

2012

Turning, drilling, threading,
milling, adaptors

_A COMPENDIUM OF EXPERTISE IN MACHINING

General Catalogue

TURNING VISIONS INTO REALITY.

Engineering what you envision requires the right tools. Tools for turning, milling, drilling and threading. But it also takes heart and soul. From the initial inspiration to the final application.

With the speciality brands of Walter, Walter Titex, Walter Prototyp and Walter Multiply you receive more than just tools from us, because we do all we can to understand and satisfy the requirements of our customers. We concentrate on the application and what the customer would like to achieve. Using this process, we help the customer to turn his idea into a reality.

For us, perfection is the most important thing. It is the easiest way to achieve productivity and efficiency, and the only way to turn vision into reality.

Expect more. Engineer what you envision.



Turning



Contents	A 1
Indexable inserts	A 5
Toolholders for turning, grooving and threading	A 76
Technical information	A 286

Drilling



Drilling and boring tools made from solid carbide and HSS

Contents	B 1
Drilling and boring tools	B 4
Technical information	B 352

Drilling and boring tools with indexable inserts



Contents	C 1
Indexable inserts	C 5
Drilling and boring tools	C 36
Technical information	C 146

Threading



Contents	D 1
Tools for thread tapping, thread forming and thread milling	D 4
Technical information	D 396

Milling



Milling cutters made from solid carbide, PCD and HSS

Contents	E 1
Milling cutters	E 4
Technical information	E 230

Milling cutters with indexable inserts



Contents	F 1
Indexable inserts	F 5
Milling cutters	F 50
Technical information	F 246

Adaptors and clamping units

Contents	G 1
Walter Capto™ clamping units and adaptors	G 10
Walter NC tools	G 42
Adaptors for ScrewFit, ConeFit™, HSK, SK	G 67
Technical information	G 110

General

Contents	H 1
General technical information	H 2
Alphanumeric search index	H 50



Turning

	Information	A 2
INDEXABLE INSERTS FOR TURNING, GROOVING AND THREADING	Product range overview	A 5
	Designation key for ISO indexable inserts	A 6
	Walter Select – Turning	A 10
	Walter indexable inserts for turning	A 17
	Designation key for cutting inserts	A 52
	Walter Select – Grooving	A 54
	Walter cutting inserts for grooving	A 58
	Walter indexable inserts for threading	A 67
WALTER TURNING TOOLS	System overview – External machining	A 76
	Walter Select – External machining	A 77
	Programme overview – External machining	A 78
	Designation key – External machining	A 82
	Turning toolholder for external machining	A 84
	System overview – Internal machining	A 158
	Walter Select – Internal machining	A 159
	Product overview – Internal machining	A 160
	Designation key – Internal machining	A 162
	Turning toolholder for internal machining	A 164
WALTER CUT GROOVING TOOLS	Walter Cut system overview	A 201
	Walter Cut product range overview	A 202
	Designation key	A 204
	Tools for grooving, parting off and recessing	A 207
WALTER NTS THREADING TOOLS	Product range overview of Walter Thread System	A 277
	Designation key	A 278
	Tools for threading	A 280
TECHNICAL INFORMATION	Cutting data – Turning	A 286
	Cutting material usage tables – Turning	A 292
	Geometry overview of turning inserts	A 293
	Application information – Turning	A 297
	Cutting data – grooving, groove turning and parting off	A 304
	Cutting material usage tables – Grooving	A 309
	Geometry overview of cutting inserts	A 310
	Application information – Grooving	A 313
	Cutting data – Threading	A 320
	Cutting material usage tables – Threading	A 322
	Application information – Threading	A 323

Turning tools

Walter provides a full range of tools for turning, grooving and threading. All tools are available with standard ISO square shanks and boring bars, and with Walter Capto™ interface C3–C8 in acc. with ISO 26623 for maximum flexibility, stability and repeatability on any lathe.

1 Walter Turn lever type clamping

- Unobstructed chip evacuation by means of lever type clamping for negative ISO indexable inserts
- Easy handling during insert replacement by operating just one screw in the normal and overhead position

2 Walter Cut monoblock tools G1011

- Maximum stability by means of unique GX insert seat design for single and double-edged inserts
- Access to clamping screw from above and below for easy tool handling

3 Walter Cut modular system

- Maximum flexibility with more than 900 possible combinations
- Reduction in inventory costs and faster set-up times

4 Walter Turn rigid clamping system

- Extremely stable indexable insert clamping for negative ISO indexable inserts
- Number one choice for interrupted cuts or machining of cast iron materials, since functionality is maintained in “dirty environments”



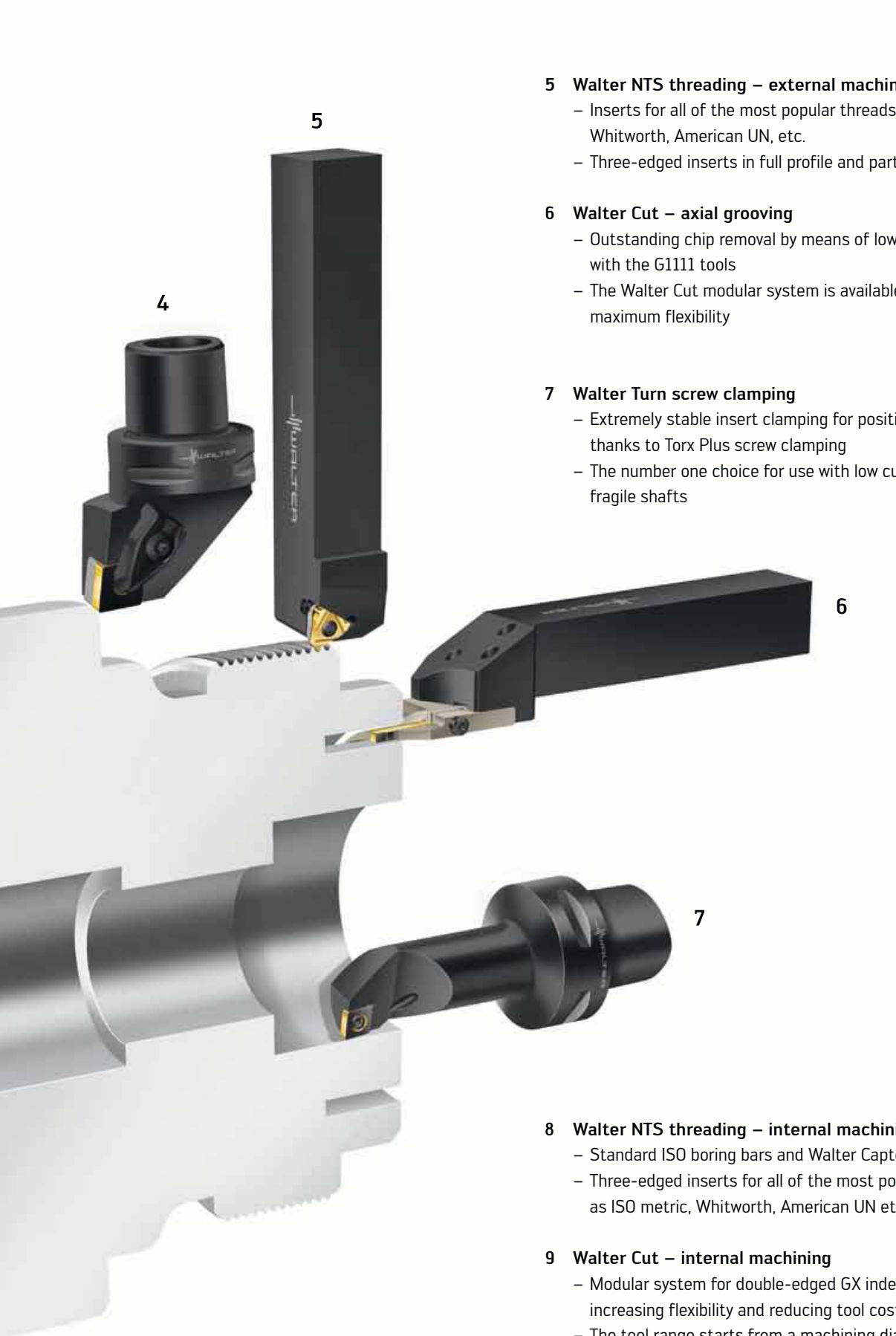

5 Walter NTS threading – external machining

- Inserts for all of the most popular threads such as ISO metric, Whitworth, American UN, etc.
- Three-edged inserts in full profile and partial profile versions

6 Walter Cut – axial grooving

- Outstanding chip removal by means of low tool head height with the G1111 tools
- The Walter Cut modular system is available as an alternative for maximum flexibility

7 Walter Turn screw clamping

- Extremely stable insert clamping for positive ISO indexable inserts thanks to Torx Plus screw clamping
- The number one choice for use with low cutting pressures or thin, fragile shafts

8 Walter NTS threading – internal machining

- Standard ISO boring bars and Walter Capto™ boring bars
- Three-edged inserts for all of the most popular threads such as ISO metric, Whitworth, American UN etc.

9 Walter Cut – internal machining

- Modular system for double-edged GX indexable inserts for increasing flexibility and reducing tool costs
- The tool range starts from a machining diameter of 16 mm



Product range overview of indexable inserts for turning, grooving and threading



Application	Insert shape	Description	Page
ISO turning	 C Wiper	Negative basic shape Positive basic shape	A 17 A 38
	 D Wiper	Negative basic shape Positive basic shape	A 22 A 40
	 R	Positive basic shape	A 43
	 S	Negative basic shape Positive basic shape	A 26 A 45
	 T	Negative basic shape Positive basic shape	A 31 A 46
	 V	Negative basic shape Positive basic shape	A 34 A 48
	 W Wiper	Negative basic shape Positive basic shape	A 35 A 50
Application	Insert shape	Description	Page
Grooving	 GX	Walter Cut GX grooving inserts, 2-edged	A 58
	 FX	Walter Cut FX grooving inserts	A 65
	 LX	Walter Cut LX grooving inserts	A 62
Application	Insert shape	Description	Page
Threading	 NTS	Walter NTS thread cutting inserts, full profile Walter NTS thread cutting inserts, partial profile	A 67 A 75

ISO 1832 designation key for indexable inserts for turning

Example 1

C	N	M	G	12	04	08	—	NM4
1	2	3	4	5	6	7		12

1	
Insert shape	
A	M
B	O
C	P
D	R
E	S
H	T
K	V
L	W

2	
Clearance angle	
A	F
B	G
C	N
D	P
E	

3			
Tolerances			
Permissible deviation in mm for			
	d	m	s
	A	± 0,025	± 0,005
	C	± 0,025	± 0,013
	E	± 0,025	± 0,025
	F	± 0,013	± 0,005
	G	± 0,025	± 0,025
	H	± 0,013	± 0,013
	J ¹	± 0,05–0,15 ²	± 0,005
	K ¹	± 0,05–0,15 ²	± 0,013
	L ¹	± 0,05–0,15 ²	± 0,025
	M	± 0,05–0,15 ²	± 0,08–0,20 ²
	N	± 0,05–0,15 ²	± 0,08–0,20 ²
	U	± 0,08–0,25 ²	± 0,13–0,38 ²

¹ Inserts with ground secondary cutting edges
² depending on insert size (see ISO standard 1832)

7	
Corner radius r [mm]	
	01 r = 0,1
	02 r = 0,2
	04 r = 0,4
	08 r = 0,8
	12 r = 1,2
	16 r = 1,6
	24 r = 2,4
00	for diameter imperial sizes converted to mm
M0	for diameter in metric sizes

8	
Edge formation	
E	
F	
T	
S	

9	
Cutting direction	
R	
L	
N	

10	
Chamfer width	
010	= 0.10 mm
020	= 0.20 mm
025	= 0.25 mm
070	= 0.70 mm
150	= 1.50 mm
200	= 2.00 mm

11	
Chamfer angle	
15	= 15°
20	= 20°

Example 2

T	N	M	A	16	04	08	T	020	20
1	2	3	4	5	6	7	8	10	11

4			5		6																																		
Machining and fastening features			Cutting edge length l [mm]		Insert thickness s [mm]																																		
A		J		U		<table style="width: 100%; border-collapse: collapse;"> <tr><td></td><td style="text-align: right;">01</td><td>s = 1,59</td></tr> <tr><td></td><td style="text-align: right;">T1</td><td>s = 1,98</td></tr> <tr><td></td><td style="text-align: right;">02</td><td>s = 2,38</td></tr> <tr><td></td><td style="text-align: right;">T2</td><td>s = 2,78</td></tr> <tr><td></td><td style="text-align: right;">03</td><td>s = 3,18</td></tr> <tr><td></td><td style="text-align: right;">T3</td><td>s = 3,97</td></tr> <tr><td></td><td style="text-align: right;">04</td><td>s = 4,76</td></tr> <tr><td></td><td style="text-align: right;">05</td><td>s = 5,56</td></tr> <tr><td></td><td style="text-align: right;">06</td><td>s = 6,35</td></tr> <tr><td></td><td style="text-align: right;">07</td><td>s = 7,94</td></tr> <tr><td></td><td style="text-align: right;">09</td><td>s = 9,52</td></tr> </table>		01	s = 1,59		T1	s = 1,98		02	s = 2,38		T2	s = 2,78		03	s = 3,18		T3	s = 3,97		04	s = 4,76		05	s = 5,56		06	s = 6,35		07	s = 7,94		09	s = 9,52
	01	s = 1,59																																					
	T1	s = 1,98																																					
	02	s = 2,38																																					
	T2	s = 2,78																																					
	03	s = 3,18																																					
	T3	s = 3,97																																					
	04	s = 4,76																																					
	05	s = 5,56																																					
	06	s = 6,35																																					
	07	s = 7,94																																					
	09	s = 9,52																																					
B		M		W																																			
C		N		X	Drawing or precise description of indexable insert required.																																		
F		Q		Y																																			
G		R		Z																																			
H		T		AA																																			
				AB																																			
				AC																																			
				AD																																			
				AE																																			
				AF																																			
				AG																																			

12		
Manufacturer information / Walter Geometry Index		
<p style="text-align: center;">1. Basic shape</p> <p>N </p> <p>P </p>	<p style="text-align: center;">2. Chip area</p> <p>F Finishing S Semifinishing M Medium machining R Roughing</p>	<p style="text-align: center;">3. Cutting edge type</p> <p>1 fine</p> <p>4 medium</p> <p>9 robust</p> <p>S ISO S materials high temperature alloys</p> <p>T ISO S titanium materials</p>

Designation key for cutting materials made from carbide – turning

Example

W	P	P	20	S
Walter	1	2	3	4

1	
1. Primary application or coating type	
P	Steel
M	Stainless steel
K	Cast iron
N	NF metals
S	Difficult-to-machine materials
H	Hard materials
A	CVD aluminium coating
X	PVD coating

2	
2. Primary application	
P	Steel
M	Stainless steel
K	Cast iron
N	NF metals
S	Difficult-to-machine materials
H	Hard materials

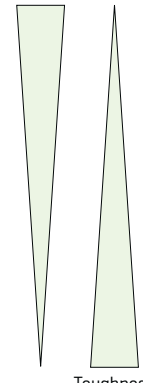
3	
ISO application range	
Wear resistance 01 05 10 20 21 23 30 32 33 43	Toughness 
Cutting materials for: 0 ISO turning 1 ISO turning 5 ISO turning 2 Threading 3 Grooving	

4	
Generation	
S	Tiger-tec® Silver



Walter Select for turning inserts

Step by step to the right indexable insert

STEP 1

Determine the **material** to be machined from page H 8 onwards.

Note the machining group that corresponds to your material e.g.: P10.

Code letters	Machining group	Groups of the materials to be machined	
P	P1–P15	Steel	All types of steel and cast steel, with the exception of steel with an austenitic structure
M	M1–M3	Stainless steel	Stainless austenitic steel and austenitic-ferritic steel and cast steel
K	K1–K7	Cast iron	Grey cast iron, cast iron with spheroidal graphite, malleable cast iron, cast iron with vermicular graphite
N	N1–N10	NF metals	Aluminium and other non-ferrous metals, non-ferrous materials
S	S1–S10	High temperature alloys and titanium alloys	Heat resisting special alloys based on iron, nickel and cobalt, titanium and titanium alloys
H	H1–H4	Hard materials	Hardened steel, hardened cast iron materials, chilled cast iron
O	O1–O6	Other	Plastics, fibre glass and carbon fibre reinforced plastics, graphite

STEP 2

Determine the **basic shape** of the indexable insert:

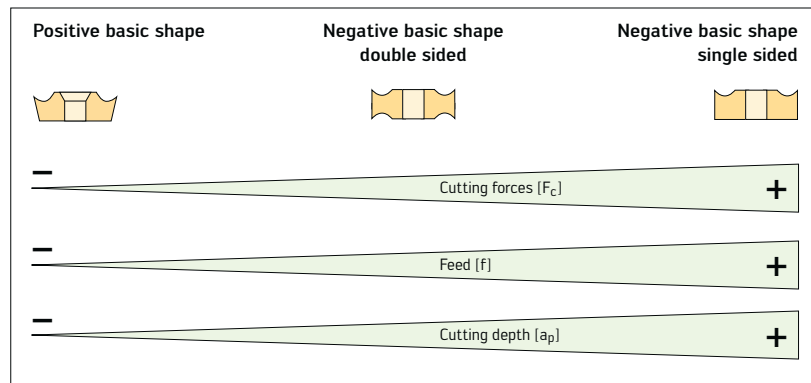

STEP 3

Select the **machining conditions**:

Type of workpiece	Machine stability, clamping system and workpiece		
	very good	good	moderate
Smooth cut Premachined surface			
Casting or forged skin Variable cutting depths			
Interrupted cuts			

STEP 4

Determine the **insert geometry** via the cutting depth (a_p) and the feed (f).

Geometries for

- P** Steel see page A 12
- M** Stainless steel see page A 13
- K** Cast iron see page A 14
- N** NF metals see page A 16
- S** High temperature alloys see page A 15
- H** Hard materials see page A 16

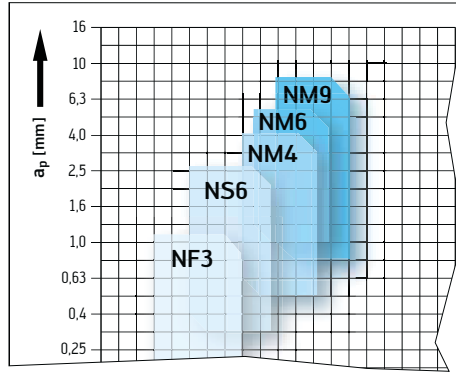

STEP 5

Overview of catalogue page on which you will find the selected **geometry** in the relevant **basic shape**.

Geometry	C	D	R	S	T	V	W
	Page	Page	Page	Page	Page	Page	Page
NF*	A 17	A 22					A 35
NF3	A 17	A 22		A 26	A 31	A 34	A 35
NS6	A 17	A 23		A 26	A 31		A 35
NM*	A 17	A 23					A 35
NM4	A 18	A 24		A 26	A 31	A 34	A 35
NM6	A 18			A 27	A 32		A 36
NM9	A 19	A 24		A 27	A 32		A 37

On the specified catalogue page you will find the cutting material recommendation, the feed value (f) and the cutting depth (a_p).

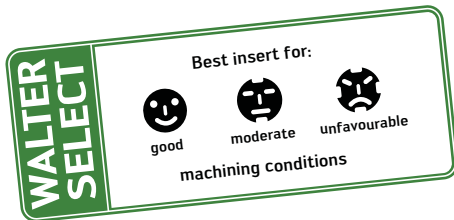

Negative basic shape CNGG / CNMG / CNMM / CNMA

Tiger-tec®

Indexable inserts

Designation	d mm	l mm	s mm	r mm	f mm	ap mm	WPP01	WPP05	WPP10	WPP20	WPP30	WSM10	WSM20	WSM30	WAK10	WAK20	WAK30	WSN10	WSN20	WSN30	WSM30	WSM30	WS10	WCB30	WCB90	H	BH
CNMG120404-NF	12.7	12.9	4.76	0.4	0.10 - 0.40	0.4 - 2.0	●	●	●	●	●	●	●	●	●	●	●	●	●	●	●	●	●	●	●	●	●
CNMG120408-NF	12.7	12.9	4.76	0.8	0.15 - 0.55	0.5 - 3.0	●	●	●	●	●	●	●	●	●	●	●	●	●	●	●	●	●	●	●	●	●
CNMG120404-NF3	12.7	12.9	4.76	0.4	0.04 - 0.20	0.1 - 0.5	●	●	●	●	●	●	●	●	●	●	●	●	●	●	●	●	●	●	●	●	●

STEP 6

Choose the **cutting data** in the technical information see page A 286 onwards for your selected indexable insert.

Cutting data for turning inserts – negative basic shape

Carbide grades

Material group	Structure of main material groups and identification letters	Annealing	Brinell hardness HB	Tensile strength R _m	Machining group 1	Cutting material grades																						
						Starting values for cutting speed v _c [m/min]																						
						WPP01			WPP05																			
						f [mm/rev]	f [mm/rev]	f [mm/rev]	f [mm/rev]	f [mm/rev]	f [mm/rev]																	
P	Unalloyed steel	C ≤ 0.25 %	annealed	125	428	P1	●	●	●	●	●	●	●	●	●	●	●	●	●	●	●	●	●	●	●	●	●	
		C > 0.25 - ≤ 0.55 %	annealed	190	639	P2	●	●	●	●	●	●	●	●	●	●	●	●	●	●	●	●	●	●	●	●	●	●
		C > 0.55 - ≤ 0.85 %	annealed	190	639	P4	●	●	●	●	●	●	●	●	●	●	●	●	●	●	●	●	●	●	●	●	●	●
		C > 0.85 %	tempered	300	1013	P5	●	●	●	●	●	●	●	●	●	●	●	●	●	●	●	●	●	●	●	●	●	●
		Free cutting steel (short-chipping)	annealed	220	745	P6	●	●	●	●	●	●	●	●	●	●	●	●	●	●	●	●	●	●	●	●	●	●
P	Low-alloyed steel	annealed	175	591	P7	●	●	●	●	●	●	●	●	●	●	●	●	●	●	●	●	●	●	●	●	●	●	
		tempered	300	1013	P8	●	●	●	●	●	●	●	●	●	●	●	●	●	●	●	●	●	●	●	●	●	●	
		tempered	380	1262	P9	●	●	●	●	●	●	●	●	●	●	●	●	●	●	●	●	●	●	●	●	●	●	●
		tempered	430	1477	P10	●	●	●	●	●	●	●	●	●	●	●	●	●	●	●	●	●	●	●	●	●	●	●
P	High-alloyed steel and high-alloyed tool steel	annealed	200	675	P11	●	●	●	●	●	●	●	●	●	●	●	●	●	●	●	●	●	●	●	●	●	●	
		hardened and tempered	300	1013	P12	●	●	●	●	●	●	●	●	●	●	●	●	●	●	●	●	●	●	●	●	●	●	●
P	Stainless steel	annealed	400	1361	P13	●	●	●	●	●	●	●	●	●	●	●	●	●	●	●	●	●	●	●	●	●	●	
		hardened and tempered	400	1361	P13	●	●	●	●	●	●	●	●	●	●	●	●	●	●	●	●	●	●	●	●	●	●	●

Walter Select – steel machining ISO P

STEP 4

Determine the **indexable insert geometry** via the cutting depth (a_p) and the feed (f).

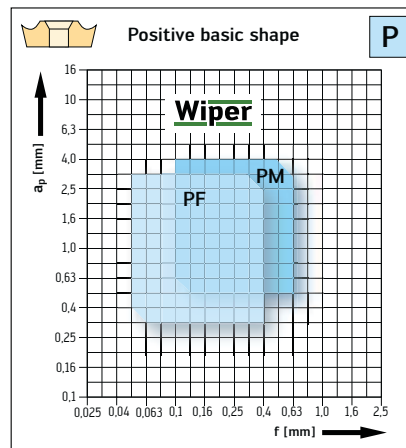
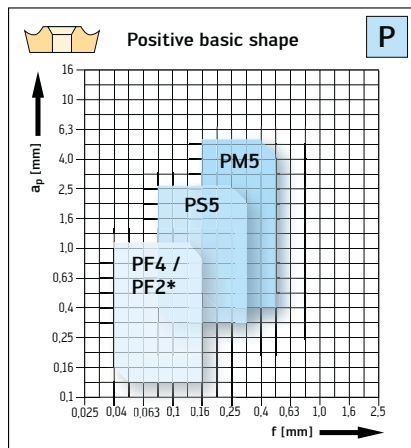
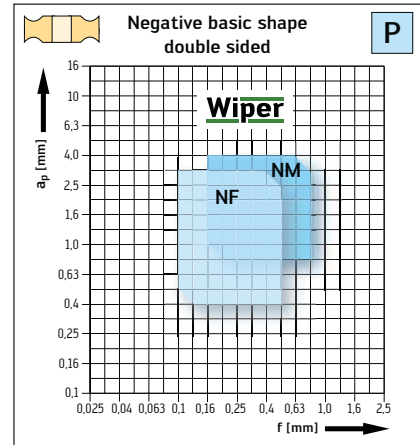
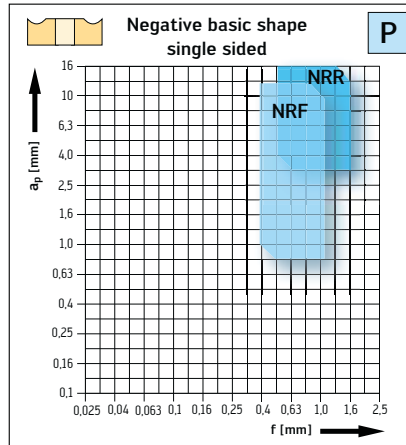
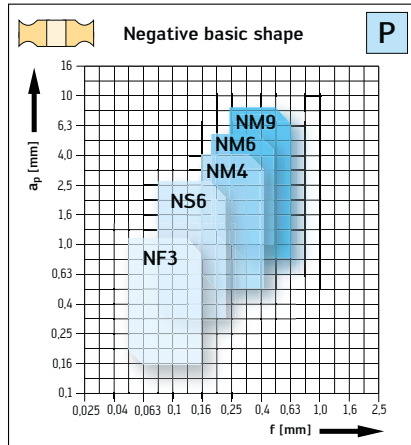

Wiper

More technical information see page A 298 onwards.

* Fully ground circumference

STEP 5

Overview of catalogue page on which you will find the selected **geometry** in the relevant **basic shape**.

Geometry	Basic shape						
	C	D	R	S	T	V	W
	Page	Page	Page	Page	Page	Page	Page
NF*	A 17	A 22					A 35
NF3	A 17	A 22		A 26	A 31	A 34	A 35
NS6	A 17	A 23		A 26	A 31		A 35
NM*	A 17	A 23					A 35
NM4	A 18	A 24		A 26	A 31	A 34	A 36
NM6	A 18			A 27	A 32		A 36
NM9	A 19	A 24		A 27	A 32		A 37
NRF	A 20	A 25		A 28	A 32		A 37
NRR	A 20			A 29	A 33		
PF*	A 38	A 41					A 50
PF4	A 38	A 41	A 43	A 45	A 46	A 48	A 50
PF5	A 38		A 43			A 48	
PS5	A 39	A 41		A 45	A 46	A 48	A 50
PM*	A 39	A 41					A 51
M0T			A 43				
PM5	A 40	A 42	A 43	A 45	A 47	A 49	A 51
PR5			A 44				

* **Wiper**

Walter Select – stainless steel ISO M

STEP 4

Determine the **indexable insert geometry** via the cutting depth (a_p) and the feed (f).

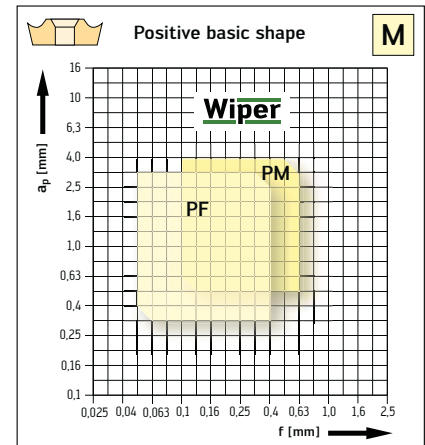
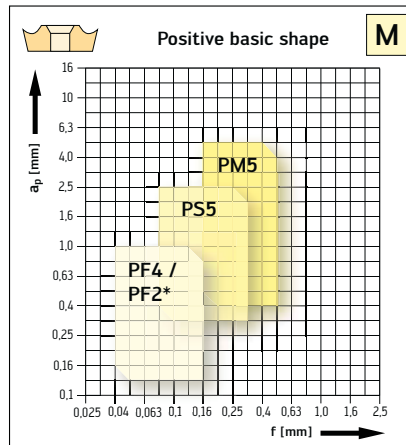
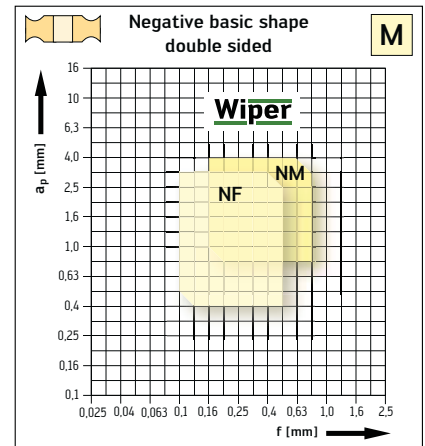
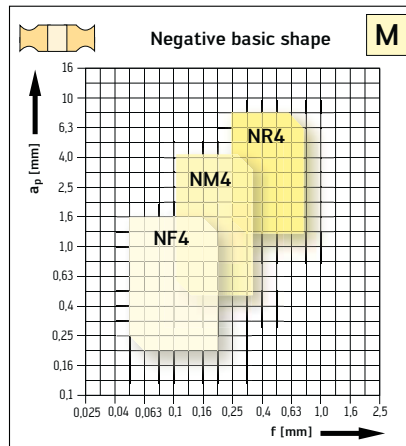

* Fully ground circumference

Wiper

More technical information see page A 298 onwards.

STEP 5

Overview of catalogue page on which you will find the selected **geometry** in the relevant **basic shape**.

Geometry	Basic shape						
	C	D	R	S	T	V	W
	Page	Page	Page	Page	Page	Page	Page
NF*	A 17	A 22					A 35
NF4	A 17	A 22		A 26	A 31		A 35
NM*	A 17						A 35
NM4	A 18	A 24		A 26	A 31	A 34	A 36
NR4	A 19	A 25		A 28	A 32		A 37
PF*	A 38	A 41					A 50
PF2	A 38	A 41		A 45	A 46	A 48	A 50
PF4	A 38	A 41	A 43	A 45	A 46	A 48	A 50
PS5	A 39	A 41		A 45	A 46	A 48	
PM*		A 41					
PM5	A 40	A 42	A 43	A 45	A 47	A 49	A 51

* **Wiper**

Walter Select – Cast Iron Machining ISO K

STEP 4

Determine the **indexable insert geometry** via the cutting depth (a_p) and the feed (f).

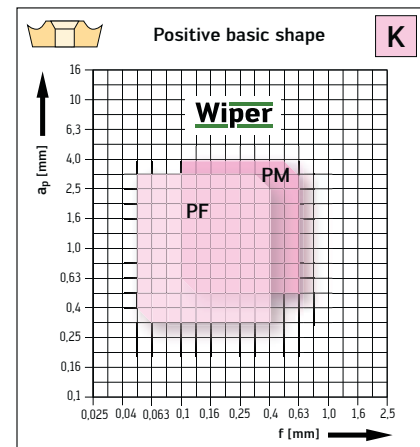
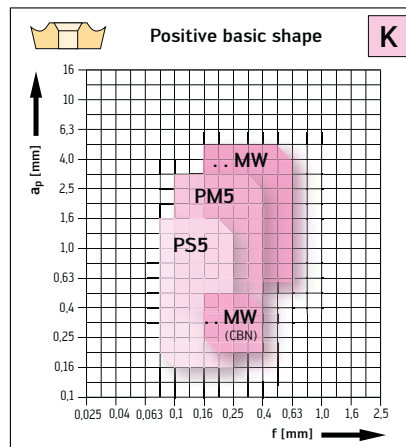
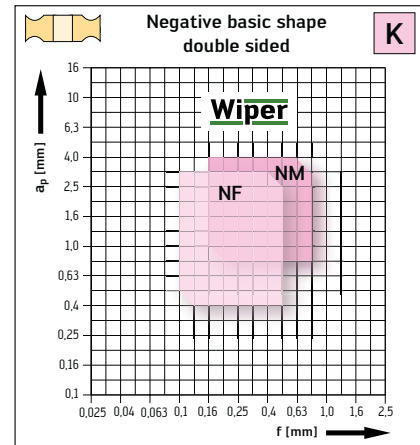
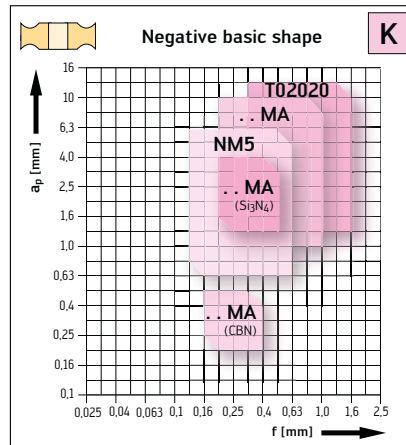

Wiper

More technical information see page A 298 onwards.

STEP 5

Overview of catalogue page on which you will find the selected **geometry** in the relevant **basic shape**.

Geometry	Basic shape						
	C	D	R	S	T	V	W
	Page	Page	Page	Page	Page	Page	Page
NF*	A 17	A 22					A 35
NM*	A 17	A 23					A 35
NM5	A 18	A 24		A 26	A 32	A 34	A 36
.. MA	A 21	A 25		A 29	A 33	A 34	A 37
T02020	A 21			A 29	A 33		A 37
PF*	A 38	A 41					A 50
PS5	A 39	A 41		A 45	A 46	A 48	A 50
PM*	A 39	A 41					A 51
PM5	A 40	A 42	A 43	A 45	A 47	A 49	A 51
.. MW	A 40	A 42		A 45	A 47	A 49	

Use NF* / PF*WPP01 grades

* **Wiper**

Walter Select – High-Temperature and Titanium Alloys ISO S

STEP 4

Determine the **indexable insert geometry** via the cutting depth (a_p) and the feed (f).

Ni, Co, Fe-based alloys

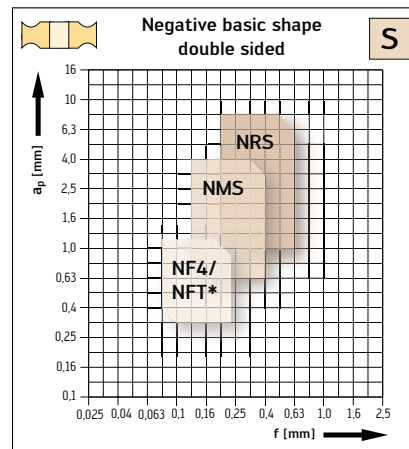

Titanium-based alloys

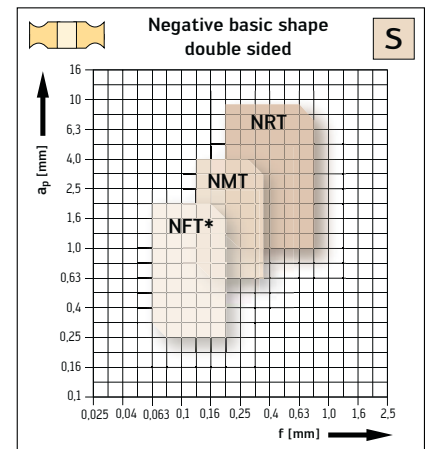

Ni, Co, Fe and titanium-based alloys

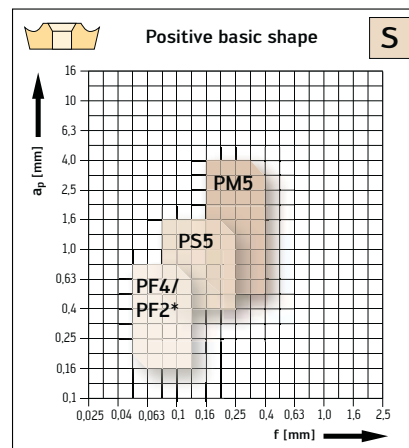

* Fully ground circumference

STEP 5

Overview of catalogue page on which you will find the selected **geometry** in the relevant **basic shape**.

Geometry	Basic shape						
	C	D	R	S	T	V	W
	 Page	 Page	 Page	 Page	 Page	 Page	 Page
NFT	A 17	A 22				A 34	
NF4	A 17	A 22		A 26	A 31		A 35
NMS	A 17	A 23			A 31	A 34	A 35
NMT	A 17	A 23			A 31		A 35
NRS	A 19	A 25		A 27			
NRT	A 19			A 27			
PF2	A 38	A 41		A 45	A 46	A 48	
PF4	A 38	A 41	A 43	A 45	A 46	A 48	A 50
PS5	A 39	A 41		A 45	A 46	A 48	
PM5	A 40	A 42	A 43	A 45	A 47	A 49	A 51

Walter Select – Non-Ferrous Metals ISO N

STEP 4

Determine the **indexable insert geometry** via the cutting depth (a_p) and the feed (f).

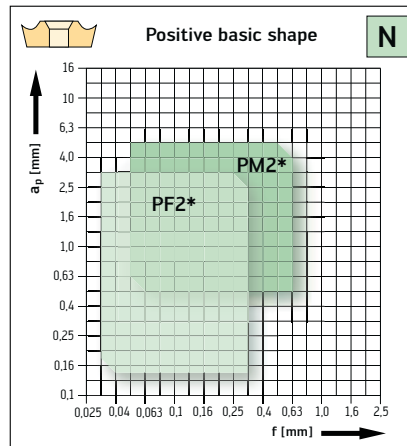

* Fully ground circumference

STEP 5

Overview of catalogue page on which you will find the selected **geometry** in the relevant **basic shape**.

Geometry	Basic shape						
	C	D	R	S	T	V	W
PF2	Page A 38	Page A 41	Page A 43	Page A 45	Page A 46	Page A 48	Page A 50
PM2	Page A 39	Page A 42	Page A 43	Page A 45	Page A 47	Page A 49	Page A 51

Walter Select – Hard Machining ISO H

STEP 4

Determine the **indexable insert geometry** via the cutting depth (a_p) and the feed (f).

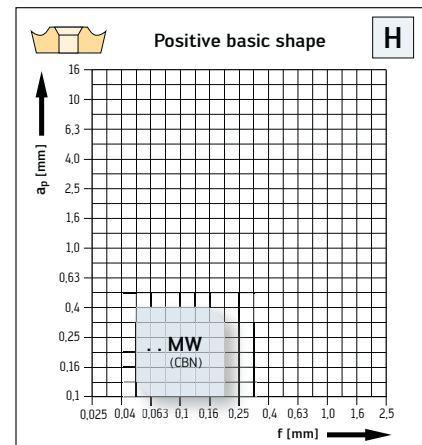
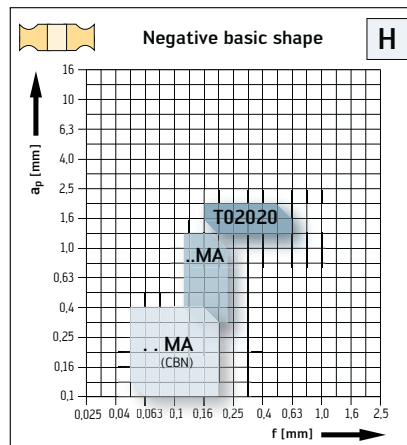

STEP 5

Overview of catalogue page on which you will find the selected **geometry** in the relevant **basic shape**.

Geometry	Basic shape						
	C	D	R	S	T	V	W
.. MA	Page A 21	Page A 25		Page A 29	Page A 33		
T02020*	Page A 21			Page A 29	Page A 33		Page A 37
.. MW	Page A 40	Page A 42			Page A 47	Page A 49	

* Use WAK10 grade

Negative basic shape CNGG / CNMG / CNMM / CNMA

Tiger-tec®

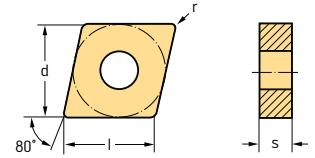

Indexable inserts

Designation	d mm	l mm	s mm	r mm	f mm	ap mm	P					M			K			S			H			
							HC					HC			HC		CN	HC			HW	BL	BH	
							WPP01	WPP05	WPP10	WPP20	WPP30	WSM10	WSM20	WSM30	WAK10	WAK20	WAK30	WSN10	WSM10	WSM20	WSM30	WS10	WCB30	WCB50
CNMG120404-NF	12,7	12,9	4,76	0,4	0,10 - 0,40	0,4 - 2,0	☺	☺	☺															
	CNMG120408-NF	12,7	12,9	4,76	0,8	0,15 - 0,55	0,5 - 3,0	☺	☺	☺														
CNMG120404-NF3	12,7	12,9	4,76	0,4	0,04 - 0,20	0,1 - 1,5	☺	☺	☺															
	CNMG120408-NF3	12,7	12,9	4,76	0,8	0,08 - 0,25	0,2 - 2,0	☺	☺	☺														
	CNMG120412-NF3	12,7	12,9	4,76	1,2	0,10 - 0,25	0,5 - 2,5	☺	☺	☺														
CNGG120404-NFT	12,7	12,9	4,76	0,4	0,06 - 0,15	0,3 - 1,5															☺			
	CNGG120408-NFT	12,7	12,9	4,76	0,8	0,08 - 0,18	0,4 - 2,0															☺		
CNMG120404-NFT	12,7	12,9	4,76	0,4	0,08 - 0,17	0,4 - 1,0																☺		
	CNMG120408-NFT	12,7	12,9	4,76	0,8	0,10 - 0,20	0,5 - 2,0																☺	
CNMG120404-NF4	12,7	12,9	4,76	0,4	0,05 - 0,12	0,2 - 1,0																☺		
	CNMG120408-NF4	12,7	12,9	4,76	0,8	0,07 - 0,16	0,4 - 1,5																☺	
	CNMG120412-NF4	12,7	12,9	4,76	1,2	0,10 - 0,20	0,5 - 1,6																☺	
CNMG120404-NS6	12,7	12,9	4,76	0,4	0,08 - 0,20	0,3 - 2,0	☺	☺	☺															
	CNMG120408-NS6	12,7	12,9	4,76	0,8	0,12 - 0,32	0,6 - 2,5	☺	☺	☺														
	CNMG120412-NS6	12,7	12,9	4,76	1,2	0,16 - 0,40	1,2 - 3,2	☺	☺	☺														
CNMG120408-NM	12,7	12,9	4,76	0,8	0,20 - 0,55	0,8 - 3,0	☺	☺	☺															
	CNMG120412-NM	12,7	12,9	4,76	1,2	0,25 - 0,70	1,5 - 4,0	☺	☺	☺														
CNMG120408-NMT	12,7	12,9	4,76	0,8	0,12 - 0,30	0,8 - 4,0			☺	☺	☺												☺	
	CNMG120412-NMT	12,7	12,9	4,76	1,2	0,15 - 0,32	1,0 - 4,0			☺	☺	☺												☺
CNMG120404-NMS	12,7	12,9	4,76	0,4	0,10 - 0,24	0,6 - 2,5																	☺	
	CNMG120408-NMS	12,7	12,9	4,76	0,8	0,13 - 0,24	0,8 - 3,5																	☺
	CNMG120412-NMS	12,7	12,9	4,76	1,2	0,16 - 0,36	1,0 - 3,5																	☺

For achievable surface finish qualities and technical information, see page A 298.

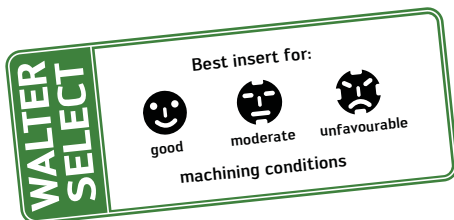

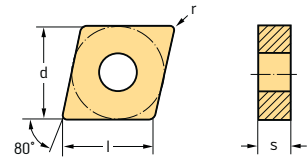

HC = Coated carbide
 CN = Silicon nitride Si₃N₄
 HW = Uncoated carbide
 BL = CBN with low CBN content
 BH = CBN with high CBN content

Negative basic shape CNGG / CNMG / CNMM / CNMA

Tiger-tec®

Indexable inserts

Designation	d mm	l mm	s mm	r mm	f mm	ap mm	P			M			K			S			H					
							HC			HC			HC			CN			HC			HW	BL	BH
							WPP01	WPP05	WPP10	WPP20	WPP30	WSM10	WSM20	WSM30	WAK10	WAK20	WAK30	WSN10	WSM10	WSM20	WSM30	WS10	WCB30	WCB50
 CNMG120404-NM4	12,7	12,9	4,76	0,4	0,16 - 0,25	0,5 - 4,0	☺	☺	☺	☺	☺	☺	☺	☺	☺	☺								
CNMG120408-NM4	12,7	12,9	4,76	0,8	0,18 - 0,40	0,6 - 5,0	☺	☺	☺	☺	☺	☺	☺	☺	☺	☺								
CNMG120412-NM4	12,7	12,9	4,76	1,2	0,20 - 0,40	1,0 - 5,0	☺	☺	☺	☺	☺	☺	☺	☺	☺	☺								
CNMG120416-NM4	12,7	12,9	4,76	1,6	0,25 - 0,40	1,2 - 5,0		☺	☺	☺		☺	☺	☺	☺	☺								
CNMG160608-NM4	15,875	16,1	6,35	0,8	0,15 - 0,40	0,8 - 4,0	☺	☺	☺	☺	☺	☺	☺	☺	☺	☺								
CNMG160612-NM4	15,875	16,1	6,35	1,2	0,30 - 0,50	1,0 - 7,0	☺	☺	☺	☺	☺	☺	☺	☺	☺	☺								
CNMG160616-NM4	15,875	16,1	6,35	1,6	0,35 - 0,55	1,2 - 7,0		☺	☺	☺		☺	☺	☺	☺	☺								
 CNMG120404-NM5	12,7	12,9	4,76	0,4	0,16 - 0,25	0,6 - 5,0							☺	☺	☺									
CNMG120408-NM5	12,7	12,9	4,76	0,8	0,25 - 0,50	0,8 - 5,0							☺	☺	☺									
CNMG120412-NM5	12,7	12,9	4,76	1,2	0,30 - 0,50	1,2 - 5,0							☺	☺	☺									
CNMG120416-NM5	12,7	12,9	4,76	1,6	0,35 - 0,50	1,5 - 5,0							☺	☺	☺									
CNMG160608-NM5	15,875	16,1	6,35	0,8	0,25 - 0,50	0,8 - 7,0							☺	☺	☺									
CNMG160612-NM5	15,875	16,1	6,35	1,2	0,30 - 0,60	1,2 - 7,0							☺	☺	☺									
CNMG160616-NM5	15,875	16,1	6,35	1,6	0,35 - 0,60	1,5 - 7,0							☺	☺	☺									
CNMG190612-NM5	19,05	19,3	6,35	1,2	0,30 - 0,65	1,2 - 8,0							☺	☺	☺									
CNMG190616-NM5	19,05	19,3	6,35	1,6	0,35 - 0,80	1,5 - 8,0							☺	☺	☺									
CNMG190624-NM5	19,05	19,3	6,35	2,4	0,40 - 0,90	2,5 - 8,0							☺	☺	☺									
 CNMG120408-NM6	12,7	12,9	4,76	0,8	0,25 - 0,50	0,8 - 5,0		☺	☺	☺				☺										
CNMG120412-NM6	12,7	12,9	4,76	1,2	0,30 - 0,50	1,2 - 5,0		☺	☺	☺				☺										
CNMG120416-NM6	12,7	12,9	4,76	1,6	0,35 - 0,50	1,5 - 5,0		☺	☺	☺				☺										
CNMG160608-NM6	15,875	16,1	6,35	0,8	0,30 - 0,50	0,8 - 6,0		☺	☺	☺														
CNMG160612-NM6	15,875	16,1	6,35	1,2	0,35 - 0,60	1,2 - 6,0		☺	☺	☺				☺										
CNMG160616-NM6	15,875	16,1	6,35	1,6	0,40 - 0,60	1,5 - 6,0		☺	☺	☺				☺										
CNMG190612-NM6	19,05	19,3	6,35	1,2	0,35 - 0,60	1,2 - 7,0		☺	☺	☺				☺										
CNMG190616-NM6	19,05	19,3	6,35	1,6	0,40 - 0,60	1,5 - 7,0		☺	☺	☺				☺										
CNMG190624-NM6	19,05	19,3	6,35	2,4	0,40 - 0,60	2,5 - 7,0		☺	☺	☺				☺										
CNMG250924-NM6	25,4	25,8	9,525	2,4	0,45 - 1,00	3,0 - 9,0				☺				☺										

For achievable surface finish qualities and technical information, see page A 298.

HC = Coated carbide
 CN = Silicon nitride Si₃N₄
 HW = Uncoated carbide
 BL = CBN with low CBN content
 BH = CBN with high CBN content

Negative basic shape CNGG / CNMG / CNMM / CNMA

Tiger-tec®

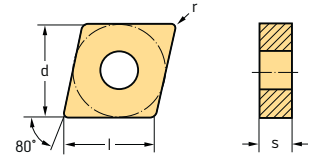

Indexable inserts

Designation	d mm	l mm	s mm	r mm	f mm	ap mm	P					M			K				S			H			
							HC					HC			HC		CN		HC			HW	BL	BH	
							WPP01	WPP05	WPP10	WPP20	WPP30	WSM10	WSM20	WSM30	WAK10	WAK20	WAK30	WSN10	WSM10	WSM20	WSM30	WS10	WCB30	WCB50	
CNMG120408-NM9	12,7	12,9	4,76	0,8	0,20 - 0,40	1,0 - 6,0	☺	☺	☺	☺															
CNMG120412-NM9	12,7	12,9	4,76	1,2	0,25 - 0,55	1,0 - 6,0	☺	☺	☺	☺															
CNMG120416-NM9	12,7	12,9	4,76	1,6	0,35 - 0,65	1,0 - 6,0	☺	☺	☺	☺															
CNMG160608-NM9	15,875	16,1	6,35	0,8	0,20 - 0,45	2,0 - 8,0			☺	☺	☺														
CNMG160612-NM9	15,875	16,1	6,35	1,2	0,25 - 0,60	2,0 - 8,0	☺	☺	☺	☺															
CNMG160616-NM9	15,875	16,1	6,35	1,6	0,35 - 0,70	2,0 - 8,0	☺	☺	☺	☺															
CNMG190608-NM9	19,05	19,3	6,35	0,8	0,20 - 0,50	2,0 - 10,0			☺	☺	☺														
CNMG190612-NM9	19,05	19,3	6,35	1,2	0,30 - 0,65	2,0 - 10,0	☺	☺	☺	☺															
CNMG190616-NM9	19,05	19,3	6,35	1,6	0,35 - 0,80	2,0 - 10,0	☺	☺	☺	☺															
CNMG120408-NRT	12,7	12,9	4,76	0,8	0,18 - 0,35	1,0 - 6,0																			
CNMG120412-NRT	12,7	12,9	4,76	1,2	0,20 - 0,40	1,2 - 6,0																			
CNMG160612-NRT	15,875	16,1	6,35	1,2	0,28 - 0,55	1,5 - 7,5																			
CNMG190616-NRT	19,05	19,3	6,35	1,6	0,35 - 0,70	2,0 - 9,0																			
CNMG120408-NRS	12,7	12,9	4,76	0,8	0,16 - 0,35	1,0 - 4,0																			
CNMG120412-NRS	12,7	12,9	4,76	1,2	0,18 - 0,40	1,2 - 4,0																			
CNMG160612-NRS	15,875	16,1	6,35	1,2	0,21 - 0,45	1,2 - 6,5																			
CNMG160616-NRS	15,875	16,1	6,35	1,6	0,23 - 0,50	1,5 - 6,5																			
CNMG190612-NRS	19,05	19,3	6,35	1,2	0,23 - 0,50	1,2 - 8,5																			
CNMG120408-NR4	12,7	12,9	4,76	0,8	0,22 - 0,40	1,2 - 5,0																			
CNMG120412-NR4	12,7	12,9	4,76	1,2	0,25 - 0,50	1,5 - 5,0																			
CNMG120416-NR4	12,7	12,9	4,76	1,6	0,30 - 0,55	2,0 - 5,0																			
CNMG160608-NR4	15,875	16,1	6,35	0,8	0,22 - 0,45	1,2 - 7,0																			
CNMG160612-NR4	15,875	16,1	6,35	1,2	0,25 - 0,60	1,5 - 7,0																			
CNMG160616-NR4	15,875	16,1	6,35	1,6	0,30 - 0,65	2,0 - 7,0																			
CNMG190612-NR4	19,05	19,3	6,35	1,2	0,25 - 0,60	1,5 - 8,0																			
CNMG190616-NR4	19,05	19,3	6,35	1,6	0,30 - 0,80	2,0 - 8,0																			

For achievable surface finish qualities and technical information, see page A 298.

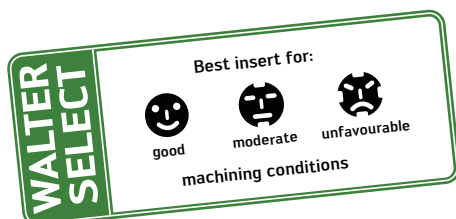

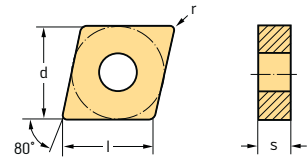

HC = Coated carbide
 CN = Silicon nitride Si₃N₄
 HW = Uncoated carbide
 BL = CBN with low CBN content
 BH = CBN with high CBN content

Negative basic shape CNGG / CNMG / CNMM / CNMA

Tiger-tec®

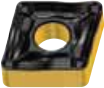
Indexable inserts

Designation	d mm	l mm	s mm	r mm	f mm	ap mm	P					M			K			S			H	
							HC					HC			HC		CN	HC		HW	BL	BH
							WPP01	WPP05	WPP10	WPP20	WPP30	WSM10	WSM20	WSM30	WAK10	WAK20	WAK30	WSN10	WSM10	WSM20	WSM30	WS10
 CNMM120408-NRF	12,7	12,9	4,76	0,8	0,30 - 0,50	0,8 - 7,0	☺	☺	☺	☺												
CNMM120412-NRF	12,7	12,9	4,76	1,2	0,35 - 0,70	1,2 - 7,0	☺	☺	☺	☺												
CNMM120416-NRF	12,7	12,9	4,76	1,6	0,40 - 0,80	1,6 - 7,0	☺	☺	☺	☺												
CNMM160612-NRF	15,875	16,1	6,35	1,2	0,35 - 0,70	1,2 - 9,0	☺	☺	☺	☺												
CNMM160616-NRF	15,875	16,1	6,35	1,6	0,40 - 0,90	1,6 - 9,0	☺	☺	☺	☺												
CNMM160624-NRF	15,875	16,1	6,35	2,4	0,45 - 1,00	2,4 - 9,0	☺	☺	☺	☺												
CNMM190612-NRF	19,05	19,3	6,35	1,2	0,35 - 0,70	1,2 - 10,0	☺	☺	☺	☺												
CNMM190616-NRF	19,05	19,3	6,35	1,6	0,40 - 0,90	1,6 - 10,0	☺	☺	☺	☺												
CNMM190624-NRF	19,05	19,3	6,35	2,4	0,45 - 1,10	2,4 - 10,0	☺	☺	☺	☺												
CNMM250924-NRF	25,4	25,8	9,52	2,4	0,45 - 1,20	2,4 - 12,0		☺	☺	☺												
 CNMM190612-NR6	19,05	19,3	6,35	1,2	0,40 - 0,70	2,0 - 10,0			☺													
CNMM190616-NR6	19,05	19,3	6,35	1,6	0,45 - 0,90	2,0 - 10,0			☺	☺												
CNMM190624-NR6	19,05	19,3	6,35	2,4	0,55 - 1,20	2,5 - 10,0			☺													
 CNMM160612-NRR	15,875	16,1	6,35	1,2	0,50 - 0,90	2,0 - 10,0			☺	☺			☺									
CNMM160616-NRR	15,875	16,1	6,35	1,6	0,50 - 1,10	2,0 - 10,0			☺	☺			☺									
CNMM190612-NRR	19,05	19,3	6,35	1,2	0,50 - 0,90	2,0 - 13,0			☺	☺			☺									
CNMM190616-NRR	19,05	19,3	6,35	1,6	0,50 - 1,10	2,0 - 13,0			☺	☺			☺									
CNMM190624-NRR	19,05	19,3	6,35	2,4	0,60 - 1,60	3,0 - 13,0			☺	☺			☺									
CNMM250924-NRR	25,4	25,8	9,52	2,4	0,60 - 1,60	3,0 - 17,0			☺	☺			☺									

For achievable surface finish qualities and technical information, see page A 298.

HC = Coated carbide
 CN = Silicon nitride Si₃N₄
 HW = Uncoated carbide
 BL = CBN with low CBN content
 BH = CBN with high CBN content

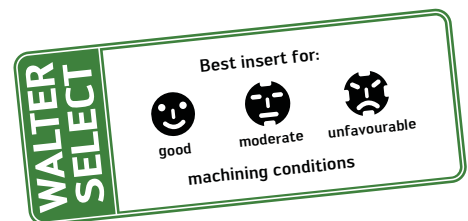

Negative basic shape CNGG / CNMG / CNMM / CNMA

Tiger-tec®

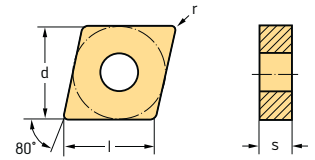

Indexable inserts

Designation	d mm	l mm	s mm	r mm	f mm	ap mm	P					M			K		S				H						
							WPP01	WPP05	WPP10	WPP20	WPP30	WSM10	WSM20	WSM30	WAK10	WAK20	WAK30	WSN10	WSM10	WSM20	WSM30	WS10	WCB30	WCB50	HC	CN	HC
CNMA120404	12,7	12,9	4,76	0,4	0,16 - 0,25	0,6 - 5,0																					
CNMA120408	12,7	12,9	4,76	0,8	0,25 - 0,50	0,8 - 5,0																					
CNMA120412	12,7	12,9	4,76	1,2	0,30 - 0,60	1,2 - 5,0																					
CNMA120416	12,7	12,9	4,76	1,6	0,35 - 0,70	1,5 - 5,0																					
CNMA160612	15,875	16,1	6,35	1,2	0,30 - 0,65	1,2 - 7,0																					
CNMA160616	15,875	16,1	6,35	1,6	0,35 - 0,80	1,5 - 7,0																					
CNMA190612	19,05	19,3	6,35	1,2	0,30 - 0,65	1,2 - 8,0																					
CNMA190616	19,05	19,3	6,35	1,6	0,35 - 0,80	1,5 - 8,0																					
CNMA190624	19,05	19,3	6,35	2,4	0,40 - 0,90	2,5 - 8,0																					
CNMA120408T02020	12,7	12,9	4,76	0,8	0,25 - 0,50	0,8 - 5,0																					
CNMA120412T02020	12,7	12,9	4,76	1,2	0,30 - 0,60	1,2 - 5,0																					
CNMA120416T02020	12,7	12,9	4,76	1,6	0,35 - 0,70	1,5 - 5,0																					
CNMA160612T02020	15,875	16,1	6,35	1,2	0,30 - 0,65	1,2 - 7,0																					
CNMA160616T02020	15,875	16,1	6,35	1,6	0,35 - 0,80	1,5 - 7,0																					
CNMA190612T02020	19,05	19,3	6,35	1,2	0,30 - 0,65	1,2 - 8,0																					
CNMA190616T02020	19,05	19,3	6,35	1,6	0,35 - 0,80	1,5 - 8,0																					
CNMA120408T02020	12,7	12,9	4,76	0,8	0,10 - 0,36	0,1 - 6,0																					
CNMA120412T02020	12,7	12,9	4,76	1,2	0,10 - 0,54	0,1 - 6,0																					
CNMA120416T02020	12,7	12,9	4,76	1,6	0,10 - 0,60	0,1 - 6,0																					
CNMA120404	12,7	12,9	4,76	0,4	0,05 - 0,20	0,1 - 2,5																					
CNMA120408	12,7	12,9	4,76	0,8	0,05 - 0,25	0,1 - 2,4																					
CNMA120412	12,7	12,9	4,76	1,2	0,05 - 0,30	0,1 - 2,3																					
CNMA120404-2	12,7	12,9	4,76	0,4	0,05 - 0,20	0,1 - 2,5																					
CNMA120408-2	12,7	12,9	4,76	0,8	0,05 - 0,25	0,1 - 2,4																					
CNMA120412-2	12,7	12,9	4,76	1,2	0,05 - 0,30	0,1 - 2,3																					

For achievable surface finish qualities and technical information, see page A 298.

- HC = Coated carbide
- CN = Silicon nitride Si₃N₄
- HW = Uncoated carbide
- BL = CBN with low CBN content
- BH = CBN with high CBN content

Negative basic shape DNMG / DNMG / DNMM / DNMA

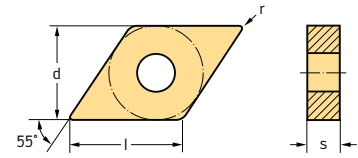
Tiger-tec®

Indexable inserts

Designation	d mm	l mm	s mm	r mm	f mm	ap mm	P					M			K			S			H		
							WPP01	WPP05	WPP10	WPP20	WPP30	WSM10	WSM20	WSM30	WAK10	WAK20	WSN10	WSM10	WSM20	WSM30	WS10	WCB30	WCB50
Wiper	DNMG110408-NF	9,525	11,6	4,76	0,8	0,15 - 0,50	0,5 - 2,0	☺	☺	☺		☺						☺					
	DNMG150408-NF	12,7	15,5	4,76	0,8	0,15 - 0,50	0,5 - 3,0	☺	☺	☺		☺						☺					
	DNMG150608-NF	12,7	15,5	6,35	0,8	0,15 - 0,50	0,5 - 3,0	☺	☺	☺		☺						☺					
	DNMG110402-NF3	9,525	11,6	4,76	0,2	0,04 - 0,12	0,1 - 0,5	☺	☺	☺													
	DNMG110404-NF3	9,525	11,6	4,76	0,4	0,04 - 0,20	0,1 - 1,5	☺	☺	☺													
	DNMG110408-NF3	9,525	11,6	4,76	0,8	0,08 - 0,25	0,2 - 2,0	☺	☺	☺													
	DNMG110412-NF3	9,525	11,6	4,76	1,2	0,10 - 0,25	0,5 - 2,5	☺	☺	☺													
	DNMG150404-NF3	12,7	15,5	4,76	0,4	0,05 - 0,20	0,1 - 1,5	☺	☺	☺													
	DNMG150408-NF3	12,7	15,5	4,76	0,8	0,08 - 0,25	0,2 - 2,0	☺	☺	☺													
	DNMG150412-NF3	12,7	15,5	4,76	1,2	0,10 - 0,25	0,5 - 2,5	☺	☺	☺													
	DNMG150604-NF3	12,7	15,5	6,35	0,4	0,05 - 0,20	0,1 - 1,5	☺	☺	☺													
	DNMG150608-NF3	12,7	15,5	6,35	0,8	0,08 - 0,25	0,2 - 2,0	☺	☺	☺													
	DNMG150612-NF3	12,7	15,5	6,35	1,2	0,10 - 0,25	0,5 - 2,5	☺	☺	☺													
	DNGG150404-NFT	12,7	15,5	4,76	0,4	0,05 - 0,14	0,2 - 1,5															☺	
	DNGG150408-NFT	12,7	15,5	4,76	0,8	0,07 - 0,17	0,3 - 2,0															☺	
	DNGG150604-NFT	12,7	15,5	6,35	0,4	0,05 - 0,14	0,2 - 1,5															☺	
	DNGG150608-NFT	12,7	15,5	6,35	0,8	0,07 - 0,17	0,3 - 2,0															☺	
	DNMG150404-NFT	12,7	15,5	4,76	0,4	0,06 - 0,16	0,4 - 1,5					☺						☺				☺	
	DNMG150408-NFT	12,7	15,5	4,76	0,8	0,08 - 0,19	0,5 - 2,0					☺						☺				☺	
	DNMG150604-NFT	12,7	15,5	6,35	0,4	0,06 - 0,16	0,4 - 1,5					☺						☺				☺	
	DNMG150608-NFT	12,7	15,5	6,35	0,8	0,08 - 0,19	0,5 - 2,0					☺						☺				☺	
	DNMG110404-NF4	9,525	11,6	4,76	0,4	0,05 - 0,12	0,2 - 1,0					☺	☺				☺	☺					
	DNMG110408-NF4	9,525	11,6	4,76	0,8	0,07 - 0,16	0,4 - 1,5					☺	☺				☺	☺					
	DNMG150404-NF4	12,7	15,5	4,76	0,4	0,05 - 0,12	0,2 - 1,0					☺	☺				☺	☺					
	DNMG150408-NF4	12,7	15,5	4,76	0,8	0,05 - 0,12	0,2 - 1,0					☺	☺				☺	☺					
	DNMG150412-NF4	12,7	15,5	4,76	1,2	0,05 - 0,12	0,2 - 1,0					☺	☺				☺	☺					
	DNMG150604-NF4	12,7	15,5	6,35	0,4	0,05 - 0,12	0,2 - 1,0					☺	☺				☺	☺					
	DNMG150608-NF4	12,7	15,5	6,35	0,8	0,07 - 0,16	0,4 - 1,5					☺	☺				☺	☺					
	DNMG150612-NF4	12,7	15,5	6,35	1,2	0,10 - 0,20	0,5 - 1,6					☺	☺				☺	☺					

For achievable surface finish qualities and technical information, see page A 298.

HC = Coated carbide
 CN = Silicon nitride Si₃N₄
 HW = Uncoated carbide
 BL = CBN with low CBN content
 BH = CBN with high CBN content

Negative basic shape DNMG / DNMG / DNMM / DNMA

Tiger-tec®

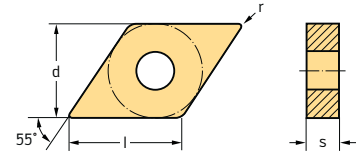

Indexable inserts

Designation	d mm	l mm	s mm	r mm	f mm	ap mm	P					M			K		S				H		
							HC					HC			HC	CN	HC		HW	BL	BH		
							WPP01	WPP05	WPP10	WPP20	WPP30	WSM10	WSM20	WSM30	WAK10	WAK20	WSN10	WSM10	WSM20	WSM30	WS10	WCB30	WCB50
DNMG110404-NS6	9,525	11,6	4,76	0,4	0,08 - 0,20	0,3 - 2,0	☺	☺	☺														
DNMG110408-NS6	9,525	11,6	4,76	0,8	0,12 - 0,32	0,6 - 2,5	☺	☺	☺														
DNMG150404-NS6	12,7	15,5	4,76	0,4	0,08 - 0,20	0,3 - 2,0	☺	☺	☺														
DNMG150408-NS6	12,7	15,5	4,76	0,8	0,12 - 0,32	0,6 - 2,5	☺	☺	☺														
DNMG150412-NS6	12,7	15,5	4,76	1,2	0,16 - 0,40	1,2 - 3,2	☺	☺	☺														
DNMG150604-NS6	12,7	15,5	6,35	0,4	0,08 - 0,20	0,3 - 2,0	☺	☺	☺														
DNMG150608-NS6	12,7	15,5	6,35	0,8	0,12 - 0,32	0,6 - 2,5	☺	☺	☺														
DNMG150612-NS6	12,7	15,5	6,35	1,2	0,16 - 0,40	1,2 - 3,2	☺	☺	☺														
DNMG110408-NM	9,525	11,6	4,76	0,8	0,15 - 0,50	0,8 - 3,0		☺	☺	☺					☺	☺							
DNMG110412-NM	9,525	11,6	4,76	1,2	0,20 - 0,60	1,5 - 4,0		☺	☺	☺					☺	☺							
DNMG150408-NM	12,7	15,5	4,76	0,8	0,15 - 0,50	0,8 - 3,0		☺	☺	☺					☺	☺							
DNMG150412-NM	12,7	15,5	4,76	1,2	0,20 - 0,60	1,5 - 4,0		☺	☺	☺					☺	☺							
DNMG150608-NM	12,7	15,5	6,35	0,8	0,15 - 0,50	0,8 - 3,0		☺	☺	☺					☺	☺							
DNMG150612-NM	12,7	15,5	6,35	1,2	0,20 - 0,60	1,5 - 4,0		☺	☺	☺					☺	☺							
DNMG110404-NMT	9,525	11,6	4,76	0,4	0,08 - 0,22	0,4 - 2,5			☺	☺	☺								☺	☺			
DNMG110408-NMT	9,525	11,6	4,76	0,8	0,12 - 0,28	0,6 - 3,2			☺	☺	☺								☺	☺			
DNMG150408-NMT	12,7	15,5	4,76	0,8	0,12 - 0,28	0,6 - 4,0			☺	☺	☺								☺	☺			
DNMG150412-NMT	12,7	15,5	4,76	1,2	0,15 - 0,30	0,8 - 4,0			☺	☺	☺								☺	☺			
DNMG150608-NMT	12,7	15,5	6,35	0,8	0,12 - 0,28	0,6 - 4,0			☺	☺	☺								☺	☺			
DNMG150612-NMT	12,7	15,5	6,35	1,2	0,15 - 0,30	0,8 - 4,0			☺	☺	☺								☺	☺			
DNMG150404-NMS	12,7	15,5	4,76	0,4	0,09 - 0,22	0,6 - 2,5													☺	☺			
DNMG150408-NMS	12,7	15,5	4,76	0,8	0,11 - 0,30	0,8 - 3,5													☺	☺			
DNMG150604-NMS	12,7	15,5	6,35	0,4	0,09 - 0,22	0,6 - 2,5													☺	☺			
DNMG150608-NMS	12,7	15,5	6,35	0,8	0,11 - 0,30	0,8 - 3,5													☺	☺			

For achievable surface finish qualities and technical information, see page A 298.

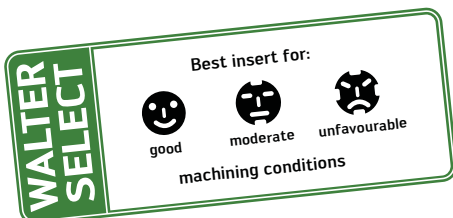

HC = Coated carbide
 CN = Silicon nitride Si₃N₄
 HW = Uncoated carbide
 BL = CBN with low CBN content
 BH = CBN with high CBN content

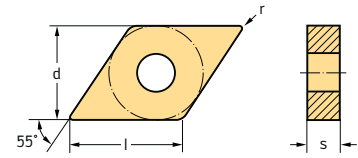

Negative basic shape DNGG / DNMG / DNMM / DNMA

Tiger-tec®

Indexable inserts

Designation	d mm	l mm	s mm	r mm	f mm	ap mm	P					M			K		S			H		
							HC					HC			HC	CN	HC			HW	BL	BH
							WPP01	WPP05	WPP10	WPP20	WPP30	WSM10	WSM20	WSM30	WAK10	WAK20	WSN10	WSM10	WSM20	WSM30	WS10	WCB30
 DNMG110404-NM4	9,525	11,6	4,76	0,4	0,16 - 0,25	0,5 - 4,0	☺	☺	☺	☺	☺	☺	☺	☺	☺	☺	☺	☺	☺			
DNMG110408-NM4	9,525	11,6	4,76	0,8	0,18 - 0,35	0,6 - 4,0	☺	☺	☺	☺	☺	☺	☺	☺	☺	☺	☺	☺	☺			
DNMG110412-NM4	9,525	11,6	4,76	1,2	0,20 - 0,35	1,0 - 4,0		☺	☺	☺	☺	☺	☺	☺	☺	☺	☺	☺	☺			
DNMG150408-NM4	12,7	15,5	4,76	0,8	0,18 - 0,35	0,6 - 5,0	☺	☺	☺	☺	☺	☺	☺	☺	☺	☺	☺	☺	☺			
DNMG150412-NM4	12,7	15,5	4,76	1,2	0,20 - 0,40	1,0 - 5,0	☺	☺	☺	☺	☺	☺	☺	☺	☺	☺	☺	☺	☺			
DNMG150604-NM4	12,7	15,5	6,35	0,4	0,16 - 0,25	0,5 - 4,0		☺	☺	☺	☺	☺	☺	☺	☺	☺	☺	☺	☺			
DNMG150608-NM4	12,7	15,5	6,35	0,8	0,18 - 0,35	0,6 - 5,0	☺	☺	☺	☺	☺	☺	☺	☺	☺	☺	☺	☺	☺			
DNMG150612-NM4	12,7	15,5	6,35	1,2	0,20 - 0,40	1,0 - 5,0	☺	☺	☺	☺	☺	☺	☺	☺	☺	☺	☺	☺	☺			
DNMG150616-NM4	12,7	15,5	6,35	1,6	0,25 - 0,40	1,2 - 5,0		☺	☺	☺												
 DNMG110404-NM5	9,525	11,6	4,76	0,4	0,15 - 0,25	0,6 - 4,0								☺	☺							
DNMG110408-NM5	9,525	11,6	4,76	0,8	0,15 - 0,40	0,6 - 4,0								☺	☺							
DNMG110412-NM5	9,525	11,6	4,76	1,2	0,20 - 0,50	1,0 - 4,0								☺	☺							
DNMG150408-NM5	12,7	15,5	4,76	0,8	0,25 - 0,45	0,8 - 5,0								☺	☺							
DNMG150412-NM5	12,7	15,5	4,76	1,2	0,30 - 0,45	1,2 - 5,0								☺	☺							
DNMG150608-NM5	12,7	15,5	6,35	0,8	0,25 - 0,45	0,8 - 5,0								☺	☺							
DNMG150612-NM5	12,7	15,5	6,35	1,2	0,30 - 0,45	1,2 - 5,0								☺	☺							
DNMG150616-NM5	12,7	15,5	6,35	1,6	0,35 - 0,45	1,6 - 5,0								☺	☺							
 DNMG110408-NM9	9,525	11,63	4,76	0,8	0,15 - 0,35	1,0 - 4,0	☺	☺	☺	☺												
DNMG110412-NM9	9,525	11,63	4,76	1,2	0,20 - 0,40	1,0 - 4,0	☺	☺	☺	☺												
DNMG150408-NM9	12,7	15,5	4,76	0,8	0,15 - 0,35	1,0 - 5,0	☺	☺	☺	☺												
DNMG150412-NM9	12,7	15,5	4,76	1,2	0,20 - 0,40	1,0 - 5,0	☺	☺	☺	☺												
DNMG150416-NM9	12,7	15,5	4,76	1,6	0,25 - 0,50	1,0 - 6,0	☺	☺	☺	☺												
DNMG150608-NM9	12,7	15,5	6,35	0,8	0,15 - 0,35	1,0 - 5,0	☺	☺	☺	☺												
DNMG150612-NM9	12,7	15,5	6,35	1,2	0,20 - 0,40	1,0 - 5,0	☺	☺	☺	☺												
DNMG150616-NM9	12,7	15,5	6,35	1,6	0,25 - 0,50	1,0 - 6,0	☺	☺	☺	☺												

For achievable surface finish qualities and technical information, see page A 298.

HC = Coated carbide
 CN = Silicon nitride Si₃N₄
 HW = Uncoated carbide
 BL = CBN with low CBN content
 BH = CBN with high CBN content

Negative basic shape DNMG / DNMG / DNMM / DNMA

Tiger-tec®

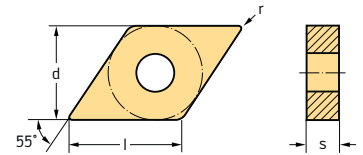

Indexable inserts

Designation	d mm	l mm	s mm	r mm	f mm	ap mm	P					M			K		S			H			
							HC					HC			HC	CN	HC			HW	BL	BH	
							WPP01	WPP05	WPP10	WPP20	WPP30	WSM10	WSM20	WSM30	WAK10	WAK20	WSN10	WSM10	WSM20	WSM30	WS10	WCB30	WCB50
DNMG150408-NRS	12,7	15,5	4,76	0,8	0,13 - 0,32	1,0 - 4,0						☺	☹					☺	☹				
DNMG150412-NRS	12,7	15,5	4,76	1,2	0,15 - 0,35	1,2 - 4,0						☺	☹					☺	☹				
DNMG150608-NRS	12,7	15,5	6,35	0,8	0,13 - 0,32	1,0 - 4,0						☺	☹					☺	☹				
DNMG150612-NRS	12,7	15,5	6,35	1,2	0,15 - 0,35	1,2 - 4,0						☺	☹					☺	☹				
DNMG110408-NR4	9,525	11,6	4,76	0,8	0,22 - 0,40	1,2 - 3,0						☹	☹	☹				☹	☹	☹			
DNMG110412-NR4	9,525	11,6	4,76	1,2	0,25 - 0,50	1,5 - 3,5						☹	☹	☹				☹	☹	☹			
DNMG150408-NR4	12,7	15,5	4,76	0,8	0,22 - 0,40	1,2 - 4,0						☹	☹	☹				☹	☹	☹			
DNMG150412-NR4	12,7	15,5	4,76	1,2	0,25 - 0,50	1,6 - 4,0						☹	☹	☹				☹	☹	☹			
DNMG150608-NR4	12,7	15,5	6,35	0,8	0,22 - 0,40	1,2 - 4,0						☹	☹	☹				☹	☹	☹			
DNMG150612-NR4	12,7	15,5	6,35	1,2	0,25 - 0,50	1,5 - 4,0						☹	☹	☹				☹	☹	☹			
DNMM150608-NRF	12,7	15	6,35	0,8	0,25 - 0,45	0,8 - 5,0			☺	☹	☹												
DNMM150612-NRF	12,7	15	6,35	1,2	0,30 - 0,50	1,2 - 5,0			☺	☺	☹	☹											
DNMM150616-NRF	12,7	15	6,35	1,6	0,35 - 0,60	1,6 - 5,0			☺	☺	☹	☹											
DNMA110404	9,525	11,6	4,76	0,4	0,16 - 0,25	0,6 - 4,0									☺	☹							
DNMA110408	9,525	11,6	4,76	0,8	0,18 - 0,40	0,6 - 4,0									☺	☹							
DNMA150408	12,7	15,5	4,76	0,8	0,20 - 0,45	0,8 - 5,0									☺	☹							
DNMA150412	12,7	15,5	4,76	1,2	0,25 - 0,45	1,2 - 5,0									☺	☹							
DNMA150608	12,7	15,5	6,35	0,8	0,20 - 0,45	0,8 - 5,0									☺	☹							
DNMA150612	12,7	15,5	6,35	1,2	0,25 - 0,45	1,2 - 5,0									☺	☹							
DNMA150608T02020	12,7	15,5	6,35	0,8	0,10 - 0,36	0,1 - 7,5											☺						
DNMA150612T02020	12,7	15,5	6,35	1,2	0,10 - 0,54	0,1 - 7,5											☺						
DNMA150604-2	12,7	15,5	6,35	0,4	0,05 - 0,20	0,1 - 2,5															☺	☹	
DNMA150608-2	12,7	15,5	6,35	0,8	0,05 - 0,25	0,1 - 2,1															☺	☹	
DNMA150612-2	12,7	15,5	6,35	1,2	0,05 - 0,30	0,1 - 2,1															☺	☹	

For achievable surface finish qualities and technical information, see page A 298.

HC = Coated carbide
 CN = Silicon nitride Si₃N₄
 HW = Uncoated carbide
 BL = CBN with low CBN content
 BH = CBN with high CBN content

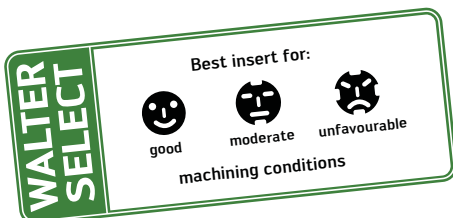

Negative basic shape SNMG / SNMM / SNMA

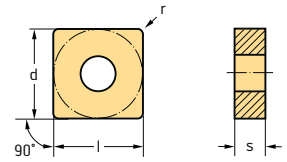
Tiger-tec®

Indexable inserts

Designation	d mm	l mm	s mm	r mm	f mm	ap mm	P					M			K			S			H					
							HC					HC			HC			CN			HC			HW	BL	BH
							WPP01	WPP05	WPP10	WPP20	WPP30	WSM10	WSM20	WSM30	WAK10	WAK20	WAK30	WSN10	WSM10	WSM20	WSM30	WS10	WCB30	WCB50		
	SNMG120404-NF3	12,7	12,7	4,76	0,4	0,04 - 0,22	0,1 - 1,8		☺	☺																
	SNMG120408-NF3	12,7	12,7	4,76	0,8	0,08 - 0,25	0,2 - 2,0		☺	☺																
	SNMG120412-NF3	12,7	12,7	4,76	1,2	0,10 - 0,25	0,5 - 2,5		☺	☺																
	SNMG120404-NF4	12,7	12,7	4,76	0,4	0,05 - 0,12	0,2 - 1,0						☺	☺												
	SNMG120408-NF4	12,7	12,7	4,76	0,8	0,07 - 0,16	0,4 - 1,5						☺	☺												
	SNMG120412-NF4	12,7	12,7	4,76	1,2	0,10 - 0,20	0,5 - 1,6						☺	☺												
	SNMG120404-NS6	12,7	12,7	4,76	0,4	0,08 - 0,20	0,3 - 2,0		☺	☺																
	SNMG120408-NS6	12,7	12,7	4,76	0,8	0,12 - 0,32	0,6 - 2,5		☺	☺																
	SNMG120412-NS6	12,7	12,7	4,76	1,2	0,16 - 0,40	1,2 - 3,2		☺	☺																
	SNMG120404-NM4	12,7	12,7	4,76	0,4	0,10 - 0,18	0,5 - 2,0						☺	☺					☺	☺						
	SNMG120408-NM4	12,7	12,7	4,76	0,8	0,18 - 0,40	0,6 - 5,0		☺	☺	☺	☺	☺	☺					☺	☺	☺					
	SNMG120412-NM4	12,7	12,7	4,76	1,2	0,20 - 0,40	1,0 - 5,0		☺	☺	☺	☺	☺	☺					☺	☺	☺					
	SNMG120416-NM4	12,7	12,7	4,76	1,6	0,25 - 0,40	1,2 - 5,0						☺	☺						☺	☺					
	SNMG150608-NM4	15,875	15,875	6,35	0,8	0,25 - 0,50	0,8 - 8,0																			
	SNMG150612-NM4	15,875	15,875	6,35	1,2	0,30 - 0,50	1,0 - 8,0																			
	SNMG150616-NM4	15,875	15,875	6,35	1,6	0,35 - 0,55	1,2 - 8,0																			
	SNMG120408-NM5	12,7	12,7	4,76	0,8	0,25 - 0,50	0,8 - 5,0												☺	☺	☺					
	SNMG120412-NM5	12,7	12,7	4,76	1,2	0,30 - 0,60	1,2 - 5,0												☺	☺	☺					
	SNMG120416-NM5	12,7	12,7	4,76	1,6	0,35 - 0,70	1,5 - 5,0												☺	☺	☺					
	SNMG150608-NM5	15,875	15,875	6,35	0,8	0,25 - 0,50	0,8 - 7,0													☺	☺					
	SNMG150612-NM5	15,875	15,875	6,35	1,2	0,30 - 0,60	1,2 - 7,0													☺	☺	☺				
	SNMG150616-NM5	15,875	15,875	6,35	1,6	0,35 - 0,70	1,5 - 7,0													☺	☺	☺				
	SNMG190612-NM5	19,05	19,05	6,35	1,2	0,30 - 0,65	1,2 - 8,0													☺	☺	☺				
	SNMG190616-NM5	19,05	19,05	6,35	1,6	0,35 - 0,80	1,5 - 8,0													☺	☺	☺				
SNMG190624-NM5	19,05	19,05	6,35	2,4	0,40 - 0,90	2,5 - 8,0													☺	☺	☺					

For achievable surface finish qualities and technical information, see page A 298.



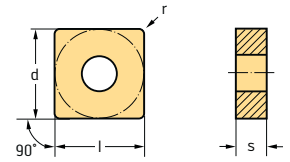

HC = Coated carbide
 CN = Silicon nitride Si₃N₄
 HW = Uncoated carbide
 BL = CBN with low CBN content
 BH = CBN with high CBN content

Negative basic shape SNMG / SNMM / SNMA

Tiger-tec®



Indexable inserts

Designation	d mm	l mm	s mm	r mm	f mm	ap mm	P					M			K			S			H	
							HC					HC			HC		CN	HC		HW	BL	BH
							WPP01	WPP05	WPP10	WPP20	WPP30	WSM10	WSM20	WSM30	WAK10	WAK20	WAK30	WSN10	WSM10	WSM20	WSM30	WS10
 SNMG120408-NM6	12,7	12,7	4,76	0,8	0,25 - 0,50	0,8 - 5,0			☺	☺	☺											
SNMG120412-NM6	12,7	12,7	4,76	1,2	0,30 - 0,50	1,2 - 5,0			☺	☺	☺											
SNMG120416-NM6	12,7	12,7	4,76	1,6	0,35 - 0,50	1,5 - 5,0			☺	☺	☺											
SNMG150608-NM6	15,875	15,875	6,35	0,8	0,30 - 0,50	0,8 - 6,0			☺	☺	☺											
SNMG150612-NM6	15,875	15,875	6,35	1,2	0,35 - 0,60	1,2 - 6,0			☺	☺	☺											
SNMG150616-NM6	15,875	15,875	6,35	1,6	0,40 - 0,60	1,5 - 6,0			☺	☺	☺											
SNMG190612-NM6	19,05	19,05	6,35	1,2	0,35 - 0,60	1,2 - 7,0			☺	☺	☺											
SNMG190616-NM6	19,05	19,05	6,35	1,6	0,40 - 0,60	1,5 - 7,0			☺	☺	☺											
SNMG190624-NM6	19,05	19,05	6,35	2,4	0,40 - 0,60	2,5 - 7,0			☺	☺	☺											
SNMG250924-NM6	25,4	25,4	9,525	2,4	0,55 - 1,00	3,0 - 10,0				☺												
 SNMG120408-NM9	12,7	12,7	4,76	0,8	0,20 - 0,50	1,0 - 6,0			☺	☺	☺											
SNMG120412-NM9	12,7	12,7	4,76	1,2	0,25 - 0,65	1,0 - 6,0			☺	☺	☺											
SNMG120416-NM9	12,7	12,7	4,76	1,6	0,35 - 0,75	1,0 - 6,0			☺	☺	☺											
SNMG150612-NM9	15,875	15,875	6,35	1,2	0,25 - 0,70	2,0 - 8,0			☺	☺	☺											
SNMG150616-NM9	15,875	15,875	6,35	1,6	0,35 - 0,80	2,0 - 8,0			☺	☺	☺											
SNMG190612-NM9	19,05	19,05	6,35	1,2	0,30 - 0,75	2,0 - 10,0			☺	☺	☺											
SNMG190616-NM9	19,05	19,05	6,35	1,6	0,35 - 0,90	2,0 - 10,0			☺	☺	☺											
 SNMG120412-NRT	12,7	12,7	4,76	1,2	0,25 - 0,50	0,8 - 6,0							☺					☺				
SNMG150612-NRT	15,875	15,875	6,35	1,2	0,30 - 0,60	1,0 - 7,5							☺					☺		☺		
SNMG150616-NRT	15,875	15,875	6,35	1,6	0,35 - 0,70	1,2 - 7,5							☺					☺		☺		
SNMG190616-NRT	19,05	19,05	6,35	1,6	0,40 - 0,80	1,5 - 9,0							☺					☺		☺		
 SNMG120408-NRS	12,7	12,7	4,76	0,8	0,20 - 0,40	0,8 - 5,0							☺	☺				☺	☺			
SNMG120412-NRS	12,7	12,7	4,76	1,2	0,22 - 0,45	1,0 - 5,0							☺	☺				☺	☺			
SNMG150616-NRS	15,875	15,875	6,35	1,6	0,24 - 0,55	1,2 - 7,0							☺	☺				☺	☺			
SNMG190612-NRS	19,05	19,05	6,35	1,2	0,24 - 0,55	1,0 - 9,0							☺	☺				☺	☺			
SNMG190616-NRS	19,05	19,05	6,35	1,6	0,27 - 0,60	1,2 - 9,0							☺	☺				☺	☺			

For achievable surface finish qualities and technical information, see page A 298.

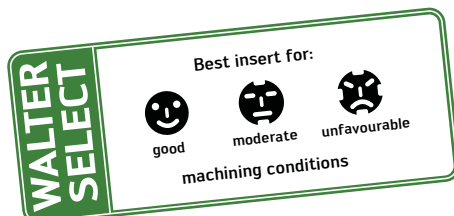

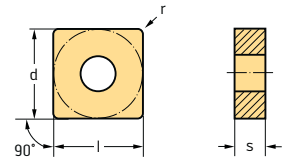

HC = Coated carbide
 CN = Silicon nitride Si₃N₄
 HW = Uncoated carbide
 BL = CBN with low CBN content
 BH = CBN with high CBN content

Negative basic shape SNMG / SNMM / SNMA

Tiger-tec®

Indexable inserts

Designation	d mm	l mm	s mm	r mm	f mm	ap mm	P					M			K			S			H		
							HC					HC			HC		CN	HC			HW	BL	BH
							WPP01	WPP05	WPP10	WPP20	WPP30	WSM10	WSM20	WSM30	WAK10	WAK20	WAK30	WSN10	WSM10	WSM20	WSM30	WS10	WCB30
 SNMG120408-NR4	12,7	12,7	4,76	0,8	0,22 - 0,40	1,2 - 5,0																	
SNMG120412-NR4	12,7	12,7	4,76	1,2	0,25 - 0,50	1,5 - 5,0																	
SNMG120416-NR4	12,7	12,7	4,76	1,6	0,30 - 0,55	2,0 - 5,0																	
SNMG150608-NR4	15,875	15,875	6,35	0,8	0,22 - 0,45	1,2 - 7,0																	
SNMG150612-NR4	15,875	15,875	6,35	1,2	0,25 - 0,60	1,5 - 7,0																	
SNMG150616-NR4	15,875	15,875	6,35	1,6	0,30 - 0,65	2,0 - 7,0																	
SNMG190612-NR4	19,05	19,05	6,35	1,2	0,25 - 0,60	1,5 - 8,0																	
SNMG190616-NR4	19,05	19,05	6,35	1,6	0,30 - 0,80	2,0 - 8,0																	
 SNMM120408-NRF	12,7	12,7	4,76	0,8	0,30 - 0,50	0,8 - 7,0			☺	☺	☺	☺											
SNMM120412-NRF	12,7	12,7	4,76	1,2	0,35 - 0,70	1,2 - 7,0			☺	☺	☺	☺											
SNMM120416-NRF	12,7	12,7	4,76	1,6	0,40 - 0,90	1,6 - 7,0			☺	☺	☺	☺											
SNMM150612-NRF	15,875	15,875	6,35	1,2	0,35 - 0,75	1,2 - 9,0			☺	☺	☺	☺											
SNMM150616-NRF	15,875	15,875	6,35	1,6	0,40 - 0,90	1,6 - 9,0			☺	☺	☺	☺											
SNMM150624-NRF	15,875	15,875	6,35	2,4	0,45 - 1,10	2,0 - 9,0			☺	☺	☺	☺											
SNMM190612-NRF	19,05	19,05	6,35	1,2	0,35 - 0,75	1,2 - 10,0			☺	☺	☺	☺											
SNMM190616-NRF	19,05	19,05	6,35	1,6	0,40 - 1,00	1,6 - 10,0			☺	☺	☺	☺											
SNMM190624-NRF	19,05	19,05	6,35	2,4	0,45 - 1,20	2,0 - 10,0			☺	☺	☺	☺											
SNMM250716-NRF	25,4	25,4	7,94	1,6	0,45 - 1,00	1,6 - 12,0			☺	☺	☺	☺											
SNMM250724-NRF	25,4	25,4	7,94	2,4	0,55 - 1,20	2,5 - 12,0			☺	☺	☺	☺											
SNMM250916-NRF	25,4	25,4	9,52	1,6	0,45 - 1,00	1,6 - 12,0			☺	☺	☺	☺											
SNMM250924-NRF	25,4	25,4	9,52	2,4	0,55 - 1,20	2,5 - 12,0			☺	☺	☺	☺											
 SNMM190616-NR6	19,05	19,05	6,35	1,6	0,45 - 0,95	2,0 - 10,0			☺	☺	☺												
SNMM190624-NR6	19,05	19,05	6,35	2,4	0,55 - 1,25	2,5 - 10,0				☺													
SNMM250716-NR6	25,4	25,4	7,94	1,6	0,45 - 1,00	2,0 - 12,0				☺													

For achievable surface finish qualities and technical information, see page A 298.

HC = Coated carbide
 CN = Silicon nitride Si₃N₄
 HW = Uncoated carbide
 BL = CBN with low CBN content
 BH = CBN with high CBN content

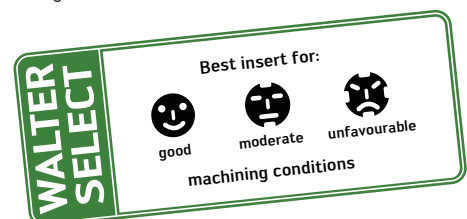



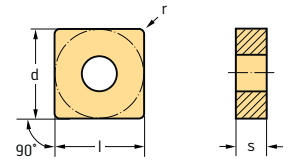

Negative basic shape SNMG / SNMM / SNMA

Tiger-tec®



Indexable inserts

Designation	d mm	l mm	s mm	r mm	f mm	ap mm	P					M			K		S				H			
							HC					HC			HC		CN		HC		HW	BL	BH	
							WPP01	WPP05	WPP10	WPP20	WPP30	WSM10	WSM20	WSM30	WAK10	WAK20	WAK30	WSN10	WSM10	WSM20	WSM30	WS10	WCB30	WCB50
 SNMM190612-NRR	19,05	19,05	6,35	1,2	0,50 - 1,00	2,0 - 13,0			☺	☺	☺													
SNMM190616-NRR	19,05	19,05	6,35	1,6	0,50 - 1,10	2,5 - 13,0			☺	☺	☺													
SNMM190624-NRR	19,05	19,05	6,35	2,4	0,60 - 1,60	3,0 - 13,0			☺	☺	☺													
SNMM250716-NRR	25,4	25,4	7,94	1,6	0,50 - 1,10	2,5 - 17,0			☺	☺	☺													
SNMM250724-NRR	25,4	25,4	7,94	2,4	0,60 - 1,60	3,0 - 17,0			☺	☺	☺													
SNMM250916-NRR	25,4	25,4	9,52	1,6	0,50 - 1,10	2,5 - 17,0			☺	☺	☺													
SNMM250924-NRR	25,4	25,4	9,52	2,4	0,60 - 1,60	3,0 - 17,0			☺	☺	☺													
SNMM250932-NRR	25,4	25,4	9,52	3,2	0,60 - 1,80	4,0 - 17,0			☺	☺	☺													
 SNMA120408	12,7	12,7	4,76	0,8	0,25 - 0,50	0,8 - 5,0																		
SNMA120412	12,7	12,7	4,76	1,2	0,30 - 0,60	1,2 - 5,0																		
SNMA120416	12,7	12,7	4,76	1,6	0,35 - 0,70	1,5 - 5,0																		
SNMA150612	15,875	15,875	6,35	1,2	0,30 - 0,65	1,2 - 7,0																		
SNMA150616	15,875	15,875	6,35	1,6	0,35 - 0,80	1,5 - 7,0																		
SNMA190612	19,05	19,05	6,35	1,2	0,30 - 0,65	1,2 - 8,0																		
SNMA190616	19,05	19,05	6,35	1,6	0,35 - 0,80	1,5 - 8,0																		
SNMA190624	19,05	19,05	6,35	2,4	0,40 - 0,90	2,5 - 8,0																		
 SNMA120408T02020	12,7	12,7	4,76	0,8	0,25 - 0,50	0,8 - 5,0																		
SNMA120412T02020	12,7	12,7	4,76	1,2	0,30 - 0,60	1,2 - 5,0																		
SNMA120416T02020	12,7	12,7	4,76	1,6	0,35 - 0,70	1,5 - 5,0																		
SNMA150612T02020	15,875	15,87	6,35	1,2	0,30 - 0,65	1,2 - 7,0																		
SNMA150616T02020	15,875	15,87	6,35	1,6	0,35 - 0,80	1,5 - 7,0																		
SNMA190612T02020	19,05	19,05	6,35	1,2	0,30 - 0,65	1,2 - 8,0																		
SNMA190616T02020	19,05	19,05	6,35	1,6	0,35 - 0,80	1,5 - 8,0																		
 SNMA120408T02020	12,7	12,7	4,76	0,8	0,10 - 0,36	0,1 - 6,0																		
SNMA120412T02020	12,7	12,7	4,76	1,2	0,10 - 0,54	0,1 - 6,0																		
SNMA120416T02020	12,7	12,7	4,76	1,6	0,10 - 0,60	0,1 - 6,0																		

For achievable surface finish qualities and technical information, see page A 298.

HC = Coated carbide
 CN = Silicon nitride Si₃N₄
 HW = Uncoated carbide
 BL = CBN with low CBN content
 BH = CBN with high CBN content

Negative basic shape SNMG / SNMM / SNMA

Tiger-tec®

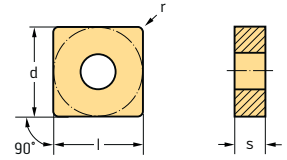

Indexable inserts

Designation	d mm	l mm	s mm	r mm	f mm	ap mm	P					M			K			S			H						
							HC					HC			HC			CN			HC			HW	BL	BH	
							WPP01	WPP05	WPP10	WPP20	WPP30	WSM10	WSM20	WSM30	WAK10	WAK20	WAK30	WSN10	WSM10	WSM20	WSM30	WS10	WCB30	WCB50			
 SNMA120408	12,7	12,7	4,76	0,8	0,05 - 0,25	0,1 - 2,3																			☺	☹	
SNMA120412	12,7	12,7	4,76	1,2	0,05 - 0,30	0,1 - 2,1																				☺	☹

For achievable surface finish qualities and technical information, see page A 298.

- HC = Coated carbide
- CN = Silicon nitride Si₃N₄
- HW = Uncoated carbide
- BL = CBN with low CBN content
- BH = CBN with high CBN content

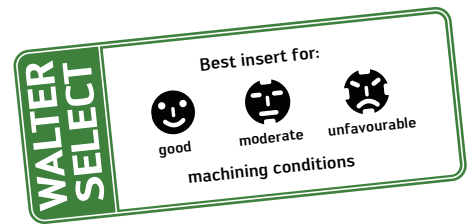





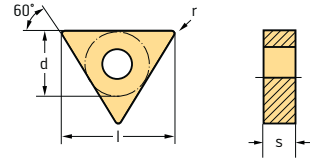

Negative basic shape TNMG / TNMM / TNMA

Tiger-tec®



Indexable inserts

Designation	d mm	l mm	s mm	r mm	f mm	ap mm	P					M			K			S			H					
							HC					HC			HC			CN			HC			HW	BL	BH
							WPP01	WPP05	WPP10	WPP20	WPP30	WSM10	WSM20	WSM30	WAK10	WAK20	WAK30	WSN10	WSM10	WSM20	WSM30	WS10	WCB30	WCB50		
 TNMG160404-NF3	9,525	16,5	4,76	0,4	0,04 - 0,20	0,1 - 1,5	☺	☺	☺																	
TNMG160408-NF3	9,525	16,5	4,76	0,8	0,08 - 0,25	0,2 - 2,0	☺	☺	☺																	
TNMG160412-NF3	9,525	16,5	4,76	1,2	0,10 - 0,25	0,5 - 2,5	☺	☺	☺																	
 TNMG160404-NF4	9,525	16,5	4,76	0,4	0,05 - 0,12	0,2 - 1,0					☺	☺				☺	☺									
TNMG160408-NF4	9,525	16,5	4,76	0,8	0,07 - 0,16	0,4 - 1,5					☺	☺				☺	☺									
TNMG160412-NF4	9,525	16,5	4,76	1,2	0,10 - 0,20	0,5 - 1,6					☺	☺				☺	☺									
 TNMG160404-NS6	9,525	16,5	4,76	0,4	0,08 - 0,20	0,3 - 2,0	☺	☺	☺																	
TNMG160408-NS6	9,525	16,5	4,76	0,8	0,12 - 0,32	0,6 - 2,5	☺	☺	☺																	
TNMG160412-NS6	9,525	16,5	4,76	1,2	0,16 - 0,40	1,2 - 3,2	☺	☺	☺																	
TNMG220408-NS6	12,7	22	4,76	0,8	0,12 - 0,32	0,6 - 2,5	☺	☺	☺																	
TNMG220412-NS6	12,7	22	4,76	1,2	0,16 - 0,40	1,2 - 3,2	☺	☺	☺																	
 TNMG160404-NMT	9,525	16,5	4,76	0,4	0,08 - 0,20	0,6 - 3,0		☺	☺	☺		☺					☺	☺								
TNMG160408-NMT	9,525	16,5	4,76	0,8	0,12 - 0,30	1,0 - 4,0		☺	☺	☺		☺					☺	☺								
 TNMG160404-NMS	9,525	16,5	4,76	0,4	0,09 - 0,22	0,6 - 2,5						☺	☺				☺	☺								
TNMG160408-NMS	9,525	16,5	4,76	0,8	0,11 - 0,30	0,8 - 3,5						☺	☺				☺	☺								
 TNMG160404-NM4	9,525	16,5	4,76	0,4	0,16 - 0,25	0,5 - 4,0		☺	☺	☺		☺	☺	☺			☺	☺	☺							
TNMG160408-NM4	9,525	16,5	4,76	0,8	0,18 - 0,35	0,6 - 4,0		☺	☺	☺		☺	☺	☺			☺	☺	☺							
TNMG160412-NM4	9,525	16,5	4,76	1,2	0,20 - 0,35	1,0 - 4,0		☺	☺	☺		☺	☺	☺			☺	☺	☺							
TNMG160416-NM4	9,525	16,5	4,76	1,6	0,20 - 0,35	1,0 - 4,0						☺	☺				☺	☺								
TNMG220408-NM4	12,7	22	4,76	0,8	0,18 - 0,35	0,8 - 5,0		☺	☺	☺																
TNMG220412-NM4	12,7	22	4,76	1,2	0,20 - 0,40	1,0 - 5,0		☺	☺	☺																

For achievable surface finish qualities and technical information, see page A 298.

HC = Coated carbide
 CN = Silicon nitride Si₃N₄
 HW = Uncoated carbide
 BL = CBN with low CBN content
 BH = CBN with high CBN content

Negative basic shape TNMG / TNMM / TNMA

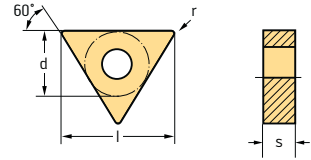
Tiger-tec®

Indexable inserts

Designation	d mm	l mm	s mm	r mm	f mm	ap mm	P					M			K			S			H					
							HC					HC			CN			HC			HW	BL	BH			
							WPP01	WPP05	WPP10	WPP20	WPP30	WSM10	WSM20	WSM30	WAK10	WAK20	WAK30	WSN10	WSM10	WSM20	WSM30	WS10	WCB30	WCB50		
TNMG160404-NM5	9,525	16,5	4,76	0,4	0,16 - 0,25	0,6 - 4,0									☺	☺										
TNMG160408-NM5	9,525	16,5	4,76	0,8	0,25 - 0,45	0,8 - 5,0									☺	☺										
TNMG160412-NM5	9,525	16,5	4,76	1,2	0,30 - 0,45	1,2 - 5,0									☺	☺										
TNMG160416-NM5	9,525	16,5	4,76	1,6	0,35 - 0,45	1,5 - 5,0									☺	☺										
TNMG220408-NM5	12,7	22	4,76	0,8	0,25 - 0,45	1,0 - 6,0									☺	☺										
TNMG220412-NM5	12,7	22	4,76	1,2	0,30 - 0,45	1,4 - 6,0									☺	☺										
TNMG220416-NM5	12,7	22	4,76	1,6	0,35 - 0,45	1,6 - 6,0									☺	☺										
TNMG270616-NM6	15,875	27	6,35	1,6	0,45 - 0,90	3,0 - 9,0				☺	☺															
TNMG270624-NM6	15,875	27	6,35	2,4	0,55 - 1,00	3,0 - 9,0				☺							☺									
TNMG160408-NM9	9,525	16,5	4,76	0,8	0,20 - 0,40	1,0 - 5,0	☺	☺	☺	☺																
TNMG160412-NM9	9,525	16,5	4,76	1,2	0,25 - 0,55	1,0 - 5,0	☺	☺	☺	☺																
TNMG220408-NM9	12,7	22	4,76	0,8	0,20 - 0,45	2,0 - 7,0			☺	☺	☺															
TNMG220412-NM9	12,7	22	4,76	1,2	0,25 - 0,60	2,0 - 7,0			☺	☺	☺															
TNMG220416-NM9	12,7	22	4,76	1,6	0,35 - 0,70	2,0 - 7,0			☺	☺	☺															
TNMG160408-NR4	9,525	16,5	4,76	0,8	0,22 - 0,40	1,2 - 4,0						☺	☺								☺	☺				
TNMG160412-NR4	9,525	16,5	4,76	1,2	0,25 - 0,50	1,5 - 4,5						☺	☺								☺	☺				
TNMG220408-NR4	12,7	22	4,76	0,8	0,22 - 0,40	1,2 - 5,0						☺	☺								☺	☺				
TNMG220412-NR4	12,7	22	4,76	1,2	0,25 - 0,55	1,5 - 6,0						☺	☺								☺	☺				
TNMG220416-NR4	12,7	22	4,76	1,6	0,30 - 0,60	2,0 - 7,0						☺	☺								☺	☺				
TNMM160408-NRF	9,525	16,5	4,76	0,8	0,30 - 0,45	0,8 - 6,0				☺	☺															
TNMM160412-NRF	9,525	16,5	4,76	1,2	0,35 - 0,50	1,2 - 6,0				☺	☺															
TNMM220408-NRF	12,7	22	4,76	0,8	0,30 - 0,50	0,8 - 7,0				☺	☺															
TNMM220412-NRF	12,7	22	4,76	1,2	0,35 - 0,60	1,2 - 7,0				☺	☺															
TNMM220416-NRF	12,7	22	4,76	1,2	0,40 - 0,80	1,6 - 7,0				☺	☺															
TNMM270612-NRF	15,875	27	6,35	1,2	0,35 - 0,65	1,2 - 8,0				☺	☺															
TNMM270616-NRF	15,875	27	6,35	1,6	0,40 - 0,85	1,6 - 8,0				☺	☺															

For achievable surface finish qualities and technical information, see page A 298.

HC = Coated carbide
 CN = Silicon nitride Si₃N₄
 HW = Uncoated carbide
 BL = CBN with low CBN content
 BH = CBN with high CBN content

Negative basic shape TNMG / TNMM / TNMA

Tiger-tec®

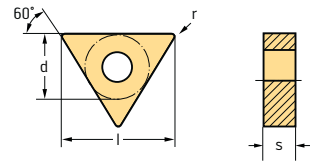

Indexable inserts

Designation	d mm	l mm	s mm	r mm	f mm	ap mm	P					M			K			S				H	
							HC					HC			HC		CN	HC			HW	BL	BH
							WPP01	WPP05	WPP10	WPP20	WPP30	WSM10	WSM20	WSM30	WAK10	WAK20	WAK30	WSN10	WSM10	WSM20	WSM30	WS10	WCB30
TNMM270616-NRR	15,88	27	6,35	1,6	0,50 - 1,10	2,0 - 13,0			☺	☹	☹												
TNMM270624-NRR	15,88	27	6,35	2,4	0,60 - 1,60	3,0 - 13,0			☺	☹	☹												
TNMA160404	9,525	16,5	4,76	0,4	0,16 - 0,25	0,6 - 5,0																	
TNMA160408	9,525	16,5	4,76	0,8	0,25 - 0,45	0,8 - 5,0																	
TNMA160412	9,525	16,5	4,76	1,2	0,30 - 0,50	1,2 - 5,0																	
TNMA160416	9,525	16,5	4,76	1,6	0,25 - 0,60	1,5 - 5,0																	
TNMA220408	12,7	22	4,76	0,8	0,25 - 0,45	1,0 - 6,0																	
TNMA220412	12,7	22	4,76	1,2	0,30 - 0,55	1,4 - 6,0																	
TNMA220416	12,7	22	4,76	1,6	0,35 - 0,60	1,6 - 6,0																	
TNMA160408T02020	9,525	16,5	4,76	0,8	0,25 - 0,45	0,8 - 5,0																	
TNMA160412T02020	9,525	16,5	4,76	1,2	0,30 - 0,55	1,2 - 5,0																	
TNMA160416T02020	9,525	16,5	4,76	1,6	0,35 - 0,60	1,5 - 5,0																	
TNMA220408T02020	12,7	22	4,76	0,8	0,25 - 0,45	1,0 - 6,0																	
TNMA220412T02020	12,7	22	4,76	1,2	0,30 - 0,55	1,4 - 6,0																	
TNMA220416T02020	12,7	22	4,76	1,6	0,35 - 0,60	1,6 - 6,0																	
TNMA160408T02020	9,525	16,5	4,76	0,8	0,05 - 0,36	0,1 - 8,0																	
TNMA160412T02020	9,525	16,5	4,76	1,2	0,10 - 0,54	0,1 - 8,0																	
TNMA160404-3	9,525	16,5	4,76	0,4	0,05 - 0,20	0,1 - 2,3																☺	☹
TNMA160408-3	9,525	16,5	4,76	0,8	0,05 - 0,25	0,1 - 2,0																☺	☹
TNMA160412-3	9,525	16,5	4,76	1,2	0,05 - 0,30	0,1 - 2,0																☺	☹

For achievable surface finish qualities and technical information, see page A 298.



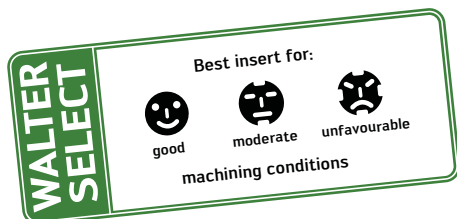

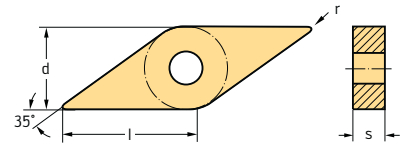

HC = Coated carbide
 CN = Silicon nitride Si₃N₄
 HW = Uncoated carbide
 BL = CBN with low CBN content
 BH = CBN with high CBN content



Negative basic shape VNGG / VNMG / VNMA

Tiger-tec®

Indexable inserts

Designation	d mm	l mm	s mm	r mm	f mm	ap mm	P					M			K		S			HW	
							HC					HC			HC		HC				
							WPP01	WPP05	WPP10	WPP20	WPP30	WSM10	WSM20	WSM30	WAK10	WAK20	WSM10	WSM20	WSM30	WS10	
 VNMG160404-NF3	9,525	16,5	4,76	0,4	0,04 - 0,22	0,1 - 1,5	☺	☺	☺												
VNMG160408-NF3	9,525	16,5	4,76	0,8	0,08 - 0,25	0,2 - 2,0	☺	☺	☺												
 VNGG160404-NFT	9,525	16,5	4,76	0,4	0,04 - 0,13	0,1 - 1,5															☺
VNGG160408-NFT	9,525	16,5	4,76	0,8	0,06 - 0,16	0,2 - 2,0															☺
VNMG160404-NFT	9,525	16,5	4,76	0,4	0,05 - 0,15	0,2 - 1,5						☺							☺		☺
VNMG160408-NFT	9,525	16,5	4,76	0,8	0,07 - 0,18	0,3 - 2,0						☺							☺		☺
 VNMG160404-NMS	9,525	16,5	4,76	0,4	0,08 - 0,16	0,5 - 1,5						☺	☺					☺	☺		
VNMG160408-NMS	9,525	16,5	4,76	0,8	0,10 - 0,22	0,8 - 2,2						☺	☺					☺	☺		
 VNMG160404-NM4	9,525	16,5	4,76	0,4	0,16 - 0,25	0,5 - 4,0		☺	☺	☺	☺	☺	☺	☺				☺	☺	☺	
VNMG160408-NM4	9,525	16,5	4,76	0,8	0,18 - 0,35	0,6 - 4,0		☺	☺	☺	☺	☺	☺	☺				☺	☺	☺	
VNMG160412-NM4	9,525	16,5	4,76	1,2	0,20 - 0,40	0,8 - 4,0			☺	☺											
 VNMG160404-NM5	9,525	16,5	4,76	0,4	0,16 - 0,25	0,6 - 4,0									☺	☺					
VNMG160408-NM5	9,525	16,5	4,76	0,8	0,18 - 0,35	0,8 - 4,0									☺	☺					
VNMG160412-NM5	9,525	16,5	4,76	1,2	0,20 - 0,40	1,0 - 4,0									☺	☺					
 VNMA160404	9,525	16,5	4,76	0,4	0,16 - 0,25	0,6 - 4,0									☺	☺					
VNMA160408	9,525	16,5	4,76	0,8	0,18 - 0,35	0,8 - 4,0									☺	☺					
VNMA160412	9,525	16,5	4,76	1,2	0,20 - 0,40	1,0 - 4,0									☺	☺					

For achievable surface finish qualities and technical information, see page A 298.

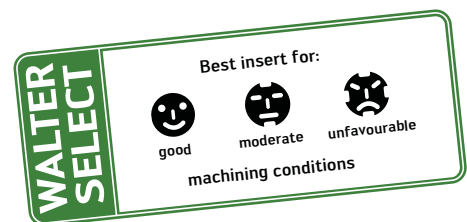
 HC = Coated carbide
 HW = Uncoated carbide

Negative basic shape WNMG / WNMM / WNMA

Tiger-tec®

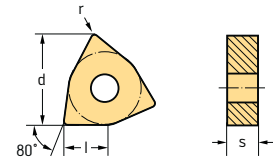

Indexable inserts

Image	Designation	d mm	l mm	s mm	r mm	f mm	ap mm	P				M			K		S			HW
								HC				HC			HC		HC			
								WPP01	WPP05	WPP10	WPP20	WPP30	WSM10	WSM20	WSM30	WAK10	WAK20	WSM10	WSM20	
	WNMG060404-NF	9,525	6,5	4,76	0,4	0,10 - 0,40	0,4 - 2,0	☺	☺	☺	☺	☺								
	WNMG060408-NF	9,525	6,5	4,76	0,8	0,15 - 0,50	0,5 - 3,0	☺	☺	☺	☺	☺								
	WNMG080404-NF	12,7	8,69	4,76	0,4	0,20 - 0,40	0,4 - 2,0	☺	☺	☺	☺	☺								
	WNMG080408-NF	12,7	8,69	4,76	0,8	0,25 - 0,55	0,5 - 3,0	☺	☺	☺	☺	☺								
	WNMG080412-NF	12,7	8,69	4,76	1,2	0,25 - 0,70	0,8 - 4,0	☺	☺	☺	☺	☺								
	WNMG060404-NF3	9,525	6,5	4,76	0,4	0,04 - 0,20	0,1 - 1,5	☺	☺	☺	☺									
	WNMG060408-NF3	9,525	6,5	4,76	0,8	0,08 - 0,25	0,2 - 2,0	☺	☺	☺	☺									
	WNMG060412-NF3	9,525	6,5	4,76	1,2	0,10 - 0,25	0,5 - 2,5	☺	☺	☺	☺									
	WNMG080404-NF3	12,7	8,69	4,76	0,4	0,05 - 0,20	0,1 - 1,5	☺	☺	☺	☺									
	WNMG080408-NF3	12,7	8,69	4,76	0,8	0,08 - 0,25	0,2 - 2,0	☺	☺	☺	☺									
	WNMG080412-NF3	12,7	8,69	4,76	1,2	0,10 - 0,25	0,5 - 2,5	☺	☺	☺	☺									
	WNMG060404-NF4	9,525	6,5	4,76	0,4	0,05 - 0,12	0,2 - 1,0					☺	☺			☺	☺			
	WNMG060408-NF4	9,525	6,5	4,76	0,8	0,07 - 0,16	0,4 - 1,5					☺	☺			☺	☺			
	WNMG080404-NF4	12,7	8,69	4,76	0,4	0,05 - 0,12	0,2 - 1,0					☺	☺			☺	☺			
	WNMG080408-NF4	12,7	8,69	4,76	0,8	0,07 - 0,16	0,4 - 1,5					☺	☺			☺	☺			
	WNMG080412-NF4	12,7	8,69	4,76	1,2	0,10 - 0,20	0,5 - 1,6					☺	☺			☺	☺			
	WNMG080404-NS6	12,7	8,69	4,76	0,4	0,08 - 0,20	0,3 - 2,0	☺	☺	☺										
	WNMG080408-NS6	12,7	8,69	4,76	0,8	0,12 - 0,32	0,6 - 2,5	☺	☺	☺										
	WNMG080412-NS6	12,7	8,69	4,76	1,2	0,16 - 0,40	1,2 - 3,2	☺	☺	☺										
		WNMG060408-NM	9,525	6,5	4,76	0,8	0,20 - 0,55	0,8 - 3,0		☺	☺	☺				☺	☺			
WNMG060412-NM		9,525	6,5	4,76	1,2	0,25 - 0,55	1,5 - 4,0		☺	☺	☺				☺	☺				
WNMG080408-NM		12,7	8,69	4,76	0,8	0,20 - 0,55	0,8 - 3,0		☺	☺	☺				☺	☺		☺		
WNMG080412-NM		12,7	8,69	4,76	1,2	0,25 - 0,70	1,5 - 4,0		☺	☺	☺				☺	☺		☺		
	WNMG080408-NMT	12,7	8,69	4,76	0,8	0,12 - 0,30	0,8 - 4,0			☺	☺	☺						☺		☺
	WNMG080412-NMT	12,7	8,69	4,76	1,2	0,15 - 0,32	1,0 - 4,0			☺	☺	☺						☺		☺
	WNMG080404-NMS	12,7	8,69	4,76	0,4	0,10 - 0,24	0,6 - 2,5					☺	☺					☺	☺	
	WNMG080408-NMS	12,7	8,69	4,76	0,8	0,13 - 0,32	0,8 - 3,5					☺	☺					☺	☺	



For achievable surface finish qualities and technical information, see page A 298.

HC = Coated carbide
HW = Uncoated carbide

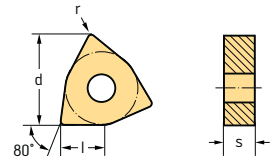
Negative basic shape WNMG / WNMM / WNMA

Tiger-tec®

Indexable inserts

Designation	d mm	l mm	s mm	r mm	f mm	ap mm	P					M			K		S			HW	
							HC					HC			HC		HC				
							WPP01	WPP05	WPP10	WPP20	WPP30	WSM10	WSM20	WSM30	WAK10	WAK20	WSM10	WSM20	WSM30		WS10
 WNMG060404-NM4	9,525	6,5	4,76	0,4	0,16 - 0,25	0,5 - 4,0	☺	☺	☺	☺	☺	☺	☺	☺	☺	☺	☺	☺	☺	☺	☺
WNMG060408-NM4	9,525	6,5	4,76	0,8	0,18 - 0,35	0,6 - 4,0	☺	☺	☺	☺	☺	☺	☺	☺	☺	☺	☺	☺	☺	☺	☺
WNMG060412-NM4	9,525	6,5	4,76	1,2	0,20 - 0,35	1,0 - 4,0	☺	☺	☺	☺	☺	☺	☺	☺	☺	☺	☺	☺	☺	☺	☺
WNMG080404-NM4	12,7	8,69	4,76	0,4	0,16 - 0,25	0,5 - 4,0		☺	☺	☺	☺	☺	☺	☺	☺	☺	☺	☺	☺	☺	☺
WNMG080408-NM4	12,7	8,69	4,76	0,8	0,18 - 0,40	0,6 - 5,0	☺	☺	☺	☺	☺	☺	☺	☺	☺	☺	☺	☺	☺	☺	☺
WNMG080412-NM4	12,7	8,69	4,76	1,2	0,20 - 0,40	1,0 - 5,0	☺	☺	☺	☺	☺	☺	☺	☺	☺	☺	☺	☺	☺	☺	☺
WNMG080416-NM4	12,7	8,69	4,76	1,6	0,25 - 0,45	1,2 - 5,0		☺	☺	☺	☺	☺	☺	☺	☺	☺	☺	☺	☺	☺	☺
WNMG100608-NM4	15,875	10,86	6,35	0,8	0,25 - 0,50	0,8 - 7,0		☺	☺	☺	☺	☺	☺	☺	☺	☺	☺	☺	☺	☺	☺
WNMG100612-NM4	15,875	10,86	6,35	1,2	0,30 - 0,50	1,0 - 7,0		☺	☺	☺	☺	☺	☺	☺	☺	☺	☺	☺	☺	☺	☺
WNMG100616-NM4	15,875	10,86	6,35	1,6	0,35 - 0,55	1,2 - 7,0		☺	☺	☺	☺	☺	☺	☺	☺	☺	☺	☺	☺	☺	☺
 WNMG060404-NM5	9,525	6,5	4,76	0,4	0,16 - 0,25	0,6 - 4,0								☺	☺						
WNMG060408-NM5	9,525	6,5	4,76	0,8	0,20 - 0,40	0,8 - 4,0								☺	☺						
WNMG060412-NM5	9,525	6,5	4,76	1,2	0,22 - 0,50	1,2 - 4,0								☺	☺						
WNMG080404-NM5	12,7	8,69	4,76	0,4	0,16 - 0,25	0,6 - 5,0								☺	☺						
WNMG080408-NM5	12,7	8,69	4,76	0,8	0,20 - 0,45	1,2 - 5,0								☺	☺						
WNMG080412-NM5	12,7	8,69	4,76	1,2	0,22 - 0,50	1,5 - 5,0								☺	☺						
WNMG080416-NM5	12,7	8,69	4,76	1,6	0,25 - 0,55	2,0 - 5,0								☺	☺						
WNMG100608-NM5	15,875	10,86	6,35	0,8	0,25 - 0,50	0,8 - 7,0								☺	☺						
WNMG100612-NM5	15,875	10,86	6,35	1,2	0,30 - 0,60	1,2 - 7,0								☺	☺						
WNMG100616-NM5	15,875	10,86	6,35	1,6	0,35 - 0,60	1,5 - 7,0								☺	☺						
 WNMG080408-NM6	12,7	8,69	4,76	0,8	0,16 - 0,45	1,0 - 5,0		☺	☺	☺											
WNMG080412-NM6	12,7	8,69	4,76	1,2	0,20 - 0,45	1,5 - 5,0		☺	☺	☺											
WNMG100608-NM6	15,875	10,86	6,35	0,8	0,25 - 0,45	1,0 - 8,0		☺	☺	☺											
WNMG100612-NM6	15,875	10,86	6,35	1,2	0,25 - 0,60	1,5 - 8,0		☺	☺	☺											
WNMG100616-NM6	15,875	10,86	6,35	1,6	0,35 - 0,70	2,0 - 8,0		☺	☺	☺											

For achievable surface finish qualities and technical information, see page A 298.

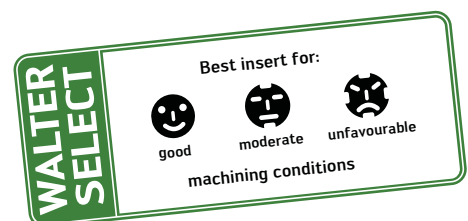
 HC = Coated carbide
 HW = Uncoated carbide

Negative basic shape WNMG / WNMM / WNMA

Tiger-tec®

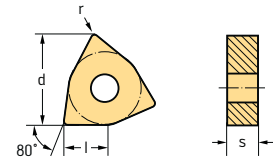

Designation	d mm	l mm	s mm	r mm	f mm	ap mm	P			M		K		S			
							HC			HC		HC		HC			
							WPP01	WPP05	WPP10	WPP20	WPP30	WSM10	WSM20	WSM30	WAK10	WAK20	WSM10
	WNMG060408-NM9	9,525	6,5	4,76	0,8	0,20 - 0,40	0,8 - 4,0			☉	☉	☉	☉				
	WNMG060412-NM9	9,525	6,5	4,76	1,2	0,25 - 0,50	0,8 - 4,0			☉	☉	☉	☉				
	WNMG080408-NM9	12,7	8,69	4,76	0,8	0,20 - 0,40	1,0 - 6,0			☉	☉	☉	☉				
	WNMG080412-NM9	12,7	8,69	4,76	1,2	0,25 - 0,55	1,0 - 6,0			☉	☉	☉	☉				
	WNMG080416-NM9	12,7	8,69	4,76	1,6	0,35 - 0,65	1,0 - 6,0			☉	☉	☉	☉				
	WNMG100608-NM9	15,875	10,86	6,35	0,8	0,20 - 0,45	2,0 - 8,0			☉	☉	☉	☉				
	WNMG100612-NM9	15,875	10,86	6,35	1,2	0,25 - 0,60	2,0 - 8,0			☉	☉	☉	☉				
WNMG100616-NM9	15,875	10,86	6,35	1,6	0,35 - 0,70	2,0 - 8,0			☉	☉	☉	☉					
	WNMG060408-NR4	9,525	6,5	4,76	0,8	0,22 - 0,40	1,2 - 3,5									☉	☉
	WNMG060412-NR4	9,525	6,5	4,76	1,2	0,25 - 0,50	1,5 - 3,5									☉	☉
	WNMG080408-NR4	12,7	8,69	4,76	0,8	0,22 - 0,40	1,2 - 4,5								☉	☉	☉
	WNMG080412-NR4	12,7	8,69	4,76	1,2	0,25 - 0,50	1,5 - 4,5								☉	☉	☉
	WNMG100608-NR4	15,875	10,86	6,35	0,8	0,22 - 0,45	1,2 - 6,0									☉	☉
	WNMG100612-NR4	15,875	10,86	6,35	1,2	0,25 - 0,60	1,5 - 6,0									☉	☉
	WNMG100616-NR4	15,875	10,86	6,35	1,6	0,30 - 0,65	2,0 - 6,0									☉	☉
	WNMM080412-NRF	12,7	8,72	4,76	1,2	0,35 - 0,60	1,2 - 6,0			☉	☉						
	WNMM100612-NRF	15,875	10,86	6,35	1,2	0,35 - 0,70	1,2 - 8,0			☉	☉	☉	☉				
	WNMM100616-NRF	15,875	10,86	6,35	1,6	0,40 - 0,90	1,6 - 8,0			☉	☉	☉	☉				
	WNMA060404	9,525	6,5	4,76	0,4	0,16 - 0,25	0,6 - 4,0									☉	☉
	WNMA060408	9,525	6,5	4,76	0,8	0,20 - 0,40	0,8 - 4,0									☉	☉
	WNMA060412	9,525	6,5	4,76	1,2	0,22 - 0,50	1,2 - 4,0									☉	☉
	WNMA080404	12,7	8,69	4,76	0,4	0,16 - 0,25	0,6 - 5,0									☉	☉
	WNMA080408	12,7	8,69	4,76	0,8	0,20 - 0,45	1,2 - 5,0									☉	☉
	WNMA080412	12,7	8,69	4,76	1,2	0,22 - 0,50	1,5 - 5,0									☉	☉
	WNMA100612	15,875	10,86	6,35	1,2	0,30 - 0,65	1,2 - 7,0									☉	☉
	WNMA100616	15,875	10,86	6,35	1,6	0,35 - 0,80	1,5 - 7,0									☉	☉
	WNMA060408T02020	9,525	6,5	4,76	0,8	0,20 - 0,40	0,8 - 4,0									☉	☉
	WNMA060412T02020	9,525	6,5	4,76	1,2	0,22 - 0,50	1,2 - 4,0									☉	☉
	WNMA080408T02020	12,7	8,69	4,76	0,8	0,20 - 0,45	1,2 - 5,0									☉	☉
	WNMA080412T02020	12,7	8,69	4,76	1,2	0,22 - 0,50	1,5 - 5,0									☉	☉
	WNMA100612T02020	15,875	10,86	6,35	1,2	0,30 - 0,65	1,2 - 7,0									☉	☉
	WNMA100616T02020	15,875	10,86	6,35	1,6	0,35 - 0,80	1,5 - 7,0									☉	☉

For achievable surface finish qualities and technical information, see page A 298.

HC = Coated carbide
HW = Uncoated carbide

Positive basic shape
 CCGT / CCMT / CCMW

Tiger-tec®

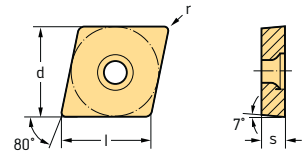

Indexable inserts

Designation	d mm	l mm	s mm	r mm	f mm	ap mm	P				M			K			N		S			H	
							HC				HC			HC			HC	HW	HC			BL	BH
							WPP01	WPP10	WPP20	WPP30	WSM10	WSM20	WSM30	WAK10	WAK20	WAK30	WXN10	WK1	WSM10	WSM20	WSM30	WCB30	WCB50
 Wiper	CCMT060204-PF	6,35	6,45	2,38	0,4	0,05 - 0,30	0,3 - 2,0	☺	☺	☺		☺	☺						☺	☺			
	CCMT060208-PF	6,35	6,45	2,38	0,8	0,09 - 0,35	0,3 - 2,0	☺	☺	☺		☺	☺						☺	☺			
	CCMT09T304-PF	9,525	9,67	3,97	0,4	0,07 - 0,30	0,3 - 3,0	☺	☺	☺		☺	☺						☺	☺			
	CCMT09T308-PF	9,525	9,67	3,97	0,8	0,12 - 0,45	0,3 - 3,0	☺	☺	☺		☺	☺						☺	☺			
	CCGT060201-PF2	6,35	6,45	2,38	0,1	0,02 - 0,06	0,1 - 1,5					☺						☺	☺				
	CCGT060202-PF2	6,35	6,45	2,38	0,2	0,05 - 0,12	0,2 - 2,0					☺						☺	☺				
	CCGT060204-PF2	6,35	6,45	2,38	0,4	0,08 - 0,25	0,2 - 2,5					☺						☺	☺				
	CCGT09T301-PF2	9,525	9,67	3,97	0,1	0,02 - 0,06	0,1 - 1,5					☺						☺	☺				
	CCGT09T302-PF2	9,525	9,67	3,97	0,2	0,05 - 0,12	0,2 - 2,0					☺						☺	☺				
	CCGT09T304-PF2	9,525	9,67	3,97	0,4	0,08 - 0,25	0,2 - 2,5					☺	☺					☺	☺	☺			
	CCGT09T308-PF2	9,525	9,67	3,97	0,8	0,10 - 0,30	0,3 - 3,0					☺	☺					☺	☺	☺			
	CCMT060202-PF4	6,35	6,45	2,38	0,2	0,04 - 0,12	0,1 - 1,0	☺	☺	☺		☺	☺	☺				☺	☺	☺			
	CCMT060204-PF4	6,35	6,45	2,38	0,4	0,05 - 0,16	0,1 - 1,5	☺	☺	☺		☺	☺	☺				☺	☺	☺			
	CCMT060208-PF4	6,35	6,45	2,38	0,8	0,08 - 0,20	0,1 - 2,5	☺	☺	☺		☺	☺	☺				☺	☺	☺			
	CCMT09T302-PF4	9,525	9,67	3,97	0,2	0,04 - 0,12	0,1 - 1,0	☺	☺	☺		☺	☺	☺				☺	☺	☺			
	CCMT09T304-PF4	9,525	9,67	3,97	0,4	0,05 - 0,16	0,1 - 1,5	☺	☺	☺		☺	☺	☺				☺	☺	☺			
	CCMT09T308-PF4	9,525	9,67	3,97	0,8	0,08 - 0,20	0,1 - 2,5	☺	☺	☺		☺	☺	☺				☺	☺	☺			
	CCMT120404-PF4	12,7	12,9	4,76	0,4	0,05 - 0,16	0,1 - 1,5	☺	☺	☺		☺	☺	☺				☺	☺	☺			
	CCMT120408-PF4	12,7	12,9	4,76	0,8	0,08 - 0,20	0,1 - 2,5	☺	☺	☺		☺	☺	☺				☺	☺	☺			
	CCGT060202-PF5	6,35	6,45	2,38	0,2	0,04 - 0,10	0,1 - 0,6			☺	☺									☺			
	CCGT060204-PF5	6,35	6,45	2,38	0,4	0,06 - 0,12	0,2 - 0,6			☺	☺										☺		
	CCGT09T302-PF5	9,525	9,67	3,97	0,2	0,04 - 0,10	0,1 - 1,0			☺	☺										☺		
	CCGT09T304-PF5	9,525	9,67	3,97	0,4	0,06 - 0,12	0,2 - 1,0			☺	☺										☺		

For achievable surface finish qualities and technical information, see page A 298.

 HC = Coated carbide
 HW = Uncoated carbide
 BL = CBN with low CBN content
 BH = CBN with high CBN content

Positive basic shape CCGT / CCMT / CCMW

Tiger-tec®

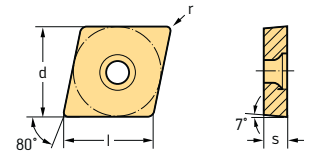

Indexable inserts

Designation	d mm	l mm	s mm	r mm	f mm	ap mm	P				M			K		N		S			H				
							HC				HC			HC		HC	HW	HC			BL	BH			
							WPP01	WPP10	WPP20	WPP30	WSM10	WSM20	WSM30	WAK10	WAK20	WAK30	WXN10	WK1	WSM10	WSM20	WSM30	WCB30	WCB50		
	CCMT060204-PS5	6,35	6,45	2,38	0,4	0,08 - 0,25	0,3 - 1,6	☺	☺			☺	☺	☺	☺						☺	☺			
	CCMT060208-PS5	6,35	6,45	2,38	0,8	0,12 - 0,30	0,5 - 1,6	☺	☺			☺	☺	☺	☺						☺	☺			
	CCMT09T304-PS5	9,525	9,67	3,97	0,4	0,08 - 0,25	0,3 - 2,0	☺	☺			☺	☺	☺	☺						☺	☺			
	CCMT09T308-PS5	9,525	9,67	3,97	0,8	0,12 - 0,32	0,5 - 2,0	☺	☺			☺	☺	☺	☺						☺	☺			
	CCMT120404-PS5	12,7	12,9	4,76	0,4	0,10 - 0,25	0,3 - 2,5	☺	☺			☺	☺	☺	☺						☺	☺			
	CCMT120408-PS5	12,7	12,9	4,76	0,8	0,12 - 0,32	0,5 - 2,5	☺	☺			☺	☺	☺	☺						☺	☺			
	CCMT09T304-PM	9,525	9,67	3,97	0,4	0,12 - 0,40	0,5 - 4,0	☺	☺					☺	☺										
	CCMT09T308-PM	9,525	9,67	3,97	0,8	0,15 - 0,50	0,7 - 4,0	☺	☺					☺	☺										
	CCMT09T312-PM	9,525	9,67	3,97	1,2	0,17 - 0,50	0,7 - 4,0	☺	☺					☺	☺										
	CCMT120404-PM	12,7	12,9	4,76	0,4	0,15 - 0,40	0,5 - 4,0	☺	☺					☺	☺										
	CCMT120408-PM	12,7	12,9	4,76	0,8	0,15 - 0,50	0,7 - 4,0	☺	☺					☺	☺										
	CCMT120412-PM	12,7	12,9	4,76	1,2	0,17 - 0,60	0,7 - 4,0	☺	☺					☺	☺										
	CCGT060201-PM2	6,35	6,45	2,38	0,1	0,02 - 0,06	0,5 - 1,5										☺	☺							
	CCGT060202-PM2	6,35	6,45	2,38	0,2	0,05 - 0,12	0,5 - 2,0										☺	☺							
	CCGT060204-PM2	6,35	6,45	2,38	0,4	0,08 - 0,25	0,6 - 3,0										☺	☺							
	CCGT09T301-PM2	9,525	9,67	3,97	0,1	0,02 - 0,06	0,5 - 1,5											☺	☺						
	CCGT09T302-PM2	9,525	9,67	3,97	0,2	0,05 - 0,12	0,5 - 2,0											☺	☺						
	CCGT09T304-PM2	9,525	9,67	3,97	0,4	0,08 - 0,25	0,6 - 4,0											☺	☺						
	CCGT09T308-PM2	9,525	9,67	3,97	0,8	0,10 - 0,35	0,8 - 4,0											☺	☺						
	CCGT120402-PM2	12,7	12,9	4,76	0,2	0,05 - 0,12	0,5 - 2,0											☺	☺						
	CCGT120404-PM2	12,7	12,9	4,76	0,4	0,08 - 0,25	0,6 - 5,0											☺	☺						
	CCGT120408-PM2	12,7	12,9	4,76	0,8	0,10 - 0,35	0,8 - 5,0											☺	☺						

For achievable surface finish qualities and technical information, see page A 298.

HC = Coated carbide
 HW = Uncoated carbide
 BL = CBN with low CBN content
 BH = CBN with high CBN content

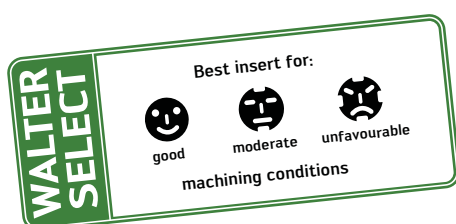

Positive basic shape CCGT / CCMT / CCMW

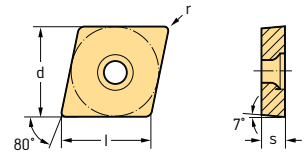
Tiger-tec®

Indexable inserts

Designation	d mm	l mm	s mm	r mm	f mm	ap mm	P			M			K			N		S			H	
							HC			HC			HC			HC	HW	HC			BL	BH
							WPP01	WPP10	WPP20	WPP30	WSM10	WSM20	WSM30	WAK10	WAK20	WAK30	WXN10	WK1	WSM10	WSM20	WSM30	WCB30
CCMT060204-PM5	6,35	6,45	2,38	0,4	0,12 - 0,25	0,4 - 2,5	☺	☺	☺	☺	☺	☺	☺	☺	☺			☺	☺	☺		
CCMT060208-PM5	6,35	6,45	2,38	0,8	0,16 - 0,30	0,6 - 2,5	☺	☺	☺	☺	☺	☺	☺	☺	☺			☺	☺	☺		
CCMT09T304-PM5	9,525	9,67	3,97	0,4	0,12 - 0,25	0,4 - 3,0	☺	☺	☺	☺	☺	☺	☺	☺	☺			☺	☺	☺		
CCMT09T308-PM5	9,525	9,67	3,97	0,8	0,16 - 0,35	0,6 - 4,0	☺	☺	☺	☺	☺	☺	☺	☺	☺			☺	☺	☺		
CCMT120404-PM5	12,7	12,9	4,76	0,4	0,12 - 0,25	0,4 - 3,0	☺	☺	☺	☺	☺	☺	☺	☺	☺			☺	☺	☺		
CCMT120408-PM5	12,7	12,9	4,76	0,8	0,16 - 0,40	0,6 - 5,0	☺	☺	☺	☺	☺	☺	☺	☺	☺			☺	☺	☺		
CCMT120412-PM5	12,7	12,9	4,76	1,2	0,20 - 0,50	0,8 - 5,0	☺	☺	☺	☺	☺	☺	☺	☺	☺			☺	☺	☺		
CCMW060202	6,35	6,45	2,38	0,2	0,08 - 0,12	0,2 - 2,5							☺	☺								
CCMW060204	6,35	6,45	2,38	0,4	0,12 - 0,25	0,4 - 2,5							☺	☺								
CCMW060208	6,35	6,45	2,38	0,8	0,16 - 0,30	0,6 - 2,5							☺	☺								
CCMW09T304	9,525	9,67	3,97	0,4	0,12 - 0,25	0,4 - 3,0							☺	☺								
CCMW09T308	9,525	9,67	3,97	0,8	0,16 - 0,35	0,6 - 4,0							☺	☺								
CCMW120404	12,7	12,1	4,76	0,4	0,12 - 0,25	0,4 - 4,0							☺	☺								
CCMW120408	12,7	12,9	4,76	0,8	0,16 - 0,40	0,6 - 6,0							☺	☺								
CCMW120412	12,7	12,9	4,76	1,2	0,20 - 0,50	0,8 - 6,0							☺	☺								
CCMW060204	6,35	6,45	2,38	0,4	0,05 - 0,20	0,1 - 2,5															☺	☺
CCMW060208	6,35	6,45	2,38	0,8	0,05 - 0,25	0,1 - 2,4															☺	☺
CCMW09T304	9,525	9,67	3,97	0,4	0,05 - 0,20	0,1 - 2,4															☺	☺
CCMW09T308	9,525	9,67	3,97	0,8	0,05 - 0,25	0,1 - 2,3															☺	☺
CCMW060204-2	6,35	6,45	2,38	0,4	0,05 - 0,20	0,1 - 2,5															☺	☺
CCMW060208-2	6,35	6,45	2,38	0,8	0,05 - 0,25	0,1 - 2,4															☺	☺
CCMW09T304-2	9,525	9,67	3,97	0,4	0,05 - 0,20	0,1 - 2,4															☺	☺
CCMW09T308-2	9,525	9,67	3,97	0,8	0,05 - 0,25	0,1 - 2,3															☺	☺

For achievable surface finish qualities and technical information, see page A 298.

HC = Coated carbide
 HW = Uncoated carbide
 BL = CBN with low CBN content
 BH = CBN with high CBN content

Positive basic shape DCGT / DCMT / DCMW

Tiger-tec®

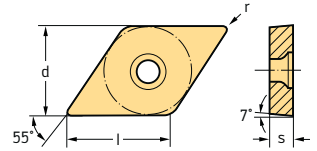

Indexable inserts

Image	Designation	d mm	l mm	s mm	r mm	f mm	ap mm	P				M			K		N		S			H	
								HC				HC			HC	HC	HW	HC			BL	BH	
								WPP01	WPP10	WPP20	WPP30	WSM10	WSM20	WSM30	WAK10	WAK20	WXN10	WK1	WSM10	WSM20	WSM30	WCB30	WCB50
	DCMT070204-PF	6,35	7,75	2,38	0,4	0,05 - 0,25	0,3 - 2,0	☺	☺	☺	☺	☺	☺	☺	☺	☺	☺	☺	☺	☺	☺	☺	☺
	DCMT070208-PF	6,35	7,75	2,38	0,8	0,05 - 0,25	0,3 - 2,0	☺	☺	☺	☺	☺	☺	☺	☺	☺	☺	☺	☺	☺	☺	☺	☺
	DCMT11T304-PF	9,525	11,63	3,97	0,4	0,07 - 0,30	0,3 - 3,0	☺	☺	☺	☺	☺	☺	☺	☺	☺	☺	☺	☺	☺	☺	☺	☺
	DCMT11T308-PF	9,525	11,63	3,97	0,8	0,12 - 0,40	0,3 - 3,0	☺	☺	☺	☺	☺	☺	☺	☺	☺	☺	☺	☺	☺	☺	☺	☺
	DCGT070201-PF2	6,35	7,75	2,38	0,1	0,02 - 0,06	0,1 - 1,5					☺	☺		☺	☺	☺	☺	☺	☺			
	DCGT070202-PF2	6,35	7,75	2,38	0,2	0,05 - 0,12	0,2 - 2,0					☺	☺		☺	☺	☺	☺	☺	☺			
	DCGT070204-PF2	6,35	7,75	2,38	0,4	0,08 - 0,25	0,2 - 2,5					☺	☺		☺	☺	☺	☺	☺	☺			
	DCGT11T301-PF2	9,525	11,6	3,97	0,1	0,02 - 0,06	0,1 - 1,5					☺	☺		☺	☺	☺	☺	☺	☺			
	DCGT11T302-PF2	9,525	11,63	3,97	0,2	0,05 - 0,12	0,2 - 2,0					☺	☺		☺	☺	☺	☺	☺	☺			
	DCGT11T304-PF2	9,525	11,63	3,97	0,4	0,08 - 0,25	0,2 - 2,5					☺	☺		☺	☺	☺	☺	☺	☺			
	DCGT11T308-PF2	9,525	11,63	3,97	0,8	0,10 - 0,30	0,3 - 3,0					☺	☺		☺	☺	☺	☺	☺	☺			
	DCMT070202-PF4	6,35	7,75	2,38	0,2	0,04 - 0,12	0,1 - 1,0	☺	☺	☺		☺	☺	☺				☺	☺	☺			
	DCMT070204-PF4	6,35	7,75	2,38	0,4	0,05 - 0,16	0,1 - 1,5	☺	☺	☺		☺	☺	☺				☺	☺	☺			
	DCMT070208-PF4	6,35	7,75	2,38	0,8	0,08 - 0,20	0,1 - 2,5	☺	☺	☺		☺	☺	☺				☺	☺	☺			
	DCMT11T302-PF4	9,525	11,63	3,97	0,2	0,04 - 0,12	0,1 - 1,0	☺	☺	☺		☺	☺	☺				☺	☺	☺			
	DCMT11T304-PF4	9,525	11,63	3,97	0,4	0,05 - 0,16	0,1 - 1,5	☺	☺	☺		☺	☺	☺				☺	☺	☺			
	DCMT11T308-PF4	9,525	11,63	3,97	0,8	0,08 - 0,20	0,1 - 2,5	☺	☺	☺		☺	☺	☺				☺	☺	☺			
	DCMT070204-PS5	6,35	7,75	2,38	0,4	0,08 - 0,25	0,3 - 1,6		☺	☺		☺	☺	☺	☺				☺	☺			
	DCMT070208-PS5	6,35	7,75	2,38	0,8	0,12 - 0,30	0,6 - 1,6		☺	☺		☺	☺	☺	☺				☺	☺			
	DCMT11T304-PS5	9,525	11,63	3,97	0,4	0,08 - 0,25	0,3 - 2,0		☺	☺		☺	☺	☺	☺				☺	☺			
	DCMT11T308-PS5	9,525	11,63	3,97	0,8	0,12 - 0,32	0,6 - 2,0		☺	☺		☺	☺	☺	☺				☺	☺			
	DCMT11T304-PM	9,525	11,63	3,97	0,4	0,12 - 0,40	0,5 - 4,0		☺	☺		☺	☺	☺	☺				☺	☺			
	DCMT11T308-PM	9,525	11,63	3,97	0,8	0,15 - 0,50	0,5 - 4,0		☺	☺		☺	☺	☺	☺				☺	☺			

For achievable surface finish qualities and technical information, see page A 298.

HC = Coated carbide
 HW = Uncoated carbide
 BL = CBN with low CBN content
 BH = CBN with high CBN content

WALTER SELECT

Best insert for:

☺
good
☺
moderate
☺
unfavourable

machining conditions

Positive basic shape DCGT / DCMT / DCMW

Tiger-tec®

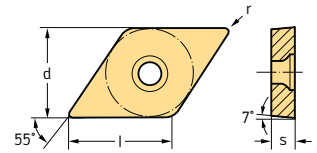

Indexable inserts

Designation	d mm	l mm	s mm	r mm	f mm	ap mm	P			M			K		N		S			H			
							HC	HC	HC	HC	HC	HC	HW	HC	HW	HC	HC	BL	BH				
							WPP01	WPP10	WPP20	WPP30	WSM10	WSM20	WSM30	WAK10	WAK20	WXN10	WK1	WSM10	WSM20	WSM30	WCB30	WCB50	
DCGT070201-PM2	6,35	7,75	2,38	0,1	0,02 - 0,06	0,5 - 1,5										☺	☺						
DCGT070202-PM2	6,35	7,75	2,38	0,2	0,05 - 0,12	0,5 - 2,0										☺	☺						
DCGT070204-PM2	6,35	7,75	2,38	0,4	0,08 - 0,25	0,6 - 2,5										☺	☺						
DCGT11T301-PM2	9,525	11,63	3,97	0,1	0,02 - 0,06	0,5 - 1,5										☺	☺						
DCGT11T302-PM2	9,525	11,63	3,97	0,2	0,05 - 0,12	0,5 - 2,0										☺	☺						
DCGT11T304-PM2	9,525	11,63	3,97	0,4	0,08 - 0,25	0,6 - 3,0										☺	☺						
DCGT11T308-PM2	9,525	11,63	3,97	0,8	0,10 - 0,30	0,8 - 3,5										☺	☺						
DCMT070204-PM5	6,35	7,75	2,38	0,4	0,12 - 0,20	0,4 - 2,0	☺	☺	☺	☺	☺	☺	☺	☺	☺			☺	☺	☺			
DCMT070208-PM5	6,35	7,75	2,38	0,8	0,16 - 0,25	0,6 - 2,0	☺	☺	☺	☺	☺	☺	☺	☺	☺			☺	☺	☺			
DCMT11T304-PM5	9,525	11,63	3,97	0,4	0,12 - 0,25	0,4 - 3,0	☺	☺	☺	☺	☺	☺	☺	☺	☺			☺	☺	☺			
DCMT11T308-PM5	9,525	11,63	3,97	0,8	0,16 - 0,30	0,6 - 4,0	☺	☺	☺	☺	☺	☺	☺	☺	☺			☺	☺	☺			
DCMT11T312-PM5	9,525	11,63	3,97	1,2	0,20 - 0,35	0,8 - 4,0	☺	☺	☺		☺	☺	☺	☺	☺				☺	☺			
DCMW11T304	9,525	11,63	3,97	0,4	0,12 - 0,25	0,4 - 3,0								☺	☺								
DCMW11T308	9,525	11,63	3,97	0,8	0,16 - 0,30	0,6 - 4,0								☺	☺								
DCMW11T302	9,525	11,63	3,97	0,2	0,05 - 0,15	0,1 - 2,6																☺	☺
DCMW11T304	9,525	11,63	3,97	0,4	0,05 - 0,20	0,1 - 2,5																☺	☺
DCMW11T308	9,525	11,63	3,97	0,8	0,05 - 0,25	0,1 - 2,1																☺	☺
DCMW11T304-2	9,525	11,63	3,97	0,4	0,05 - 0,20	0,1 - 2,5																☺	☺
DCMW11T308-2	9,525	11,63	3,97	0,8	0,05 - 0,25	0,1 - 2,1																☺	☺

For achievable surface finish qualities and technical information, see page A 298.

HC = Coated carbide
 HW = Uncoated carbide
 BL = CBN with low CBN content
 BH = CBN with high CBN content

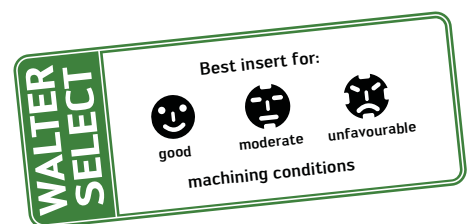

Positive basic shape RCGT / RCMT / RCMX

Tiger-tec®

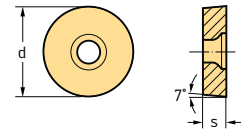

Indexable inserts

Designation	d mm	s mm	r mm	f mm	ap mm	P				M		K		N		S		
						HC				HC		HC		HC	HW	HC		HW
						WPP01	WPP10	WPP20	WPP30	WSM10	WSM20	WSM30	WAK10	WAK20	WXN10	WK1	WSM10	WSM20
RCGT0602M0-PF2	6	2,38	3	0,06 - 0,25	0,2 - 2,0									☺	☺			
RCGT0803M0-PF2	8	3,18	4	0,08 - 0,30	0,3 - 3,0									☺	☺			
RCGT10T3M0-PF2	10	3,97	5	0,10 - 0,40	0,3 - 4,0									☺	☺			
RCGT1204M0-PF2	12	4,76	6	0,12 - 0,40	0,4 - 4,5									☺	☺			
RCMT0602M0-PF4	6	2,38	3	0,07 - 0,30	0,6 - 2,5		☺	☺		☺	☺					☺	☺	
RCMT0803M0-PF4	8	3,18	4	0,08 - 0,30	0,8 - 3,0		☺	☺		☺	☺					☺	☺	
RCMT10T3M0-PF4	10	3,97	5	0,10 - 0,35	1,0 - 4,0		☺	☺		☺	☺					☺	☺	
RCMT1204M0-PF4	12	4,76	6	0,12 - 0,40	1,2 - 5,0		☺	☺		☺	☺					☺	☺	
RCGT0502M0-PF5	5	2,38	2,5	0,07 - 0,25	0,6 - 2,5												☺	
RCGT0602M0-PF5	6	2,38	3	0,07 - 0,25	0,6 - 2,5			☺	☺		☺						☺	
RCGT0803M0-PF5	8	3,18	4	0,08 - 0,30	0,8 - 3,0			☺	☺		☺						☺	
RCGT10T3M0-PF5	10	3,97	5	0,10 - 0,35	1,0 - 4,0			☺	☺		☺						☺	
RCGT1204M0-PF5	12	4,76	6	0,12 - 0,40	1,2 - 5,0												☺	
RCGT0602M0-PM2	6	2,38	3	0,10 - 0,55	0,6 - 2,5									☺	☺			
RCGT0803M0-PM2	8	3,18	4	0,12 - 0,60	0,7 - 3,0									☺	☺			
RCGT10T3M0-PM2	10	3,97	5	0,15 - 0,70	0,8 - 4,0									☺	☺			
RCGT1204M0-PM2	12	4,76	6	0,18 - 0,80	1,0 - 5,0									☺	☺			
RCMT10T3M0T	10	3,97	5	0,12 - 0,80	1,0 - 4,0			☺	☺									
RCMT1204M0T	12	4,76	6	0,12 - 1,00	1,2 - 5,0			☺	☺									
RCMT1605M0T	16	5,56	8	0,15 - 1,10	1,6 - 7,0			☺	☺									
RCMT1606M0T	16	6,35	8	0,15 - 1,10	1,6 - 7,0			☺	☺									
RCMT2006M0T	20	6,35	10	0,20 - 1,20	2,0 - 9,0			☺	☺									
RCMT2507M0T	25	7,94	12,5	0,20 - 1,30	2,5 - 11,0			☺	☺									
RCMT0602M0-PM5	6	2,38	3	0,08 - 0,50	0,6 - 2,5		☺	☺	☺	☺	☺	☺	☺			☺	☺	
RCMT0803M0-PM5	8	3,18	4	0,10 - 0,60	0,8 - 3,0		☺	☺	☺	☺	☺	☺	☺			☺	☺	
RCMT10T3M0-PM5	10	3,97	5	0,12 - 0,80	1,0 - 4,0		☺	☺	☺	☺	☺	☺	☺			☺	☺	
RCMT1204M0-PM5	12	4,76	6	0,12 - 1,00	1,2 - 5,0		☺	☺	☺	☺	☺	☺	☺			☺	☺	
RCMT1605M0-PM5	16	5,56	8	0,15 - 1,20	1,6 - 7,0		☺	☺	☺	☺	☺	☺	☺			☺	☺	
RCMT1606M0-PM5	16	6,35	8	0,15 - 1,20	1,6 - 7,0		☺	☺	☺	☺	☺	☺	☺			☺	☺	

For achievable surface finish qualities and technical information, see page A 298.

HC = Coated carbide
HW = Uncoated carbide

Positive basic shape RCGT / RCMT / RCMX

Tiger-tec®

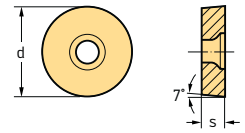

Indexable inserts

Designation	d mm	s mm	r mm	f mm	ap mm	P				M			K		N		S			
						HC				HC			HC		HC	HW	HC		HW	
						WPP01	WPP10	WPP20	WPP30	WSM10	WSM20	WSM30	WAK10	WAK20	WXN10	WK1	WSM10	WSM20	WSM30	WS10
 RCMX100300-PR5	10	3,18	5	0,20 - 1,00	1,0 - 4,0			☺	☹											
RCMX120400-PR5	12	4,76	6	0,20 - 1,20	1,2 - 5,0			☺	☹											
RCMX160600-PR5	16	6,35	8	0,20 - 1,30	1,6 - 7,0		☺	☹	☹											
RCMX200600-PR5	20	6,35	10	0,25 - 1,40	2,0 - 9,0		☺	☹	☹											
RCMX250700-PR5	25	7,94	12,5	0,30 - 1,60	2,5 - 11,0		☺	☹	☹											
RCMX320900-PR5	32	9,52	16	0,30 - 1,70	3,2 - 15,0		☺	☹	☹											

For achievable surface finish qualities and technical information, see page A 298.

HC = Coated carbide
HW = Uncoated carbide

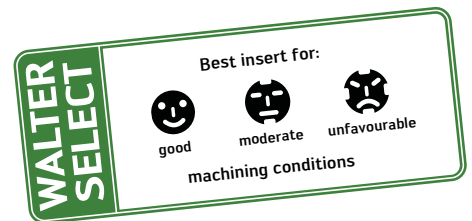

Positive basic shape SCGT / SCMT / SCMW

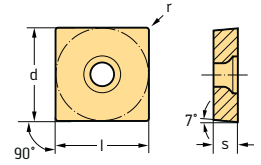

Indexable inserts

Designation	d mm	l mm	s mm	r mm	f mm	ap mm	P				M			K		N		S			
							HC				HC			HC		HC	HW	HC			
							WPP01	WPP10	WPP20	WPP30	WSM10	WSM20	WSM30	WAK10	WAK20	WAK30	WXN10	WK1	WSM10	WSM20	WSM30
SCGT09T304-PF2	9,525	9,525	3,97	0,4	0,08 - 0,25	0,2 - 2,5															
SCGT09T308-PF2	9,525	9,525	3,97	0,8	0,10 - 0,30	0,3 - 3,0															
SCGT120408-PF2	12,7	12,7	4,76	0,8	0,10 - 0,30	0,3 - 3,0															
SCMT09T304-PF4	9,525	9,525	3,97	0,4	0,05 - 0,15	0,1 - 1,5															
SCMT09T308-PF4	9,525	9,525	3,97	0,8	0,05 - 0,18	0,1 - 1,8															
SCMT120404-PF4	12,7	12,7	4,76	0,4	0,05 - 0,15	0,1 - 1,5															
SCMT120408-PF4	12,7	12,7	4,76	0,8	0,05 - 0,18	0,1 - 1,8															
SCMT120412-PF4	12,7	12,7	4,91	1,2	0,12 - 0,32	0,3 - 1,8															
SCMT09T304-PS5	9,525	9,525	3,97	0,4	0,08 - 0,25	0,3 - 2,0															
SCMT09T308-PS5	9,525	9,52	3,97	0,8	0,12 - 0,30	0,5 - 2,0															
SCMT120408-PS5	12,7	12,7	4,76	0,8	0,12 - 0,32	0,5 - 2,5															
SCGT09T304-PM2	9,525	9,525	3,97	0,4	0,08 - 0,25	0,6 - 4,0															
SCGT09T308-PM2	9,525	9,525	3,97	0,8	0,10 - 0,35	0,7 - 4,0															
SCGT120408-PM2	12,7	12,7	4,76	0,8	0,10 - 0,40	0,8 - 6,0															
SCMT09T304-PM5	9,525	9,525	3,97	0,4	0,12 - 0,25	0,4 - 3,0															
SCMT09T308-PM5	9,525	9,525	3,97	0,8	0,16 - 0,35	0,6 - 4,0															
SCMT120404-PM5	12,7	12,7	4,76	0,4	0,12 - 0,25	0,4 - 3,0															
SCMT120408-PM5	12,7	12,7	4,76	0,8	0,16 - 0,40	0,6 - 5,0															
SCMT120412-PM5	12,7	12,7	4,76	1,2	0,20 - 0,50	0,8 - 5,0															
SCMW09T304	9,525	9,525	3,97	0,4	0,12 - 0,25	0,4 - 3,0															
SCMW09T308	9,525	9,525	3,97	0,8	0,16 - 0,35	0,6 - 4,0															
SCMW120404	12,7	12,7	4,76	0,4	0,12 - 0,25	0,4 - 4,0															
SCMW120408	12,7	12,7	4,76	0,8	0,16 - 0,40	0,6 - 5,0															
SCMW120412	12,7	12,7	4,76	1,2	0,16 - 0,40	0,8 - 5,0															

For achievable surface finish qualities and technical information, see page A 298.

HC = Coated carbide
HW = Uncoated carbide

Positive basic shape TCGT / TCMT / TCMW

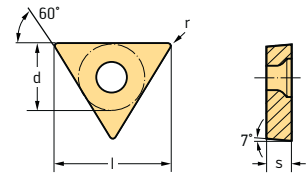
Tiger-tec®

Indexable inserts

Designation	d mm	l mm	s mm	r mm	f mm	ap mm	P			M			K			N		S		H					
							HC	HC	HC	HC	HC	HC	HW	HC	HW	HC	BL	BH							
							WPP01	WPP10	WPP20	WPP30	WSM10	WSM20	WSM21	WSM30	WAK10	WAK20	WAK30	WXN10	WK1	WSM10	WSM20	WSM30	WCB30	WCB50	
TCGT06T101-PF2	3,97	6,9	1,98	0,1	0,02 - 0,06	0,1 - 1,5												☺	☺						
TCGT06T102-PF2	3,97	6,9	1,98	0,2	0,05 - 0,12	0,2 - 2,0												☺	☺						
TCGT06T104-PF2	3,97	6,9	1,98	0,4	0,08 - 0,25	0,2 - 2,5												☺	☺						
TCGT090201-PF2	5,56	9	2,38	0,1	0,02 - 0,06	0,1 - 1,5												☺	☺		☺				
TCGT090202-PF2	5,56	9	2,38	0,2	0,05 - 0,12	0,2 - 2,0												☺	☺		☺				
TCGT090204-PF2	5,56	9	2,38	0,4	0,08 - 0,25	0,2 - 2,5												☺	☺		☺				
TCGT110201-PF2	6,35	11	2,38	0,1	0,02 - 0,06	0,1 - 1,5												☺	☺		☺				
TCGT110202-PF2	6,35	11	2,38	0,2	0,05 - 0,12	0,2 - 2,0												☺	☺		☺				
TCGT110204-PF2	6,35	11	2,38	0,4	0,08 - 0,25	0,2 - 2,5												☺	☺		☺				
TCGT16T301-PF2	9,525	16,5	3,97	0,1	0,02 - 0,06	0,1 - 1,5												☺	☺		☺				
TCGT16T302-PF2	9,525	16,5	3,97	0,2	0,05 - 0,12	0,2 - 2,0												☺	☺		☺				
TCGT16T304-PF2	9,525	16,5	3,97	0,4	0,08 - 0,25	0,2 - 2,5												☺	☺		☺				
TCGT16T308-PF2	9,525	16,5	3,97	0,8	0,10 - 0,30	0,3 - 3,0												☺	☺		☺				
TCMT06T102-PF4	3,97	6,9	1,98	0,2	0,02 - 0,10	0,1 - 1,0			☺																
TCMT06T104-PF4	3,97	6,9	1,98	0,4	0,04 - 0,17	0,1 - 1,0			☺																
TCMT090202-PF4	5,56	9	2,38	0,2	0,04 - 0,12	0,1 - 1,0	☺	☺	☺		☺	☺									☺	☺	☺		
TCMT090204-PF4	5,56	9	2,38	0,4	0,05 - 0,16	0,1 - 1,5	☺	☺	☺		☺	☺									☺	☺	☺		
TCMT090208-PF4	5,56	9	2,38	0,8	0,08 - 0,20	0,1 - 2,5	☺	☺	☺		☺	☺									☺	☺	☺		
TCMT110202-PF4	6,35	11	2,38	0,2	0,04 - 0,12	0,1 - 1,0	☺	☺	☺		☺	☺									☺	☺	☺		
TCMT110204-PF4	6,35	11	2,38	0,4	0,05 - 0,16	0,1 - 1,5	☺	☺	☺		☺	☺									☺	☺	☺		
TCMT110208-PF4	6,35	11	2,38	0,8	0,08 - 0,20	0,1 - 2,5	☺	☺	☺		☺	☺									☺	☺	☺		
TCMT16T302-PF4	9,525	16,5	3,97	0,2	0,04 - 0,12	0,1 - 1,0	☺	☺	☺		☺	☺									☺	☺	☺		
TCMT16T304-PF4	9,525	16,5	3,97	0,4	0,05 - 0,16	0,1 - 1,5	☺	☺	☺		☺	☺									☺	☺	☺		
TCMT16T308-PF4	9,525	16,5	3,97	0,8	0,08 - 0,20	0,1 - 2,5	☺	☺	☺		☺	☺									☺	☺	☺		
TCMT110204-PS5	6,35	11	2,38	0,4	0,08 - 0,25	0,3 - 1,6			☺													☺	☺		
TCMT110208-PS5	6,35	11	2,38	0,8	0,12 - 0,30	0,5 - 1,6			☺													☺	☺		
TCMT16T304-PS5	9,525	16,5	3,97	0,4	0,08 - 0,25	0,3 - 2,0			☺													☺	☺		
TCMT16T308-PS5	9,525	16,5	3,97	0,8	0,12 - 0,32	0,5 - 2,5			☺													☺	☺		

For achievable surface finish qualities and technical information, see page A 298.



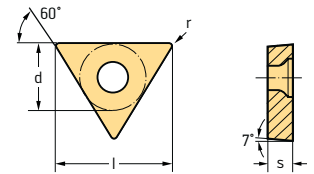

HC = Coated carbide
 HW = Uncoated carbide
 BL = CBN with low CBN content
 BH = CBN with high CBN content

Positive basic shape TCGT / TCMT / TCMW

Tiger-tec®



Indexable inserts

Designation	d mm	l mm	s mm	r mm	f mm	ap mm	P			M			K		N		S			H	
							HC			HC			HC		HC	HW	HC			BL	BH
							WPP01	WPP10	WPP20	WPP30	WSM10	WSM20	WSM21	WSM30	WAK10	WAK20	WAK30	WXN10	WK1	WSM10	WSM20
 TCGT110201-PM2	6,35	11	2,38	0,1	0,02 - 0,06	0,5 - 1,5										☺	☺				
TCGT110202-PM2	6,35	11	2,38	0,2	0,05 - 0,12	0,6 - 2,0										☺	☺				
TCGT110204-PM2	6,35	11	2,38	0,4	0,08 - 0,25	0,6 - 3,0										☺	☺				
TCGT16T302-PM2	9,525	16,5	3,97	0,2	0,05 - 0,12	0,5 - 2,0										☺	☺				
TCGT16T304-PM2	9,525	16,5	3,97	0,4	0,08 - 0,25	0,6 - 4,0										☺	☺				
TCGT16T308-PM2	9,525	16,5	3,97	0,8	0,10 - 0,35	0,8 - 4,0										☺	☺				
 TCMT090204-PM5	5,56	9	2,38	0,4	0,12 - 0,25	0,4 - 3,0		☺	☺	☺		☺	☺						☺	☺	
TCMT090208-PM5	5,56	9	2,38	0,8	0,16 - 0,30	0,6 - 3,0		☺	☺	☺		☺	☺						☺	☺	
TCMT110204-PM5	6,35	11	2,38	0,4	0,12 - 0,25	0,4 - 3,0		☺	☺	☺	☺	☺	☺					☺	☺	☺	
TCMT110208-PM5	6,35	11	2,38	0,8	0,16 - 0,30	0,6 - 3,0		☺	☺	☺	☺	☺	☺					☺	☺	☺	
TCMT16T304-PM5	9,525	16	3,97	0,4	0,12 - 0,25	0,4 - 3,0		☺	☺	☺	☺	☺	☺					☺	☺	☺	
TCMT16T308-PM5	9,525	16,5	3,97	0,8	0,16 - 0,30	0,6 - 4,0		☺	☺	☺	☺	☺	☺					☺	☺	☺	
TCMT16T312-PM5	9,525	16,5	3,97	1,2	0,20 - 0,40	0,8 - 4,0		☺	☺	☺	☺	☺	☺					☺	☺	☺	
 TCMW110202	6,35	11	2,38	0,2	0,08 - 0,12	0,2 - 3,0										☺	☺				
TCMW110204	6,35	11	2,38	0,4	0,12 - 0,25	0,4 - 3,0										☺	☺				
TCMW110208	6,35	11	2,38	0,8	0,16 - 0,30	0,6 - 3,0										☺	☺				
TCMW16T304	9,525	16,5	3,97	0,4	0,12 - 0,25	0,4 - 3,0										☺	☺				
TCMW16T308	9,525	16,5	3,97	0,8	0,16 - 0,30	0,6 - 4,0										☺	☺				
TCMW16T312	9,525	16,5	3,97	1,2	0,20 - 0,40	0,8 - 4,0										☺	☺				
 TCMW110204	6,35	11	2,38	0,4	0,05 - 0,20	0,1 - 2,2														☺	☺
TCMW110208	6,35	11	2,38	0,8	0,05 - 0,25	0,1 - 1,9														☺	☺

For achievable surface finish qualities and technical information, see page A 298.

HC = Coated carbide
 HW = Uncoated carbide
 BL = CBN with low CBN content
 BH = CBN with high CBN content

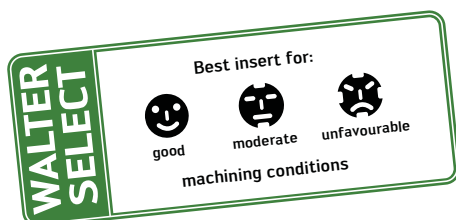

Positive basic shape VBGT / VBMT / VCGT / VCMT / VCMW / VBMW

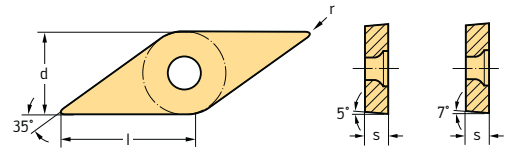
Tiger-tec®

Indexable inserts

Designation	d mm	l mm	s mm	r mm	f mm	ap mm	P			M			K	N		S			H					
							HC			HC			HC	HC	HW	HC			BL	BH				
							WPP01	WPP10	WPP20	WPP30	WSM10	WSM20	WSM30	WAK10	WAK20	WXN10	WK1	WSM10	WSM20	WSM30	WCB30	WCB50		
	VC GT110301-PF2	6,35	11	3,18	0,1	0,02 - 0,06					☺					☺	☺	☺						
	VC GT110302-PF2	6,35	11	3,18	0,2	0,05 - 0,12					☺					☺	☺	☺						
	VC GT110304-PF2	6,35	11	3,18	0,4	0,08 - 0,25					☺	☺				☺	☺	☺	☺	☺				
	VC GT160402-PF2	9,525	16,6	4,76	0,2	0,05 - 0,12					☺					☺	☺	☺	☺					
	VC GT160404-PF2	9,525	16,6	4,76	0,4	0,08 - 0,25					☺	☺				☺	☺	☺	☺	☺				
	VC GT160408-PF2	9,525	16,6	4,76	0,8	0,10 - 0,30					☺	☺				☺	☺	☺	☺	☺				
	VC MT110302-PF4	6,35	11	3,18	0,2	0,04 - 0,12	☺	☺	☺		☺	☺	☺					☺	☺	☺	☺			
	VC MT110304-PF4	6,35	11	3,18	0,4	0,05 - 0,16	☺	☺	☺		☺	☺	☺					☺	☺	☺	☺			
	VC MT160402-PF4	9,525	16,6	4,76	0,2	0,04 - 0,12	☺	☺	☺		☺	☺	☺					☺	☺	☺	☺			
	VC MT160404-PF4	9,525	16,6	4,76	0,4	0,05 - 0,16	☺	☺	☺		☺	☺	☺					☺	☺	☺	☺			
	VC MT160408-PF4	9,525	16,6	4,76	0,8	0,08 - 0,20	☺	☺	☺		☺	☺	☺					☺	☺	☺	☺			
	VB GT110302-PF5	6,35	11	3,18	0,2	0,04 - 0,10			☺	☺			☺								☺			
	VB GT110304-PF5	6,35	11	3,18	0,4	0,06 - 0,12			☺	☺			☺									☺		
	VB MT110304-PS5	6,35	11	3,18	0,4	0,08 - 0,20	☺	☺			☺	☺	☺	☺					☺	☺	☺			
	VB MT110308-PS5	6,35	11	3,18	0,8	0,12 - 0,30	☺	☺			☺	☺	☺	☺					☺	☺	☺			
	VB MT160404-PS5	9,525	16,6	4,76	0,4	0,08 - 0,25	☺	☺			☺	☺	☺	☺					☺	☺	☺			
	VB MT160406-PS5	9,525	16,6	4,76	0,6	0,12 - 0,30	☺	☺			☺	☺	☺	☺					☺	☺	☺			
	VB MT160408-PS5	9,525	16,6	4,76	0,8	0,12 - 0,30	☺	☺			☺	☺	☺	☺					☺	☺	☺			
	VB MT160412-PS5	9,525	16,6	4,76	1,2	0,15 - 0,30	☺	☺			☺	☺	☺	☺					☺	☺	☺			

For achievable surface finish qualities and technical information, see page A 298.

HC = Coated carbide
 HW = Uncoated carbide
 BL = CBN with low CBN content
 BH = CBN with high CBN content

Positive basic shape VBGT / VBMT / VCGT / VCMT / VCMW / VBMW

Tiger-tec®

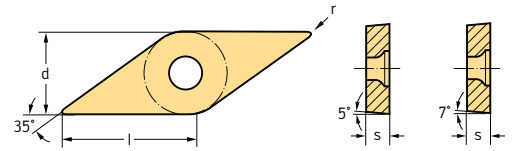

Indexable inserts

Designation	d mm	l mm	s mm	r mm	f mm	ap mm	P			M			K		N		S			H	
							WPP01	WPP10	WPP20	WPP30	WSM10	WSM20	WSM30	WAK10	WAK20	WCN10	WK1	WSM10	WSM20	WSM30	WCB30
VCGT110301-PM2	6,35	11	3,18	0,1	0,02 - 0,06	0,5 - 1,5										☺	☺				
VCMT110302-PM2	6,35	11	3,18	0,2	0,05 - 0,12	0,5 - 2,0										☺	☺				
VCMT110304-PM2	6,35	11	3,18	0,4	0,08 - 0,25	0,6 - 2,5										☺	☺				
VCMT110308-PM2	6,35	11	3,18	0,8	0,10 - 0,35	0,8 - 3,0										☺	☺				
VCMT130301-PM2	7,94	13,1	3,18	0,1	0,02 - 0,06	0,5 - 1,5										☺	☺				
VCMT130302-PM2	7,94	13,1	3,18	0,2	0,05 - 0,12	0,5 - 2,0										☺	☺				
VCMT130304-PM2	7,94	13,1	3,18	0,4	0,08 - 0,25	0,6 - 3,0										☺	☺				
VCMT160404-PM2	9,525	16,6	4,76	0,4	0,08 - 0,25	0,6 - 3,5										☺	☺				
VCMT160408-PM2	9,525	16,6	4,76	0,8	0,10 - 0,35	0,8 - 3,5										☺	☺				
VCMT160412-PM2	9,525	16,6	4,76	1,2	0,10 - 0,45	1,0 - 3,5										☺	☺				
VCMT110304-PM5	6,35	11	3,18	0,4	0,12 - 0,20	0,4 - 2,5	☺	☺	☺	☺	☺	☺	☺	☺			☺	☺	☺		
VCMT110308-PM5	6,35	11	3,18	0,8	0,16 - 0,25	0,6 - 3,0	☺	☺	☺	☺	☺	☺	☺	☺			☺	☺	☺		
VCMT160404-PM5	9,525	16,6	4,76	0,4	0,12 - 0,25	0,4 - 2,5	☺	☺	☺	☺	☺	☺	☺	☺			☺	☺	☺		
VCMT160406-PM5	9,525	16,6	4,76	0,6	0,15 - 0,25	0,6 - 3,0	☺	☺	☺	☺	☺	☺	☺	☺			☺	☺	☺		
VCMT160408-PM5	9,525	16,6	4,76	0,8	0,16 - 0,30	0,6 - 3,0	☺	☺	☺	☺	☺	☺	☺	☺			☺	☺	☺		
VCMT160412-PM5	9,525	16,6	4,76	1,2	0,20 - 0,35	0,8 - 4,0	☺	☺	☺	☺	☺	☺	☺	☺			☺	☺	☺		
VCMW160404	9,525	16,6	4,76	0,4	0,12 - 0,25	0,4 - 2,5							☺	☺							
VCMW160408	9,525	16,6	4,76	0,8	0,16 - 0,30	0,6 - 3,0							☺	☺							
VCMW160412	9,525	16,6	4,76	1,2	0,20 - 0,25	0,8 - 4,0							☺	☺							
VBMW160402	9,525	16,6	4,76	0,2	0,05 - 0,15	0,1 - 3,8														☺	☺
VBMW160404	9,525	16,6	4,76	0,4	0,05 - 0,20	0,1 - 3,3														☺	☺
VBMW160408	9,525	16,6	4,76	0,8	0,05 - 0,25	0,1 - 2,5														☺	☺
VBMW160404-2	9,525	16,6	4,76	0,4	0,05 - 0,20	0,1 - 3,3														☺	☺
VBMW160408-2	9,525	16,6	4,76	0,8	0,05 - 0,25	0,1 - 2,5														☺	☺

For achievable surface finish qualities and technical information, see page A 298.

HC = Coated carbide
 HW = Uncoated carbide
 BL = CBN with low CBN content
 BH = CBN with high CBN content

WALTER SELECT

Best insert for:

☺
good

☹
moderate



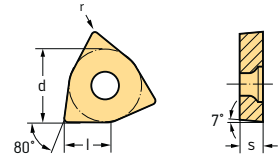

☹☹
unfavourable

machining conditions

Positive basic shape WCGT / WCMT

Tiger-tec®

Indexable inserts

Designation	d mm	l mm	s mm	r mm	f mm	ap mm	P				M			K		N		S		
							HC				HC			HC	HC	HW	HC			
							WPP01	WPP10	WPP20	WPP30	WSM10	WSM20	WSM21	WSM30	WAK10	WAK20	WXN10	WK1	WSM10	WSM20
 Wiper	WCMT040204-PF	6,35	4,3	2,38	0,4	0,05 - 0,30	0,3 - 1,5	☒	☒	☒	☒	☒	☒					☒	☒	
	WCMT040208-PF	6,35	4,3	2,38	0,8	0,05 - 0,30	0,3 - 1,5	☒	☒	☒	☒	☒	☒					☒	☒	
	WCMT06T304-PF	9,525	6,5	3,97	0,4	0,07 - 0,30	0,3 - 2,0	☒	☒	☒	☒	☒	☒					☒	☒	
	WCMT06T308-PF	9,525	6,5	3,97	0,8	0,07 - 0,35	0,3 - 2,0	☒	☒	☒	☒	☒	☒					☒	☒	
	WCGT030201-PF2	5,56	3,8	2,38	0,1	0,02 - 0,06	0,1 - 1,5										☒	☒		
	WCGT030202-PF2	5,56	3,8	2,38	0,2	0,05 - 0,12	0,2 - 2,0				☒						☒	☒		
	WCGT030204-PF2	5,56	3,8	2,38	0,4	0,08 - 0,25	0,2 - 2,5				☒						☒	☒		
	WCGT040201-PF2	6,35	4,3	2,38	0,1	0,02 - 0,06	0,1 - 1,5										☒	☒		
	WCGT040202-PF2	6,35	4,3	2,38	0,2	0,05 - 0,12	0,2 - 2,0				☒						☒	☒		
	WCGT040204-PF2	6,35	4,3	2,38	0,4	0,08 - 0,25	0,2 - 2,5				☒						☒	☒		
	WCGT06T301-PF2	9,525	6,5	3,97	0,1	0,02 - 0,06	0,1 - 1,5										☒	☒		
	WCGT06T302-PF2	9,525	6,5	3,97	0,2	0,05 - 0,12	0,2 - 2,0										☒	☒		
	WCGT06T304-PF2	9,525	6,5	3,97	0,4	0,08 - 0,25	0,2 - 2,5										☒	☒		
	WCGT06T308-PF2	9,525	6,5	3,97	0,8	0,10 - 0,30	0,3 - 3,0										☒	☒		
	WCMT040202-PF4	6,35	4,3	2,38	0,2	0,04 - 0,12	0,1 - 1,0	☒	☒		☒	☒						☒	☒	
	WCMT040204-PF4	6,35	4,3	2,38	0,4	0,05 - 0,16	0,1 - 1,5	☒	☒		☒	☒						☒	☒	
	WCMT040208-PF4	6,35	4,3	2,38	0,8	0,08 - 0,20	0,1 - 2,5	☒	☒		☒	☒						☒	☒	
	WCMT06T302-PF4	9,525	6,5	3,97	0,2	0,04 - 0,12	0,1 - 1,0	☒	☒		☒	☒						☒	☒	
	WCMT06T304-PF4	9,525	6,5	3,97	0,4	0,05 - 0,16	0,1 - 1,5	☒	☒		☒	☒						☒	☒	
	WCMT06T308-PF4	9,525	6,5	3,97	0,8	0,08 - 0,20	0,1 - 2,5	☒	☒		☒	☒						☒	☒	
	WCMT080404-PF4	12,7	8,7	4,76	0,4	0,05 - 0,16	0,1 - 1,5	☒	☒		☒	☒						☒	☒	
	WCMT080408-PF4	12,7	8,7	4,76	0,8	0,08 - 0,20	0,1 - 2,5	☒	☒		☒	☒						☒	☒	
	WCMT040204-PS5	6,35	4,3	2,38	0,4	0,08 - 0,25	0,3 - 1,6		☒					☒	☒					
	WCMT040208-PS5	6,35	4,3	2,38	0,8	0,12 - 0,30	0,5 - 1,6		☒					☒	☒					
	WCMT06T304-PS5	9,525	6,5	3,97	0,4	0,08 - 0,25	0,3 - 2,0		☒					☒	☒					
	WCMT06T308-PS5	9,525	6,5	3,97	0,8	0,12 - 0,32	0,5 - 2,0		☒					☒	☒					
	WCMT080404-PS5	12,7	8,7	4,76	0,4	0,08 - 0,25	0,3 - 2,5		☒					☒	☒					
	WCMT080408-PS5	12,7	8,7	4,76	0,8	0,12 - 0,32	0,5 - 2,5		☒					☒	☒					

For achievable surface finish qualities and technical information, see page A 298.



 HC = Coated carbide
 HW = Uncoated carbide

Positive basic shape
WCGT / WCMT

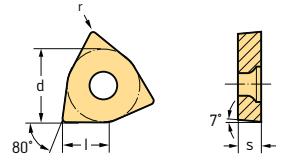
Tiger-tec®

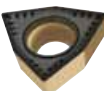

Indexable inserts

Designation	d mm	l mm	s mm	r mm	f mm	ap mm	P			M			K		N		S			
							HC			HC			HC		HC	HW	HC			
							WPP01	WPP10	WPP20	WPP30	WSM10	WSM20	WSM21	WSM30	WAK10	WAK20	WXN10	WK1	WSM10	WSM20
 Wiper WCMT06T304-PM WCMT06T308-PM	9,525	6,5	3,97	0,4	0,12 - 0,35	0,5 - 2,5	☺	☺	☺					☺	☺					
	9,525	6,5	3,97	0,8	0,12 - 0,35	0,5 - 2,5	☺	☺	☺					☺	☺					
 WCGT030202-PM2 WCGT030204-PM2 WCGT040202-PM2 WCGT040204-PM2 WCGT06T302-PM2 WCGT06T304-PM2 WCGT080404-PM2 WCGT080408-PM2	5,56	3,8	2,38	0,2	0,05 - 0,12	0,5 - 1,5										☺	☺			
	5,56	3,8	2,38	0,4	0,08 - 0,20	0,6 - 1,5										☺	☺			
	6,35	4,3	2,38	0,2	0,05 - 0,12	0,5 - 2,0										☺	☺			
	6,35	4,3	2,38	0,4	0,08 - 0,25	0,6 - 2,5										☺	☺			
	9,525	6,5	3,97	0,2	0,05 - 0,12	0,6 - 2,0										☺	☺			
	9,525	6,5	3,97	0,4	0,08 - 0,25	0,6 - 3,0										☺	☺			
	12,7	8,7	4,76	0,4	0,08 - 0,25	0,6 - 4,0										☺	☺			
	12,7	8,7	4,76	0,8	0,10 - 0,35	0,8 - 4,0										☺	☺			
 WCMT030202-PM5 WCMT040202-PM5 WCMT040204-PM5 WCMT06T304-PM5 WCMT06T308-PM5 WCMT080404-PM5 WCMT080408-PM5 WCMT080412-PM5	5,56	3,8	2,38	0,2	0,08 - 0,12	0,2 - 1,5	☺	☺	☺	☺	☺	☺	☺					☺	☺	
	6,35	4,3	2,38	0,2	0,08 - 0,12	0,4 - 2,0	☺	☺	☺	☺	☺	☺	☺					☺	☺	
	6,35	4,3	2,38	0,4	0,12 - 0,25	0,4 - 2,5	☺	☺	☺	☺	☺	☺	☺					☺	☺	
	9,525	6,5	3,97	0,4	0,12 - 0,25	0,4 - 3,0	☺	☺	☺	☺	☺	☺	☺					☺	☺	
	9,525	6,5	3,97	0,8	0,16 - 0,35	0,6 - 4,0	☺	☺	☺	☺	☺	☺	☺					☺	☺	
	12,7	8,7	4,76	0,4	0,12 - 0,25	0,4 - 3,0	☺	☺	☺	☺	☺	☺	☺					☺	☺	
	12,7	8,7	4,76	0,8	0,16 - 0,40	0,6 - 4,0	☺	☺	☺	☺	☺	☺	☺					☺	☺	
	12,7	8,7	4,76	1,2	0,20 - 0,55	0,8 - 5,0	☺	☺	☺	☺	☺	☺	☺					☺	☺	

For achievable surface finish qualities and technical information, see page A 298.

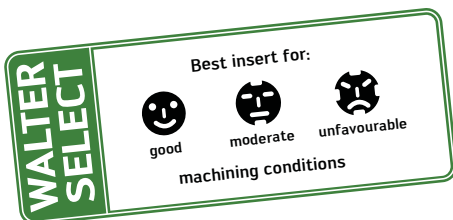

HC = Coated carbide
HW = Uncoated carbide



Designation key for inserts



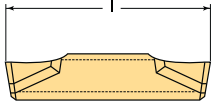

Example

GX 24	—	2 E 300 N 030	—	U F 4
1		3 4 5 6 7		8 9 10

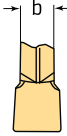
1
Insert type
GX 
LX 
FX 

2
Insert length l [mm]

09 l = 9
16 l = 16
24 l = 24

3
Width category

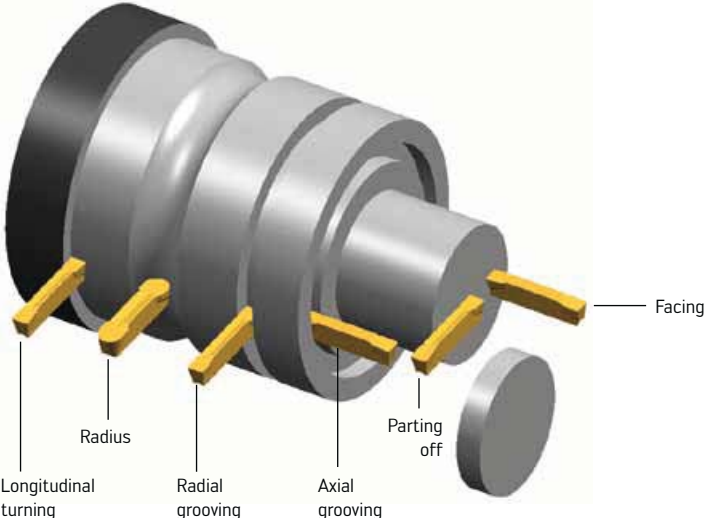
0
1
2
3
4
5

4
Basic shape
E 
F 
R 
S 

8	
Application	
<p>C "Cut off"</p> <ul style="list-style-type: none"> – Parting off – Radial grooving 	
<p>G "Grooving"</p> <ul style="list-style-type: none"> – Radial grooving – Axial grooving – Parting off 	
<p>R Full radius</p> <ul style="list-style-type: none"> – Radial grooving – Axial grooving – Longitudinal turning – Facing 	
<p>U Universal</p> <ul style="list-style-type: none"> – Longitudinal turning – Radial grooving – Axial grooving – Facing – Parting off 	

5

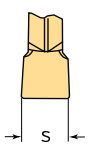
Groove width s [mm]







for example:

200	s = 2,0
220	s = 2,2
250	s = 2,5
300	s = 3,0
310	s = 3,1
etc.	

6

Version

Grooving:	R		right-hand
	L		left-hand
	N		neutral
Parting off:	R		right-hand
	L		left-hand

7

Corner radius r [mm] / clearance angle χ [°]

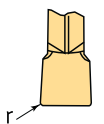

020	r = 0,2
030	r = 0,3
040	r = 0,4
050	r = 0,5
etc.	

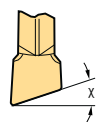









4	$\chi = 4^\circ$
5	$\chi = 5^\circ$
6	$\chi = 6^\circ$

9

Rake angle

smaller











		A
		D
		F
		K

larger

10

Cutting edge

stable

		1
		3
		4
		6
		8

sharp

Walter Select for inserts for parting off

Step by step to the right insert

STEP 1

Determine the **material** to be machined on page H 8.

Make a note of the machining group corresponding to your material e.g.: P10.

Code letters	Machining group	Groups of the materials to be machined	
P	P1–P15	Steel	All types of steel and cast steel, with the exception of steel with an austenitic structure
M	M1–M3	Stainless steel	Stainless austenitic steel and austenitic-ferritic steel and cast steel
K	K1–K7	Cast iron	Grey cast iron, cast iron with spheroidal graphite, malleable cast iron, cast iron with vermicular graphite
N	N1–N10	NF metals	Aluminium and other non-ferrous metals, non-ferrous materials
S	S1–S10	High temperature alloys and titanium alloys	Heat resisting special alloys based on iron, nickel and cobalt, titanium and titanium alloys
H	H1–H4	Hard materials	Hardened steel, hardened cast iron materials, chilled cast iron
O	O1–O6	Other	Plastics, fibre glass and carbon fibre reinforced plastics, graphite

STEP 2

Determine the **basic shape** of the insert:

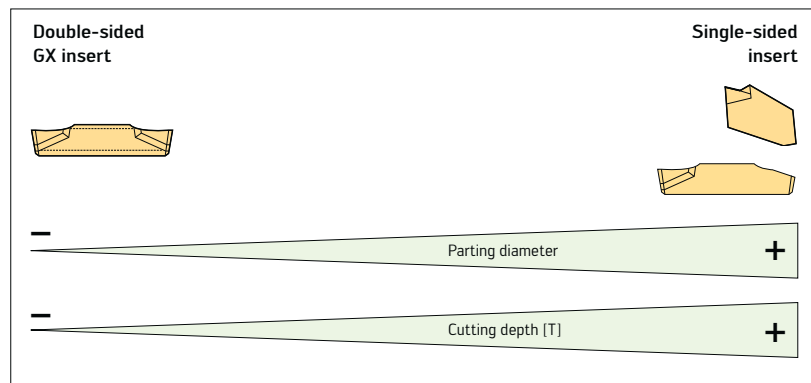

STEP 3

Select the **machining conditions**:

Type of workpiece	Machine stability, clamping system and workpiece		
	very good	good	moderate
Smooth cut Parting off to a bore	☺	☹	☹
Smooth cut Parting off to centre	☹	☹	☹
Interrupted cuts	☹	☹	☹

STEP 4

Determine the **indexable insert geometry** via cutting edge stability and feed.



Geometry selection for inserts for parting off

GX inserts

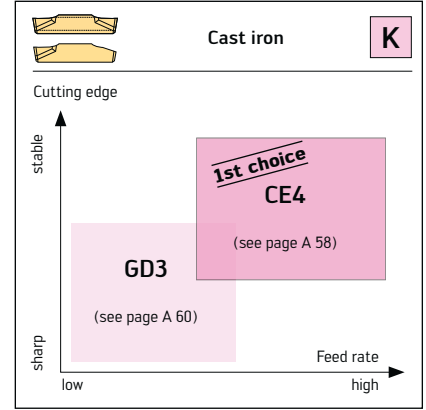
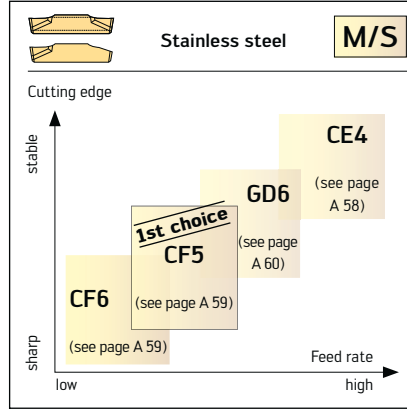
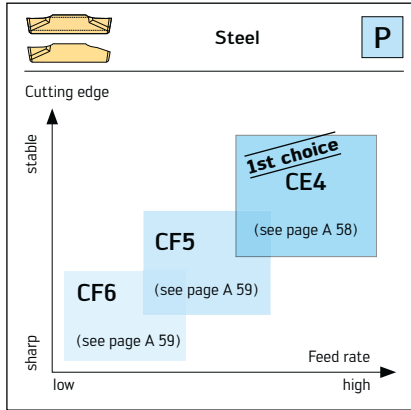

FX inserts

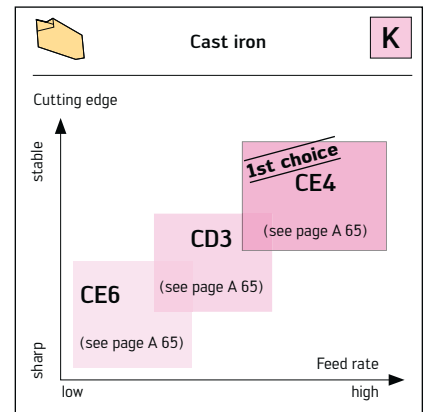
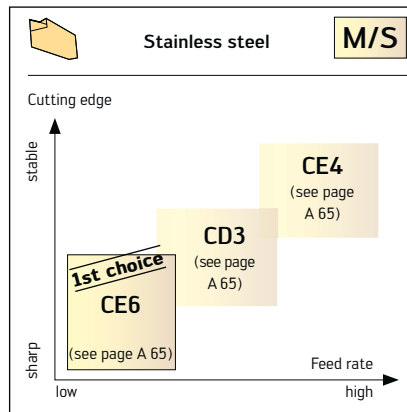
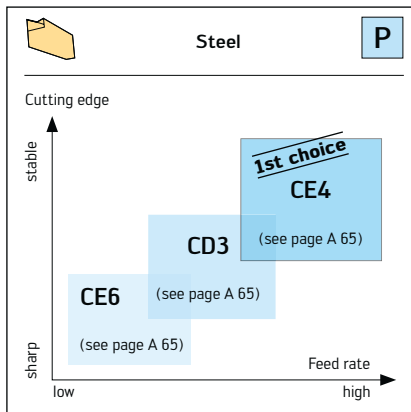

STEP 5

You will find the cutting material recommendation and the feed value (F) on the specified catalogue page.

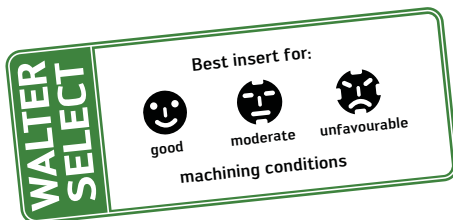

Walter Cut GX grooving inserts
Grooving and parting off
Tiger-tec®

Indexable inserts

Designation	s mm	r mm	k	l mm	f mm	S _{tol} mm	l _{tol} mm	P		M		K		S		
								HC	HC	HC	HC	HC	HC			
GX16-1E200N020-CE4	2	0.2		16,6	0,04 - 0,12	±0,05	±0,15	WSM23	WSM33	WSM43	WSM23	WSM33	WSM43	WSP23	WSP33	WSP43
GX16-1E200R/L6-CE4	2	0.2	6°	16,6	0,04 - 0,10	±0,05	±0,15	WSM23	WSM33	WSM43	WSM23	WSM33	WSM43	WSP23	WSP33	WSP43
GX16-1E250N020-CE4	2,5	0,2		16,6	0,05 - 0,15	±0,05	±0,15	WSM23	WSM33	WSM43	WSM23	WSM33	WSM43	WSP23	WSP33	WSP43

Cutting data for Walter Cut – parting off Carbide grades

☞ = Cutting data for wet machining
☞ = Dry machining is possible

Material group	Structure of main material groups and identification letters	Annealed	Tempered	Bore hardness (HRC)	Tensile strength (R _m N/mm²)	Machining group	☞	☞
Unalloyed steel	C ≤ 0.25 %	annealed		125	428	P1	•	•
	C > 0.25 ... ≤ 0.55 %	annealed		190	639	P2	•	•
	C > 0.25 ... ≤ 0.55 %	tempered		210	708	P3	•	•
	C > 0.55 %	annealed		190	639	P4	•	•
	C > 0.55 %	tempered		300	1013	P5	•	•
Low-alloyed steel	Free cutting steel (short-chipping)	annealed		220	745	P6	•	•
	annealed			175	591	P7	•	•

STEP 6

Choose the **cutting data** in the technical information from page A 306 onwards for your selected insert.

Walter Select for inserts for grooving and recessing

Step by step to the right insert

STEP 1

Determine the **material** to be machined on page H 8.

Note the machining group that corresponds to your material e.g.: P10.

Code letters	Machining group	Groups of the materials to be machined	
P	P1–P15	Steel	All types of steel and cast steel, with the exception of steel with an austenitic structure
M	M1–M3	Stainless steel	Stainless austenitic steel and austenitic-ferritic steel and cast steel
K	K1–K7	Cast iron	Grey cast iron, cast iron with spheroidal graphite, malleable cast iron, cast iron with vermicular graphite
N	N1–N10	NF metals	Aluminium and other non-ferrous metals, non-ferrous materials
S	S1–S10	High temperature alloys and titanium alloys	Heat resisting special alloys based on iron, nickel and cobalt, titanium and titanium alloys
H	H1–H4	Hard materials	Hardened steel, hardened cast iron materials, chilled cast iron
O	O1–O6	Other	Plastics, fibre glass and carbon fibre reinforced plastics, graphite

STEP 2

Determine the **basic shape** of the insert:

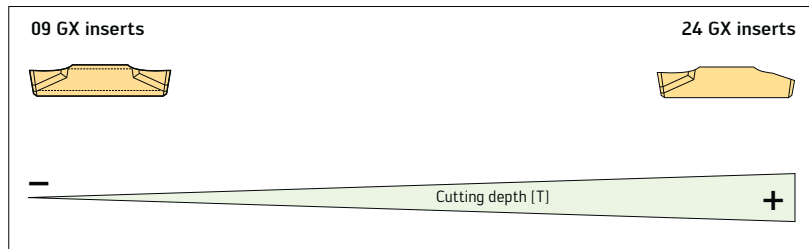

STEP 3

Select the **machining conditions**:

Type of workpiece	Machine stability, clamping system and workpiece		
	very good	good	moderate
Smooth cut Premachined surface	☺	☺	☹
Casting or forged skin Variable cutting depths	☺	☹	☹
Interrupted cuts	☹	☹	☹

STEP 4

Determine the indexable insert geometry via the cutting edge stability and the feed.



Geometry selection for grooving

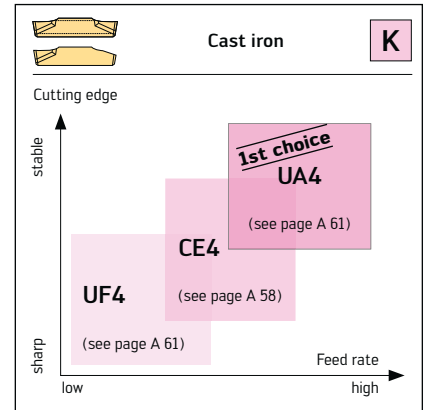
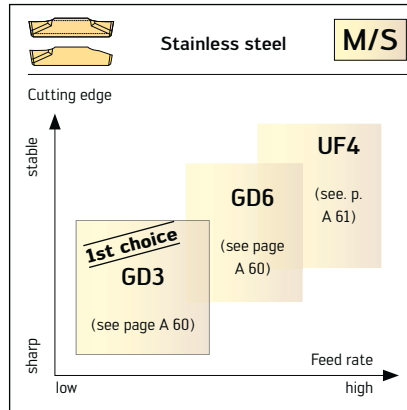
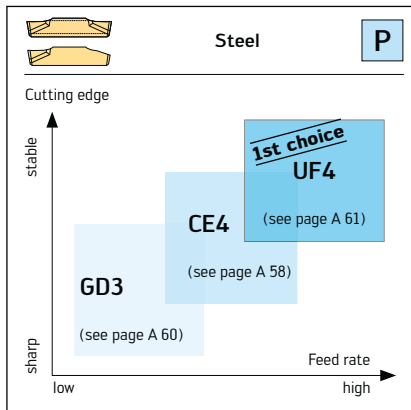

Geometry selection for groove turning

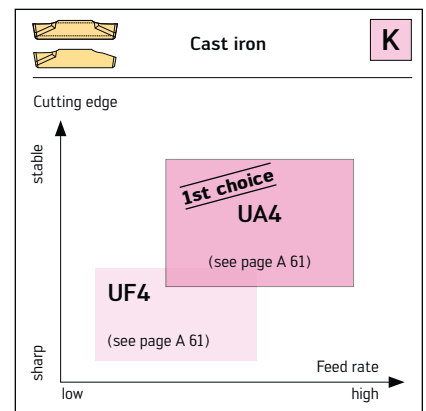
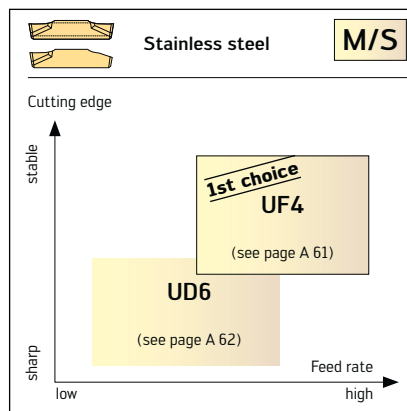
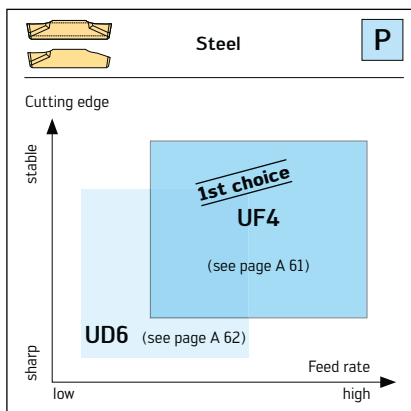

STEP 5

On the specified catalogue page you will find the cutting material recommendation, the feed value (f) and the cutting depth (a_p).

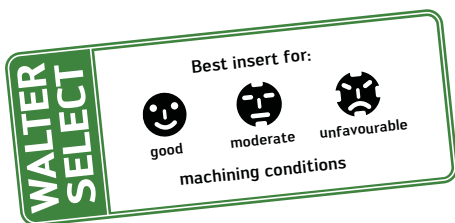

Walter Cut GX grooving inserts
Grooving and parting off
Tiger-tec®

Indexable inserts

Designation	s mm	r mm	k	l mm	f mm	S _{tol} mm	l _{tol} mm	P		M		K		S	
								HC	WC	HC	WC	HC	WC	HC	WC
GX16-1E200N020-CE4	2	0.2		16.6	0.04 - 0.12	±0.05	±0.15	●	●	●	●	●	●	●	●
GX16-1E200R/L6-CE4	2	0.2	6°	16.6	0.04 - 0.10	±0.05	±0.15	●	●	●	●	●	●	●	●
GX16-1E250N020-CE4	2.5	0.2		16.6	0.05 - 0.15	±0.05	±0.15	●	●	●	●	●	●	●	●

Cutting data for Walter Cut – grooving and recessing
Carbide grades

☞ = Cutting data for wet machining
 ☞ = Dry machining is possible

Material group	Structure of main material groups and identification letters		Breed hardness HB	Tensile strength R _m (N/mm²)	Machining group*
	C	W			
Unalloyed steel	C ≤ 0.25 %	annealed	125	428	P1
	C > 0.25 - ≤ 0.55 %	annealed	190	639	P2
	C > 0.25 - ≤ 0.55 %	tempered	210	708	P3
	C > 0.55 %	annealed	190	639	P4
		tempered	300	1013	P5

STEP 6

Choose the cutting data in the technical information from page A 304 onwards for your selected insert.



Walter Cut GX grooving inserts

Grooving and parting off

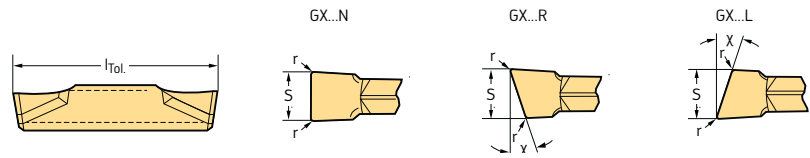
Tiger-tec®



Indexable inserts

Designation	s mm	r mm	κ	l mm	f mm	s _{Tol} mm	l _{Tol} mm	P					M				K	S				
								HC					HC				HC	HC				
								WPP23	WSM23	WSM33	WSP43	WXM33	WSM23	WSM33	WSP43	WAM20	WXM33	WPP23	WSM23	WSM33	WSP43	
 GX16-1E200N020-CE4	2	0,2		16,6	0,04 - 0,12	±0,05	±0,15			☺	☺			☺	☺						☺	☺
GX16-1E200R/L6-CE4	2	0,2	6°	16,6	0,04 - 0,10	±0,05	±0,15			☺	☺			☺	☺						☺	☺
GX16-1E250N020-CE4	2,5	0,2		16,6	0,05 - 0,15	±0,05	±0,15			☺	☺			☺	☺						☺	☺
GX16-1E250R/L6-CE4	2,5	0,2	6°	16,6	0,05 - 0,12	±0,05	±0,15			☺	☺			☺	☺						☺	☺
GX16-2E300N020-CE4	3	0,2		16,6	0,09 - 0,30	±0,05	±0,15			☺	☺			☺	☺						☺	☺
GX16-2E300R/L6-CE4	3	0,2	6°	16,6	0,09 - 0,24	±0,05	±0,15			☺	☺			☺	☺						☺	☺
GX24-2E300N020-CE4	3	0,2		24	0,09 - 0,30	±0,05	±0,15	☺		☺	☺			☺	☺					☺	☺	☺
GX24-2E300R/L6-CE4	3	0,2	6°	24,6	0,09 - 0,24	±0,05	±0,15	☺		☺	☺			☺	☺					☺	☺	☺
GX24-3E400N030-CE4	4	0,3		24	0,10 - 0,32	±0,05	±0,15	☺		☺	☺			☺	☺					☺	☺	☺
GX24-3E400R/L6-CE4	4	0,2	6°	24,6	0,10 - 0,26	±0,05	±0,15	☺		☺	☺			☺	☺					☺	☺	☺
GX24-3E500N030-CE4	5	0,3		24	0,12 - 0,35	±0,05	±0,15	☺		☺	☺			☺	☺					☺	☺	☺
GX24-4E600N030-CE4	6	0,3		24	0,12 - 0,40	±0,05	±0,15	☺		☺	☺			☺	☺					☺	☺	☺
 GX16-1F200N020-CE4	2	0,2		16	0,04 - 0,12	±0,05	±0,15			☺	☺			☺	☺						☺	☺
GX16-1F250N020-CE4	2,5	0,2		16	0,05 - 0,15	±0,05	±0,15			☺	☺			☺	☺						☺	☺
GX24-2F300N020-CE4	3	0,2		23,7	0,09 - 0,30	±0,05	±0,15			☺	☺			☺	☺						☺	☺
GX24-3F400N030-CE4	4	0,3		23,7	0,10 - 0,32	±0,05	±0,15			☺	☺			☺	☺						☺	☺

l_{Tol} = repeat accuracy when changing indexable insert
 Radius tolerance r_{Tol} = ±0.05

HC = Coated carbide

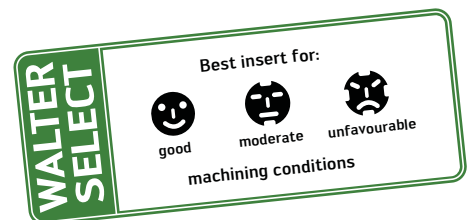



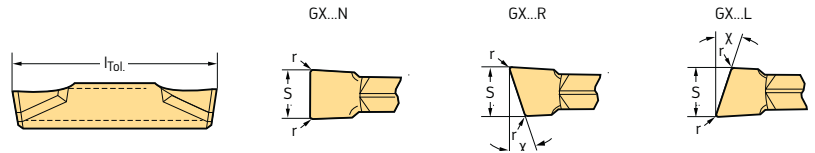

Walter Cut GX grooving inserts

Grooving and parting off

Tiger-tec®



Indexable inserts

Designation	s mm	r mm	κ	l mm	f mm	s _{Tol} mm	l _{Tol} mm	P					M				K		S		
								HC					HC				HC		HC		
								WPP23	WSM23	WSM33	WSP43	WXM33	WSM23	WSM33	WSP43	WAM20	WXM33	WPP23	WSM23	WSM33	WSP43
 GX16-1E200N020-CF5	2	0,2		16,6	0,06 - 0,15	±0,05	±0,15		☉	☉			☉	☉				☉	☉		
GX16-1E200R/L6-CF5	2	0,2	6°	16,6	0,03 - 0,10	±0,05	±0,15		☉	☉			☉	☉				☉	☉		
GX16-1E250N020-CF5	2,5	0,2		16,6	0,07 - 0,18	±0,05	±0,15		☉	☉			☉	☉				☉	☉		
GX16-1E250R/L6-CF5	2,5	0,2	6°	16,6	0,03 - 0,12	±0,05	±0,15		☉	☉			☉	☉				☉	☉		
GX16-2E300N020-CF5	3	0,2		16,6	0,08 - 0,20	±0,05	±0,15		☉	☉			☉	☉				☉	☉		
GX16-2E300R/L6-CF5	3	0,2	6°	16,6	0,04 - 0,16	±0,05	±0,15		☉	☉			☉	☉				☉	☉		
GX24-2E300N020-CF5	3	0,2		24	0,08 - 0,20	±0,05	±0,15		☉	☉			☉	☉				☉	☉		
GX24-2E300R/L6-CF5	3	0,2	6°	24,6	0,04 - 0,16	±0,05	±0,15		☉	☉			☉	☉				☉	☉		
GX24-3E400N020-CF5	4	0,2		24	0,10 - 0,22	±0,05	±0,15		☉	☉			☉	☉				☉	☉		
GX24-3E400R/L6-CF5	4	0,2	6°	24,6	0,10 - 0,18	±0,05	±0,15		☉	☉			☉	☉				☉	☉		
GX24-3E500N030-CF5	5	0,3		24	0,10 - 0,25	±0,05	±0,15		☉	☉			☉	☉				☉	☉		
 GX16-1F200N020-CF5	2	0,2		16	0,03 - 0,12	±0,05	±0,15		☉	☉			☉	☉				☉	☉		
GX16-1F250N020-CF5	2,5	0,2		16	0,03 - 0,15	±0,05	±0,15		☉	☉			☉	☉				☉	☉		
GX24-2F300N020-CF5	3	0,2		23,7	0,04 - 0,20	±0,05	±0,15		☉	☉			☉	☉				☉	☉		
GX24-3F400N020-CF5	4	0,2		23,7	0,10 - 0,22	±0,05	±0,15		☉	☉			☉	☉				☉	☉		
GX24-3F500N030-CF5	5	0,3		23,7	0,10 - 0,25	±0,05	±0,15		☉	☉			☉	☉				☉	☉		
 GX16-0E150N015-CF6	1,5	0,15		16,6	0,03 - 0,10	±0,02	±0,05		☉				☉					☉			
GX16-1E200N020-CF6	2	0,2		16,6	0,03 - 0,12	±0,05	±0,15		☉	☉			☉	☉				☉	☉		
GX16-1E200R/L6-CF6	2	0,2	6°	16,6	0,03 - 0,10	±0,05	±0,15		☉	☉			☉	☉				☉	☉		
GX16-1E250N020-CF6	2,5	0,2		16,6	0,03 - 0,15	±0,05	±0,15		☉	☉			☉	☉				☉	☉		
GX16-1E250R/L6-CF6	2,5	0,2	6°	16,6	0,03 - 0,12	±0,05	±0,15		☉	☉			☉	☉				☉	☉		
GX16-2E300N020-CF6	3	0,2		16,6	0,04 - 0,20	±0,05	±0,15		☉	☉			☉	☉				☉	☉		
GX16-2E300R/L6-CF6	3	0,2	6°	16,6	0,04 - 0,16	±0,05	±0,15		☉	☉			☉	☉				☉	☉		
GX24-2E300N020-CF6	3	0,2		24,6	0,04 - 0,20	±0,05	±0,15		☉	☉			☉	☉				☉	☉		
GX24-2E300R/L6-CF6	3	0,2	6°	24,6	0,04 - 0,16	±0,05	±0,15		☉	☉			☉	☉				☉	☉		
 GX16-1F200N020-CF6	2	0,2		16	0,03 - 0,12	±0,05	±0,15		☉	☉			☉	☉				☉	☉		
GX16-1F250N020-CF6	2,5	0,2		16	0,03 - 0,15	±0,05	±0,15		☉	☉			☉	☉				☉	☉		
GX24-2F300N020-CF6	3	0,2		24,2	0,04 - 0,20	±0,05	±0,15		☉	☉			☉	☉				☉	☉		

l_{Tol} = repeat accuracy when changing indexable insert
 Radius tolerance r_{Tol} = ±0.05

HC = Coated carbide



Walter Cut GX grooving inserts

Grooving and parting off

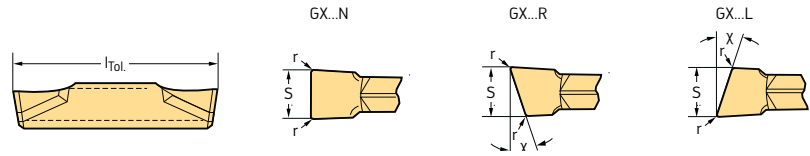
Tiger-tec®



Indexable inserts

Designation	s mm	r mm	k	l mm	f mm	s _{Tol} mm	l _{Tol} mm	P					M				K		S	
								HC					HC				HC		HC	
								WPP23	WSM23	WSM33	WSP43	WXM33	WSM23	WSM33	WSP43	WAM20	WXM33	WPP23	WSM23	WSM33
 GX09-1E200N020-GD3	2	0,2		9	0,04 - 0,12	±0,02	±0,05	☺	☺	☺	☺	☺	☺	☺	☺	☺	☺	☺	☺	
GX09-1E250N020-GD3	2,5	0,2		9	0,04 - 0,14	±0,02	±0,05	☺	☺	☺	☺	☺	☺	☺	☺	☺	☺	☺	☺	
GX09-2E300N030-GD3	3	0,3		9	0,06 - 0,18	±0,02	±0,05	☺	☺	☺	☺	☺	☺	☺	☺	☺	☺	☺	☺	
GX09-2E350N030-GD3	3,5	0,3		9	0,06 - 0,18	±0,02	±0,05	☺	☺	☺	☺	☺	☺	☺	☺	☺	☺	☺	☺	
GX16-1E200N020-GD3	2	0,2		16	0,04 - 0,12	±0,02	±0,05	☺	☺	☺	☺	☺	☺	☺	☺	☺	☺	☺	☺	
GX16-1E250N020-GD3	2,5	0,2		16	0,04 - 0,14	±0,02	±0,05	☺	☺	☺	☺	☺	☺	☺	☺	☺	☺	☺	☺	
GX16-2E300N030-GD3	3	0,3		16	0,06 - 0,18	±0,02	±0,05	☺	☺	☺	☺	☺	☺	☺	☺	☺	☺	☺	☺	
GX16-3E400N040-GD3	4	0,4		16	0,10 - 0,20	±0,02	±0,05	☺	☺	☺	☺	☺	☺	☺	☺	☺	☺	☺	☺	
GX16-3E500N040-GD3	5	0,4		16	0,12 - 0,25	±0,02	±0,05	☺	☺	☺	☺	☺	☺	☺	☺	☺	☺	☺	☺	
GX16-4E600N050-GD3	6	0,5		16	0,14 - 0,28	±0,02	±0,05	☺	☺	☺	☺	☺	☺	☺	☺	☺	☺	☺	☺	
GX24-2E300N030-GD3	3	0,3		24	0,06 - 0,18	±0,05	±0,15	☺	☺	☺	☺	☺	☺	☺	☺	☺	☺	☺	☺	
GX24-3E400N040-GD3	4	0,4		24	0,10 - 0,20	±0,05	±0,15	☺	☺	☺	☺	☺	☺	☺	☺	☺	☺	☺	☺	
GX24-3E500N040-GD3	5	0,4		24	0,12 - 0,25	±0,05	±0,15	☺	☺	☺	☺	☺	☺	☺	☺	☺	☺	☺	☺	
GX24-4E600N050-GD3	6	0,5		24	0,14 - 0,28	±0,05	±0,15	☺	☺	☺	☺	☺	☺	☺	☺	☺	☺	☺	☺	
 GX16-1E200N020-GD6	2	0,2		16	0,04 - 0,12	±0,05	±0,15				☺			☺	☺					
GX16-1E250N020-GD6	2,5	0,2		16	0,06 - 0,17	±0,05	±0,15				☺			☺	☺					
GX16-2E300N030-GD6	3	0,3		16	0,08 - 0,18	±0,05	±0,15				☺			☺	☺					
GX16-3E400N040-GD6	4	0,4		16	0,10 - 0,22	±0,05	±0,15				☺			☺	☺					
GX16-3E500N040-GD6	5	0,4		16	0,12 - 0,24	±0,05	±0,15				☺			☺	☺					
GX16-4E600N050-GD6	6	0,5		16	0,14 - 0,30	±0,05	±0,15				☺			☺	☺					
GX24-2E300N030-GD6	3	0,3		24	0,08 - 0,18	±0,05	±0,15				☺			☺	☺					
GX24-3E400N040-GD6	4	0,4		24	0,10 - 0,22	±0,05	±0,15				☺			☺	☺					
GX24-3E500N040-GD6	5	0,4		24	0,12 - 0,24	±0,05	±0,15				☺			☺	☺					
GX24-4E600N050-GD6	6	0,5		24	0,14 - 0,30	±0,05	±0,15				☺			☺	☺					

l_{Tol} = repeat accuracy when changing indexable insert
 Radius tolerance r_{Tol} = ±0.05

HC = Coated carbide

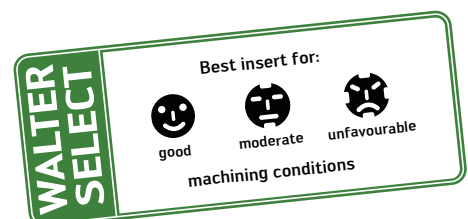



Walter Cut GX/LX grooving inserts

Grooving and recessing

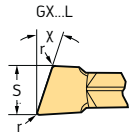
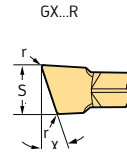
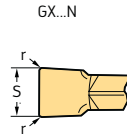
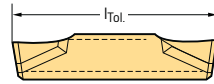
Tiger-tec®

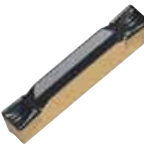

Indexable inserts

Designation	s mm	r mm	l mm	f mm	ap mm	s _{Tol} mm	l _{Tol} mm	P				M				K			S	
								HC				HC				HC			HC	
								WPP23	WSM33	WSP43	WXM33	WSM33	WSP43	WAM20	WXM33	WAK20	WAK30	WPP23	WSM33	WSP43
 GX09-1E200N020-UF4	2	0,2	9	0,10 - 0,15	0,3 - 1,0	±0,05	±0,15	☺	☺	☺	☺	☺	☺				☺	☺		
GX09-2E300N030-UF4	3	0,3	9	0,10 - 0,20	0,4 - 1,5	±0,05	±0,15	☺	☺	☺	☺	☺					☺	☺		
GX16-1E200N020-UF4	2	0,2	16	0,10 - 0,15	0,3 - 1,2	±0,05	±0,15	☺	☺	☺	☺	☺					☺	☺		
GX16-1E250N020-UF4	2,5	0,2	16	0,10 - 0,18	0,3 - 1,3	±0,05	±0,15	☺	☺	☺	☺	☺					☺	☺		
GX16-2E300N030-UF4	3	0,3	16	0,10 - 0,20	0,4 - 2,0	±0,05	±0,15	☺	☺	☺	☺	☺					☺	☺		
GX16-3E400N040-UF4	4	0,4	16	0,10 - 0,30	0,5 - 2,8	±0,05	±0,15	☺	☺	☺	☺	☺					☺	☺		
GX16-3E500N040-UF4	5	0,4	16	0,12 - 0,35	0,5 - 3,0	±0,05	±0,15	☺	☺	☺	☺	☺					☺	☺		
GX16-4E600N050-UF4	6	0,5	16	0,14 - 0,40	0,6 - 3,5	±0,05	±0,15	☺	☺	☺	☺	☺					☺	☺		
GX24-2E300N030-UF4	3	0,3	24	0,10 - 0,20	0,4 - 2,0	±0,05	±0,15	☺	☺	☺	☺	☺					☺	☺		
GX24-3E400N040-UF4	4	0,4	24	0,10 - 0,30	0,5 - 2,8	±0,05	±0,15	☺	☺	☺	☺	☺					☺	☺		
GX24-3E400N080-UF4	4	0,8	24	0,10 - 0,30	0,9 - 2,8	±0,05	±0,15	☺	☺		☺						☺	☺		
GX24-3E500N040-UF4	5	0,4	24	0,12 - 0,35	0,5 - 3,0	±0,05	±0,15	☺	☺	☺	☺	☺					☺	☺		
GX24-3E500N080-UF4	5	0,8	24	0,12 - 0,35	0,9 - 3,0	±0,05	±0,15	☺	☺		☺						☺	☺		
GX24-4E600N050-UF4	6	0,5	24	0,14 - 0,40	0,6 - 3,5	±0,05	±0,15	☺	☺	☺	☺	☺					☺	☺		
GX24-4E600N080-UF4	6	0,8	24	0,14 - 0,40	0,9 - 3,5	±0,05	±0,15	☺	☺		☺						☺	☺		
 GX16-1E200N020-UA4	2	0,2	16	0,08 - 0,15	0,3 - 1,2	±0,05	±0,15										☺	☺		
GX16-1E250N020-UA4	2,5	0,2	16	0,10 - 0,20	0,3 - 1,3	±0,05	±0,15										☺	☺		
GX16-2E300N030-UA4	3	0,3	16	0,10 - 0,22	0,4 - 2,0	±0,05	±0,15										☺	☺		
GX16-3E400N040-UA4	4	0,4	16	0,10 - 0,35	0,5 - 2,8	±0,05	±0,15										☺	☺		
GX16-3E500N040-UA4	5	0,4	16	0,12 - 0,35	0,5 - 3,0	±0,05	±0,15										☺	☺		
GX16-4E600N050-UA4	6	0,5	16	0,14 - 0,40	0,6 - 3,5	±0,05	±0,15										☺	☺		
GX24-2E300N030-UA4	3	0,3	24	0,10 - 0,22	0,4 - 2,0	±0,05	±0,15										☺	☺		
GX24-3E400N040-UA4	4	0,4	24	0,10 - 0,35	0,5 - 2,8	±0,05	±0,15										☺	☺		
GX24-3E500N040-UA4	5	0,4	24	0,12 - 0,35	0,5 - 3,0	±0,05	±0,15										☺	☺		
GX24-4E600N050-UA4	6	0,5	24	0,14 - 0,40	0,6 - 3,5	±0,05	±0,15										☺	☺		

l_{Tol} = repeat accuracy when changing indexable insert
 Radius tolerance r_{Tol} = ±0.05

HC = Coated carbide

Walter Cut GX/LX grooving inserts

Grooving and recessing

Tiger-tec®

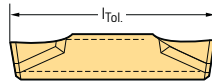

GX...N

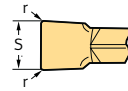

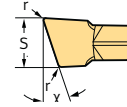

GX...R

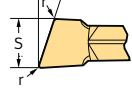

GX...L



Indexable inserts

Designation	s mm	r mm	l mm	f mm	ap mm	s _{Tol} mm	l _{Tol} mm	P				M				K			S	
								HC				HC				HC			HC	
								WPP23	WSM33	WSP43	WXM33	WSM33	WSP43	WAM20	WXM33	WAK20	WAK30	WPP23	WSM33	WSP43
 GX16-1E200N020-UD6	2	0,2	16	0,06 - 0,15	0,3 - 1,2	±0,05	±0,15				☺									
GX16-1E250N020-UD6	2,5	0,2	16	0,08 - 0,14	0,3 - 1,3	±0,05	±0,15				☺									
GX16-2E300N030-UD6	3	0,3	16	0,10 - 0,20	0,4 - 2,0	±0,05	±0,15				☺									
GX16-3E400N040-UD6	4	0,4	16	0,12 - 0,25	0,5 - 2,8	±0,05	±0,15				☺									
GX16-3E500N040-UD6	5	0,4	16	0,12 - 0,30	0,5 - 3,0	±0,05	±0,15				☺									
GX16-4E600N050-UD6	6	0,5	16	0,14 - 0,35	0,6 - 3,5	±0,05	±0,15				☺									
GX24-2E300N030-UD6	3	0,3	24	0,10 - 0,20	0,4 - 2,0	±0,05	±0,15				☺									
GX24-3E400N040-UD6	4	0,4	24	0,12 - 0,25	0,5 - 2,8	±0,05	±0,15				☺									
GX24-3E500N040-UD6	5	0,4	24	0,12 - 0,30	0,5 - 3,0	±0,05	±0,15				☺									
GX24-4E600N050-UD6	6	0,5	24	0,14 - 0,35	0,6 - 3,5	±0,05	±0,15				☺									
 LX-E800N080-UE4	8	0,8		0,20 - 0,50	0,9 - 5,0	-0,08	±0,15	☺	☺	☺		☺	☺				☺	☺	☺	

l_{Tol} = repeat accuracy when changing indexable insert

Radius tolerance r_{Tol} = ±0.05

HC = Coated carbide

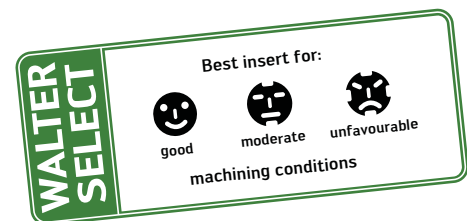

Walter Cut GX grooving inserts Circlip grooves

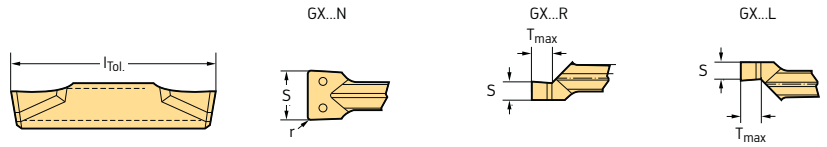

Indexable inserts

Designation	s mm	r mm	T _{max} mm	l mm	f mm	S _{Tol} mm	l _{Tol} mm	P			M		K		S	
								HC			HC		HC		HC	
								WPP23	WSM33	WSP43	WTA33	WSM33	WSP43	WTA33	WSM33	WSP43
GX09-1S1.00R/L	1		1,14	9	0,05 - 0,10	±0,02	±0,05			⊕		⊕				
GX09-1S1.20R/L	1,2		1,34	9	0,05 - 0,10	±0,02	±0,05			⊕		⊕				
GX09-1S1.40R/L	1,4		1,53	9	0,05 - 0,10	±0,02	±0,05			⊕		⊕				
GX09-1S1.70R/L	1,7		1,82	9	0,05 - 0,10	±0,02	±0,05			⊕		⊕				
GX09-1S1.95N	1,95	0,1		9	0,05 - 0,10	±0,02	±0,05			⊕		⊕				
GX09-1S2.25N	2,25	0,1		9	0,05 - 0,12	±0,02	±0,05			⊕		⊕				
GX09-2S2.75N	2,75	0,1		9	0,05 - 0,12	±0,02	±0,05			⊕		⊕				
GX09-2S3.25N	3,25	0,1		9	0,05 - 0,12	±0,02	±0,05			⊕		⊕				
GX16-2S0.60R/L	0,6		0,75	16	0,05 - 0,10	±0,02	±0,05			⊕		⊕				
GX16-2S0.80R/L	0,8		0,94	16	0,05 - 0,10	±0,02	±0,05			⊕		⊕				
GX16-2S0.90R/L	0,9		1,04	16	0,05 - 0,10	±0,02	±0,05			⊕		⊕				
GX16-2S1.00R/L	1		1,14	16	0,05 - 0,10	±0,02	±0,05			⊕		⊕				
GX16-2S1.20R/L	1,2		1,34	16	0,05 - 0,10	±0,02	±0,05			⊕		⊕				
GX16-2S1.40R/L	1,4		1,53	16	0,05 - 0,10	±0,02	±0,05			⊕		⊕				
GX16-2S1.70R/L	1,7		1,82	16	0,05 - 0,10	±0,02	±0,05			⊕		⊕				
GX16-2S1.95R/L	1,95		2,07	16	0,05 - 0,10	±0,02	±0,05			⊕		⊕				
GX16-2S2.25R/L	2,25		2,36	16	0,05 - 0,12	±0,02	±0,05			⊕		⊕				
GX16-2S2.75N	2,75	0,1		16	0,05 - 0,12	±0,02	±0,05			⊕		⊕				
GX16-2S3.25N	3,25	0,1		16	0,07 - 0,14	±0,02	±0,05			⊕		⊕				
GX16-3S4.25N	4,25	0,2		16	0,07 - 0,20	±0,02	±0,05			⊕		⊕				
GX16-4S5.25N	5,25	0,2		16	0,08 - 0,20	±0,02	±0,05			⊕		⊕				

l_{Tol} = repeat accuracy when changing indexable insert
 Radius tolerance r_{Tol} = ±0.05

HC = Coated carbide



Walter Cut GX/LX grooving inserts

Grooving and longitudinal turning

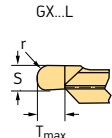
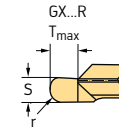
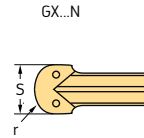
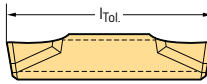
Tiger-tec®

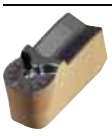

Indexable inserts

Designation	s mm	r mm	l mm	T _{max} mm	f mm	ap mm	S _{Tol} mm	l _{Tol} mm	P				M		K		N	S	
									HC				HC		HC		HW	HC	
									WPP23	WSM33	WSP43	WTA33	WSM33	WSP43	WPP23	WTA33	WK1	WSM33	WSP43
 GX24-2E300N150-RD4	3	1,5	24		0,08 - 0,35	1,5	±0,05	±0,15	☺	☺			☺		☺				☺
GX24-3E400N200-RD4	4	2	24		0,10 - 0,40	2	±0,05	±0,15	☺	☺			☺		☺				☺
GX24-3E500N250-RD4	5	2,5	24		0,12 - 0,50	2,5	±0,05	±0,15	☺	☺			☺		☺				☺
GX24-4E600N300-RD4	6	3	24		0,15 - 0,60	3	±0,05	±0,15	☺	☺			☺		☺				☺
 GX09-1R1.00N	2	1	9		0,05 - 0,17	1	±0,02	±0,02				☺			☺				
GX09-1R1.20N	2,4	1,2	9		0,05 - 0,17	1,2	±0,02	±0,02				☺			☺				
GX16-2R1.00R/L	2	1	16	2,18	0,05 - 0,17	1	±0,02	±0,02				☺			☺				
GX16-2R1.20R/L	2,4	1,2	16	2,58	0,05 - 0,17	1,2	±0,02	±0,02				☺			☺				
GX16-2R1.50N	3	1,5	16		0,10 - 0,20	1,5	±0,02	±0,02				☺			☺				
GX16-3R2.00N	4	2	16		0,10 - 0,30	2	±0,02	±0,02				☺			☺				
GX16-3R2.50N	5	2,5	16		0,15 - 0,35	2,5	±0,02	±0,02				☺			☺				
GX16-4R3.00N	6	3	16		0,15 - 0,40	3	±0,02	±0,02				☺			☺				
 GX24-4R300N-RK8	6	3	25,4		0,10 - 0,30	4	±0,02	±0,05											☺
GX24-5R400N-RK8	8	4	25,4		0,10 - 0,35	5	±0,02	±0,05											☺
 LX-E800N400-RD3	8	4	19		0,15 - 0,50	4	±0,08	±0,15	☺	☺			☺		☺				☺

l_{Tol} = repeat accuracy when changing indexable insert
 Radius tolerance r_{Tol} = ±0.05

HC = Coated carbide
 HW = Uncoated carbide

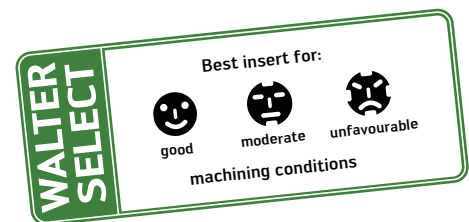



Walter Cut FX grooving inserts

Grooving and parting off

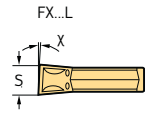
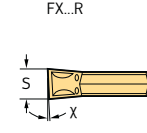
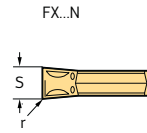
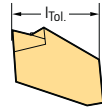
Tiger-tec®

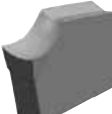

Indexable inserts

Designation	s mm	r mm	k	f mm	s _{Tol} mm	l _{Tol} mm	P		M		K		N		S	
							HC		HC		HC		HW		HC	
							WPP23	WSM33	WSP43	WSM33	WSP43	WPP23	WK1	WSM33	WSP43	
 FX2.2-E220N010-CE4	2,2	0,1		0,05 - 0,15	±0,05	±0,10	☉	☉	☉	☉	☉	☉	☉	☉	☉	☉
FX2.2-E220R/L4-CE4	2,2	0,1	4°	0,05 - 0,15	±0,05	±0,10	☉	☉	☉	☉	☉	☉	☉	☉	☉	☉
FX3.1-E310N015-CE4	3,1	0,15		0,09 - 0,30	±0,05	±0,10	☉	☉	☉	☉	☉	☉	☉	☉	☉	☉
FX3.1-E310R/L6-CE4	3,1	0,15	6°	0,09 - 0,24	±0,05	±0,10	☉	☉	☉	☉	☉	☉	☉	☉	☉	☉
FX4.1-E410N020-CE4	4,1	0,2		0,10 - 0,32	±0,05	±0,10	☉	☉	☉	☉	☉	☉	☉	☉	☉	☉
FX4.1-E410R/L6-CE4	4,1	0,2	6°	0,10 - 0,26	±0,05	±0,10	☉	☉	☉	☉	☉	☉	☉	☉	☉	☉
FX5.1-E510N025-CE4	5,1	0,25		0,12 - 0,35	±0,05	±0,10	☉	☉	☉	☉	☉	☉	☉	☉	☉	☉
FX5.1-E510/L6-CE4	5,1	0,25	6°	0,12 - 0,28	±0,05	±0,10	☉	☉	☉	☉	☉	☉	☉	☉	☉	☉
FX6.5-E650N030-CE4	6,5	0,3		0,12 - 0,40	±0,05	±0,10	☉	☉	☉	☉	☉	☉	☉	☉	☉	☉
FX6.5-E650/L6-CE4	6,5	0,3	6°	0,12 - 0,32	±0,05	±0,10	☉	☉	☉	☉	☉	☉	☉	☉	☉	☉
FX8.2-E820N040-CE4	8,2	0,4		0,15 - 0,45	±0,05	±0,10	☉	☉	☉	☉	☉	☉	☉	☉	☉	☉
FX9.7-E970N040-CE4	9,7	0,4		0,15 - 0,50	±0,05	±0,10	☉	☉	☉	☉	☉	☉	☉	☉	☉	☉
 FX3.1-E310N040-CD3	3,1	0,4		0,10 - 0,30	±0,05	±0,10	☉	☉	☉	☉	☉	☉	☉	☉	☉	☉
FX4.1-E410N020-CD3	4,1	0,2		0,15 - 0,35	±0,05	±0,10	☉	☉	☉	☉	☉	☉	☉	☉	☉	☉
FX4.1-E410N050-CD3	4,1	0,5		0,15 - 0,35	±0,05	±0,10	☉	☉	☉	☉	☉	☉	☉	☉	☉	☉
 FX2.2-E220N015-CE6	2,2	0,15		0,05 - 0,15	±0,05	±0,10	☉	☉	☉	☉	☉	☉	☉	☉	☉	☉
FX2.2-E220R/L5-CE6	2,2	0,15	5°	0,05 - 0,15	±0,05	±0,10	☉	☉	☉	☉	☉	☉	☉	☉	☉	☉
FX3.1-E310N020-CE6	3,1	0,2		0,06 - 0,25	±0,05	±0,10	☉	☉	☉	☉	☉	☉	☉	☉	☉	☉
FX3.1-E310N040-CE6	3,1	0,4		0,06 - 0,25	±0,05	±0,10	☉	☉	☉	☉	☉	☉	☉	☉	☉	☉
FX3.1-E310R/L5-CE6	3,1	0,2	5°	0,06 - 0,20	±0,05	±0,10	☉	☉	☉	☉	☉	☉	☉	☉	☉	☉
FX4.1-E410N020-CE6	4,1	0,2		0,08 - 0,25	±0,05	±0,10	☉	☉	☉	☉	☉	☉	☉	☉	☉	☉
FX4.1-E410N050-CE6	4,1	0,5		0,08 - 0,25	±0,05	±0,10	☉	☉	☉	☉	☉	☉	☉	☉	☉	☉
FX4.1-E410R/L5-CE6	4,1	0,2	5°	0,08 - 0,20	±0,05	±0,10	☉	☉	☉	☉	☉	☉	☉	☉	☉	☉
 FX2.2-E220N010-CK8	2,2	0,1		0,05 - 0,10	±0,05	±0,10							☉			
FX3.1-E310N015-CK8	3,1	0,15		0,05 - 0,15	±0,05	±0,10							☉			
FX4.1-E410N015-CK8	4,1	0,15		0,05 - 0,20	±0,05	±0,10							☉			

l_{Tol} = repeat accuracy when changing indexable insert
 Radius tolerance r_{Tol} = ±0.05

HC = Coated carbide
 HW = Uncoated carbide

Special inserts made from standard blanks



Blanks for special forms

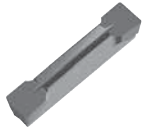

Designation	s mm	b mm	l mm	HW WK08
GX 16-1E3.30N	3,3	1,4	16,6	△
GX 16-2E4.30N	4,3	2,1	16,6	△
GX 24-2E4.80N	4,8	2,1	24,6	△
GX 16-3E6.30N	6,3	3,05	16,6	△
GX 24-3E6.30N	3,6	3,05	24,6	△
GX 16-4E8.30N	8,3	4,3	24,6	△
GX 24-4E8.30N	8,3	4,3	24,6	△
GX 24-5E10.30N	10,3	6,2	24,6	△

Cutting material WK08 has the ISO application range P20, M20.

HW = Uncoated carbide

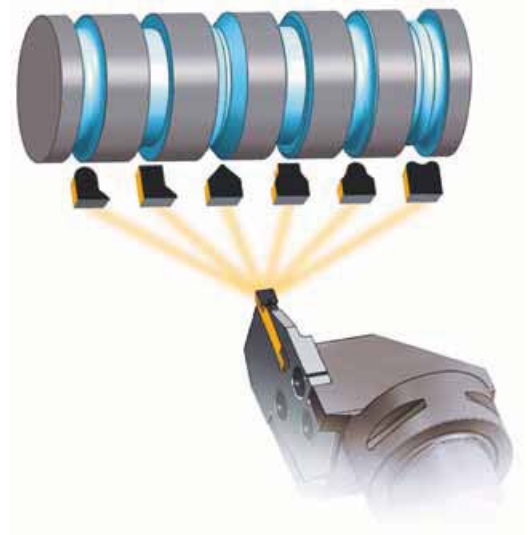

Walter NTS threading inserts

Full profile, ISO metric 60°

External thread

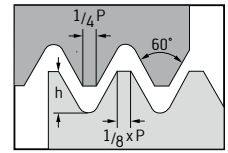
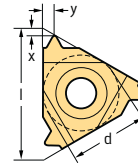

Indexable insert

Designation	Lead (P) mm	l mm	d mm	h _{min} mm	X mm	Y mm	P		M	
							HC		HC	
							WXP20	WMP32	WXM20	WMP32
NTS-ER/L-16 0.50ISO	0,5	16	9,525	0,31	0,6	0,4	☺	☺	☺	☺
NTS-ER/L-16 0.60ISO	0,6	16	9,525	0,37	0,6	0,6	☺	☺	☺	☺
NTS-ER/L-16 0.70ISO	0,7	16	9,525	0,43	0,6	0,6	☺	☺	☺	☺
NTS-ER/L-16 0.75ISO	0,75	16	9,525	0,46	0,6	0,6	☺	☺	☺	☺
NTS-ER/L-16 0.80ISO	0,8	16	9,525	0,49	0,6	0,6	☺	☺	☺	☺
NTS-ER/L-16 1.00ISO	1	16	9,525	0,61	0,7	0,7	☺	☺	☺	☺
NTS-ER/L-16 1.25ISO	1,25	16	9,525	0,77	0,8	0,9	☺	☺	☺	☺
NTS-ER/L-16 1.50ISO	1,5	16	9,525	0,92	0,8	1	☺	☺	☺	☺
NTS-ER/L-16 1.75ISO	1,75	16	9,525	1,07	0,9	1,2	☺	☺	☺	☺
NTS-ER/L-16 2.00ISO	2	16	9,525	1,23	1	1,3	☺	☺	☺	☺
NTS-ER/L-16 2.50ISO	2,5	16	9,525	1,53	1,1	1,5	☺	☺	☺	☺
NTS-ER/L-16 3.00ISO	3	16	9,525	1,84	1,2	1,6	☺	☺	☺	☺
NTS-ER/L-22 3.50ISO	3,5	22	12,7	2,15	1,6	2,3	☺	☺	☺	☺
NTS-ER/L-22 4.00ISO	4	22	12,7	2,45	1,6	2,3	☺	☺	☺	☺
NTS-ER/L-22 4.50ISO	4,5	22	12,7	2,76	1,7	2,4	☺	☺	☺	☺
NTS-ER/L-22 5.00ISO	5	22	12,7	3,07	1,7	2,5	☺	☺	☺	☺



HC = Coated carbide

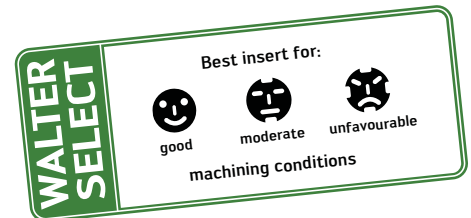

Walter NTS threading inserts

Full profile, ISO metric 60°

Internal thread

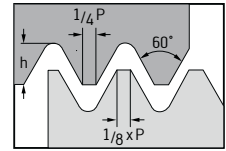
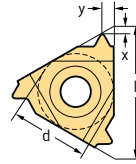

Indexable inserts

Designation	Lead (P) mm	l mm	d mm	h _{min} mm	X mm	Y mm	P		M	
							HC		HC	
							WXP20	WMP32	WXM20	WMP32
NTS-IR/L-11 0.75ISO	0,75	11	6,35	0,43	0,6	0,6	☺	☺	☺	☺
NTS-IR/L-11 0.80ISO	0,8	11	6,35	0,46	0,6	0,6	☺	☺	☺	☺
NTS-IR/L-11 1.00ISO	1	11	6,35	0,58	0,6	0,7	☺	☺	☺	☺
NTS-IR/L-11 1.25ISO	1,25	11	6,35	0,72	0,8	0,9	☺	☺	☺	☺
NTS-IR/L-11 1.50ISO	1,5	11	6,35	0,87	0,8	1	☺	☺	☺	☺
NTS-IR/L-11 1.75ISO	1,75	11	6,35	1,01	0,9	1,1	☺	☺	☺	☺
NTS-IR/L-11 2.00ISO	2	11	6,35	1,15	0,9	1,1	☺	☺	☺	☺
NTS-IR/L-11 2.50ISO	2,5	11	6,35	1,44	0,8	1,1	☺	☺	☺	☺
NTS-IR/L-16 0.50ISO	0,5	16	9,525	0,29	0,6	0,4	☺	☺	☺	☺
NTS-IR/L-16 0.60ISO	0,6	16	9,525	0,35	0,6	0,6	☺	☺	☺	☺
NTS-IR/L-16 0.70ISO	0,7	16	9,525	0,4	0,6	0,6	☺	☺	☺	☺
NTS-IR/L-16 0.75ISO	0,75	16	9,525	0,43	0,6	0,6	☺	☺	☺	☺
NTS-IR/L-16 0.80ISO	0,8	16	9,525	0,46	0,6	0,6	☺	☺	☺	☺
NTS-IR/L-16 1.00ISO	1	16	9,525	0,58	0,6	0,7	☺	☺	☺	☺
NTS-IR/L-16 1.25ISO	1,25	16	9,525	0,72	0,8	0,9	☺	☺	☺	☺
NTS-IR/L-16 1.50ISO	1,5	16	9,525	0,87	0,8	1	☺	☺	☺	☺
NTS-IR/L-16 1.75ISO	1,75	16	9,525	1,01	0,9	1,2	☺	☺	☺	☺
NTS-IR/L-16 2.00ISO	2	16	9,525	1,15	1	1,3	☺	☺	☺	☺
NTS-IR/L-16 2.50ISO	2,5	16	9,525	1,44	1,1	1,5	☺	☺	☺	☺
NTS-IR/L-16 3.00ISO	3	16	9,525	1,73	1,1	1,5	☺	☺	☺	☺
NTS-IR/L-22 3.50ISO	3,5	22	12,7	2,02	1,6	2,3	☺	☺	☺	☺
NTS-IR/L-22 4.00ISO	4	22	12,7	2,31	1,6	2,3	☺	☺	☺	☺
NTS-IR/L-22 4.50ISO	4,5	22	12,7	2,6	1,6	2,4	☺	☺	☺	☺
NTS-IR/L-22 5.00ISO	5	22	12,7	2,89	1,6	2,4	☺	☺	☺	☺

HC = Coated carbide

Walter NTS threading inserts

Full profile, American UN 60°

External thread

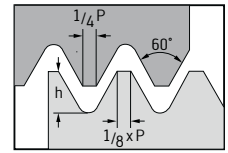
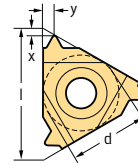

Indexable inserts

Designation	Lead (TPI)	l mm	d mm	h _{min} mm	X mm	Y mm	P		M	
							HC		HC	
							WXP20	WMP32	WXM20	WMP32
NTS-ER/L-16 008UN	8	16	9,525	1,95	1,2	1,6	☺	☺	☺	☺
NTS-ER/L-16 009UN	9	16	9,525	1,73	1,2	1,7	☺	☺	☺	☺
NTS-ER/L-16 010UN	10	16	9,525	1,56	1,1	1,5	☺	☺	☺	☺
NTS-ER/L-16 011UN	11	16	9,525	1,42	1,1	1,5	☺	☺	☺	☺
NTS-ER/L-16 012UN	12	16	9,525	1,3	1,1	1,4	☺	☺	☺	☺
NTS-ER/L-16 013UN	13	16	9,525	1,2	1	1,3	☺	☺	☺	☺
NTS-ER/L-16 014UN	14	16	9,525	1,11	1	1,2	☺	☺	☺	☺
NTS-ER/L-16 016UN	16	16	9,525	0,97	0,9	1,1	☺	☺	☺	☺
NTS-ER/L-16 018UN	18	16	9,525	0,87	0,8	1	☺	☺	☺	☺
NTS-ER/L-16 020UN	20	16	9,525	0,78	0,8	0,9	☺	☺	☺	☺
NTS-ER/L-16 024UN	24	16	9,525	0,65	0,7	0,8	☺	☺	☺	☺
NTS-ER/L-16 027UN	27	16	9,525	0,58	0,7	0,8	☺	☺	☺	☺
NTS-ER/L-16 028UN	28	16	9,525	0,56	0,6	0,7	☺	☺	☺	☺
NTS-ER/L-16 032UN	32	16	9,525	0,49	0,6	0,6	☺	☺	☺	☺
NTS-ER/L-16 036UN	36	16	9,525	0,43	0,6	0,6	☺	☺	☺	☺
NTS-ER/L-16 040UN	40	16	9,525	0,39	0,6	0,6	☺	☺	☺	☺
NTS-ER/L-16 044UN	44	16	9,525	0,35	0,6	0,6	☺	☺	☺	☺
NTS-ER/L-16 048UN	48	16	9,525	0,32	0,6	0,6	☺	☺	☺	☺
NTS-ER/L-22 005UN	5	22	12,7	3,12	1,7	2,5	☺	☺	☺	☺
NTS-ER/L-22 006UN	6	22	12,7	2,6	1,6	2,3	☺	☺	☺	☺
NTS-ER/L-22 007UN	7	22	12,7	2,22	1,6	2,3	☺	☺	☺	☺

HC = Coated carbide

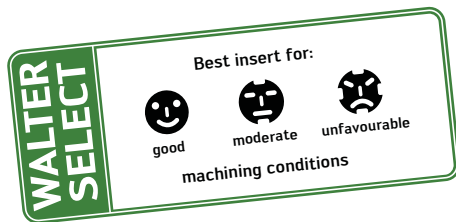

Walter NTS threading inserts

Full profile, American UN 60°

Internal thread

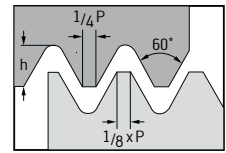
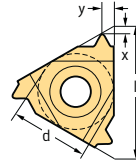

Indexable inserts

Designation	Lead (TPI)	l mm	d mm	h _{min} mm	X mm	Y mm	P		M	
							HC		HC	
							WXP20	WMP32	WXM20	WMP32
NTS-IR/L-11 11UN	11	11	6,35	1,33	0,8	1,1	☺	☺	☺	☺
NTS-IR/L-11 12UN	12	11	6,35	1,22	0,8	1,1	☺	☺	☺	☺
NTS-IR/L-11 14UN	14	11	6,35	1,05	0,9	1,1	☺	☺	☺	☺
NTS-IR/L-11 16UN	16	11	6,35	0,92	0,9	1,1	☺	☺	☺	☺
NTS-IR/L-11 18UN	18	11	6,35	0,81	0,8	1	☺	☺	☺	☺
NTS-IR/L-11 20UN	20	11	6,35	0,73	0,8	0,9	☺	☺	☺	☺
NTS-IR/L-11 24UN	24	11	6,35	0,61	0,7	0,8	☺	☺	☺	☺
NTS-IR/L-11 27UN	27	11	6,35	0,54	0,7	0,8	☺	☺	☺	☺
NTS-IR/L-11 28UN	28	11	6,35	0,52	0,6	0,7	☺	☺	☺	☺
NTS-IR/L-11 32UN	32	11	6,35	0,46	0,6	0,6	☺	☺	☺	☺
NTS-IR/L-11 36UN	36	11	6,35	0,41	0,6	0,6	☺	☺	☺	☺
NTS-IR/L-11 40UN	40	11	6,35	0,37	0,6	0,6	☺	☺	☺	☺
NTS-IR/L-11 56UN	56	11	6,35	0,26	0,7	0,4	☺	☺	☺	☺
NTS-IR/L-11 64UN	64	11	6,35	0,23	0,8	0,4	☺	☺	☺	☺
NTS-IR/L-16 008UN	8	16	9,525	1,83	1,1	1,5	☺	☺	☺	☺
NTS-IR/L-16 009UN	9	16	9,525	1,63	1,2	1,7	☺	☺	☺	☺
NTS-IR/L-16 010UN	10	16	9,525	1,47	1,1	1,5	☺	☺	☺	☺
NTS-IR/L-16 011UN	11	16	9,525	1,33	1,1	1,5	☺	☺	☺	☺
NTS-IR/L-16 012UN	12	16	9,525	1,22	1,1	1,4	☺	☺	☺	☺
NTS-IR/L-16 013UN	13	16	9,525	1,13	1	1,3	☺	☺	☺	☺
NTS-IR/L-16 014UN	14	16	9,525	1,05	0,9	1,2	☺	☺	☺	☺
NTS-IR/L-16 016UN	16	16	9,525	0,92	0,9	1,1	☺	☺	☺	☺
NTS-IR/L-16 018UN	18	16	9,525	0,81	0,8	1	☺	☺	☺	☺
NTS-IR/L-16 020UN	20	16	9,525	0,73	0,8	0,9	☺	☺	☺	☺
NTS-IR/L-16 024UN	24	16	9,525	0,61	0,7	0,8	☺	☺	☺	☺
NTS-IR/L-16 027UN	27	16	9,525	0,54	0,7	0,8	☺	☺	☺	☺
NTS-IR/L-16 028UN	28	16	9,525	0,52	0,6	0,7	☺	☺	☺	☺
NTS-IR/L-16 032UN	32	16	9,525	0,51	0,6	0,6	☺	☺	☺	☺
NTS-IR/L-16 036UN	36	16	9,525	0,41	0,6	0,6	☺	☺	☺	☺
NTS-IR/L-16 040UN	40	16	9,525	0,37	0,6	0,6	☺	☺	☺	☺
NTS-IR/L-16 044UN	44	16	9,525	0,33	0,6	0,6	☺	☺	☺	☺
NTS-IR/L-16 048UN	48	16	9,525	0,31	0,6	0,6	☺	☺	☺	☺
NTS-IR/L-22 005UN	5	22	12,7	2,93	1,6	2,3	☺	☺	☺	☺
NTS-IR/L-22 006UN	6	22	12,7	2,44	1,6	2,3	☺	☺	☺	☺
NTS-IR/L-22 007UN	7	22	12,7	2,09	1,6	2,3	☺	☺	☺	☺

HC = Coated carbide

Walter NTS threading inserts

Full profile, American UNJ 60°

External thread

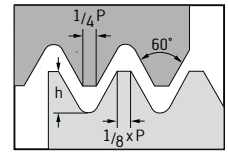
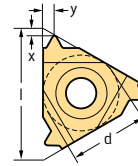

Indexable inserts

Designation	Lead (TPI)	l mm	d mm	h _{min} mm	X mm	Y mm	P		M	
							HC		HC	
							WXP20	WMP32	WXM20	WMP32
NTS-ER/L-16 8UNJ	8	16	9,525	1,83	1,2	1,6	☺	☺	☺	☺
NTS-ER/L-16 9UNJ	9	16	9,525	1,63	1,3	1,7	☺	☺	☺	☺
NTS-ER/L-16 10UNJ	10	16	9,525	1,47	1,2	1,5	☺	☺	☺	☺
NTS-ER/L-16 11UNJ	11	16	9,525	1,33	1,2	1,5	☺	☺	☺	☺
NTS-ER/L-16 12UNJ	12	16	9,525	1,22	1,1	1,3	☺	☺	☺	☺
NTS-ER/L-16 13UNJ	13	16	9,525	1,13	1	1,3	☺	☺	☺	☺
NTS-ER/L-16 14UNJ	14	16	9,525	1,05	1	1,2	☺	☺	☺	☺
NTS-ER/L-16 16UNJ	16	16	9,525	0,92	0,9	1,1	☺	☺	☺	☺
NTS-ER/L-16 18UNJ	18	16	9,525	0,81	0,8	1	☺	☺	☺	☺
NTS-ER/L-16 20UNJ	20	16	9,525	0,73	0,8	0,9	☺	☺	☺	☺
NTS-ER/L-16 24UNJ	24	16	9,525	0,61	0,7	0,8	☺	☺	☺	☺
NTS-ER/L-16 28UNJ	28	16	9,525	0,52	0,7	0,7	☺	☺	☺	☺
NTS-ER/L-16 32UNJ	32	16	9,525	0,46	0,6	0,7	☺	☺	☺	☺
NTS-ER/L-16 36UNJ	36	16	9,525	0,41	0,6	0,6	☺	☺	☺	☺
NTS-ER/L-16 40UNJ	40	16	9,525	0,37	0,6	0,6	☺	☺	☺	☺
NTS-ER/L-16 44UNJ	44	16	9,525	0,33	0,6	0,6	☺	☺	☺	☺
NTS-ER/L-16 48UNJ	48	16	9,525	0,31	0,6	0,5	☺	☺	☺	☺
NTS-ER/L-22 5UNJ	5	22	12,7	2,93	1,8	2,5	☺	☺	☺	☺
NTS-ER/L-22 6UNJ	6	22	12,7	2,44	1,7	2,3	☺	☺	☺	☺
NTS-ER/L-22 7UNJ	7	22	12,7	2,09	1,7	2,3	☺	☺	☺	☺

HC = Coated carbide

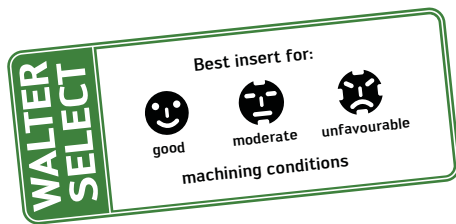

Walter NTS threading inserts

Full profile, American UNJ 60°

Internal thread

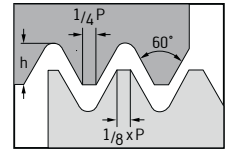
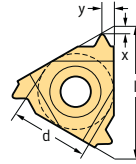

Indexable inserts

Designation	Lead (TPI)	l mm	d mm	h _{min} mm	X mm	Y mm	P		M	
							HC		HC	
							WXP20	WMP32	WXM20	WMP32
NTS-IR/L-11 14UNJ	14	11	6,35	0,95	1	1,2	☺	☺	☺	☺
NTS-IR/L-11 16UNJ	16	11	6,35	0,83	0,9	0,1	☺	☺	☺	☺
NTS-IR/L-11 18UNJ	18	11	6,35	0,74	0,8	1	☺	☺	☺	☺
NTS-IR/L-11 20UNJ	20	11	6,35	0,66	0,8	0,9	☺	☺	☺	☺
NTS-IR/L-11 24UNJ	24	11	6,35	0,55	0,7	0,8	☺	☺	☺	☺
NTS-IR/L-11 28UNJ	28	11	6,35	0,47	0,7	0,7	☺	☺	☺	☺
NTS-IR/L-16 8UNJ	8	16	9,525	1,66	1,2	1,6	☺	☺	☺	☺
NTS-IR/L-16 9UNJ	9	16	9,525	1,48	1,3	1,7	☺	☺	☺	☺
NTS-IR/L-16 10UNJ	10	16	9,525	1,33	1,2	1,5	☺	☺	☺	☺
NTS-IR/L-16 11UNJ	11	16	9,525	1,21	1,2	1,5	☺	☺	☺	☺
NTS-IR/L-16 12UNJ	12	16	9,525	1,11	1,1	1,3	☺	☺	☺	☺
NTS-IR/L-16 13UNJ	13	16	9,525	1,02	1	1,3	☺	☺	☺	☺
NTS-IR/L-16 14UNJ	14	16	9,525	0,95	1	1,2	☺	☺	☺	☺
NTS-IR/L-16 16UNJ	16	16	9,525	0,83	0,9	1,1	☺	☺	☺	☺
NTS-IR/L-16 18UNJ	18	16	9,525	0,74	0,8	1	☺	☺	☺	☺
NTS-IR/L-16 20UNJ	20	16	9,525	0,66	0,8	0,9	☺	☺	☺	☺
NTS-IR/L-16 24UNJ	24	16	9,525	0,55	0,7	0,8	☺	☺	☺	☺
NTS-IR/L-16 28UNJ	28	16	9,525	0,47	0,7	0,7	☺	☺	☺	☺
NTS-IR/L-16 32UNJ	32	16	9,525	0,42	0,6	0,7	☺	☺	☺	☺
NTS-IR/L-16 36UNJ	36	16	9,525	0,37	0,6	0,6	☺	☺	☺	☺
NTS-IR/L-16 40UNJ	40	16	9,525	0,33	0,6	0,6	☺	☺	☺	☺
NTS-IR/L-16 44UNJ	44	16	9,525	0,3	0,6	0,6	☺	☺	☺	☺
NTS-IR/L-16 48UNJ	48	16	9,525	0,28	0,6	0,5	☺	☺	☺	☺
NTS-IR/L-22 5UNJ	5	22	12,7	2,66	1,8	2,5	☺	☺	☺	☺
NTS-IR/L-22 6UNJ	6	22	12,7	2,21	1,7	2,3	☺	☺	☺	☺
NTS-IR/L-22 7UNJ	7	22	12,7	1,9	1,7	2,3	☺	☺	☺	☺

HC = Coated carbide

Walter NTS threading inserts

Solid profile, Whitworth

External thread

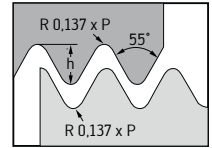
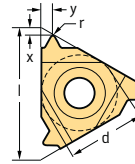

Indexable inserts

Designation	Lead (TPI)	l mm	d mm	h _{min} mm	X mm	Y mm	P		M	
							HC		HC	
							WXP20	WMP32	WXM20	WMP32
NTS-ER/L-16 008W	8	16	9,525	2,03	1,2	1,5	☺	☺	☺	☺
NTS-ER/L-16 009W	9	16	9,525	1,81	1,2	1,7	☺	☺	☺	☺
NTS-ER/L-16 010W	10	16	9,525	1,63	1,1	1,5	☺	☺	☺	☺
NTS-ER/L-16 011W	11	16	9,525	1,48	1,1	1,5	☺	☺	☺	☺
NTS-ER/L-16 012W	12	16	9,525	1,36	1,1	1,4	☺	☺	☺	☺
NTS-ER/L-16 014W	14	16	9,525	1,16	1	1,2	☺	☺	☺	☺
NTS-ER/L-16 016W	16	16	9,525	1,02	0,9	1,1	☺	☺	☺	☺
NTS-ER/L-16 018W	18	16	9,525	0,9	0,8	1	☺	☺	☺	☺
NTS-ER/L-16 019W	19	16	9,525	0,86	0,8	1	☺	☺	☺	☺
NTS-ER/L-16 020W	20	16	9,525	0,81	0,8	0,9	☺	☺	☺	☺
NTS-ER/L-16 022W	22	16	9,525	0,74	0,8	0,9	☺	☺	☺	☺
NTS-ER/L-16 024W	24	16	9,525	0,68	0,7	0,8	☺	☺	☺	☺
NTS-ER/L-16 026W	26	16	9,525	0,63	0,7	0,8	☺	☺	☺	☺
NTS-ER/L-16 028W	28	16	9,525	0,58	0,6	0,7	☺	☺	☺	☺
NTS-ER/L-16 032W	32	16	9,525	0,51	0,6	0,6	☺	☺	☺	☺
NTS-ER/L-16 036W	36	16	9,525	0,45	0,6	0,6	☺	☺	☺	☺
NTS-ER/L-16 040W	40	16	9,525	0,41	0,6	0,6	☺	☺	☺	☺
NTS-ER/L-16 048W	48	16	9,525	0,34	0,6	0,6	☺	☺	☺	☺
NTS-ER/L-22 005W	5	22	12,7	3,25	1,7	2,4	☺	☺	☺	☺
NTS-ER/L-22 006W	6	22	12,7	2,71	1,6	2,3	☺	☺	☺	☺
NTS-ER/L-22 007W	7	22	12,7	2,32	1,6	2,3	☺	☺	☺	☺

HC = Coated carbide

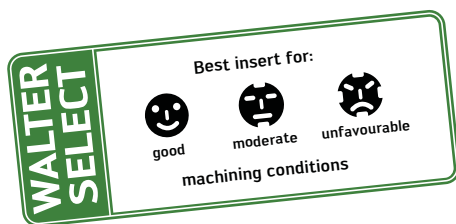

Walter NTS threading inserts

Solid profile, Whitworth

Internal thread

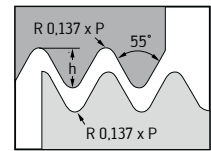
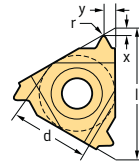

Indexable inserts

Designation	Lead (TPI)	l mm	d mm	h _{min} mm	X mm	Y mm	P		M	
							HC		HC	
							WXP20	WMP32	WXM20	WMP32
NTS-IR/L-11 12W	12	11	6,35	1,32	0,9	1,2	☺	☺	☺	☺
NTS-IR/L-11 14W	14	11	6,35	1,16	0,9	1,1	☺	☺	☺	☺
NTS-IR/L-11 16W	16	11	6,35	1,02	0,9	1,1	☺	☺	☺	☺
NTS-IR/L-11 18W	18	11	6,35	0,9	0,8	1	☺	☺	☺	☺
NTS-IR/L-11 19W	19	11	6,35	0,86	0,8	1	☺	☺	☺	☺
NTS-IR/L-11 20W	20	11	6,35	0,81	0,8	0,9	☺	☺	☺	☺
NTS-IR/L-11 22W	22	11	6,35	0,74	0,8	0,9	☺	☺	☺	☺
NTS-IR/L-11 24W	24	11	6,35	0,68	0,7	0,8	☺	☺	☺	☺
NTS-IR/L-11 26W	26	11	6,35	0,63	0,7	0,8	☺	☺	☺	☺
NTS-IR/L-11 32W	32	11	6,35	0,51	0,6	0,6	☺	☺	☺	☺
NTS-IR/L-11 36W	36	11	6,35	0,45	0,6	0,6	☺	☺	☺	☺
NTS-IR/L-11 48W	48	11	6,35	0,34	0,6	0,6	☺	☺	☺	☺
NTS-IR/L-16 008W	8	16	9,525	2,03	1,2	1,5	☺	☺	☺	☺
NTS-IR/L-16 009W	9	16	9,525	1,81	1,2	1,7	☺	☺	☺	☺
NTS-IR/L-16 010W	10	16	9,525	1,63	1,1	1,5	☺	☺	☺	☺
NTS-IR/L-16 011W	11	16	9,525	1,48	1,1	1,5	☺	☺	☺	☺
NTS-IR/L-16 012W	12	16	9,525	1,36	1,1	1,4	☺	☺	☺	☺
NTS-IR/L-16 014W	14	16	9,525	1,16	1	1,2	☺	☺	☺	☺
NTS-IR/L-16 016W	16	16	9,525	1,02	0,9	1,1	☺	☺	☺	☺
NTS-IR/L-16 018W	18	16	9,525	0,9	0,8	1	☺	☺	☺	☺
NTS-IR/L-16 019W	19	16	9,525	0,86	0,8	1	☺	☺	☺	☺
NTS-IR/L-16 020W	20	16	9,525	0,81	0,8	0,9	☺	☺	☺	☺
NTS-IR/L-16 022W	22	16	9,525	0,74	0,8	0,9	☺	☺	☺	☺
NTS-IR/L-16 024W	24	16	9,525	0,68	0,7	0,8	☺	☺	☺	☺
NTS-IR/L-16 026W	26	16	9,525	0,63	0,7	0,8	☺	☺	☺	☺
NTS-IR/L-16 028W	28	16	9,525	0,58	0,6	0,7	☺	☺	☺	☺
NTS-IR/L-16 032W	32	16	9,525	0,51	0,6	0,6	☺	☺	☺	☺
NTS-IR/L-16 036W	36	16	9,525	0,45	0,6	0,6	☺	☺	☺	☺
NTS-IR/L-16 040W	40	16	9,525	0,41	0,6	0,6	☺	☺	☺	☺
NTS-IR/L-16 048W	48	16	9,525	0,34	0,6	0,6	☺	☺	☺	☺
NTS-IR/L-22 005W	5	22	12,7	3,25	1,7	2,4	☺	☺	☺	☺
NTS-IR/L-22 006W	6	22	12,7	2,71	1,6	2,3	☺	☺	☺	☺
NTS-IR/L-22 007W	7	22	12,7	2,32	1,6	2,3	☺	☺	☺	☺

HC = Coated carbide

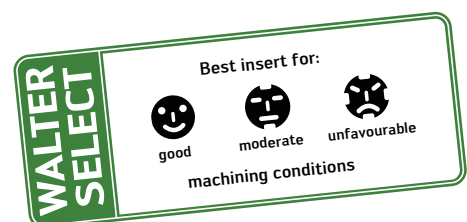

Walter NTS threading inserts Partial profile 60° External thread

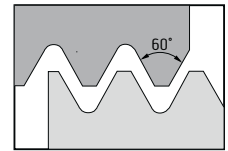
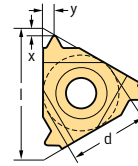

Indexable inserts

Designation	Lead (P) mm	Lead (TPI)	l mm	d mm	r mm	X mm	Y mm	P		M	
								HC		HC	
								WXP20	WMP32	WXM20	WMP32
 NTS-ER/L-16 AG60 NTS-ER/L-16 G60 NTS-ER/L-22 N60	0,50 - 3,0	8,0 - 48,0	16	9,525	0,08	1,2	1,7	☺	☺	☹	☹
	1,75 - 3,0	8,0 - 14,0	16	9,525	0,27	1,2	1,7	☺	☺	☹	☹
	3,50 - 5,0	5,0 - 7,0	22	12,7	0,53	1,7	2,5	☺	☺	☹	☹

HC = Coated carbide

Walter NTS threading inserts Partial profile 60° Internal thread

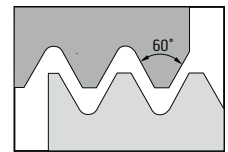
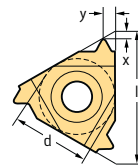

Indexable inserts

Designation	Lead (P) mm	Lead (TPI)	l mm	d mm	r mm	X mm	Y mm	P		M	
								HC		HC	
								WXP20	WMP32	WXM20	WMP32
 NTS-IR/L-11 A60 NTS-IR/L-16 AG60 NTS-IR/L-16 G60 NTS-IR/L-22 N60	0,50 - 1,5	16,0 - 48,0	11	6,35	0,05	0,8	0,9	☹	☹	☹	☹
	0,50 - 3,0	8,0 - 48,0	16	9,525	0,05	1,2	1,7	☺	☺	☹	☹
	1,75 - 3,0	8,0 - 14,0	16	9,525	0,16	1,2	1,7	☺	☺	☹	☹
	3,50 - 5,0	5,0 - 7,0	22	12,7	0,53	1,7	2,5	☺	☺	☹	☹

HC = Coated carbide

Walter NTS threading inserts Partial profile 55° Internal thread

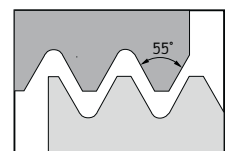
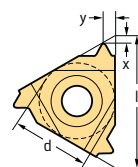

Indexable inserts

Designation	Lead (P) mm	Lead (TPI)	l mm	d mm	r mm	X mm	Y mm	P		M	
								HC		HC	
								WXP20	WMP32	WXM20	WMP32
 NTS-IR/L-11 A55	0,50 - 1,5	16,0 - 48,0	11	6,35	0,05	0,8	0,9	☹	☹	☹	☹

HC = Coated carbide

System overview of Walter Turn / Walter Capto™ – external machining

External toolholder for indexable inserts with a negative basic shape



Walter Turn rigid clamping system (D)

- The number one choice for machining short-chipping material such as cast iron
- Functionality is also maintained in "dirty environments", e.g. chilled cast iron machining
- The number one choice with interrupted cuts thanks to extremely stable insert clamping
- Indexable insert and shim replaced using the same wrench
- Reinforced top clamp with carbide shoe for longer top clamp service life



Walter Turn lever-type clamping (P)

- Universal system with easy indexable insert replacement
- The number one choice for single-sided negative inserts, e.g. SNMM for heavy roughing
- Unobstructed chip evacuation and usable as an alternative to the rigid clamping system



Walter Turn wedge-type clamping system (M)

- For indexable inserts with a negative T basic shape
- Profiling is possible up to an angle of 22° with TNMG indexable inserts
- Insert that is frequently used when shaft machining with undercuts



External toolholder for indexable inserts with a positive basic shape

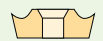

Walter Turn screw clamping (S)

- For indexable inserts with positive basic shape with clearance angle of 5° and 7°
- The number one choice for use with low cutting pressures / small diameter shafts
- Fewer assembly parts are needed
- Torx Plus screw clamping for transmitting higher tightening torques
- Indexable insert and shim replaced using the same wrench











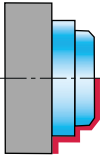



Walter Turn positive lever type clamping (P)

- For indexable inserts with positive V/R basic shape with clearance angle of 5° and 7°
- A high degree of shape accuracy is achieved on the component because of the large amount of pre-tension via the knee lever with V inserts
- No danger of the clamping screw slackening during machining because of round insert distortion

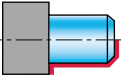
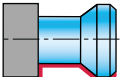

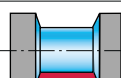
Walter Select – external machining

Workpiece characteristics	short, stable 			long, unstable 	
Basic shape	 Negative basic shape			 Positive basic shape	
Holder clamping system Walter Turn / Walter Capto™	Rigid clamping system 	Lever clamping 	Wedge-type clamping system 	Screw clamping 	Lever clamping 
Product range overview	Page A 78	Page A 79	Page A 79	Page A 80	Page A 80
Step 1: selection of the contour to be machined					
 Longitudinal turning / facing	••	••	•	••	••
 Profile turning	••	••	••	••	••
 Facing	••	••	—	••	••
 Necking	••	•	—	•	••
 Interrupted cuts	••	•	•	••	•
Step 2: selection of the material to be machined					
P Steel	••	••	••	••	••
M Stainless steel	•	••	••	••	••
K Cast iron	••	•	•	••	•
N NF metals	—	•	—	••	••
S Difficult-to-machine materials	••	••	•	••	••
H Hard materials	••	•	•	•	•
O Other	—	•	—	•	•

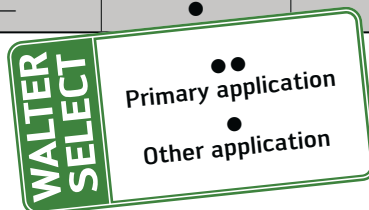

Product range overview of Walter Turn tools

External machining – negative basic shape



Rigid-clamping system

For Walter Select, see page A 77



<p>95°</p> <p>DCLN R/L</p> <p>h = 16–32 mm</p> <p>Shank tools: Page A 84 Page A 122</p>	<p>107°30'</p> <p>DDHN R/L</p> <p>h = 20–25 mm</p> <p>Shank tools: Page A 88</p>	<p>45°</p> <p>DSDN N</p> <p>h = 20–32 mm</p> <p>Shank tools: Page A 91 Page A 126</p>	<p>93°</p> <p>DVJN R/L</p> <p>h = 20–32 mm</p> <p>Shank tools: Page A 95 Page A 129</p>
<p>75°</p> <p>DCBN R/L</p> <p>h = 25–32 mm</p> <p>Shank tools: Page A 85</p>	<p>62°30'</p> <p>DDNN N</p> <p>h = 20–32 mm</p> <p>Shank tools: Page A 89</p>	<p>75°</p> <p>DSBN / DSRN R/L</p> <p>h = 25–40 mm</p> <p>Shank tools: Page A 92 Page A 127</p>	<p>72°30'</p> <p>DVNN N</p> <p>h = 20–32 mm</p> <p>Shank tools: Page A 95</p>
<p>75°</p> <p>DCKN R/L</p> <p>h = 25–32 mm</p> <p>Shank tools: Page A 86</p>	<p>93°</p> <p>DDUN R/L</p> <p>h = 20–32 mm</p> <p>Shank tools: Page A 124</p>	<p>75°</p> <p>DSKN R/L</p> <p>h = 25–32 mm</p> <p>Shank tools: Page A 93 Page A 128</p>	<p>95°</p> <p>DWLN R/L</p> <p>h = 20–32 mm</p> <p>Shank tools: Page A 96 Page A 130</p>
<p>93°</p> <p>DDJN R/L</p> <p>h = 20–32 mm</p> <p>Shank tools: Page A 87 Page A 123</p>	<p>45°</p> <p>DSSN R/L</p> <p>h = 20–32 mm</p> <p>Shank tools: Page A 90 Page A 125</p>	<p>91°</p> <p>DTGN R/L</p> <p>h = 20–32 mm</p> <p>Shank tools: Page A 94</p>	

Lever-type clamping system

For Walter Select, see page A 77



Wedge-type clamping system



<p>95°</p> <p>PCLN R/L</p> <p>h = 16–50 mm</p> <p>Shank tools: Page A 97 Page A 131</p>	<p>93°</p> <p>PDJN R/L</p> <p>h = 16–32 mm</p> <p>Shank tools: Page A 100 Page A 132</p>	<p>75°</p> <p>PSKN R/L</p> <p>h = 20–25 mm</p> <p>Shank tools: Page A 104 Page A 135</p>	<p>93°</p> <p>MTJN R/L</p> <p>h = 20–32 mm</p> <p>Shank tools: Page A 106 Page A 136</p>
<p>75°</p> <p>PCBN R/L</p> <p>h = 25–32 mm</p> <p>Shank tools: Page A 98</p>	<p>45°</p> <p>PSSN R/L</p> <p>h = 20–32 mm</p> <p>Shank tools: Page A 101 Page A 133</p>	<p>91°</p> <p>PTGN R/L</p> <p>h = 16–40 mm</p> <p>Shank tools: Page A 105</p>	
<p>75°</p> <p>PCKN R/L</p> <p>h = 25 mm</p> <p>Shank tools: Page A 99</p>	<p>45°</p> <p>PSDN N</p> <p>h = 20–40 mm</p> <p>Shank tools: Page A 102</p>	<p>91°</p> <p>PTFN R/L</p> <p>h = 20–32 mm</p> <p>Shank tools: Page A 105</p>	
<p>45°</p> <p>PCSN R/L</p> <p>h = 25 mm</p> <p>Shank tools: Page A 99</p>	<p>75°</p> <p>PSBN / PSRN R/L</p> <p>h = 20–50 mm</p> <p>Shank tools: Page A 103 Page A 134</p>	<p>95°</p> <p>PWLN R/L</p> <p>h = 16–32 mm</p> <p>Shank tools: Page A 107 Page A 137</p>	

Product range overview of Walter Turn tools

External machining – positive basic shape



Screw clamping system / lever-type clamping system



For Walter Select, see page A 77

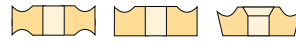

<p>95°</p> <p>SCLC R/L</p> <p>h = 10–25 mm</p> <p>Shank tools: Page A 108 Page A 138</p>	<p>SRSC R/L</p> <p>h = 20–40 mm</p> <p>Shank tools: Page A 113 Page A 142</p>	<p>45°</p> <p>SSDC N</p> <p>h = 12–25 mm</p> <p>Shank tools: Page A 115</p>	<p>107°30'</p> <p>SVHB / PVHB* R/L</p> <p>h = 16–32 mm</p> <p>Shank tools: Page A 117-118 Page A 146-147</p>
<p>93°</p> <p>SDJC R/L</p> <p>h = 10–25 mm</p> <p>Shank tools: Page A 109 Page A 139</p>	<p>PRGC* / PRSC* R/L</p> <p>h = 20–40 mm</p> <p>Shank tools: Page A 114 Page A 143</p>	<p>75°</p> <p>SSBC / SSRC R/L</p> <p>h = 12–25 mm</p> <p>Shank tools: Page A 115 Page A 144</p>	<p>72°30'</p> <p>SVVB / PVVB* N</p> <p>h = 12–32 mm</p> <p>Shank tools: Page A 119-120 Page A 148-149</p>
<p>107°30'</p> <p>SDHC R/L</p> <p>h = 12–25 mm</p> <p>Shank tools: Page A 109</p>	<p>SRDC / PRDC* N</p> <p>h = 12–50 mm</p> <p>Shank tools: Page A 111-112 Page A 140-144</p>	<p>91°</p> <p>STGC R/L</p> <p>h = 12–25 mm</p> <p>Shank tools: Page A 116 Page A 145</p>	<p>95°</p> <p>SWLC R/L</p> <p>h = 12–25 mm</p> <p>Shank tools: Page A 121 Page A 150</p>
<p>62°30'</p> <p>SDNC N</p> <p>Shank tools: Page A 110 Page A 139</p>	<p>45°</p> <p>SSDC R/L</p> <p>h = 16–25 mm</p> <p>Shank tools: Page A 115</p>	<p>93°</p> <p>SVJB / PVJB* R/L</p> <p>h = 12–32 mm</p> <p>Shank tools: Page A 117-118 Page A 146-147</p>	<p>* Walter Turn positive lever type clamping</p>

Product range overview of Walter Turn 45° Toolholders for turning/milling centres

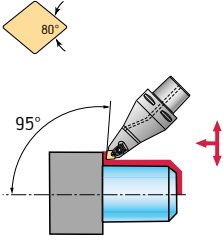
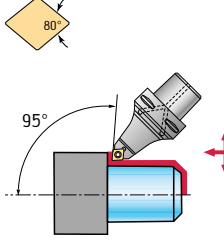
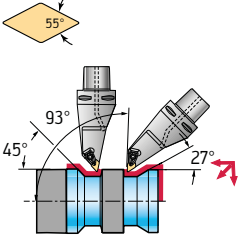
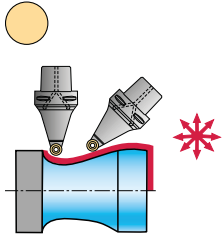
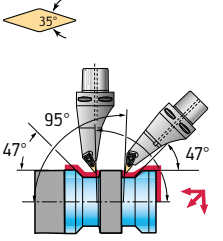
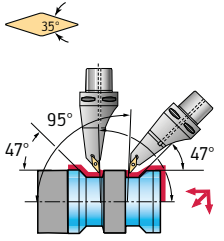

Rigid-clamping system	Screw clamping system
<p>Negative basic shape</p>  <p>Walter Capto™</p>	<p>Positive basic shape</p>  <p>Walter Capto™</p>
<p>95° DCMN N R/L</p>  <p>Walter Capto™ Page A 151</p>	<p>95° SCMC N</p>  <p>Walter Capto™ Page A 154</p>
<p>93° DDMN L R/L</p>  <p>Walter Capto™ Page A 152</p>	<p>SRDC N</p>  <p>Walter Capto™ Page A 155</p>
<p>95° DVMN L</p>  <p>Walter Capto™ Page A 153</p>	<p>95° SVMB L</p>  <p>Walter Capto™ Page A 156</p>

ISO designation key for turning toolholders – external machining

Example of Walter Turn

P	W	L	N	R	25	25	M	08
1	2	3	4	5	6	7	8	9

0
Coupling size d_1 [mm]
C = Walter Capto™ ISO 26623 C3 $d_1 = 32$ C4 $d_1 = 40$ C5 $d_1 = 50$ C6 $d_1 = 63$ C8 $d_1 = 80$

1
Type of insert mounting
C Top clamping D Top and hole clamping M Top and hole clamping P Hole clamping S Screw clamping

2
Basic shape of indexable insert
C D R S T V W

5
Orientation of turning toolholder
R L N

6
Turning toolholder height h_1 [mm]
The height of the cutting edge h_1 , is shown in mm. Figures after the decimal point are ignored. Integers are preceded by a "0" Example: $h_1 = 8 \text{ mm} = 08$.

7
Holder width b or f dimension [mm]
Shank width b in mm. Figures after the decimal point are ignored. Integers are preceded by a "0" Example: $b = 8 \text{ mm} = 08$. For cartridges CA.



Example of Walter Capto™

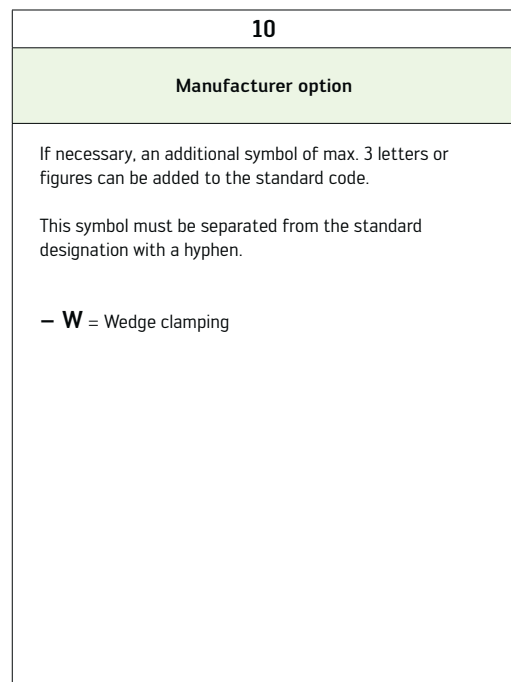
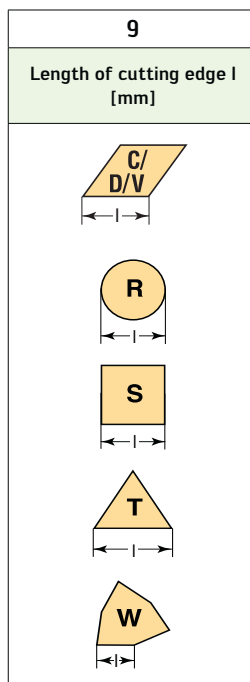
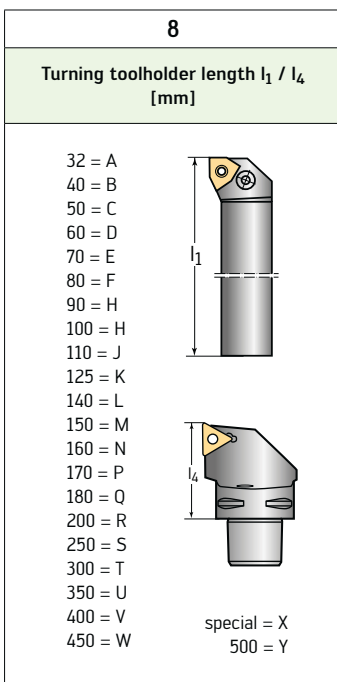
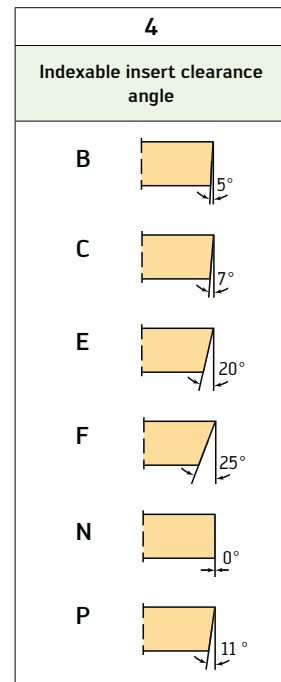
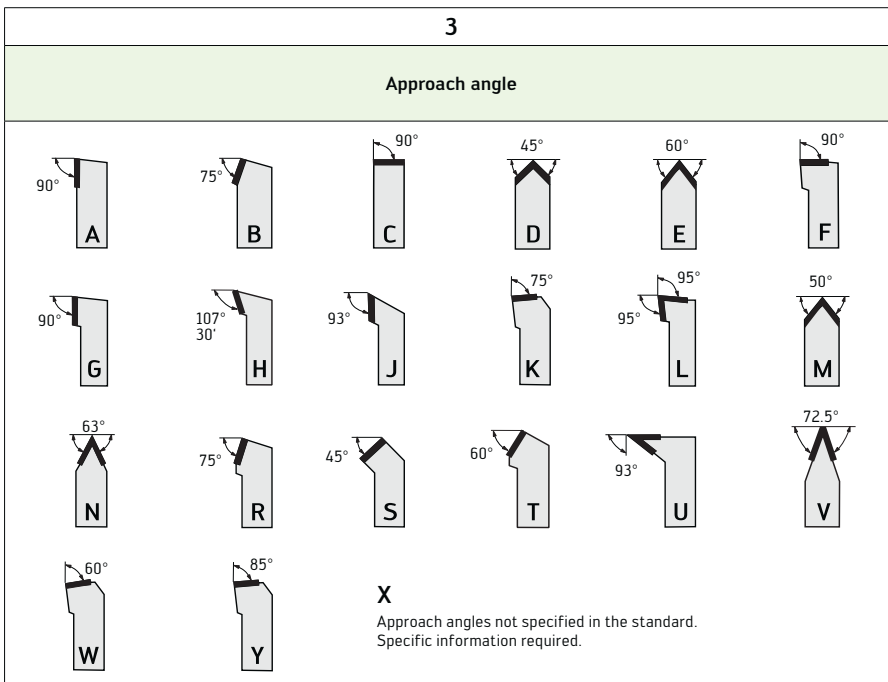
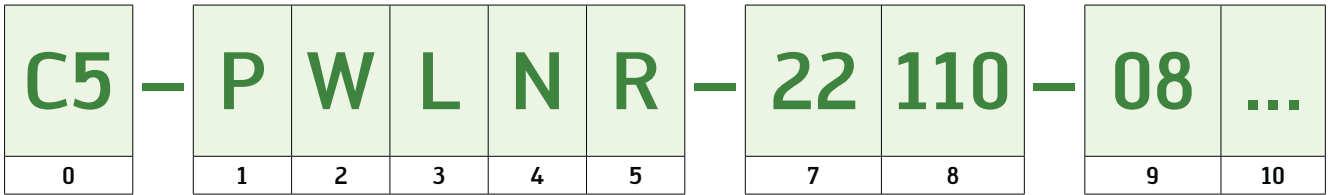

Walter Turn DCLN

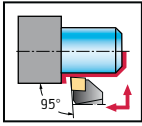

- negative toolholder range
- external machining
- rigid clamping system

Tool	Designation		h = h ₁ mm	b mm	f mm	l ₁ mm	l ₄ mm	γ	λ _s	Type
κ = 95°	DCLNR/L1616H12		12	16	20	100	32,2	-6°	-6°	CN .. 1204 ..
	DCLNR/L2020K12		12	20	25	125	32,1	-6°	-6°	
	DCLNR/L2525M12		12	25	32	150	32,1	-6°	-6°	
	DCLNR/L3225P12		12	32	32	170	32,1	-6°	-6°	
	DCLNR/L2525M16		16	25	32	150	39,1	-6°	-6°	CN .. 1606 ..
	DCLNR/L3225P16		16	32	32	170	39,1	-6°	-6°	
	DCLNR/L3232P16		16	32	40	170	39,1	-6°	-6°	CN .. 1906 ..
	DCLNR/L3232P19		19	32	40	170	43,5	-6°	-6°	

Measured with master insert CN .. 120408 / CN .. 160612 / CN .. 190612.

For information on the rake angle γ (for indexable inserts without geometry) and on the inclination angle λ_s, see page A 301.

Bodies and assembly parts are included in the scope of delivery.

Assembly parts	Type h mm	CN .. 1204 .. 16	CN .. 1204 .. 20-32	CN .. 1606 .. 25-32	CN .. 1906 .. 32
	Shim	AP354-CN12	AP301-CN12	AP302-CN16	AP303-CN19
	Screw for shim	FS1461 (Torx 15IP)	FS1461 (Torx 15IP)	FS1463 (Torx 20IP)	FS1463 (Torx 20IP)
	Clamp	PK241	PK241	PK242	PK243
	Screw for clamp	FS1473 (Torx 15IP)	FS1473 (Torx 15IP)	FS1474 (Torx 20IP)	FS1474 (Torx 20IP)
	Tightening torque	3,9 Nm	3,9 Nm	6,4 Nm	6,4 Nm
	Pressure spring	FS1470	FS1470	FS1471	FS1471
	Pin	RS117	RS117	RS117	RS117
	Torx key	FS1465 (Torx 15IP/SW 3,5)	FS1465 (Torx 15IP/SW 3,5)	FS1464 (Torx 20IP)	FS1464 (Torx 20IP)

Accessories	Type h mm	CN .. 1204 .. 16-32	CN .. 1606 .. 25-32	CN .. 1906 .. 32
	Clamp set (standard mounting parts)	PK241-SET	PK242-SET	PK243-SET
	Clamp set with carbide clamping plate	PK245-SET	PK246-SET	

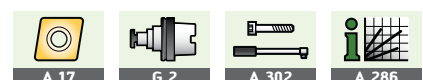

Walter Turn

DCBN

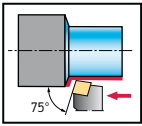

- negative toolholder range
- external machining
- rigid clamping system

Tool	Designation		h = h ₁ mm	b mm	f mm	l ₁ mm	l ₄ mm	γ	λ _s	Type	
											κ = 75°
	DCBNR/L2525M12		12	25	22	150	34,6	-6°	-6°	CN .. 1204 ..	
	DCBNR/L3225P12		12	32	22	170	34,6	-6°	-6°		
	DCBNR/L2525M16		16	25	22	150	41,5	-6°	-6°		CN .. 1606 ..
	DCBNR/L3232P16		16	32	27	170	41,6	-6°	-6°		
	DCBNR/L3232P19		19	32	27	170	46,1	-6°	-6°		CN .. 1906 ..

Measured with master insert CN .. 120408 / CN .. 160612 / CN .. 190612.

For information on the rake angle γ (for indexable inserts without geometry) and on the inclination angle λ_s, see page A 301.

Bodies and assembly parts are included in the scope of delivery.

Assembly parts	Type h mm	CN .. 1204 .. 25-32	CN .. 1606 .. 25-32	CN .. 1906 .. 32
	Shim	AP301-CN12	AP302-CN16	AP303-CN19
	Screw for shim	FS1461 (Torx 15IP)	FS1463 (Torx 20IP)	FS1463 (Torx 20IP)
	Clamp	PK241	PK242	PK243
	Screw for clamp Tightening torque	FS1473 (Torx 15IP) 3,9 Nm	FS1474 (Torx 20IP) 6,4 Nm	FS1474 (Torx 20IP) 6,4 Nm
	Pressure spring	FS1470	FS1471	FS1471
	Pin	RS117	RS117	RS117
	Torx key	FS1465 (Torx 15IP/SW 3,5)	FS1464 (Torx 20IP)	FS1464 (Torx 20IP)

Accessories	Type h mm	CN .. 1204 .. 25-32	CN .. 1606 .. 25-32	CN .. 1906 .. 32
	Clamp set (standard mounting parts)	PK241-SET	PK242-SET	PK243-SET
	Clamp set with carbide clamping plate	PK245-SET	PK246-SET	



Walter Turn DCKN

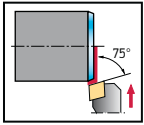

- negative toolholder range
- external machining
- rigid clamping system

Tool			$h = h_1$ mm	b mm	f mm	l_1 mm	l_4 mm	γ	λ_s	Type
$\kappa = 75^\circ$	DCKNR/L2525M12		12	25	32	150	21,1	-6°	-6°	CN .. 1204 ..
	DCKNR/L3225P12		12	32	32	170	21,1	-6°	-6°	
	DCKNR/L3232P16		16	32	40	170	26	-6°	-6°	CN .. 1606 ..

Measured with master insert CN .. 120408 / CN .. 160612.

For information on the rake angle γ (for indexable inserts without geometry) and on the inclination angle λ_s , see page A 301.

Bodies and assembly parts are included in the scope of delivery.

Assembly parts	Type h mm	CN .. 1204 .. 25-32	CN .. 1606 .. 32
	Shim	AP301-CN12	AP302-CN16
	Screw for shim	FS1461 (Torx 15IP)	FS1463 (Torx 20IP)
	Clamp	PK241	PK242
	Screw for clamp	FS1473 (Torx 15IP)	FS1474 (Torx 20IP)
	Tightening torque	3,9 Nm	6,4 Nm
	Pressure spring	FS1470	FS1471
	Pin	RS117	RS117
	Torx key	FS1465 (Torx 15IP/SW 3,5)	FS1464 (Torx 20IP)

Accessories	Type h mm	CN .. 1204 .. 25-32	CN .. 1606 .. 32
	Clamp set (standard mounting parts)	PK241-SET	PK242-SET
	Clamp set with carbide clamping plate	PK245-SET	PK246-SET

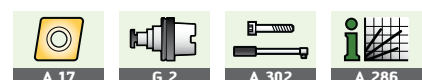

Walter Turn

DDJN

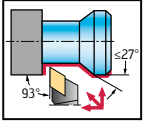

- negative toolholder range
- external machining
- rigid clamping system

Tool	Designation		h = h ₁ mm	b mm	f mm	l ₁ mm	l ₄ mm	γ	λ _s	Type
	DDJNR/L2020K11	11	20	20	25	125	30	-6°	-7°	DN .. 1104 ..
	DDJNR/L2525M11	11	25	25	32	150	30	-6°	-7°	
	DDJNR/L3225P11	11	32	25	32	170	30	-6°	-7°	
	DDJNR/L2020K15	15	20	20	25	125	39,5	-6°	-7°	DN .. 1506 ..
	DDJNR/L2525M15	15	25	25	32	150	39,5	-6°	-7°	
	DDJNR/L3225P15	15	32	25	32	170	39,5	-6°	-7°	
	DDJNR/L3232P15	15	32	32	40	170	39,5	-6°	-7°	

Measured with master insert DN .. 110408 / DN .. 150608.

For information on the rake angle γ (for indexable inserts without geometry) and on the inclination angle λ_s, see page A 301.

Bodies and assembly parts are included in the scope of delivery.

Assembly parts	Type h mm	DN .. 1104 .. 20-32	DN .. 1506 .. 20-32
	Shim	AP305-DN11	AP304-DN15
	Screw for shim	FS1462 (Torx 9IP)	FS1461 (Torx 15IP)
	Clamp	PK240	PK241
	Screw for clamp	FS1472 (Torx 9IP)	FS1473 (Torx 15IP)
	Tightening torque	1,7 Nm	3,9 Nm
	Pressure spring	FS1469	FS1470
	Pin	RS116	RS117
	Torx key	FS1466 (Torx 9IP)	FS1465 (Torx 15IP/SW 3,5)

Accessories	Type h mm	DN .. 1104 .. 20-32	DN .. 1506 .. 20-32
	Clamp set (standard mounting parts)	PK240-SET	PK241-SET
	Clamp set with carbide clamping plate		PK245-SET
	Shim		AP304-DN1504 DN .. 1504 ..



Walter Turn DDHN

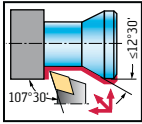

- negative toolholder range
- external machining
- rigid clamping system

Tool	Designation		h = h ₁ mm	b mm	f mm	l ₁ mm	l ₄ mm	γ	λ _s	Type
	DDHNR/L2020K15		15	20	25	125	36,1	-6°	-7°	DN .. 1506 ..
	DDHNR/L2525M15		15	25	32	150	36,1	-6°	-7°	

Measured with master insert DN .. 110408 / DN .. 150608.

For information on the rake angle γ (for indexable inserts without geometry) and on the inclination angle λ_s, see page A 301.

Bodies and assembly parts are included in the scope of delivery.

Assembly parts	Type h mm	DN .. 1506 .. 20-25
	Shim	AP304-DN15
	Screw for shim	FS1461 (Torx 15IP)
	Clamp	PK241
	Screw for clamp	FS1473 (Torx 15IP)
	Tightening torque	3,9 Nm
	Pressure spring	FS1470
	Pin	RS117
	Torx key	FS1465 (Torx 15IP/SW 3,5)

Accessories	Type h mm	DN .. 1506 .. 20-25
	Clamp set (standard mounting parts)	PK241-SET
	Clamp set with carbide clamping plate	PK245-SET
	Shim	AP304-DN1504 DN .. 1504 ..

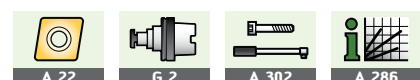

Walter Turn DDNN

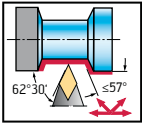

- negative toolholder range
- external machining
- rigid clamping system

Tool	Designation		h = h ₁ mm	b mm	f mm	l ₁ mm	l ₄ mm	γ	λ _s	Type
	DDNNN2020K11		11	20	10,5	125	31,2	-5°	-9°	DN . . 1104 . .
	DDNNN2525M11		11	25	13	150	31,2	-5°	-9°	DN . . 1506 . .
	DDNNN2525M15		15	25	13	150	40,8	-5°	-9°	
	DDNNN3225P15		15	32	13	170	40,8	-5°	-9°	

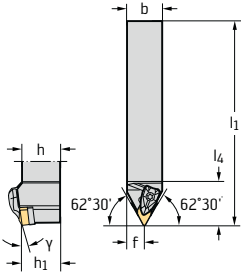

Measured with master insert DN . . 110408 / DN . . 150608.

For information on the rake angle γ (for indexable inserts without geometry) and on the inclination angle λ_s, see page A 301.

Bodies and assembly parts are included in the scope of delivery.

Assembly parts	Type h mm	DN . . 1104 . . 20-25	DN . . 1506 . . 25-32
	Shim	AP305-DN11	AP304-DN15
	Screw for shim	FS1462 (Torx 9IP)	FS1461 (Torx 15IP)
	Clamp	PK240	PK241
	Screw for clamp Tightening torque	FS1472 (Torx 9IP) 1,7 Nm	FS1473 (Torx 15IP) 3,9 Nm
	Pressure spring	FS1469	FS1470
	Pin	RS116	RS117
	Torx key	FS1466 (Torx 9IP)	FS1465 (Torx 15IP/SW 3,5)

Accessories	Type h mm	DN . . 1104 . . 20-25	DN . . 1506 . . 25-32
	Clamp set (standard mounting parts)	PK240-SET	PK241-SET
	Clamp set with carbide clamping plate		PK245-SET
	Shim		AP304-DN1504 DN . . 1504 . .



Walter Turn DSSN

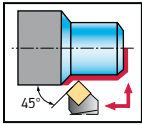

- negative toolholder range
- external machining
- rigid clamping system

Tool	Designation												Type
			h = h ₁ mm	b mm	f mm	f ₁ mm	l ₁ mm	l ₄ mm	l ₂₀ mm	γ	λ _s		
κ = 45°	DSSNR/L2020K12		12	20	20	25	16,7	125	37,1	133,3	-8°	0°	SN .. 1204 ..
	DSSNR/L2525M12		12	25	25	32	23,7	150	37,1	158,3	-8°	0°	
	DSSNR/L3225P12		12	32	25	32	23,7	170	37,1	178,3	-8°	0°	SN .. 1506 ..
	DSSNR/L2525M15		15	25	25	32	21,8	150	45,1	160,2	-8°	0°	
	DSSNR/L3225P15		15	32	25	32	21,8	170	45,1	180,2	-8°	0°	SN .. 1906 ..
	DSSNR/L3232P15		15	32	32	40	29,8	170	45,1	180,2	-8°	0°	
	DSSNR/L3232P19		19	32	32	40	27,5	170	49,5	182,5	-8°	0°	

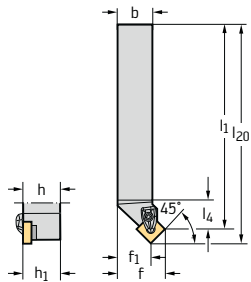

Measured with master insert SN .. 120408 / SN .. 150612 / SN .. 190612.

For information on the rake angle γ (for indexable inserts without geometry) and on the inclination angle λ_s, see page A 301.

Bodies and assembly parts are included in the scope of delivery.

Assembly parts	Type h mm	SN .. 1204 .. 20-32	SN .. 1506 .. 25-32	SN .. 1906 .. 32
	Shim	AP308-SN12	AP309-SN15	AP310-SN19
	Screw for shim	FS1461 (Torx 15IP)	FS1463 (Torx 20IP)	FS1463 (Torx 20IP)
	Clamp	PK241	PK242	PK243
	Screw for clamp	FS1473 (Torx 15IP)	FS1474 (Torx 20IP)	FS1474 (Torx 20IP)
	Tightening torque	3,9 Nm	6,4 Nm	6,4 Nm
	Pressure spring	FS1470	FS1471	FS1471
	Pin	RS117	RS117	RS117
	Torx key	FS1465 (Torx 15IP/SW 3,5)	FS1464 (Torx 20IP)	FS1464 (Torx 20IP)

Accessories	Type h mm	SN .. 1204 .. 20-32	SN .. 1506 .. 25-32	SN .. 1906 .. 32
	Clamp set (standard mounting parts)	PK241-SET	PK242-SET	PK243-SET
	Clamp set with carbide clamping plate	PK245-SET	PK246-SET	

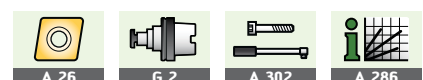

Walter Turn DSDN

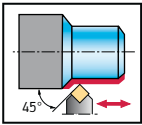

- negative toolholder range
- external machining
- rigid clamping system

Tool	Designation		h = h ₁	b	f	l ₁	l ₄	γ	λ _s	Type	
			mm	mm	mm	mm	mm	°	°		
κ = 45°	DSDNN2020K12	12	20	20	10	125	36,5	-6°	-6°	SN .. 1204 ..	
	DSDNN2525M12	12	25	25	12,8	150	36,5	-6°	-6°		
	DSDNN3225P12	12	32	25	12,8	170	36,5	-6°	-6°		
	DSDNN2525M15	15	25	25	12,8	150	44,8	-6°	-6°		SN .. 1506 ..
	DSDNN3225P19	19	32	25	13	170	49,5	-6°	-6°		SN .. 1906 ..

Measured with master insert SN .. 120408 / SN .. 150612 / SN .. 190612.
 For information on the rake angle γ (for indexable inserts without geometry) and on the inclination angle λ_s, see page A 301.
 Bodies and assembly parts are included in the scope of delivery.

Assembly parts	Type h mm	SN .. 1204 .. 20-32	SN .. 1506 .. 25	SN .. 1906 .. 32
	Shim	AP308-SN12	AP309-SN15	AP310-SN19
	Screw for shim	FS1461 (Torx 15IP)	FS1463 (Torx 20IP)	FS1463 (Torx 20IP)
	Clamp	PK241	PK242	PK243
	Screw for clamp Tightening torque	FS1473 (Torx 15IP) 3,9 Nm	FS1474 (Torx 20IP) 6,4 Nm	FS1474 (Torx 20IP) 6,4 Nm
	Pressure spring	FS1470	FS1471	FS1471
	Pin	RS117	RS117	RS117
	Torx key	FS1465 (Torx 15IP/SW 3,5)	FS1464 (Torx 20IP)	FS1464 (Torx 20IP)

Accessories	Type h mm	SN .. 1204 .. 20-32	SN .. 1506 .. 25	SN .. 1906 .. 32
	Clamp set (standard mounting parts)	PK241-SET	PK242-SET	PK243-SET
	Clamp set with carbide clamping plate	PK245-SET	PK246-SET	

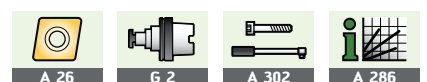

Walter Turn DSBN

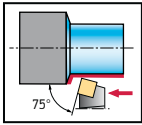

- negative toolholder range
- external machining
- rigid clamping system

Tool	Designation		h = h ₁ mm	b mm	f mm	l ₁ mm	l ₄ mm	γ	λ _s	Type		
κ = 75°	DSBNR/L2525M12		12	25	25	22	150	34,1	-6°	-6°	SN .. 1204 ..	
	DSBNR/L3225P12		12	32	25	22	170	34,1	-6°	-6°		
	DSBNR/L3232P15		15	32	32	27	170	41,5	-6°	-6°		SN .. 1506 ..
	DSBNR/L3232P19		19	32	32	27	170	46,3	-6°	-6°		
	DSBNR/L4040S19		19	40	40	35	250	46,5	-6°	-6°		SN .. 1906 ..

Measured with master insert SN .. 120408 / SN .. 150612 / SN .. 190612.

For information on the rake angle γ (for indexable inserts without geometry) and on the inclination angle λ_s, see page A 301.

Bodies and assembly parts are included in the scope of delivery.

Assembly parts	Type h mm	SN .. 1204 .. 25-32	SN .. 1506 .. 32	SN .. 1906 .. 32-40
	Shim	AP308-SN12	AP309-SN15	AP310-SN19
	Screw for shim	FS1461 (Torx 15IP)	FS1463 (Torx 20IP)	FS1463 (Torx 20IP)
	Clamp	PK241	PK242	PK243
	Screw for clamp	FS1473 (Torx 15IP)	FS1474 (Torx 20IP)	FS1474 (Torx 20IP)
	Tightening torque	3,9 Nm	6,4 Nm	6,4 Nm
	Pressure spring	FS1470	FS1471	FS1471
	Pin	RS117	RS117	RS117
	Torx key	FS1465 (Torx 15IP/SW 3,5)	FS1464 (Torx 20IP)	FS1464 (Torx 20IP)

Accessories	Type h mm	SN .. 1204 .. 25-32	SN .. 1506 .. 32	SN .. 1906 .. 32-40
	Clamp set (standard mounting parts)	PK241-SET	PK242-SET	PK243-SET
	Clamp set with carbide clamping plate	PK245-SET	PK246-SET	

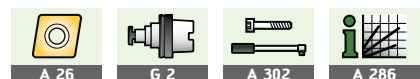

Walter Turn DSKN

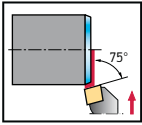

- negative toolholder range
- external machining
- rigid clamping system

Tool	Designation		h = h ₁ mm	b mm	f mm	l ₁ mm	l ₄ mm	γ	λ _s	Type
κ = 75°	DSKNR/L2525M12	12	25	25	32	150	23,5	-6°	-6°	SN .. 1204 ..
	DSKNR/L3232P15	15	32	32	40	170	28,9	-6°	-6°	SN .. 1506 ..

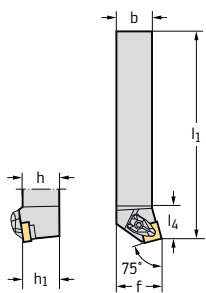

Measured with master insert SN .. 120408 / SN .. 150612 / SN .. 190612.
 For information on the rake angle γ (for indexable inserts without geometry) and on the inclination angle λ_s, see page A 301.
 Bodies and assembly parts are included in the scope of delivery.

Assembly parts	Type h mm	SN .. 1204 .. 25	SN .. 1506 .. 32
	Shim	AP308-SN12	AP309-SN15
	Screw for shim	FS1461 (Torx 15IP)	FS1463 (Torx 20IP)
	Clamp	PK241	PK242
	Screw for clamp	FS1473 (Torx 15IP)	FS1474 (Torx 20IP)
	Tightening torque	3,9 Nm	6,4 Nm
	Pressure spring	FS1470	FS1471
	Pin	RS117	RS117
	Torx key	FS1465 (Torx 15IP/SW 3,5)	FS1464 (Torx 20IP)

Accessories	Type h mm	SN .. 1204 .. 25	SN .. 1506 .. 32
	Clamp set (standard mounting parts)	PK241-SET	PK242-SET
	Clamp set with carbide clamping plate	PK245-SET	PK246-SET

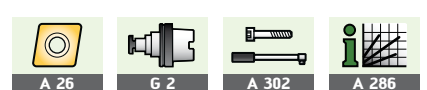

Walter Turn DTGN

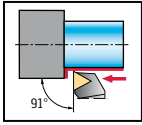

- negative toolholder range
- external machining
- rigid clamping system

Tool	Designation		h = h ₁ mm	b mm	f mm	l ₁ mm	l ₄ mm	γ	λ _s	Type
κ = 91°	DTGNR/L2020K16		16	20	25	125	25,4	-6°	-6°	TN .. 1604 ..
	DTGNR/L2525M16		16	25	32	150	24,6	-6°	-6°	
	DTGNR/L3225P16		16	32	32	170	25,3	-6°	-6°	
	DTGNR/L2525M22		22	25	32	150	32,1	-6°	-6°	TN .. 2204 ..
	DTGNR/L3225P22		22	32	32	170	33,1	-6°	-6°	

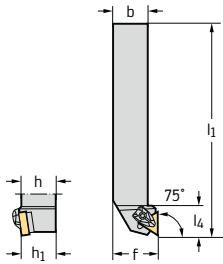

Measured with master insert TN .. 160408 / TN .. 220408.

For information on the rake angle γ (for indexable inserts without geometry) and on the inclination angle λ_s, see page A 301.

Bodies and assembly parts are included in the scope of delivery.

Assembly parts	Type h mm	TN .. 1604 .. 20-32	TN .. 2204 .. 25-32
	Shim	AP321-TN16	AP322-TN22
	Screw for shim	FS1462 (Torx 9IP)	FS1461 (Torx 15IP)
	Clamp	PK240	PK241
	Screw for clamp	FS1472 (Torx 9IP)	FS1473 (Torx 15IP)
	Tightening torque	1,7 Nm	3,9 Nm
	Pressure spring	FS1469	FS1470
	Pin	RS116	RS117
	Torx key	FS1466 (Torx 9IP)	FS1465 (Torx 15IP/SW 3,5)

Accessories	Type h mm	TN .. 1604 .. 20-32	TN .. 2204 .. 25-32
	Clamp set (standard mounting parts)	PK240-SET	PK241-SET
	Clamp set with carbide clamping plate		PK245-SET

Walter Turn DVJN / DVVN

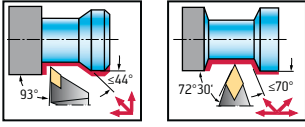

- negative toolholder range
- external machining
- rigid clamping system

Tool	Designation		h = h ₁ mm	b mm	f mm	l ₁ mm	l ₄ mm	γ	λ _s	Type	
κ = 93° 	DVJNR/L2020K16		16	20	20	25	125	41	-4°	-13°	
	DVJNR/L2525M16		16	25	25	32	150	42	-4°	-13°	VN .. 1604 ..
	DVJNR/L3225P16		16	32	25	32	170	42	-4°	-13°	
κ = 72°30' 	DVNN2020K16		16	20	10,6	25	125	47,8	-13°	-13°	
	DVNN2525M16		16	25	13,1	32	150	47,8	-13°	-13°	VN .. 1604 ..
	DVNN3225P16		16	32	13,1	32	170	47,8	-13°	-13°	

Measured with master insert VN .. 160408.

For information on the rake angle γ (for indexable inserts without geometry) and on the inclination angle λ_s, see page A 301.

Bodies and assembly parts are included in the scope of delivery.

Assembly parts	Type h mm	VN .. 1604 .. 20-32
	Shim	AP312-VN16
	Screw for shim	FS1467 (Torx 15IP)
	Clamp	PK244
	Screw for clamp Tightening torque	FS1473 (Torx 15IP) 1,7 Nm
	Pressure spring	FS1470
	Pin	RS117
	Torx key	FS1465 (Torx 15IP/SW 3,5)

Accessories	Type h mm	VN .. 1604 .. 20-32
	Clamp set (standard mounting parts)	PK244-SET



Walter Turn DWLN

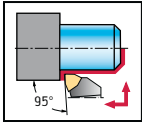

- negative toolholder range
- external machining
- rigid clamping system

Tool	Designation		h = h ₁ mm	b mm	f mm	l ₁ mm	l ₄ mm	γ	λ _s	Type
κ = 95° 	DWLN/L2020K06	6	20	20	25	125	26,3	-6°	-6°	WN .. 0604 ..
	DWLN/L2525M06	6	25	25	32	150	26,3	-6°	-6°	
	DWLN/L3225P06	6	32	25	32	170	26,3	-6°	-6°	
	DWLN/L2020K08	8	20	20	25	125	34,2	-6°	-6°	WN .. 0804 ..
	DWLN/L2525M08	8	25	25	32	150	34,2	-6°	-6°	
	DWLN/L3225P08	8	32	25	32	170	34,2	-6°	-6°	
	DWLN/L2525M10	10	25	25	32	150	40,3	-6°	-6°	WN .. 1006 ..
	DWLN/L3225P10	10	32	25	32	170	40,3	-6°	-6°	
	DWLN/L3232P10	10	32	32	40	170	41,8	-6°	-6°	

Measured with master insert WN .. 060408 / WN .. 080408 / WN .. 100612.

For information on the rake angle γ (for indexable inserts without geometry) and on the inclination angle λ_s, see page A 301.

Bodies and assembly parts are included in the scope of delivery.

Assembly parts	Type h mm	WN .. 0604 .. 20-32	WN .. 0804 .. 20-32	WN .. 1006 .. 25-32
	Shim	AP306-WN06	AP307-WN08 r ≤ 1,6	AP311-WN10
	Screw for shim	FS1462 (Torx 9IP)	FS1461 (Torx 15IP)	FS1463 (Torx 20IP)
	Clamp	PK240	PK241	PK242
	Screw for clamp Tightening torque	FS1472 (Torx 9IP) 1,7 Nm	FS1473 (Torx 15IP) 3,9 Nm	FS1474 (Torx 20IP) 6,4 Nm
	Pressure spring	FS1469	FS1470	FS1471
	Pin	RS116	RS117	RS117
	Torx key	FS1466 (Torx 9IP)	FS1465 (Torx 15IP/SW 3,5)	FS1464 (Torx 20IP)

Accessories	Type h mm	WN .. 0604 .. 20-32	WN .. 0804 .. 20-32	WN .. 1006 .. 25-32
	Clamp set (standard mounting parts)	PK240-SET	PK241-SET	PK242-SET
	Clamp set with carbide clamping plate		PK245-SET	PK246-SET

Walter Turn PCLN

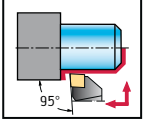

- negative toolholder range
- external machining
- lever type clamping

Tool	Designation		h = h ₁ mm	b mm	f mm	l ₁ mm	l ₄ mm	γ	λ _s	Type
κ = 95°	PCLNR/L1616H12		12	16	20	100	27,2	-6°	-6°	CN .. 1204 ..
	PCLNR/L2020K12		12	20	25	125	26	-6°	-6°	
	PCLNR/L2525M12		12	25	32	150	26	-6°	-6°	
	PCLNR/L3225P12		12	32	32	170	26	-6°	-6°	CN .. 1606 ..
	PCLNR/L2525M16		16	25	32	150	28	-6°	-6°	
	PCLNR/L3225P16		16	32	32	170	38	-6°	-6°	
	PCLNR/L3232P16		16	32	40	170	36	-6°	-6°	CN .. 1906 ..
	PCLNR/L3232P19		19	32	40	170	36	-6°	-6°	
	PCLNR/L4040S19		19	40	50	250	36	-6°	-6°	CN .. 2509 ..
	PCLNR/L4040S25		25	40	50	250	50	-6°	-6°	
PCLNR/L5050T25		25	50	60	300	50	-6°	-6°		

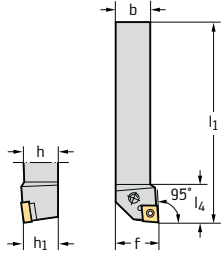

Measured with master insert CN .. 120408 / CN .. 160612 / CN .. 190612 / CN .. 250924.

For information on the rake angle γ (for indexable inserts without geometry) and on the inclination angle λ_s, see page A 301.

Bodies and assembly parts are included in the scope of delivery.

Assembly parts	Type h mm	CN .. 1204 .. 16	CN .. 1204 .. 20-32	CN .. 1606 .. 25-32	CN .. 1906 .. 32-40	CN .. 2509 .. 40-50
	Shim	AP134-CN1216 r ≤ 1,6	AP134-CN1216 r ≤ 1,6	AP135-CN1624 r ≤ 2,4	AP136-CN1924 r ≤ 2,4	AP192-CN2524 r ≤ 2,4
	Lever	KN121	KN102	KN104	KN106	KN107
	Clamping screw Tightening torque	FS2129 (SW 3)	FS352 (SW 3) 5,0 Nm	FS354 (SW 3) 5,0 Nm	FS356 (SW 4) 10,0 Nm	FS357 (SW 5) 14,0 Nm
	Pipe pin	RS102	RS102	RS103	RS104	RS105
	Assembly plug	MD101	MD101	MD102	MD102	MD103
	Allen key	ISO 2936-3 (SW 3)	ISO 2936-3 (SW 3)	ISO 2936-3 (SW 3)	ISO 2936-4 (SW 4)	ISO 2936-5 (SW 5)

Accessories	Type h mm	CN .. 1204 .. 16-32	CN .. 1606 .. 25-32	CN .. 1906 .. 32-40
	Shim	AP134-CN1208 r ≤ 0,8		AP136-CN1912 r ≤ 1,2

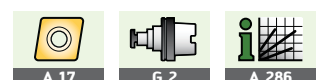

A 17

G 2

A 286

Walter Turn PCBN

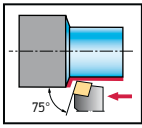

- negative toolholder range
- external machining
- lever type clamping

Tool	Designation		h = h ₁ mm	b mm	f mm	l ₁ mm	l ₄ mm	γ	λ _s	Type	
											κ = 75°
	PCBNR/L2525M12		12	25	25	22	150	26	-6°	-6°	CN .. 1204 ..
	PCBNR/L2525M16		16	25	25	22	150	28	-6°	-6°	CN .. 1606 ..
	PCBNR/L3232P16		16	32	32	27	170	38	-6°	-6°	CN .. 1906 ..
	PCBNR/L3232P19		19	32	32	27	170	38	-6°	-6°	CN .. 1906 ..

Measured with master insert CN .. 120408 / CN .. 160612 / CN .. 190612.

For information on the rake angle γ (for indexable inserts without geometry) and on the inclination angle λ_s, see page A 301.

Bodies and assembly parts are included in the scope of delivery.

Assembly parts	Type h mm	CN .. 1204 .. 25	CN .. 1606 .. 25-32	CN .. 1906 .. 32
	Shim	AP134-CN1216 r ≤ 1,6	AP135-CN1624 r ≤ 2,4	AP136-CN1924 r ≤ 2,4
	Lever	KN102	KN104	KN106
	Clamping screw Tightening torque	FS352 (SW 3) 5,0 Nm	FS354 (SW 3) 5,0 Nm	FS356 (SW 4) 10,0 Nm
	Pipe pin	RS102	RS103	RS104
	Assembly plug	MD101	MD102	MD102
	Allen key	ISO 2936-3 (SW 3)	ISO 2936-3 (SW 3)	ISO 2936-4 (SW 4)

Accessories	Type h mm	CN .. 1204 .. 25	CN .. 1606 .. 25-32	CN .. 1906 .. 32
	Shim	AP134-CN1208 r ≤ 0,8	AP135-CN1616 r ≤ 1,6	AP136-CN1912 r ≤ 1,2



Walter Turn PCKN / PCSN

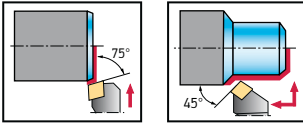

- negative toolholder range
- external machining
- lever type clamping

Tool	Designation		h = h ₁ mm	b mm	f mm	f ₁ mm	l ₁ mm	l ₄ mm	l ₂₀ mm	γ	λ _s	Type	
κ = 75° 	PCKNR/L2525M12		12	25	25	32		150	26		-6°	-6°	CN . . 1204 . .
κ = 45° 	PCSNR/L2525M12		12	25	25	32	23,9	150	28	160	-8°	-8°	CN . . 1204 . .

Measured with master insert CN . . 120408.
 For information on the rake angle γ (for indexable inserts without geometry) and on the inclination angle λ_s, see page A 301.
 Bodies and assembly parts are included in the scope of delivery.

Assembly parts	Type	CN . . 1204 . .
	Shim	25 AP134-CN1216 r ≤ 1,6
	Lever	KN102
	Clamping screw	FS352 (SW 3)
	Tightening torque	5,0 Nm
	Pipe pin	RS102
	Assembly plug	MD101
	Allen key	ISO 2936-3 (SW 3)

Accessories	Type	CN . . 1204 . .
	Shim	25 AP134-CN1208 r ≤ 0,8

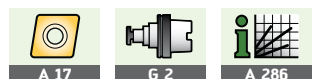

Walter Turn PDJN

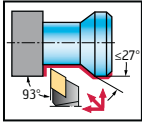

- negative toolholder range
- external machining
- lever type clamping

Tool	Designation		h = h ₁ mm	b mm	f mm	l ₁ mm	l ₄ mm	γ	λ _s	Type
κ = 93°	PDJNR/L1616H11		11	16	20	100	28	-6°	-7°	DN .. 1104 ..
	PDJNR/L2020K11		11	20	25	125	28	-6°	-7°	
	PDJNR/L2525M11		11	25	32	150	28	-6°	-7°	
	PDJNR/L3225P11		11	32	32	170	28	-6°	-7°	
	PDJNR/L2020K15		15	20	25	125	36	-6°	-7°	DN .. 1506 ..
	PDJNR/L2525M15		15	25	32	150	36	-6°	-7°	
	PDJNR/L3225P15		15	32	32	170	36	-6°	-7°	
	PDJNR/L3232P15		15	32	40	170	36	-6°	-7°	

Measured with master insert DN .. 110408 / DN .. 150608.

For information on the rake angle γ (for indexable inserts without geometry) and on the inclination angle λ_s, see page A 301.

Bodies and assembly parts are included in the scope of delivery.

Assembly parts	Type h mm	DN .. 1104 .. 16-32	DN .. 1506 .. 20-32
	Shim	AP171-DN1112 r ≤ 1,2	AP145-DN1516 r ≤ 1,6
	Lever	KN119	KN103
	Clamping screw Tightening torque	FS351 (SW 2,5) 2,0 Nm	FS355 (SW 3) 5,0 Nm
	Pipe pin	RS101	RS102
	Assembly plug	MD101	MD101
	Allen key	ISO 2936-2,5 (SW 2,5)	ISO 2936-3 (SW 3)

Accessories	Type h mm	DN .. 1104 .. 16-32	DN .. 1506 .. 20-32
	Shim	AP171-DN1108 r ≤ 0,8	AP145-DN1508 r ≤ 0,8
	Shim for DN .. 1504 ..		AP357-DN1508 r ≤ 0,8
			AP357-DN1516 r ≤ 1,6

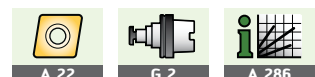

Walter Turn PSSN

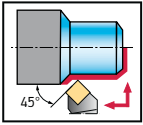

- negative toolholder range
- external machining
- lever type clamping

Tool	Designation	⊙		h = h ₁ mm	b mm	f mm	f ₁ mm	l ₁ mm	l ₄ mm	l ₂₀ mm	γ	λ _s	Type
		⊙	⊙										
κ = 45°	PSSNR/L2020K12	12	20	20	25	16,7	125	28	133,3	-8°	0°	SN..1204..	
	PSSNR/L2525M12	12	25	25	32	23,7	150	28	158,3	-8°	0°		
	PSSNR/L3225P12	12	32	25	32	23,7	170	29	178,3	-8°	0°	SN..1506..	
	PSSNR/L2525M15	15	25	25	32	21,8	150	32	160,2	-8°	0°		
	PSSNR/L3232P15	15	32	32	40	29,8	170	32	180,2	-8°	0°	SN..1906..	
	PSSNR/L3232P19	19	32	32	40	27,5	170	37,5	182,5	-8°	0°		

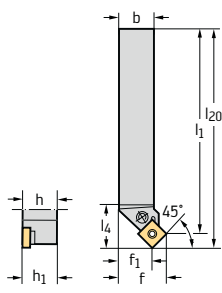

Measured with master insert SN . . 120408 / SN . . 150612 / SN . . 190612.
 For information on the rake angle γ (for indexable inserts without geometry) and on the inclination angle λ_s, see page A 301.
 Bodies and assembly parts are included in the scope of delivery.

Assembly parts	Type h mm	SN..1204.. 20-32	SN..1506.. 25-32	SN..1906.. 32
	Shim	AP141-SN1216 r ≤ 1,6	AP142-SN1524 r ≤ 2,4	AP143-SN1924 r ≤ 2,4
	Lever	KN102	KN104	KN106
	Clamping screw Tightening torque	FS352 (SW 3) 5,0 Nm	FS354 (SW 3) 5,0 Nm	FS356 (SW 4) 10,0 Nm
	Pipe pin	RS102	RS103	RS104
	Assembly plug	MD101	MD102	MD102
	Allen key	ISO 2936-3 (SW 3)	ISO 2936-3 (SW 3)	ISO 2936-4 (SW 4)

Accessories	Type h mm	SN..1204.. 20-32	SN..1506.. 25-32	SN..1906.. 32
	Shim	AP141-SN1208 r ≤ 0,8	AP142-SN1516 r ≤ 1,6	AP143-SN1912 r ≤ 1,2

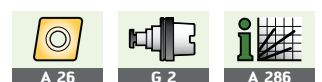

Walter Turn PSDN

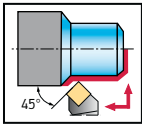

- negative toolholder range
- external machining
- lever type clamping

Tool	Designation		h = h ₁ mm	b mm	f mm	l ₁ mm	l ₄ mm	γ	λ _s	Type
	PSDNN2020K12		12	20	10	125	28	-6°	-6°	
	PSDNN2525M12		12	25	12,5	150	28	-6°	-6°	SN .. 1204 ..
	PSDNN3225P12		12	32	12,5	170	28	-6°	-6°	
	PSDNN3225P15		15	32	12,5	170	36	-6°	-6°	SN .. 1506 ..
	PSDNN3232P19		19	32	16	170	40	-6°	-6°	SN .. 1906 ..
	PSDNN4040S25		25	40	21	250	48,8	-6°	-6°	SN .. 2507 ..

Measured with master insert SN .. 120408 / SN .. 150612 / SN .. 190612 / SN..250716.

For information on the rake angle γ (for indexable inserts without geometry) and on the inclination angle λ_s, see page A 301.

Bodies and assembly parts are included in the scope of delivery.

Assembly parts	Type h mm	SN .. 1204 .. 20-32	SN .. 1506 .. 32	SN .. 1906 .. 32	SN .. 2507 .. 40
	Shim	AP141-SN1216 r ≤ 1,6	AP142-SN1524 r ≤ 2,4	AP143-SN1924 r ≤ 2,4	AP144-SN2524 r ≤ 2,4
	Lever	KN102	KN104	KN106	KN107
	Clamping screw Tightening torque	FS352 (SW 3) 5,0 Nm	FS354 (SW 3) 5,0 Nm	FS356 (SW 4) 10,0 Nm	FS357 (SW 5) 14,0 Nm
	Pipe pin	RS102	RS103	RS104	RS105
	Assembly plug	MD101	MD102	MD102	MD103
	Allen key	ISO 2936-3 (SW 3)	ISO 2936-3 (SW 3)	ISO 2936-4 (SW 4)	ISO 2936-5 (SW 5)

Accessories	Type h mm	SN .. 1204 .. 20-32	SN .. 1506 .. 32	SN .. 1906 .. 32	SN .. 2507 .. 40
	Shim	AP141-SN1208 r ≤ 0,8	AP142-SN1516 r ≤ 1,6	AP143-SN1912 r ≤ 1,2	AP191-SN250924 SN..250924



Walter Turn

PSBN

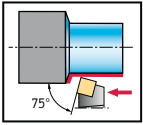

- negative toolholder range
- external machining
- lever type clamping

Tool	Designation		h = h ₁ mm	b mm	f mm	l ₁ mm	l ₄ mm	γ	λ _s	Type
	PSBNR/L2020K12		12	20	17	125	26	-6°	-6°	SN .. 1204 ..
	PSBNR/L2525M12		12	25	22	150	26	-6°	-6°	
	PSBNR/L3225P12		12	32	22	170	26	-6°	-6°	
	PSBNR/L2525M15		15	25	22	150	36	-6°	-6°	SN .. 1506 ..
	PSBNR/L3232P15		15	32	27	170	33	-6°	-6°	
	PSBNR/L3232P19		19	32	27	170	40	-6°	-6°	SN .. 1906 ..
	PSBNR/L4040S19		19	40	35	250	38	-6°	-6°	
	PSBNR/L4040S25		25	40	35	250	47	-6°	-6°	SN .. 2507 ..
	PSBNR/L5050T25		25	50	43,4	300	47,5	-6°	-6°	

Measured with master insert SN .. 120408 / SN .. 150612 / SN .. 190612 / SN .. 250716.

For information on the rake angle γ (for indexable inserts without geometry) and on the inclination angle λ_s, see page A 301.

Bodies and assembly parts are included in the scope of delivery.

Assembly parts	Type h mm	SN .. 1204 .. 20-32	SN .. 1506 .. 25-32	SN .. 1906 .. 32-40	SN .. 2507 .. 40-50
	Shim	AP141-SN1216 r ≤ 1,6	AP142-SN1524 r ≤ 2,4	AP143-SN1924 r ≤ 2,4	AP144-SN2524 r ≤ 2,4
	Lever	KN102	KN104	KN106	KN107
	Clamping screw Tightening torque	FS352 (SW 3) 5,0 Nm	FS354 (SW 3) 5,0 Nm	FS356 (SW 4) 10,0 Nm	FS357 (SW 5) 14,0 Nm
	Pipe pin	RS102	RS103	RS104	RS105
	Assembly plug	MD101	MD102	MD102	MD103
	Allen key	ISO 2936-3 (SW 3)	ISO 2936-3 (SW 3)	ISO 2936-4 (SW 4)	ISO 2936-5 (SW 5)

Accessories	Type h mm	SN .. 1204 .. 20-32	SN .. 1506 .. 25-32	SN .. 1906 .. 32-40	SN .. 2507 .. 40-50	
	Shim	AP191-SN250924 SN..250924	AP141-SN1208 r ≤ 0,8	AP142-SN1516 r ≤ 1,6	AP143-SN1912 r ≤ 1,2	AP191-SN250924 SN..250924

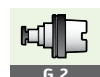

Walter Turn PSKN

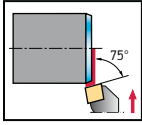

- negative toolholder range
- external machining
- lever type clamping

Tool			h = h ₁ mm	b mm	f mm	l ₁ mm	l ₄ mm	γ	λ _s	Type
κ = 75°	PSKNR/L2020K12	12	20	20	25	125	25	-6°	-6°	SN .. 1204 ..
	PSKNR/L2525M12	12	25	25	32	150	26	-6°	-6°	
	PSKNR/L3232P19	19	32	32	40	170	37,5	-6°	-6°	SN .. 1906 ..

Measured with master insert SN .. 120408 / SN .. 190612.

For information on the rake angle γ (for indexable inserts without geometry) and on the inclination angle λ_s, see page A 301.

Bodies and assembly parts are included in the scope of delivery.

Assembly parts	Type h mm	SN .. 1204 .. 20-25	SN .. 1906 .. 32
	Shim	AP141-SN1216 r ≤ 1,6	AP143-SN1924 r ≤ 2,4
	Lever	KN102	KN106
	Clamping screw Tightening torque	FS352 (SW 3) 5,0 Nm	FS356 (SW 4) 10,0 Nm
	Pipe pin	RS102	RS104
	Assembly plug	MD101	MD102
	Allen key	ISO 2936-3 (SW 3)	ISO 2936-4 (SW 4)

Accessories	Type h mm	SN .. 1204 .. 20-25	SN .. 1906 .. 32
	Shim	AP141-SN1208 r ≤ 0,8	AP143-SN1912 r ≤ 1,2

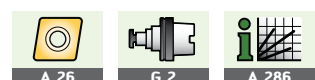

Walter Turn PTGN / PTFN

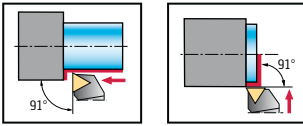

- negative toolholder range
- external machining
- lever type clamping

Tool	Designation		h = h ₁ mm	b mm	f mm	l ₁ mm	l ₄ mm	γ	λ _s	Type
κ = 91° 	PTGNR/L1616H16	16	16	16	20	100	20,2	-6°	-6°	TN .. 1604 ..
	PTGNR/L2020K16	16	20	20	25	125	20	-6°	-6°	
	PTGNR/L2525M16	16	25	25	32	150	20	-6°	-6°	
	PTGNR/L3225P16	16	32	25	32	170	20	-6°	-6°	
	PTGNR/L3232P22	22	32	32	40	170	26	-6°	-6°	
	PTGNR/L4040S27	27	40	40	50	250	34	-6°	-6°	
κ = 91° 	PTFNR/L2020K16	16	20	20	25	125	20	-6°	-6°	TN .. 1604 ..
	PTFNR/L2525M16	16	25	25	32	150	20	-6°	-6°	
	PTFNR/L3225P16	16	32	25	32	170	20	-6°	-6°	

Measured with master insert TN .. 160408 / TN .. 220408.

For information on the rake angle γ (for indexable inserts without geometry) and on the inclination angle λ_s, see page A 301.

Bodies and assembly parts are included in the scope of delivery.

Assembly parts	Type h mm	TN .. 1604 .. 16-32	TN .. 2207 .. 32	TN .. 2706 .. 40
	Shim	AP137-TN1616 r ≤ 1,6	AP138-TN2216 r ≤ 1,6	AP193-TN2716 r ≤ 1,6
	Lever	KN101	KN102	KN125
	Clamping screw Tightening torque	FS351 (SW 2,5) 2,0 Nm	FS352 (SW 3) 5,0 Nm	FS2156 (SW 3) 5,0 Nm
	Pipe pin	RS101	RS102	RS103
	Assembly plug	MD101	MD101	MD102
	Allen key	ISO 2936-2,5 (SW 2,5)	ISO 2936-3 (SW 3)	ISO 2936-3 (SW 3)

Accessories	Type h mm	TN .. 1604 .. 16-32	TN .. 2204 .. 32
	Shim	AP137-TN1608 r ≤ 0,8	AP138-TN2208 r ≤ 0,8



Walter Turn MTJN

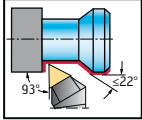

- negative toolholder range
- external machining
- wedge-type clamping system

Tool	Designation		h = h ₁ mm	b mm	f mm	l ₁ mm	l ₄ mm	γ	λ _s	Type
κ = 93°	MTJNR/L2020K16	16	20	20	25	125	30,8	-6°	-6°	TN..1604..
	MTJNR/L2525M16	16	25	25	32	150	30,8	-6°	-6°	
	MTJNR/L3225P16	16	32	25	32	170	30,8	-6°	-6°	
	MTJNR/L2525M22	22	25	25	32	150	34,8	-6°	-6°	TN..2204..
	MTJNR/L3225P22	22	32	25	32	170	34,8	-6°	-6°	

Measured with master insert TN . . 160408 / TN . . 220408.

For information on the rake angle γ (for indexable inserts without geometry) and on the inclination angle λ_s, see page A 301.

Bodies and assembly parts are included in the scope of delivery.

Assembly parts	Type h mm	TN..1604.. 20-32	TN..2204.. 25-32
	Shim	AP147 r ≤ 1,6	AP148 r ≤ 1,6
	Clamping wedge set	FK303 (SW 2,5)	FK304 (SW 3)
	Pin	RS106	RS107
	Clamping screw	FS358 (SW 3)	FS358 (SW 3)
	Allen key	ISO 2936-25 (SW 2,5)	ISO 2936-25 (SW 3)







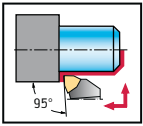



Accessories	Type h mm	TN..2204.. 25
	Shim	AP149 r ≤ 0,8



Walter Turn PWLN









- negative toolholder range
- external machining
- lever type clamping

Tool	Designation		h = h ₁ mm	b mm	f mm	l ₁ mm	l ₄ mm	γ	λ _s	Type	
κ = 95°	PWLN/L1616H06		6	16	20	100	18,5	-6°	-6°	WN .. 0604 ..	
	PWLN/L2020K06		6	20	25	125	18,5	-6°	-6°		
	PWLN/L2525M06		6	25	32	150	18,5	-6°	-6°		
		PWLN/L2020K08		8	20	25	125	22	-6°	-6°	WN .. 0804 ..
		PWLN/L2525M08		8	25	32	150	22	-6°	-6°	
		PWLN/L3225P08		8	32	32	170	22	-6°	-6°	
		PWLN/L2525M10		10	25	32	150	22	-6°	-6°	WN .. 1006 ..
		PWLN/L3225P10		10	32	32	170	22	-6°	-6°	
		PWLN/L3232P10		10	32	40	170	24	-6°	-6°	

Measured with master insert WN .. 060408 / WN .. 080408 / WN .. 100612.

For information on the rake angle γ (for indexable inserts without geometry) and on the inclination angle λ_s, see page A 301.

Bodies and assembly parts are included in the scope of delivery.

Assembly parts	Type h mm	WN .. 0604 .. 16-20	WN .. 0604 .. 25	WN .. 0804 .. 20-32	WN .. 1006 .. 25-32
	Shim	AP172-WN0612 r ≤ 1,2	AP172-WN0612 r ≤ 1,2	AP170-WN0816 r ≤ 1,6	AP174-WN1016 r ≤ 1,6
	Lever	KN101	KN101	KN102	KN104
	Clamping screw Tightening torque	FS351 (SW 2,5) 2,0 Nm	FS351 (SW 2,5) 2,0 Nm	FS352 (SW 3) 5,0 Nm	FS354 (SW 3) 5,0 Nm
	Pipe pin	RS101	RS101	RS102	RS103
	Assembly plug	MD101	MD103	MD101	MD102
	Allen key	ISO 2936-2,5 (SW 2,5)	ISO 2936-5 (SW 5)	ISO 2936-3 (SW 3)	ISO 2936-3 (SW 3)

Accessories	Type h mm	WN .. 0804 .. 20-32
	Shim	AP170-WN0808 r ≤ 0,8



Walter Turn SCLC

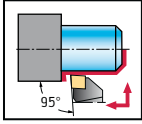

- positive toolholder range
- external machining
- screw clamping

Tool	Designation		h = h ₁ mm	b mm	f mm	l ₁ mm	l ₄ mm	γ	λ _s	Type
κ = 95°	SCLCR/L1010E06		10	10	12	70	13	0°	0°	CC...0602...
	SCLCR/L1212F06		12	12	16	80	10	0°	0°	
	SCLCR/L1616H06		16	16	20	100	12	0°	0°	
	SCLCR/L2020K06		20	20	25	125	12	0°	0°	
	SCLCR/L1212F09		12	12	16	80	19,5	0°	0°	CC...09T3...
	SCLCR/L1616H09		16	16	20	100	18	0°	0°	
	SCLCR/L2020K09		20	20	25	125	18	0°	0°	
	SCLCR/L2525M09		25	25	32	150	17	0°	0°	
	SCLCR/L2020K12		20	20	25	125	25	0°	0°	CC...1204...
	SCLCR/L2525M12		25	25	32	150	26	0°	0°	

Measured with master insert CC...060204 / CC...09T308 / CC...120408.

For information on the rake angle γ (for indexable inserts without geometry) and on the inclination angle λ_s, see page A 301.

Bodies and assembly parts are included in the scope of delivery.

Assembly parts	Type h mm	CC...0602... 10-20	CC...09T3... 12	CC...09T3... 16-25	CC...1204... 20-25
	Clamping screw for insert Tightening torque	FS2061 (Torx 7IP) 0,9 Nm	FS2063 (Torx 15IP) 3,0 Nm	FS2060 (Torx 15 IP) 3,0 Nm	FS2065 (Torx 15IP) 3,0 Nm
	Shim			AP313-CC0908 r ≤ 0,8	AP314-CC1212 r ≤ 1,2
	Screw for shim			FS2068 (SW 3,5)	FS2069 (SW 4)
	Torx key	FS1490 (Torx 7IP)	FS1465 (Torx 15IP/SW 3,5)	FS1465 (Torx 15IP/SW 3,5)	FS1496 (Torx 15IP/SW 4)



Walter Turn SDJC / SDHC

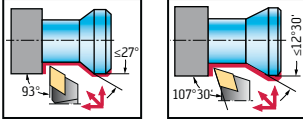

- positive toolholder range
- external machining
- screw clamping

Tool	Designation		h = h ₁ mm	b mm	f mm	l ₁ mm	l ₄ mm	γ	λ _s	Type
κ = 93° 	SDJCR/L1010E07	7	10	10	12	70	15,7	0°	0°	DC . . 0702 . .
	SDJCR/L1212F07	7	12	12	16	80	15,5	0°	0°	
	SDJCR/L1616H11	11	16	16	20	100	20,3	0°	0°	
	SDJCR/L2020K11	11	20	20	25	125	21,9	0°	0°	DC . . 11T3 . .
	SDJCR/L2525M11	11	25	25	32	150	24,4	0°	0°	
κ = 107° 30' 	SDHCR/L1212F07	7	12	12	16	80	14,3	0°	0°	DC . . 0702 . .
	SDHCR/L1616H11	11	16	12	20	100	17,9	0°	0°	
	SDHCR/L2020K11	11	25	25	25	125	17,9	0°	0°	DC . . 11T3 . .
	SDHCR/L2525M11	11	25	25	32	150	150	0°	0°	

Measured with master insert DC . . 070204 / DC . . 11T308.

For information on the rake angle γ (for indexable inserts without geometry) and on the inclination angle λ_s, see page A 301.

Bodies and assembly parts are included in the scope of delivery.

Assembly parts	Type h mm	DC . . 0702 . . 10-12	DC . . 11T3 . . 16-25
	Clamping screw for insert Tightening torque	FS2061 (Torx 7IP) 0,9 Nm	FS2060 (Torx 15 IP) 3,0 Nm
	Shim		AP315-DC1108 r ≤ 0,8
	Screw for shim		FS2068 (SW 3,5)
	Torx key	FS1490 (Torx 7IP)	FS1465 (Torx 15IP/SW 3,5)

Accessories	Type h mm	DC . . 11T3 . . 16-25
	Shim	AP329-DC1112 r ≤ 1,2

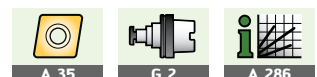

Walter Turn SDNC

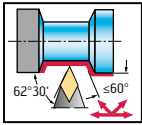

- positive toolholder range
- external machining
- screw clamping

Tool

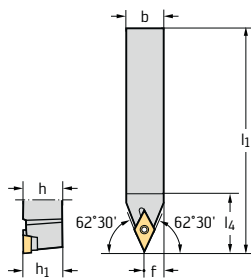
 $\kappa = 62^\circ 30'$

Designation		$h = h_1$ mm	b mm	f mm	l_1 mm	l_4 mm	γ	λ_s	Type
SDNCN1010E07		7	10	5,2	70	14,5	0°	0°	DC...0702...
SDNCN1212F07		7	12	6,2	80	14,5	0°	0°	
SDNCN1616H11		11	16	8,5	100	21,9	0°	0°	DC...11T3...
SDNCN2020K11		11	20	10,5	125	21,9	0°	0°	
SDNCN2525M11		11	25	13	150	150	0°	0°	

Measured with master insert DC...070204 / DC...11T308.

For information on the rake angle γ (for indexable inserts without geometry) and on the inclination angle λ_s , see page A 301.

Bodies and assembly parts are included in the scope of delivery.

Assembly parts

Type	h mm	DC...0702... 10-12	DC...11T3... 16-25
Clamping screw for insert Tightening torque		FS2061 (Torx 7IP) 0,9 Nm	FS2060 (Torx 15 IP) 3,0 Nm
Shim			AP315-DC1108 $r \leq 0,8$
Screw for shim			FS2068 (SW 3,5)
Torx key		FS1490 (Torx 7IP)	FS1465 (Torx 15IP/SW 3,5)

Accessories

Type	h mm	DC...11T3... 16-25
Shim		AP329-DC1112 $r \leq 1,2$

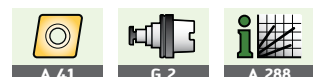

Walter Turn SRDC

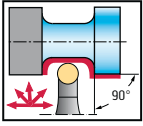

- positive toolholder range
- external machining
- screw clamping

Tool	Designation		h = h ₁ mm	b mm	f mm	l ₁ mm	l ₄ mm	γ	λ _s	Type
	SRDCN1212F06	6	12	12	6	80	12	0°	0°	RC . T0602 . .
	SRDCN2020K06	6	20	20	10	125	24	0°	0°	
	SRDCN2525M06	6	25	25	12,5	150	25	0°	0°	
	SRDCN1616H08	8	16	16	8	100	16	0°	0°	RC . T0803 . .
	SRDCN2020K08	8	20	20	10	125	24	0°	0°	
	SRDCN2525M08	8	25	25	12,5	150	25	0°	0°	RC . T10T3 . .
	SRDCN2020K10	10	20	20	10	125	25	0°	0°	
	SRDCN2525M10	10	25	25	12,5	150	25	0°	0°	RC . T1204 . .
	SRDCN2020K12	12	20	20	10	125	25	0°	0°	
	SRDCN2525M12	12	25	25	12,5	150	28	0°	0°	RC . T1606 . .
	SRDCN3225P12	12	32	25	12,5	170	28	0°	0°	
	SRDCN3225P16	16	32	25	12,5	170	35	0°	0°	RC . T2006 . .
	SRDCN3232P20	20	32	32	12,5	170	40	0°	0°	

Measured with master insert RC . T 0602M0 / RC . T 0803M0 / RC . T 1204M0 / RC . T 1606M0 / RC . T 2006M0.

For information on the rake angle γ (for indexable inserts without geometry) and on the inclination angle λ_s, see page A 301.

Bodies and assembly parts are included in the scope of delivery.

Assembly parts	Type h mm	RC . T0602 . . 12-25	RC . T0803 . . 16-25	RC . T10T3 . . 20-25	RC . T1204 . . 20-32	RC . T1606 . . 32	RC . T2006 . . 32
	Clamping screw for insert Tightening torque	FS2061 (Torx 7IP) 0,9 Nm	FS1462 (Torx 9IP) 0,9 Nm	FS2063 (Torx 15IP) 3,0 Nm	FS2060 (Torx 15 IP) 3,0 Nm	FS2090 (Torx 20IP) 6,4 Nm	FS2089 (Torx 25IP) 9,5 Nm
	Shim			AP324- RC10T3	AP325- RC1204	AP326- RC1606	AP327- RC2006
	Screw for shim			FS2068 (SW 3,5)	FS2068 (SW 3,5)	FS2091 (SW 5)	FS2092 (SW 6)
	Torx key	FS1490 (Torx 7IP)	FS1466 (Torx 9IP)	FS1465 (Torx 15IP/SW 3,5)	FS1465 (Torx 15IP/SW 3,5)	FS1464 (Torx 20IP)	FS1592 (Torx T25IP)

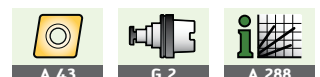

Walter Turn PRDC

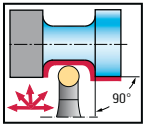

- positive toolholder range
- external machining
- lever type clamping

Tool

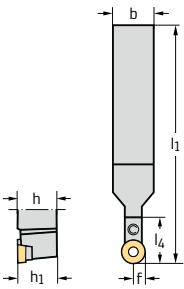

Designation		$h = h_1$ mm	b mm	f mm	l_1 mm	l_4 mm	γ	λ_s	Type
PRDCN2020K10	10	20	20	10	125	24	0°	0°	RC .. 10T3 ..
PRDCN2525M10	10	25	25	12,5	150	25	0°	0°	
PRDCN2525M12	12	25	25	12,5	150	25	0°	0°	RC .. 1204 ..
PRDCN3225P12	12	32	25	12,5	170	28	0°	0°	
PRDCN3225P16	16	32	25	12,5	170	32	0°	0°	RC .. 1605 ..
PRDCN3232P20	16	32	32	26	170	32	0°	0°	RC .. 2006 ..
PRDCN4040S25	25	40	40	20	250	50	0°	0°	RC .. 2507 ..
PRDCN5050U32	32	50	50	41	350	50	0°	0°	RC .. 3209 ..

Measured with master insert RC .. 0602M0 .. / RC .. 0803M0 .. / RC .. 10T3M0 .. / RC .. 1204M0 .. / RC .. 1605M0 .. / RC .. 2006M0 ..

For information on the rake angle γ (for indexable inserts without geometry) and on the inclination angle λ_s , see page A 301.

Bodies and assembly parts are included in the scope of delivery.

Assembly parts

Type h mm	RC .. 10T3 .. 20-25	RC .. 1204 .. 25-32	RC .. 1605 .. 32	RC .. 2006 .. 32	RC .. 2507 .. 40	RC .. 3209 .. 50
Shim	AP407-RC10T3	AP402-RC1204	AP403-RC1605	AP404-RC2006	AP405-RC2507	AP406-RC3209
Lever	KN122	KN123	KN111	KN112	KN113	KN124
Clamping screw Tightening torque	FS2155 (SW 2) 0,6 Nm	FS351 (SW 2,5) 2,0 Nm	FS344 (SW 2,5) 2,5 Nm	FS2156 (SW 3) 5 Nm	FS2145 (SW 4) 10 Nm	FS357 (SW 5) 14,0 Nm
Pipe pin	RS101	RS120	RS118	RS103	RS104	RS105
Assembly plug	MD101	MD101	MD101	MD102	MD102	MD103
Allen key	ISO 2936-2 (SW 2)	ISO 2936-2,5 (SW 2,5)	ISO 2936-2,5 (SW 2,5)	ISO 2936-3 (SW 3)	ISO 2936-4 (SW 4)	ISO 2936-5 (SW 5)

Accessories

Type h mm	RC .. 10T3 .. 20-25	RC .. 1605 .. 32
Shim for RC .. 1003 ..	AP401-RC1003	
Shim for RC .. 1606 ..		AP403-RC1606



Walter Turn SRSC

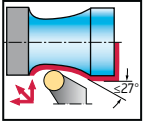

- positive toolholder range
- external machining
- screw clamping

Tool	Designation		h = h ₁ mm	b mm	f mm	l ₁ mm	l ₄ mm	γ	λ _s	Type
	SRSCR/L2020K06	6	20	20	25	125	20	0°	0°	RC . T0602 ..
	SRSCR/L2525M06	6	25	25	32	150	20	0°	0°	
	SRSCR/L2020K08	8	20	20	25	125	20	0°	0°	RC . T0803 ..
	SRSCR/L2525M08	8	25	25	32	150	20	0°	0°	
	SRSCR/L2020K10	10	20	20	25	125	20	0°	0°	RC . T10T3 ..
	SRSCR/L2525M10	10	25	25	32	150	20	0°	0°	
	SRSCR/L2020K12	12	20	20	25	125	22	0°	0°	
	SRSCR/L2525M12	12	25	25	32	150	22	0°	0°	RC . T1204 ..
	SRSCR/L3225P12	12	32	25	32	170	22	0°	0°	
	SRSCR/L3225P16	16	32	25	32	170	28	0°	0°	RC . T1606 ..
SRSCR/L3232P20	20	32	32	40	170	32	0°	0°	RC . T2006 ..	

Measured with master insert RC . . T 0602M0 / RC . . T 0803M0 / RC . . T 1204M0 / RC . T 1606M0 / RC . T 2006M0.

For information on the rake angle γ (for indexable inserts without geometry) and on the inclination angle λ_s, see page A 301.

Bodies and assembly parts are included in the scope of delivery.

Assembly parts	Type h mm	RC . T0602 .. 20-25	RC . T0803 .. 20-25	RC . T10T3 .. 20-25	RC . T1204 .. 20-32	RC . T1606 .. 32	RC . T2006 .. 32
	Clamping screw for insert	FS2061 (Torx 7IP)	FS1462 (Torx 9IP)	FS2063 (Torx 15IP)	FS2060 (Torx 15 IP)	FS2090 (Torx 20IP)	FS2089 (Torx 25IP)
	Tightening torque	0,9 Nm	0,9 Nm	3,0 Nm	3,0 Nm	6,4 Nm	9,5 Nm
	Shim			AP324- RC10T3	AP325- RC1204	AP326- RC1606	AP327- RC2006
	Screw for shim			FS2068 (SW 3,5)	FS2068 (SW 3,5)	FS2091 (SW 5)	FS2092 (SW 6)
	Torx key	FS1490 (Torx 7IP)	FS1466 (Torx 9IP)	FS1465 (Torx 15IP/SW 3,5)	FS1465 (Torx 15IP/SW 3,5)	FS1464 (Torx 20IP)	FS1592 (Torx T25IP)



Walter Turn PRGC

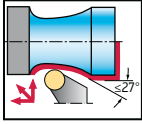

- positive toolholder range
- external machining
- lever type clamping

Tool

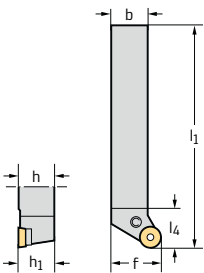

Designation		h = h ₁ mm	b mm	f mm	l ₁ mm	l ₄ mm	γ	λ _s	Type
PRGCR/L2020K10	10	20	20	25	125	20	0°	0°	RC...10T3...
PRGCR/L2525M10	10	25	25	32	150	20	0°	0°	
PRGCR/L2020K12	12	20	20	25	125	22	0°	0°	RC...1204...
PRGCR/L2525M12	12	25	25	32	150	22	0°	0°	
PRGCR/L3225P12	12	32	25	32	170	22	0°	0°	RC...1605...
PRGCR/L3225P16	16	32	25	32	170	28	0°	0°	
PRGCR/L3232P20	20	32	32	40	170	32	0°	0°	RC...2006...
PRGCR/L4040S25	25	40	40	50	250	38	0°	0°	RC...2507...

Measured with master insert RC...0602M0... / RC...0803M0... / RC...10T3M0... / RC...1204M0... / RC...1605M0... / RC...2006M0... / RC...2507M0...

For information on the rake angle γ (for indexable inserts without geometry) and on the inclination angle λ_s, see page A 301.

Bodies and assembly parts are included in the scope of delivery.

Assembly parts



Type h mm	RC...10T3... 20-25	RC...1204... 20-32	RC...1605... 32	RC...2006... 32	RC...2507... 40
Shim	AP407-RC10T3	AP402-RC1204	AP403-RC1605	AP404-RC2006	AP405-RC2507
Lever	KN122	KN123	KN111	KN112	KN113
Clamping screw Tightening torque	FS2155 (SW 2) 0,6 Nm	FS351 (SW 2,5) 2,0 Nm	FS344 (SW 2,5) 2,5 Nm	FS2156 (SW 3) 5 Nm	FS2145 (SW 4) 10 Nm
Pipe pin	RS101	RS120	RS118	RS103	RS104
Assembly plug	MD101	MD101	MD101	MD102	MD102
Allen key	ISO 2936-2 (SW 2)	ISO 2936-2,5 (SW 2,5)	ISO 2936-2,5 (SW 2,5)	ISO 2936-3 (SW 3)	ISO 2936-4 (SW 4)

Accessories



Type h mm	RC...10T3... 20-25	RC...1605... 32
Shim for RC...1003...	AP401-RC1003	
Shim for RC...1606...		AP403-RC1606



Walter Turn SSDC / SSDCN / SSBC

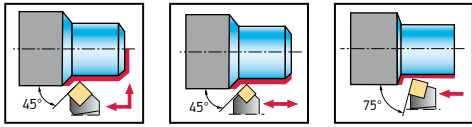

- positive toolholder range
- external machining
- screw clamping

Tool		Designation	h = h ₁ mm	b mm	f mm	f ₁ mm	l ₁ mm	l ₄ mm	l ₂₀ mm	γ	λ _s	Type	
κ = 45°		SSDCR/L1616H09	9	16	16	17	10,9	93,9	15,1	100	0°	0°	SC..09T3..
		SSDCR/L2020K09	9	20	20	22	15,9	118,9	18	125	0°	0°	
		SSDCR/L2020K12	12	20	20	22	13,7	116,7	21,7	125	0°	0°	SC..1204..
		SSDCR/L2525M12	12	25	25	27	18,7	141,7	21,7	150	0°	0°	
κ = 45°		SSDCN1212F09	9	12	12	6		80	16		0°	0°	SC..09T3..
		SSDCN1616H09	9	16	16	8		100	16		0°	0°	
		SSDCN2020K12	12	20	20	10		125	22		0°	0°	SC..1204..
		SSDCN2525M12	12	25	25	12,5		150	22		0°	0°	
κ = 75°		SSRCR/L1212F09	9	12	12	14		80	15,5		0°	0°	SC..09T3..
		SSBCR/L1616H09	9	16	16	13		100	15,5		0°	0°	
		SSBCR/L2020K12	12	20	20	17		125	21		0°	0°	SC..1204..
		SSBCR/L2525M12	12	25	25	22		150	24		0°	0°	

Measured with master insert SC..09T308 / SC..120408.

For information on the rake angle γ (for indexable inserts without geometry) and on the inclination angle λ_s, see page A 301.

Bodies and assembly parts are included in the scope of delivery.

Assembly parts	Type h mm	SC..09T3.. 12	SC..09T3.. 16-20	SC..1204.. 20-25
	Clamping screw for insert Tightening torque	FS2063 (Torx 15IP) 3,0 Nm	FS2060 (Torx 15 IP) 3,0 Nm	FS2065 (Torx 15IP) 3,0 Nm
	Shim		AP328-SC0908	AP319-SC1212
	Screw for shim		FS2068 (SW 3,5)	FS2069 (SW 4)
	Torx key	FS1465 (Torx 15IP/SW 3,5)	FS1465 (Torx 15IP/SW 3,5)	FS1496 (Torx 15IP/SW 4)

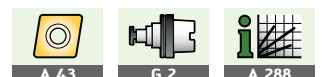

Walter Turn STGC

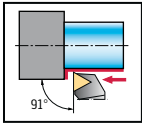

- positive toolholder range
- external machining
- screw clamping

Tool	Designation		h = h ₁ mm	b mm	f mm	l ₁ mm	l ₄ mm	γ	λ _s	Type
κ = 91°	STGCR/L1212F11		11	12	16	80	13	0°	0°	TC..1102..
	STGCR/L1616H16		16	16	20	100	25	0°	0°	TC..16T3..
	STGCR/L2020K16		16	20	25	125	26	0°	0°	
	STGCR/L2525M16		16	25	32	150	27	0°	0°	

Measured with master insert TC . . 110204 / TC . . 16T308.

For information on the rake angle γ (for indexable inserts without geometry) and on the inclination angle λ_s, see page A 301.

Bodies and assembly parts are included in the scope of delivery.

Assembly parts	Type h mm	TC..1102.. 12	TC..16T3.. 16-25
	Clamping screw for insert Tightening torque	FS2061 (Torx 7IP) 0,9 Nm	FS2060 (Torx 15 IP) 3,0 Nm
	Shim		AP317-TC1612 r ≤ 1,2
	Screw for shim		FS2068 (SW 3,5)
	Torx key	FS1490 (Torx 7IP)	FS1465 (Torx 15IP/SW 3,5)

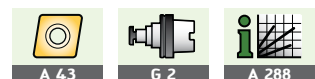

Walter Turn SVJB / SVHB

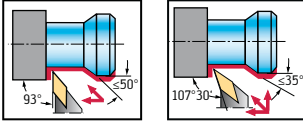
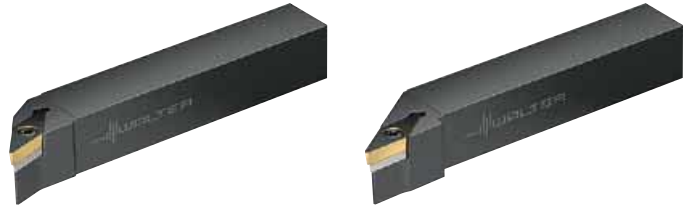

- positive toolholder range
- external machining
- screw clamping

Tool	Designation		h = h ₁ mm	b mm	f mm	l ₁ mm	l ₄ mm	γ	λ _s	Type
κ = 93° 	SVJBR/L1212F11		11	12	16	80	20,6	0°	0°	VB/C...1103...
	SVJBR/L1616H11		11	16	20	100	21,2	0°	0°	
	SVJBR/L2020K11		11	20	25	125	21,2	0°	0°	
	SVJBR/L2525M11		11	25	32	150	21,2	0°	0°	
	SVJBR/L1616H16		16	16	20	100	27	0°	0°	VB/C...1604...
	SVJBR/L2020K16		16	20	25	125	34	0°	0°	
	SVJBR/L2525M16		16	25	32	150	31,5	0°	0°	
	SVJBR/L3225P16		16	32	32	170	31,5	0°	0°	
κ = 107°30' 	SVHBR/L1616H11		11	16	20	100	18	0°	0°	VB/C...1103...
	SVHBR/L2020K11		11	20	25	125	19	0°	0°	
	SVHBR/L2525M11		11	25	32	150	27	0°	0°	
	SVHBR/L2020K16		16	20	25	125	27,6	0°	0°	VB/C...1604...
	SVHBR/L2525M16		16	25	32	150	27,6	0°	0°	
	SVHBR/L3225P16		16	32	32	170	27,6	0°	0°	

Measured with master insert VB...110304 / VB...160408.

For information on the rake angle γ (for indexable inserts without geometry) and on the inclination angle λ_s, see page A 301.

Bodies and assembly parts are included in the scope of delivery.

Assembly parts	Type h mm	VB/C...1103... 12-25	VB/C...1604... 16	VB/C...1604... 20-32
	Clamping screw for insert Tightening torque	FS2061 (Torx 7IP) 0,9 Nm	FS2063 (Torx 15IP) 3,0 Nm	FS2060 (Torx 15 IP) 3,0 Nm
	Shim			AP316-VB1608 r ≤ 0,8
	Screw for shim			FS2068 (SW 3,5)
	Torx key	FS1490 (Torx 7IP)	FS1465 (Torx 15IP/SW 3,5)	FS1465 (Torx 15IP/SW 3,5)

Accessories	Type h mm	VB/C...1604... 20-32
	Shim	AP330-VB1612 r ≤ 1,2

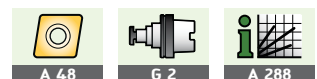

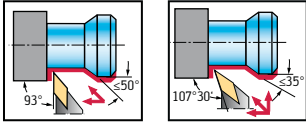
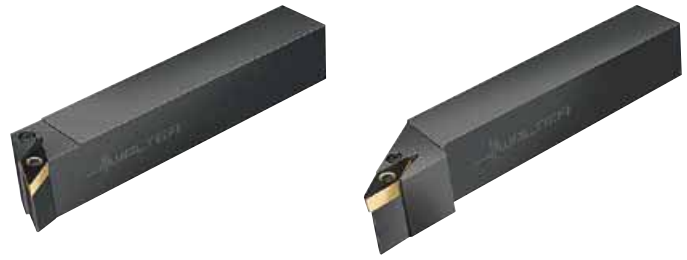
**Walter Turn
PVHB / PVJB**

- positive toolholder range
- external machining
- lever type clamping

Tool	Designation		h = h ₁ mm	b mm	f mm	l ₁ mm	l ₄ mm	γ	λ _s	Type	
κ = 93°	PVJBR/L1616H11		11	16	20	100	25	0°	0°	VB/C . . 1103 . .	
	PVJBR/L2020K11		11	20	25	125	25	0°	0°		
	PVJBR/L2525M11		11	25	32	150	32	0°	0°		
	PVJBR/L1616H16			16	16	20	100	32	0°	0°	VB/C . . 1604 . .
	PVJBR/L2020K16			16	20	25	125	34	0°	0°	
	PVJBR/L2525M16			16	25	32	150	38	0°	0°	
	PVJBR/L3225P16			16	32	32	170	38	0°	0°	
κ = 107°30'	PVHBR/L1616H11		11	16	20	100	25	0°	0°	VB/C . . 1103 . .	
	PVHBR/L2020K11		11	20	25	125	25	0°	0°		
	PVHBR/L2525M11		11	25	32	150	32	0°	0°		
	PVHBR/L2020K16			16	20	25	125	28	0°	0°	VB/C . . 1604 . .
	PVHBR/L2525M16			16	25	32	150	28	0°	0°	
	PVHBR/L3225P16			16	32	32	170	28	0°	0°	

Measured with master insert VB . . 110304 / VB . . 160408.

For information on the rake angle γ (for indexable inserts without geometry) and on the inclination angle λ_s, see page A 301.

Bodies and assembly parts are included in the scope of delivery.

Assembly parts	Type h mm	VB/C . . 1103 . . 16-25	VB/C . . 1604 . . 16	VB/C . . 1604 . . 20-32
	Shim		AP153 r ≤ 0,8	AP153 r ≤ 0,8
	Pipe pin		RS101	RS101
	Lever	KN118	KN110	KN110
	Clamping screw Tightening torque	FS347 (SW 2) 0,6 Nm	FS332 (SW 2,5) 2,5 Nm	FS351 (SW 2,5) 2,0 Nm
	Assembly plug		MD101	MD101
	Allen key	ISO 2936-2 (SW 2)	ISO 2936-2,5 (SW 2,5)	ISO 2936-2,5 (SW 2,5)

Accessories	Type h mm	VB/C . . 1604 . . 16-32
	Shim	AP154 r ≤ 1,2

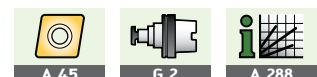

Walter Turn SVVB

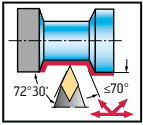

- positive toolholder range
- external machining
- screw clamping

Tool	Designation		h = h ₁ mm	b mm	f mm	l ₁ mm	l ₄ mm	γ	λ _s	Type
	SVVBN1212F11		11	12	6,3	80	21,1	0°	0°	VB/C...1103..
	SVVBN1616H11		11	16	8,3	100	21,1	0°	0°	
	SVVBN2020K11		11	20	10,3	125	21,1	0°	0°	
	SVVBN2525M11		11	25	12,8	150	21,1	0°	0°	VB/C...1604..
	SVVBN2020K16		16	20	10,6	125	31,5	0°	0°	
	SVVBN2525M16		16	25	13,1	150	31,5	0°	0°	
	SVVBN3225P16		16	32	13,1	170	31,5	0°	0°	

Measured with master insert VB...110304 / VB...160408.

For information on the rake angle γ (for indexable inserts without geometry) and on the inclination angle λ_s, see page A 301.

Bodies and assembly parts are included in the scope of delivery.

Assembly parts	Type h mm	VB/C...1103... 12-25	VB/C...1604... 20-32
	Clamping screw for insert Tightening torque	FS2061 (Torx 7IP) 0,9 Nm	FS2060 (Torx 15 IP) 3,0 Nm
	Shim		AP316-VB1608 r ≤ 0,8
	Screw for shim		FS2068 (SW 3,5)
	Torx key	FS1490 (Torx 7IP)	FS1465 (Torx 15IP/SW 3,5)

Accessories	Type h mm	VB/C...1604... 20-32
	Shim	AP330-VB1612 r ≤ 1,2

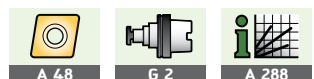

Walter Turn PVVB

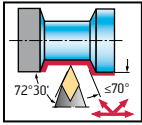

- positive toolholder range
- external machining
- lever type clamping

Tool

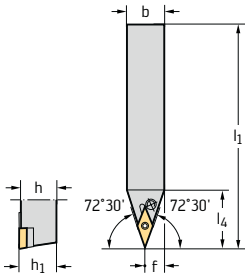
 $\kappa = 72^\circ 30'$

Designation

Designation	$h = h_1$ mm	b mm	f mm	l_1 mm	l_4 mm	γ	λ_s	Type
PVVBN1616H11	11	16	8	100	25	0°	0°	VB/C . . 1103 . .
PVVBN2020K11	11	20	10	125	25	0°	0°	
PVVBN2525M11	11	25	12,5	150	25	0°	0°	
PVVBN2020K16	16	20	10	125	34	0°	0°	VB/C . . 1604 . .
PVVBN2525M16	16	25	12,5	150	34	0°	0°	
PVVBN3225P16	16	32	12,5	170	34	0°	0°	

Measured with master insert VB . . 110304 / VB . . 160408.

 For information on the rake angle γ (for indexable inserts without geometry) and on the inclination angle λ_s , see page A 301.

Bodies and assembly parts are included in the scope of delivery.

Assembly parts



Type h mm	VB/C . . 1103 . . 16-25	VB/C . . 1604 . . 20-32
Shim		AP153 $r \leq 0,8$
Pipe pin		RS101
Lever	KN118	KN110
Clamping screw Tightening torque	FS347 (SW 2) 0,6 Nm	FS351 (SW 2,5) 2,0 Nm
Assembly plug		MD101
Allen key	ISO 2936-2 (SW 2)	ISO 2936-2,5 (SW 2,5)

Accessories



Type h mm	VB/C . . 1604 . . 20-32
Shim	AP154 $r \leq 1,2$



Walter Turn SWLC

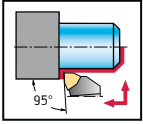



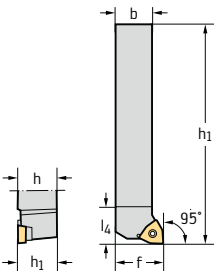

- positive toolholder range
- external machining
- screw clamping

Tool	Designation		h = h ₁ mm	b mm	f mm	l ₁ mm	l ₄ mm	γ	λ _s	Type
κ = 95° 	SWLCR/L1212F04	4	12	12	16	80	11	0°	0°	WC..0402..
	SWLCR/L1616H04	4	16	16	20	100	11	0°	0°	
	SWLCR/L2020K04	4	20	20	25	125	12	0°	0°	
	SWLCR/L1616H06	6	16	16	20	100	15	0°	0°	WC..06T3..
	SWLCR/L2020K06	6	20	20	25	125	15	0°	0°	
	SWLCR/L2525M06	6	25	25	32	150	17	0°	0°	WC..0804..
	SWLCR/L2020K08	8	20	20	25	125	20	0°	0°	
	SWLCR/L2525M08	8	25	25	32	150	21	0°	0°	

Measured with master insert WC .. 040204 / WC .. 06T308 / WC .. 080408.

For information on the rake angle γ (for indexable inserts without geometry) and on the inclination angle λ_s, see page A 301.

Bodies and assembly parts are included in the scope of delivery.

Assembly parts	Type h mm	WC..0402.. 12-20	WC..06T3.. 16-25	WC..0804.. 20-25
	Clamping screw for insert Tightening torque	FS2067 (Torx 7IP) 0,9 Nm	FS2063 (Torx 15IP) 3,0 Nm	FS2065 (Torx 15IP) 3,0 Nm
	Shim		AP318-WC0608	AP320-WC0812
	Screw for shim		FS2068 (SW 3,5)	FS2069 (SW 4)
	Torx key	FS1490 (Torx 7IP)	FS1465 (Torx 15IP/SW 3,5)	FS1496 (Torx 15IP/SW 4)

Walter Capto™

C ... – DCLN

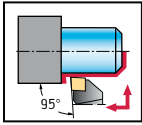

- negative toolholder range
- external machining
- rigid clamping system

Tool

Walter Capto™ ISO 26623
 $\kappa = 95^\circ$

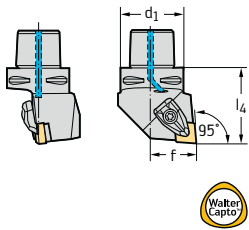

Designation

 d_1
 f
 l_4
 D_{min}
 D_{min2}
 γ
 λ_s

Type

Designation	d_1 mm	f mm	l_4 mm	D_{min} mm	D_{min2} mm	γ	λ_s	Type	
C4-DCLNR/L-27050-12	12	C4	27	50	110	140	-6°	-6°	CN .. 1204 ..
C5-DCLNR/L-35060-12	12	C5	35	60	110	165	-6°	-6°	
C6-DCLNR/L-45065-12	12	C6	45	65	110	190	-6°	-6°	
C8-DCLNR/L-55080-12	12	C8	55	80	110	250	-6°	-6°	
C4-DCLNR/L-27055-16	16	C4	27	55	125	145	-6°	-6°	CN .. 1606 ..
C5-DCLNR/L-35060-16	16	C5	35	60	125	165	-6°	-6°	
C6-DCLNR/L-45065-16	16	C6	45	65	125	190	-6°	-6°	
C8-DCLNR/L-55080-16	16	C8	55	80	125	250	-6°	-6°	
C5-DCLNR/L-35060-19	19	C5	35	60	80	165	-6°	-6°	CN .. 1906 ..
C6-DCLNR/L-45065-19	19	C6	45	65	81	190	-6°	-6°	
C8-DCLNR/L-55080-19	19	C8	55	80	100	250	-6°	-6°	

Measured with master insert CN .. 120408 / CN .. 160612 / CN .. 190612.

Bodies and assembly parts are included in the scope of delivery.

For information on the rake angle γ (for indexable inserts without geometry) and on the inclination angle λ_s , see page A 301.

For information on D_{min} and D_{min2} , see page A 301.

Assembly parts

Type	CN .. 1204 ..	CN .. 1606 ..	CN .. 1906 ..
Shim	AP301-CN12	AP302-CN16	AP303-CN19
Screw for shim	FS1461 (Torx 15IP)	FS1463 (Torx 20IP)	FS1463 (Torx 20IP)
Clamp	PK241	PK242	PK243
Screw for clamp Tightening torque	FS1473 (Torx 15IP) 3,9 Nm	FS1474 (Torx 20IP) 6,4 Nm	FS1474 (Torx 20IP) 6,4 Nm
Pressure spring	FS1470	FS1471	FS1471
Pin	RS117	RS117	RS117
Torx key	FS1465 (Torx 15IP/SW 3,5)	FS1464 (Torx 20IP)	FS1464 (Torx 20IP)
Cooling lubricant nozzle C4	FS1475	FS1475	
Cooling lubricant nozzle C5	FS1475	FS1475	FS1475
Cooling lubricant nozzle C6	FS1475	FS1475	FS1475
Cooling lubricant nozzle C8	FS1475	FS1475	FS1475

Accessories

Type	CN .. 1204 ..	CN .. 1606 ..	CN .. 1906 ..
Clamp set (standard mounting parts)	PK241-SET	PK242-SET	PK243-SET
Clamp set with carbide clamping plate	PK245-SET	PK246-SET	

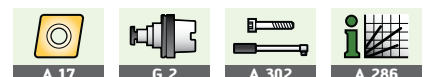

Walter Capto™

C ... – DDJN

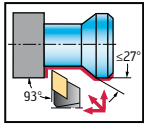

- negative toolholder range
- external machining
- rigid clamping system

Tool	Designation		d ₁ mm	f mm	l ₄ mm	D _{min} mm	D _{min2} mm	γ	λ _s	Type
Walter Capto™ ISO 26623 κ = 93° 	C4-DDJNR/L-27050-11	11	C4	27	50	60	140	-6°	-7°	DN .. 1104 ..
	C5-DDJNR/L-35060-11	11	C5	35	60	65	165	-6°	-7°	
	C6-DDJNR/L-45065-11	11	C6	45	65	81	190	-6°	-7°	
	C4-DDJNR/L-27055-15	15	C4	27	55	110	145	-6°	-7°	DN .. 1506 ..
	C5-DDJNR/L-35060-15	15	C5	35	60	110	165	-6°	-7°	
	C6-DDJNR/L-45065-15	15	C6	45	65	110	190	-6°	-7°	
	C8-DDJNR/L-55080-15	15	C8	55	80	110	250	-6°	-7°	

Measured with master insert DN .. 110408 / DN .. 150608.

Bodies and assembly parts are included in the scope of delivery.

For information on the rake angle γ (for indexable inserts without geometry) and on the inclination angle λ_s, see page A 301.

For information on D_{min} and D_{min2}, see page A 301.

Assembly parts	Type	DN .. 1104 ..	DN .. 1506 ..
	Shim	AP305-DN11	AP304-DN15
	Screw for shim	FS1462 (Torx 9IP)	FS1461 (Torx 15IP)
	Clamp	PK240	PK241
	Screw for clamp	FS1472 (Torx 9IP)	FS1473 (Torx 15IP)
	Tightening torque	1,7 Nm	3,9 Nm
	Pressure spring	FS1469	FS1470
	Pin	RS116	RS117
	Torx key	FS1466 (Torx 9IP)	FS1465 (Torx 15IP/SW 3,5)
	Cooling lubricant nozzle C4	FS1477	FS1477
	Cooling lubricant nozzle C5	FS1476	FS1475
	Cooling lubricant nozzle C6	FS1476	FS1476
	Cooling lubricant nozzle C8		FS1479

Accessories	Type	DN .. 1104 ..	DN .. 1506 ..
	Clamp set (standard mounting parts)	PK240-SET	PK241-SET
	Clamp set with carbide clamping plate		PK245-SET
	Shim		AP304-DN1504 DN .. 1504 ..



Walter Capto™ C ... – DDUN

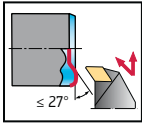

- negative toolholder range
- external machining
- rigid clamping system

Tool

Walter Capto™ ISO 26623
 $\kappa = 93^\circ$

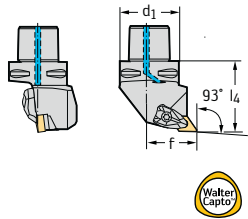

Designation

Designation		d ₁ mm	f mm	l ₄ mm	D _{min} mm	D _{min2} mm	γ	λ _s	Type
C4-DDUNR/L-27050-15	15	C4	27	50	110	140	-6°	-7°	DN .. 1506 ..
C5-DDUNR/L-35060-15	15	C5	35	60	110	165	-6°	-7°	
C6-DDUNR/L-45065-15	15	C6	45	65	110	190	-6°	-7°	
C8-DDUNR/L-55080-15	15	C8	55	80	110	250	-6°	-7°	

Measured with master insert DN .. 150608.

Bodies and assembly parts are included in the scope of delivery.

For information on the rake angle γ (for indexable inserts without geometry) and on the inclination angle λ_s, see page A 301.

For information on D_{min} and D_{min2}, see page A 301.

Assembly parts

	Type	DN .. 1506 ..
	Shim	AP304-DN15
	Screw for shim	FS1461 (Torx 15IP)
	Clamp	PK243
	Screw for clamp	FS1473 (Torx 15IP) 3,9 Nm
	Tightening torque	
	Pressure spring	FS1471
	Pin	RS117
	Torx key	FS1465 (Torx 15IP/SW 3,5)
	Cooling lubricant nozzle C4	FS1477
	Cooling lubricant nozzle C5	FS1476
	Cooling lubricant nozzle C6	FS1476
	Cooling lubricant nozzle C8	FS1479

Accessories

	Type	DN .. 1506 ..
	Clamp set (standard mounting parts)	PK241-SET
	Clamp set with carbide clamping plate	PK245-SET
	Shim	AP304-DN1504 DN .. 1504 ..



Walter Capto™

C ... – DSSN

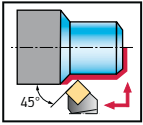

- negative toolholder range
- external machining
- rigid clamping system

Tool	Designation		d ₁ mm	f mm	f ₁ mm	l ₄ mm	l ₂₀ mm	D _{min} mm	D _{min2} mm	γ	λ _s	Type	
Walter Capto™ ISO 26623 κ = 45° 	C4-DSSNR/L-27042-12		12	C4	27	18,7	42	50,3	110	140	-8°	0°	SN .. 1204 ..
	C5-DSSNR/L-35052-12		12	C5	35	26,7	52	60,3	110	165	-8°	0°	
	C6-DSSNR/L-45056-12		12	C6	45	36,7	56	64,3	110	190	-8°	0°	SN .. 1506 ..
	C4-DSSNR/L-27045-15		15	C4	27	16,8	45	55,2	125	145	-8°	0°	
	C5-DSSNR/L-35050-15		15	C5	35	24,8	50	60,2	125	165	-8°	0°	
	C6-DSSNR/L-45054-15		15	C6	45	34,8	54	64,2	125	190	-8°	0°	SN .. 1906 ..
C5-DSSNR/L-35048-19		19	C5	35	22,5	48	60,5	125	165	-8°	0°		
C6-DSSNR/L-45052-19		19	C6	45	32,5	52	64,5	125	190	-8°	0°		

Measured with master insert SN .. 120408 / SN .. 150612 / SN .. 190612.

Bodies and assembly parts are included in the scope of delivery.

For information on the rake angle γ (for indexable inserts without geometry) and on the inclination angle λ_s, see page A 301.

For information on D_{min} and D_{min2}, see page A 301.

Assembly parts		SN .. 1204 ..	SN .. 1506 ..	SN .. 1906 ..
	Shim	AP308-SN12	AP309-SN15	AP310-SN19
	Screw for shim	FS1461 (Torx 15IP)	FS1463 (Torx 20IP)	FS1463 (Torx 20IP)
	Clamp	PK241	PK242	PK243
	Screw for clamp	FS1473 (Torx 15IP)	FS1474 (Torx 20IP)	FS1474 (Torx 20IP)
	Tightening torque	3,9 Nm	6,4 Nm	6,4 Nm
	Pressure spring	FS1470	FS1471	FS1471
	Pin	RS117	RS117	RS117
	Torx key	FS1465 (Torx 15IP/SW 3,5)	FS1464 (Torx 20IP)	FS1464 (Torx 20IP)
	Cooling lubricant nozzle C4	FS1477	FS1477	
	Cooling lubricant nozzle C5	FS1476	FS1476	FS1476
	Cooling lubricant nozzle C6	FS1475	FS1475	FS1476

Accessories		SN .. 1204 ..	SN .. 1506 ..	SN .. 1906 ..
	Clamp set (standard mounting parts)	PK241-SET	PK242-SET	PK243-SET
	Clamp set with carbide clamping plate	PK245-SET	PK246-SET	



Walter Capto™ C ... – DSDN

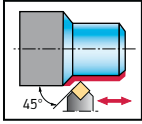

- negative toolholder range
- external machining
- rigid clamping system

Tool	Designation		d ₁ mm	f mm	l ₄ mm	D _{min2} mm	γ	λ _s	Type
Walter Capto™ ISO 26623 κ = 45° 	C4-DSDNN-00050-12	12	C4	0,3	50	140	-6°	-6°	SN .. 1204 ..
	C5-DSDNN-00060-12	12	C5	0,3	60	165	-6°	-6°	
	C6-DSDNN-00065-12	12	C6	0,3	65	190	-6°	-6°	SN .. 1906 ..
	C6-DSDNN-00070-19	19	C6	0,5	70	195	-6°	-6°	
	C8-DSDNN-00080-25	25	C8	1	80	250	-6°	-6°	

Measured with master insert SN .. 120408 / SN .. 190612 / SN .. 25 .. .

Bodies and assembly parts are included in the scope of delivery.

For information on the rake angle γ (for indexable inserts without geometry) and on the inclination angle λ_s, see page A 301.

For information on D_{min} and D_{min2}, see page A 301.

Assembly parts		SN .. 1204 ..	SN .. 1906 ..	SN .. 2507 ..
	Shim	AP308-SN12	AP310-SN19	AP351-SN25
	Screw for shim	FS1461 (Torx 15IP)	FS1463 (Torx 20IP)	FS1589 (Torx T25IP)
	Clamp	PK241	PK243	PK301
	Screw for clamp	FS1473 (Torx 15IP)	FS1474 (Torx 20IP)	FS1591 (Torx T25IP)
	Tightening torque	3,9 Nm	6,4 Nm	9,5 Nm
	Pressure spring	FS1470	FS1471	FS1471
	Pin	RS117	RS117	RS117
	Torx key	FS1465 (Torx 15IP/SW 3,5)	FS1464 (Torx 20IP)	FS1592 (Torx T25IP)
	Cooling lubricant nozzle C4	FS1477		
	Cooling lubricant nozzle C5	FS1475		
	Cooling lubricant nozzle C6	FS1475	FS1475	
	Cooling lubricant nozzle C8			FS1475

Accessories		SN .. 1204 ..	SN .. 1906 ..	SN .. 2507 ..
	Clamp set (standard mounting parts)	PK241-SET	PK243-SET	PK301-SET
	Clamp set with carbide clamping plate	PK245-SET		
	Shim			AP351-SN2509 SN .. 2509 ..

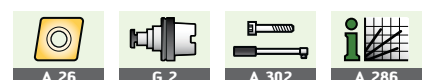

Walter Capto™

C ... – DSRN

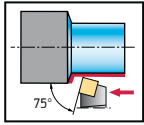

- negative toolholder range
- external machining
- rigid clamping system

Tool	Designation		d ₁ mm	f mm	l ₄ mm	D _{min2} mm	γ	λ _s	Type	
Walter Capto™ ISO 26623 κ = 75° 	C4-DSRNR/L-22050-12		12	C4	22	50	140	-6°	-6°	SN .. 1204 ..
	C5-DSRNR/L-27060-12		12	C5	27	60	165	-6°	-6°	
	C6-DSRNR/L-35065-12		12	C6	35	65	190	-6°	-6°	SN .. 1506 ..
	C5-DSRNR/L-27060-15		15	C5	27	60	165	-6°	-6°	
	C6-DSRNR/L-35065-15		15	C6	35	65	190	-6°	-6°	SN .. 1906 ..
	C6-DSRNR/L-35065-19		19	C6	35	65	190	-6°	-6°	
	C8-DSRNR/L-45080-19		19	C8	45	80	250	-6°	-6°	SN .. 2507 ..
	C8-DSRNR/L-45080-25		25	C8	45	80	250	-6°	-6°	

Measured with master insert SN .. 120408 / SN .. 150612 / SN .. 190612.

Bodies and assembly parts are included in the scope of delivery.

For information on the rake angle γ (for indexable inserts without geometry) and on the inclination angle λ_s, see page A 301.

For information on D_{min} and D_{min2}, see page A 301.

Assembly parts	Type	SN .. 1204 ..	SN .. 1506 ..	SN .. 1906 ..	SN .. 2507 ..
	Shim	AP308-SN12	AP309-SN15	AP310-SN19	AP351-SN25
	Screw for shim	FS1461 (Torx 15IP)	FS1463 (Torx 20IP)	FS1463 (Torx 20IP)	FS1589 (Torx T25IP)
	Clamp	PK241	PK242	PK243	PK301
	Screw for clamp	FS1473 (Torx 15IP)	FS1474 (Torx 20IP)	FS1474 (Torx 20IP)	FS1591 (Torx T25IP)
	Tightening torque	3,9 Nm	6,4 Nm	6,4 Nm	9,5 Nm
	Pressure spring	FS1470	FS1471	FS1471	FS1471
	Pin	RS117	RS117	RS117	RS117
	Torx key	FS1465 (Torx 15IP/SW 3,5)	FS1464 (Torx 20IP)	FS1464 (Torx 20IP)	FS1592 (Torx T25IP)
	Cooling lubricant nozzle C4	FS1475			
	Cooling lubricant nozzle C5	FS1475	FS1475		
	Cooling lubricant nozzle C6	FS1475	FS1475	FS1475	
	Cooling lubricant nozzle C8			FS1475	FS1475

Accessories	Type	SN .. 1204 ..	SN .. 1506 ..	SN .. 1906 ..	SN .. 2507 ..
	Clamp set (standard mounting parts)	PK241-SET	PK242-SET	PK243-SET	PK301-SET
	Clamp set with carbide clamping plate	PK245-SET	PK246-SET		
	Shim				AP351-SN2509 SN .. 2509 ..



Walter Capto™

C ... – DSKN

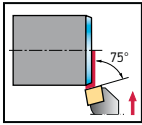

- negative toolholder range
- external machining
- rigid clamping system

Tool

Walter Capto™ ISO 26623
 $\kappa = 75^\circ$

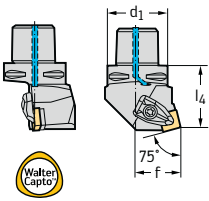

Designation

			d_1 mm	f mm	l_4 mm	D_{min} mm	γ	λ_s	Type
C4-DSKNR/L-27050-12	12	C4	27	50	110	-6°	-6°	SN .. 1204 ..	
C5-DSKNR/L-35060-12	12	C5	35	60	110	-6°	-6°		
C6-DSKNR/L-45065-12	12	C6	45	65	110	-6°	-6°		
C5-DSKNR/L-35060-15	15	C5	35	60	125	-6°	-6°	SN .. 1506 ..	
C6-DSKNR/L-45065-15	15	C6	45	65	125	-6°	-6°		
C6-DSKNR/L-45065-19	19	C6	45	65	125	-6°	-6°	SN .. 1906 ..	
C8-DSKNR/L-55080-19	19	C8	55	80	125	-6°	-6°		

Measured with master insert SN .. 120408 / SN .. 150612 / SN .. 190612.

Bodies and assembly parts are included in the scope of delivery.

For information on the rake angle γ (for indexable inserts without geometry) and on the inclination angle λ_s , see page A 301.

For information on D_{min} and D_{min2} , see page A 301.

Assembly parts

	Type	SN .. 1204 ..	SN .. 1506 ..	SN .. 1906 ..
	Shim	AP308-SN12	AP309-SN15	AP310-SN19
	Screw for shim	FS1461 (Torx 15IP)	FS1463 (Torx 20IP)	FS1463 (Torx 20IP)
	Clamp	PK241	PK242	PK243
	Screw for clamp	FS1473 (Torx 15IP)	FS1474 (Torx 20IP)	FS1474 (Torx 20IP)
	Tightening torque	3,9 Nm	6,4 Nm	6,4 Nm
	Pressure spring	FS1470	FS1471	FS1471
	Pin	RS117	RS117	RS117
	Torx key	FS1465 (Torx 15IP/SW 3,5)	FS1464 (Torx 20IP)	FS1464 (Torx 20IP)
	Cooling lubricant nozzle C4	FS1477		
	Cooling lubricant nozzle C5	FS1476	FS1476	
	Cooling lubricant nozzle C6	FS1476	FS1476	FS1476
	Cooling lubricant nozzle C8			FS1479

Accessories

	Type	SN .. 1204 ..	SN .. 1506 ..	SN .. 1906 ..
	Clamp set (standard mounting parts)	PK241-SET	PK242-SET	PK243-SET
	Clamp set with carbide clamping plate	PK245-SET	PK246-SET	

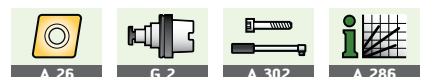

Walter Capto™

C ... – DVJN

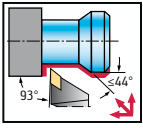

- negative toolholder range
- external machining
- rigid clamping system

Tool	Designation		d ₁ mm	f mm	l ₄ mm	D _{min} mm	D _{min2} mm	γ	λ _s	Type
Walter Capto™ ISO 26623 κ = 93°	C4-DVJNR/L-27062-16	16	C4	27	62	60	152	-4°	-13°	VN .. 1604 ..
	C5-DVJNR/L-35065-16	16	C5	35	65	65	170	-4°	-13°	
	C6-DVJNR/L-45065-16	16	C6	45	65	81	190	-4°	-13°	
	C8-DVJNR/L-55080-16	16	C8	55	80	100	250	-4°	-13°	

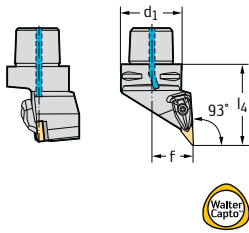

Measured with master insert VN .. 160408.

Bodies and assembly parts are included in the scope of delivery.

For information on the rake angle γ (for indexable inserts without geometry) and on the inclination angle λ_s, see page A 301.

For information on D_{min} and D_{min2}, see page A 301.

Assembly parts

	Type	VN .. 1604 ..
	Shim	AP312-VN16
	Screw for shim	FS1467 (Torx 15IP)
	Clamp	PK244
	Screw for clamp	FS1473 (Torx 15IP)
	Tightening torque	1,7 Nm
	Pressure spring	FS1470
	Pin	RS117
	Torx key	FS1465 (Torx 15IP/SW 3,5)
	Cooling lubricant nozzle C4	FS1477
	Cooling lubricant nozzle C5	FS1476
	Cooling lubricant nozzle C6	FS1476
	Cooling lubricant nozzle C8	FS1479

Accessories

	Type	VN .. 1604 ..
	Clamp set (standard mounting parts)	PK244-SET



A 34



G 2



A 302



A 286

Walter Capto™

C ... – DWLN

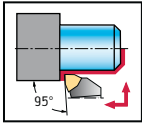

- negative toolholder range
- external machining
- rigid clamping system

Tool

Walter Capto™ ISO 26623
 $\kappa = 95^\circ$

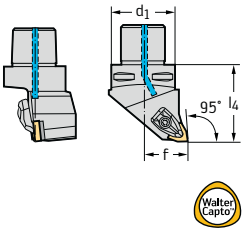

Designation		d ₁ mm	f mm	l ₄ mm	D _{min} mm	D _{min2} mm	γ	λ _s	Type
C4-DWLN/L-27050-06	6	C4	27	50	60	140	-6°	-6°	WN .. 0604 ..
C5-DWLN/L-35060-06	6	C5	35	60	65	165	-6°	-6°	
C6-DWLN/L-45065-06	6	C6	45	65	81	190	-6°	-6°	
C4-DWLN/L-27050-08	8	C4	27	50	110	140	-6°	-6°	WN .. 0804 ..
C5-DWLN/L-35060-08	8	C5	35	60	110	165	-6°	-6°	
C6-DWLN/L-45065-08	8	C6	45	65	110	190	-6°	-6°	
C5-DWLN/L-35060-10	10	C5	35	60	115	170	-6°	-6°	WN .. 1006 ..
C6-DWLN/L-45065-10	10	C6	45	65	115	195	-6°	-6°	

Measured with master insert WN .. 060408 / WN .. 080408 / WN .. 100612.

Bodies and assembly parts are included in the scope of delivery.

For information on the rake angle γ (for indexable inserts without geometry) and on the inclination angle λ_s, see page A 301.

For information on D_{min} and D_{min2}, see page A 301.

Assembly parts

Type	WN .. 0604 ..	WN .. 0804 ..	WN .. 1006 ..
Shim	AP306-WN06	AP307-WN08 r ≤ 1,6	AP311-WN10
Clamp	PK240	PK241	PK242
Screw for clamp Tightening torque	FS1472 (Torx 9IP) 1,7 Nm	FS1473 (Torx 15IP) 3,9 Nm	FS1474 (Torx 20IP) 6,4 Nm
Pressure spring	FS1469	FS1470	FS1471
Pin	RS116	RS117	RS117
Screw for shim	FS1462 (Torx 9IP)	FS1461 (Torx 15IP)	FS1463 (Torx 20IP)
Torx key	FS1466 (Torx 9IP)	FS1465 (Torx 15IP/SW 3,5)	FS1464 (Torx 20IP)
Cooling lubricant nozzle C4	FS1477	FS1477	
Cooling lubricant nozzle C5	FS1475	FS1475	FS1475
Cooling lubricant nozzle C6	FS1475	FS1475	FS1475

Accessories

Type	WN .. 0604 ..	WN .. 0804 ..	WN .. 1006 ..
Clamp set (standard mounting parts)	PK240-SET	PK241-SET	PK242-SET
Clamp set with carbide clamping plate		PK245-SET	PK246-SET

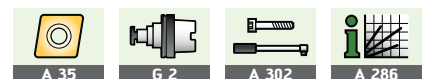

Walter Capto™

C ... – PCLN

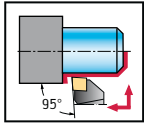

- negative toolholder range
- external machining
- lever type clamping

Tool	Designation		d ₁ mm	f mm	l ₄ mm	D _{min} mm	D _{min2} mm	γ	λ _s	Type	
Walter Capto™ ISO 26623 κ = 95° 	C3-PCLNR/L-22040-12	12	C3	22	40	60	116	-6°	-6°	CN..1204..	
	C4-PCLNR/L-27050-12	12	C4	27	50	60	140	-6°	-6°		
	C5-PCLNR/L-35060-12	12	C5	35	60	65	165	-6°	-6°		
	C6-PCLNR/L-45065-12	12	C6	45	65	81	190	-6°	-6°		
	C8-PCLNR/L-55080-12	12	C8	55	80	100	250	-6°	-6°		
	C4-PCLNR/L-27050-16	16	C4	27	50	80	140	-6°	-6°		CN..1606..
	C5-PCLNR/L-35060-16	16	C5	35	60	80	165	-6°	-6°		
	C6-PCLNR/L-45065-16	16	C6	45	65	81	190	-6°	-6°		
	C8-PCLNR/L-55080-16	16	C8	55	80	100	250	-6°	-6°		
	C5-PCLNR/L-35060-19	19	C5	35	60	80	165	-6°	-6°	CN..1906..	
	C6-PCLNR/L-45065-19	19	C6	45	65	81	190	-6°	-6°		
	C8-PCLNR/L-55080-19	19	C8	55	80	100	250	-6°	-6°		
	C8-PCLNR/L-55080-25	25	C8	55	80	80	150	250	-6°	-6°	CN..2509..

Measured with master insert CN .. 120408 / CN .. 160612 / CN .. 190612 / CN .. 250924

Bodies and assembly parts are included in the scope of delivery.

For information on the rake angle γ (for indexable inserts without geometry) and on the inclination angle λ_s, see page A 301.

For information on D_{min} and D_{min2}, see page A 301.

Assembly parts	Type	CN..1204..	CN..1606..	CN..1906..	CN..2509..
	Shim	AP134-CN1216 r ≤ 1,6	AP135-CN1624 r ≤ 2,4	AP136-CN1924 r ≤ 2,4	AP192-CN2524 r ≤ 2,4
	Lever	KN102	KN104	KN106	KN107
	Clamping screw	FS352 (SW 3)	FS354 (SW 3)	FS356 (SW 4)	FS357 (SW 5)
	Tightening torque	5,0 Nm	5,0 Nm	10,0 Nm	14,0 Nm
	Pipe pin	RS102	RS103	RS104	RS105
	Assembly plug	MD101	MD102	MD102	MD103
	Allen key	ISO 2936-3 (SW 3)	ISO 2936-3 (SW 3)	ISO 2936-4 (SW 4)	ISO 2936-5 (SW 5)
	Cooling lubricant nozzle C3	FS1477			
	Cooling lubricant nozzle C4	FS1477	FS1477		
	Cooling lubricant nozzle C5	FS1476	FS1476	FS1476	
	Cooling lubricant nozzle C6	FS1476	FS1476	FS1476	
	Cooling lubricant nozzle C8	FS1479	FS1479	FS1479	FS1479

Accessories	Type	CN..1204..	CN..1606..	CN..1906..
	Shim	AP134-CN1208 r ≤ 0,8	AP135-CN1616 r ≤ 1,6	AP136-CN1912 r ≤ 1,2



Walter Capto™

C ... – PDJN

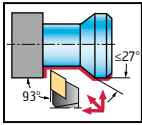

- negative toolholder range
- external machining
- lever type clamping

Tool

Walter Capto™ ISO 26623
 $\kappa = 93^\circ$

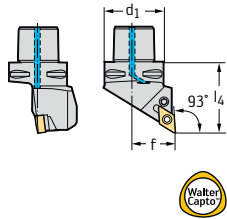

Designation		d ₁ mm	f mm	l ₄ mm	D _{min} mm	D _{min2} mm	γ	λ _s	Type	
C3-PDJNR/L-22045-11		11	C3	22	45	80	116	-6°	-7°	DN .. 1104 ..
C4-PDJNR/L-27050-11		11	C4	27	50	80	140	-6°	-7°	
C5-PDJNR/L-35060-11		11	C5	35	60	80	165	-6°	-7°	
C4-PDJNR/L-27050-15		15	C4	27	50	80	140	-6°	-7°	DN .. 1506 ..
C5-PDJNR/L-35060-15		15	C5	35	60	80	165	-6°	-7°	
C6-PDJNR/L-45065-15		15	C6	45	65	81	190	-6°	-7°	

Measured with master insert DN .. 110408 / DN .. 150608.

Bodies and assembly parts are included in the scope of delivery.

For information on the rake angle γ (for indexable inserts without geometry) and on the inclination angle λ_s, see page A 301.

For information on D_{min} and D_{min2}, see page A 301.

Assembly parts

Type	DN .. 1104 ..	DN .. 1506 ..
Shim	AP171-DN1112 r ≤ 1,2	AP145-DN1516 r ≤ 1,6
Lever	KN119	KN103
Clamping screw Tightening torque	FS351 (SW 2,5) 2,0 Nm	FS355 (SW 3) 5,0 Nm
Pipe pin	RS101	RS102
Assembly plug	MD101	MD101
Allen key	ISO 2936-2.5 (SW 2,5)	ISO 2936-3 (SW 3)
Cooling lubricant nozzle C3	FS1477	
Cooling lubricant nozzle C4	FS1477	FS1477
Cooling lubricant nozzle C5	FS1476	FS1476
Cooling lubricant nozzle C6		FS1476

Accessories

Type	DN .. 1104 ..	DN .. 1506 ..
Shim	AP171-DN1108 r ≤ 0,8	AP145-DN1508 r ≤ 0,8
Shim for DN .. 1504 ..		AP357-DN1508 r ≤ 0,8
		AP357-DN1516 r ≤ 1,6



Walter Capto™

C ... – PSSN

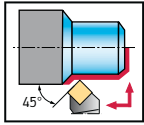

- negative toolholder range
- external machining
- lever type clamping

Tool	Designation		d ₁ mm	f mm	f ₁ mm	l ₄ mm	l ₂₀ mm	D _{min} mm	D _{min2} mm	γ	λ _s	Type	
Walter Capto™ ISO 26623 κ = 45° 	C3-PSSNR/L-22032-12		12	C3	22	13,4	32	40,3	60	108	-8°	0°	SN ... 1204 ...
	C4-PSSNR/L-27042-12		12	C4	27	18,7	42	50,3	60	132	-8°	0°	
	C5-PSSNR/L-35052-12		12	C5	35	26,7	52	60,3	65	157	-8°	0°	
	C6-PSSNR/L-45056-12		12	C6	45	36,7	56	64,5	81	181	-8°	0°	SN ... 1506 ...
	C6-PSSNR/L-45054-15		15	C6	45	34,8	54	64,2	100	179	-8°	0°	
	C6-PSSNR/L-45052-19		19	C6	45	32,5	52	64,5	100	177	-8°	0°	

Measured with master insert SN ... 120408 / SN ... 150612 / SN ... 190612.

Bodies and assembly parts are included in the scope of delivery.

For information on the rake angle γ (for indexable inserts without geometry) and on the inclination angle λ_s, see page A 301.

For information on D_{min} and D_{min2}, see page A 301.

Assembly parts		SN ... 1204 ...	SN ... 1506 ...	SN ... 1906 ...
	Shim	AP141-SN1216 r ≤ 1,6	AP142-SN1524 r ≤ 2,4	AP143-SN1924 r ≤ 2,4
	Lever	KN102	KN104	KN106
	Clamping screw	FS352 (SW 3)	FS354 (SW 3)	FS356 (SW 4)
	Tightening torque	5,0 Nm	5,0 Nm	10,0 Nm
	Pipe pin	RS102	RS103	RS104
	Assembly plug	MD101	MD102	MD102
	Allen key	ISO 2936-3 (SW 3)	ISO 2936-3 (SW 3)	ISO 2936-4 (SW 4)
	Cooling lubricant nozzle C3	FS1477		
	Cooling lubricant nozzle C4	FS1477		
	Cooling lubricant nozzle C5	FS1476		
	Cooling lubricant nozzle C6	FS1476	FS1476	FS1476

Accessories		SN ... 1204 ...	SN ... 1506 ...	SN ... 1906 ...
	Shim	AP141-SN1208 r ≤ 0,8	AP142-SN1516 r ≤ 1,6	AP143-SN1912 r ≤ 1,2

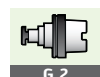

Walter Capto™ C ... – PSRN

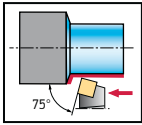

- negative toolholder range
- external machining
- lever type clamping

Tool	Designation		d ₁ mm	f mm	l ₄ mm	γ	λ _s	Type
Walter Capto™ ISO 26623 κ = 75°	C3-PSRNR/L-17040-12	12	C3	17	40	-6°	-6°	SN .. 1204 ..
	C4-PSRNR/L-22050-12	12	C4	22	50	-6°	-6°	
	C5-PSRNR/L-27060-12	12	C5	27	60	-6°	-6°	
	C6-PSRNR/L-35065-12	12	C6	35	65	-6°	-6°	SN .. 1506 ..
	C5-PSRNR/L-27060-15	15	C5	27	60	-6°	-6°	
	C6-PSRNR/L-35065-15	15	C6	35	65	-6°	-6°	SN .. 1906 ..
	C5-PSRNR/L-27060-19	19	C5	27	60	-6°	-6°	
	C6-PSRNR/L-35065-19	19	C6	35	65	-6°	-6°	SN .. 2507 ..
	C8-PSRNR/L-45080-19	19	C8	45	80	-6°	-6°	
	C8-PSRNR/L-45080-25	25	C8	45	80	-6°	-6°	

Measured with master insert SN .. 120408 / SN .. 150612 / SN .. 190612 / SN .. 250924.

Bodies and assembly parts are included in the scope of delivery.

For information on the rake angle γ (for indexable inserts without geometry) and on the inclination angle λ_s, see page A 301.

Assembly parts		SN .. 1204 ..	SN .. 1506 ..	SN .. 1906 ..	SN .. 2507 ..
	Shim	AP141-SN1216 r ≤ 1,6	AP142-SN1524 r ≤ 2,4	AP143-SN1924 r ≤ 2,4	AP144-SN2524 r ≤ 2,4
	Lever	KN102	KN104	KN106	KN107
	Clamping screw	FS352 (SW 3)	FS354 (SW 3)	FS356 (SW 4)	FS357 (SW 5)
	Tightening torque	5,0 Nm	5,0 Nm	10,0 Nm	14,0 Nm
	Pipe pin	RS102	RS103	RS104	RS105
	Assembly plug	MD101	MD102	MD102	MD103
	Allen key	ISO 2936-3 (SW 3)	ISO 2936-3 (SW 3)	ISO 2936-4 (SW 4)	ISO 2936-5 (SW 5)
	Cooling lubricant nozzle C3	FS1477			
	Cooling lubricant nozzle C4	FS1477			
	Cooling lubricant nozzle C5	FS1476	FS1476	FS1476	
	Cooling lubricant nozzle C6	FS1476	FS1476	FS1476	
	Cooling lubricant nozzle C8			FS1479	FS1479

Accessories		SN .. 1204 ..	SN .. 1506 ..	SN .. 1906 ..	SN .. 2507 ..
	Shim	AP141-SN1208 r ≤ 0,8	AP142-SN1516 r ≤ 1,6	AP143-SN1912 r ≤ 1,2	AP191-SN250924 SN .. 250924



Walter Capto™

C ... – PSKN

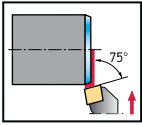

- negative toolholder range
- external machining
- lever type clamping

Tool	Designation		d ₁ mm	f mm	l ₄ mm	D _{min} mm	D _{min2} mm	γ	λ _s	Type
Walter Capto™ ISO 26623 κ = 75° 	C3-PSKNR/L-22040-12	12	C3	22	40	60	116	-6°	-6°	SN .. 1204 ..
	C4-PSKNR/L-27050-12	12	C4	27	50	60	140	-6°	-6°	
	C5-PSKNR/L-35060-12	12	C5	35	60	65	165	-6°	-6°	
	C6-PSKNR/L-45065-12	12	C6	45	65	81	190	-6°	-6°	SN .. 1506 ..
	C5-PSKNR/L-35060-15	15	C5	35	60	80	165	-6°	-6°	
	C6-PSKNR/L-45065-15	15	C6	45	65	81	190	-6°	-6°	
	C5-PSKNR/L-35060-19	19	C5	35	60	80	165	-6°	-6°	SN .. 1906 ..
	C6-PSKNR/L-45065-19	19	C6	45	65	81	190	-6°	-6°	
	C8-PSKNR/L-55080-19	19	C8	55	80	100	250	-6°	-6°	

Measured with master insert SN .. 120408 / SN .. 150612 / SN .. 190612.

Bodies and assembly parts are included in the scope of delivery.

For information on the rake angle γ (for indexable inserts without geometry) and on the inclination angle λ_s, see page A 301.

For information on D_{min} and D_{min2}, see page A 301.

Assembly parts		SN .. 1204 ..	SN .. 1506 ..	SN .. 1906 ..
	Shim	AP141-SN1216 r ≤ 1,6	AP142-SN1524 r ≤ 2,4	AP143-SN1924 r ≤ 2,4
	Lever	KN102	KN104	KN106
	Clamping screw	FS352 (SW 3)	FS354 (SW 3)	FS356 (SW 4)
	Tightening torque	5,0 Nm	5,0 Nm	10,0 Nm
	Pipe pin	RS102	RS103	RS104
	Assembly plug	MD101	MD102	MD102
	Allen key	ISO 2936-3 (SW 3)	ISO 2936-3 (SW 3)	ISO 2936-4 (SW 4)
	Cooling lubricant nozzle C3	FS1477		
	Cooling lubricant nozzle C4	FS1477		
	Cooling lubricant nozzle C5	FS1476	FS1476	FS1476
	Cooling lubricant nozzle C6	FS1476	FS1476	FS1476
	Cooling lubricant nozzle C8			FS1479

Accessories		SN .. 1204 ..	SN .. 1506 ..	SN .. 1906 ..
	Shim	AP141-SN1208 r ≤ 0,8	AP142-SN1516 r ≤ 1,6	AP143-SN1912 r ≤ 1,2



Walter Capto™ C ... – MTJN

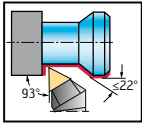

- negative toolholder range
- external machining
- wedge-type clamping system

Tool

Walter Capto™ ISO 26623
 $\kappa = 93^\circ$

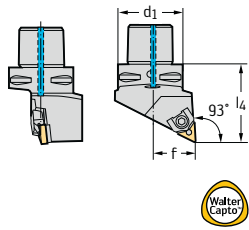

Designation



d_1
mm

f
mm

l_4
mm

γ

λ_s

Type

Designation	d_1 mm	f mm	l_4 mm	γ	λ_s	Type
C3-MTJNR/L-22040-16	16	22	40	-6°	-6°	TN .. 1604 ..
C4-MTJNR/L-27050-16	16	27	50	-6°	-6°	
C5-MTJNR/L-35060-16	16	35	60	-6°	-6°	
C4-MTJNR/L-27050-22	22	27	50	-6°	-6°	TN .. 2204 ..
C5-MTJNR/L-35060-22	22	35	60	-6°	-6°	
C6-MTJNR/L-45065-22	22	45	65	-6°	-6°	

Measured with master insert TN .. 160408 / TN .. 220408.

Bodies and assembly parts are included in the scope of delivery.

For information on the rake angle γ (for indexable inserts without geometry) and on the inclination angle λ_s , see page A 301.

Assembly parts

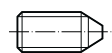
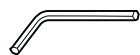
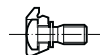

Type

TN .. 1604 ..

TN .. 2204 ..

Shim

AP147
 $r \leq 1,6$

AP148
 $r \leq 1,6$

Pin

RS106

RS107

Clamping wedge set

FK303 (SW 2,5)

FK304 (SW 3)

Allen key

ISO 2936-2,5 (SW 2,5)

ISO 2936-3 (SW 3)

Clamping screw

FS358 (SW 3)

FS358 (SW 3)

Cooling lubricant nozzle C3

FS1230

Cooling lubricant nozzle C4

FS1018

FS1018

Cooling lubricant nozzle C5

FS1019

FS1019

Cooling lubricant nozzle C6

FS1019

Accessories



Type

TN .. 2204 ..

Shim

AP149
 $r \leq 0,8$

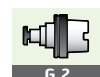

Walter Capto™

C ... – PWLN

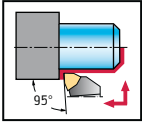

- negative toolholder range
- external machining
- lever type clamping

Tool	Designation		d ₁ mm	f mm	l ₄ mm	D _{min} mm	D _{min2} mm	γ	λ _s	Type
Walter Capto™ ISO 26623 κ = 95°	C3-PWLN/L-22040-06	6	C3	22	40	60	116	-6°	-6°	WN...0604...
	C4-PWLN/L-27050-06	6	C4	27	50	60	140	-6°	-6°	
	C4-PWLN/L-27050-08	8	C4	27	50	60	140	-6°	-6°	WN...0804...
	C5-PWLN/L-35060-08	8	C5	35	60	65	165	-6°	-6°	
	C6-PWLN/L-45065-08	8	C6	45	65	81	190	-6°	-6°	WN...1006...
	C5-PWLN/L-35060-10	10	C5	35	60	80	165	-6°	-6°	
C6-PWLN/L-45065-10	10	C6	45	65	81	190	-6°	-6°		

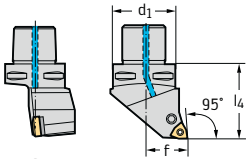







Measured with master insert WN...060408 / WN...080408 / WN...100612.

Bodies and assembly parts are included in the scope of delivery.

For information on the rake angle γ (for indexable inserts without geometry) and on the inclination angle λ_s, see page A 301.

For information on D_{min} and D_{min2}, see page A 301.

Assembly parts	Type	WN...0604...	WN...0804...	WN...1006...
	Shim	AP172-WN0612 r ≤ 1,2	AP170-WN0816 r ≤ 1,6	AP174-WN1016 r ≤ 1,6
	Lever	KN101	KN102	KN104
	Clamping screw Tightening torque	FS351 (SW 2,5) 2,0 Nm	FS352 (SW 3) 5,0 Nm	FS354 (SW 3) 5,0 Nm
	Pipe pin	RS101	RS102	RS103
	Assembly plug	MD101	MD101	MD102
	Allen key	ISO 2936-2,5 (SW 2,5)	ISO 2936-3 (SW 3)	ISO 2936-3 (SW 3)
	Cooling lubricant nozzle C3	FS1477		
	Cooling lubricant nozzle C4	FS1477	FS1477	
	Cooling lubricant nozzle C5		FS1476	FS1476
	Cooling lubricant nozzle C6		FS1476	FS1476

Accessories	Type	WN...0804...
	Shim	AP170-WN0808 r ≤ 0,8



Walter Capto™

C ... – SCLC

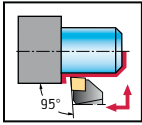

- positive toolholder range
- external machining
- screw clamping

Tool

Walter Capto™ ISO 26623
 $\kappa = 95^\circ$

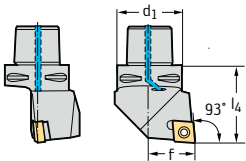

Designation		d ₁ mm	f mm	l ₄ mm	D _{min} mm	D _{min2} mm	γ	λ _s	Type
C3-SCLCR/L-22040-09		9	22	40	130	116	0°	0°	CC...09T3...
C4-SCLCR/L-27050-09		9	27	50	130	140	0°	0°	
C5-SCLCR/L-35060-09		9	35	60	130	165	0°	0°	
C6-SCLCR/L-45065-09		9	45	65	130	190	0°	0°	CC...1204...
C3-SCLCR/L-22040-12		12	22	40	125	116	0°	0°	
C4-SCLCR/L-27050-12		12	27	50	125	140	0°	0°	
C5-SCLCR/L-35060-12		12	35	60	125	165	0°	0°	
C6-SCLCR/L-45065-12		12	45	65	125	190	0°	0°	

Measured with master insert CC...09T308 / CC...120408.

Bodies and assembly parts are included in the scope of delivery.

For information on the rake angle γ (for indexable inserts without geometry) and on the inclination angle λ_s, see page A 301.

For information on D_{min} and D_{min2}, see page A 301.

Assembly parts



Type	CC...09T3...	CC...1204...
Clamping screw for insert Tightening torque	FS2060 (Torx 15 IP) 3,0 Nm	FS2065 (Torx 15IP) 3,0 Nm
Shim	AP313-CC0908 r ≤ 0,8	AP314-CC1212 r ≤ 1,2
Screw for shim	FS2068 (SW 3,5)	FS2069 (SW 4)
Torx key	FS1465 (Torx 15IP/SW 3,5)	FS1496 (Torx 15IP/SW 4)
Cooling lubricant nozzle C3	FS1477	FS1477
Cooling lubricant nozzle C4	FS1477	FS1477
Cooling lubricant nozzle C5	FS1476	FS1476
Cooling lubricant nozzle C6	FS1476	FS1476



Walter Capto™ C ... – SDJC / SDNC

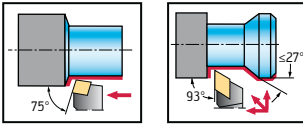

- positive toolholder range
- external machining
- screw clamping

Tool	Designation		d ₁ mm	f mm	l ₄ mm	D _{min} mm	D _{min2} mm	γ	λ _s	Type
Walter Capto™ ISO 26623 κ = 93° 	C3-SDJCR/L-22040-07	7	C3	22	40	70	116	0°	0°	DC ... 0702 ...
	C4-SDJCR/L-27050-07	7	C4	27	50	70	140	0°	0°	
	C3-SDJCR/L-22040-11	11	C3	22	40	140	116	0°	0°	DC ... 11T3 ...
	C4-SDJCR/L-27050-11	11	C4	27	50	140	140	0°	0°	
	C5-SDJCR/L-35060-11	11	C5	35	60	140	165	0°	0°	
	C6-SDJCR/L-45065-11	11	C6	45	65	140	190	0°	0°	
Walter Capto™ ISO κ = 62°30' 	C3-SDNCN-00040-11	11	C3	0,5	40		116	0°	0°	DC ... 11T3 ...
	C4-SDNCN-00050-11	11	C4	0,5	50		140	0°	0°	
	C5-SDNCN-00060-11	11	C5	0,5	60		165	0°	0°	

Measured with master insert DC ... 070204 / DC ... 11T308.

Bodies and assembly parts are included in the scope of delivery.

For information on the rake angle γ (for indexable inserts without geometry) and on the inclination angle λ_s, see page A 301.

For information on D_{min} and D_{min2}, see page A 301.

Assembly parts	Type	DC ... 0702 ...	DC ... 11T3 ...
	Clamping screw for insert Tightening torque	FS2061 (Torx 7IP) 0,9 Nm	FS2060 (Torx 15 IP) 3,0 Nm
	Shim		AP315-DC1108 r ≤ 0,8
	Screw for shim		FS2068 (SW 3,5)
	Torx key	FS1490 (Torx 7IP)	FS1465 (Torx 15IP/SW 3,5)
	Cooling lubricant nozzle C3	FS1477	FS1477
	Cooling lubricant nozzle C4	FS1477	FS1477
	Cooling lubricant nozzle C5		FS1476
	Cooling lubricant nozzle C6		FS1476

Accessories	Type	DC ... 11T3 ...
	Shim	AP329-DC1112 r ≤ 1,2

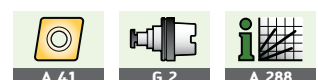

Walter Capto™

C ... – SRDC

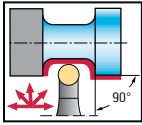

- positive toolholder range
- external machining
- screw clamping

Tool

Walter Capto™ ISO 26623

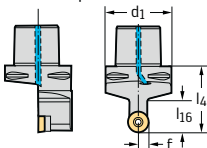

Designation

 d_1
 f
 l_4
 l_{16}
 γ
 λ_s

Type

Designation	d_1 mm	f mm	l_4 mm	l_{16} mm	γ	λ_s	Type
C3-SRDCN-00040-06	6	C3	3	40	12	0°	RC . T0602 ..
C4-SRDCN-00050-06	6	C4	3	50	12	0°	
C5-SRDCN-00060-06	6	C5	3	60	12	0°	
C3-SRDCN-00040-08	8	C3	4	40	16	0°	RC . T0803 ..
C4-SRDCN-00050-08	8	C4	4	50	16	0°	
C5-SRDCN-00060-08	8	C5	4	60	16	0°	
C3-SRDCN-00040-10	10	C3	5	40	20	0°	RC . T10T3 ..
C4-SRDCN-00050-10	10	C4	5	50	25	0°	
C5-SRDCN-00060-10	10	C5	5	60	25	0°	
C6-SRDCN-00065-10	10	C6	5	65	25	0°	RC . T1204 ..
C4-SRDCN-00050-12	12	C4	6	50	28	0°	
C5-SRDCN-00060-12	12	C5	6	60	28	0°	
C6-SRDCN-00065-12	12	C6	6	65	28	0°	RC . T1606 ..
C5-SRDCN-00060-16	16	C5	8	60	35	0°	
C6-SRDCN-00065-16	16	C6	8	65	35	0°	
C5-SRDCN-00060-20	20	C5	10	60	40	0°	RC . T2006 ..
C6-SRDCN-00065-20	20	C6	10	65	40	0°	

Measured with master insert RC . .0602M0 . . / RC . .0803M0 . . / RC . .10T3M0 . . / RC . .1204M0 . . / RC . .1605M0 . . / RC . .2006M0 . .

Bodies and assembly parts are included in the scope of delivery.

 For information on the rake angle γ (for indexable inserts without geometry) and on the inclination angle λ_s , see page A 301.

Assembly parts

Type	RC . T0602 ..	RC . T0803 ..	RC . T10T3 ..	RC . T1204 ..	RC . T1606 ..	RC . T2006 ..
 Clamping screw for insert Tightening torque	FS2061 (Torx 7IP)	FS1462 (Torx 9IP)	FS2063 (Torx 15IP)	FS2060 (Torx 15 IP)	FS2090 (Torx 20IP)	FS2089 (Torx 25IP)
	0,9 Nm	0,9 Nm	3,0 Nm	3,0 Nm	6,4 Nm	9,5 Nm
 Shim			AP324- RC10T3	AP325- RC1204	AP326- RC1606	AP327- RC2006
 Screw for shim			FS2068 (SW 3,5)	FS2068 (SW 3,5)	FS2091 (SW 5)	FS2092 (SW 6)
 Torx key	FS1490 (Torx 7IP)	FS1466 (Torx 9IP)	FS1465 (Torx 15IP/SW 3,5)	FS1465 (Torx 15IP/SW 3,5)	FS1464 (Torx 20IP)	FS1592 (Torx T25IP)
 Cooling lubricant nozzle C3	FS1477	FS1477	FS1477			
 Cooling lubricant nozzle C4	FS1477	FS1477	FS1477	FS1477		
 Cooling lubricant nozzle C5	FS1476	FS1476	FS1476	FS1476	FS1476	FS1476
 Cooling lubricant nozzle C6			FS1476	FS1476	FS1476	FS1476



A 43



G 2



A 288

Walter Capto™

C ... – PRDC

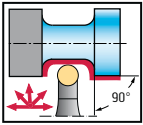

- positive toolholder range
- external machining
- lever type clamping

Tool	Designation		d ₁ mm	f mm	l ₄ mm	l ₁₆ mm	Y	λ _s	Type
Walter Capto™ ISO 26623	C5-PRDCN-00060-16	16	C5	8	60	35	0°	0°	RC ... 1605 ..
	C6-PRDCN-00065-16	16	C6	8	65	35	0°	0°	
	C5-PRDCN-00060-20	20	C5	10	60	40	0°	0°	RC ... 2006 ..
	C6-PRDCN-00065-20	20	C6	10	65	40	0°	0°	
	C6-PRDCN-00065-25	25	C6	10	65	40	0°	0°	RC ... 2507 ..

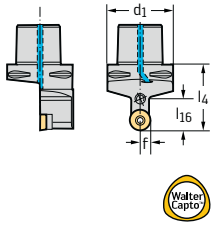

Measured with master insert RC ... 0602M0 .. / RC ... 0803M0 .. / RC ... 10T3M0 .. / RC ... 1204M0 .. / RC ... 1605M0 .. / RC ... 2006M0 .. / RC ... 2507M0 ..

Bodies and assembly parts are included in the scope of delivery.

For information on the rake angle γ (for indexable inserts without geometry) and on the inclination angle λ_s, see page A 301.

Assembly parts		RC ... 1605 ..	RC ... 2006 ..	RC ... 2507 ..
	Shim	AP157	AP158	AP405-RC2507
	Lever	KN111	KN112	KN113
	Pipe pin	RS108	RS103	RS104
	Clamping screw	FS344 (SW 2,5)	FS354 (SW 3)	FS2145 (SW 4)
	Tightening torque		5,0 Nm	10 Nm
	Assembly plug	MD102	MD102	MD102
	Torx key	FS1155 (SW 2,5)		ISO2936-4 (SW 4)
	Cooling lubricant nozzle C5	FS1019	FS1019	
	Cooling lubricant nozzle C6	FS1019	FS1019	FS1476

Accessories		RC ... 1605 ..		
	Shim for RC ... 1606	AP188		



Walter Capto™

C ... – SRSC

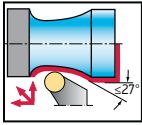

- positive toolholder range
- external machining
- screw clamping

Tool	Designation		d ₁ mm	f mm	l ₄ mm	D _{min} mm	D _{min2} mm	γ	λ _s	Type
Walter Capto™ ISO 26623 	C3-SRSCR/L-22040-06		6	22	40	160	116	0°	0°	RC . T 0602 ...
	C4-SRSCR/L-27050-06		6	27	50	160	140	0°	0°	
	C5-SRSCR/L-35060-06		6	35	60	160	165	0°	0°	
	C3-SRSCR/L-22040-08		8	22	40	110	116	0°	0°	RC . T 0803 ...
	C4-SRSCR/L-27050-08		8	27	50	110	140	0°	0°	
	C5-SRSCR/L-35060-08		8	35	60	110	165	0°	0°	
	C3-SRSCR/L-22040-10		10	22	40	150	116	0°	0°	RC . T 10T3 ...
	C4-SRSCR/L-27050-10		10	27	50	150	140	0°	0°	
	C5-SRSCR/L-35060-10		10	35	60	150	165	0°	0°	
	C6-SRSCR/L-45065-10		10	45	65	150	190	0°	0°	RC . T 1204 ...
	C4-SRSCR/L-27050-12		12	27	50	150	140	0°	0°	
	C5-SRSCR/L-35060-12		12	35	60	150	165	0°	0°	
	C6-SRSCR/L-45065-12		12	45	65	150	190	0°	0°	RC . T 1606 ...
	C5-SRSCR/L-35060-16		16	35	60	175	165	0°	0°	
	C6-SRSCR/L-45065-16		16	45	65	175	190	0°	0°	
	C5-SRSCR/L-35060-20		20	35	60	175	165	0°	0°	RC . T 2006 ...
	C6-SRSCR/L-45065-20		20	45	65	175	190	0°	0°	

Measured with master insert RC . . 0602M0 . . / RC . . 0803M0 . . / RC . . 10T3M0 . . / RC . . 1204M0 . . / RC . . 1605M0 . . / RC . . 2006M0 . . / RC . . 2507M0 . .

Bodies and assembly parts are included in the scope of delivery.

For information on the rake angle γ (for indexable inserts without geometry) and on the inclination angle λ_s, see page A 301.

For information on D_{min} and D_{min2}, see page A 301.

Assembly parts

Type	RC . T 0602 ...	RC . T 0803 ...	RC . T 10T3 ...	RC . T 1204 ...	RC . T 1606 ...	RC . T 2006 ...
	FS2061 (Torx 7IP)	FS1462 (Torx 9IP)	FS2063 (Torx 15IP)	FS2060 (Torx 15 IP)	FS2090 (Torx 20IP)	FS2089 (Torx 25IP)
	Tightening torque	0,9 Nm	0,9 Nm	3,0 Nm	3,0 Nm	6,4 Nm
Shim			AP324-RC10T3	AP325-RC1204	AP326-RC1606	AP327-RC2006
Screw for shim			FS2068 (SW 3,5)	FS2068 (SW 3,5)	FS2091 (SW 5)	FS2092 (SW 6)
Torx key	FS1490 (Torx 7IP)	FS1466 (Torx 9IP)	FS1465 (Torx 15IP/SW 3,5)	FS1465 (Torx 15IP/SW 3,5)	FS1464 (Torx 20IP)	FS1592 (Torx T25IP)
Cooling lubricant nozzle C3	FS1477	FS1477	FS1477			
Cooling lubricant nozzle C4	FS1477	FS1477	FS1477	FS1477		
Cooling lubricant nozzle C5	FS1476	FS1476	FS1476	FS1476	FS1476	FS1476
Cooling lubricant nozzle C6			FS1476	FS1476	FS1476	FS1476



Walter Capto™

C ... – PRSC

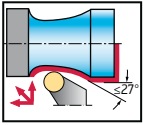

- positive toolholder range
- external machining
- lever type clamping

Tool	Designation		d ₁ mm	f mm	l ₄ mm	D _{min} mm	D _{min2} mm	γ	λ _s	Type
Walter Capto™ ISO 26623 	C5-PRSCR/L-35060-16	16	C5	35	60	-	-	0°	0°	RC ... 1605 ..
	C6-PRSCR/L-45065-16	16	C6	45	65	-	-	0°	0°	
	C5-PRSCR/L-35060-20	20	C5	35	60	-	-	0°	0°	RC ... 2006 ..
	C6-PRSCR/L-45065-20	20	C6	45	65	-	-	0°	0°	
	C8-PRSCR/L-55080-20	20	C8	55	80	150	250	0°	0°	RC ... 2507 ..
	C6-PRSCR/L-45065-25	25	C6	45	65	200	190	0°	0°	
	C8-PRSCR/L-55080-25	25	C8	55	80	200	250	0°	0°	

Measured with master insert RC ... 0602M0 ... / RC ... 0803M0 ... / RC ... 10T3M0 ... / RC ... 1204M0 ... / RC ... 1605M0 ... / RC ... 2006M0 ... / RC ... 2507M0 ...

Bodies and assembly parts are included in the scope of delivery.

For information on the rake angle γ (for indexable inserts without geometry) and on the inclination angle λ_s, see page A 301.

For information on D_{min} and D_{min2}, see page A 301.

Assembly parts		RC ... 1605 ..	RC ... 2006 ..	RC ... 2507 ..
	Shim	AP157	AP158	AP405-RC2507
	Shim for C8		AP404-RC2006	
	Pipe pin	RS108	RS103	RS104
	Lever	KN111	KN112	KN113
	Clamping screw	FS344 (SW 2,5)	FS2156 (SW 3)	FS2145 (SW 4)
	Tightening torque	2,5 Nm	5 Nm	10 Nm
	Assembly plug	MD102	MD102	MD102
	Allen key	ISO2936-2,5 (SW 2,5)	ISO2936-3 (SW 3)	ISO2936-4 (SW 4)
	Cooling lubricant nozzle C5	FS1019	FS1019	
	Cooling lubricant nozzle C6	FS1019	FS1019	FS1476
	Cooling lubricant nozzle C8		FS1479	FS1479

Accessories		RC ... 1605 ..		
	Shim	AP188 RC ... 1606		



Walter Capto™

C ... – SSRC

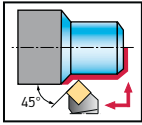

- positive toolholder range
- external machining
- screw clamping

Tool

Walter Capto™ ISO 26623
 $\kappa = 75^\circ$

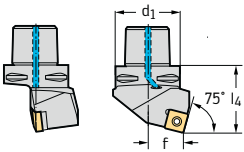

Designation

			d_1 mm	f mm	l_4 mm	D_{min2} mm	γ	λ_s	Type
C3-SSRCR/L-17040-09		9	C3	17	40	116	0°	0°	SC...09T3...
C4-SSRCR/L-22050-12		12	C4	22	50	140	0°	0°	SC...1204...
C5-SSRCR/L-27060-12		12	C5	27	60	165	0°	0°	

Measured with master insert SC...09T308 / SC...120408.

Bodies and assembly parts are included in the scope of delivery.

For information on the rake angle γ (for indexable inserts without geometry) and on the inclination angle λ_s , see page A 301.

For information on D_{min} and D_{min2} , see page A 301.

Assembly parts

	Type	SC...09T3...	SC...1204...
	Clamping screw for insert	FS2060 (Torx 15 IP)	FS2065 (Torx 15IP)
	Tightening torque	3,0 Nm	3,0 Nm
	Shim	AP328-SC0908	AP319-SC1212
	Screw for shim	FS2068 (SW 3,5)	FS2069 (SW 4)
	Torx key	FS1465 (Torx 15IP/SW 3,5)	FS1496 (Torx 15IP/SW 4)
	Cooling lubricant nozzle C3	FS1477	
	Cooling lubricant nozzle C4		FS1477
	Cooling lubricant nozzle C5		FS1476



Walter Capto™ C ... – STGC

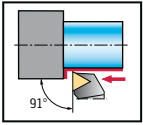

- positive toolholder range
- external machining
- screw clamping

Tool	Designation		d ₁ mm	f mm	l ₄ mm	D _{min} mm	D _{min2} mm	γ	λ _s	Type
Walter Capto™ ISO 26623 κ = 91° 	C3-STGCR/L-22040-11		11	22	40	90	116	0°	0°	TC... 1102...
	C4-STGCR/L-27050-11		11	27	50	90	140	0°	0°	
	C3-STGCR/L-22040-16		16	22	40	140	116	0°	0°	TC... 16T3...
	C4-STGCR/L-27050-16		16	27	50	140	140	0°	0°	
	C5-STGCR/L-35060-16		16	35	60	140	165	0°	0°	
	C6-STGCR/L-45065-16		16	45	65	140	190	0°	0°	

Measured with master insert TC... 110204. / TC... 16T308.

Bodies and assembly parts are included in the scope of delivery.

For information on the rake angle γ (for indexable inserts without geometry) and on the inclination angle λ_s, see page A 301.

For information on D_{min} and D_{min2}, see page A 301.

Assembly parts		TC... 1102...	TC... 16T3...
	Clamping screw for insert Tightening torque	FS2061 (Torx 7IP) 0,9 Nm	FS2060 (Torx 15 IP) 3,0 Nm
	Shim		AP317-TC1612
	Screw for shim		FS2068 (SW 3,5)
	Torx key	FS1490 (Torx 7IP)	FS1465 (Torx 15IP/SW 3,5)
	Cooling lubricant nozzle C3	FS1477	FS1477
	Cooling lubricant nozzle C4	FS1477	FS1477
	Cooling lubricant nozzle C5		FS1476
	Cooling lubricant nozzle C6		FS1476

Walter Capto™

C ... – SVJB / C ... – SVHB

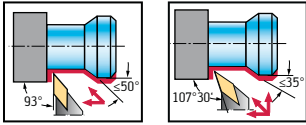

- positive toolholder range
- external machining
- screw clamping

Tool	Designation		d ₁ mm	f mm	l ₄ mm	D _{min} mm	D _{min2} mm	γ	λ _s	Type
Walter Capto™ ISO 26623κ = 93° 	C3-SVJBR/L-22040-11	11	C3	22	40	55	116	0°	0°	VB/C . . 1103 . .
	C4-SVJBR/L-27050-11	11	C4	27	50	55	150	0°	0°	
	C4-SVJBR/L-27050-16	16	C4	27	50	155	140	0°	0°	VB/C . . 1604 . .
	C5-SVJBR/L-35060-16	16	C5	35	60	155	165	0°	0°	
	C6-SVJBR/L-45065-16	16	C6	45	65	155	190	0°	0°	
Walter Capto™ ISO κ = 107° 30' 	C3-SVHBR/L-22040-11	11	C3	22	40	55	114	0°	0°	VB/C . . 1103 . .
	C4-SVHBR/L-27050-11	11	C4	27	50	55	140	0°	0°	
	C4-SVHBR/L-27050-16	16	C4	27	50	95	140	0°	0°	VB/C . . 1604 . .
	C5-SVHBR/L-35060-16	16	C5	35	60	95	165	0°	0°	
	C6-SVHBR/L-45065-16	16	C6	45	65	95	190	0°	0°	

Measured with master insert VB . . 110304 / VB . . 160408.

Bodies and assembly parts are included in the scope of delivery.

For information on the rake angle γ (for indexable inserts without geometry) and on the inclination angle λ_s, see page A 301.

For information on D_{min} and D_{min2}, see page A 301.

Assembly parts	Type	VB/C . . 1103 . .	VB/C . . 1604 . .
	Clamping screw for insert Tightening torque	FS2061 (Torx 7IP) 0,9 Nm	FS2060 (Torx 15 IP) 3,0 Nm
	Shim		AP316-VB1608 r ≤ 0,8
	Screw for shim		FS2068 (SW 3,5)
	Torx key	FS1490 (Torx 7IP)	FS1465 (Torx 15IP/SW 3,5)
	Cooling lubricant nozzle C3	FS1477	
	Cooling lubricant nozzle C4	FS1477	FS1477
	Cooling lubricant nozzle C5		FS1476
	Cooling lubricant nozzle C6		FS1476

Accessories	Type	VB/C . . 1604 . .
	Shim	AP330-VB1612 r ≤ 1,2



Walter Capto™

C ... – PVJB / C ... – PVHB

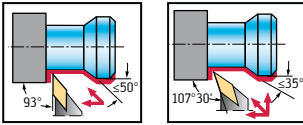

- positive toolholder range
- external machining
- lever type clamping

Tool	Designation		d ₁ mm	f mm	l ₄ mm	γ	λ _s	Type
Walter Capto™ ISO 26623 κ = 93° 	C3-PVJBR/L-22040-11	11	C3	22	40	0°	0°	VB/C...1103...
	C4-PVJBR/L-27050-11	11	C4	27	50	0°	0°	
	C4-PVJBR/L-27050-16	16	C4	27	50	0°	0°	VB/C...1604...
	C5-PVJBR/L-35060-16	16	C5	35	60	0°	0°	
	C6-PVJBR/L-45065-16	16	C6	45	65	0°	0°	
Walter Capto™ ISO κ = 107°30' 	C3-PVHBR/L-22040-11	11	C3	22	40	0°	0°	VB/C...1103...
	C4-PVHBR/L-27050-11	11	C4	27	50	0°	0°	
	C4-PVHBR/L-27050-16	16	C4	27	50	0°	0°	VB/C...1604...
	C5-PVHBR/L-35060-16	16	C5	35	60	0°	0°	
	C6-PVHBR/L-45065-16	16	C6	45	65	0°	0°	

Measured with master insert VB . . 110304 / VB . . 160408.

Bodies and assembly parts are included in the scope of delivery.

For information on the rake angle γ (for indexable inserts without geometry) and on the inclination angle λ_s, see page A 301.

Assembly parts	Type	VB/C . . 1103 . .	VB/C . . 1604 . .
	Shim		AP153 r ≤ 0,8
	Pipe pin		RS101
	Lever	KN118	KN110
	Clamping screw	FS347 (SW 2)	FS351 (SW 2,5)
	Tightening torque	0,6 Nm	2,0 Nm
	Assembly plug		MD101
	Allen key	ISO2936-2 (SW 2)	ISO2936-2,5 (SW 2,5)
	Cooling lubricant nozzle C3	FS1230	
	Cooling lubricant nozzle C4	FS1018	FS1018
	Cooling lubricant nozzle C5		FS1019
	Cooling lubricant nozzle C6		FS1019

Accessories	Type	VB/C . . 1604 . .
	Shim	AP154 r ≤ 1,2



Walter Capto™

C ... – SVVB

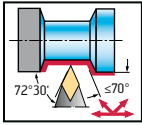

- positive toolholder range
- external machining
- screw clamping

Tool

Walter Capto™ ISO 26623
 $\kappa = 72^\circ 30'$

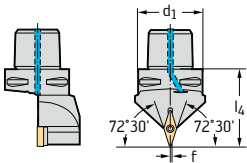

Designation

Designation		d_1 mm	f mm	l_4 mm	D_{min2} mm	γ	λ_s	Type
C3-SVVBN-00040-11	11	C3	0,3	40	116	0°	0°	VB/C .. 1103 ..
C4-SVVBN-00050-11	11	C4	0,3	50	140	0°	0°	
C4-SVVBN-00050-16	16	C4	0,6	50	140	0°	0°	VB/C .. 1604 ..
C5-SVVBN-00060-16	16	C5	0,6	60	165	0°	0°	
C6-SVVBN-00065-16	16	C6	0,6	65	190	0°	0°	

Measured with master insert VB .. 110304 / VB .. 160408.

Bodies and assembly parts are included in the scope of delivery.

For information on the rake angle γ (for indexable inserts without geometry) and on the inclination angle λ_s , see page A 301.

For information on D_{min} and D_{min2} , see page A 301.

Assembly parts

	Type	VB/C .. 1103 ..	VB/C .. 1604 ..
	Clamping screw for insert Tightening torque	FS2061 (Torx 7IP) 0,9 Nm	FS2060 (Torx 15 IP) 3,0 Nm
	Shim		AP316-VB1608 $r \leq 0,8$
	Screw for shim		FS2068 (SW 3,5)
	Torx key	FS1490 (Torx 7IP)	FS1465 (Torx 15IP/SW 3,5)
	Cooling lubricant nozzle C3	FS1477	
	Cooling lubricant nozzle C4	FS1477	FS1477
	Cooling lubricant nozzle C5		FS1476
	Cooling lubricant nozzle C6		FS1476

Accessories

	Type	VB/C .. 1604 ..
	Shim	AP330-VB1612 $r \leq 1,2$



A 48



G 2



A 288

Walter Capto™

C ... – PVVB

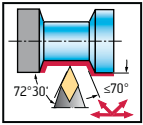

- positive toolholder range
- external machining
- lever type clamping



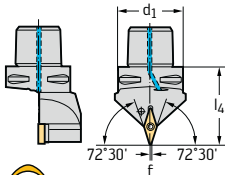



Tool	Designation		d ₁ mm	f mm	l ₄ mm	γ	λ _s	Type
Walter Capto™ ISO 26623 κ = 72°30'	C3-PVVBN-00040-11	11	C3	0,3	40	0°	0°	VB/C...1103..
	C4-PVVBN-00050-11	11	C4	0,3	50	0°	0°	
	C4-PVVBN-00050-16	16	C4	0,6	50	0°	0°	VB/C...1604..
	C5-PVVBN-00060-16	16	C5	0,6	60	0°	0°	
	C6-PVVBN-00065-16	16	C6	0,6	65	0°	0°	



Measured with master insert VB...110304 / VB...160408.

Bodies and assembly parts are included in the scope of delivery.

For information on the rake angle γ (for indexable inserts without geometry) and on the inclination angle λ_s, see page A 301.

Assembly parts		VB/C...1103..	VB/C...1604..
	Shim		AP153 r ≤ 0,8
	Pipe pin		RS101
	Lever	KN118	KN110
	Clamping screw	FS347 (SW 2)	FS351 (SW 2,5)
	Tightening torque	0,6 Nm	2,0 Nm
	Assembly plug		MD101
	Allen key	ISO2936-2 (SW 2)	ISO2936-2,5 (SW 2,5)
	Cooling lubricant nozzle C3	FS1230	
	Cooling lubricant nozzle C4	FS1018	FS1018
	Cooling lubricant nozzle C5		FS1019
	Cooling lubricant nozzle C6		FS1019

Accessories		VB/C...1604..
	Shim	AP154 r ≤ 1,2

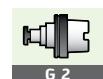

Walter Capto™ C ... – SWLC

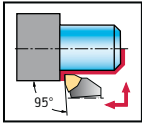

- positive toolholder range
- external machining
- screw clamping

Tool

Walter Capto™ ISO 26623
 $\kappa = 95^\circ$

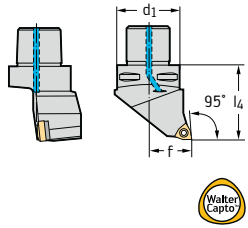

Designation

			d_1 mm	f mm	l_4 mm	D_{min} mm	D_{min2} mm	γ	λ_s	Type
C3-SWLCR/L-22040-06	6	C3	22	40	150	116	0°	0°	WC...06T3...	
C4-SWLCR/L-27050-06	6	C4	27	50	150	140	0°	0°		
C5-SWLCR/L-35060-06	6	C5	35	60	150	165	0°	0°	WC...0804...	
C5-SWLCR/L-35060-08	8	C5	35	60	150	165	0°	0°		
C6-SWLCR/L-45065-08	8	C6	45	65	150	190	0°	0°		

Measured with master insert WC...06T308 / WC...080408.

Bodies and assembly parts are included in the scope of delivery.

For information on the rake angle γ (for indexable inserts without geometry) and on the inclination angle λ_s , see page A 301.

For information on D_{min} and D_{min2} , see page A 301.

Assembly parts

	Type	WC...06T3...	WC...0804...
	Clamping screw for insert Tightening torque	FS2063 (Torx 15IP) 3,0 Nm	FS2065 (Torx 15IP) 3,0 Nm
	Shim	AP318-WC0608	AP320-WC0812
	Screw for shim	FS2068 (SW 3,5)	FS2069 (SW 4)
	Torx key	FS1465 (Torx 15IP/SW 3,5)	FS1496 (Torx 15IP/SW 4)
	Cooling lubricant nozzle C3	FS1477	
	Cooling lubricant nozzle C4	FS1477	
	Cooling lubricant nozzle C5	FS1476	FS1476
	Cooling lubricant nozzle C6		FS1476



Walter Capto™

C ... – DCMN

Walter Turn 45°

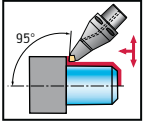

- toolholders for turning / milling centres
- negative toolholder range
- external machining
- rigid clamping system

Tool	Designation		d ₁ mm	f mm	l ₄ mm	D _{min2} mm	γ	λ _s	Type
Walter Capto™ ISO 26623 κ = 95°	C5-DCMNN-00105-12	12	C5	0	105	110	-6°	-6°	CN..1204..
	C6-DCMNN-00090-12	12	C6	0	90	110	-6°	-6°	
	C6-DCMNN-00115-12	12	C6	0	115	110	-6°	-6°	CN..1606..
	C6-DCMNN-00090-16	16	C6	0	90	110	-6°	-6°	
	C8-DCMNN-00150-16	16	C8	0	150	115	-6°	-6°	

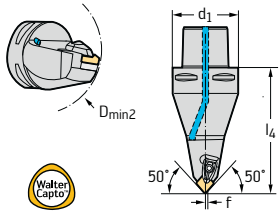

Measured with master insert CN .. 120408 / CN .. 160612.

Bodies and assembly parts are included in the scope of delivery.

For information on the rake angle γ (for indexable inserts without geometry) and on the inclination angle λ_s, see page A 301.

For information on D_{min2}, see page A 301.

Assembly parts	Type	CN..1204..	CN..1606..
	Shim	AP301-CN12	AP302-CN16
	Screw for shim	FS1461 (Torx 15IP)	FS1463 (Torx 20IP)
	Clamp	PK241	PK242
	Screw for clamp	FS1473 (Torx 15IP)	FS1474 (Torx 20IP)
	Tightening torque	3,9 Nm	6,4 Nm
	Pressure spring	FS1470	FS1471
	Pin	RS117	RS117
	Torx key	FS1465 (Torx 15IP/SW 3,5)	FS1464 (Torx 20IP)
	Cooling lubricant nozzle C5	FS1476	
	Cooling lubricant nozzle C6	FS1479	FS1479
	Cooling lubricant nozzle C8		FS1479

Accessories	Type	CN..1204..	CN..1606..
	Clamp set (standard mounting parts)	PK241-SET	PK242-SET
	Clamp set with carbide clamping plate	PK245-SET	PK246-SET

Walter Capto™ C ... – DDMN

Walter Turn 45°

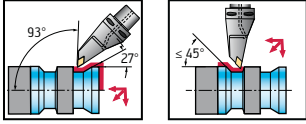

- toolholders for turning / milling centres
- negative toolholder range
- external machining
- rigid clamping system

Tool	Designation		d ₁ mm	f mm	l ₄ mm	D _{min2} mm	γ	λ _s	Type
Walter Capto™ ISO 26623 κ = 93°	C5-DDMNL-00115-15	15	C5	0	115	110	-5°	-6°	DN..1506..
	C6-DDMNL-00130-15	15	C6	0	130	110	-5°	-6°	
	C6-DDMNL-33120-15	15	C6	33	120	130	-5°	-6°	
	C8-DDMNL-00160-15	15	C8	0	160	120	-5°	-6°	

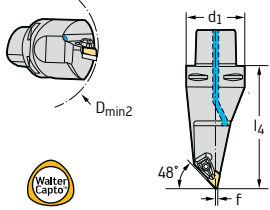

Measured with master insert DN .. 150608.

Bodies and assembly parts are included in the scope of delivery.

For information on the rake angle γ (for indexable inserts without geometry) and on the inclination angle λ_s, see page A 301.

For information on D_{min2}, see page A 301.

Assembly parts	Type	DN..1506..
	Shim	AP304-DN15
	Screw for shim	FS1461 (Torx 15IP)
	Clamp	PK241
	Screw for clamp	FS1473 (Torx 15IP)
	Tightening torque	3,9 Nm
	Pressure spring	FS1470
	Pin	RS117
	Torx key	FS1465 (Torx 15IP/SW 3,5)
	Cooling lubricant nozzle C5	FS1476
	Cooling lubricant nozzle C6	FS1479
	Cooling lubricant nozzle C8	FS1479

Accessories	Type	DN..1506..
	Clamp set (standard mounting parts)	PK241-SET
	Clamp set with carbide clamping plate	PK245-SET
	Shim	AP304-DN1504 DN .. 1504 ..

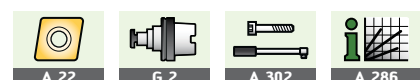

Walter Capto™

C ... – DVMN

Walter Turn 45°

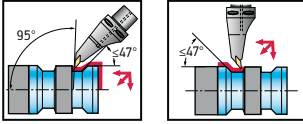

- toolholders for turning / milling centres
- negative toolholder range
- external machining
- rigid clamping system

Tool	Designation		d ₁ mm	f mm	l ₄ mm	D _{min2} mm	γ	λ _s	Type
Walter Capto™ ISO 26623 κ = 95°	C8-DVMNL-00160-16	16	C8	0	160	110	-4°	-14°	VN..1604..

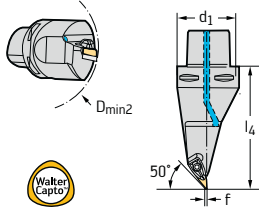

Measured with master insert VN .. 160408.

Bodies and assembly parts are included in the scope of delivery.

For information on the rake angle γ (for indexable inserts without geometry) and on the inclination angle λ_s, see page A 301.

For information on D_{min2}, see page A 301.

Assembly parts	Type	VN..1604..
	Shim	AP312-VN16
	Screw for shim	FS1467 (Torx 15IP)
	Clamp	PK244
	Screw for clamp	FS1473 (Torx 15IP)
	Tightening torque	1,7 Nm
	Pressure spring	FS1470
	Pin	RS117
	Torx key	FS1465 (Torx 15IP/SW 3,5)
	Cooling lubricant nozzle C8	FS1479

Accessories	Type	VN..1604..
	Clamp set (standard mounting parts)	PK244-SET



A 34



G 2



A 302



A 286

Walter Capto™ C ... – SCMC

Walter Turn 45°

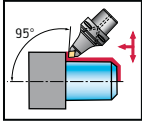

- toolholders for turning / milling centres
- positive toolholder range
- external machining
- screw clamping

Tool	Designation		d ₁ mm	f mm	l ₄ mm	D _{min2} mm	γ	λ _s	Type
Walter Capto™ ISO 26623 κ = 95°	C6-SCMCN-00090-12	12	C6	0	90	100	0°	0°	CC...1204..

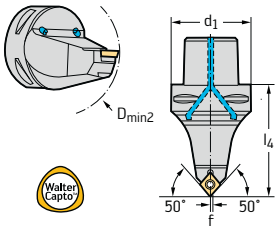

Measured with master insert CC..120408.

Bodies and assembly parts are included in the scope of delivery.

For information on the rake angle γ (for indexable inserts without geometry) and on the inclination angle λ_s, see page A 301.

For information on D_{min2}, see page A 301.

Assembly parts	Type	CC...1204..
	Clamping screw for insert Tightening torque	FS2065 (Torx 15IP) 3,0 Nm
	Shim	AP319-SC1212
	Screw for shim	FS2069 (SW 4)
	Torx key	FS1496 (Torx 15IP/SW 4)

Walter Capto™ C ... – SRDC

Walter Turn 45°

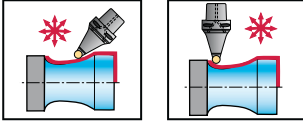

- toolholders for turning / milling centres
- positive toolholder range
- external machining
- screw clamping

Tool	Designation		d ₁ mm	f mm	l ₄ mm	D _{min2} mm	γ	λ _s	Type
Walter Capto™ ISO 26623 κ = 95°	C6-SRDCN-00100-10	10	C6	5	100	110	0°	0°	RC.T10T3 ..
	C6-SRDCN-00100-16	16	C6	8	100	110	0°	0°	RC.T1606 ..

Measured with master insert CC..120408.

Bodies and assembly parts are included in the scope of delivery.

For information on the rake angle γ (for indexable inserts without geometry) and on the inclination angle λ_s, see page A 301.

For information on D_{min2}, see page A 301.

Assembly parts	Type	RC.T10T3 ..	RC.T1606 ..
	Clamping screw for insert Tightening torque	FS2063 (Torx 15IP) 3,0 Nm	FS2090 (Torx 20IP) 6,4 Nm
	Shim	AP324-RC10T3	AP326-RC1606
	Screw for shim	FS2068 (SW 3,5)	FS2091 (SW 5)
	Torx key	FS1465 (Torx 15IP/SW 3,5)	FS1464 (Torx 20IP)

Walter Capto™ C ... – SVMB

Walter Turn 45°

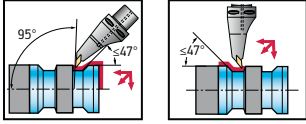

- toolholders for turning / milling centres
- positive toolholder range
- external machining
- screw clamping

Tool	Designation		d ₁ mm	f mm	l ₄ mm	D _{min2} mm	γ	λ _s	Type
Walter Capto™ ISO 26623 κ = 95°	C5-SVMBL-00115-16		16	C5	0	115	110	0°	0°
	C6-SVMBL-00130-16		16	C6	0	130	110	0°	0°
	C6-SVMBL-33120-16		16	C6	33	120	110	0°	0°

Measured with master insert VB . . 160408.

Bodies and assembly parts are included in the scope of delivery.

For information on the rake angle γ (for indexable inserts without geometry) and on the inclination angle λ_s, see page A 301.

For information on D_{min2}, see page A 301.

Assembly parts

	Type	VB..1604..
	Clamping screw for insert Tightening torque	FS2060 (Torx 15 IP) 3,0 Nm
	Shim	AP316-VB1608 r ≤ 0,8
	Screw for shim	FS2068 (SW 3,5)
	Torx key	FS1465 (Torx 15IP/SW 3,5)

Accessories

	Type	VB..1604..
	Shim	AP330-VB1612 r ≤ 1,2





System overview of Walter Turn / Walter Capto™ – internal machining

Boring bars for indexable inserts with a negative basic shape



Walter Turn rigid clamping system (D)

- The number one choice for machining short-chipping material such as cast iron
- Functionality is also maintained in "dirty environments", e.g. chilled cast iron machining
- The number one choice with interrupted cuts thanks to extremely stable insert clamping
- Indexable insert or shim replaced using the same wrench
- Reinforced top clamp with carbide shoe for longer top clamp service life
- Internal coolant supply on all tools



Walter Turn lever-type clamping (P)

- Universal system with easy indexable insert replacement
- Number one choice for single-sided negative inserts, e.g. CNMM
- Number one choice when machining small bore diameters with negative inserts
- Unobstructed chip evacuation from the hole and therefore an alternative to the rigid clamping system



Boring bars for indexable inserts with a positive basic shape

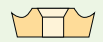

Walter Turn screw clamping (S)

- For indexable inserts with positive basic shape with clearance angle of 5° and 7°
- Machining of small hole diameters
- For use with low cutting pressures / long projection lengths
- Few assembly parts
- Torx Plus screw clamping for transmitting higher tightening torques
- Indexable insert or shim replaced using the same wrench
- Unobstructed chip evacuation from the hole
- Internal coolant supply on all tools
- Versions with steel and solid carbide shank



Walter Turn positive lever type clamping (P)

- For indexable inserts with positive V basic shape with clearance angle of 5° and 7°
- A high degree of shape accuracy is achieved on the component by means of the high degree of clamping via the lever type clamping
- For use with low cutting pressures / long projection lengths
- Unobstructed chip evacuation from the hole



Retaining sleeves for boring bars with cylindrical shank



Walter Turn boring bar holder AK 600

- Easy handling due to automatic tip height adjustment via a spring-loaded ball / flute detent
- Full round shank boring bars are completely enclosed for maximum stability
- Clamping of steel and solid carbide boring bars without flats (-R)



Walter Select – internal machining

<p>Workpiece characteristics</p>	<p>from Ø 25 mm</p> <p>Steel boring bar: L/D_{max} = 3/1</p>		<p>from Ø 8.5 mm*</p> <p>Steel boring bar: L/D_{max} = 5/1</p> <p>Solid carbide boring bar L/D_{max} = 8/1</p>	
<p>Basic shape</p>	<p>Negative basic shape</p>		<p>Positive basic shape</p>	
<p>Holder clamping system Walter Turn / Walter Capto™</p>	<p>Rigid clamping system</p>	<p>Lever-type clamping system</p>	<p>Screw clamping</p>	<p>Lever-type clamping system</p>
<p>Product range overview</p>	<p>Page A 160</p>	<p>Page A 160</p>	<p>Page A 161</p>	<p>Page A 161</p>
<p>Step 1: selection of the contour to be machined</p> <p>Longitudinal turning / facing</p> <p>Profile turning</p> <p>Facing</p> <p>Interrupted cuts</p>				
<p>Step 2: selection of the material to be machined</p>				
<p>P Steel</p>	<p>••</p>	<p>••</p>	<p>••</p>	<p>••</p>
<p>M Stainless steel</p>	<p>•</p>	<p>••</p>	<p>••</p>	<p>••</p>
<p>K Cast iron</p>	<p>••</p>	<p>•</p>	<p>••</p>	<p>•</p>
<p>N NF metals</p>	<p>—</p>	<p>•</p>	<p>—</p>	<p>••</p>
<p>S Difficult-to-machine materials</p>	<p>••</p>	<p>••</p>	<p>••</p>	<p>••</p>
<p>H Hard materials</p>	<p>••</p>	<p>•</p>	<p>•</p>	<p>•</p>
<p>O Other</p>	<p>•</p>	<p>•</p>	<p>•</p>	<p>•</p>



* For other boring bars from Ø 2 mm made from steel or solid carbide, see page C 106 (Walter precision boring product range).

Product range overview of Walter Turn tools Internal machining – negative basic shape



Rigid-clamping system		Lever-type clamping system	
Walter Select See page A 159 		Walter Select See page A 159 	
95° DCLN R/L $d_1 = 25-50 \text{ mm}$ Boring bar: Page A 164 Page A 186	93° DVUN R/L $d_1 = 40 \text{ mm}$ Boring bar: Page A 168	95° PCLN R/L $d_1 = 25-40 \text{ mm}$ Boring bar: Page A 170 Page A 189	95° PWLN R/L $d_1 = 20-40 \text{ mm}$ Boring bar: Page A 174 Page A 193
93° DDUN R/L $d_1 = 25-50 \text{ mm}$ Boring bar: Page A 165 Page A 187	95° DWLN R/L $d_1 = 25-50 \text{ mm}$ Boring bar: Page A 169 Page A 188	93° PDUN R/L $d_1 = 25-40 \text{ mm}$ Boring bar: Page A 171 Page A 190	
75° DSKN R/L $d_1 = 25-40 \text{ mm}$ Boring bar: Page A 166	75° PSKN R/L $d_1 = 25-40 \text{ mm}$ Boring bar: Page A 172 Page A 191		
91° DTFN R/L $d_1 = 25-50 \text{ mm}$ Boring bar: Page A 167	91° PTFN N $d_1 = 25-40 \text{ mm}$ Boring bar: Page A 173 Page A 192		

Product range overview of Walter Turn tools Internal machining – positive basic shape



Screw clamping system / lever-type clamping system











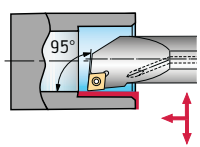

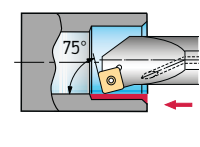

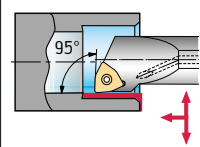

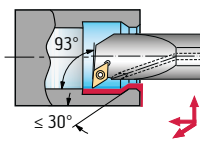

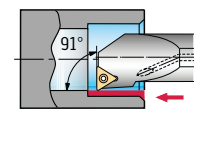
Walter Select
See page A 159

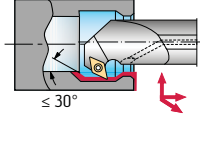

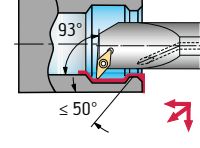
Walter Turn

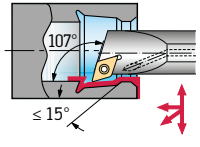

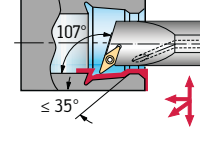
Walter Capto™

95°   Boring bar: Page A 175  Page A 194	SCLC R/L $d_1 = 08-32 \text{ mm}$	75°   Boring bar: Page A 179	SSKC R/L $d_1 = 16-32 \text{ mm}$	95°   Boring bar: Page A 185  Page A 199	SWLC R/L $d_1 = 10-32 \text{ mm}$
93°   Boring bar: Page A 176  Page A 195	SDUC R/L $d_1 = 10-25 \text{ mm}$	91°   Boring bar: Page A 180  Page A 196	STFC R/L $d_1 = 06-32 \text{ mm}$		
93°   Boring bar: Page A 177	SDUC R/L-X $d_1 = 16-32 \text{ mm}$	93°   Boring bar: Page A 181-182	SVUB / PVUB* R/L $d_1 = 16-40 \text{ mm}$		
107°30'   Boring bar: Page A 178	SDQC R/L $d_1 = 12-25 \text{ mm}$	107°30'   Boring bar: Page A 183-184  Page A 197-198	SVQB / PVQB* R/L $d_1 = 16-40 \text{ mm}$		





* Walter Turn positive lever type clamping.

ISO designation key for turning toolholders – internal machining

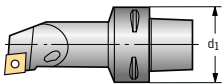
Example of Walter Turn

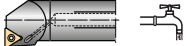

A	20	S	–	S	C	L	C	R	09	–	R
1	2	3		4	5	6	7	8	9		10

0
Coupling size d_1 [mm]
C = Walter Capto™ ISO 26623
C3 $d_1 = 32$ C4 $d_1 = 40$ C5 $d_1 = 50$ C6 $d_1 = 63$ C8 $d_1 = 80$

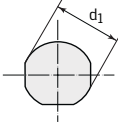
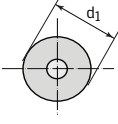
1
Shank design
A Solid steel design with internal coolant supply 
S Solid steel design without internal coolant supply 
E Tungsten carbide shank with steel head and internal coolant supply 
C Tungsten carbide shank with steel head and without internal coolant supply 

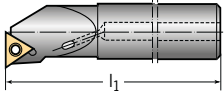
2
Boring bar diameter d_1 [mm]
Shank diameter is shown in mm. Figures after the decimal point are ignored. Integers are preceded by a "0".
 

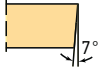
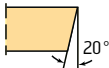
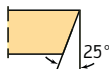
3	
Turning toolholder length l_1 [mm]	
A 32	M 150
B 40	N 160
C 50	P 170
D 60	Q 180
E 70	R 200
F 80	S 250
G 90	T 300
H 100	U 350
J 110	V 400
K 125	W 450
L 140	X Custom
	Y 500
	

7
Indexable insert clearance angle
B 
C 
E 
F 
N 
P 

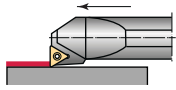
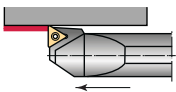
8
Turning toolholder version
R = r. h. cutting 
L = l. h. cutting 

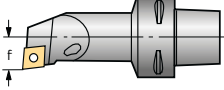
11
f-dimension [mm]

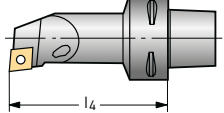
12
Tool length l_4 [mm]



Example of Walter Capto™

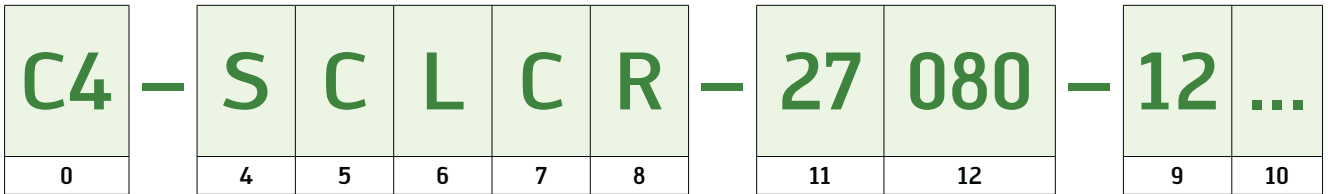

4	
Type of insert mounting	
C	Top clamping
D	Top and hole clamping
M	Top and hole clamping
P	Hole clamping
S	Screw clamping

5	
Basic shape of indexable insert	
C	
D	
R	
S	
T	
V	
W	

6	
Approach angle	
F	S
K	U
L	W
Q	Y

9
Length of cutting edge l [mm]

10
Manufacturer option
<p>If necessary, an additional symbol of max. 3 letters or figures can be added to the standard code.</p> <p>This symbol must be separated from the standard designation with a hyphen.</p> <p>The following versions:</p> <ul style="list-style-type: none"> – R Boring bars with cylindrical shank – X Reverse copy boring bars – W Wedge-type clamping system

Walter Turn A ... – DCLN

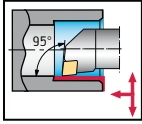

- negative toolholder range
- internal machining
- rigid clamping system

Tool	Designation		D _{min} mm	d ₁ mm	f mm	h mm	l ₁ mm	γ	λ _s	Type
	A25T-DCLNR/L12	12	32	25	17	23	300	-6°	-12°	CN .. 1204 ..
	A32T-DCLNR/L12	12	40	32	22	30	300	-6°	-10°	
	A40T-DCLNR/L12	12	50	40	27	37	300	-6°	-15°	
	A40T-DCLNR/L16	16	50	40	27	37	300	-6°	-16°	CN .. 1606 ..
	A50U-DCLNR/L16	16	63	50	35	47	350	-6°	-13°	

For information on the rake angle γ (for indexable inserts without geometry) and on the inclination angle λ_s, see page A 301.

Measured with master insert CN .. 120408 / CN .. 160612.

Bodies and assembly parts are included in the scope of delivery.

Assembly parts	Type D _{min} mm	CN .. 1204 .. 32-40	CN .. 1204 .. 50	CN .. 1606 .. 50-63
	Shim	AP354-CN12	AP301-CN12	AP302-CN16
	Screw for shim	FS1461 (Torx 15IP)	FS1461 (Torx 15IP)	FS1463 (Torx 20IP)
	Clamp	PK241	PK241	PK242
	Screw for clamp	FS1473 (Torx 15IP)	FS1473 (Torx 15IP)	FS1474 (Torx 20IP)
	Tightening torque	3,9 Nm	3,9 Nm	6,4 Nm
	Pressure spring	FS1470	FS1470	FS1471
	Pin	RS117	RS117	RS117
	Torx key	FS1465 (Torx 15IP/SW 3,5)	FS1465 (Torx 15IP/SW 3,5)	FS1464 (Torx 20IP)

Accessories	Type D _{min} mm	CN .. 1204 .. 32-50	CN .. 1606 .. 50-63
	Clamp set (standard mounting parts)	PK241-SET	PK242-SET
	Clamp set with carbide clamping plate	PK245-SET	PK246-SET

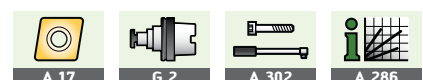

Walter Turn A ... – DDUN

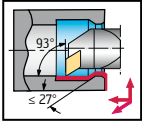

- negative toolholder range
- internal machining
- rigid clamping system

Tool	Designation		D_{min} mm	d_1 mm	f mm	h mm	l_1 mm	γ	λ_s	Type
$\kappa = 93^\circ$	A25T-DDUNR/L11		11	32	25	17	23	-6°	-12°	DN..1104..
	A32T-DDUNR/L11		11	40	32	22	30	-6°	-10°	
	A32T-DDUNR/L15		15	40	32	22	30	-6°	-14°	DN..1506..
	A40T-DDUNR/L15		15	50	40	27	37	-6°	-11°	
	A50U-DDUNR/L15		15	63	50	35	47	-6°	-8°	

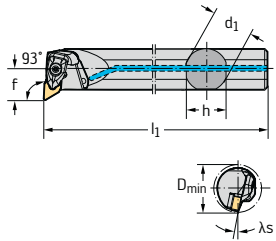

For information on the rake angle γ (for indexable inserts without geometry) and on the inclination angle λ_s , see page A 301.
Measured with master insert DN . . 110408 / DN . . 150608.
Bodies and assembly parts are included in the scope of delivery.

Assembly parts	Type D_{min} mm	DN..1104.. 32-40	DN..1506.. 40-63
	Shim	AP305-DN11	AP304-DN15
	Screw for shim	FS1462 (Torx 9IP)	FS1461 (Torx 15IP)
	Clamp	PK240	PK241
	Screw for clamp Tightening torque	FS1472 (Torx 9IP) 1,7 Nm	FS1473 (Torx 15IP) 3,9 Nm
	Pressure spring	FS1469	FS1470
	Pin	RS116	RS117
	Torx key	FS1466 (Torx 9IP)	FS1465 (Torx 15IP/SW 3,5)

Accessories	Type D_{min} mm	DN..1104.. 32-40	DN..1506.. 40-63
	Clamp set (standard mounting parts)	PK240-SET	PK241-SET
	Clamp set with carbide clamping plate		PK245-SET
	Shim		AP304-DN1504 DN . . 1504 . .

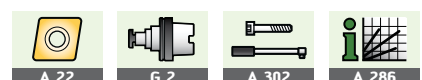

Walter Turn A ... – DSKN

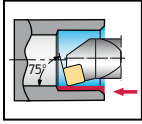

- negative toolholder range
- internal machining
- rigid clamping system

Tool	Designation		D _{min} mm	d ₁ mm	f mm	h mm	l ₁ mm	γ	λ _s	Type
	A25T-DSKNR/L12	12	32	25	17	23	300	-6°	-11°	SN .. 1204 ..
	A32T-DSKNR/L12	12	40	32	22	30	300	-6°	-9°	
	A40T-DSKNR/L12	12	50	40	27	37	300	-6°	-13°	
	A40T-DSKNR/L15	15	50	40	27	37	300	-6°	-14°	SN .. 1506 ..

For information on the rake angle γ (for indexable inserts without geometry) and on the inclination angle λ_s, see page A 301.

Measured with master insert SN .. 120408 / SN .. 150612 / SN .. 190612.

Bodies and assembly parts are included in the scope of delivery.

Assembly parts	Type D _{min} mm	SN .. 1204 .. 32-40	SN .. 1204 .. 50	SN .. 1506 .. 50
	Shim	AP355-SN12	AP308-SN12	AP309-SN15
	Screw for shim	FS1461 (Torx 15IP)	FS1461 (Torx 15IP)	FS1463 (Torx 20IP)
	Clamp	PK241	PK241	PK242
	Screw for clamp Tightening torque	FS1473 (Torx 15IP) 3,9 Nm	FS1473 (Torx 15IP) 3,9 Nm	FS1474 (Torx 20IP) 6,4 Nm
	Pressure spring	FS1470	FS1470	FS1471
	Pin	RS117	RS117	RS117
	Torx key	FS1465 (Torx 15IP/SW 3,5)	FS1465 (Torx 15IP/SW 3,5)	FS1464 (Torx 20IP)

Accessories	Type D _{min} mm	SN .. 1204 .. 32-50	SN .. 1506 .. 50
	Clamp set (standard mounting parts)	PK241-SET	PK242-SET
	Clamp set with carbide clamping plate	PK245-SET	PK246-SET

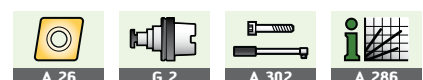

Walter Turn A ... – DTFN

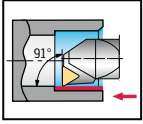

- negative toolholder range
- internal machining
- rigid clamping system

Tool			D_{min} mm	d_1 mm	f mm	h mm	l_1 mm	γ	λ_s	Type
$\kappa = 91^\circ$ 	Designation									
	A25T-DTFNR/L16	16	32	25	17	23	300	-6°	-12°	TN .. 1604 ..
	A32T-DTFNR/L16	16	40	32	22	30	300	-6°	-10°	
	A40T-DTFNR/L16	16	50	40	27	37	300	-6°	-8°	
	A40T-DTFNR/L22	22	50	40	27	37	300	-6°	-13°	TN .. 2204 ..
A50U-DTFNR/L22	22	63	50	35	47	350	-6°	-10°		

For information on the rake angle γ (for indexable inserts without geometry) and on the inclination angle λ_s , see page A 301.
 Measured with master insert TN .. 160408 / TN .. 220408.
 Bodies and assembly parts are included in the scope of delivery.

Assembly parts	Type D_{min} mm	TN .. 1604 .. 32-50	TN .. 2204 .. 50-63
	Shim	AP356-TN16	AP322-TN22
	Screw for shim	FS1462 (Torx 9IP)	FS1461 (Torx 15IP)
	Clamp	PK240	PK241
	Screw for clamp	FS1472 (Torx 9IP)	FS1473 (Torx 15IP)
	Tightening torque	1,7 Nm	3,9 Nm
	Pressure spring	FS1469	FS1470
	Pin	RS116	RS117
	Torx key	FS1466 (Torx 9IP)	FS1465 (Torx 15IP/SW 3,5)

Accessories	Type D_{min} mm	TN .. 1604 .. 32-50	TN .. 2204 .. 50-63
	Clamp set (standard mounting parts)	PK240-SET	PK241-SET
	Clamp set with carbide clamping plate		PK245-SET

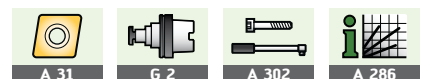

Walter Turn A ... – DVUN

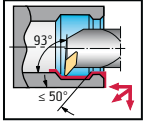

- negative toolholder range
- internal machining
- rigid clamping system

Tool	Designation		D_{min} mm	d_1 mm	f mm	h mm	l_1 mm	γ	λ_s	Type
$\kappa = 93^\circ$	A40T-DVUNR/L16	16	50	40	27	37	300	-6°	-9°	VN .. 1604 ..

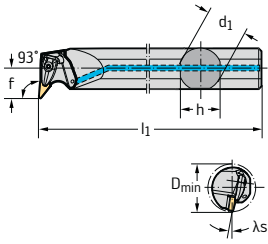

For information on the rake angle γ (for indexable inserts without geometry) and on the inclination angle λ_s , see page A 301.

Measured with master insert VN .. 160408.

Bodies and assembly parts are included in the scope of delivery.

Assembly parts	Type D_{min} mm	VN .. 1604 .. 50
	Shim	AP312-VN16
	Screw for shim	FS1467 (Torx 15IP)
	Clamp	PK244
	Screw for clamp Tightening torque	FS1473 (Torx 15IP) 1,7 Nm
	Pressure spring	FS1470
	Pin	RS117
	Torx key	FS1465 (Torx 15IP/SW 3,5)

Accessories	Type D_{min} mm	VN .. 1604 .. 50
	Clamp set (standard mounting parts)	PK244-SET

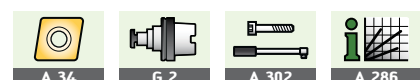

Walter Turn

A ... – DWLN

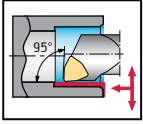

- negative toolholder range
- internal machining
- rigid clamping system

Tool	Designation		D_{min} mm	d_1 mm	f mm	h mm	l_1 mm	γ	λ_s	Type	
$\kappa = 95^\circ$ 	A25T-DWLN/L06	6	32	25	17	23	300	-6°	-14°	WN .. 0604 ..	
	A32T-DWLN/L06	6	40	32	22	30	300	-6°	-11°	WN .. 0804 ..	
	A25T-DWLN/L08	8	32	25	17	23	300	-6°	-12°		
	A32T-DWLN/L08	8	40	32	22	30	300	-6°	-10°		
	A40T-DWLN/L08	8	50	40	27	37	300	-6°	-13°		
	A50U-DWLN/L08	8	63	50	35	47	350	-6°	-11°	WN .. 1006 ..	
	A40T-DWLN/L10	10	50	40	27	37	300	-6°	-16°		

For information on the rake angle γ (for indexable inserts without geometry) and on the inclination angle λ_s , see page A 301.

Measured with master insert WN .. 060408 / WN .. 080408 / WN .. 100612.

Bodies and assembly parts are included in the scope of delivery.

Assembly parts	Type D_{min} mm	WN .. 0604 .. 32-40	WN .. 0804 .. 32-40	WN .. 0804 .. 50-63	WN .. 1006 .. 50
	Shim	AP306-WN06	AP331-WN08	AP307-WN08 $r \leq 1,6$	AP311-WN10
	Screw for shim	FS1462 (Torx 9IP)	FS1461 (Torx 15IP)	FS1461 (Torx 15IP)	FS1463 (Torx 20IP)
	Clamp	PK240	PK241	PK241	PK242
	Screw for clamp	FS1472 (Torx 9IP)	FS1473 (Torx 15IP)	FS1473 (Torx 15IP)	FS1474 (Torx 20IP)
	Tightening torque	1,7 Nm	3,9 Nm	3,9 Nm	6,4 Nm
	Pressure spring	FS1469	FS1470	FS1470	FS1471
	Pin	RS116	RS117	RS117	RS117
	Torx key	FS1466 (Torx 9IP)	FS1465 (Torx 15IP/SW 3,5)	FS1465 (Torx 15IP/SW 3,5)	FS1464 (Torx 20IP)

Accessories	Type D_{min} mm	WN .. 0604 .. 32-40	WN .. 0804 .. 32-63	WN .. 1006 .. 50
	Clamp set (standard mounting parts)	PK240-SET	PK241-SET	PK242-SET
	Clamp set with carbide clamping plate		PK245-SET	PK246-SET



Walter Turn

S ... – PCLN / A ... – PCLN

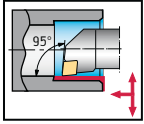

- negative toolholder range
- internal machining
- lever type clamping

Tool	Designation		D_{min} mm	d_1 mm	f mm	h mm	l_1 mm	γ	λ_s	Type
$\kappa = 95^\circ$ 	S25T-PCLNR/L12		12	32	17	23	300	-6°	-13°	CN .. 1204 ..
	S32U-PCLNR/L12		12	40	22	30	350	-6°	-11°	
	S40V-PCLNR/L12		12	50	27	37	400	-6°	-10°	
	S32U-PCLNR/L16		16	55	22	30	350	-6°	-10°	
	S40V-PCLNR/L16		16	58	27	37	400	-6°	-10°	
$\kappa = 95^\circ$ 	A25R-PCLNR/L12		12	32	17		200	-6°	-12°	CN .. 1204 ..
	A32S-PCLNR/L12		12	40	22		250	-6°	-10°	
	A40T-PCLNR/L12		12	50	27		300	-6°	-10°	

For information on the rake angle γ (for indexable inserts without geometry) and on the inclination angle λ_s , see page A 301.

Measured with master insert CN .. 120408 / CN .. 160612.

Bodies and assembly parts are included in the scope of delivery.

Assembly parts	Type D_{min} mm	CN .. 1204 .. 32	CN .. 1204 .. 40-50	CN .. 1606 .. 55-58
	Shim		AP134-CN1216 $r \leq 1,6$	AP135-CN1624 $r \leq 2,4$
	Lever	KN109	KN102	KN104
	Clamping screw Tightening torque	FS332 (SW 2,5) 2,5 Nm	FS352 (SW 3) 5,0 Nm	FS354 (SW 3) 5,0 Nm
	Pipe pin		RS102	RS103
	Assembly plug		MD101	MD102
	Allen key	ISO 2936-2,5 (SW 2,5)	ISO 2936-3 (SW 3)	ISO 2936-3 (SW 3)

Accessories	Type D_{min} mm	CN .. 1204 .. 40-50	CN .. 1606 .. 55-58	
	Shim		AP134-CN1208 $r \leq 0,8$	AP135-CN1616 $r \leq 1,6$



Walter Turn

S ... – PDUN / A ... – PDUN

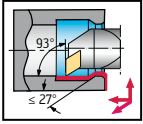

- negative toolholder range
- internal machining
- lever type clamping

Tool	Designation		D_{min} mm	d_1 mm	f mm	h mm	l_1 mm	γ	λ_s	Type
$\kappa = 93^\circ$ 	S40V-PDUNR/L15	15	50	40	27	37	400	-6°	-11°	DN .. 1506 ..
$\kappa = 93^\circ$ 	A25R-PDUNR/L11	11	32	25	17		200	-6°	-10°	DN .. 1104 ..
	A32S-PDUNR/L11	11	40	32	22		250	-6°	-10°	
	A40T-PDUNR/L11	11	50	40	27		300	-6°	-10°	

For information on the rake angle γ (for indexable inserts without geometry) and on the inclination angle λ_s , see page A 301.
 Measured with master insert DN .. 110408 / DN .. 150608.
 Bodies and assembly parts are included in the scope of delivery.

Assembly parts	Type D_{min} mm	DN .. 1104 .. 32	DN .. 1104 .. 40-50	DN .. 1506 .. 50
	Shim		AP171-DN1112 $r \leq 1,2$	AP145-DN1516 $r \leq 1,6$
	Lever	KN120	KN119	KN103
	Pipe pin		RS101	RS102
	Clamping screw Tightening torque	FS905 (SW 2) 2,0 Nm	FS351 (SW 2,5) 2,0 Nm	FS355 (SW 3) 5,0 Nm
	Assembly plug		MD101	MD101
	Allen key	ISO 2936-2 (SW 2)	ISO 2936-2,5 (SW 2,5)	ISO 2936-3 (SW 3)

Accessories	Type D_{min} mm	DN .. 1104 .. 40-50	DN .. 1506 .. 50
	Shim		AP171-DN1108 $r \leq 0,8$
	Shim for DN .. 1504 ..		AP357-DN1508 $r \leq 0,8$
	Shim for DN .. 1504 ..		AP357-DN1516 $r \leq 1,6$

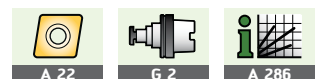

Walter Turn

S ... – PSKN

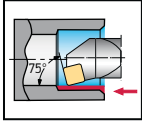

- negative toolholder range
- internal machining
- lever type clamping

Tool	Designation		D _{min} mm	d ₁ mm	f mm	h mm	l ₁ mm	γ	λ _s	Type
	S25T-PSKNR/L12	12	32	25	17	23	300	-6°	-11°	SN .. 1204 ..
	S32U-PSKNR/L12	12	40	32	22	30	350	-6°	-10°	
	S40V-PSKNR/L12	12	50	40	27	37	400	-6°	-10°	

For information on the rake angle γ (for indexable inserts without geometry) and on the inclination angle λ_s, see page A 301.

Measured with master insert SN .. 120408.

Bodies and assembly parts are included in the scope of delivery.

Assembly parts	Type D _{min} mm	SN .. 1204 .. 32	SN .. 1204 .. 40-50
	Shim		AP141-SN1216 r ≤ 1,6
	Lever	KN109	KN102
	Clamping screw Tightening torque	FS332 (SW 2,5) 2,5 Nm	FS352 (SW 3) 5,0 Nm
	Pipe pin		RS102
	Assembly plug		MD101
	Allen key	ISO 2936-2.5 (SW 2,5)	ISO 2936-3 (SW 3)

Accessories	Type D _{min} mm	SN .. 1204 .. 40
	Shim	AP141-SN1208 r ≤ 0,8



Walter Turn S ... – PTFN

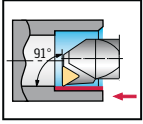

- negative toolholder range
- internal machining
- lever type clamping

Tool			D_{min} mm	d_1 mm	f mm	h mm	l_1 mm	γ	λ_s	Type
$\kappa = 91^\circ$ 	Designation									
	S25T-PTFNR/L16	16	32	25	17	23	300	-6°	-10°	TN .. 1604 ..
	S32U-PTFNR/L16	16	40	32	22	30	350	-6°	-10°	
	S40V-PTFNR/L22	22	50	40	27	37	400	-6°	-10°	TN .. 2204 ..

For information on the rake angle γ (for indexable inserts without geometry) and on the inclination angle λ_s , see page A 301.

Measured with master insert TN .. 160408 / TN .. 220408.

Bodies and assembly parts are included in the scope of delivery.

Assembly parts	Type D_{min} mm	TN .. 1604 .. 32-40	TN .. 2204 .. 50
	Shim	AP137-TN1616 $r \leq 1,6$	AP138-TN2216 $r \leq 1,6$
	Lever	KN101	KN102
	Clamping screw Tightening torque	FS351 (SW 2,5) 2,0 Nm	FS352 (SW 3) 5,0 Nm
	Pipe pin	RS101	RS102
	Assembly plug	MD101	MD101
	Allen key	ISO 2936-2,5 (SW 2,5)	ISO 2936-3 (SW 3)

Accessories	Type D_{min} mm	TN .. 1604 .. 32-40	TN .. 2204 .. 50
	Shim	AP137-TN1608 $r \leq 0,8$	AP138-TN2208 $r \leq 0,8$

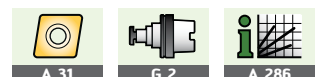

Walter Turn A ... – PWLN

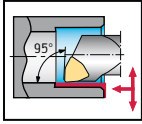

- negative toolholder range
- internal machining
- lever type clamping

Tool	Designation		D_{min} mm	d_1 mm	f mm	l_1 mm	γ	λ_s	Type
$\kappa = 95^\circ$ 	A20Q-PWLN/L06	6	25	20	13	180	-6°	-15°	WN .. 0604 ..
	A25R-PWLN/L06	6	32	25	17	200	-6°	-12°	
	A32S-PWLN/L06	6	40	32	22	250	-6°	-12°	
	A25R-PWLN/L08	8	32	25	17	200	-6°	-12°	WN .. 0804 ..
	A32S-PWLN/L08	8	40	32	22	250	-6°	-10°	
	A40T-PWLN/L08	8	50	40	27	300	-6°	-10°	

For information on the rake angle γ (for indexable inserts without geometry) and on the inclination angle λ_s , see page A 301.

Measured with master insert WN .. 060408 / WN .. 080408 / WN .. 100612.

Bodies and assembly parts are included in the scope of delivery.

Assembly parts	Type D_{min} mm	WN .. 0604 .. 25-32	WN .. 0604 .. 40	WN .. 0804 .. 32	WN .. 0804 .. 40-50
	Shim		AP172-WN0612 $r \leq 1,2$		AP170-WN0816 $r \leq 1,6$
	Lever	KN108	KN101	KN109	KN102
	Pipe pin		RS101		RS102
	Clamping screw Tightening torque	FS331 (SW 2) 2,0 Nm	FS351 (SW 2,5) 2,0 Nm	FS332 (SW 2,5) 2,5 Nm	FS352 (SW 3) 5,0 Nm
	Assembly plug		MD101		MD101
	Allen key	ISO 2936-2 (SW 2)	ISO 2936-2,5 (SW 2,5)	ISO 2936-2,5 (SW 2,5)	ISO 2936-3 (SW 3)

Accessories	Type D_{min} mm	WN .. 0804 .. 40-50			
	Shim				AP170-WN0808 $r \leq 0,8$

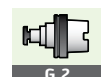

Walter Turn

A ... – SCLC / E ... – SCLC

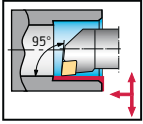

- positive toolholder range
- internal machining
- screw clamping

Tool	Designation		D_{min} mm	d_1 mm	f mm	h mm	l_1 mm	γ	λ_s	Type	
$\kappa = 95^\circ$ 	A08H-SCLCR/L06	6	10	8	5	7	100	0°	-14°	CC..0602..	
	A10K-SCLCR/L06	6	12	10	6	9	125	0°	-11°		
	A12M-SCLCR/L06	6	16	12	9	11	150	0°	-7°		
	$\kappa = 95^\circ$ 	A16R-SCLCR/L09	9	20	16	11	15	200	0°	-8,5°	CC..09T3..
		A20S-SCLCR/L09	9	25	20	13	18	250	0°	-6°	
		A25T-SCLCR/L09	9	32	25	17	23	300	0°	-3,5°	CC..1204..
		A25T-SCLCR/L12	12	32	25	17	23	300	0°	-4,5°	
A32T-SCLCR/L12		12	40	32	22	30	300	0°	-10°		
$\kappa = 95^\circ$ 	A08H-SCLCR/L06-R	6	10	8	5		100	0°	-14°	CC..0602..	
	E08K-SCLCR/L06-R	6	10	8	5		125	0°	-10°		
	A10K-SCLCR/L06-R	6	12	10	6		125	0°	-11°		
	E10M-SCLCR/L06-R	6	12	10	6		150	0°	-7°		
	A12M-SCLCR/L06-R	6	16	12	9		150	0°	-7°		
	$\kappa = 95^\circ$ 	E12Q-SCLCR/L06-R	6	16	12	9		180	0°	-3°	CC..09T3..
		A16R-SCLCR/L09-R	9	20	16	11		200	0°	-8,5°	
		E16R-SCLCR/L09-R	9	20	16	11		200	0°	0°	
		A20S-SCLCR/L09-R	9	25	20	13		250	0°	-6°	

For information on the rake angle γ (for indexable inserts without geometry) and on the inclination angle λ_s , see page A 301.

Measured with master insert CC . . 060204 / CC . . 09T308 / CC . . 120408.

Bodies and assembly parts are included in the scope of delivery.

A = Boring bar in steel version

E = Boring bar made of solid carbide

Assembly parts	Type D_{min} mm	CC..0602.. 10-16	CC..09T3.. 20-25	CC..09T3.. 32	CC..1204.. 32	CC..1204.. 40
	Clamping screw for insert Tightening torque	FS2066 (Torx 7IP) 0,9 Nm	FS2062 (Torx 15IP) 3,0 Nm	FS2063 (Torx 15IP) 3,0 Nm	FS2064 (Torx 15IP) 3,0 Nm	FS2065 (Torx 15IP) 3,0 Nm
	Shim					AP314-CC1212 $r \leq 1,2$
	Screw for shim					FS2069 (SW 4)
	Torx key	FS1490 (Torx 7IP)	FS1465 (Torx 15IP/SW3,5)	FS1465 (Torx 15IP/SW3,5)	FS1496 (Torx 15IP/SW4)	FS1496 (Torx 15IP/SW 4)

Accessories	d_1 mm		
	8	K600.08.28.066	
	10	K600.10.28.086	
	12	K600.12.38.086	
	16	K600.16.40.137	
	20	K600.20.40.137	
	25	K600.25.44.137	
	32	K600.32.44.137	

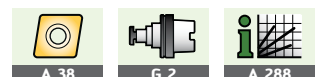

Walter Turn

A ... – SDUC / E ... – SDUC

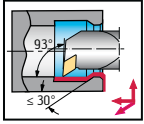

- positive toolholder range
- internal machining
- screw clamping

Tool	Designation		D_{min} mm	d_1 mm	f mm	h mm	l_1 mm	γ	λ_s	Type
$\kappa = 93^\circ$ 	A10K-SDUCR/L07	7	13	10	7	9	125	0°	-9°	DC..0702..
	A12M-SDUCR/L07	7	16	12	9	11	150	0°	-6,5°	
	A16R-SDUCR/L07	7	20	16	11	15	200	0°	-4°	
	A20S-SDUCR/L11	11	25	20	13	18	250	0°	-6°	
	A25T-SDUCR/L11	11	32	25	17	23	300	0°	-3°	
$\kappa = 93^\circ$ 	A10K-SDUCR/L07-R	7	15	10	7		125	0°	-7°	DC..0702..
	E10M-SDUCR/L07-R	7	15	10	9		150	0°	-5°	
	A12M-SDUCR/L07-R	7	18	12	9		150	0°	-5°	
	E12Q-SDUCR/L07-R	7	18	12	11		180	0°	-5°	
	A16R-SDUCR/L07-R	7	20	16	11		200	0°	-4°	
	E16R-SDUCR/L07-R	7	22	16	13		200	0°	-5°	
	A20S-SDUCR/L11-R	11	25	20	13		250	0°	-6°	DC..11T3..

For information on the rake angle γ (for indexable inserts without geometry) and on the inclination angle λ_s , see page A 301.

Measured with master insert DC . . 070204 / DC . . 11T308.

Bodies and assembly parts are included in the scope of delivery.

A = Boring bar in steel version

E = Boring bar made of solid carbide

Assembly parts	Type D_{min} mm	DC..0702.. 13-22	DC..11T3.. 25	DC..11T3.. 32
	Clamping screw for insert Tightening torque	FS2061 (Torx 7IP) 0,9 Nm	FS2062 (Torx 15IP) 3,0 Nm	FS2063 (Torx 15IP) 3,0 Nm
	Torx key	FS1490 (Torx 7IP)	FS1465 (Torx 15IP/SW 3,5)	FS1465 (Torx 15IP/SW 3,5)

Accessories	d_1 mm		
	10	K600.10.28.086	
	12	K600.12.38.086	
	16	K600.16.40.137	
	20	K600.20.40.137	
	25	K600.25.44.137	



Walter Turn

A ... – SDUC ... – X

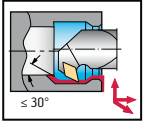

- reverse copy boring bar
- positive toolholder range
- internal machining
- screw clamping

Tool			D_{min} mm	d_1 mm	f mm	h mm	l_1 mm	X_1 mm	l_{20} mm	γ	λ_s	Type	
$\kappa = 93^\circ$	A16R-SDUCR/L07-X		7	22	16	13	15	200	5,0	212,2	0°	-3°	DC..0702..
	A20S-SDUCR/L07-X		7	27	20	15	18	250	5,0	262,2	0°	-2°	
	A25T-SDUCR/L07-X		7	33	25	18	23	300	6,0	312,2	0°	0°	
	A32T-SDUCR/L11-X		11	40	32	22	30	300	7,0	316,7	0°	-7°	

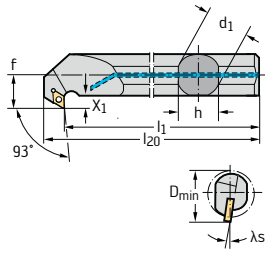

For information on the rake angle γ (for indexable inserts without geometry) and on the inclination angle λ_s , see page A 301.
 Measured with master insert DC . . 070204 / DC . . 11T308.
 Bodies and assembly parts are included in the scope of delivery.

Assembly parts	Type D_{min} mm	DC..0702.. 22-33	DC..11T3.. 40
	Clamping screw for insert Tightening torque	FS2061 (Torx 7IP) 0,9 Nm	FS2062 (Torx 15IP) 3,0 Nm
	Torx key	FS1490 (Torx 7IP)	FS1465 (Torx 15IP/SW 3,5)

Accessories	d_1 mm		
	16	K600.16.40.137	
	20	K600.20.40.137	
	25	K600.25.44.137	
	32	K600.32.44.137	

Walter Turn A ... – SDQC

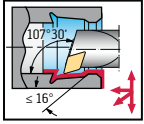

- positive toolholder range
- internal machining
- screw clamping

Tool	Designation		D_{min} mm	d_1 mm	f mm	h mm	l_1 mm	γ	λ_s	Type
$\kappa = 107^\circ 30'$ 	A12M-SDQCR/L07	7	16	12	9	11	150	0°	-7°	DC..0702..
	A16R-SDQCR/L07	7	20	16	11	15	200	0°	-5°	
	A20S-SDQCR/L11	11	25	20	13	18	250	0°	-6°	DC..11T3..
	A25T-SDQCR/L11	11	32	25	17	23	300	0°	-3,5°	
$\kappa = 107^\circ 30'$ 	A12M-SDQCR/L07-R	7	16	12	9		150	0°	-7°	DC..0702..
	A16R-SDQCR/L07-R	7	20	16	11		200	0°	-5°	
	A20S-SDQCR/L11-R	11	25	20	13		250	0°	-6°	DC..11T3..

For information on the rake angle γ (for indexable inserts without geometry) and on the inclination angle λ_s , see page A 301.

Measured with master insert DC . . 070204 / DC . . 11T308.

Bodies and assembly parts are included in the scope of delivery.

Assembly parts	Type D_{min} mm	DC..0702.. 16-20	DC..11T3.. 25	DC..11T3.. 32
	Clamping screw for insert Tightening torque	FS2061 (Torx 7IP) 0,9 Nm	FS2062 (Torx 15IP) 3,0 Nm	FS2063 (Torx 15IP) 3,0 Nm
	Torx key	FS1490 (Torx 7IP)	FS1465 (Torx 15IP/SW 3,5)	FS1465 (Torx 15IP/SW 3,5)

Accessories	d_1 mm		
	12	K600.12.38.086	
	16	K600.16.40.137	
	20	K600.20.40.137	
	25	K600.25.44.137	



Walter Turn A ... – SSKC

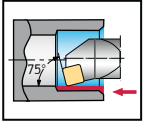

- positive toolholder range
- internal machining
- screw clamping

Tool	Designation		D _{min} mm	d ₁ mm	f mm	h mm	l ₁ mm	γ	λ _s	Type
κ = 75° 	A16R-SSKCR/L09	9	20	16	11	15	200	0°	-9°	SC..09T3..
	A20S-SSKCR/L09	9	25	20	13	18	250	0°	-6°	
	A25T-SSKCR/L12	12	32	25	17	23	300	0°	-4,5°	SC..1204..
	A32T-SSKCR/L12	12	40	32	22	30	300	0°	-9°	
κ = 75° 	A16R-SSKCR/L09-R	9	20	16	11		200	0°	-9°	SC..09T3..

For information on the rake angle γ (for indexable inserts without geometry) and on the inclination angle λ_s, see page A 301.
Measured with master insert SC . . 09T308 / SC . . 120408.
Bodies and assembly parts are included in the scope of delivery.

Assembly parts	Type D _{min} mm	SC..09T3.. 20-25	SC..1204.. 32	SC..1204.. 40
	Clamping screw for insert Tightening torque	FS2062 (Torx 15IP) 3,0 Nm	FS2064 (Torx 15IP) 3,0 Nm	FS2065 (Torx 15IP) 3,0 Nm
	Shim			AP319-SC1212
	Screw for shim			FS2069 (SW 4)
	Torx key	FS1465 (Torx 15IP/SW 3,5)	FS1496 (Torx 15IP/SW 4)	FS1496 (Torx 15IP/SW 4)

Accessories		d ₁ mm		
	Coolant adapter	16	K600.16.40.137	
		20	K600.20.40.137	
		25	K600.25.44.137	
		32	K600.32.44.137	

Walter Turn

A ... – STFC / E ... – STFC

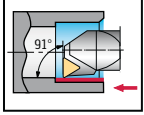

- positive toolholder range
- internal machining
- screw clamping

Tool	Designation		D_{min} mm	d_1 mm	f mm	h mm	l_1 mm	γ	λ_s	Type
$\kappa = 91^\circ$ 	A06F-STFCR/L06	6	8,5	6	4,5	5	80	0°	-12°	TC..06T1..
	A08H-STFCR/L06	6	11	8	5,9	5	100	0°	-10°	
	A10K-STFCR/L09	9	13	10	7	9	125	0°	-9°	TC..0902..
	A12M-STFCR/L11	11	16	12	9	11	150	0°	-6,5°	TC..1102..
	A16R-STFCR/L11	11	20	16	11	15	200	0°	-4,5°	
	A20S-STFCR/L11	11	25	20	13	18	250	0°	-3°	TC..16T3..
	A25T-STFCR/L16	16	32	25	17	23	300	0°	-3°	
	A32T-STFCR/L16	16	40	32	22	30	300	0°	-7°	
$\kappa = 91^\circ$ 	A06F-STFCR/L06-R	6	8,5	6	4,5	5	80	0°	-10°	TC..06T1..
	E06H-STFCR/L06-R	6	8,5	6	4,5	5	100	0°	-10°	
	A08H-STFCR/L06-R	6	11	8	5,9	5	100	0°	-6°	
	E08K-STFCR/L06-R	6	11	8	5,9	5	125	0°	-10°	TC..0902..
	A10K-STFCR/L09-R	9	13	10	7	9	125	0°	-8°	
	E10M-STFCR/L09-R	9	13	10	7	9	150	0°	-8°	TC..1102..
	E12Q-STFCR/L09-R	9	16	12	9	11	180	0°	-6°	
	A12M-STFCR/L11-R	11	16	12	9	11	150	0°	-6,5°	
	A16R-STFCR/L11-R	11	20	16	11	15	200	0°	-4,5°	TC..1102..
	E16R-STFCR/L11-R	11	20	16	11	15	200	0°	-4°	

For information on the rake angle γ (for indexable inserts without geometry) and on the inclination angle λ_s , see page A 301.

Measured with master insert TC..06T102 / TC..090204 / TC..110204 / TC..16T308.

Bodies and assembly parts are included in the price of delivery.

A = boring bar in steel version / E = boring bar made of solid carbide

Assembly parts	Type	TC..06T1.. D_{min} mm	TC..06T1.. 8,5	TC..06T1.. 11	TC..0902.. 13-16	TC..1102.. 16	TC..1102.. 20-25	TC..16T3.. 32	TC..16T3.. 40
	Clamping screw for insert	FS2147 (Torx 6 IP)	FS2148 (Torx 6 IP)	FS2149 (Torx 7 IP)	FS2067 (Torx 7 IP)	FS2061 (Torx 7 IP)	FS2063 (Torx 15IP)	FS2060 (Torx 15 IP)	
	Tightening torque	0,5 Nm	0,5 Nm	0,9 Nm	0,9 Nm	0,9 Nm	3,0 Nm	3,0 Nm	
	Shim							AP317-TC1612 $r \leq 1,2$	
	Screw for shim							FS2068 (SW 3,5)	
	Torx key	FS2146 (Torx 6IP)	FS2146 (Torx 6IP)	FS1490 (Torx 7IP)	FS1490 (Torx 7IP)	FS1490 (Torx 7IP)	FS1465 (Torx 15IP/ SW 3,5)	FS1465 (Torx 15IP/ SW 3,5)	

Accessories	d_1 mm	
	6	K600.06.25.054
	8	K600.08.28.066
	10	K600.10.28.086
	12	K600.12.38.086
	16	K600.16.40.137
	20	K600.20.40.137
	25	K600.25.44.137
	32	K600.32.44.137



Walter Turn A ... – SVUB

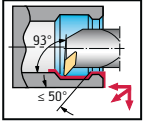

- positive toolholder range
- internal machining
- screw clamping

Tool	Designation		D_{min} mm	d_1 mm	f mm	h mm	l_1 mm	γ	λ_s	Type
$\kappa = 93^\circ$ 	A16R-SVUBR/L11		11	22	16	13	15	0°	-7°	VB/C..1103..
	A20S-SVUBR/L11		11	27	20	15	18	0°	-5°	
	A25T-SVUBR/L11		11	33	25	18	23	0°	-4°	
	A32T-SVUBR/L16		16	40	32	22	30	0°	-6°	VB/C..1604..
	A40T-SVUBR/L16		16	50	40	27	37	0°	-4°	
$\kappa = 93^\circ$ 	A16R-SVUBR/L11-R		11	22	16	13	200	0°	-7°	VB/C..1103..
	A20S-SVUBR/L11-R		11	27	20	15	250	0°	-5°	

For information on the rake angle γ (for indexable inserts without geometry) and on the inclination angle λ_s , see page A 301.
 Measured with master insert VB . . 110304 / VB . . 160408.
 Bodies and assembly parts are included in the scope of delivery.

Assembly parts	Type	VB/C..1103.. 22-33	VB/C..1604.. 40-50
	Clamping screw for insert Tightening torque	FS2172 (Torx 7IP) 0,9 Nm	FS2060 (Torx 15 IP) 3,0 Nm
	Shim		AP316-VB1608 $r \leq 0,8$
	Screw for shim		FS2068 (SW 3,5)
	Torx key	FS1490 (Torx 7IP)	FS1465 (Torx 15IP/SW 3,5)

Accessories	d_1 mm		
	16	K600.16.40.137	
	20	K600.20.40.137	
	25	K600.25.44.137	
	32	K600.32.44.137	
	40	K600.40.46.137	

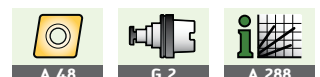

Walter Turn A ... – PVUB

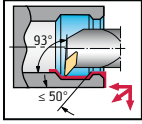

- positive toolholder range
- internal machining
- lever type clamping

Tool	Designation		D_{min} mm	d_1 mm	f mm	l_1 mm	γ	λ_s	Type
$\kappa = 93^\circ$ 	A20Q-PVUBR/L11	11	25	20	13	180	0°	-6°	VB/C..1103..
	A25R-PVUBR/L11	11	32	25	17	200	0°	-6°	
	A32S-PVUBR/L16	16	40	32	22	250	0°	-8°	VB/C..1604..
	A40T-PVUBR/L16	16	50	40	27	300	0°	-8°	

For information on the rake angle γ (for indexable inserts without geometry) and on the inclination angle λ_s , see page A 301.

Measured with master insert VB . . 110304 / VB . . 160408

Bodies and assembly parts are included in the scope of delivery.

Assembly parts	Type D_{min} mm	VB/C..1103.. 25-32	VB/C..1604.. 40	VB/C..1604.. 50
	Shim			AP153 $r \leq 0,8$
	Lever	KN118	KN114	KN110
	Clamping screw Tightening torque	FS347 (SW 2) 0,6 Nm	FS332 (SW 2,5) 2,5 Nm	FS351 (SW 2,5) 2,0 Nm
	Pipe pin			RS101
	Assembly plug			MD101
	Allen key	ISO2936-2 (SW 2)	ISO2936-2.5 (SW 2,5)	ISO2936-2.5 (SW 2,5)



Walter Turn A ... – SVQB

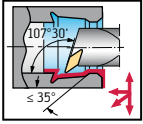

- positive toolholder range
- internal machining
- screw clamping

Tool	Designation		D _{min} mm	d ₁ mm	f mm	h mm	l ₁ mm	γ	λ _s	Type		
κ = 107°30'	A16R-SVQBR/L11		11	22	16	13	15	200	0°	-7°	VB/C..1103..	
	A20S-SVQBR/L11		11	27	20	15	18	250	0°	-5°		
	A25T-SVQBR/L11		11	33	25	17	23	300	0°	-4°		
	A32T-SVQBR/L16		16	40	32	22	30	300	0°	-7°		VB/C..1604..
	A40T-SVQBR/L16		16	50	40	27	37	300	0°	-5°		
κ = 107°30'	A16R-SVQBR/L11-R		11	22	16	13	200	0°	-7°	VB/C..1103..		
	A20S-SVQBR/L11-R		11	27	20	15	250	0°	-5°			

For information on the rake angle γ (for indexable inserts without geometry) and on the inclination angle λ_s, see page A 301.
Measured with master insert VB . . 110304 / VB . . 160408.
Bodies and assembly parts are included in the scope of delivery.

Assembly parts	Type	VB/C..1103.. 22-33	VB/C..1604.. 40-50
	Clamping screw for insert Tightening torque	FS2172 (Torx 7IP) 0,9 Nm	FS2060 (Torx 15 IP) 3,0 Nm
	Shim		AP316-VB1608 r ≤ 0,8
	Screw for shim		FS2068 (SW 3,5)
	Torx key	FS1490 (Torx 7IP)	FS1465 (Torx 15IP/SW 3,5)

Accessories	d ₁ mm		
	16	K600.16.40.137	
	20	K600.20.40.137	
	25	K600.25.44.137	
	32	K600.32.44.137	
	40	K600.40.46.137	



Walter Turn A ... – PVQB

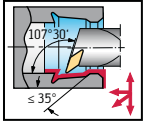

- positive toolholder range
- internal machining
- lever type clamping

Tool	Designation		D_{min} mm	d_1 mm	f mm	l_1 mm	γ	λ_s	Type
$\kappa = 107^\circ 30'$ 	A20Q-PVQBR/L11	11	25	20	13	180	0°	-6°	VB/C..1103..
	A25R-PVQBR/L11	11	32	25	17	200	0°	-6°	
	A32S-PVQBR/L16	16	40	32	22	250	0°	-8°	VB/C..1604..
	A40T-PVQBR/L16	16	50	40	27	300	0°	-8°	

For information on the rake angle γ (for indexable inserts without geometry) and on the inclination angle λ_s , see page A 301.

Measured with master insert VB . . 110304 / VB . . 160408.

Bodies and assembly parts are included in the scope of delivery.

Assembly parts	Type D_{min} mm	VB/C..1103.. 25-32	VB/C..1604.. 40	VB/C..1604.. 50
	Shim			AP153 $r \leq 0,8$
	Lever	KN118	KN114	KN110
	Clamping screw Tightening torque	FS347 (SW 2) 0,6 Nm	FS332 (SW 2,5) 2,5 Nm	FS351 (SW 2,5) 2,0 Nm
	Pipe pin			RS101
	Assembly plug			MD101
	Allen key	ISO2936-2 (SW 2)	ISO2936-2.5 (SW 2,5)	ISO2936-2,5 (SW 2,5)



Walter Turn A ... – SWLC

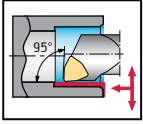

- positive toolholder range
- internal machining
- screw clamping

Tool	Designation		D_{min} mm	d_1 mm	f mm	h mm	l_1 mm	γ	λ_s	Type	
$\kappa = 95^\circ$ 	A10K-SWLCR/L04		4	12	7	9	125	0°	-10°	WC...0402...	
	A12M-SWLCR/L04		4	16	9	11	150	0°	-7°		
	A16R-SWLCR/L04		4	20	11	15	200	0°	-5°		
	$\kappa = 95^\circ$ 	A20S-SWLCR/L06		6	25	13	18	250	0°	-6°	WC...06T3...
		A25T-SWLCR/L06		6	32	17	23	300	0°	-3.5°	
		A32T-SWLCR/L06		6	40	22	30	300	0°	-5.5°	WC...0804...
		A25T-SWLCR/L08		8	32	17	23	300	0°	-4°	
$\kappa = 95^\circ$ 	A32T-SWLCR/L08		8	40	22	30	300	0°	-9°		
	A10K-SWLCR/L04-R		4	13	7		125	0°	-10°	WC...0402...	
	A12M-SWLCR/L04-R		4	16	9		150	0°	-7°		
	A16R-SWLCR/L04-R		4	20	11		200	0°	-5°	WC...06T3...	
	A20S-SWLCR/L06-R		6	25	13		250	0°	-6°		

For information on the rake angle γ (for indexable inserts without geometry) and on the inclination angle λ_s , see page A 301.
 Measured with master insert WC...040204 / WC...06T308 / WC...080408.
 Bodies and assembly parts are included in the scope of delivery.

Assembly parts	Type	WC...0402... 12-20	WC...06T3... 25-32	WC...06T3... 40	WC...0804... 32	WC...0804... 40
	Clamping screw for insert Tightening torque	FS2067 (Torx 7IP) 0,9 Nm	FS2062 (Torx 15IP) 3,0 Nm	FS2063 (Torx 15IP) 3,0 Nm	FS2064 (Torx 15IP) 3,0 Nm	FS2065 (Torx 15IP) 3,0 Nm
	Shim			AP318-WC0608		AP320-WC0812
	Screw for shim			FS2068 (SW 3,5)		FS2069 (SW 4)
	Torx key	FS1490 (Torx 7IP)	FS1465 (Torx 15IP/SW 3,5)	FS1465 (Torx 15IP/SW 3,5)	FS1496 (Torx 15IP/SW 4)	FS1496 (Torx 15IP/SW 4)

Accessories	d_1 mm		
	10	K600.10.28.086	
	12	K600.12.38.086	
	16	K600.16.40.137	
	20	K600.20.40.137	
	25	K600.25.44.137	
	32	K600.32.44.137	



Walter Capto™ C ... – DCLN

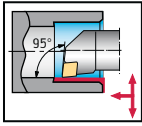

- negative toolholder range
- internal machining
- rigid clamping system

Tool

Walter Capto™ ISO 26623
 $\kappa = 95^\circ$

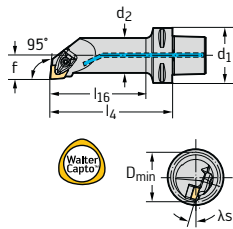

Designation

			D_{min} mm	d_2 mm	d_1 mm	f mm	l_4 mm	l_{16} mm	γ	λ_s	Type
C4-DCLNR/L-17090-12	12		32	25	C4	17	90	68	-6°	-12°	CN..1204..
C5-DCLNR/L-17090-12	12		32	25	C5	17	90	66	-6°	-12°	
C6-DCLNR/L-17100-12	12		32	25	C6	17	100	72	-6°	-12°	
C6-DCLNR/L-27140-16	16		50	40	C6	27	140	114	-6°	-16°	CN..1606..

For information on the rake angle γ (for indexable inserts without geometry) and on the inclination angle λ_s , see page A 301.

Measured with master insert CN . . 120408 / CN . . 160612.

Bodies and assembly parts are included in the scope of delivery.

Assembly parts

	Type D_{min} mm	CN..1204.. 32	CN..1606.. 50
	Shim	AP354-CN12	AP302-CN16
	Screw for shim	FS1461 (Torx 15IP)	FS1463 (Torx 20IP)
	Clamp	PK241	PK242
	Screw for clamp Tightening torque	FS1473 (Torx 15IP) 3,9 Nm	FS1474 (Torx 20IP) 6,4 Nm
	Pressure spring	FS1470	FS1471
	Pin	RS117	RS117
	Torx key	FS1465 (Torx 15IP/SW 3,5)	FS1464 (Torx 20IP)

Accessories

	Type D_{min} mm	CN..1204.. 32	CN..1606.. 50
	Clamp set (standard mounting parts)	PK241-SET	PK242-SET
	Clamp set with carbide clamping plate	PK245-SET	PK246-SET

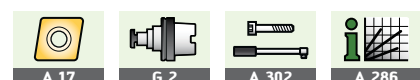

Walter Capto™

C ... – DDUN

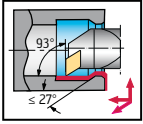

- negative toolholder range
- internal machining
- rigid clamping system

Tool	Designation		D _{min} mm	d ₂ mm	d ₁ mm	f mm	l ₄ mm	l ₁₆ mm	γ	λ _s	Type	
												Walter Capto
Walter Capto™ ISO 26623 κ = 93°	C4-DDUNR/L-17090-11		11	32	25	C4	17	90	68	-6°	-12°	DN..1104..
	C5-DDUNR/L-17090-11		11	32	25	C5	17	90	66	-6°	-12°	
	C4-DDUNR/L-27080-15		15	50	40	C4	27	80	59	-6°	-11°	DN..1506..
	C5-DDUNR/L-27140-15		15	50	40	C5	27	140	118	-6°	-11°	
	C6-DDUNR/L-27140-15		15	50	40	C6	27	140	114	-6°	-11°	

For information on the rake angle γ (for indexable inserts without geometry) and on the inclination angle λ_s, see page A 301.

Measured with master insert DN . . 110408 / DN . . 150608.

Bodies and assembly parts are included in the scope of delivery.

Assembly parts	Type D _{min} mm	DN..1104..	DN..1506..
		32	50
	Shim	AP305-DN11	AP304-DN15
	Screw for shim	FS1462 (Torx 9IP)	FS1461 (Torx 15IP)
	Clamp	PK240	PK241
	Screw for clamp	FS1472 (Torx 9IP)	FS1473 (Torx 15IP)
	Tightening torque	1,7 Nm	3,9 Nm
	Pressure spring	FS1469	FS1470
	Pin	RS116	RS117
	Torx key	FS1466 (Torx 9IP)	FS1465 (Torx 15IP/SW 3,5)

Accessories	Type D _{min} mm	DN..1104..	DN..1506..
		32	50
	Clamp set (standard mounting parts)	PK240-SET	PK241-SET
	Clamp set with carbide clamping plate		PK245-SET
	Shim		AP304-DN1504 DN . . 1504 . .



Walter Capto™ C ... – DWLN

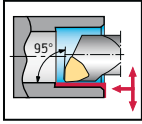

- negative toolholder range
- internal machining
- rigid clamping system

Tool

Walter Capto™ ISO 26623
 $\kappa = 95^\circ$

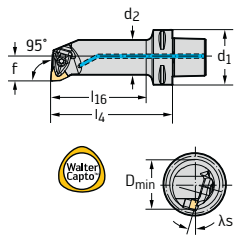

Designation		D_{min} mm	d_2 mm	d_1 mm	f mm	l_4 mm	l_{16} mm	γ	λ_s	Type	
C4-DWLN/L-13075-06		6	27	20	C4	13	75	52	-6°	-17°	WN..0604..
C4-DWLN/L-17090-08		8	33	25	C4	17	90	68	-6°	-12°	WN..0804..
C5-DWLN/L-17090-08		8	33	25	C5	17	90	66	-6°	-12°	WN..0804..
C6-DWLN/L-27140-10		10	50	40	C6	27	140	114	-6°	-16°	WN..1006..

For information on the rake angle γ (for indexable inserts without geometry) and on the inclination angle λ_s , see page A 301.

Measured with master insert WN . . 060408 / WN . . 080408 / WN . . 100612.

Bodies and assembly parts are included in the scope of delivery.

Assembly parts

Type D_{min} mm	WN..0604.. 27	WN..0804.. 33	WN..1006.. 50
Shim	AP306-WN06	AP331-WN08	AP311-WN10
Screw for shim	FS1462 (Torx 9IP)	FS1461 (Torx 15IP)	FS1463 (Torx 20IP)
Clamp	PK240	PK241	PK242
Screw for clamp Tightening torque	FS1472 (Torx 9IP) 1,7 Nm	FS1473 (Torx 15IP) 3,9 Nm	FS1474 (Torx 20IP) 6,4 Nm
Pressure spring	FS1469	FS1470	FS1471
Pin	RS116	RS117	RS117
Torx key	FS1466 (Torx 9IP)	FS1465 (Torx 15IP/SW 3,5)	FS1464 (Torx 20IP)

Accessories

Type D_{min} mm	WN..0604.. 27	WN..0804.. 33	WN..1006.. 50
Clamp set (standard mounting parts)	PK240-SET	PK241-SET	PK242-SET
Clamp set with carbide clamping plate		PK245-SET	PK246-SET

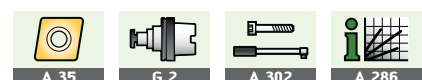

Walter Capto™

C ... – PCLN

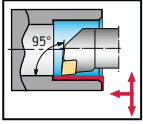

- negative toolholder range
- internal machining
- lever type clamping

Tool	Designation		D_{min} mm	d_2 mm	d_1 mm	f mm	l_4 mm	l_{16} mm	γ	λ_s	Type	
Walter Capto™ ISO 26623 $\kappa = 95^\circ$	C3-PCLNR/L-17090-12		12	32	25	C3	17	90	75	-6°	-11°	CN .. 1204 ..
	C3-PCLNR/L-22064-12		12	40	32	C3	22	64	50	-6°	-11°	
	C3-PCLNR/L-22096-12		12	40	32	C3	22	96	82	-6°	-11°	
	C4-PCLNR/L-17090-12		12	32	25	C4	17	90	69	-6°	-11°	
	C4-PCLNR/L-22110-12		12	40	32	C4	22	110	89	-6°	-11°	
	C4-PCLNR/L-27120-12		12	50	40	C4	27	120	100	-6°	-11°	
	C4-PCLNR/L-27080-12		12	50	40	C4	27	80	60	-6°	-10°	
	C5-PCLNR/L-17090-12		12	32	25	C5	17	90	67	-6°	-11°	
	C5-PCLNR/L-22110-12		12	40	32	C5	22	110	88	-6°	-11°	
	C5-PCLNR/L-27140-12		12	50	40	C5	27	140	119	-6°	-10°	
	C5-PCLNR/L-35100-12		12	63	50	C5	35	100	81	-6°	-7°	
	C6-PCLNR/L-17100-12		12	32	25	C6	17	100	74	-6°	-11°	
	C6-PCLNR/L-22110-12		12	40	32	C6	22	110	84	-6°	-11°	
	C5-PCLNR/L-35150-16		16	63	50	C5	35	150	131	-6°	-11°	CN .. 1606 ..
	C6-PCLNR/L-27140-16		16	50	40	C6	27	140	115	-6°	-11°	
	C6-PCLNR/L-35175-16		16	63	50	C6	35	175	152	-6°	-11°	

For information on the rake angle γ (for indexable inserts without geometry) and on the inclination angle λ_s , see page A 301.

Measured with master insert CN .. 120408 / CN .. 160612.

Bodies and assembly parts are included in the scope of delivery.

Assembly parts	Type D_{min} mm	CN .. 1204 .. 32	CN .. 1204 .. 40	CN .. 1204 .. 50-63	CN .. 1606 .. 50-63
	Shim		AP134-CN1216 $r \leq 1,6$	AP134-CN1216 $r \leq 1,6$	AP135-CN1624 $r \leq 2,4$
	Lever	KN109	KN102	KN102	KN104
	Pipe pin		RS102	RS102	RS103
	Clamping screw Tightening torque	FS332 (SW 2,5) 2,5 Nm	FS352 (SW 3) 5,0 Nm	FS352 (SW 3) 5,0 Nm	FS354 (SW 3) 5,0 Nm
	Assembly plug		MD101	MD101	MD102
	Allen key	ISO 2936-2,5 (SW 2,5)	ISO 2936-3 (SW 3)	ISO 2936-3 (SW 3)	ISO 2936-3 (SW 3)

Accessories	Type D_{min} mm	CN .. 1204 .. 40-63	CN .. 1606 .. 50-63
	Shim	AP134-CN1208 $r \leq 0,8$	AP135-CN1616 $r \leq 1,6$

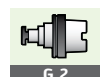

Walter Capto™

C ... – PDUN

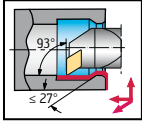

- negative toolholder range
- internal machining
- lever type clamping

Tool

Walter Capto™ ISO 26623
 $\kappa = 93^\circ$

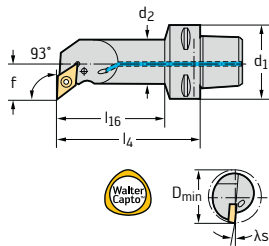

Designation

Designation		D_{min} mm	d_2 mm	d_1 mm	f mm	l_4 mm	l_{16} mm	γ	λ_s	Type
C3-PDUNR/L-17090-11		11	32	25	C3	17	90	74	-6°	-11°
C3-PDUNR/L-22064-11		11	40	32	C3	22	64	49	-6°	-10°
C3-PDUNR/L-22096-11		11	40	32	C3	22	96	81	-6°	-10°
C4-PDUNR/L-17090-11		11	32	25	C4	17	90	69	-6°	-11°
C4-PDUNR/L-22110-11		11	40	32	C4	22	110	89	-6°	-10°
C5-PDUNR/L-17090-11		11	32	25	C5	17	90	67	-6°	-11°
C5-PDUNR/L-22110-11		11	40	32	C5	22	110	88	-6°	-10°
C6-PDUNR/L-17100-11		11	32	25	C6	17	100	74	-6°	-11°
C4-PDUNR/L-27080-15		15	50	40	C4	27	80	60	-6°	-11°
C4-PDUNR/L-27120-15		15	50	40	C4	27	120	100	-6°	-11°
C5-PDUNR/L-27140-15		15	50	40	C5	27	140	119	-6°	-11°
C5-PDUNR/L-35100-15		15	63	50	C5	35	100	81	-6°	-10°
C5-PDUNR/L-35150-15		15	63	50	C5	35	150	131	-6°	-10°
C6-PDUNR/L-27140-15		15	50	40	C6	27	140	115	-6°	-11°
C6-PDUNR/L-35175-15		15	63	50	C6	35	175	152	-6°	-10°

For information on the rake angle γ (for indexable inserts without geometry) and on the inclination angle λ_s , see page A 301.

Measured with master insert DN . . 110408 / DN . . 150608.

Bodies and assembly parts are included in the scope of delivery.

Assembly parts

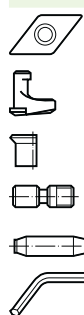

Type D_{min} mm	DN . . 1104 . . 32	DN . . 1104 . . 40	DN . . 1506 . . 50-63
Shim		AP171-DN1112 $r \leq 1,2$	AP145-DN1516 $r \leq 1,6$
Lever	KN120	KN119	KN103
Pipe pin		RS101	RS102
Clamping screw Tightening torque	FS905 (SW 2) 2,0 Nm	FS351 (SW 2,5) 2,0 Nm	FS355 (SW 3) 5,0 Nm
Assembly plug		MD101	MD101
Allen key	ISO 2936-2 (SW 2)	ISO 2936-2,5 (SW 2,5)	ISO 2936-3 (SW 3)

Accessories



Type D_{min} mm	DN . . 1104 . . 40	DN . . 1506 . . 50-63
Shim		AP171-DN1108 $r \leq 0,8$
		AP145-DN1508 $r \leq 0,8$



Walter Capto™ C ... – PSKN

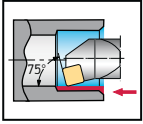

- negative toolholder range
- internal machining
- lever type clamping

Tool	Designation		D _{min} mm	d ₂ mm	d ₁ mm	f mm	l ₄ mm	l ₁₆ mm	γ	λ _s	Type	
Walter Capto™ ISO 26623 κ = 75° 	C4-PSKNR/L-17090-12		12	32	25	C4	17	90	69	-6°	-11°	SN ... 1204 ...
	C4-PSKNR/L-22110-12		12	40	32	C4	22	110	89	-6°	-10°	
	C5-PSKNR/L-17090-12		12	32	25	C5	17	90	67	-6°	-11°	
	C5-PSKNR/L-22110-12		12	40	32	C5	22	110	88	-6°	-10°	
	C5-PSKNR/L-27140-12		12	50	40	C5	27	140	119	-6°	-10°	
	C6-PSKNR/L-22110-12		12	40	32	C6	22	110	84	-6°	-10°	
	C6-PSKNR/L-35175-15		15	63	50	C6	35	175	152	-6°	-9°	SN ... 1506 ...

For information on the rake angle γ (for indexable inserts without geometry) and on the inclination angle λ_s, see page A 301.

Measured with master insert SN ... 120408 / SN ... 150608.

Bodies and assembly parts are included in the scope of delivery.

Assembly parts	Type D _{min} mm	SN ... 1204 ... 32	SN ... 1204 ... 40-50	SN ... 1506 ... 63
	Shim		AP141-SN1216 r ≤ 1,6	AP142-SN1524 r ≤ 2,4
	Lever	KN109	KN102	KN104
	Pipe pin		RS102	RS103
	Clamping screw	FS332 (SW 2,5)	FS352 (SW 3)	FS354 (SW 3)
	Tightening torque	2,5 Nm	5,0 Nm	5,0 Nm
	Assembly plug		MD101	MD102
	Allen key	ISO 2936-2,5 (SW 2,5)	ISO 2936-3 (SW 3)	ISO 2936-3 (SW 3)

Accessories	Type D _{min} mm	SN ... 1204 ... 40-50	SN ... 1506 ... 63	
	Shim		AP141-SN1208 r ≤ 0,8	AP142-SN1516 r ≤ 1,6



Walter Capto™ C ... – PTFN

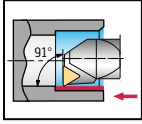

- negative toolholder range
- internal machining
- wedge-type clamping system

Tool	Designation		D_{min} mm	d_2 mm	d_1 mm	f mm	l_4 mm	l_{16} mm	γ	λ_s	Type
Walter Capto™ ISO 26623 $\kappa = 91^\circ$	C4-PTFNR/L-17090-16W	16	32	25	C4	17	90	69	-6°	-13°	TN .. 1604 ..
	C4-PTFNR/L-22110-16W	16	40	32	C4	22	110	89	-6°	-12°	
	C4-PTFNR/L-27120-16W	16	50	40	C4	27	120	100	-6°	-11°	
	C5-PTFNR/L-17090-16W	16	32	25	C5	17	90	67	-6°	-13°	
	C5-PTFNR/L-22110-16W	16	40	32	C5	22	110	88	-6°	-12°	
	C5-PTFNR/L-27140-16W	16	50	40	C5	27	140	119	-6°	-11°	
	C6-PTFNR/L-22110-16W	16	40	32	C6	22	110	84	-6°	-12°	TN .. 2204 ..
	C6-PTFNR/L-27140-16W	16	50	40	C6	27	140	115	-6°	-11°	
	C5-PTFNR/L-27140-22W	22	50	40	C5	27	140	119	-6°	-11°	
	C5-PTFNR/L-35150-22W	22	63	50	C5	35	150	131	-6°	-11°	
	C6-PTFNR/L-27140-22W	22	50	40	C6	27	140	115	-6°	-11°	
	C6-PTFNR/L-35175-22W	22	63	50	C6	35	175	152	-6°	-10°	

For information on the rake angle γ (for indexable inserts without geometry) and on the inclination angle λ_s , see page A 301.

Measured with master insert TN .. 160408 / TN .. 220408.

Bodies and assembly parts are included in the scope of delivery.

Assembly parts	Type D_{min} mm	TN .. 1604 .. 32	TN .. 1604 .. 40-50	TN .. 2204 .. 50-63
	Shim		AP147 $r \leq 1,6$	AP148 $r \leq 1,6$
	Wedge set	FK307 (SW 3)	FK308 (SW 3)	FK309 (SW 4)
	Pin	RS113	RS114	RS115
	Screw	FS1156 (Torx 9IP)	FS1156 (Torx 9IP)	FS1158 (Torx 15IP)
	Allen key	ISO 2936-3 (SW 3)	ISO 2936-3 (SW 3)	ISO 2936-4 (SW 4)



Walter Capto™ C ... – PWLN

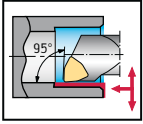

- negative toolholder range
- internal machining
- lever type clamping

Tool	Designation		D_{min} mm	d_2 mm	d_1 mm	f mm	l_4 mm	l_{16} mm	γ	λ_s	Type	
Walter Capto™ ISO 26623 $\kappa = 91^\circ$	C3-PWLN/L-13075-06		6	25	20	C3	13	75	58	-6°	-15°	WN..0604..
	C4-PWLN/L-13075-06		6	25	20	C4	13	75	52	-6°	-15°	
	C4-PWLN/L-17090-06		6	32	25	C4	17	90	68	-6°	-10°	
	C5-PWLN/L-22110-06		6	40	32	C5	22	110	88	-6°	-12°	
	C5-PWLN/L-27140-06		6	50	40	C5	27	140	119	-6°	-10°	
	C3-PWLN/L-17090-08		8	32	25	C3	17	90	74	-6°	-10°	
	C4-PWLN/L-17090-08		8	32	25	C4	17	90	67	-6°	-10°	
	C4-PWLN/L-22110-08		8	40	32	C4	22	110	89	-6°	-10°	
	C4-PWLN/L-27120-08		8	50	40	C4	27	120	100	-6°	-10°	
	C5-PWLN/L-17090-08		8	32	25	C5	17	90	67	-6°	-10°	
	C5-PWLN/L-22110-08		8	40	32	C5	22	110	88	-6°	-10°	
	C5-PWLN/L-27140-08		8	50	40	C5	27	140	119	-6°	-10°	
	C6-PWLN/L-27140-08		8	50	40	C6	27	140	115	-6°	-10°	
	C6-PWLN/L-35175-08		8	63	50	C6	35	175	152	-6°	-10°	

For information on the rake angle γ (for indexable inserts without geometry) and on the inclination angle λ_s , see page A 301.

Measured with master insert WN . . 060408 / WN . . 080408.

Bodies and assembly parts are included in the scope of delivery.

Assembly parts	Type D_{min} mm	WN..0604.. 25-32	WN..0604.. 40-50	WN..0804.. 32	WN..0804.. 40	WN..0804.. 50-63
	Shim		AP172-WN0612 $r \leq 1,2$		AP170-WN0816 $r \leq 1,6$	AP170-WN0816 $r \leq 1,6$
	Pipe pin		RS101		RS102	RS102
	Lever	KN108	KN101	KN109	KN102	KN102
	Clamping screw Tightening torque	FS331 (SW 2) 2,0 Nm	FS351 (SW 2,5) 2,0 Nm	FS332 (SW 2,5) 2,5 Nm	FS352 (SW 3) 5,0 Nm	FS352 (SW 3) 5,0 Nm
	Assembly plug		MD101		MD101	MD101
	Allen key	ISO 2936-2 (SW 2)	ISO 2936-2,5 (SW 2,5)	ISO 2936-2,5 (SW 2,5)	ISO 2936-3 (SW 3)	ISO 2936-3 (SW 3)

Accessories	Type D_{min} mm	WN..0804.. 40-63
	Shim	AP170-WN0808 $r \leq 0,8$

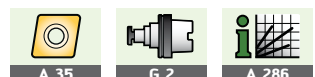

Walter Capto™ C ... – SCLC

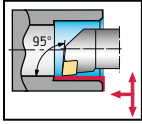

- positive toolholder range
- internal machining
- screw clamping

Tool	Designation		D_{min} mm	d_2 mm	d_1 mm	f mm	l_4 mm	l_{16} mm	γ	λ_s	Type
Walter Capto™ ISO 26623 $\kappa = 95^\circ$	C3-SCLCR/L-11065-09	9	20	16	C3	11	65	48	0°	-8,5°	CC...09T3...
	C3-SCLCR/L-13075-09	9	25	20	C3	13	75	58	0°	-6°	
	C3-SCLCR/L-17090-09	9	32	25	C3	17	90	74	0°	-3,5°	
	C4-SCLCR/L-11070-09	9	20	16	C4	11	70	47	0°	-8,5°	
	C4-SCLCR/L-13080-09	9	25	20	C4	13	80	57	0°	-6°	
	C4-SCLCR/L-17090-09	9	32	25	C4	17	90	68	0°	-3,5°	
	C4-SCLCR/L-27080-09	9	50	40	C4	27	80	60	0°	-6,5°	
	C5-SCLCR/L-11070-09	9	20	16	C5	11	70	46	0°	-8,5°	
	C5-SCLCR/L-13080-09	9	25	20	C5	13	80	56	0°	-6°	
	C5-SCLCR/L-17090-09	9	32	25	C5	17	90	67	0°	-3,5°	
	C5-SCLCR/L-35100-09	9	63	50	C5	35	100	80	0°	-4,5°	
	C3-SCLCR/L-22064-12	12	40	32	C3	22	64	49	0°	-10°	CC...1204...
	C4-SCLCR/L-17090-12	12	32	25	C4	17	90	68	0°	-4,5°	
	C4-SCLCR/L-22110-12	12	40	32	C4	22	110	89	0°	-10°	
	C4-SCLCR/L-27080-12	12	50	40	C4	27	80	60	0°	-7°	
	C5-SCLCR/L-17090-12	12	32	25	C5	17	90	67	0°	-4,5°	
	C5-SCLCR/L-22110-12	12	40	32	C5	22	110	88	0°	-10°	
	C5-SCLCR/L-27140-12	12	50	40	C5	27	140	119	0°	-7°	

For information on the rake angle γ (for indexable inserts without geometry) and on the inclination angle λ_s , see page A 301.

Measured with master insert CC...09T308 / CC...120408.

Bodies and assembly parts are included in the scope of delivery.

Assembly parts	Type D_{min} mm	CC...09T3... 20-25	CC...09T3... 32	CC...09T3... 50-63	CC...1204... 32	CC...1204... 40-50
	Clamping screw for insert Tightening torque	FS2062 (Torx 15IP) 3,0 Nm	FS2063 (Torx 15IP) 3,0 Nm	FS2060 (Torx 15 IP) 3,0 Nm	FS2064 (Torx 15IP) 3,0 Nm	FS2065 (Torx 15IP) 3,0 Nm
	Shim			AP313-CC0908 $r \leq 0,8$		AP314-CC1212 $r \leq 1,2$
	Screw for shim			FS2068 (SW 3,5)		FS2069 (SW 4)
	Torx key	FS1465 (Torx 15IP/SW 3,5)	FS1465 (Torx 15IP/SW 3,5)	FS1465 (Torx 15IP/SW 3,5)	FS1496 (Torx 15IP/SW 4)	FS1496 (Torx 15IP/SW 4)



Walter Capto™ C ... – SDUC

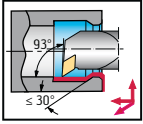

- positive toolholder range
- internal machining
- screw clamping

Tool	Designation		D _{min} mm	d ₂ mm	d ₁ mm	f mm	l ₄ mm	l ₁₆ mm	γ	λ _s	Type
Walter Capto™ ISO 26623 κ = 93° 	C3-SDUCR/L-11065-07	7	20	16	C3	11	65	48	0°	-4,5°	DC...0702...
	C4-SDUCR/L-11070-07	7	20	16	C4	11	70	47	0°	-4,5°	
	C5-SDUCR/L-11070-07	7	20	16	C5	11	70	46	0°	-4,5°	
	C3-SDUCR/L-13075-11	11	25	20	C3	13	75	58	0°	-6°	DC...11T3...
	C3-SDUCR/L-17090-11	11	32	25	C3	17	90	73	0°	-3,5°	
	C4-SDUCR/L-13080-11	11	25	20	C4	13	80	57	0°	-6°	
	C4-SDUCR/L-17090-11	11	32	25	C4	17	90	68	0°	-3,5°	
	C4-SDUCR/L-22110-11	11	40	32	C4	22	110	89	0°	-7,5°	
	C4-SDUCR/L-27080-11	11	50	40	C4	27	80	60	0°	-5,5°	
	C5-SDUCR/L-13080-11	11	25	20	C5	13	80	56	0°	-6°	
	C5-SDUCR/L-17090-11	11	32	25	C5	17	90	67	0°	-3,5°	
	C5-SDUCR/L-22110-11	11	40	32	C5	22	110	88	0°	-7,5°	

For information on the rake angle γ (for indexable inserts without geometry) and on the inclination angle λ_s, see page A 301.

Measured with master insert DC...070204 / DC...11T308.

Bodies and assembly parts are included in the scope of delivery.

Assembly parts	Type D _{min} mm	DC...0702... 20	DC...11T3... 25	DC...11T3... 32	DC...11T3... 40-50
	Clamping screw for insert Tightening torque	FS2061 (Torx 7IP) 0,9 Nm	FS2062 (Torx 15IP) 3,0 Nm	FS2063 (Torx 15IP) 3,0 Nm	FS2060 (Torx 15 IP) 3,0 Nm
	Shim				AP315-DC1108 r ≤ 0,8
	Screw for shim				FS2068 (SW 3,5)
	Torx key	FS1490 (Torx 7IP)	FS1465 (Torx 15IP/SW 3,5)	FS1465 (Torx 15IP/SW 3,5)	FS1465 (Torx 15IP/SW 3,5)



Walter Capto™

C ... – STFC

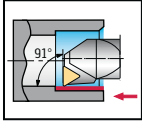

- positive toolholder range
- internal machining
- screw clamping

Tool	Designation		D_{min} mm	d_2 mm	d_1 mm	f mm	l_4 mm	l_{16} mm	γ	λ_s	Type
Walter Capto™ ISO 26623 $\kappa = 91^\circ$	C3-STFCR/L-11065-11	11	20	16	C3	11	65	48	0°	-4,5°	TC .. 1102 ..
	C3-STFCR/L-13075-11	11	25	20	C3	13	75	59	0°	-3°	
	C4-STFCR/L-11070-11	11	20	16	C4	11	70	47	0°	-4,5°	
	C4-STFCR/L-13080-11	11	25	20	C4	13	80	58	0°	-3°	
	C5-STFCR/L-11070-11	11	20	16	C5	11	70	46	0°	-4,5°	
	C5-STFCR/L-13080-11	11	25	20	C5	13	80	56	0°	-3°	TC .. 16T3 ..
	C4-STFCR/L-17090-16	16	32	25	C4	17	90	68	0°	-3,5°	
	C4-STFCR/L-22110-16	16	40	32	C4	22	110	89	0°	-7°	
	C5-STFCR/L-17090-16	16	32	25	C5	17	90	67	0°	-3,5°	
	C5-STFCR/L-22110-16	16	40	32	C5	22	110	88	0°	-7°	

For information on the rake angle γ (for indexable inserts without geometry) and on the inclination angle λ_s , see page A 301.

Measured with master insert TC .. 110204 / TC .. 16T308.

Bodies and assembly parts are included in the scope of delivery.

Assembly parts	Type D_{min} mm	TC .. 1102 .. 20-25	TC .. 16T3 .. 32	TC .. 16T3 .. 40
	Clamping screw for insert Tightening torque	FS2061 (Torx 7IP) 0,9 Nm	FS2063 (Torx 15IP) 3,0 Nm	FS2060 (Torx 15 IP) 3,0 Nm
	Shim			AP317-TC1612 $r \leq 1,2$
	Screw for shim			FS2068 (SW 3,5)
	Torx key	FS1490 (Torx 7IP)	FS1465 (Torx 15IP/SW 3,5)	FS1465 (Torx 15IP/SW 3,5)



Walter Capto™ C ... – SVQB

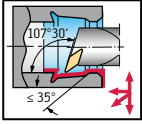

- positive toolholder range
- internal machining
- screw clamping

Tool	Designation		D _{min} mm	d ₂ mm	d ₁ mm	f mm	l ₄ mm	l ₁₆ mm	γ	λ _s	Type	
Walter Capto™ ISO 26623 κ = 107°30'	C3-SVQBR/L-13070-11		11	22	16	C3	13	70	53,4	0°	-7°	VB/C...1103...
	C3-SVQBR/L-15080-11		11	27	20	C3	15	70	64,9	0°	-5°	
C4-SVQBR/L-13070-11		11	25	20	C4	13	70	47,9	0°	-7°		
C4-SVQBR/L-15080-11		11	27	20	C4	15	70	57,9	0°	-5°		
C5-SVQBR/L-15080-11		11	27	20	C5	15	70	56,5	0°	-5°		
 	C3-SVQBR/L-18090-16		16	33	25	C3	18	70	75	0°	-7°	VB/C...1604...
	C3-SVQBR/L-22096-16		16	40	32	C3	22	70	82	0°	-7,5°	
	C4-SVQBR/L-18090-16		16	33	25	C4	18	90	69	0°	-7°	
	C4-SVQBR/L-22110-16		16	40	32	C4	22	70	89	0°	-7,5°	
	C4-SVQBR/L-27120-16		16	50	40	C4	27	70	100	0°	-5°	
	C4-SVQBR/L-27080-16		16	50	40	C4	27	70	60	0°	-5°	
	C5-SVQBR/L-18090-16		16	33	25	C5	18	90	67	0°	-6°	
	C5-SVQBR/L-22110-16		16	40	32	C5	22	70	88	0°	-7,5°	
	C5-SVQBR/L-27140-16		16	50	40	C5	27	70	119	0°	-5°	
	C5-SVQBR/L-35100-16		16	63	50	C5	35	70	81	0°	-3°	
	C5-SVQBR/L-35150-16		16	63	50	C5	35	70	131	0°	-3°	
	C6-SVQBR/L-22120-16		16	40	32	C6	22	70	94	0°	-7,5°	
	C6-SVQBR/L-27145-16		16	50	40	C6	27	70	120	0°	-5°	
	C6-SVQBR/L-35175-16		16	63	50	C6	35	70	152	0°	-3°	

For information on the rake angle γ (for indexable inserts without geometry) and on the inclination angle λ_s, see page A 301.

Measured with master insert VB...110304 / VB...160408.

Bodies and assembly parts are included in the scope of delivery.

Assembly parts	Type D _{min} mm	VB/C...1103... 22-27	VB/C...1604... 33	VB/C...1604... 40-63
	Clamping screw for insert Tightening torque	FS2172 (Torx 7IP) 0,9 Nm	FS2063 (Torx 15IP) 3,0 Nm	FS2060 (Torx 15 IP) 3,0 Nm
	Shim		AP316-VB1608 r ≤ 0,8	AP316-VB1608 r ≤ 0,8
	Screw for shim		FS2068 (SW 3,5)	FS2068 (SW 3,5)
	Torx key	FS1490 (Torx 7IP)	FS1465 (Torx 15IP/SW 3,5)	FS1465 (Torx 15IP/SW 3,5)

Accessories	Type D _{min} mm	VB/C...1604... 33-63
	Shim	AP330-VB1612 r ≤ 1,2



Walter Capto™ C ... – PVQB

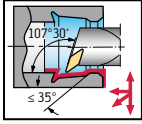

- positive toolholder range
- internal machining
- lever type clamping

Tool

Walter Capto™ ISO 26623
κ = 107°30'

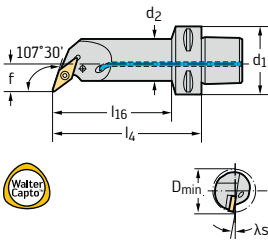

Designation



Designation	D_{min} mm	d_2 mm	d_1 mm	f mm	l_4 mm	l_{16} mm	γ	λ_s	Type
C3-PVQBR/L-13070-11	11	25	20	C3	13	70	0°	-6°	VB/C .. 1103 ..
C3-PVQBR/L-15080-11	11	27	20	C3	15	80	0°	-6°	
C4-PVQBR/L-13070-11	11	25	20	C4	13	70	0°	-6°	
C4-PVQBR/L-15080-11	11	27	20	C4	15	80	0°	-6°	
C5-PVQBR/L-15080-11	11	27	20	C5	15	80	0°	-6°	
C4-PVQBR/L-22110-16	16	40	32	C4	22	110	0°	-8°	VB/C .. 1604 ..
C4-PVQBR/L-27120-16	16	50	40	C4	27	120	0°	-8°	
C4-PVQBR/L-27080-16	16	50	40	C4	27	80	0°	-8°	
C5-PVQBR/L-22110-16	16	40	32	C5	22	110	0°	-8°	
C5-PVQBR/L-27140-16	16	50	40	C5	27	140	0°	-8°	
C5-PVQBR/L-35100-16	16	63	50	C5	35	100	0°	-7°	
C5-PVQBR/L-35150-16	16	63	50	C5	35	150	0°	-7°	
C6-PVQBR/L-22120-16	16	40	32	C6	22	120	0°	-8°	
C6-PVQBR/L-27145-16	16	50	40	C6	27	145	0°	-8°	
C6-PVQBR/L-35175-16	16	63	50	C6	35	175	0°	-8°	

For information on the rake angle γ (for indexable inserts without geometry) and on the inclination angle λ_s , see page A 301.

Measured with master insert VB .. 110304 / VB .. 160408.

Bodies and assembly parts are included in the scope of delivery.

Assembly parts

Assembly parts	Type D_{min} mm	VB/C .. 1103 .. 25-27	VB/C .. 1604 .. 40	VB/C .. 1604 .. 50-63
	Shim			AP153 $r \leq 0,8$
	Lever	KN118	KN114	KN110
	Pipe pin			RS101
	Clamping screw	FS347 (SW 2)	FS332 (SW 2,5)	FS351 (SW 2,5)
	Tightening torque	0,6 Nm	2,5 Nm	2,0 Nm
	Assembly plug			MD101
	Allen key	ISO2936-2 (SW 2)	ISO2936-2,5 (SW 2,5)	ISO2936-2,5 (SW 2,5)



Walter Capto™ C ... – SWLC

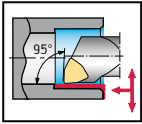

- positive toolholder range
- internal machining
- screw clamping

Tool	Designation		D _{min} mm	d ₂ mm	d ₁ mm	f mm	l ₄ mm	l ₁₆ mm	γ	λ _s	Type
Walter Capto™ ISO 26623 κ = 95° 	C3-SWLCR/L-11065-06	6	20	16	C3	11	65	48,4	0°	-8,5°	WC...06T3...
	C3-SWLCR/L-13075-06	6	25	20	C3	13	75	58,9	0°	-6°	
	C3-SWLCR/L-17090-06	6	32	25	C3	17	90	74,6	0°	-3,5°	
	C4-SWLCR/L-11070-06	6	20	16	C4	11	70	47,3	0°	-8,5°	
	C4-SWLCR/L-13080-06	6	25	20	C4	13	80	57,9	0°	-6°	
	C4-SWLCR/L-17090-06	6	32	25	C4	17	90	68,5	0°	-3,5°	
	C4-SWLCR/L-27080-06	6	50	40	C4	27	80	60,4	0°	-4°	
	C5-SWLCR/L-13080-06	6	25	20	C5	13	80	56,5	0°	-6°	
	C5-SWLCR/L-17090-06	6	32	25	C5	17	90	67,2	0°	-3,5°	
	C5-SWLCR/L-35100-06	6	63	50	C5	35	100	80,4	0°	-2,5°	
	C3-SWLCR/L-22064-08	8	40	32	C3	22	64	49,4	0°	-9,5°	WC...0804...
	C4-SWLCR/L-17090-08	8	32	25	C4	17	90	68,5	0°	-4°	
	C4-SWLCR/L-22110-08	8	40	32	C4	22	110	89,5	0°	-9,5°	
	C4-SWLCR/L-27080-08	8	50	40	C4	27	80	60,4	0°	-7°	
	C5-SWLCR/L-17090-08	8	32	25	C5	17	90	67,2	0°	-4°	
	C5-SWLCR/L-22110-08	8	40	32	C5	22	110	88,1	0°	-9,5°	
	C5-SWLCR/L-27140-08	8	50	40	C5	27	140	119,2	0°	-7°	
	C5-SWLCR/L-35100-08	8	63	50	C5	35	100	80,4	0°	-5°	

For information on the rake angle γ (for indexable inserts without geometry) and on the inclination angle λ_s, see page A 301.

Measured with master insert WC...06T308 / WC...080408.

Bodies and assembly parts are included in the scope of delivery.

Assembly parts	Type D _{min} mm	WC...06T3... 20-32	WC...06T3... 50-63	WC...0804... 32	WC...0804... 40-63
	Clamping screw for insert Tightening torque	FS2062 (Torx 15IP) 3,0 Nm	FS2063 (Torx 15IP) 3,0 Nm	FS2064 (Torx 15IP) 3,0 Nm	FS2065 (Torx 15IP) 3,0 Nm
	Shim		AP318-WC0608		AP320-WC0812
	Screw for shim		FS2068 (SW 3,5)		FS2069 (SW 4)
	Torx key	FS1465 (Torx 15IP/ SW 3,5)	FS1465 (Torx 15IP/ SW 3,5)	FS1496 (Torx 15IP/ SW 4)	FS1496 (Torx 15IP/ SW 4)

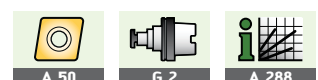

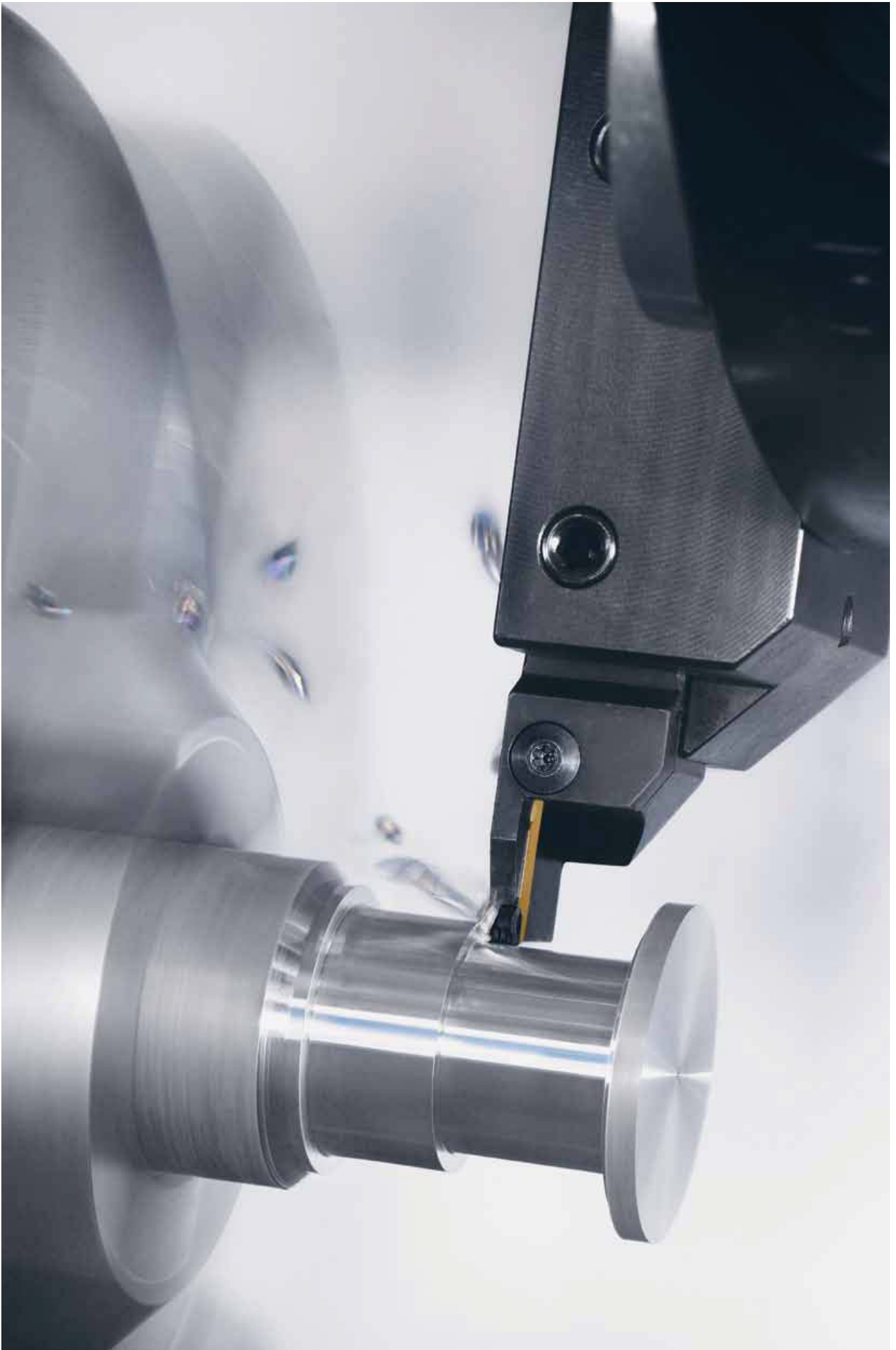

Walter Cut system overview

Tool families for grooving and parting off



G1011 monoblock tool

- For GX inserts
- For grooving, parting off and longitudinal turning
- For all types of lathe
- Different cutting depths available
- Clamped with screws
- Access for screw from above and below; extremely simple tool handling, even during inverted use
- Best chip evacuation by means of low head height



XLDE monoblock tool for parting off

- Simple tool handling because of angled access clamping screw
- Shank sizes 10 x 10 mm–20 x 20 mm for use on sliding head machines and multi-spindle machines
- Quick insert replacement time by possibility of insert replacement in the machine
- For parting diameters of up to 32 mm



G1042 deep parting blade

- Cost-effective, double-edged parting off solution with cutting depth of up to 23 mm
- Single-edged parting off solution with cutting depth of up to 60 mm
- Stable 4-point clamping
- Simple tool handling
- Defined clamping force
- One tool system for single and double-edged inserts



G1041 Reinforced parting blade

- Maximum process reliability due to stable tool design
- Maximum cost efficiency due to double-ended inserts for parting off operation
- Optimum insert holding due to Torx Plus screw clamping and insert seat design
- Little tool deflection due to reinforced tool body
- Longer tool life due to reduction in micro-vibration



Walter Cut Modular

- Maximum grooving flexibility
- Small inventory
- Short set-up times
- For GX, FX and LX inserts
- 3 different parting systems can be used
- 900 possible combinations



G1111 monoblock tool for axial grooving

- For GX24 inserts
- For grooving and recessing
- Best chip evacuation by means of low tool head height
- Access for screw from above and below; extremely simple tool handling, even during inverted use



G15 . . monoblock tool for shallow cutting depths

- For GX inserts
- For grooving, groove-turning and recess turning
- Cutting depth of up to 6 mm
- Groove widths of 2–6 mm in one and the same tool
- Best chip evacuation by means of low tool head height
- Access for screw from above and below; extremely simple tool handling, even during inverted use

Product range overview of Walter Cut grooving tools

Parting off / grooving

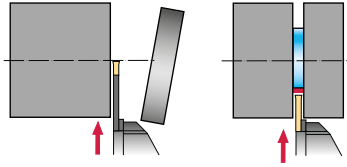

GX system

FX system

XLDE	NCAE / NCBE	G1041	XLCE
s = 1,5–3 mm T _{max} = 16 mm  Page A 210	s = 2–8 mm T _{max} = 21 mm  Shank tools: Page A 218  Page A 250	s = 1,5–4 mm T _{max} = 32 mm  Page A 214	s = 2,2–4,1 mm T _{max} = 25 mm  Page A 212
XLDE-C	NCLE	G1041-C	NCDE
s = 1,5–3 mm T _{max} = 16 mm  Page A 211	s = 2–8 mm T _{max} = 21 mm  Shank tools: Page A 220  Page A 254	s = 1,5–4 mm T _{max} = 32 mm  Page A 215	s = 2,2–8,0 mm T _{max} = 45 mm  Shank tools: Page A 226  Page A 260
G1011	NCCE	G1042	NCME
s = 2–6 mm T _{max} = 32 mm  Page A 207	s = 0,6–2,25 mm T _{max} = 3 mm  Shank tools: Page A 220  Page A 256	s = 3–6 mm T _{max} = 60 mm  Page A 213	s = 2,2–4,0 mm T _{max} = 45 mm  Shank tools: Page A 228  Page A 262
	NCNE	XLCFN	XLCFN / XLCEN
	s = 0,6–2,25 mm T _{max} = 3 mm  Shank tools: Page A 224  Page A 258	s = 3–8 mm T _{max} = 80 mm  Page A 216	s = 2,2–9,7 mm T _{max} = 80 mm  Page A 216

Grooving / recessing		Axial grooving		Internal grooving
<p>GX system</p>		<p>GX system</p>		<p>GX system</p>
G1011		G1511		I 12
<p>s = 2–6 mm T_{max} = 32 mm</p> <p>Page A 207</p>		<p>s = 2–6 mm T_{max} = 6 mm</p> <p>Page A 208</p>		<p>s = 1,95–2,5 mm T_{max} = 3 mm</p> <p>Page A 245</p>
G1521		G1551		NCEE
<p>s = 2–6 mm T_{max} = 6 mm</p> <p>Page A 208</p>		<p>s = 3–6 mm T_{max} = 6 mm</p> <p>Page A 209</p>		<p>s = 3–6 mm T_{max} = 15 mm</p> <p>Shank tools: Page A 232 Page A 264</p>
NCAE / NCBE		NCCE		NCHE
<p>s = 2–8 mm T_{max} = 21 mm</p> <p>Shank tools: Page A 218 Page A 250</p>		<p>s = 0,6–2,25 mm T_{max} = 3 mm</p> <p>Shank tools: Page A 222 Page A 256</p>		<p>s = 3–6 mm T_{max} = 15 mm</p> <p>Shank tools: Page A 234 Page A 266</p>
NCAE / NCBE		NCCE		NCFE
<p>s = 2–8 mm T_{max} = 21 mm</p> <p>Shank tools: Page A 218 Page A 250</p>		<p>s = 3–6 mm T_{max} = 21 mm</p> <p>Shank tools: Page A 236 Page A 286</p>		<p>s = 1,95–6 mm T_{max} = 19 mm</p> <p>Page A 246</p>
NCLE		NCNE		NCOE
<p>s = 2–8 mm T_{max} = 21 mm</p> <p>Shank tools: Page A 220 Page A 254</p>		<p>s = 3–6 mm T_{max} = 21 mm</p> <p>Shank tools: Page A 238 Page A 270</p>		<p>s = 0,6–3,25 mm T_{max} = 3 mm</p> <p>Page A 248</p>
NCLE		NCNE		NCFE-C
<p>s = 2–8 mm T_{max} = 21 mm</p> <p>Shank tools: Page A 220 Page A 254</p>		<p>s = 0,6–2,25 mm T_{max} = 3 mm</p> <p>Shank tools: Page A 224 Page A 258</p>		<p>s = 3–6 mm T_{max} = 21 mm</p> <p>Shank tools: Page A 240 Page A 272</p>
NCLE		NCNE		NCOE-C
<p>s = 2–8 mm T_{max} = 21 mm</p> <p>Shank tools: Page A 220 Page A 254</p>		<p>s = 3–6 mm T_{max} = 21 mm</p> <p>Shank tools: Page A 242 Page A 274</p>		

Designation key for Walter Cut grooving tools

Example for clamping block and blade

NC	D	E	25	—	2525	L	—	FX	51	—	35
1	2	3	4		6	8		9	10 / 11		12

1
Tool range
NC Walter Cut

2	
Machining method	
<p>A 0° radial grooving and turning GX</p> <p>B 0° radial grooving and turning GX</p> <p>C 0° circlip and O-ring grooves GX</p> <p>D 0° radial grooving and parting off GX</p> <p>E 0° axial grooving and face turning GX</p> <p>F 0° deep axial grooving and facing GX</p>	<p>K Deep radial grooving with clamping block and blade GX, FX, L</p> <p>H 90° axial grooving and face turning GX</p> <p>L 90° radial grooving and turning GX</p> <p>M 90° radial grooving and parting off FX, LX</p> <p>N 90° circlip and O-ring grooves GX</p> <p>O 90° deep axial grooving and facing GX</p>

3
Application
<p>E External machining</p> <p>I Internal machining</p>

8
Holder design
<p>R Right-hand</p> <p>L Left-hand</p> <p>N Neutral</p>

9
Holder design
<p>FX Grooving single-edged</p> <p>GX Grooving double-edged</p> <p>LX Grooving single-edged</p>

10
Groove width FX / LX [mm]
<p>22 = 2,2</p> <p>31 = 3,1</p> <p>41 = 4,1</p> <p>51 = 5,1</p> <p>65 = 6,5</p> <p>80 = 8,0</p> <p>82 = 8,2</p> <p>97 = 9,7</p>

11
Insert length GX [mm]
<p>09</p> <p>16</p> <p>24</p>

12	
Deep grooving [mm]	
<p>D</p> <p>T_{max}</p> <p>20</p> <p>21</p> <p>25</p> <p>32</p> <p>35</p> <p>45</p>	<p>K</p> <p>D_{max}</p> <p>50</p> <p>70</p> <p>80</p> <p>100</p> <p>110</p> <p>160</p>

Example for axial grooving 0°

NC	E	E	25	-	2525	R	-	GX	24	-	3	-	2	-	C
1	2	3	5		7	8		9	11		13		14		15

4
Clamping block / blade [mm]
h ₃
26
32
46

5
Module size
12
16
20
25
32
40

6										
Shank dimensions Clamping block / blade [mm]										
<table border="1"> <thead> <tr> <th>h₁ = h₂</th> <th>b</th> </tr> </thead> <tbody> <tr> <td>20</td> <td>20</td> </tr> <tr> <td>25</td> <td>29</td> </tr> <tr> <td>32</td> <td>37</td> </tr> <tr> <td>40</td> <td></td> </tr> </tbody> </table>	h ₁ = h ₂	b	20	20	25	29	32	37	40	
h ₁ = h ₂	b									
20	20									
25	29									
32	37									
40										

7		
Shank dimensions [mm] / Walter Capto™		
External holder		Walter Capto™
Height	Width	External
12	12	C3 00 = C3
16	16	C4 00 = C4
20	20	C5 00 = C5
25	25	C6 00 = C6
32	25	
Boring bar		
d₁	d/l	
20	1/1,5 = 15	
25	1/2,5 = 25	
32		
40		

13
Width category GX
1
2
3
4
5

14
Axial diameter range [mm]
1 50-70
2 70-100
3 100-150
4 150-300
5 300-900

15
Version
C Contra



Walter Cut G1011

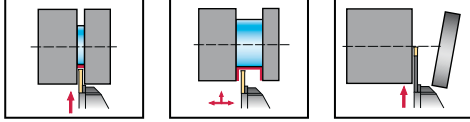

- external machining
- radial grooving 0°
- one-piece shank tool
- for grooving, recessing and parting off
- for GX inserts

Tool	Designation	s mm	T _{max} mm	D _{max} mm	h=h ₁ mm	b mm	f ₁ mm	l ₁ mm	l ₄ mm	s ₁ mm	Type	
	G1011.1212R/L-2T8GX16	2	8		12	12	11,2	121,5	31,5	1,6	GX 16-1E2/F2 ..	
	G1011.1212R/L-2T12GX16		12		12	12	11,2	121,5	31,5	1,6		
	G1011.1616R/L-2T8GX16		8		16	16	15,2	131,5	35,5	1,6		
	G1011.1616R/L-2T15GX16		15		16	16	15,2	135,5	35,5	1,6		
	G1011.2020R/L-2T8GX16		8		20	20	19,2	141,5	31,5	1,6		
	G1011.2020R/L-2T15GX16		15		20	20	19,2	145,5	35,5	1,6		
	G1011.2525R/L-2T8GX16		8		25	25	24,2	141,5	31,5	1,6		
	G1011.2525R/L-2T15GX16		15		25	25	24,2	145,5	35,5	1,6		
	G1011.1616R/L-3T12GX24		12		16	16	14,8	135	35	2,4		GX 24-2E3/F3 ..
	G1011.1616R/L-3T21GX24		21	80	16	16	14,8	150	40	2,4		
	G1011.2020R/L-3T12GX24		12		20	20	18,8	145	35	2,4		
	G1011.2012R/L-3T21GX24		21	80	20	12	10,8	150	40	2,4		
G1011.2020R/L-3T21GX24	21	80	20	20	18,8	150	40	2,4				
G1011.2525R/L-3T12GX24	12		25	25	11,3	145	35	2,4				
G1011.1616R/L-4T12GX24	12		16	16	14,3	135	35	3,4	GX 24-3E4/F4 ..			
G1011.1616R/L-4T21GX24	21	80	16	16	14,3	150	40	3,4				
G1011.2020R/L-4T12GX24	12		20	20	18,3	145	35	3,4				
G1011.2020R/L-4T21GX24	21	80	20	20	18,3	150	40	3,4				
G1011.2012R/L-4T21GX24	21	80	20	12	10,3	150	40	3,4				
G1011.2525R/L-4T12GX24	12		25	25	10,8	145	35	3,4				
G1011.2525R/L-4T21GX24	21	80	25	25	23,3	150	40	3,4				
G1011.2020R/L-5T12GX24	12		20	20	17,9	145	35	4,2		GX 24-3E5/F5 ..		
G1011.2020R/L-5T21GX24	21	80	20	20	17,9	150	40	4,2				
G1011.2525R/L-5T12GX24	12		25	25	10,4	145	35	4,2				
G1011.2525R/L-5T21GX24	21	80	25	25	10,4	150	40	4,2				
G1011.2525R/L-5T32GX24	32	120	25	25	22,9	165	55	4,2				
G1011.2020R/L-6T12GX24	12		20	20	17,4	145	35	5,2	GX 24-4E6/F6 ..			
G1011.2020R/L-6T21GX24	21	80	20	20	17,4	150	40	5,2				
G1011.2525R/L-6T12GX24	12		25	25	9,9	145	35	5,2				
G1011.2525R/L-6T21GX24	21	80	25	25	9,9	150	40	5,2				
G1011.2525R/L-6T32GX24	32	120	25	25	22,4	165	55	5,2				

For T_{max} with greater diameters than D_{max}, see technical information on page A 318.

Max. double-edged GX insert cutting depth 23 mm

$f = f_1 + s/2$

Ordering example: right-handed shank tool: G1011.2020 R-3T12GX24/left-handed shank tool: G1011.2020 L-3T12GX24

Bodies and assembly parts are included in the scope of delivery.

Assembly parts

	Type	GX 16-1E2/F2 . . -GX 24-4E6/F6 . .
	Clamping screw for grooving insert Tightening torque	FS2118 (Torx 20IP) 5,0 Nm
	Torx key	FS1464 (Torx 20IP)

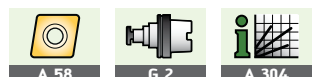

Walter Cut G1511 / G1521

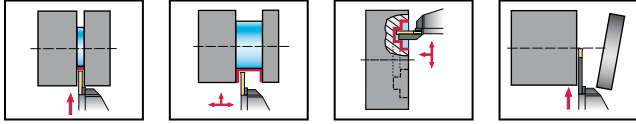

- external machining
- radial grooving 0°/90°
- axial grooving 0°/90°
- one-piece shank tool
- for grooving, recessing and parting off
- for GX inserts

Tool		Designation	s mm	T _{max} mm	h=h ₁ mm	b mm	f mm	f ₁ mm	l ₂₁ mm	l ₁ mm	l ₄ mm	s ₁ mm	Type		
		G1511.1212R/L-T4GX16	2,0 - 6,0	4	12	12		9,9		131,5	31,5	4,5	GX16-...		
		G1511.1616R/L-T4GX16			16	16		13,9		141,5	31,5	4,5			
		G1511.2020R/L-T4GX16			20	20		17,9		141,5	31,5	4,5			
				G1511.2525R/L-T4GX16	3,0 - 6,0	6	25	25		22,9		141,5	31,5	4,5	GX24-...
				G1511.1616R/L-T6GX24			16	16		13,9		143,5	33,5	4,5	
				G1511.2020R/L-T6GX24			20	20		17,9		143,5	33,5	4,5	
						G1521.1616R/L-T4GX16	2,0 - 6,0	4	16	16	20,5	12,5	134,9		27
G1521.2020R/L-T4GX16	20					20			24,5	14,5	134,9		27		
G1521.2525R/L-T4GX16	25					25			29,5	17	134,9		27		
		G1521.2020R/L-T6GX24	3,0 - 6,0	6	20	20	26,5	16,5	134,9		27	GX24-...			
		G1521.2525R/L-T6GX24			25	25	31,5	19	134,9		27				

G1511: $f = f_1 + s/2$

G1521: $l_1 = l_{21} + S/2$

Ordering example:

Right shank tool: G1511.1212R-T4GX16

Left shank tool: G1511.1212L-T4GX16

Bodies and assembly parts are included in the scope of delivery.

Grooving insert width s mm	Minimum axially cut groove D _{min} [mm]	
	GX16	GX24
3	81	65
4	75	62
5	63	51
6	53	43

Assembly parts

Type	GX16-...GX24-...
 Clamping screw for grooving insert Tightening torque	FS2118 (Torx 20IP) 5,0 Nm
 Torx key	FS1464 (Torx 20IP)



Walter Cut G1551

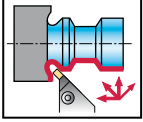
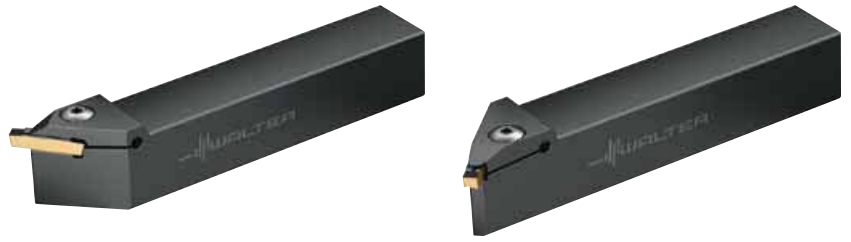

- external machining
- grooving 45°
- copy turning
- one-piece shank tool
- for grooving, recessing and copy turning
- for GX inserts

Tool		Designation	s mm	T _{max} mm	h=h ₁ mm	b mm	f mm	f ₁ mm	l ₂₁ mm	l ₄ mm	Type
		G1551.2020R/L-T6GX24	3,0 - 6,0	6	20	20	23,2	13,2	143,1	33,1	GX24- . .
		G1551.2525R/L-T6GX24		6	25	25	28,2	15,7	143,1	33,1	

G1551: l₁=l₂₁+0,707 x s/2
 f=f₁+0,707 x s/2
 Ordering example:
 Right shank tool: G1551.2020R-T6GX24
 Left shank tool: G1551.2020L-T6GX24

Assembly parts		Type	GX24- . .
	Clamping screw for grooving insert Tightening torque		FS2118 (Torx 20IP) 5,0 Nm
	Torx key		FS1464 (Torx 20IP)

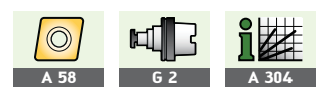

Walter Cut XLDE

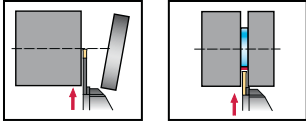
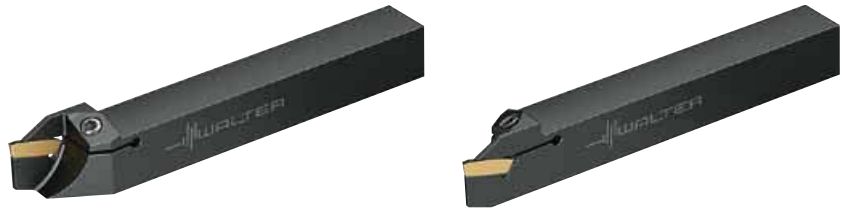

- external machining
- radial grooving 0°
- one-piece shank tool
- for grooving and parting off
- for GX inserts

Tool

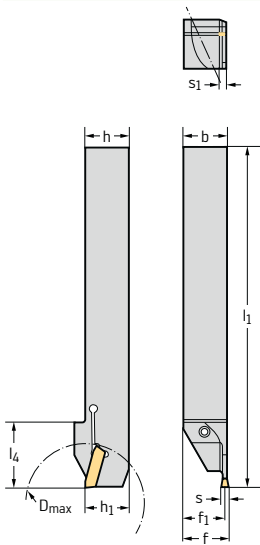

Designation	s mm	D _{max} mm	h=h ₁ mm	b mm	f ₁ mm	l ₁ mm	l ₄ mm	s ₁ mm	Type
XLDER/L1010K-GX16-0	1.5	10	10	10	9,4	125	19	1,2	GX16-0E150..
XLDER/L1212K-GX16-0		12	12	12	11,4	125	19	1,2	
XLDER/L1616K-GX16-0		16	16	16	15,4	125	24	1,2	
XLDER/L1010K-GX16-1	2,0 - 2,5	20	10	10	9,2	125	19	1,6	GX16-1E2..
XLDER/L1212K-GX16-1		24	12	12	11,2	125	19	1,6	
XLDER/L1616K-GX16-1		32	16	16	15,2	125	24	1,6	
XLDER/L2020K-GX16-1		32	20	20	19,2	125	24	1,6	
XLDER/L1212K-GX16-2	3	24	12	12	10,8	125	19	2,4	GX16-2E3..
XLDER/L1616K-GX16-2		32	16	16	14,8	125	24	2,4	
XLDER/L2020K-GX16-2		32	20	20	18,8	125	24	2,4	

$$f = f_1 + s/2$$

For description of contra version/standard version, see page A 315.

Ordering example:

Right shank tool: XLDER1010K-GX16-1

Left shank tool: XLDEL1010K-GX16-1

Bodies and assembly parts are included in the scope of delivery.

Assembly parts



Type	GX16-0E150..-GX16-2E3..
Clamping screw for grooving insert	FS2164 (Torx 15IP)
Tightening torque	3,5 Nm

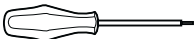

Screwdriver	FS1485 (Torx 15IP)
-------------	--------------------



Walter Cut XLDE-C Contra version

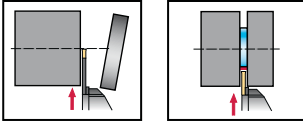
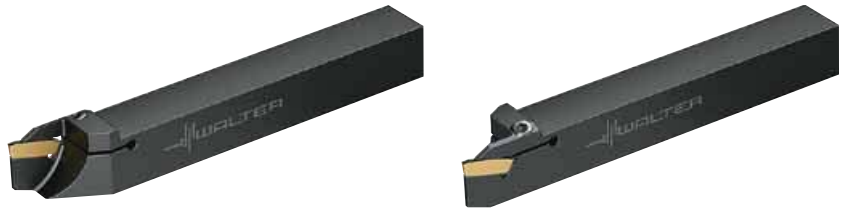

- external machining
- radial grooving 0°
- one-piece shank tool
- for grooving and parting off
- for GX inserts

Tool	Designation	s mm	D _{max} mm	h=h ₁ mm	b mm	f ₁ mm	l ₁ mm	l ₄ mm	s ₁ mm	Type	
	XLDER/L1010K-GX16-0C	1,5	10	10	10	9,2	125	19	1,2	GX16-0E150..	
	XLDER/L1212K-GX16-0C		12	12	12	11,2	125	19	1,2		
	XLDER/L1616K-GX16-0C		12	16	16	15,2	125	24	1,2		
	XLDER/L1010K-GX16-1C	XLDER/L1212K-GX16-1C	2,0 - 2,5	20	10	10	9,2	125	19	1,6	GX16-1E2..
	XLDER/L1616K-GX16-1C			24	12	12	11,2	125	19	1,6	
	XLDER/L1616K-GX16-1C			32	16	16	15,2	125	24	1,6	
	XLDER/L1212K-GX16-2C	XLDER/L1616K-GX16-2C	3	24	12	12	10,8	125	19	2,4	GX16-2E3..
	XLDER/L1616K-GX16-2C			32	16	16	14,8	125	24	2,4	

f=f₁+S/2
 For description of contra version/standard version, see page A 315.
 Ordering example:
 Right shank tool: XLDER1010K-GX16-1C
 Left shank tool: XLDEL1010K-GX16-1C
 Bodies and assembly parts are included in the scope of delivery.

Assembly parts	Type	GX16-0E150..-GX16-2E3..
	Clamping screw for grooving insert Tightening torque	FS2164 (Torx 15IP) 3,5 Nm
	Screwdriver	FS1485 (Torx 15IP)

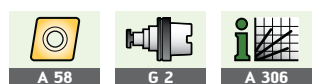

Walter Cut XLCE / XLCF

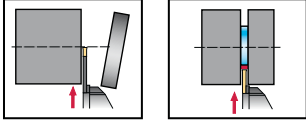

- external machining
- radial grooving 0°
- one-piece shank tool
- for grooving and parting off
- for FX inserts

Tool

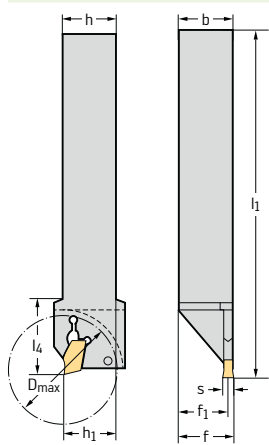

Designation	s mm	D _{max} mm	h=h ₁ mm	b mm	f mm	l ₁ mm	l ₄ mm	Type
XLCER/L1010M22-FX	2,2	30	10	10	10,2	150	19	FX2.2...
XLCER/L1212F22-FX		30	12	12	12,2	80	19	
XLCER/L1212M22-FX		30	12	12	12,2	150	19,4	
XLCER/L1414M22-FX		30	14	14	14,2	150	19,4	
XLCER/L1612H22-FX		30	16	12	12,2	100	20	
XLCFR/L1612H31-FX	3,1	30	16	12	12,3	100	21,9	FX3.1...
XLCFR/L2016K31-FX		40	20	16	16,3	125	25,9	
XLCFR/L2520M31-FX		50	25	20	20,3	150	31,9	
XLCFR/L2016K41-FX	4,1	40	20	16	16,4	125	25,9	FX4.1...
XLCFR/L2520M41-FX		50	25	20	20,8	150	31,9	

For instructions on replacing the cutting edge, see page A 314.

Ordering example:

Right shank tool: XLCER1010M22-FX

Left shank tool: XLCER1010M22-FX

Accessories

Type	FX2.2...	FX3.1...-FX4.1...
 Mounting wrench for FX grooving insert	FS1494	FS1493



A 65



G 2



A 306

Walter Cut G1042

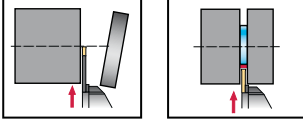

- external machining
- radial grooving 0°
- deep parting blade
- for parting off and grooving
- for GX inserts

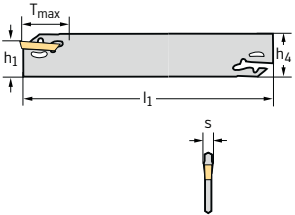
Tool	Designation	s mm	T _{max} mm	h ₄ mm	l ₁ mm	h ₁ mm	Type
	G1042.26N-2T25GX16	2	25	26	108,3	21,1	GX16-1E2/F2...
	G1042.32N-2T25GX16		25	32	149,3	24,8	
	G1042.26N-3T40GX24	3	40	26	108,3	21	GX24-2E3/F3...
	G1042.32N-3T50GX24		50	32	149,3	24,7	
	G1042.26N-4T40GX24	4	40	26	108,3	20,9	GX24-3E4/F4...
	G1042.32N-4T50GX24		50	32	149,3	24,6	
	G1042.32N-5T60GX24	5	60	32	149,3	24,5	GX24-3E5/F5...
	G1042.32N-6T60GX24	6	60	32	149,3	24,4	GX24-4E6/F6...

For clamping blocks, see page A 217.

For instructions on replacing the cutting edge, see page H 314.

Accessories

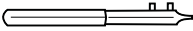
	Type	GX16-1E2/F2 . . .GX24-4E6/F6...
	Mounting wrench for grooving insert	FS1494

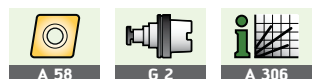

Walter Cut G1041

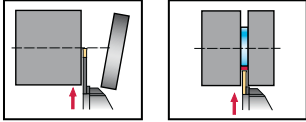

- external machining
- radial grooving 0°
- deep parting blade
- for parting off and grooving
- for GX inserts

Tool	Designation	s mm	T _{max} mm	h ₄ mm	l ₁ mm	h ₁ mm	Type
	G1041.26R/L-1.5T16GX16	1,5	16	26	110	21	GX16-0E..
	G1041.26R/L-2T16GX16	2	16	26	110	21	GX16-1E2/F2..
	G1041.32R/L-2T23GX16		23	32	110	24,6	
	G1041.26R/L-3T16GX16	3	16	26	110	21	GX16-2E3/F3..
	G1041.26R/L-3T23GX24		23	26	110	21	GX24-2E3/F3..
	G1041.32R/L-3T23GX24		23	32	110	24,6	
	G1041.32R/L-3T32GX24		32	32	110	24,6	
	G1041.32R/L-4T32GX24	4	32	32	110	24,6	GX24-3E4/F4..

For clamping blocks, see page A 207.

For description of contra version/standard version, see page A 315.

Bodies and assembly parts are included in the scope of delivery.

Assembly parts

	Type	GX16-0E-GX24-3E4/F4..
	Clamping screw for grooving insert Tightening torque	FS2164 (Torx 15IP) 3,5 Nm

Accessories

	Type	GX16-0E-GX24-3E4/F4..
	Screwdriver	FS1485 (Torx 15IP)



Walter Cut G1041 C Contra version

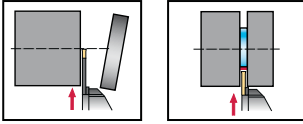

- external machining
- radial grooving 0°
- deep parting blade
- for parting off and grooving
- for GX inserts

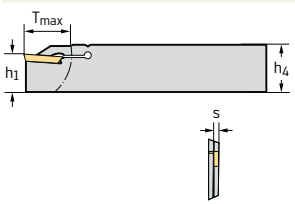
Tool	Designation	s mm	T _{max} mm	h ₄ mm	l ₁ mm	h ₁ mm	Type
	G1041.26R/L-1.5T16GX16C	1,5	16	26	110	21	GX16-0E ..
	G1041.26R/L-2T16GX16C	2	16	26	110	21	GX16-1E2/F2 ..
	G1041.32R/L-2T23GX16C		23	32	110	24,6	
	G1041.26R/L-3T16GX16C	3	16	26	110	21	GX16-2E3/F3 ..
	G1041.26R/L-3T23GX24C		23	26	110	21	GX24-2E3/F3 ..
	G1041.32R/L-3T23GX24C		23	32	110	24,6	
	G1041.32R/L-3T32GX24C		32	32	110	24,6	
	G1041.32R/L-4T32GX24C	4	32	32	110	24,6	GX24-3E4/F4 ..

For clamping blocks, see page A 217.

For description of contra version/standard version, see page A 315.

Bodies and assembly parts are included in the scope of delivery.

Assembly parts

	Type	GX16-0E-GX24-3E4/F4 ..
	Clamping screw for grooving insert Tightening torque	FS2164 (Torx 15IP) 3,5 Nm

Accessories

	Type	GX16-0E-GX24-3E4/F4 ..
	Screwdriver	FS1485 (Torx 15IP)

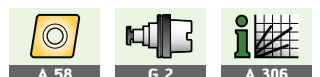

Walter Cut XLC

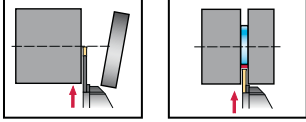
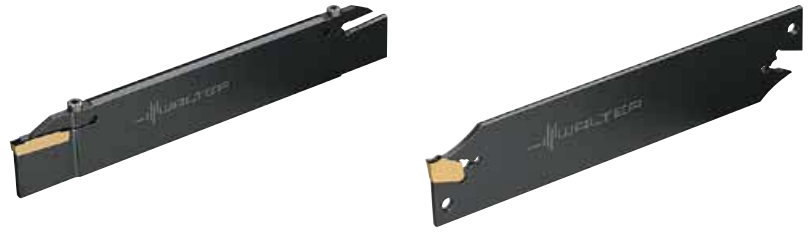

- external machining
- radial grooving 0°
- deep parting blade
- for parting off and grooving
- for FX/GX/LX inserts

Tool	Designation	s mm	T _{max} mm	h ₄ mm	l ₁ mm	h ₁ mm	Type
	XLCEN2602J22-FX	2,2	25	26	110	21,1	FX2.2 ...
	XLCEN3202M22-FX		30	32	151	24,8	
	XLCFN2603J31-FX	3,1	35	26	109,9	21	FX3.1 ...
	XLCFN3203M31-FX		50	32	150,9	24,6	
	XLCFN2604J41-FX	4,1	40	26	109,9	20,9	FX4.1 ...
	XLCFN3204M41-FX		50	32	150,9	24,5	
	XLCFN3205M51-FX	5,1	55	32	150,9	24,4	FX5.1 ...
	XLCFN3206M65-FX	6,5	55	32	150,9	24,2	FX6.5 ...
	XLCEN4608S82-FX	8,2	80	46	248,9	37	FX8.2 ...
	XLCEN4609S97-FX	9,7	80	46	248,9	36,9	FX9.7 ...
	XLCFN3203-GX24-2S	3,0 - 3,5	21	32	179,3	24,2	GX24-2 ...
	XLCFN3204-GX24-3S	4,0 - 5,0	21	32	179,3	24,2	GX24-3 ...
	XLCFN3206-GX24-4S	6	21	32	179,3	24,2	GX24-4 ...
	XLCEN4608-LX	8	80	46	249,7	35,1	LX- ...

For clamping blocks, see page A 217.

Bodies and assembly parts are included in the scope of delivery.

For instructions on replacing the cutting edge, see page A 314.

Assembly parts

	Type	GX24-2 ...	LX- ...
	Clamping screw for grooving insert Tightening torque	FS1342 (Torx 15) 1,0 Nm	FS1217 (Torx 20) 2,0 Nm

Accessories

	Type	FX2.2 ...	FX3.1 ...-FX9.7 ...	GX24-2 ...	LX- ...
	Mounting wrench for FX grooving insert	FS1494	FS1493		
	Handle key			FS1047 (Torx T15)	FS1048 (Torx 20)



Walter Cut SBN

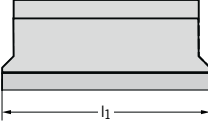
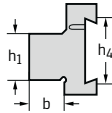

- Clamping blocks for parting blades

Tool	Designation	h_4 mm	h_1 mm	b mm	l_1 mm
 	SBN2020-26-K	26	20	20	90
	SBN2520-32-K	32	25	20	110
	SBN3229-32-K	32	32	29	120
	SBN3229-46-K	46	32	29	150
	SBN4037-46-K	46	40	47	150

Bodies and assembly parts are included in the scope of delivery.

Assembly parts	h_1 mm	20-32	40
 Clamping screw		M06X025 ISO4762 12.9	M08X035 ISO4762 12.9

Walter Cut shank tool NCAE / NCBE

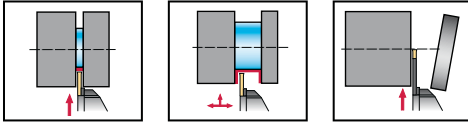

- external machining
- radial grooving 0°
- for grooving, recessing and parting off
- for GX/LX inserts

Tool

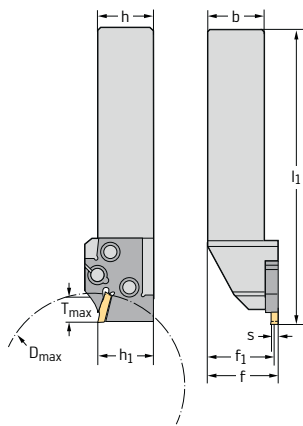

Designation	s mm	T _{max} mm	D _{max} mm	h=h ₁ mm	h ₁ mm
NCAE12-1212R/L-GX09-1	2,0 - 2,5	7	36	12	12
NCAE16-1616R/L-GX09-1		7	52	16	16
NCAE12-1212R/L-GX09-2	3,0 - 3,5	7	36	12	12
NCAE16-1616R/L-GX09-2		7	52	16	16
NCAE20-2020R/L-GX16-1	2,0 - 2,5	12	63	20	20
NCAE25-2525R/L-GX16-1		12	79	25	25
NCAE20-2020R/L-GX16-2	3,0 - 3,5	12	63	20	20
NCAE25-2525R/L-GX16-2		12	79	25	25
NCAE32-3225R/L-GX16-2	4,0 - 5,0	12	100	32	32
NCAE20-2020R/L-GX16-3		12	63	20	20
NCAE25-2525R/L-GX16-3	4,0 - 5,0	12	79	25	25
NCAE32-3225R/L-GX16-3		12	100	32	32
NCAE25-2525R/L-GX16-4	6	12	79	25	25
NCAE32-3225R/L-GX16-4		12	100	32	32
NCBE20-2020R/L-GX24-2-21	3	21	63	20	20
NCBE25-2525R/L-GX24-2-21		21	79	25	25
NCBE25-2525R/L-GX24-3-21	4,0 - 5,0	21	79	25	25
NCBE32-3225R/L-GX24-3-21		21	100	32	32
NCBE25-2525R/L-GX24-4-21	6	21	79	25	25
NCBE32-3225R/L-GX24-4-21		21	100	32	32
NCBE25-2525R/L-GX24-5-21	8	21	79	25	25
NCBE32-3225R/L-LX80-32		32	100	32	32
NCBE32-3225R/L-LX80-45	8	45	100	32	32

$$f=f_1+s/2$$

For T_{max} with greater diameters than D_{max}, see technical information on page A 316.

Bodies and assembly parts are included in the scope of delivery.

Ordering example:

Right-handed shank tool NCAE12-1212R-GX09-1 (right-handed module and right-handed toolholder)

Left-handed shank tool NCAE12-1212L-GX09-1 (left-handed module and left-handed toolholder)

Assembly parts

	Module size	E12	E16	E20	E25	E32
	Clamping screw for LX grooving insert Tightening torque					FS1217 (Torx 20) 2,0 Nm
	Screw for grooving module Tightening torque	FS1051 (Torx 8) 2,0 Nm	FS1052 (Torx 15) 2,0 Nm	FS1053 (Torx 15) 2,0 Nm	FS1054 (Torx 20) 3,0 Nm	FS1055 (Torx 25) 3,0 Nm
	Handle key, small	FS257 (Torx 8)	FS1047 (Torx T15)	FS1047 (Torx T15)	FS1048 (Torx 20)	FS1049 (Torx 25)

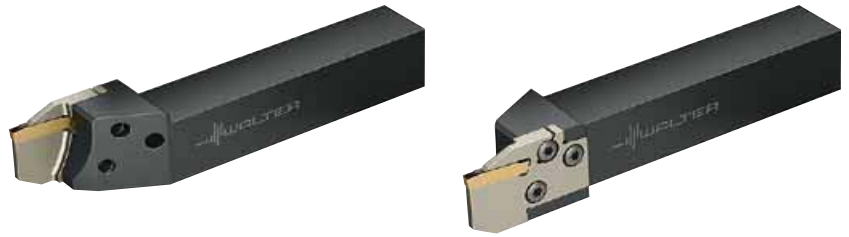

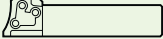
b mm	f mm	f ₁ mm	l ₁ mm	Module size	Type	Grooving module	Toolholder
							
12		14,9	78	E12	GX 09-1 ...	MSS-E12R/L07-GX09-1	MSS-E12R/L00-1212E
16		18,9	98	E16		MSS-E16R/L07-GX09-1	MSS-E16R/L00-1616G
12		14,6	78	E12	GX 09-2 ...	MSS-E12R/L07-GX09-2	MSS-E12R/L00-1212E
16		18,6	98	E16		MSS-E16R/L07-GX09-2	MSS-E16R/L00-1616G
20		23,9	123	E20	GX 16-1 ...	MSS-E20R/L12-GX16-1	MSS-E20R/L00-2020J
25		30,8	153	E25		MSS-E25R/L12-GX16-1	MSS-E25R/L00-2525L
20		23,6	123	E20	GX 16-2 ...	MSS-E20R/L12-GX16-2	MSS-E20R/L00-2020J
25		30,4	153	E25		MSS-E25R/L12-GX16-2	MSS-E25R/L00-2525L
25		30,4	173	E32	GX 16-3 ...	MSS-E32R/L12-GX16-2	MSS-E32R/L00-3225N
20		23,1	123	E20		MSS-E20R/L12-GX16-3	MSS-E20R/L00-2020J
25		29,9	153	E25	GX 16-3 ...	MSS-E25R/L12-GX16-3	MSS-E25R/L00-2525L
25		29,9	173	E32		MSS-E32R/L12-GX16-3	MSS-E32R/L00-3225N
25		29,3	153	E25	GX 16-4 ...	MSS-E25R/L12-GX16-4	MSS-E25R/L00-2525L
25		29,3	173	E32		MSS-E32R/L12-GX16-4	MSS-E32R/L00-3225N
20		23,6	132	E20	GX 24-2 ...	MSS-E20R/L21-GX24-2	MSS-E20R/L00-2020J
25		30,4	162	E25		MSS-E25R/L21-GX24-2	MSS-E25R/L00-2525L
25		29,9	162	E25	GX 24-3 ...	MSS-E25R/L21-GX24-3	MSS-E25R/L00-2525L
25		29,9	182	E32		MSS-E32R/L21-GX24-3	MSS-E32R/L00-3225N
25		29,3	162	E25	GX 24-4 ...	MSS-E25R/L21-GX24-4	MSS-E25R/L00-2525L
25		29,3	182	E32		MSS-E32R/L21-GX24-4	MSS-E32R/L00-3225N
25		28,5	162	E25	GX 24-5 ...	MSS-E25R/L21-GX24-5	MSS-E25R/L00-2525L
25		28,9	194	E32	LX - ...	MSS-E32N32-LX	MSS-E32R/L00-3225N
25		28,9	207	E32		MSS-E32N45-LX	MSS-E32R/L00-3225N

Accessories

Module size

E32



Handle key, small

FS1048 (Torx 20)



A 58



G 2



A 313



A 304

Walter Cut shank tool NCLE

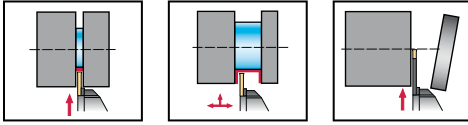

- external machining
- radial grooving 90°
- for grooving, recessing and parting off
- for GX/LX inserts

Tool

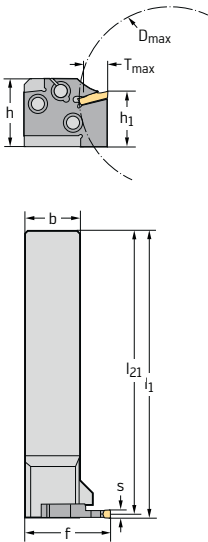

Designation	s mm	T _{max} mm	D _{max} mm	h=h ₁ mm	b mm
NCLE20-2020R/L-GX16-1	2,0 - 2,5	12	63	20	20
NCLE25-2525R/L-GX16-1		12	79	25	25
NCLE20-2020R/L-GX16-2	3	12	63	20	20
NCLE25-2525R/L-GX16-2		12	79	25	25
NCLE32-3225R/L-GX16-2		12	100	32	25
NCLE20-2020R/L-GX16-3	4,0 - 5,0	12	63	20	20
NCLE25-2525R/L-GX16-3		12	79	25	25
NCLE32-3225R/L-GX16-3		12	100	32	25
NCLE25-2525R/L-GX16-4	6	12	79	25	25
NCLE32-3225R/L-GX16-4		12	100	32	25
NCLE20-2020R/L-GX24-2-21	3	21	63	20	20
NCLE25-2525R/L-GX24-2-21		21	79	25	25
NCLE25-2525R/L-GX24-3-21	4,0 - 5,0	21	79	25	25
NCLE32-3225R/L-GX24-3-21		21	100	32	25
NCLE25-2525R/L-GX24-4-21	6	21	79	25	25
NCLE32-3225R/L-GX24-4-21		21	100	32	25
NCLE25-2525R/L-GX24-5-21	8	21	79	25	25
NCLE32-3225R/L-LX80-32		32	100	32	25
NCLE32-3225R/L-LX80-45		45	100	32	25

For Tmax with greater diameters than Dmax, see technical information on page A 316.

Bodies and assembly parts are included in the scope of delivery.

Ordering example:

Right-handed shank tool: NCLE25-2525R-GX16-1 (left-handed module and right-handed toolholder)

Left-handed shank tool: NCLE25-2525L-GX16-1 (right-handed module and left-handed toolholder)

Assembly parts

	Module size	E20	E25	E32
	Clamping screw for LX grooving insert Tightening torque			FS1217 (Torx 20) 2,0 Nm
	Screw for grooving module Tightening torque	FS1053 (Torx 15) 2,0 Nm	FS1054 (Torx 20) 3,0 Nm	FS1055 (Torx 25) 3,0 Nm
	Handle key, small	FS1047 (Torx T15)	FS1048 (Torx 20)	FS1049 (Torx 25)

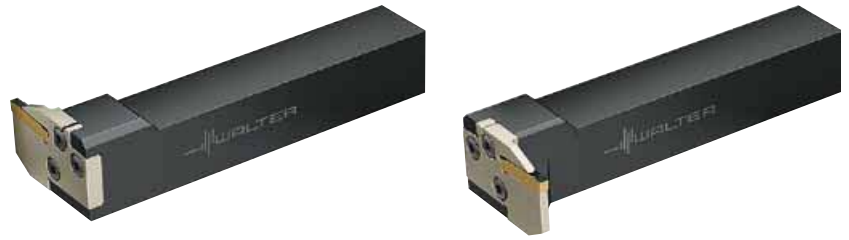

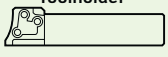
f mm	l ₁ mm	l ₂₁ mm	Module size	Type	Grooving module	Toolholder
						
33		109,8	E20	GX16-1E...	MSS-E20R/L12-GX16-1	MSS-E20R/L90-2020J
38		139,8	E25		MSS-E25R/L12-GX16-1	MSS-E25R/L90-2525L
33		109,4	E20	GX16-2E...	MSS-E20R/L12-GX16-2	MSS-E20R/L90-2020J
38		139,4	E25		MSS-E25R/L12-GX16-2	MSS-E25R/L90-2525L
45		159,4	E32		MSS-E32R/L12-GX16-2	MSS-E32R/L90-3225N
33		108,9	E20	GX16-3E...	MSS-E20R/L12-GX16-3	MSS-E20R/L90-2020J
38		138,9	E25		MSS-E25R/L12-GX16-3	MSS-E25R/L90-2525L
45		158,9	E32		MSS-E32R/L12-GX16-3	MSS-E32R/L90-3225N
38		138,3	E25	GX16-4E...	MSS-E25R/L12-GX16-4	MSS-E25R/L90-2525L
45		158,3	E32		MSS-E32R/L12-GX16-4	MSS-E32R/L90-3225N
42		109,4	E20	GX24-2E...	MSS-E20R/L21-GX24-2	MSS-E20R/L90-2020J
47		139,4	E25		MSS-E25R/L21-GX24-2	MSS-E25R/L90-2525L
47		138,9	E25	GX24-3E...	MSS-E25R/L21-GX24-3	MSS-E25R/L90-2525L
54		158,9	E32		MSS-E32R/L21-GX24-3	MSS-E32R/L90-3225N
47		138,3	E25	GX24-4E...	MSS-E25R/L21-GX24-4	MSS-E25R/L90-2525L
54		158,3	E32		MSS-E32R/L21-GX24-4	MSS-E32R/L90-3225N
47		137,5	E25	GX24-5E...	MSS-E25R/L21-GX24-5	MSS-E25R/L90-2525L
66		157,9	E32	LX - ...	MSS-E32N32-LX	MSS-E32R/L90-3225N
79		157,9	E32		MSS-E32N45-LX	MSS-E32R/L90-3225N

Accessories

Module size

E32



Handle key, small

FS1048 (Torx 20)



A 58



G 2



A 313



A 304

Walter Cut shank tool NCCE

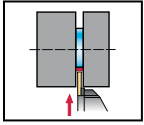

- external machining
- radial grooving 0°
- for circlip grooves
- for GX inserts

Tool		Designation	s mm	T _{max} mm	h=h ₁ mm	b mm
		NCCE12-1212R/L-GX09-1	0,6 - 1,7	2	12	12
		NCCE16-1616R/L-GX09-1		2	16	16
		NCCE20-2020R/L-GX16-2	0,6 - 2,3	3	20	20
		NCCE25-2525R/L-GX16-2		3	25	25
		NCCE32-3225R/L-GX16-2		3	32	25

$$f = f_1 + s/2$$

Bodies and assembly parts are included in the scope of delivery.

Ordering example:

Right-handed shank tool NCCE20-2020R-GX16-2 (right-handed module and right-handed toolholder)

Left-handed shank tool NCCE20-2020L-GX16-2 (left-handed module and left-handed toolholder)

Assembly parts		Module size	E12	E16	E20	E25	E32
	Screw for grooving module Tightening torque		FS1051 (Torx 8) 2,0 Nm	FS1052 (Torx 15) 2,0 Nm	FS1053 (Torx 15) 2,0 Nm	FS1054 (Torx 20) 3,0 Nm	FS1055 (Torx 25) 3,0 Nm
	Handle key, small		FS257 (Torx 8)	FS1047 (Torx T15)	FS1047 (Torx T15)	FS1048 (Torx 20)	FS1049 (Torx 25)

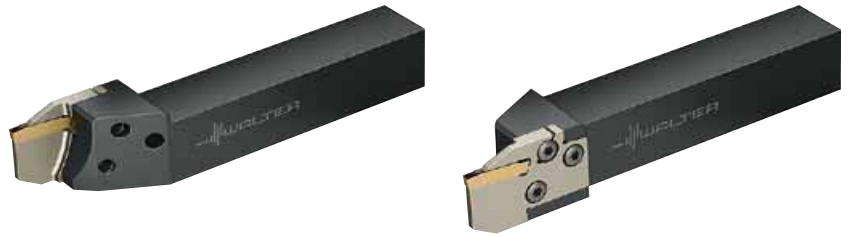

						Grooving module	Toolholder
f_1 mm	l_1 mm	Module size	Type				
14,9	78	E12	GX 09-1 ...		MSS-E12R/L02-GX09-1	MSS-E12R/L00-1212E	
18,9	98	E16			MSS-E16R/L02-GX09-1	MSS-E16R/L00-1616G	
23,6	123	E20	GX 16-2 ...		MSS-E20R/L03-GX16-2	MSS-E20R/L00-2020J	
30,4	153	E25			MSS-E25R/L03-GX16-2	MSS-E25R/L00-2525L	
30,4	173	E32			MSS-E32R/L03-GX16-2	MSS-E32R/L00-3225N	

Walter Cut shank tool

NCNE

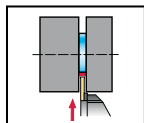

- external machining
- radial grooving 90°
- for circlip grooves
- for GX inserts

Tool

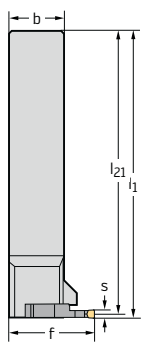
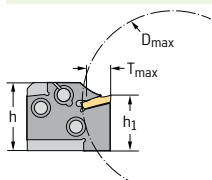

Designation	s mm	T _{max} mm	h=h ₁ mm	b mm
NCNE20-2020R/L-GX16-2	0,6 - 2,3	3	20	20
NCNE25-2525R/L-GX16-2		3	25	25
NCNE32-3225R/L-GX16-2		3	32	25

$$l_1 = l_{21} + s/2$$



Bodies and assembly parts are included in the scope of delivery.

Ordering example:

Right-handed shank tool: NCNE32-3225R-GX16-2 (left-handed module and right-handed toolholder)

Left-handed shank tool: NCNE32-3225L-GX16-2 (right-handed module and left-handed toolholder)

Assembly parts

Module size	E20	E25	E32
 Screw for grooving module Tightening torque	FS1053 (Torx 15) 2,0 Nm	FS1054 (Torx 20) 3,0 Nm	FS1055 (Torx 25) 3,0 Nm
 Handle key, small	FS1047 (Torx T15)	FS1048 (Torx 20)	FS1049 (Torx 25)

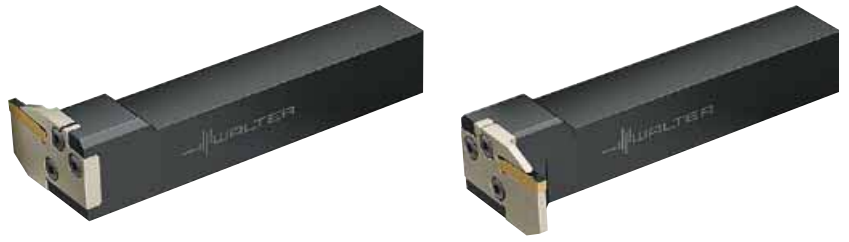

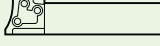
	f mm	l ₂₁ mm	Module size	Type	Grooving module 	Toolholder 
	33	109,4	E20	GX 16-2 ...	MSS-E20R/L03-GX16-2	MSS-E20R/L90-2020J
	38	139,4	E25		MSS-E25R/L03-GX16-2	MSS-E25R/L90-2525L
	45	159,4	E32		MSS-E32R/L03-GX16-2	MSS-E32R/L90-3225N

Walter Cut shank tool NCDE

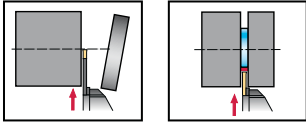

- external machining
- radial grooving 0°
- for grooving and parting off
- for FX inserts

Tool		Designation	s mm	T _{max} mm	D _{max} mm	h=h ₁ mm
		NCDE20-2020R/L-FX22-20	2,2	20	63	20
		NCDE25-2525R/L-FX22-20		20	79	25
		NCDE20-2020R/L-FX31-20	3,1	20	63	20
		NCDE25-2525R/L-FX31-25		25	79	25
		NCDE25-2525R/L-FX31-35		35	79	25
		NCDE32-3225R/L-FX31-32		32	100	32
		NCDE32-3225R/L-FX31-45	45	100	32	
		NCDE20-2020R/L-FX41-20	4,1	20	63	20
		NCDE25-2525R/L-FX41-25		25	79	25
		NCDE25-2525R/L-FX41-35		35	79	25
		NCDE32-3225R/L-FX41-32		32	100	32
		NCDE32-3225R/L-FX41-45	45	100	32	
		NCDE25-2525R/L-FX51-25	5,1	25	79	25
		NCDE25-2525R/L-FX51-35		35	79	25
		NCDE32-3225R/L-FX51-32		32	100	32
		NCDE32-3225R/L-FX51-45		45	100	32
		NCDE25-2525R/L-FX65-25	6,5	25	79	25
		NCDE25-2525R/L-FX65-35		35	79	25
		NCDE32-3225R/L-FX65-32		32	100	32
		NCDE32-3225R/L-FX65-45		45	100	32

For T_{max} with greater diameters than D, see technical information on page A 317.

Ordering example

Right-handed complete tool NCDE20-2020R-FX22-20 (right-handed module and right-handed toolholder)

Left-handed complete tool NCDE20-2020L-FX22-20 (left-handed module and left-handed toolholder)

Bodies and assembly parts are included in the scope of delivery.

Assembly parts		Module size	E20	E25	E32
	Screw for grooving module Tightening torque		FS1053 (Torx 15) 2,0 Nm	FS1054 (Torx 20) 3,0 Nm	FS1055 (Torx 25) 3,0 Nm
	Handle key, small		FS1047 (Torx T15)	FS1048 (Torx 20)	FS1049 (Torx 25)

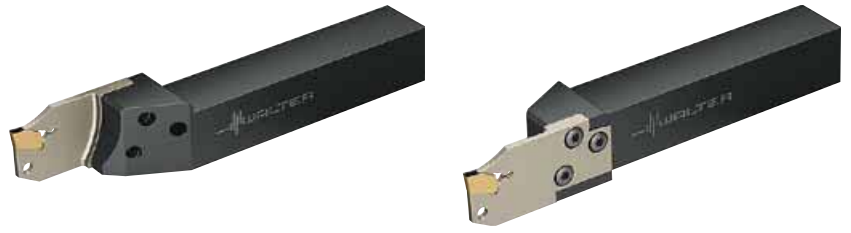

b mm	f mm	l ₁ mm	Module size	Type	Grooving module	Toolholder	
20	24,6	132	E20	FX 2.2 ...	MSS-E20R/L20-FX2.2	MSS-E20R/L00-2020J	
25	31,4	162	E25		MSS-E25R/L20-FX2.2	MSS-E25R/L00-2525L	
20	24,6	132	E20	FX 3.1 ...	MSS-E20R/L20-FX3.1	MSS-E20R/L00-2020J	
25	31,4	167	E25		MSS-E25R/L25-FX3.1	MSS-E25R/L00-2525L	
25	31,4	177	E25		MSS-E25R/L35-FX3.1	MSS-E25R/L00-2525L	
25	31,4	194	E32		MSS-E32R/L32-FX3.1	MSS-E32R/L00-3225N	
25	31,4	207	E32		MSS-E32R/L45-FX3.1	MSS-E32R/L00-3225N	
20	24,6	132	E20		FX 4.1 ...	MSS-E20R/L20-FX4.1	MSS-E20R/L00-2020J
25	31,4	167	E25			MSS-E25R/L25-FX4.1	MSS-E25R/L00-2525L
25	31,4	177	E25	MSS-E25R/L35-FX4.1		MSS-E25R/L00-2525L	
25	31,4	194	E32	MSS-E32R/L32-FX4.1		MSS-E32R/L00-3225N	
25	31,4	207	E32	MSS-E32R/L45-FX4.1		MSS-E32R/L00-3225N	
25	31,4	167	E25	FX 5.1 ...		MSS-E25R/L25-FX5.1	MSS-E25R/L00-2525L
25	31,4	177	E25		MSS-E25R/L35-FX5.1	MSS-E25R/L00-2525L	
25	31,4	194	E32		MSS-E32R/L32-FX5.1	MSS-E32R/L00-3225N	
25	31,4	207	E32		MSS-E32R/L45-FX5.1	MSS-E32R/L00-3225N	
25	31,4	167	E25	FX 6.5 ...	MSS-E25R/L25-FX6.5	MSS-E25R/L00-2525L	
25	31,4	177	E25		MSS-E25R/L35-FX6.5	MSS-E25R/L00-2525L	
25	31,4	194	E32		MSS-E32R/L32-FX6.5	MSS-E32R/L00-3225N	
25	31,4	207	E32		MSS-E32R/L45-FX6.5	MSS-E32R/L00-3225N	

Accessories

	Type	FX2.2...	FX3.1...-FX6.5...
	Mounting wrench for FX grooving insert	FS1494	FS1493



Walter Cut shank tool NCME

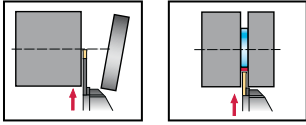

- external machining
- radial grooving 90°
- for grooving and parting off
- for FX inserts

Tool

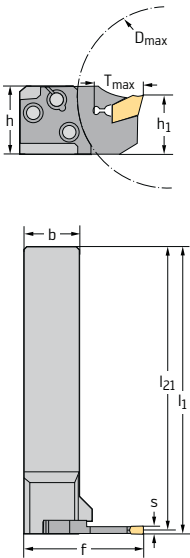

Designation

Designation	s mm	T _{max} mm	D _{max} mm	h=h ₁ mm	b mm
NCME20-2020R/L-FX22-20	2,2	20	63	20	20
NCME25-2525R/L-FX22-20		20	79	25	25
NCME20-2020R/L-FX31-20	3,1	20	63	20	20
NCME25-2525R/L-FX31-25		25	79	25	25
NCME25-2525R/L-FX31-35		35	79	25	25
NCME32-3225R/L-FX31-32		32	100	32	25
NCME32-3225R/L-FX31-45	4,1	45	100	32	25
NCME20-2020R/L-FX41-20		20	63	20	20
NCME25-2525R/L-FX41-25		25	79	25	25
NCME25-2525R/L-FX41-35		35	79	25	25
NCME32-3225R/L-FX41-32		32	100	32	25
NCME32-3225R/L-FX41-45		45	100	32	25
NCME25-2525R/L-FX51-25	5,1	25	79	25	25
NCME25-2525R/L-FX51-35		35	79	25	25
NCME32-3225R/L-FX51-45		45	100	25	25
NCME32-3225R/L-FX51-32		32	100	32	25
NCME25-2525R/L-FX65-25	6,5	25	79	25	25
NCME25-2525R/L-FX65-35		35	79	25	25
NCME32-3225R/L-FX65-32		32	100	32	25
NCME32-3225R/L-FX65-45		45	100	32	25

For T_{max} with greater diameters than D, see technical information on page A 317.

Ordering example

Right-handed complete tool NCME20-2020R-FX22-20 (left-handed module and right-handed toolholder)

Left-handed complete tool NCME20-2020L-FX22-20 (right-handed module and left-handed toolholder)

Bodies and assembly parts are included in the scope of delivery.

Assembly parts

	Module size	E20	E25	E32
	Screw for grooving module Tightening torque	FS1053 (Torx 15) 2,0 Nm	FS1054 (Torx 20) 3,0 Nm	FS1055 (Torx 25) 3,0 Nm
	Handle key, small	FS1047 (Torx T15)	FS1048 (Torx 20)	FS1049 (Torx 25)

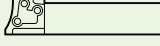

f mm	l ₁ mm	l ₂₁ mm	Module size	Type	Grooving module	Toolholder
						
42	110,7	109,6	E20	+FX 2.2	MSS-E20R/L20-FX2.2	MSS-E20R/L90-2020J
47	141,2	139,6	E25	...	MSS-E25R/L20-FX2.2	MSS-E25R/L90-2525L
46,6	110,8	109,2	E20	FX 3.1 ...	MSS-E20R/L20-FX3.1	MSS-E20R/L90-2020J
51,6	141,3	139,2	E25		MSS-E25R/L25-FX3.1	MSS-E25R/L90-2525L
51,6	141,3	139,2	E25		MSS-E25R/L35-FX3.1	MSS-E25R/L90-2525L
58,6	161,3	159,2	E32		MSS-E32R/L32-FX3.1	MSS-E32R/L90-3225N
58,6	161,3	159,2	E32		MSS-E32R/L45-FX3.1	MSS-E32R/L90-3225N
46,6	110,9	108,8	E20		FX 4.1 ...	MSS-E20R/L20-FX4.1
51,6	141,4	138,8	E25	MSS-E25R/L25-FX4.1		MSS-E25R/L90-2525L
51,6	141,4	138,8	E25	MSS-E25R/L35-FX4.1		MSS-E25R/L90-2525L
58,6	161,4	158,8	E32	MSS-E32R/L45-FX3.1		MSS-E32R/L90-3225N
58,6	161,4	158,8	E32	MSS-E32R/L45-FX4.1		MSS-E32R/L90-3225N
51,6	141,5	138,4	E25	FX 5.1 ...		MSS-E25R/L25-FX5.1
51,6	141,5	138,4	E25		MSS-E25R/L35-FX5.1	MSS-E25R/L90-2525L
58,6	161,5	158,4	E32		MSS-E32R/L45-FX5.1	MSS-E32R/L90-3225N
58,6	161,5	158,4	E32		MSS-E32R/L32-FX5.1	MSS-E32R/L90-3225N
51,6	141,6	137,8	E25	FX 6.5 ...	MSS-E25R/L25-FX6.5	MSS-E25R/L90-2525L
51,6	141,6	137,8	E25		MSS-E25R/L35-FX6.5	MSS-E25R/L90-2525L
58,6	161,6	157,8	E32		MSS-E32R/L32-FX6.5	MSS-E32R/L90-3225N
58,6	161,6	157,8	E32		MSS-E32R/L45-FX6.5	MSS-E32R/L90-3225N

Accessories

	Type	FX2.2...	FX3.1...-FX6.5...
	Mounting wrench for FX grooving insert	FS1494	FS1493



Walter Cut G1111

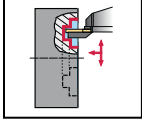
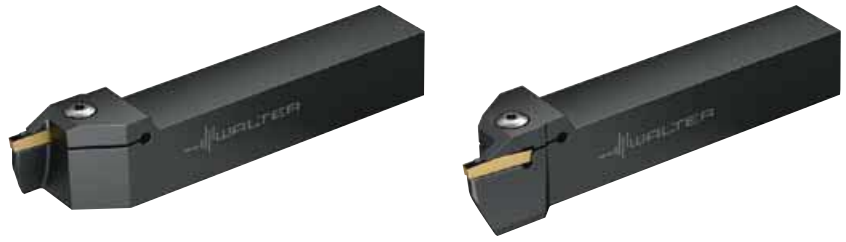

- external machining
- one-piece shank tool
- for axial grooving
- for GX inserts

Tool

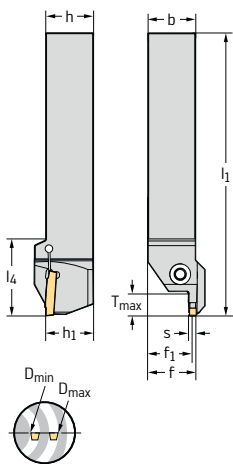

Designation	s mm	T _{max} mm	D _{min} mm	D _{max} mm	h=h ₁ mm	b mm	f mm	l ₁ mm	l ₄ mm	Type
G1111.2525R/L-3T12-034GX24	3	12	34	44	25	25	26,2	150	40	GX24-2E3..
G1111.2525R/L-3T12-042GX24		12	42	60	25	25	26,2	150	40	
G1111.2525R/L-3T12-054GX24		12	54	75	25	25	26,1	150	40	
G1111.2525R/L-3T19-054GX24		19	54	75	25	25	26,2	152	42	
G1111.2525R/L-3T22-067GX24		22	67	100	25	25	26,2	154	44	
G1111.2525R/L-3T12-067GX24		12	67	100	25	25	26,1	150	40	
G1111.2525R/L-3T12-090GX24		12	90	160	25	25	26,1	150	40	
G1111.2525R/L-3T22-090GX24		22	90	160	25	25	26,1	154	44	
G1111.2525R/L-3T12-130GX24		12	130	300	25	25	26,1	150	40	
G1111.2525R/L-3T22-130GX24		22	130	300	25	25	26,1	154	44	
G1111.2525R/L-4T12-040GX24	4	12	40	60	25	25	26,1	150	40	GX24-3E4/F4..
G1111.2525R/L-4T20-040GX24		20	40	60	25	25	26,3	152	42	
G1111.2525R/L-4T12-052GX24		12	52	72	25	25	26,1	150	40	
G1111.2525R/L-4T20-052GX24		20	52	72	25	25	26,2	152	42	
G1111.2525R/L-4T12-064GX24		12	64	100	25	25	26,1	150	40	
G1111.2525R/L-4T25-064GX24		25	64	100	25	25	26,1	156	46	
G1111.2525R/L-4T12-092GX24		12	92	140	25	25	26,1	150	40	
G1111.2525R/L-4T25-092GX24		25	92	140	25	25	26,1	156	46	
G1111.2525R/L-4T25-132GX24		25	132	230	25	25	26,1	156	46	
G1111.2525R/L-4T12-132GX24		12	132	230	25	25	26,1	150	40	
G1111.2525R/L-4T12-220GX24	12	220	500	25	25	26,1	150	40	GX24-3E5/F5..	
G1111.2525R/L-4T25-220GX24	25	220	500	25	25	26,1	156	46		
G1111.2525R/L-5T20-040GX24	5	20	40	70	25	25	26,3	152		42
G1111.2525R/L-5T12-040GX24		12	40	70	25	25	26,2	150		40
G1111.2525R/L-5T20-060GX24		20	60	95	25	25	26,3	152		42
G1111.2525R/L-5T12-060GX24		12	60	95	25	25	26,2	150		40
G1111.2525R/L-5T12-085GX24		12	85	130	25	25	26,2	150		40
G1111.2525R/L-5T25-085GX24		25	85	130	25	25	26,2	156		46
G1111.2525R/L-5T25-120GX24		25	120	180	25	25	26,2	156		46
G1111.2525R/L-5T12-120GX24		12	120	180	25	25	26,2	150		40
G1111.2525R/L-5T12-175GX24		12	175	500	25	25	26,1	150	40	
G1111.2525R/L-5T25-175GX24		25	175	500	25	25	26,2	156	46	

Max. double-edged insert cutting depth 23 mm

Ordering example:

Right shank tool: G1111.2525R-5T12-085GX24

Left shank tool: G1111.2525L-5T12-085GX24

Walter Cut G1111

Continued

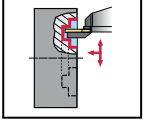
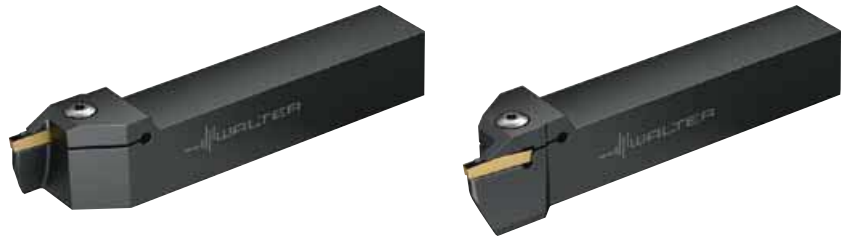

- external machining
- one-piece shank tool
- for axial grooving
- for GX inserts

Tool

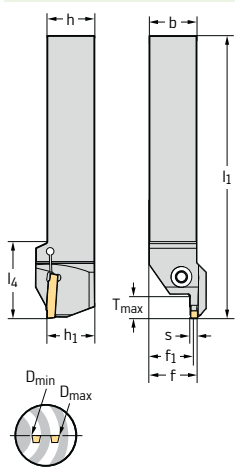

Designation	s mm	T _{max} mm	D _{min} mm	D _{max} mm	h=h ₁ mm	b mm	f mm	l ₁ mm	l ₄ mm	Type
G1111.2525R/L-6T12-040GX24	6	12	40	70	25	25	26,2	150	40	GX24-4E6/F6 . .
G1111.2525R/L-6T20-040GX24		25	40	70	25	25	26,3	152	42	
G1111.2525R/L-6T12-058GX24		12	58	100	25	25	26,2	150	40	
G1111.2525R/L-6T25-058GX24		25	58	100	25	25	26,2	156	46	
G1111.2525R/L-6T12-088GX24		12	88	180	25	25	26,2	150	40	
G1111.2525R/L-6T25-088GX24		25	88	180	25	25	26,2	156	46	
G1111.2525R/L-6T12-168GX24		12	168	400	25	25	26,2	150	40	
G1111.2525R/L-6T25-168GX24		25	168	400	25	25	26,2	156	46	

max. double-edged insert cutting depth 23 mm

Ordering example:

$$f = f_1 + s/2$$

Right shank tool: G1111.2525R-5T12-085GX24

Left shank tool: G1111.2525L-5T12-085GX24

Assembly parts

	Type	GX24-2E3 . .-GX24-4E6/F6 . .
	Clamping screw for grooving insert Tightening torque	FS2118 (Torx 20IP) 4,0 Nm
	Torx key	FS1464 (Torx 20IP)

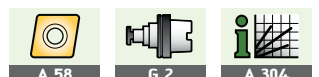

Walter Cut shank tool NCEE

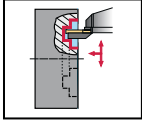

- external machining
- axial grooving 0°
- for axial grooving and face turning
- for GX inserts

Tool		Designation	s mm	T _{max} mm	D _{min} mm	D _{max} mm	h mm
		NCEE20-2020R/L-GX24-2-1	3,0 - 3,5	14	50	70	20
		NCEE20-2020R/L-GX24-2-2		14	70	100	20
		NCEE20-2020R/L-GX24-2-3		14	100	150	20
		NCEE25-2525R/L-GX24-2-3		15	100	150	25
		NCEE25-2525R/L-GX24-2-2		15	70	100	25
		NCEE25-2525R/L-GX24-2-1		15	50	70	25
		NCEE25-2525R/L-GX24-3-1	4,0 - 5,0	15	50	70	25
		NCEE25-2525R/L-GX24-3-2		15	70	100	25
		NCEE25-2525R/L-GX24-3-3		15	100	150	25
		NCEE25-2525R/L-GX24-3-4		15	150	300	25
		NCEE32-3225R/L-GX24-3-4		15	150	300	32
		NCEE32-3225R/L-GX24-3-3		15	100	150	32
		NCEE32-3225R/L-GX24-3-2	6	15	70	100	32
		NCEE25-2525R/L-GX24-4-4		15	150	300	25
		NCEE25-2525R/L-GX24-4-3		15	100	150	25
		NCEE25-2525R/L-GX24-4-2		15	70	100	25
		NCEE25-2525R/L-GX24-4-1		15	50	70	25
		NCEE32-3225R/L-GX24-4-2		15	70	100	32
		NCEE32-3225R/L-GX24-4-3		15	100	150	32
		NCEE32-3225R/L-GX24-4-4		15	150	300	32
NCEE32-3225R/L-GX24-4-5	15	300	900	32			

$$f = f_1 + s/2$$

Bodies and assembly parts are included in the scope of delivery.

Ordering example:

Right-handed tool NCEE20-2020R-GX24-2-1 (right-handed module and right-handed toolholder)

Left-handed tool NCEE20-2020L-GX24-2-1 (left-handed module and left-handed toolholder)

Assembly parts	Module size	E20	E25	E32
	Screw for grooving module Tightening torque	FS1053 (Torx 15) 2,0 Nm	FS1054 (Torx 20) 3,0 Nm	FS1055 (Torx 25) 3,0 Nm
	Handle key, small	FS1047 (Torx T15)	FS1048 (Torx 20)	FS1049 (Torx 25)

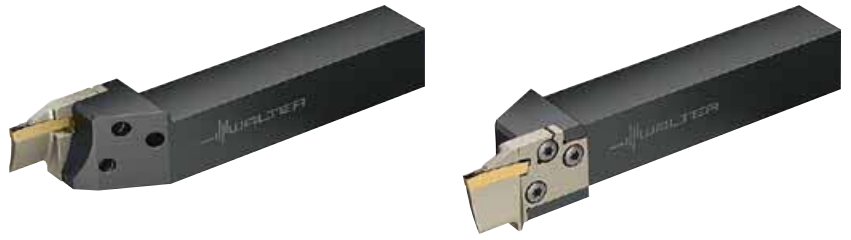

	b mm	f ₁ mm	l ₁ mm	Module size	Type	Grooving module	Toolholder
	20	23,6	132	E20	GX 24-2 ...	MSS-E20R/L14-GX24-2A5070	MSS-E20R/L00-2020J
	20	23,6	132	E20		MSS-E20R/L14-GX24-2A70100	MSS-E20R/L00-2020J
	20	23,6	132	E20		MSS-E20R/L14-GX24-2A100150	MSS-E20R/L00-2020J
	25	30,4	162	E25		MSS-E25R/L15-GX24-2A100150	MSS-E25R/L00-2525L
	25	30,4	162	E25		MSS-E25R/L15-GX24-2A70100	MSS-E25R/L00-2525L
	25	30,4	162	E25		MSS-E25R/L15-GX24-2A5070	MSS-E25R/L00-2525L
	25	29,9	162	E25		MSS-E25R/L15-GX24-3A5070	MSS-E25R/L00-2525L
	25	29,9	162	E25	GX 24-3 ...	MSS-E25R/L15-GX24-3A70100	MSS-E25R/L00-2525L
	25	29,9	162	E25		MSS-E25R/L15-GX24-3A100150	MSS-E25R/L00-2525L
	25	29,9	162	E25		MSS-E25R/L15-GX24-3A150300	MSS-E25R/L00-2525L
	25	29,9	182	E32		MSS-E32R/L15-GX24-3A150300	MSS-E32R/L00-3225N
	25	29,9	182	E32		MSS-E32R/L15-GX24-3A100150	MSS-E32R/L00-3225N
	25	29,9	182	E32		MSS-E32R/L15-GX24-3A70100	MSS-E32R/L00-3225N
	25	29,9	182	E32		MSS-E32R/L15-GX24-3A5070	MSS-E32R/L00-3225N
	25	29,3	162	E25	GX 24-4 ...	MSS-E25R/L15-GX24-4A150300	MSS-E25R/L00-2525L
	25	29,3	162	E25		MSS-E25R/L15-GX24-4A100150	MSS-E25R/L00-2525L
	25	29,3	162	E25		MSS-E25R/L15-GX24-4A70100	MSS-E25R/L00-2525L
	25	29,3	162	E25		MSS-E25R/L15-GX24-4A5070	MSS-E25R/L00-2525L
	25	29,3	182	E32		MSS-E32R/L15-GX24-4A70100	MSS-E32R/L00-3225N
	25	29,3	182	E32		MSS-E32R/L15-GX24-4A100150	MSS-E32R/L00-3225N
	25	29,3	182	E32		MSS-E32R/L15-GX24-4A150300	MSS-E32R/L00-3225N
	25	29,3	182	E32		MSS-E32R/L15-GX24-4A300900	MSS-E32R/L00-3225N
	25	29,3	182	E32			
	25	29,3	182	E32			



Walter Cut shank tool NCHE

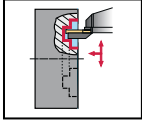

- external machining
- axial grooving 90°
- for axial grooving and face turning

Tool	Designation	s mm	T _{max} mm	D _{min} mm	D _{max} mm	h mm
	NCHE20-2020R/L-GX24-2-1	3,0 - 3,5	14	50	70	20
	NCHE20-2020R/L-GX24-2-2		14	70	100	20
	NCHE20-2020R/L-GX24-2-3		14	100	150	20
	NCHE25-2525R/L-GX24-2-3		15	100	150	25
	NCHE25-2525R/L-GX24-2-2		15	70	100	25
	NCHE25-2525R/L-GX24-2-1		15	50	70	25
	NCHE25-2525R/L-GX24-3-1	4,0 - 5,0	15	50	70	25
	NCHE25-2525R/L-GX24-3-2		15	70	100	25
	NCHE25-2525R/L-GX24-3-3		15	100	150	25
	NCHE25-2525R/L-GX24-3-4		15	150	300	25
	NCHE32-3225R/L-GX24-3-4		15	150	300	32
	NCHE32-3225R/L-GX24-3-3		15	100	150	32
	NCHE32-3225R/L-GX24-3-2	6	15	70	100	32
	NCHE25-2525R/L-GX24-4-4		15	150	300	25
	NCHE25-2525R/L-GX24-4-3		15	100	150	25
	NCHE25-2525R/L-GX24-4-2		15	70	100	25
	NCHE25-2525R/L-GX24-4-1		15	50	70	25
	NCHE32-3225R/L-GX24-4-2		15	70	100	32
	NCHE32-3225R/L-GX24-4-3	6	15	100	150	32
	NCHE32-3225R/L-GX24-4-4		15	150	300	32
NCHE32-3225R/L-GX24-4-5	15		300	900	32	

Bodies and assembly parts are included in the scope of delivery.

$$l1 = l21 + s/2$$

Ordering example:

Right-handed tool NCHE20-2020R-GX24-2-1 (left-handed module and right-handed toolholder)

Left-handed tool NCHE20-2020L-GX24-2-1 (right-handed module and left-handed toolholder)

Assembly parts

	Module size	E20	E25	E32
	Screw for grooving module Tightening torque	FS1053 (Torx 15) 2,0 Nm	FS1054 (Torx 20) 3,0 Nm	FS1055 (Torx 25) 3,0 Nm
	Handle key, small	FS1047 (Torx T15)	FS1048 (Torx 20)	FS1049 (Torx 25)

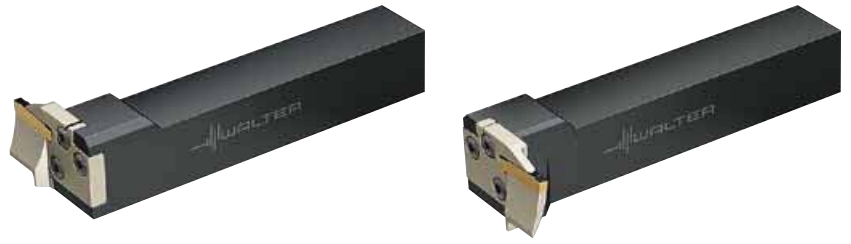

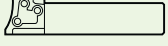
	b mm	f mm	l ₂₁ mm	Module size	Type	Grooving module	Toolholder
							
	20	42	109,4	E20	GX 24-2 ...	MSS-E20R/L14-GX24-2A5070	MSS-E20R/L90-2020J
	20	42	109,4	E20		MSS-E20R/L14-GX24-2A70100	MSS-E20R/L90-2020J
	20	42	109,4	E20		MSS-E20R/L14-GX24-2A100150	MSS-E20R/L90-2020J
	25	47	139,4	E25		MSS-E25R/L15-GX24-2A100150	MSS-E25R/L90-2525L
	25	47	139,4	E25		MSS-E25R/L15-GX24-2A70100	MSS-E25R/L90-2525L
	25	47	139,4	E25		MSS-E25R/L15-GX24-2A5070	MSS-E25R/L90-2525L
	25	47	138,9	E25		MSS-E25R/L15-GX24-3A5070	MSS-E25R/L90-2525L
	25	47	138,9	E25	GX 24-3 ...	MSS-E25R/L15-GX24-3A70100	MSS-E25R/L90-2525L
	25	47	138,9	E25		MSS-E25R/L15-GX24-3A100150	MSS-E25R/L90-2525L
	25	47	138,9	E25		MSS-E25R/L15-GX24-3A150300	MSS-E25R/L90-2525L
	25	54	158,9	E32		MSS-E32R/L15-GX24-3A150300	MSS-E32R/L90-3225N
	25	54	158,9	E32		MSS-E32R/L15-GX24-3A100150	MSS-E32R/L90-3225N
	25	54	158,9	E32		MSS-E32R/L15-GX24-3A70100	MSS-E32R/L90-3225N
	25	47	138,3	E25		GX 24-4 ...	MSS-E25R/L15-GX24-4A150300
	25	47	138,3	E25	MSS-E25R/L15-GX24-4A100150		MSS-E25R/L90-2525L
	25	47	138,3	E25	MSS-E25R/L15-GX24-4A70100		MSS-E25R/L90-2525L
	25	47	138,3	E25	MSS-E25R/L15-GX24-4A5070		MSS-E25R/L90-2525L
	25	54	158,3	E32	MSS-E32R/L15-GX24-4A70100		MSS-E32R/L90-3225N
	25	54	158,3	E32	MSS-E32R/L15-GX24-4A100150		MSS-E32R/L90-3225N
	25	54	158,3	E32	MSS-E32R/L15-GX24-4A150300		MSS-E32R/L90-3225N
	25	54	158,3	E32	MSS-E32R/L15-GX24-4A300900		MSS-E32R/L90-3225N



Walter Cut shank tool NCFE

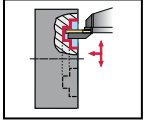

- external machining
- axial grooving 0°
- for deep axial grooving and face turning
- for GX inserts

Tool

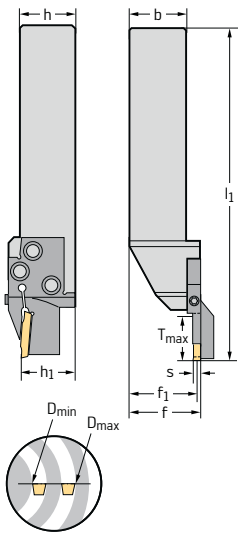

Designation

Designation	s mm	T _{max} mm	D _{min} mm	D _{max} mm	h mm
NCFE25-2525R/L-GX24-3-1	4,0 - 5,0	21	50	70	25
NCFE25-2525R/L-GX24-3-2		21	70	100	25
NCFE25-2525R/L-GX24-3-3		21	100	150	25
NCFE25-2525R/L-GX24-3-4		21	150	300	25
NCFE25-2525R/L-GX24-4-1	6	21	50	70	25
NCFE25-2525R/L-GX24-4-2		21	70	100	25
NCFE25-2525R/L-GX24-4-3		21	100	150	25
NCFE25-2525R/L-GX24-4-4		21	150	300	25

$$f = f_1 + s/2$$

Bodies and assembly parts are included in the scope of delivery.

Ordering example:

Right-handed tool NCFE25-2525R-GX24-3-1 (right-handed module and right-handed toolholder)

Left-handed tool NCFE25-2525L-GX24-3-1 (left-handed module and left-handed toolholder)

For description of contra version/standard version, see page A 214.

Assembly parts

	Module size	E25
	Clamping screw for grooving insert	FS1342 (Torx 15)
	Tightening torque	1,0 Nm
	Screw for grooving module	FS1054 (Torx 20)
	Tightening torque	3,0 Nm
	Key for grooving module	FS1048 (Torx 20)
	Handle key, small	FS1047 (Torx T15)

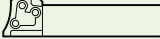

	b mm	f ₁ mm	l ₁ mm	Module size	Type	Grooving module 	Toolholder 
	25	29,9	175	E25	GX 24-3 ...	MSS-E25R/L21-GX24-3C5070	MSS-E25R/L00-2525L
	25	29,9	175	E25		MSS-E25R/L21-GX24-3C70100	MSS-E25R/L00-2525L
	25	29,9	175	E25		MSS-E25R/L21-GX24-3C100150	MSS-E25R/L00-2525L
	25	29,9	175	E25		MSS-E25R/L21-GX24-3C150300	MSS-E25R/L00-2525L
	25	29,3	175	E25	GX 24-4 ...	MSS-E25R/L25-GX24-4C5070	MSS-E25R/L00-2525L
	25	29,3	175	E25		MSS-E25R/L25-GX24-4C70100	MSS-E25R/L00-2525L
	25	29,3	175	E25		MSS-E25R/L25-GX24-4C100150	MSS-E25R/L00-2525L
	25	29,3	175	E25		MSS-E25R/L25-GX24-4C150300	MSS-E25R/L00-2525L

Walter Cut shank tool NCFE-C Contra version

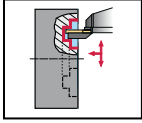

- external machining
- axial grooving 0°
- for deep axial grooving and face turning
- Contra version
- for GX inserts

Tool

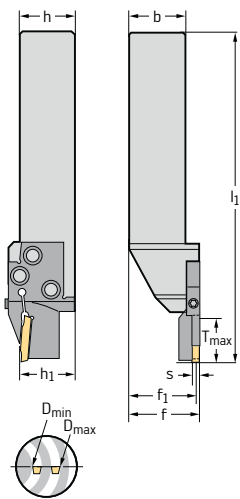

Designation

NCFE25-2525R/L-GX24-3-1C
 NCFE25-2525R/L-GX24-3-2C
 NCFE25-2525R/L-GX24-3-3C
 NCFE25-2525R/L-GX24-3-4C
 NCFE25-2525R/L-GX24-4-1C
 NCFE25-2525R/L-GX24-4-2C
 NCFE25-2525R/L-GX24-4-3C
 NCFE25-2525R/L-GX24-4-4C

s
mm

T_{max}
mm

D_{min}
mm

D_{max}
mm

h
mm

4,0 - 5,0

21

50

70

25

21

70

100

25

21

100

150

25

21

150

300

25

21

50

70

25

21

70

100

25

21

100

150

25

21

150

300

25

$$f = f_1 + s/2$$

Bodies and assembly parts are included in the scope of delivery.

Ordering example:

Right-handed tool NCFE25-2525R-GX24-3-1C (left-handed module and right-handed toolholder)

Left-handed tool NCFE25-2525L-GX24-3-1C (right-handed module and left-handed toolholder)

For description of contra version/standard version, see page A 215.

Assembly parts

Module size

E25



Clamping screw for grooving insert
Tightening torque

FS1342 (Torx 15)
1,0 Nm

Screw for grooving module
Tightening torque

FS1054 (Torx 20)
3,0 Nm



Key for grooving module

FS1048 (Torx 20)

Handle key, small

FS1047 (Torx T15)



					Grooving module		Toolholder
b mm	f ₁ mm	l ₁ mm	Module size	Type			
25	29,9	175	E25	GX 24-3 ...	MSS-E25R/L21-GX24-3C5070	MSS-E25R/L00-2525L	
25	29,9	175	E25		MSS-E25R/L21-GX24-3C70100	MSS-E25R/L00-2525L	
25	29,9	175	E25		MSS-E25R/L21-GX24-3C100150	MSS-E25R/L00-2525L	
25	29,9	175	E25		MSS-E25R/L21-GX24-3C150300	MSS-E25R/L00-2525L	
25	29,3	175	E25	GX 24-4 ...	MSS-E25R/L25-GX24-4C5070	MSS-E25R/L00-2525L	
25	29,3	175	E25		MSS-E25R/L25-GX24-4C70100	MSS-E25R/L00-2525L	
25	29,3	175	E25		MSS-E25R/L25-GX24-4C100150	MSS-E25R/L00-2525L	
25	29,3	175	E25		MSS-E25R/L25-GX24-4C150300	MSS-E25R/L00-2525L	

Walter Cut shank tool NCOE

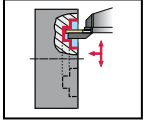

- external machining
- axial grooving 90°
- for deep axial grooving and face turning
- for GX inserts

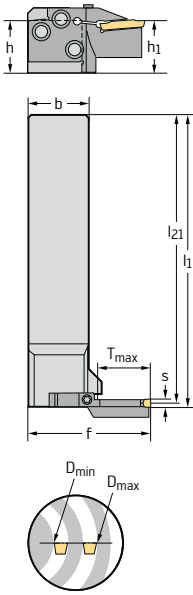

Tool





Designation	s mm	T _{max} mm	D _{min} mm	D _{max} mm	h mm
NCOE25-2525R/L-GX24-3-1	4,0 - 5,0	21	50	70	25
NCOE25-2525R/L-GX24-3-2		21	70	100	25
NCOE25-2525R/L-GX24-3-3		21	100	150	25
NCOE25-2525R/L-GX24-3-4	6	21	150	300	25
NCOE25-2525R/L-GX24-4-1		21	50	70	25
NCOE25-2525R/L-GX24-4-2		21	70	100	25
NCOE25-2525R/L-GX24-4-3		21	100	150	25
NCOE25-2525R/L-GX24-4-4		21	150	300	25

l1 = l21+s/2
 Bodies and assembly parts are included in the scope of delivery.
 Ordering example:
 Right-handed tool NCOE25-2525R-GX24-3-1 (left-handed module and right-handed toolholder)
 Left-handed tool NCOE25-2525L-GX24-3-1 (right-handed module and left-handed toolholder)
 For description of contra version/standard version, see page A 214.

Assembly parts

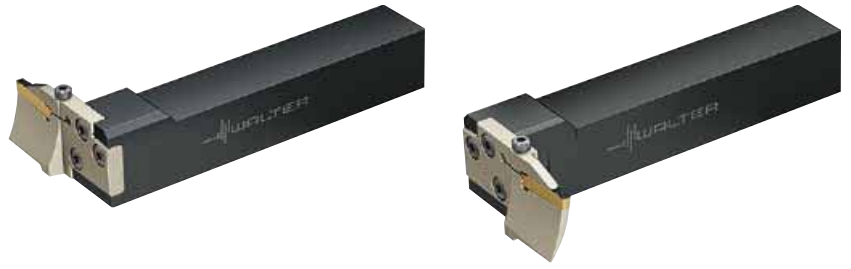
	Module size	E25
	Clamping screw for grooving insert Tightening torque	FS1342 (Torx 15) 1,0 Nm
	Screw for grooving module Tightening torque	FS1054 (Torx 20) 3,0 Nm
	Key for clamping screw	FS1047 (Torx 15)
	Handle key, small	FS1048 (Torx 20)

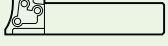

	b mm	f mm	l ₂₁ mm	Module size	Type	Grooving module	Toolholder
							
	25	47	138,9	E25	GX 24-3 ...	MSS-E25R/L21-GX24-3C5070	MSS-E25R/L90-2525L
	25	47	138,9	E25		MSS-E25R/L21-GX24-3C70100	MSS-E25R/L90-2525L
	25	47	138,9	E25		MSS-E25R/L21-GX24-3C100150	MSS-E25R/L90-2525L
	25	47	138,9	E25		MSS-E25R/L21-GX24-3C150300	MSS-E25R/L90-2525L
	25	47	138,3	E25		MSS-E25R/L25-GX24-4C5070	MSS-E25R/L90-2525L
	25	47	138,3	E25	GX 24-4 ...	MSS-E25R/L25-GX24-4C70100	MSS-E25R/L90-2525L
	25	47	138,3	E25		MSS-E25R/L25-GX24-4C100150	MSS-E25R/L90-2525L
	25	47	138,3	E25		MSS-E25R/L25-GX24-4C150300	MSS-E25R/L90-2525L
	25	47	138,3	E25		MSS-E25R/L25-GX24-4C150300	MSS-E25R/L90-2525L

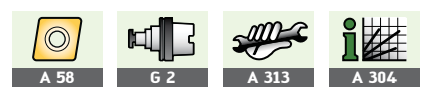

A 58

G 2

A 313

A 304

Walter Cut shank tool

NCOE-C

Contra version

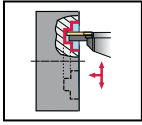

- external machining
- axial grooving 90°
- for deep axial grooving and face turning
- Contra version
- for GX inserts

Tool

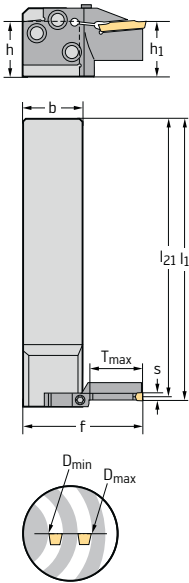

Designation	s mm	T _{max} mm	D _{min} mm	D _{max} mm	h mm
NCOE25-2525R/L-GX24-3-1C	4,0 - 5,0	21	50	70	25
NCOE25-2525R/L-GX24-3-2C		21	70	100	25
NCOE25-2525R/L-GX24-3-3C		21	100	150	25
NCOE25-2525R/L-GX24-3-4C		21	150	300	25
NCOE25-2525R/L-GX24-4-1C	6	21	50	70	25
NCOE25-2525R/L-GX24-4-2C		21	70	100	25
NCOE25-2525R/L-GX24-4-3C		21	100	150	25
NCOE25-2525R/L-GX24-4-4C		21	150	300	25

$$l1 = l21 + s/2$$

Bodies and assembly parts are included in the scope of delivery.



Ordering example:

Right-handed tool NCOE25-2525R-GX24-3-1C (right-handed module and right-handed toolholder)

Left-handed tool NCOE25-2525L-GX24-3-1C (left-handed module and left-handed toolholder)

For description of contra version/standard version, see page A 214.

Assembly parts

Module size	E25
 Clamping screw for grooving insert Tightening torque	FS1342 (Torx 15) 1,0 Nm
Screw for grooving module Tightening torque	FS1054 (Torx 20) 3,0 Nm
 Key for clamping screw	FS1047 (Torx 15)
Handle key, small	FS1048 (Torx 20)

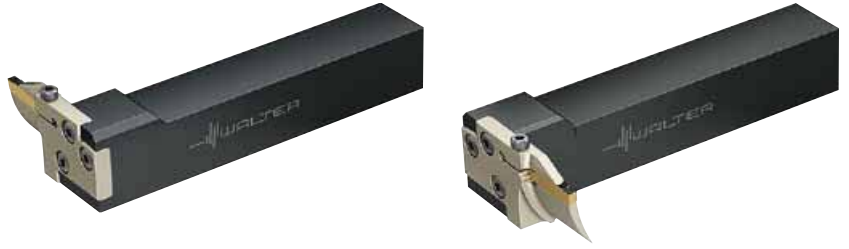

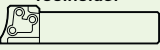
b mm	f ₁ mm	l ₁ mm	l ₂₁ mm	Module size	Type	Grooving module 	Toolholder 
25	47	141,9	138,9	E25	GX 24-3 ...	MSS-E25R/L21-GX24-3C5070	MSS-E25R/L90-2525L
25	47	141,9	138,9	E25		MSS-E25R/L21-GX24-3C70100	MSS-E25R/L90-2525L
25	47	141,9	138,9	E25		MSS-E25R/L21-GX24-3C100150	MSS-E25R/L90-2525L
25	47	141,9	138,9	E25		MSS-E25R/L21-GX24-3C150300	MSS-E25R/L90-2525L
25	47	141,8	138,3	E25		MSS-E25R/L25-GX24-4C5070	MSS-E25R/L90-2525L
25	47	141,8	138,3	E25	GX 24-4 ...	MSS-E25R/L25-GX24-4C70100	MSS-E25R/L90-2525L
25	47	141,8	138,3	E25		MSS-E25R/L25-GX24-4C100150	MSS-E25R/L90-2525L
25	47	141,8	138,3	E25		MSS-E25R/L25-GX24-4C150300	MSS-E25R/L90-2525L
25	47	141,8	138,3	E25			



Walter Cut I 12 R/L

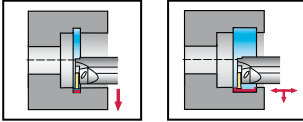

- internal machining
- radial grooving 90°
- one-piece shank tool
- for grooving and longitudinal turning
- for GX inserts

Tool	Designation	s mm	T _{max} mm	D _{min} mm	d ₁ mm	f mm	l ₄ mm	l ₂₁ mm	Type
	I12R/L90-2,5D-GX09	2,0 - 2,5	3	16	16	11	29,4	149,4	GX 09-1 ...

$l_1 = l_{21} + s/2$

Ordering example:

Right-handed shank tool: I 12 R 90-2.5D-GX09

Left-handed shank tool: I 12 R 90-2.5D-GX09

Bodies and assembly parts are included in the scope of delivery.

Assembly parts	Type	GX 09-1 ...
	Clamping screw for grooving insert Tightening torque	FS1052 (Torx 15) 2,0 Nm
	Pin	02,0M6X005 ISO 8734
	Handle key, small	FS1047 (Torx T15)



Walter Cut shank tool NCAI

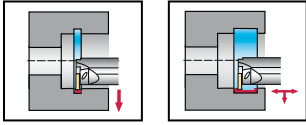

- internal machining
- radial grooving 90°
- for grooving and longitudinal turning
- for GX inserts

Tool	Designation	s mm	T _{max} mm	D _{min} mm	d ₁ mm	d ₄ mm	l ₄ mm
1,5 x D 	NCAI16-2015R/L-GX09-1	2,0 - 2,5	4	20	20	25	24
	NCAI20-2015R/L-GX09-1		5	25	20	25	30
	NCAI16-2015R/L-GX09-2	3	4	20	20	25	24
	NCAI20-2015R/L-GX09-2		5	25	20	25	30
	NCAI40-4015R/L-GX16-1	2,0 - 2,5	10	50	40	50	60
	NCAI32-3215R/L-GX16-1		9	40	32	40	48
	NCAI32-3215R/L-GX16-2	3	9	40	32	40	48
	NCAI40-4015R/L-GX16-2		10	50	40	50	60
	NCAI32-3215R/L-GX16-3	4,0 - 5,0	9	40	32	40	48
	NCAI40-4015R/L-GX16-3		10	50	40	50	60
	NCAI32-3215R/L-GX16-4	6	9	40	32	40	48
	NCAI40-4015R/L-GX16-4		10	50	40	50	60
	NCAI40-4015R/L-GX24-3	4,0 - 5,0	19	60	40	50	60
	NCAI40-4015R/L-GX24-4	6	19	60	40	50	60
2,5 x D 	NCAI16-2025R/L-GX09-1	2,0 - 2,5	4	20	20	25	40
	NCAI20-2525R/L-GX09-1		5	25	25	25	50
	NCAI25-2515R/L-GX09-1		6	32	25	32	38
	NCAI25-3225R/L-GX09-1		6	32	32	32	63
	NCAI25-3225R/L-GX09-2	3	6	32	32	32	63
	NCAI25-2515R/L-GX09-2		6	32	25	32	38
	NCAI20-2525R/L-GX09-2	2,0 - 2,5	4	20	20	25	40
	NCAI16-2025R/L-GX09-2		5	25	25	25	50
	NCAI32-4025R/L-GX16-1	3	9	40	40	40	80
	NCAI40-5025R/L-GX16-1		10	50	50	50	100
	NCAI32-4025R/L-GX16-2	4,0 - 5,0	9	40	40	40	80
	NCAI40-5025R/L-GX16-2		10	50	50	50	100
	NCAI32-4025R/L-GX16-3	6	9	40	40	40	80
	NCAI40-5025R/L-GX16-3		10	50	50	50	100
	NCAI32-4025R/L-GX16-4	4,0 - 5,0	9	40	40	40	80
	NCAI40-5025R/L-GX16-4		10	50	50	50	100
	NCAI40-5025R/L-GX24-3	6	19	60	50	50	100
	NCAI40-5025R/L-GX24-4	6	19	60	50	50	100

$$l1 = l21 + s/2$$

Bodies and assembly parts are included in the scope of delivery.

Ordering example:

Right-handed tool NCAI16-2015R-GX09-1 (right-handed module and right-handed toolholder)

Left-handed tool NCAI16-2015L-GX09-1 (left-handed module and left-handed toolholder)

Assembly parts		Module size	I16	I20	I25	I32	I40
	Handle key, small		FS257 (Torx 8)	FS1050 (Torx 10)	FS1047 (Torx T15)	FS1048 (Torx 20)	FS1048 (Torx 20)
	Screw for grooving module Tightening torque		FS1051 (Torx 8) 2,0 Nm	FS1056 (Torx 10) 2,0 Nm	FS1052 (Torx 15) 2,0 Nm	FS1057 (Torx 20) 3,0 Nm	FS1054 (Torx 20) 3,0 Nm

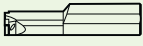

f mm	l ₅ mm	l ₂₁ mm	l ₁₆ mm	Module size	Type	Grooving module	Toolholder
							
11	50	31,4	23,4	l16	GX09-1E...	MSS-I16R/L04-GX09-1	MSS-I16R/L90-1,5D-N
13	50	37	29,4	l20		MSS-I20R/L05-GX09-1	MSS-I20R/L90-1,5D-N
11	50	31,4	23,4	l16	GX09-2E...	MSS-I16R/L04-GX09-2	MSS-I16R/L90-1,5D-N
13	50	37	29,4	l20		MSS-I20R/L05-GX09-2	MSS-I20R/L90-1,5D-N
27	70	71,4	59,4	l40	GX16-1E...	MSS-I40R/L10-GX16-1	MSS-I40R/L90-1,5D-N
22	60	58,4	47,4	l32		MSS-I32R/L09-GX16-1	MSS-I32R/L90-1,5D-N
22	60	58	47	l32	GX16-2E...	MSS-I32R/L09-GX16-2	MSS-I32R/L90-1,5D-N
27	70	71	59	l40		MSS-I40R/L10-GX16-2	MSS-I40R/L90-1,5D-N
22	60	60,5	49,5	l32	GX16-3E...	MSS-I32R/L09-GX16-3	MSS-I32R/L90-1,5D-N
27	70	80,5	68,5	l40		MSS-I40R/L10-GX16-3	MSS-I40R/L90-1,5D-N
22	60	56,9	45,9	l32	GX16-4E...	MSS-I32R/L09-GX16-4	MSS-I32R/L90-1,5D-N
27	70	69,9	57,9	l40		MSS-I40R/L10-GX16-4	MSS-I40R/L90-1,5D-N
36	70	70,8	58,8	l40	GX24-3E...	MSS-I40N19-GX24-3	MSS-I40R/L90-1,5D-N
36	70	70,2	58,2	l40	GX24-4E...	MSS-I40N19-GX24-4	MSS-I40R/L90-1,5D-N
14,5		179,4	39,4	l16	GX09-1E...	MSS-I16R/L04-GX09-1	MSS-I16R/L90-2,5D-N
18		199,4	49,4	l20		MSS-I20R/L05-GX09-1	MSS-I20R/L90-2,5D-N
17		45,4	37,4	l25		MSS-I25R/L06-GX09-1	MSS-I25R/L90-1,5D-N
22,5		249,4	62,4	l25		MSS-I25R/L06-GX09-1	MSS-I25R/L90-2,5D-N
22,5		249	62	l25	GX09-2E...	MSS-I25R/L06-GX09-2	MSS-I25R/L90-2,5D-N
17		45	37	l25		MSS-I25R/L06-GX09-2	MSS-I25R/L90-1,5D-N
18		199	49	l20		MSS-I20R/L05-GX09-2	MSS-I20R/L90-2,5D-N
14,5		179	39	l16		MSS-I16R/L04-GX09-2	MSS-I16R/L90-2,5D-N
29,5		299,4	79,4	l32	GX16-1E...	MSS-I32R/L09-GX16-1	MSS-I32R/L90-2,5D-N
35,5		349,4	99,4	l40		MSS-I40R/L10-GX16-1	MSS-I40R/L90-2,5D-N
29,5		299	79	l32	GX16-2E...	MSS-I32R/L09-GX16-2	MSS-I32R/L90-2,5D-N
35,5		349	99	l40		MSS-I40R/L10-GX16-2	MSS-I40R/L90-2,5D-N
29,5		301,5	81,5	l32	GX16-3E...	MSS-I32R/L09-GX16-3	MSS-I32R/L90-2,5D-N
35,5		348,5	98,5	l40		MSS-I40R/L10-GX16-3	MSS-I40R/L90-2,5D-N
29,5		303,4	83,4	l32	GX16-4E...	MSS-I32R/L09-GX16-4	MSS-I32R/L90-2,5D-N
35,5		347,9	97,9	l40		MSS-I40R/L10-GX16-4	MSS-I40R/L90-2,5D-N
44,5		348,8	98,8	l40	GX24-3E...	MSS-I40N19-GX24-3	MSS-I40R/L90-2,5D-N
44,5		348,2	98,2	l40	GX24-4E...	MSS-I40N19-GX24-4	MSS-I40R/L90-2,5D-N



Walter Cut shank tool NCCI

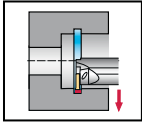

- internal machining
- for circlip grooves
- for GX inserts

Tool	Designation	s mm	T _{max} mm	D _{min} mm	d ₁ mm	d ₄ mm	l ₄ mm
1,5 x D 	NCCI16-2015R/L-GX09-1	0,6 - 1,7	2	20	20	25	24
	NCCI20-2015R/L-GX09-1		2	25	20	25	30
	NCCI25-2515R/L-GX09-1	0,6 - 2,3	2	32	25	32	38
	NCCI32-3215R/L-GX16-2		3	40	32	40	48
	NCCI40-4015R/L-GX16-2		3	50	40	50	60
2,5 x D 	NCCI16-2025R/L-GX09-1	0,6 - 1,7	2	20	20		40
	NCCI20-2525R/L-GX09-1		2	25	25		50
	NCCI25-3225R/L-GX09-1	0,6 - 2,3	2	32	32		63
	NCCI32-4025R/L-GX16-2		3	40	40		80
	NCCI40-5025R/L-GX16-2		3	50	50		100

$$l_1 = l_{21} + s/2$$

Bodies and assembly parts are included in the scope of delivery.

Ordering example:

Right-handed tool NCCI16-2015R-GX09-1 (right-handed module and right-handed toolholder)

Left-handed tool NCCI16-2015L-GX09-1 (left-handed module and left-handed toolholder)

Assembly parts	Module size	I16	I20	I25	I32	I40
	Screw for grooving module Tightening torque	FS1051 (Torx 8) 2,0 Nm	FS1056 (Torx 10) 2,0 Nm	FS1052 (Torx 15) 2,0 Nm	FS1057 (Torx 20) 3,0 Nm	FS1054 (Torx 20) 3,0 Nm
	Handle key, small	FS257 (Torx 8)	FS1050 (Torx 10)	FS1047 (Torx T15)	FS1048 (Torx 20)	FS1048 (Torx 20)



								Grooving module	Toolholder
f mm	l ₅ mm	l ₂₁ mm	l ₁₆ mm	Module size	Type				
11	50	31,4	23,4	l16	GX09-1...	MSS-I16R/L02-GX09-1	MSS-I16R/L90-1,5D-N		
13	50	36,4	29,4	l20		MSS-I20R/L02-GX09-1	MSS-I20R/L90-1,5D-N		
17	56	45,4	37,4	l25		MSS-I25R/L02-GX09-1	MSS-I25R/L90-1,5D-N		
22	60	58	47	l32	GX16-2...	MSS-I32R/L03-GX16-2	MSS-I32R/L90-1,5D-N		
27	70	71	59	l40		MSS-I40R/L03-GX16-2	MSS-I40R/L90-1,5D-N		
14,5		179,4	39,4	l16	GX09-1...	MSS-I16R/L02-GX09-1	MSS-I16R/L90-2,5D-N		
18		199,4	49,4	l20		MSS-I20R/L02-GX09-1	MSS-I20R/L90-2,5D-N		
22,5		249,4	62,4	l25		MSS-I25R/L02-GX09-1	MSS-I25R/L90-2,5D-N		
29,5		299	79	l32	GX16-2...	MSS-I32R/L03-GX16-2	MSS-I32R/L90-2,5D-N		
35,5		349	99	l40		MSS-I40R/L03-GX16-2	MSS-I40R/L90-2,5D-N		

Walter Cut Capto™ tool

C ... – NCAE

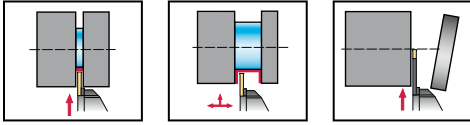

- external machining
- radial grooving 0°
- for grooving, recessing and parting off
- for GX inserts

Tool	Designation	s mm	T _{max} mm	D _{max} mm	d ₁ mm
Walter Capto™ ISO 26623 	NCAE16-C300R/L-GX09-1	2,0 - 2,5	7	52	C3
	NCAE16-C300R/L-GX09-2	3	7	52	C3
	NCAE20-C300R/L-GX16-1	2,0 - 2,5	12	63	C3
	NCAE25-C400R/L-GX16-1		12	79	C4
	NCAE25-C500R/L-GX16-1	12	79	79	C5
	NCAE20-C300R/L-GX16-2	3	12	63	C3
	NCAE25-C400R/L-GX16-2		12	79	C4
	NCAE25-C500R/L-GX16-2		12	79	C5
	NCAE32-C600R/L-GX16-2	4,0 - 5,0	12	100	C6
	NCAE20-C300R/L-GX16-3		12	63	C3
	NCAE25-C400R/L-GX16-3		12	79	C4
	NCAE25-C500R/L-GX16-3		12	79	C5
	NCAE32-C600R/L-GX16-3	6	12	100	C6
	NCAE25-C400R/L-GX16-4		12	79	C4
	NCAE25-C500R/L-GX16-4		12	79	C5
	NCAE32-C600R/L-GX16-4	12	100	C6	

$$f = f_1 + s/2$$

For T_{max} with greater diameters than D_{max}, see technical information on page A 316.

Bodies and assembly parts are included in the scope of delivery.

Ordering example:



Right-handed complete tool NCAE20-C300R-GX16-2 (right-handed module and right-handed toolholder)

Left-handed complete tool NCAE20-C300L-GX16-2 (left-handed module and left-handed toolholder)

Assembly parts

Module size	E16	E20	E25	E32
Screw for grooving module Tightening torque	FS1052 (Torx T15) 2,0 Nm	FS1053 (Torx T15) 2,0 Nm	FS1054 (Torx T20) 3,0 Nm	FS1055 (Torx T25) 3,0 Nm
Handle key, small	FS1047 (Torx T15)	FS1047 (Torx T15)	FS1048 (Torx T20)	FS1049 (Torx T25)
Cooling lubricant nozzle C3	FS1230	FS1230		
Cooling lubricant nozzle C4			FS1018	
Cooling lubricant nozzle C5			FS1019	
Cooling lubricant nozzle C6				FS1019



	f_1 mm	l_4 mm	Module size	Type	Grooving module 	Toolholder 
	19,8	40,5	E16	GX 09-1 ...	MSS-E16R/L07-GX09-1	C3-MSS-E16R/L00
	19,4	40,5	E16	GX 09-2 ...	MSS-E16R/L07-GX09-2	C3-MSS-E16R/L00
	19,8	40,5	E20	GX 16-1 ...	MSS-E20R/L12-GX16-1	C3-MSS-E20R/L00
	25,8	60,5	E25		MSS-E25R/L12-GX16-1	C4-MSS-E25R/L00
	30,8	60,5	E25	GX 16-2 ...	MSS-E25R/L12-GX16-1	C5-MSS-E25R/L00
	19,4	40,5	E20		MSS-E20R/L12-GX16-2	C3-MSS-E20R/L00
	25,4	60,5	E25		MSS-E25R/L12-GX16-2	C4-MSS-E25R/L00
	30,4	60,5	E25		MSS-E25R/L12-GX16-2	C5-MSS-E25R/L00
	36,4	66,5	E32	GX 16-3 ...	MSS-E32R/L12-GX16-2	C6-MSS-E32R/L00
	18,9	40,5	E20		MSS-E20R/L12-GX16-3	C3-MSS-E20R/L00
	24,9	60,5	E25		MSS-E25R/L12-GX16-3	C4-MSS-E25R/L00
	29,9	60,5	E25		MSS-E25R/L12-GX16-3	C5-MSS-E25R/L00
	35,9	66,5	E32	GX 16-4 ...	MSS-E32R/L12-GX16-3	C6-MSS-E32R/L00
	24,3	60,5	E25		MSS-E25R/L12-GX16-4	C4-MSS-E25R/L00
	29,3	60,5	E25		MSS-E25R/L12-GX16-4	C5-MSS-E25R/L00
	35,3	66,5	E32		MSS-E32R/L12-GX16-4	C6-MSS-E32R/L00



Walter Cut Capto™ tool

C ... – NCBE

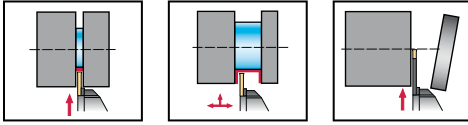

- external machining
- radial grooving 0°
- for grooving, recessing and parting off
- for GX/LX inserts

Tool	Designation	s mm	T _{max} mm	D _{max} mm	d ₁ mm
Walter Capto™ ISO 26623 	NCBE20-C300R/L-GX24-2-21	3	21	63	C3
	NCBE25-C400R/L-GX24-2-21		21	79	C4
	NCBE25-C500R/L-GX24-2-21		21	79	C5
	NCBE25-C400R/L-GX24-3-21	4,0 - 5,0	21	79	C4
	NCBE25-C500R/L-GX24-3-21		21	79	C5
	NCBE32-C600R/L-GX24-3-21		21	100	C6
	NCBE25-C400R/L-GX24-4-21	6	21	79	C4
	NCBE25-C500R/L-GX24-4-21		21	79	C5
	NCBE32-C600R/L-GX24-4-21		21	100	C6
	NCBE25-C400R/L-GX24-5-21	8	21	79	C4
	NCBE25-C500R/L-GX24-5-21		21	79	C5
	NCBE32-C600R/L-LX80-32		32	100	C6
	NCBE32-C600R/L-LX80-45		45	100	C6

$$f = f_1 + s/2$$

For T_{max} with greater diameters than D_{max}, see technical information on page A 316.

Bodies and assembly parts are included in the scope of delivery.



Ordering example:

Right-handed complete tool NCBE25-C400R-GX24-4-21 (right-handed module and right-handed toolholder)

Left-handed complete tool NCBE25-C400L-GX24-4-21 (left-handed module and left-handed toolholder)

Assembly parts	Module size	E20	E25	E32
	Clamping screw for LX grooving insert Tightening torque			FS1217 (Torx 20) 2,0 Nm
	Screw for grooving module Tightening torque	FS1053 (Torx 15) 2,0 Nm	FS1054 (Torx 20) 3,0 Nm	FS1055 (Torx 25) 3,0 Nm
	Handle key, small	FS1047 (Torx T15)	FS1048 (Torx 20)	FS1049 (Torx 25)
	Cooling lubricant nozzle C3	FS1230		
	Cooling lubricant nozzle C4		FS1018	
	Cooling lubricant nozzle C5		FS1019	
	Cooling lubricant nozzle C6			FS1019



	f_1 mm	l_4 mm	Module size	Type	Grooving module 	Toolholder 
	19,4	58,5	E20	GX 24-2 ...	MSS-E20R/L21-GX24-2	C3-MSS-E20R/L00
	25,4	69,5	E25		MSS-E25R/L21-GX24-2	C4-MSS-E25R/L00
	30,4	69,5	E25		MSS-E25R/L21-GX24-2	C5-MSS-E25R/L00
	24,9	69,5	E25	GX 24-3 ...	MSS-E25R/L21-GX24-3	C4-MSS-E25R/L00
	29,9	69,5	E25		MSS-E25R/L21-GX24-3	C5-MSS-E25R/L00
	35,9	75,5	E32		MSS-E32R/L21-GX24-3	C6-MSS-E32R/L00
	24,3	69,5	E25	GX 24-4 ...	MSS-E25R/L21-GX24-4	C4-MSS-E25R/L00
	29,3	69,5	E25		MSS-E25R/L21-GX24-4	C5-MSS-E25R/L00
	35,3	75,5	E32		MSS-E32R/L21-GX24-4	C6-MSS-E32R/L00
	23,5	69,5	E25	GX 24-5 ...	MSS-E25R/L21-GX24-5	C4-MSS-E25R/L00
	28,5	69,5	E25		MSS-E25R/L21-GX24-5	C5-MSS-E25R/L00
	38,9	87,3	E32	LX-...	MSS-E32N32-LX	C6-MSS-E32R/L00
	38,9	100,3	E32		MSS-E32N45-LX	C6-MSS-E32R/L00

Accessories



Module size

Handle key, small

E32

FS1048 (Torx 20)



A 58



G 2



A 313



A 304

Walter Cut Capto™ tool

C ... – NCLE

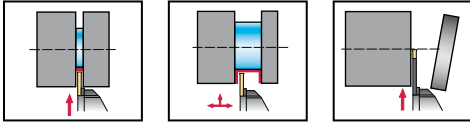

- external machining
- radial grooving 90°
- for grooving, recessing and parting off
- for GX/LX inserts

Tool	Designation	s mm	T _{max} mm	D _{max} mm	d ₁ mm
Walter Capto™ ISO 26623 	NCLE20-C300R/L-GX16-1	2,0 - 2,5	12	63	C3
	NCLE25-C400R/L-GX16-1		12	79	C4
	NCLE25-C500R/L-GX16-1		12	79	C5
	NCLE25-C400R/L-GX16-2	3	12	79	C4
	NCLE25-C500R/L-GX16-2		12	79	C5
	NCLE32-C600R/L-GX16-2		12	100	C6
	NCLE20-C300R/L-GX16-2	3,0 - 3,5	12	63	C3
	NCLE20-C300R/L-GX16-3		12	63	C3
	NCLE25-C400R/L-GX16-3		12	79	C4
	NCLE25-C500R/L-GX16-3	4,0 - 5,0	12	79	C5
	NCLE32-C600R/L-GX16-3		12	100	C6
	NCLE25-C400R/L-GX16-4		12	79	C4
	NCLE25-C500R/L-GX16-4	6	12	79	C5
	NCLE32-C600R/L-GX16-4		12	100	C6
	NCLE20-C300R/L-GX24-2-21		3	21	63
	NCLE25-C400R/L-GX24-2-21	21		79	C4
	NCLE25-C500R/L-GX24-2-21	21		79	C5
	NCLE25-C400R/L-GX24-3-21	4,0 - 5,0	21	79	C4
	NCLE25-C500R/L-GX24-3-21		21	79	C5
	NCLE32-C600R/L-GX24-3-21		21	100	C6
	NCLE25-C400R/L-GX24-4-21	6	21	79	C4
	NCLE25-C500R/L-GX24-4-21		21	79	C5
	NCLE32-C600R/L-GX24-4-21		21	100	C6
	NCLE25-C400R/L-GX24-5-21	8	21	79	C4
	NCLE25-C500R/L-GX24-5-21		21	79	C5
NCLE32-C600R/L-LX80-32	32		100	C6	
NCLE32-C600R/L-LX80-45		45	100	C6	

$$l_4 = l_{21} + s/2$$

For T_{max} with greater diameters than D_{max}, see technical information on page A 316.

Bodies and assembly parts are included in the scope of delivery.



Ordering example:

Right-handed complete tool NCLE32-C600R-GX16-3 (left-handed module and right-handed toolholder)

Left-handed complete tool NCLE32-C600L-GX16-3 (right-handed module and left-handed toolholder)

Assembly parts	Module size	E20	E25	E32
	Clamping screw for LX grooving insert Tightening torque			FS1217 (Torx 20) 2,0 Nm
	Screw for grooving module Tightening torque	FS1053 (Torx 15) 2,0 Nm	FS1054 (Torx 20) 3,0 Nm	FS1055 (Torx 25) 3,0 Nm
	Handle key, small	FS1047 (Torx T15)	FS1048 (Torx 20)	FS1049 (Torx 25)
	Cooling lubricant nozzle C3	FS1230		
	Cooling lubricant nozzle C4		FS1018	
	Cooling lubricant nozzle C5		FS1018	
	Cooling lubricant nozzle C6			FS1019



f mm	l ₂₁ mm	Module size	Type	Grooving module 	Toolholder 
33	35,8	E20	GX 16-1 ...	MSS-E20R/L12-GX16-1	C3-MSS-E20R/L90
33	53,8	E25		MSS-E25R/L12-GX16-1	C4-MSS-E25R/L90
38	53,8	E25	GX 16-2 ...	MSS-E25R/L12-GX16-1	C5-MSS-E25R/L90
33	53,4	E25		MSS-E25R/L12-GX16-2	C4-MSS-E25R/L90
38	53,4	E25	GX 16-3 ...	MSS-E25R/L12-GX16-2	C5-MSS-E25R/L90
40	61,9	E32		MSS-E32R/L12-GX16-2	C6-MSS-E32R/L90
33	35,4	E20	GX 16-4 ...	MSS-E20R/L12-GX16-2	C3-MSS-E20R/L90
33	34,9	E20		MSS-E20R/L12-GX16-3	C3-MSS-E20R/L90
33	52,9	E25	GX 24-2 ...	MSS-E25R/L12-GX16-3	C4-MSS-E25R/L90
38	52,9	E25		MSS-E25R/L12-GX16-3	C5-MSS-E25R/L90
40	61,4	E32	GX 24-3 ...	MSS-E32R/L12-GX16-3	C6-MSS-E32R/L90
33	52,3	E25		MSS-E25R/L12-GX16-4	C4-MSS-E25R/L90
38	52,3	E25	GX 24-4 ...	MSS-E25R/L12-GX16-4	C5-MSS-E25R/L90
40	60,8	E32		MSS-E32R/L12-GX16-4	C6-MSS-E32R/L90
42	35,4	E20	GX 24-5 ...	MSS-E20R/L21-GX24-2	C3-MSS-E20R/L90
42	53,4	E25		MSS-E25R/L21-GX24-2	C4-MSS-E25R/L90
47	53,4	E25	GX 24-3 ...	MSS-E25R/L21-GX24-2	C5-MSS-E25R/L90
42	52,9	E25		MSS-E25R/L21-GX24-3	C4-MSS-E25R/L90
47	52,9	E25	GX 24-4 ...	MSS-E25R/L21-GX24-3	C5-MSS-E25R/L90
49	61,4	E32		MSS-E32R/L21-GX24-3	C6-MSS-E32R/L90
42	52,3	E25	GX 24-5 ...	MSS-E25R/L21-GX24-4	C4-MSS-E25R/L90
47	52,3	E25		MSS-E25R/L21-GX24-4	C5-MSS-E25R/L90
49	60,8	E32	LX - ...	MSS-E32R/L21-GX24-4	C6-MSS-E32R/L90
42	51,5	E25		MSS-E25R/L21-GX24-5	C4-MSS-E25R/L90
47	51,5	E25	LX - ...	MSS-E25R/L21-GX24-5	C5-MSS-E25R/L90
61	60,4	E32		MSS-E32N32-LX	C6-MSS-E32R/L90
74	60,4	E32	LX - ...	MSS-E32N45-LX	C6-MSS-E32R/L90

Accessories

Module size

E32



Handle key, small

FS1048 (Torx 20)



A 58



G 2



A 313



A 304

Walter Cut Capto™ tool

C ... – NCCE

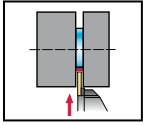

- external machining
- radial grooving 0°
- for circlip grooves
- for GX inserts

Tool

Walter Capto™ ISO 26623

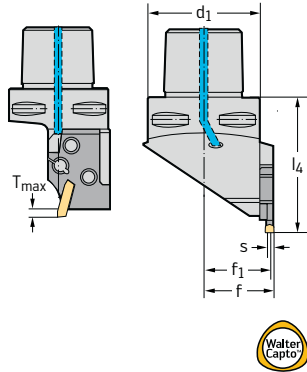

Designation	s mm	T _{max} mm	D _{max} mm	d ₁ mm
NCCE16-C300R/L-GX09-1	0,6 - 2,3	2	52	C3
NCCE20-C300R/L-GX16-2	0,6 - 3,3	3	52	C3
NCCE25-C400R/L-GX16-2		3	63	C4
NCCE25-C500R/L-GX16-2		3	79	C5
NCCE32-C600R/L-GX16-2		3	100	C6

$$f = f_1 + s/2$$

Bodies and assembly parts are included in the scope of delivery.

Ordering example:

Right-handed tool NCCE16-C300R-GX09-1 (right-handed module and right-handed toolholder)

Left-handed tool NCCE16-C300L-GX09-1 (left-handed module and left-handed toolholder)

Assembly parts

Module size	E16	E20	E25	E32
Screw for grooving module Tightening torque	FS1053 (Torx 15) 2,0 Nm	FS1054 (Torx 20) 2,0 Nm	FS1054 (Torx 20) 3,0 Nm	FS1055 (Torx 25) 3,0 Nm
Handle key, small	FS1047 (Torx T15)	FS1048 (Torx 20)	FS1048 (Torx 20)	FS1049 (Torx 25)
Cooling lubricant nozzle C3	FS1230			
Cooling lubricant nozzle C4		FS1018		
Cooling lubricant nozzle C5			FS1019	
Cooling lubricant nozzle C6				FS1019



	f_1 mm	l_4 mm	Module size	Type	Grooving module 	Toolholder
	19,8	40,5	E16	GX 09-1 ...	MSS-E16R/L02-GX09-1	C3-MSS-E16R/L00
	19,4	49,5	E16	GX 16-2 ...	MSS-E20R/L03-GX16-2	C3-MSS-E20R/L00
	25,4	60,5	E20		MSS-E25R/L03-GX16-2	C4-MSS-E25R/L00
	30,4	60,5	E25		MSS-E25R/L03-GX16-2	C5-MSS-E25R/L00
	36,4	66,5	E32		MSS-E32R/L03-GX16-2	C6-MSS-E32R/L00

Walter Cut Capto™ tool

C ... – NCNE

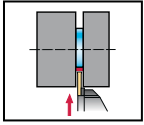

- external machining
- radial grooving 90°
- for circlip grooves
- for GX inserts

Tool

Walter Capto™ ISO 26623

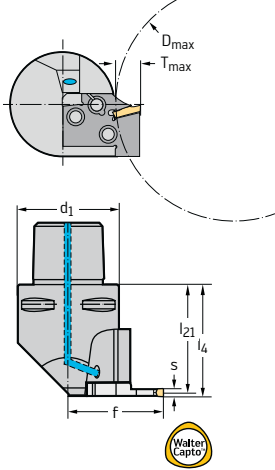

Designation

NCNE20-C300R/L-GX16-2
 NCNE25-C400R/L-GX16-2
 NCNE25-C500R/L-GX16-2
 NCNE32-C600R/L-GX16-2

s
mm

0,6 - 3,3

T_{max}
mm

3

3

3

3

D_{max}
mm

63

79

79

100

d₁
mm

C3

C4

C5

C6

$$l_4 = l_{21} + s/2$$

Bodies and assembly parts are included in the scope of delivery.

Ordering example:

Right-handed tool NCNE20-C300R-GX16-2 (left-handed module and right-handed toolholder)

Left-handed tool NCNE20-C300L-GX16-2 (right-handed module and left-handed toolholder)

Assembly parts



Module size

E20

E25

E32

 Screw for grooving module
 Tightening torque

 FS1053 (Torx 15)
 2,0 Nm

 FS1054 (Torx 20)
 3,0 Nm

 FS1055 (Torx 25)
 3,0 Nm

Handle key, small

FS1047 (Torx T15)

FS1048 (Torx 20)

FS1049 (Torx 25)



Cooling lubricant nozzle C3

FS1230

Cooling lubricant nozzle C4

FS1018

Cooling lubricant nozzle C5

FS1018

Cooling lubricant nozzle C6

FS1019



	f mm	l ₂₁ mm	Module size	Type	Grooving module	Toolholder
	33	35,4	E20	GX 16-2 ...	MSS-E20R/L03-GX16-2	C3-MSS-E20R/L90
	33	53,4	E25		MSS-E25R/L03-GX16-2	C4-MSS-E25R/L90
	38	53,4	E25		MSS-E25R/L03-GX16-2	C5-MSS-E25R/L90
	40	61,9	E32		MSS-E32R/L03-GX16-2	C6-MSS-E32R/L90

Walter Cut Capto™ tool

C ... – NCDE

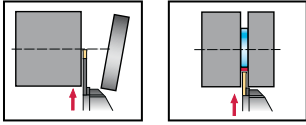

- external machining
- radial grooving 0°
- for grooving and parting off
- for FX inserts

Tool

Walter Capto™ ISO 26623

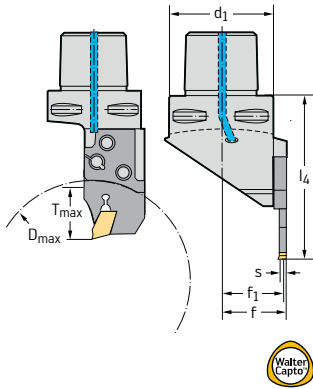

Designation

s
mm

T_{max}
mm

D_{max}
mm

Designation	s mm	T _{max} mm	D _{max} mm
NCDE20-C300R/L-FX22-20	2,2	20	63
NCDE25-C400R/L-FX22-20		20	79
NCDE25-C500R/L-FX22-20		20	79
NCDE20-C300R/L-FX31-20	3,1	20	63
NCDE25-C400R/L-FX31-25		25	79
NCDE25-C400R/L-FX31-35		35	79
NCDE25-C500R/L-FX31-25		25	79
NCDE25-C500R/L-FX31-35		35	79
NCDE32-C600R/L-FX31-32		32	100
NCDE32-C600R/L-FX31-45		45	100
NCDE20-C300R/L-FX41-20	4,1	20	63
NCDE25-C400R/L-FX41-25		25	79
NCDE25-C400R/L-FX41-35		35	79
NCDE25-C500R/L-FX41-25		25	79
NCDE25-C500R/L-FX41-35		35	79
NCDE32-C600R/L-FX41-32		32	100
NCDE32-C600R/L-FX41-45		45	100
NCDE25-C400R/L-FX51-25	5,1	25	79
NCDE25-C500R/L-FX51-25		25	79
NCDE25-C500R/L-FX51-35		35	100
NCDE32-C600R/L-FX51-32		32	100
NCDE32-C600R/L-FX51-45		45	100
NCDE32-C600R/L-FX65-32	6,5	32	100
NCDE32-C600R/L-FX65-45		45	100

 For T_{max} with greater diameters than D, see technical information on page A 317.

Bodies and assembly parts are included in the scope of delivery.

Ordering example:



Right-handed complete tool NCDE25-C400R-FX22-20 (right-handed module and right-handed toolholder)

Left-handed complete tool NCDE25-C400L-FX22-20 (left-handed module and left-handed toolholder)

Assembly parts

	Module size	E20	E25	E32
	Screw for grooving module Tightening torque	FS1053 (Torx T15) 2,0 Nm	FS1054 (Torx T20) 3,0 Nm	FS1055 (Torx T25) 3,0 Nm
	Handle key, small	FS1047 (Torx T15)	FS1048 (Torx T20)	FS1049 (Torx T25)
	Cooling lubricant nozzle C3	FS1230		
	Cooling lubricant nozzle C4		FS1018	
	Cooling lubricant nozzle C5		FS1019	
	Cooling lubricant nozzle C6			FS1019



	d_1 mm	f mm	l_4 mm	Module size	Type	Grooving module 	Toolholder 	
	C3	20,7	58,5	E20	FX2.2...	MSS-E20R/L20-FX2.2	C3-MSS-E20R/L00	
	C4	26,7	69,5	E25		MSS-E25R/L20-FX2.2	C4-MSS-E25R/L00	
	C5	31,7	69,5	E25		MSS-E25R/L20-FX2.2	C5-MSS-E25R/L00	
	C3	20,8	58,1	E20	FX3.1...	MSS-E20R/L20-FX3.1	C3-MSS-E20R/L00	
	C4	26,8	74,1	E25		MSS-E25R/L25-FX3.1	C4-MSS-E25R/L00	
	C4	26,8	84,1	E25		MSS-E25R/L35-FX3.1	C4-MSS-E25R/L00	
	C5	31,8	74,1	E25		MSS-E25R/L25-FX3.1	C5-MSS-E25R/L00	
	C5	31,8	84,1	E25		MSS-E25R/L35-FX3.1	C5-MSS-E25R/L00	
	C6	37,8	87,1	E32		MSS-E32R/L32-FX3.1	C6-MSS-E32R/L00	
	C6	37,8	100,1	E32		MSS-E32R/L45-FX3.1	C6-MSS-E32R/L00	
	C3	20,9	58,1	E20		FX4.1...	MSS-E20R/L20-FX4.1	C3-MSS-E20R/L00
	C4	26,9	74,1	E25			MSS-E25R/L25-FX4.1	C4-MSS-E25R/L00
	C4	26,9	84,1	E25			MSS-E25R/L35-FX4.1	C4-MSS-E25R/L00
	C5	31,9	74,1	E25	MSS-E25R/L25-FX4.1		C5-MSS-E25R/L00	
	C5	31,9	84,1	E25	MSS-E25R/L35-FX4.1		C5-MSS-E25R/L00	
	C6	37,9	87,1	E32	MSS-E32R/L32-FX4.1		C6-MSS-E32R/L00	
	C6	37,9	100,1	E32	MSS-E32R/L45-FX4.1		C6-MSS-E32R/L00	
	C4	27	74,1	E25	FX5.1...		MSS-E25R/L25-FX5.1	C4-MSS-E25R/L00
	C5	32	74,1	E25		MSS-E25R/L25-FX5.1	C5-MSS-E25R/L00	
	C5	32	84,1	E25		MSS-E25R/L35-FX5.1	C5-MSS-E25R/L00	
	C6	38	87,1	E32		MSS-E32R/L32-FX5.1	C6-MSS-E32R/L00	
	C6	38	100,1	E32		MSS-E32R/L45-FX5.1	C6-MSS-E32R/L00	
	C6	38,1	87,1	E32	FX6.5...	MSS-E32R/L32-FX6.5	C6-MSS-E32R/L00	
	C6	38,1	100,1	E32		MSS-E32R/L45-FX6.5	C6-MSS-E32R/L00	

Accessories

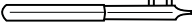
	Type	FX2.2...	FX3.1...-FX6.5...
	Mounting wrench for FX grooving insert	FS1494	FS1493



Walter Cut Capto™ tool

C ... – NCME

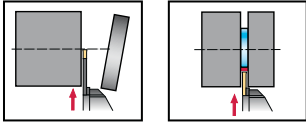

- external machining
- radial grooving 90°
- for grooving and parting off
- for FX/LX inserts

Tool	Designation	s mm	T _{max} mm	D _{max} mm	d ₁ mm
Walter Capto™ ISO 26623 	NCME20-C300R/L-FX22-20	2,2	20	63	C3
	NCME25-C400R/L-FX22-20		20	79	C4
	NCME25-C500R/L-FX22-20		20	79	C5
	NCME20-C300R/L-FX31-20	3,1	20	63	C3
	NCME25-C400R/L-FX31-25		25	79	C4
	NCME25-C400R/L-FX31-35		35	79	C4
	NCME25-C500R/L-FX31-25		25	79	C5
	NCME25-C500R/L-FX31-35		35	79	C5
	NCME32-C600R/L-FX31-32		32	100	C6
	NCME32-C600R/L-FX31-45	45	100	C6	
	NCME20-C300R/L-FX41-20	4,1	20	63	C3
	NCME25-C400R/L-FX41-25		25	79	C4
	NCME25-C400R/L-FX41-35		35	79	C4
	NCME25-C500R/L-FX41-25		25	79	C5
	NCME25-C500R/L-FX41-35		35	79	C5
	NCME32-C600R/L-FX41-32		32	100	C6
	NCME32-C600R/L-FX41-45	45	100	C6	
	NCME25-C400R/L-FX51-25	5,1	25	79	C4
	NCME25-C500R/L-FX51-25		25	79	C5
	NCME25-C500R/L-FX51-35		35	79	C5
	NCME32-C600R/L-FX51-32		32	100	C6
	NCME32-C600R/L-FX51-45	6,5	45	100	C6
	NCME32-C600R/L-FX65-32		32	100	C6
	NCME32-C600R/L-FX65-45	45	100	C6	

$$l_4 = l_{21} + s/2$$

T_{max} with greater diameters than D, see technical information on page A 317.

Bodies and assembly parts are included in the scope of delivery.



Ordering example:

Right-handed complete tool NCME25-C400R-FX41-35 (left-handed module and right-handed toolholder)

Left-handed complete tool NCME25-C400L-FX41-35 (right-handed module and left-handed toolholder)

Assembly parts	Module size	E20	E25	E32
	Handle key, small	FS1047 (Torx T15)	FS1048 (Torx 20)	FS1049 (Torx 25)
	Screw for grooving module Tightening torque	FS1053 (Torx 15) 2,0 Nm	FS1054 (Torx 20) 3,0 Nm	FS1055 (Torx 25) 3,0 Nm
	Cooling lubricant nozzle C3	FS1230		
	Cooling lubricant nozzle C4		FS1018	
	Cooling lubricant nozzle C5		FS1018	
	Cooling lubricant nozzle C6			FS1019



f mm	l ₂₁ mm	Module size	Type	Grooving module 	Toolholder 	
42	35,6	E20	FX 2.2 ...	MSS-E20R/L20-FX2.2	C3-MSS-E20R/L90	
42	53,6	E25		MSS-E25R/L20-FX2.2	C4-MSS-E25R/L90	
47	53,6	E25	FX 3.1 ...	MSS-E25R/L20-FX2.2	C5-MSS-E25R/L90	
46,6	35,2	E20		MSS-E20R/L20-FX3.1	C3-MSS-E20R/L90	
46,6	53,2	E25		MSS-E25R/L25-FX3.1	C4-MSS-E25R/L90	
46,6	53,2	E25		MSS-E25R/L35-FX3.1	C4-MSS-E25R/L90	
51,6	53,2	E25		MSS-E25R/L25-FX3.1	C5-MSS-E25R/L90	
51,6	53,2	E25		MSS-E25R/L35-FX3.1	C5-MSS-E25R/L90	
53,6	61,7	E32		MSS-E32R/L32-FX3.1	C6-MSS-E32R/L90	
53,6	61,7	E32		MSS-E32R/L45-FX3.1	C6-MSS-E32R/L90	
46,6	34,8	E20		FX 4.1 ...	MSS-E20R/L20-FX4.1	C3-MSS-E20R/L90
46,6	52,8	E25			MSS-E25R/L25-FX4.1	C4-MSS-E25R/L90
46,6	52,8	E25			MSS-E25R/L35-FX4.1	C4-MSS-E25R/L90
51,6	52,8	E25			MSS-E25R/L25-FX4.1	C5-MSS-E25R/L90
51,6	52,8	E25			MSS-E25R/L35-FX4.1	C5-MSS-E25R/L90
53,6	61,3	E32			MSS-E32R/L32-FX4.1	C6-MSS-E32R/L90
53,6	61,3	E32	MSS-E32R/L45-FX4.1		C6-MSS-E32R/L90	
46,6	52,4	E25	FX 5.1 ...		MSS-E25R/L25-FX5.1	C4-MSS-E25R/L90
51,6	52,4	E25			MSS-E25R/L25-FX5.1	C5-MSS-E25R/L90
51,6	52,4	E25			MSS-E25R/L35-FX5.1	C5-MSS-E25R/L90
53,6	60,9	E32		MSS-E32R/L32-FX5.1	C6-MSS-E32R/L90	
53,6	60,9	E32		MSS-E32R/L45-FX5.1	C6-MSS-E32R/L90	
53,6	60,3	E32	FX 6.5 ...	MSS-E32R/L32-FX6.5	C6-MSS-E32R/L90	
53,6	60,3	E32		MSS-E32R/L45-FX6.5	C6-MSS-E32R/L90	

Accessories

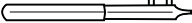
	Type	FX2.2...	FX3.1...-FX6.5...
	Mounting wrench for FX grooving insert	FS1494	FS1493



Walter Cut Capto™ tool

C ... – NCEE

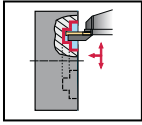

- external machining
- axial grooving 0°
- for axial grooving and face turning
- for GX inserts

Tool		s mm	T _{max} mm	D _{min} mm	D _{max} mm
Walter Capto™ ISO 26623					
	NCEE20-C300R/L-GX24-2-1	3	14	50	70
	NCEE20-C300R/L-GX24-2-2		14	70	100
	NCEE20-C300R/L-GX24-2-3		14	100	150
	NCEE25-C400R/L-GX24-2-1	3.0 - 3.5	15	50	70
	NCEE25-C400R/L-GX24-2-2		15	70	100
	NCEE25-C400R/L-GX24-2-3		15	100	150
	NCEE25-C500R/L-GX24-2-1		15	50	70
	NCEE25-C500R/L-GX24-2-2		15	70	100
	NCEE25-C500R/L-GX24-2-3		15	100	150
	NCEE25-C400R/L-GX24-3-1	4.0 - 5.0	15	50	70
	NCEE25-C400R/L-GX24-3-2		15	70	100
	NCEE25-C400R/L-GX24-3-3		15	100	150
	NCEE25-C400R/L-GX24-3-4		15	150	300
	NCEE25-C500R/L-GX24-3-1		15	50	70
	NCEE25-C500R/L-GX24-3-2		15	70	100
	NCEE25-C500R/L-GX24-3-3		15	100	150
	NCEE25-C500R/L-GX24-3-4		15	150	300
	NCEE32-C600R/L-GX24-3-2		15	70	100
	NCEE32-C600R/L-GX24-3-3		15	100	150
	NCEE32-C600R/L-GX24-3-4		15	150	300
	NCEE25-C400R/L-GX24-4-1		6	15	50
	NCEE25-C400R/L-GX24-4-2	15		70	100
	NCEE25-C400R/L-GX24-4-3	15		100	150
	NCEE25-C400R/L-GX24-4-4	15		150	300
	NCEE25-C500R/L-GX24-4-1	15		50	70
	NCEE25-C500R/L-GX24-4-2	15		70	100
	NCEE25-C500R/L-GX24-4-3	15		100	150
	NCEE25-C500R/L-GX24-4-4	15		150	300
	NCEE32-C600R/L-GX24-4-2	15		70	100
	NCEE32-C600R/L-GX24-4-3	15		100	150
	NCEE32-C600R/L-GX24-4-4	15		150	300
	NCEE32-C600R/L-GX24-4-5	15		300	900

$$f = f_1 + s/2$$

Bodies and assembly parts are included in the scope of delivery.

Ordering example:

Right-handed tool NCEE20-C300R-GX24-2-1 (right-handed module and right-handed toolholder)

Left-handed tool NCEE20-C300L-GX24-2-1 (left-handed module and left-handed toolholder)

Assembly parts		E20	E25	E32
	Screw for grooving module Tightening torque	FS1053 (Torx 15) 2,0 Nm	FS1054 (Torx 20) 3,0 Nm	FS1055 (Torx 25) 3,0 Nm
	Handle key, small	FS1047 (Torx T15)	FS1048 (Torx 20)	FS1049 (Torx 25)
	Cooling lubricant nozzle C3	FS1230		
	Cooling lubricant nozzle C4		FS1018	
	Cooling lubricant nozzle C5		FS1019	
	Cooling lubricant nozzle C6			FS1019



	d_1 mm	f_1 mm	l_4 mm	Module size	Type	Grooving module 	Toolholder
	C3	19,4	58,5	E20	GX 24-2 ...	MSS-E20R/L14-GX24-2A5070	C3-MSS-E20R/L00
	C3	19,4	58,5	E20		MSS-E20R/L14-GX24-2A70100	C3-MSS-E20R/L00
	C3	19,4	58,5	E20		MSS-E20R/L14-GX24-2A100150	C3-MSS-E20R/L00
	C4	26,4	69,5	E25		MSS-E25R/L15-GX24-2A5070	C4-MSS-E25R/L00
	C4	26,4	69,5	E25		MSS-E25R/L15-GX24-2A70100	C4-MSS-E25R/L00
	C4	26,4	69,5	E25		MSS-E25R/L15-GX24-2A100150	C4-MSS-E25R/L00
	C5	31,4	69,5	E25		MSS-E25R/L15-GX24-2A5070	C5-MSS-E25R/L00
	C5	31,4	69,5	E25		MSS-E25R/L15-GX24-2A70100	C5-MSS-E25R/L00
	C5	31,4	69,5	E25		MSS-E25R/L15-GX24-2A100150	C5-MSS-E25R/L00
	C4	26,4	69,5	E25	GX 24-3 ...	MSS-E25R/L15-GX24-3A5070	C4-MSS-E25R/L00
	C4	26,4	69,5	E25		MSS-E25R/L15-GX24-3A70100	C4-MSS-E25R/L00
	C4	26,4	69,5	E25		MSS-E25R/L15-GX24-3A100150	C4-MSS-E25R/L00
	C4	26,4	69,5	E25		MSS-E25R/L15-GX24-3A150300	C4-MSS-E25R/L00
	C5	31,4	69,5	E25		MSS-E25R/L15-GX24-3A5070	C5-MSS-E25R/L00
	C5	31,4	69,5	E25		MSS-E25R/L15-GX24-3A70100	C5-MSS-E25R/L00
	C5	31,4	69,5	E25		MSS-E25R/L15-GX24-3A100150	C5-MSS-E25R/L00
	C5	31,4	69,5	E25		MSS-E25R/L15-GX24-3A150300	C5-MSS-E25R/L00
	C6	37,4	75,5	E32		MSS-E32R/L15-GX24-3A70100	C6-MSS-E32R/L00
	C6	37,4	75,5	E32		MSS-E32R/L15-GX24-3A100150	C6-MSS-E32R/L00
	C6	37,4	75,5	E32		MSS-E32R/L15-GX24-3A150300	C6-MSS-E32R/L00
	C4	26,4	69,5	E25		GX 24-4 ...	MSS-E25R/L15-GX24-4A5070
	C4	26,4	69,5	E25	MSS-E25R/L15-GX24-4A70100		C4-MSS-E25R/L00
	C4	26,4	69,5	E25	MSS-E25R/L15-GX24-4A100150		C4-MSS-E25R/L00
	C4	26,4	69,5	E25	MSS-E25R/L15-GX24-4A150300		C4-MSS-E25R/L00
	C5	31,4	69,5	E25	MSS-E25R/L15-GX24-4A5070		C5-MSS-E25R/L00
	C5	31,4	69,5	E25	MSS-E25R/L15-GX24-4A70100		C5-MSS-E25R/L00
	C5	31,4	69,5	E25	MSS-E25R/L15-GX24-4A100150		C5-MSS-E25R/L00
	C5	31,4	69,5	E25	MSS-E25R/L15-GX24-4A150300		C5-MSS-E25R/L00
	C6	37,4	75,5	E32	MSS-E32R/L15-GX24-4A70100		C6-MSS-E32R/L00
	C6	37,4	75,5	E32	MSS-E32R/L15-GX24-4A100150		C6-MSS-E32R/L00
	C6	37,4	75,5	E32	MSS-E32R/L15-GX24-4A150300		C6-MSS-E32R/L00
	C6	37,4	75,5	E32	MSS-E32R/L15-GX24-4A300900		C6-MSS-E32R/L00



Walter Cut Capto™ tool

C ... – NCHE

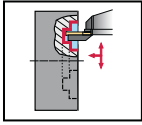

- external machining
- axial grooving 90°
- for axial grooving and face turning
- for GX inserts

Tool	Designation	s mm	T _{max} mm	D _{min} mm	D _{max} mm
Walter Capto™ ISO 26623 	NCHE20-C300R/L-GX24-2-1	3	14	50	70
	NCHE20-C300R/L-GX24-2-2		14	70	100
	NCHE20-C300R/L-GX24-2-3		14	100	150
	NCHE25-C400R/L-GX24-2-3		15	100	150
	NCHE25-C400R/L-GX24-2-2		15	70	100
	NCHE25-C400R/L-GX24-2-1		15	50	70
	NCHE25-C500R/L-GX24-2-3		15	100	150
	NCHE25-C500R/L-GX24-2-2		15	70	100
	NCHE25-C500R/L-GX24-2-1		15	50	70
	NCHE25-C400R/L-GX24-3-4		15	150	300
	NCHE25-C400R/L-GX24-3-3		15	100	150
	NCHE25-C400R/L-GX24-3-2		15	70	100
	NCHE25-C400R/L-GX24-3-1	15	50	70	
	NCHE25-C500R/L-GX24-3-4	15	150	300	
	NCHE25-C500R/L-GX24-3-3	15	100	150	
	NCHE25-C500R/L-GX24-3-2	15	70	100	
	NCHE25-C500R/L-GX24-3-1	15	50	70	
	NCHE32-C600R/L-GX24-3-2	15	70	100	
	NCHE32-C600R/L-GX24-3-3	15	100	150	
	NCHE32-C600R/L-GX24-3-4	15	150	300	
	NCHE25-C400R/L-GX24-4-4	15	150	300	
	NCHE25-C400R/L-GX24-4-3	15	100	150	
	NCHE25-C400R/L-GX24-4-2	15	70	100	
	NCHE25-C400R/L-GX24-4-1	15	50	70	
	NCHE25-C500R/L-GX24-4-1	15	50	70	
	NCHE25-C500R/L-GX24-4-2	15	70	100	
	NCHE25-C500R/L-GX24-4-3	15	100	150	
	NCHE25-C500R/L-GX24-4-4	15	150	300	
	NCHE32-C600R/L-GX24-4-2	15	70	100	
	NCHE32-C600R/L-GX24-4-3	15	100	150	
	NCHE32-C600R/L-GX24-4-4	15	150	300	
	NCHE32-C600R/L-GX24-4-5	15	300	900	

$$l_4 = l_{21} + s/2$$

Bodies and assembly parts are included in the scope of delivery.



Ordering example:

Right-handed complete tool NCHE25-C400R-GX24-4-2 (left-handed module and right-handed toolholder)

Left-handed complete tool NCHE25-C400L-GX24-4-2 (right-handed module and left-handed toolholder)

Assembly parts	Module size	E20	E25	E32
	Handle key, small	FS1047 (Torx T15)	FS1048 (Torx 20)	FS1049 (Torx 25)
	Screw for grooving module Tightening torque	FS1053 (Torx 15) 2,0 Nm	FS1054 (Torx 20) 3,0 Nm	FS1055 (Torx 25) 3,0 Nm
	Cooling lubricant nozzle C3	FS1230		
	Cooling lubricant nozzle C4		FS1018	
	Cooling lubricant nozzle C5		FS1018	
	Cooling lubricant nozzle C6			FS1019



	d_1 mm	f mm	l_{21} mm	Module size	Type	Grooving module 	Toolholder 
	C3	42	35,4	E20	GX 24-2 ...	MSS-E20R/L14-GX24-2A5070	C3-MSS-E20R/L90
	C3	42	35,4	E20		MSS-E20R/L14-GX24-2A70100	C3-MSS-E20R/L90
	C3	42	35,4	E20		MSS-E20R/L14-GX24-2A100150	C3-MSS-E20R/L90
	C4	42	53,4	E25		MSS-E25R/L15-GX24-2A100150	C4-MSS-E25R/L90
	C4	42	53,4	E25		MSS-E25R/L15-GX24-2A70100	C4-MSS-E25R/L90
	C4	42	53,4	E25		MSS-E25R/L15-GX24-2A5070	C4-MSS-E25R/L90
	C5	47	53,4	E25		MSS-E25R/L15-GX24-2A100150	C5-MSS-E25R/L90
	C5	47	53,4	E25		MSS-E25R/L15-GX24-2A70100	C5-MSS-E25R/L90
	C5	47	53,4	E25		MSS-E25R/L15-GX24-2A5070	C5-MSS-E25R/L90
	C4	42	52,9	E25		MSS-E25R/L15-GX24-3A150300	C4-MSS-E25R/L90
	C4	42	52,9	E25	MSS-E25R/L15-GX24-3A100150	C4-MSS-E25R/L90	
	C4	42	52,9	E25	MSS-E25R/L15-GX24-3A70100	C4-MSS-E25R/L90	
	C4	42	52,9	E25	MSS-E25R/L15-GX24-3A5070	C4-MSS-E25R/L90	
	C5	47	52,9	E25	MSS-E25R/L15-GX24-3A150300	C5-MSS-E25R/L90	
	C5	47	52,9	E25	MSS-E25R/L15-GX24-3A100150	C5-MSS-E25R/L90	
	C5	47	52,9	E25	MSS-E25R/L15-GX24-3A70100	C5-MSS-E25R/L90	
	C5	47	52,9	E25	MSS-E25R/L15-GX24-3A5070	C5-MSS-E25R/L90	
	C6	49	61,4	E32	MSS-E32R/L15-GX24-3A70100	C6-MSS-E32R/L90	
	C6	49	61,4	E32	MSS-E32R/L15-GX24-3A100150	C6-MSS-E32R/L90	
	C6	49	61,4	E32	MSS-E32R/L15-GX24-3A150300	C6-MSS-E32R/L90	
	C4	42	52,3	E25	MSS-E25R/L15-GX24-4A150300	C4-MSS-E25R/L90	
	C4	42	52,3	E25	MSS-E25R/L15-GX24-4A100150	C4-MSS-E25R/L90	
	C4	42	52,3	E25	MSS-E25R/L15-GX24-4A70100	C4-MSS-E25R/L90	
	C4	42	52,3	E25	MSS-E25R/L15-GX24-4A5070	C4-MSS-E25R/L90	
	C5	47	52,3	E25	MSS-E25R/L15-GX24-4A5070	C5-MSS-E25R/L90	
	C5	47	52,3	E25	MSS-E25R/L15-GX24-4A70100	C5-MSS-E25R/L90	
	C5	47	52,3	E25	MSS-E25R/L15-GX24-4A100150	C5-MSS-E25R/L90	
	C5	47	52,3	E25	MSS-E25R/L15-GX24-4A150300	C5-MSS-E25R/L90	
	C6	49	60,8	E32	MSS-E32R/L15-GX24-4A70100	C6-MSS-E32R/L90	
	C6	49	60,8	E32	MSS-E32R/L15-GX24-4A100150	C6-MSS-E32R/L90	
	C6	49	60,8	E32	MSS-E32R/L15-GX24-4A150300	C6-MSS-E32R/L90	
	C6	49	60,8	E32	MSS-E32R/L15-GX24-4A300900	C6-MSS-E32R/L90	



Walter Cut Capto™ tool

C ... – NCFE

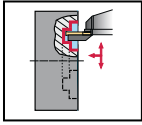

- external machining
- axial grooving 0°
- for deep axial grooving and face turning
- for GX inserts

Tool	Designation	s mm	T _{max} mm	D _{min} mm	D _{max} mm	
Walter Capto™ ISO 26623 	NCFE25-C400R/L-GX24-3-1	4,0 - 5,0	21	50	70	
	NCFE25-C400R/L-GX24-3-2		21	70	100	
	NCFE25-C400R/L-GX24-3-3		21	100	150	
	NCFE25-C400R/L-GX24-3-4		21	150	300	
	NCFE25-C500R/L-GX24-3-1		21	50	70	
	NCFE25-C500R/L-GX24-3-2		21	70	100	
	NCFE25-C500R/L-GX24-3-3		21	100	150	
	NCFE25-C500R/L-GX24-3-4		21	150	300	
	NCFE25-C400R/L-GX24-4-1		6	21	50	70
	NCFE25-C400R/L-GX24-4-2			21	70	100
	NCFE25-C400R/L-GX24-4-3	21		100	150	
	NCFE25-C400R/L-GX24-4-4	21		150	300	
	NCFE25-C500R/L-GX24-4-1	21		50	70	
	NCFE25-C500R/L-GX24-4-2	21		70	100	
	NCFE25-C500R/L-GX24-4-3	21		100	150	
	NCFE25-C500R/L-GX24-4-4	21		150	300	

$$f = f_1 + s/2$$

Bodies and assembly parts are included in the scope of delivery.

Ordering example:



Right-handed complete tool NCFE25-C400R-GX24-4-3 (right-handed module and right-handed toolholder)

Left-handed complete tool NCFE25-C400L-GX24-4-3 (left-handed module and left-handed toolholder)

For description of contra version/standard version, see page A 315.

Assembly parts	Module size	E25
	Clamping screw for grooving insert Tightening torque	FS1342 (Torx 15) 1,0 Nm
	Screw for grooving module Tightening torque	FS1054 (Torx 20) 3,0 Nm
	Key for clamping screw	FS1047 (Torx 15)
	Handle key, small	FS1048 (Torx 20)
	Cooling lubricant nozzle C4	FS1018
	Cooling lubricant nozzle C5	FS1019



	d_1 mm	f_1 mm	l_4 mm	Module size	Type	Grooving module 	Toolholder 	
	C4	24,9	82,5	E25	GX 24-3 ...	MSS-E25R/L21-GX24-3C5070	C4-MSS-E25R/L00	
	C4	24,9	82,5	E25		MSS-E25R/L21-GX24-3C70100	C4-MSS-E25R/L00	
	C4	24,9	82,5	E25		MSS-E25R/L21-GX24-3C100150	C4-MSS-E25R/L00	
	C4	24,9	82,5	E25		MSS-E25R/L21-GX24-3C150300	C4-MSS-E25R/L00	
	C5	29,9	82,5	E25		MSS-E25R/L21-GX24-3C5070	C5-MSS-E25R/L00	
	C5	29,9	82,5	E25		MSS-E25R/L21-GX24-3C70100	C5-MSS-E25R/L00	
	C5	29,9	82,5	E25		MSS-E25R/L21-GX24-3C100150	C5-MSS-E25R/L00	
	C5	29,9	82,5	E25		MSS-E25R/L21-GX24-3C150300	C5-MSS-E25R/L00	
	C4	24,3	82,5	E25		GX 24-4 ...	MSS-E25R/L25-GX24-4C5070	C4-MSS-E25R/L00
	C4	24,3	82,5	E25			MSS-E25R/L25-GX24-4C70100	C4-MSS-E25R/L00
	C4	24,3	82,5	E25			MSS-E25R/L25-GX24-4C100150	C4-MSS-E25R/L00
	C4	24,3	82,5	E25			MSS-E25R/L25-GX24-4C150300	C4-MSS-E25R/L00
	C5	29,3	82,5	E25	MSS-E25R/L25-GX24-4C5070		C5-MSS-E25R/L00	
	C5	29,3	82,5	E25	MSS-E25R/L25-GX24-4C70100		C5-MSS-E25R/L00	
	C5	29,3	82,5	E25	MSS-E25R/L25-GX24-4C100150		C5-MSS-E25R/L00	
	C5	29,3	82,5	E25	MSS-E25R/L25-GX24-4C150300		C5-MSS-E25R/L00	



A 58



G 2



A 313



A 304

Walter Cut Capto™ tool

C ... – NCOE

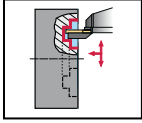

- external machining
- axial grooving 90°
- for deep axial grooving and face turning
- for GX inserts

Tool	Designation	s mm	T _{max} mm	D _{min} mm	D _{max} mm
Walter Capto™ ISO 26623 	NCOE25-C400R/L-GX24-3-1	4,0 - 5,0	21	50	70
	NCOE25-C400R/L-GX24-3-2		21	70	100
	NCOE25-C400R/L-GX24-3-3		21	100	150
	NCOE25-C400R/L-GX24-3-4		21	150	300
	NCOE25-C500R/L-GX24-3-1		21	50	70
	NCOE25-C500R/L-GX24-3-2		21	70	100
	NCOE25-C500R/L-GX24-3-3		21	100	150
	NCOE25-C500R/L-GX24-3-4		21	150	300
	NCOE25-C400R/L-GX24-4-1	6	21	50	70
	NCOE25-C400R/L-GX24-4-2		21	70	100
	NCOE25-C400R/L-GX24-4-3		21	100	150
	NCOE25-C400R/L-GX24-4-4		21	150	300
	NCOE25-C500R/L-GX24-4-1		21	50	70
	NCOE25-C500R/L-GX24-4-2		21	70	100
	NCOE25-C500R/L-GX24-4-3		21	100	150
	NCOE25-C500R/L-GX24-4-4		21	150	300

$$l_4 = l_{21} + s/2$$

Bodies and assembly parts are included in the scope of delivery.

Ordering example:

Right-handed complete tool NCOE25-C500R-GX24-4-1 (left-handed module and right-handed toolholder)

Left-handed complete tool NCOE25-C500L-GX24-4-1 (right-handed module and left-handed toolholder)

For description of contra version/standard version, see page A 315.

Assembly parts	Module size	E25
	Clamping screw for grooving insert	FS1342 (Torx 15)
	Tightening torque	1,0 Nm
	Screw for grooving module	FS1054 (Torx 20)
	Tightening torque	3,0 Nm
	Key for clamping screw	FS1047 (Torx 15)
	Handle key, small	FS1048 (Torx 20)
	Cooling lubricant nozzle C4	FS1018
	Cooling lubricant nozzle C5	FS1018



	d_1 mm	f mm	l_{21} mm	Module size	Type	Grooving module 	Toolholder 	
	C4	42	52,9	E25	GX 24-3 ...	MSS-E25R/L21-GX24-3C5070	C4-MSS-E25R/L90	
	C4	42	52,9	E25		MSS-E25R/L21-GX24-3C70100	C4-MSS-E25R/L90	
	C4	42	52,9	E25		MSS-E25R/L21-GX24-3C100150	C4-MSS-E25R/L90	
	C4	42	52,9	E25		MSS-E25R/L21-GX24-3C150300	C4-MSS-E25R/L90	
	C5	47	52,9	E25		MSS-E25R/L21-GX24-3C5070	C5-MSS-E25R/L90	
	C5	47	52,9	E25		MSS-E25R/L21-GX24-3C70100	C4-MSS-E25R/L90	
	C5	47	52,9	E25		MSS-E25R/L21-GX24-3C100150	C5-MSS-E25R/L90	
	C5	47	52,9	E25		MSS-E25R/L21-GX24-3C150300	C5-MSS-E25R/L90	
	C4	42	52,3	E25		GX 24-4 ...	MSS-E25R/L25-GX24-4C5070	C4-MSS-E25R/L90
	C4	42	52,3	E25			MSS-E25R/L25-GX24-4C70100	C4-MSS-E25R/L90
	C4	42	52,3	E25			MSS-E25R/L25-GX24-4C100150	C4-MSS-E25R/L90
	C4	42	52,3	E25			MSS-E25R/L25-GX24-4C150300	C4-MSS-E25R/L90
	C5	47	52,3	E25	MSS-E25R/L25-GX24-4C5070		C5-MSS-E25R/L90	
	C5	47	52,3	E25	MSS-E25R/L25-GX24-4C70100		C5-MSS-E25R/L90	
	C5	47	52,3	E25	MSS-E25R/L25-GX24-4C100150		C5-MSS-E25R/L90	
	C5	47	52,3	E25	MSS-E25R/L25-GX24-4C150300		C5-MSS-E25R/L90	



Walter Cut Capto™ tool

C ... – NCFE-C

Contra version

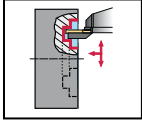

- external machining
- axial grooving 0°
- for deep axial grooving and face turning
- Contra version
- for GX inserts

Tool	Designation	s mm	T _{max} mm	D _{min} mm	D _{max} mm	
Walter Capto™ ISO 26623 	NCFE25-C400R/L-GX24-3-1C	4,0 - 5,0	21	50	70	
	NCFE25-C400R/L-GX24-3-2C		21	70	100	
	NCFE25-C400R/L-GX24-3-3C		21	100	150	
	NCFE25-C400R/L-GX24-3-4C		21	150	300	
	NCFE25-C500R/L-GX24-3-1C		21	50	70	
	NCFE25-C500R/L-GX24-3-2C		21	70	100	
	NCFE25-C500R/L-GX24-3-3C		21	100	150	
	NCFE25-C500R/L-GX24-3-4C		21	150	300	
	NCFE25-C400R/L-GX24-4-1C		5,0 - 6,0	21	50	70
	NCFE25-C400R/L-GX24-4-2C			21	70	100
	NCFE25-C400R/L-GX24-4-3C	21		100	150	
	NCFE25-C400R/L-GX24-4-4C	21		150	300	
	NCFE25-C500R/L-GX24-4-1C	21		50	70	
	NCFE25-C500R/L-GX24-4-2C	21		70	100	
	NCFE25-C500R/L-GX24-4-3C	21		100	150	
	NCFE25-C500R/L-GX24-4-4C	21		150	300	

$$f = f_1 + s/2$$

Bodies and assembly parts are included in the scope of delivery.

Ordering example:



Right-handed complete tool NCFE25-C500R-GX24-4-2C (left-handed module and right-handed toolholder)

Left-handed complete tool NCFE25-C500L-GX24-4-2C (right-handed module and left-handed toolholder)

For description of contra version/standard version, see page A 315.

Assembly parts	Module size	E25
	Handle key, small	FS1048 (Torx 20)
	Key for clamping screw	FS1047 (Torx 15)
	Screw for grooving module Tightening torque	FS1054 (Torx 20) 3,0 Nm
	Clamping screw for grooving insert Tightening torque	FS1342 (Torx 15) 1,0 Nm
	Cooling lubricant nozzle C4	FS1018
	Cooling lubricant nozzle C5	FS1019



	d_1 mm	f_1 mm	l_4 mm	Module size	Type	Grooving module 	Toolholder 	
	C4	24,9	82,5	E25	GX 24-3 ...	MSS-E25R/L21-GX24-3C5070	C4-MSS-E25R/L00	
	C4	24,9	82,5	E25		MSS-E25R/L21-GX24-3C70100	C4-MSS-E25R/L00	
	C4	24,9	82,5	E25		MSS-E25R/L21-GX24-3C100150	C4-MSS-E25R/L00	
	C4	24,9	82,5	E25		MSS-E25R/L21-GX24-3C150300	C4-MSS-E25R/L00	
	C5	29,9	82,5	E25		MSS-E25R/L21-GX24-3C5070	C5-MSS-E25R/L00	
	C5	29,9	82,5	E25		MSS-E25R/L21-GX24-3C70100	C5-MSS-E25R/L00	
	C5	29,9	82,5	E25		MSS-E25R/L21-GX24-3C100150	C5-MSS-E25R/L00	
	C5	29,9	82,5	E25		MSS-E25R/L21-GX24-3C150300	C5-MSS-E25R/L00	
	C4	24,3	82,5	E25		GX 24-4 ...	MSS-E25R/L25-GX24-4C5070	C4-MSS-E25R/L00
	C4	24,3	82,5	E25			MSS-E25R/L25-GX24-4C70100	C4-MSS-E25R/L00
	C4	24,3	82,5	E25			MSS-E25R/L25-GX24-4C100150	C4-MSS-E25R/L00
	C4	24,3	82,5	E25			MSS-E25R/L25-GX24-4C150300	C4-MSS-E25R/L00
	C5	29,3	82,5	E25	MSS-E25R/L25-GX24-4C5070		C5-MSS-E25R/L00	
	C5	29,3	82,5	E25	MSS-E25R/L25-GX24-4C70100		C5-MSS-E25R/L00	
	C5	29,3	82,5	E25	MSS-E25R/L25-GX24-4C100150		C5-MSS-E25R/L00	
	C5	29,3	82,5	E25	MSS-E25R/L25-GX24-4C150300		C5-MSS-E25R/L00	



Walter Cut Capto™ tool

C ... – NCOE-C

Contra version

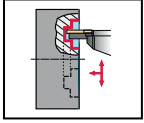

- external machining
- axial grooving 90°
- for deep axial grooving and face turning
- Contra version
- for GX inserts

Tool	Designation	s mm	T _{max} mm	D _{min} mm	D _{max} mm
Walter Capto™ ISO 26623 	NCOE25-C400R/L-GX24-3-1C	4,0 - 5,0	21	50	70
	NCOE25-C400R/L-GX24-3-2C		21	70	100
	NCOE25-C400R/L-GX24-3-3C		21	100	150
	NCOE25-C400R/L-GX24-3-4C		21	150	300
	NCOE25-C500R/L-GX24-3-1C		21	50	70
	NCOE25-C500R/L-GX24-3-2C		21	70	100
	NCOE25-C500R/L-GX24-3-3C	21	100	150	
	NCOE25-C500R/L-GX24-3-4C	21	150	300	
	NCOE25-C400R/L-GX24-4-1C	6	21	50	70
	NCOE25-C400R/L-GX24-4-2C		21	70	100
	NCOE25-C400R/L-GX24-4-3C		21	100	150
	NCOE25-C400R/L-GX24-4-4C		21	150	300
	NCOE25-C500R/L-GX24-4-1C		21	50	70
	NCOE25-C500R/L-GX24-4-2C		21	70	100
	NCOE25-C500R/L-GX24-4-3C	21	100	150	
	NCOE25-C500R/L-GX24-4-4C	21	150	300	

$$l_4 = l_{21} + s/2$$

Bodies and assembly parts are included in the scope of delivery.

Ordering example:



Right-handed complete tool NCOE25-C500R-GX24-4-3C (left-handed module and right-handed toolholder)

Left-handed complete tool NCOE25-C500L-GX24-4-3C (left-handed module and left-handed toolholder)

For description of contra version/standard version, see page A 315.

Assembly parts	Module size	E25
	Clamping screw for grooving insert	FS1342 (Torx 15)
	Tightening torque	1,0 Nm
	Screw for grooving module	FS1054 (Torx 20)
		3,0 Nm
	Key for clamping screw	FS1047 (Torx 15)
	Handle key, small	FS1048 (Torx 20)
	Cooling lubricant nozzle C4	FS1018
	Cooling lubricant nozzle C5	FS1018



	d_1 mm	f mm	l_{21} mm	Module size	Type	Grooving module 	Toolholder 	
	C4	42	52,9	E25	GX 24-3 ...	MSS-E25R/L21-GX24-3C5070	C4-MSS-E25R/L90	
	C4	42	52,9	E25		MSS-E25R/L21-GX24-3C70100	C4-MSS-E25R/L90	
	C4	42	52,9	E25		MSS-E25R/L21-GX24-3C100150	C4-MSS-E25R/L90	
	C4	42	52,9	E25		MSS-E25R/L21-GX24-3C150300	C4-MSS-E25R/L90	
	C5	47	52,9	E25		MSS-E25R/L21-GX24-3C5070	C5-MSS-E25R/L90	
	C5	47	52,9	E25		MSS-E25R/L21-GX24-3C70100	C5-MSS-E25R/L90	
	C5	47	52,9	E25		MSS-E25R/L21-GX24-3C100150	C5-MSS-E25R/L90	
	C5	47	52,9	E25		MSS-E25R/L21-GX24-3C150300	C5-MSS-E25R/L90	
	C4	42	52,3	E25		GX 24-4 ...	MSS-E25R/L25-GX24-4C5070	C4-MSS-E25R/L90
	C4	42	52,3	E25			MSS-E25R/L25-GX24-4C70100	C4-MSS-E25R/L90
	C4	42	52,3	E25			MSS-E25R/L25-GX24-4C100150	C4-MSS-E25R/L90
	C4	42	52,3	E25			MSS-E25R/L25-GX24-4C150300	C4-MSS-E25R/L90
	C5	47	52,3	E25	MSS-E25R/L25-GX24-4C5070		C5-MSS-E25R/L90	
	C5	47	52,3	E25	MSS-E25R/L25-GX24-4C70100		C5-MSS-E25R/L90	
	C5	47	52,3	E25	MSS-E25R/L25-GX24-4C100150		C5-MSS-E25R/L90	
	C5	47	52,3	E25	MSS-E25R/L25-GX24-4C150300		C5-MSS-E25R/L90	



A 58



G 2





A 313



A 304

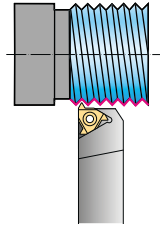
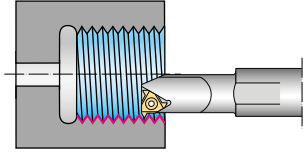
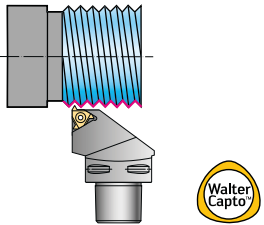
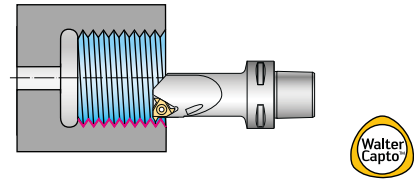
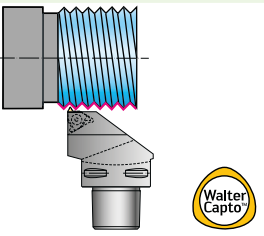
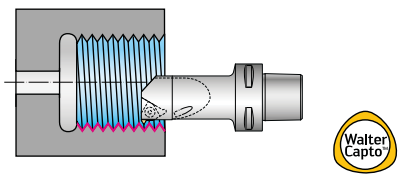

Product range overview of Walter Thread System / Walter Capto™

Threading	
External machining	Internal machining
 <p>Walter NTS Walter Capto™</p>	 <p>Walter NTS Walter Capto™</p>
NTS SE	NTS I
<p>$h = 12-40 \text{ mm}$</p>  <p style="text-align: right;">Page A 280</p>	<p>$d_1 = 16-40 \text{ mm}$</p>  <p style="text-align: right;">Page A 283</p>
NTS SE	NTS SI
<p>Normal position Walter Capto™</p>  <p style="text-align: right;">Page A 281</p>	<p>Normal position Walter Capto™</p>  <p style="text-align: right;">Page A 284</p>
NTS OE	NTS OI
<p>Inverted position Walter Capto™</p>  <p style="text-align: right;">Page A 282</p>	<p>Inverted position Walter Capto™</p>  <p style="text-align: right;">Page A 285</p>

Designation key for Walter Thread System

Example for external machining

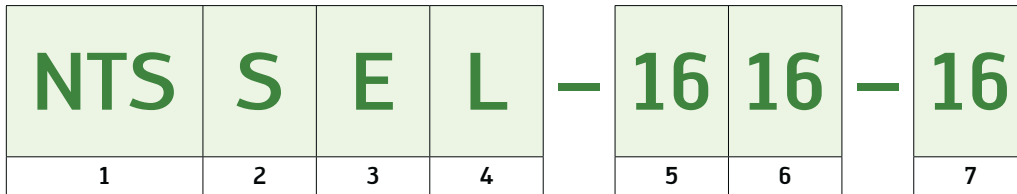

Example for internal machining

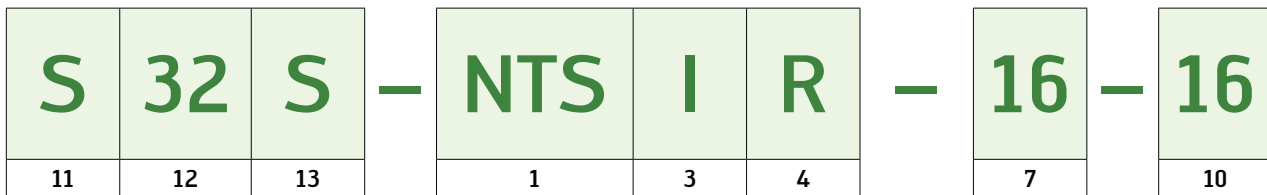

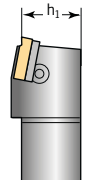

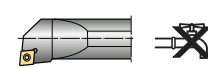
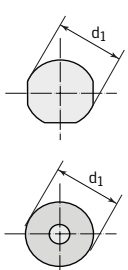
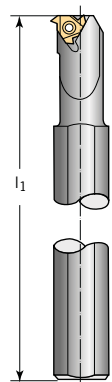
1	2	3	4	5
Tool range	Tool position	Version Tool	Version Shank	Holder height h_1 [mm]
NTS = Walter Thread System	S Standard position O Overhead position	E External I Internal	R Right-hand L Left-hand	

11	12	13		
Shank design	Boring bar diameter d_1 [mm]	Tool length l_1 [mm]		
A Solid steel design with internal coolant supply  S Solid steel design without internal coolant supply 	Shank diameter is shown in mm. Figures after the decimal point are ignored. Single-digit integers are preceded by a "0". 	<table style="width: 100%; border: none;"> <tr> <td style="width: 50%; vertical-align: top;"> A 32 B 40 C 50 D 60 E 70 F 80 G 90 H 100 J 110 K 125 L 140 M 150 N 160 </td> <td style="width: 50%; vertical-align: top;"> P 170 Q 180 R 200 S 250 T 300 U 350 V 400 W 450 X Custom Y 500 </td> </tr> </table> <div style="text-align: right; padding-top: 20px;">  </div>	A 32 B 40 C 50 D 60 E 70 F 80 G 90 H 100 J 110 K 125 L 140 M 150 N 160	P 170 Q 180 R 200 S 250 T 300 U 350 V 400 W 450 X Custom Y 500
A 32 B 40 C 50 D 60 E 70 F 80 G 90 H 100 J 110 K 125 L 140 M 150 N 160	P 170 Q 180 R 200 S 250 T 300 U 350 V 400 W 450 X Custom Y 500			

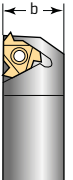

Example of Walter Capto™

C4	—	NTS	S	E	R	—	27	050	—	16
14		1	2	3	4		8	9		7

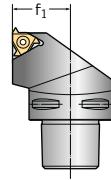
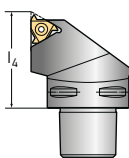
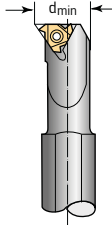
6	7	8	9	10
Holder width b [mm]	Cutting edge length l [mm]	f_1 dimension [mm]	Tool length l_4 [mm]	d_{min} dimension [mm]
	 <p>l = 11 l = 16 l = 22</p>			

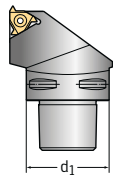
14
Coupling size d_1 [mm]
C = Walter Capto™
C3 $d_1 = 32$
C4 $d_1 = 40$
C5 $d_1 = 50$
C6 $d_1 = 63$

Walter NTS threading

NTS-SE

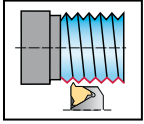

- external thread

Tool	Designation		h=h ₁ mm	b mm	f mm	l ₁ mm	l ₄ mm	Type
Standard position 	NTS-SER/L1216-16	16	12	12	16	83,2	22	NTS E ... -16
	NTS-SER/L1616-16	16	16	16	16	100	22	
	NTS-SER/L2020-16	16	20	20	20	128,6	30	
	NTS-SER/L2525-16	16	25	25	25	153,6	30	
	NTS-SER/L3232-16	16	32	32	32	173,6	34	NTS E ... -22
	NTS-SER/L2525-22	22	25	25	25	155,7	36	
	NTS-SER/L3232-22	22	32	32	32	175,7	36	
	NTS-SER/L4040-22	22	40	40	40	205,7	36	

Bodies and assembly parts are included in the scope of delivery.
 The toolholders listed are designed for an inclination angle of 1.5°.
 For additional shims for gradient angle correction, see page A 324.

Assembly parts	Type	NTSE ... -16	NTSE ... -22
	Shim, left	YE3	YE4
	Shim, right	YI3	YI4
	Clamping screw for threading insert	FS2177 (Torx 10)	FS2178 (Torx 20)
	Tightening torque	1,7 Nm	3,8 Nm
	Clamping screw and washer for shim	FS2179 (Torx 10)	FS2180 (Torx 20)
	Torx key	FS1050 (Torx 10)	FS256 (Torx 20)



Walter NTS Capto™ threading C ... - NTS-SE

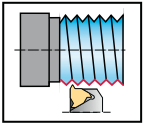

- external thread

Tool	Designation		d ₁ mm	f mm	l ₄ mm	Type	
Walter Capto™ ISO 26623 Standard position	C3-NTS-SER/L22040-16	16	C3	22	40	NTS E ... -16	
	C4-NTS-SER/L27050-16	16	C4	27	50		
	C5-NTS-SER/L35060-16	16	C5	35	60		
		C6-NTS-SER/L45065-16	16	C6	45	65	NTS E ... -22
		C4-NTS-SER/L27050-22	22	C4	27	50	
		C5-NTS-SER/L35060-22	22	C5	35	60	
	C6-NTS-SER/L45065-22	22	C6	45	65		

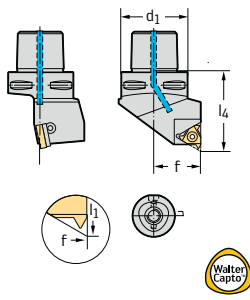

Bodies and assembly parts are included in the scope of delivery.
The toolholders listed are designed for an inclination angle of 1.5°.
For additional shims for gradient angle correction, see page A 324.

Assembly parts	Type	NTS E ... -16	NTS E ... -22
	Shim, left	YE3	YE4
	Shim, right	YI3	YI4
	Clamping screw and washer for shim	FS2179 (Torx 10)	FS2180 (Torx 20)
	Clamping screw for threading insert Tightening torque	FS2177 (Torx 10) 1,7 Nm	FS2178 (Torx 20) 3,8 Nm
	Torx key	FS1050 (Torx 10)	FS256 (Torx 20)
	Cooling lubricant nozzle C3	FS1230	
	Cooling lubricant nozzle C4	FS1018	FS1018
	Cooling lubricant nozzle C5	FS1019	FS1019
	Cooling lubricant nozzle C6	FS1019	FS1019

Walter NTS Capto™ threading

C ... -NTS-OE

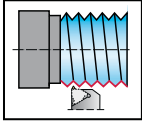

- external thread

Tool	Designation		d ₁ mm	f mm	l ₄ mm	Type
Walter Capto™ ISO 26623 Overhead position	C3-NTS-OER/L22040-16	16	C3	22	40	NTS E ... -16
	C4-NTS-OER/L27050-16	16	C4	27	50	
	C5-NTS-OER/L35060-16	16	C5	35	60	
	C6-NTS-OER/L45065-16	16	C6	45	65	NTS E ... -22
	C4-NTS-OER/L27050-22	22	C4	27	50	
	C5-NTS-OER/L35060-22	22	C5	35	60	
C6-NTS-OER/L45065-22	22	C6	45	65		

Bodies and assembly parts are included in the scope of delivery.
 The toolholders listed are designed for an inclination angle of 1.5°.
 For additional shims for gradient angle correction, see page A 324.

Assembly parts

	Type	NTS E ... -16	NTS E ... -22
	Shim, left	YE3	YE4
	Shim, right	YI3	YI4
	Clamping screw and washer for shim	FS2179 (Torx 10)	FS2180 (Torx 20)
	Clamping screw for threading insert	FS2177 (Torx 10)	FS2178 (Torx 20)
	Tightening torque	1,7 Nm	3,8 Nm
	Torx key	FS1050 (Torx 10)	FS256 (Torx 20)
	Cooling lubricant nozzle C3	FS1230	
	Cooling lubricant nozzle C4	FS1230	FS1230
	Cooling lubricant nozzle C5	FS1230	FS1230
	Cooling lubricant nozzle C6	FS1230	FS1230



Walter NTS threading

A ... -NTS-I / S ... -NTS-I

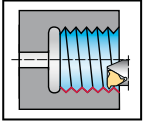

- internal thread

Tool	Designation		D_{min} mm	d_1 mm	f mm	h mm	l_1 mm	l_4 mm	Type
Standard position	A20Q-NTS-IR/L11-12	11	12	20	7,3	18	180	25	NTS I ... -11
Version A ... -NTS-I	A20Q-NTS-IR/L11-13	11	13	20	7,4	18	180	25	
	A20Q-NTS-IR/L11-16	11	16	20	8,9	18	180	32	NTS I ... -16
	A20Q-NTS-IR/L16-16	16	16	20	10,2	18	180	34	
	S16M-NTS-IR/L16-20	16	20	16	11,3	15,2	150	32	NTS I ... -16
	S20Q-NTS-IR/L16-17	16	17	20	10,3	18	180	32	
	S20Q-NTS-IR/L16-20	16	20	20	11,5	18	180	40	
	S20Q-NTS-IR/L16-24	16	24	20	13,4	18	180	40	
	S25R-NTS-IR/L16-29	16	29	25	16,1	22,6	200	45	
	S32S-NTS-IR/L16-29	16	29	32	16,3	29	250	60	
	S32S-NTS-IR/L16-36	16	36	32	19,6	29	250	60	
	S40T-NTS-IR/L16-44	16	44	40	23,8	36	300	60	
Version S ... -NTS-I	S20Q-NTS-IR/L22-27	22	27	20	15,6	18	180	50	NTS I ... -22
	S25R-NTS-IR/L22-32	22	32	25	17,2	22,6	200	45	
	S32S-NTS-IR/L22-32	22	32	32	17,4	29	250	60	
	S32S-NTS-IR/L22-39	22	39	32	21,5	29	250	60	
	S40T-NTS-IR/L22-47	22	47	40	25,8	36	300	60	

Bodies and assembly parts are included in the scope of delivery.
 The toolholders listed are designed for an inclination angle of 1.5°.
 For additional shims for gradient angle correction, see page A 324.

Assembly parts	Type	NTS I ... -11	NTS I ... -16	NTS I ... -22
	Shim, left		YE3	YE4
	Shim, right		YI3	YI4
	Clamping screw for threading insert	FS2174 (Torx 8)	FS2177 (Torx 10)	FS2178 (Torx 20)
	Tightening torque	0,9 Nm	1,7 Nm	3,8 Nm
	Clamping screw and washer for shim		FS2179 (Torx 10)	FS2180 (Torx 20)
	Torx key	FS257 (Torx 8)	FS1050 (Torx 10)	FS256 (Torx 20)



Cutting data for turning inserts – negative basic shape

Carbide grades

Material group	Structure of main material groups and identification letters		Brinell hardness HB	Tensile strength R_m N/mm ²	Machining group ¹			Cutting material grades						
								Starting values for cutting speed v_c [m/min]						
								WPP01			WPP05			
								f [mm/rev]			f [mm/rev]			
								0,10	0,20	0,30	0,10	0,40	0,60	
P	Unalloyed steel	C ≤ 0,25 %	annealed	125	428	P1	●●	●	620	590	560	610	470	350
		C > 0,25... ≤ 0,55 %	annealed	190	639	P2	●●	●	530	500	480	520	380	300
		C > 0,25... ≤ 0,55 %	tempered	210	708	P3	●●	●	400	380	360	400	310	260
		C > 0,55 %	annealed	190	639	P4	●●	●	510	480	460	500	360	280
		C > 0,55 %	tempered	300	1013	P5	●●	●	320	300	290	310	240	220
	Low-alloyed steel	Free cutting steel (short-chipping)	annealed	220	745	P6	●●	●	510	490	470	500	360	280
		annealed	175	591	P7	●●	●	460	440	420	460	330	290	
		tempered	300	1013	P8	●●	●	300	280	270	290	230	200	
		tempered	380	1282	P9	●●	●	270	250	220	260	180	140	
		tempered	430	1477	P10	●●	●	80	70	60	70	60		
High-alloyed steel and high-alloyed tool steel	annealed	200	675	P11	●●	●	480	460	440	480	300	220		
	hardened and tempered	300	1013	P12	●●	●	250	240	230	250	140	110		
	hardened and tempered	400	1361	P13	●●	●	90	80	70	80	70			
Stainless steel	ferritic / martensitic, annealed	200	675	P14	●●	●								
	martensitic, tempered	330	1114	P15	●●	●								
M	Stainless steel	austenitic, quench hardened	200	675	M1	●●	●							
		austenitic, precipitation hardened (PH)	300	1013	M2	●●	●							
		austenitic / ferritic, duplex	230	778	M3	●●	●							
K	Malleable cast iron	ferritic	200	675	K1	●●	●	300	270	250				
		pearlitic	260	867	K2	●●	●	260	230	210				
	Grey cast iron	low tensile strength	180	602	K3	●●	●	550	490	440				
		high tensile strength / austenitic	245	825	K4	●●	●	300	270	250				
	Cast iron with spheroidal graphite	ferritic	155	518	K5	●●	●	320	290	260				
pearlitic		265	885	K6	●●	●	230	210	190					
GGV (CGI)		200	675	K7	●●	●				380	250			
N	Aluminium wrought alloys	cannot be hardened	30	–	N1									
		hardenable, hardened	100	343	N2									
	Cast aluminium alloys	≤ 12 % Si, cannot be hardened	75	260	N3									
		≤ 12 % Si, hardenable, hardened	90	314	N4									
		> 12 % Si, cannot be hardened	130	447	N5									
	Magnesium alloys		70	250	N6									
	Copper and copper alloys (bronze / brass)	unalloyed, electrolytic copper	100	343	N7									
		Brass, bronze, red brass	90	314	N8									
		Cu-alloys, short-chipping	110	382	N9									
		high-strength, Ampco	300	1013	N10									
S	Heat-resistant alloys	Fe-based	annealed	200	675	S1	●●	●						
			hardened	280	943	S2	●●	●						
		Ni or Co base	annealed	250	839	S3	●●	●						
			hardened	350	1177	S4	●●	●						
	Titanium alloys	cast	320	1076	S5	●●	●							
		Pure titanium	200	675	S6	●●	●							
		α and β alloys, hardened	375	1262	S7	●●	●							
	Tungsten alloys	β alloys	410	1396	S8	●●	●							
Molybdenum alloys		300	1013	S9										
		300	1013	S10										
H	Hardened steel	hardened and tempered	50 HRC	–	H1	●	●●							
		hardened and tempered	55 HRC	–	H2	●	●●							
		hardened and tempered	60 HRC	–	H3	●	●●							
	Hardened cast iron	hardened and tempered	55 HRC	–	H4	●	●●							
O	Thermoplasts	without abrasive fillers			O1									
	Thermosetting plastics	without abrasive fillers			O2									
	Plastic, glass-fibre reinforced	GFRP			O3									
	Plastic, carbon-fibre reinforced	CFRP			O4									
	Plastic, aramid fibre reinforced	AFRP			O5									
	Graphite (technical)		80 Shore			O6								

- Recommended application (the specified cutting data are regarded as starting values for the recommended application).
- Possible application.

Note:

If dry machining is possible, the tool life reduces by an average of 20–30 %.

¹ The machining groups are assigned from H 8 onwards.

Cutting data for turning inserts – positive basic shape

Carbide grades

Material group	Structure of main material groups and identification letters		Brinell hardness HB	Tensile strength R _m N/mm ²	Machining group ¹		Cutting material grades							
							Starting values for cutting speed v _c [m/min]							
							WPP01			WPP10				
							f [mm/rev]			f [mm/rev]				
							0,10	0,20	0,30	0,10	0,20	0,40		
P	Unalloyed steel	C ≤ 0,25 %	annealed	125	428	P1	●●	●	560	530	500	530	480	410
		C > 0,25... ≤ 0,55 %	annealed	190	639	P2	●●	●	480	450	430	450	410	320
		C > 0,25... ≤ 0,55 %	tempered	210	708	P3	●●	●	360	330	330	340	310	290
		C > 0,55 %	annealed	190	639	P4	●●	●	470	440	420	440	410	390
		C > 0,55 %	tempered	300	1013	P5	●●	●	280	250	220	260	230	210
	Low-alloyed steel	Free cutting steel (short-chipping)	annealed	220	745	P6	●●	●	470	440	420	440	410	390
		annealed		175	591	P7	●●	●	420	390	370	400	370	350
		tempered		300	1013	P8	●●	●	260	230	210	240	210	190
		tempered		380	1282	P9	●●	●	200	180	160	180	150	130
		tempered		430	1477	P10	●●	●	70	60	50	60	50	
High-alloyed steel and high-alloyed tool steel	annealed		200	675	P11	●●	●	440	410	390	420	390	370	
	hardened and tempered		300	1013	P12	●●	●	230	200	180	200	180	160	
	hardened and tempered		400	1361	P13	●●	●	80	70	60	70	60		
Stainless steel	ferritic / martensitic, annealed		200	675	P14	●●	●				360	330	310	
	martensitic, tempered		330	1114	P15	●●	●				180	150	130	
M	Stainless steel	austenitic, quench hardened		200	675	M1	●●	●						
		austenitic, precipitation hardened (PH)		300	1013	M2	●●	●						
		austenitic / ferritic, duplex		230	778	M3	●●	●						
K	Malleable cast iron	ferritic		200	675	K1	●●	●	270	240	220	270	240	220
		pearlitic		260	867	K2	●●	●	230	200	180	230	200	180
	Grey cast iron	low tensile strength		180	602	K3	●●	●	520	490	470	500	470	430
		high tensile strength / austenitic		245	825	K4	●●	●	270	240	220	270	240	220
	Cast iron with spheroidal graphite	ferritic		155	518	K5	●●	●	290	260	240	290	260	240
		pearlitic		265	885	K6	●●	●	200	170	150	200	170	150
GGV (CGI)		200	675	K7	●●	●				270	220	200		
N	Aluminium wrought alloys	cannot be hardened		30	–	N1	●●	●						
		hardenable, hardened		100	343	N2	●●	●						
	Cast aluminium alloys	≤ 12 % Si, cannot be hardened		75	260	N3	●●	●						
		≤ 12 % Si, hardenable, hardened		90	314	N4	●●	●						
		> 12 % Si, cannot be hardened		130	447	N5	●●	●						
	Magnesium alloys		70	250	N6	●●	●							
	Copper and copper alloys (bronze / brass)	unalloyed, electrolytic copper		100	343	N7	●●	●						
Brass, bronze, red brass			90	314	N8	●●	●							
Cu-alloys, short-chipping			110	382	N9	●●	●							
high-strength, Ampco			300	1013	N10	●●	●							
S	Heat-resistant alloys	Fe-based	annealed		200	675	S1	●●	●					
			hardened		280	943	S2	●●	●					
		Ni or Co base	annealed		250	839	S3	●●	●					
			hardened		350	1177	S4	●●	●					
	Titanium alloys	cast		320	1076	S5	●●	●						
		Pure titanium		200	675	S6	●●	●						
		α and β alloys, hardened		375	1262	S7	●●	●						
		β alloys		410	1396	S8	●●	●						
Tungsten alloys		300	1013	S9	●●	●								
Molybdenum alloys		300	1013	S10	●●	●								
H	Hardened steel	hardened and tempered		50 HRC	–	H1	●	●●						
		hardened and tempered		55 HRC	–	H2	●	●●						
		hardened and tempered		60 HRC	–	H3	●	●●						
	Hardened cast iron	hardened and tempered		55 HRC	–	H4	●	●●						
O	Thermoplasts	without abrasive fillers				O1								
	Thermosetting plastics	without abrasive fillers				O2								
	Plastic, glass-fibre reinforced	GFRP				O3								
	Plastic, carbon-fibre reinforced	CFRP				O4								
	Plastic, aramid fibre reinforced	AFRP				O5								
	Graphite (technical)		80 Shore			O6								

- Recommended application (the specified cutting data are regarded as starting values for the recommended application).
- Possible application.

Note:

If dry machining is possible, the tool life reduces by an average of 20–30 %.

¹ The machining groups are assigned from H 8 onwards.

Cutting data for turning inserts – positive and negative basic shape

CBN and Si₃N₄ ceramic

Material group	Structure of main material groups and identification letters		Brinell hardness HB	Tensile strength R _m N/mm ²	Machining group ¹			
	= Cutting data for wet machining = Dry machining is possible							
P	Unalloyed steel	C ≤ 0,25 % annealed	125	428	P1			
		C > 0,25... ≤ 0,55 % annealed	190	639	P2			
		C > 0,25... ≤ 0,55 % tempered	210	708	P3			
		C > 0,55 % annealed	190	639	P4			
		C > 0,55 % tempered	300	1013	P5			
		Free cutting steel (short-chipping) annealed	220	745	P6			
	Low-alloyed steel	annealed	175	591	P7			
		tempered	300	1013	P8			
		tempered	380	1282	P9			
		tempered	430	1477	P10			
	High-alloyed steel and high-alloyed tool steel	annealed	200	675	P11			
		hardened and tempered	300	1013	P12			
		hardened and tempered	400	1361	P13			
	Stainless steel	ferritic / martensitic, annealed	200	675	P14			
		martensitic, tempered	330	1114	P15			
M	Stainless steel	austenitic, quench hardened	200	675	M1			
		austenitic, precipitation hardened (PH)	300	1013	M2			
		austenitic / ferritic, duplex	230	778	M3			
K	Malleable cast iron	ferritic	200	675	K1	●●		
		pearlitic	260	867	K2	●●		
	Grey cast iron	low tensile strength	180	602	K3	●●		
		high tensile strength / austenitic	245	825	K4	●●		
	Cast iron with spheroidal graphite	ferritic	155	518	K5	●●		
		pearlitic	265	885	K6	●●		
GGV (CGI)		200	675	K7				
N	Aluminium wrought alloys	cannot be hardened	30	–	N1			
		hardenable, hardened	100	343	N2			
	Cast aluminium alloys	≤ 12 % Si, cannot be hardened	75	260	N3			
		≤ 12 % Si, hardenable, hardened	90	314	N4			
		> 12 % Si, cannot be hardened	130	447	N5			
	Magnesium alloys		70	250	N6			
	Copper and copper alloys (bronze / brass)	unalloyed, electrolytic copper	100	343	N7			
		Brass, bronze, red brass	90	314	N8			
		Cu-alloys, short-chipping	110	382	N9			
		high-strength, Ampco	300	1013	N10			
S	Heat-resistant alloys	Fe-based	annealed	200	675	S1		
			hardened	280	943	S2		
		Ni or Co base	annealed	250	839	S3	●●	
			hardened	350	1177	S4	●●	
			cast	320	1076	S5	●●	
	Titanium alloys	Pure titanium	200	675	S6			
		α and β alloys, hardened	375	1262	S7			
		β alloys	410	1396	S8			
	Tungsten alloys		300	1013	S9			
	Molybdenum alloys		300	1013	S10			
H	Hardened steel	hardened and tempered	50 HRC	–	H1	●	●●	
		hardened and tempered	55 HRC	–	H2	●	●●	
		hardened and tempered	60 HRC	–	H3	●	●●	
	Hardened cast iron	hardened and tempered	55 HRC	–	H4	●	●●	
O	Thermoplasts	without abrasive fillers			O1			
	Thermosetting plastics	without abrasive fillers			O2			
	Plastic, glass-fibre reinforced	GFRP			O3			
	Plastic, carbon-fibre reinforced	CFRP			O4			
	Plastic, aramid fibre reinforced	AFRP			O5			
	Graphite (technical)		80 Shore		O6			

- Recommended application (the specified cutting data are regarded as starting values for the recommended application).
- Possible application.

¹ The machining groups are assigned from H 8 onwards.

Walter NTS Capto™ threading

C ... -NTS-SI

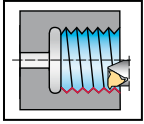

- internal thread

Tool	Designation		D_{\min} mm	d_2 mm	d_1 mm	f mm	l_4 mm	l_{16} mm	Type
Walter Capto™ ISO 26623 Standard position	C3-NTS-SIR/L22085-16	16	40	32	C3	22	85	70	NTSI ... -16
	C4-NTS-SIR/L22090-16	16	40	32	C4	22	90	69	
	C5-NTS-SIR/L22090-16	16	40	32	C5	22	90	68	
	C6-NTS-SIR/L22090-16	16	40	32	C6	22	90	64	
	C4-NTS-SIR/L27080-16	16	50	39,5	C4	27	80	60	
	C5-NTS-SIR/L27105-16	16	50	40	C5	27	105	84	
	C6-NTS-SIR/L27105-16	16	50	40	C6	27	105	80	NTSI ... -22
	C4-NTS-SIR/L22090-22	22	40	31,5	C4	22	90	69	
	C5-NTS-SIR/L22090-22	22	40	31,5	C5	22	90	68	
	C6-NTS-SIR/L22090-22	22	40	31,5	C6	22	90	64	
	C4-NTS-SIR/L27080-22	22	50	39,5	C4	27	80	60	
	C5-NTS-SIR/L27105-22	22	50	40	C5	27	105	84	
C6-NTS-SIR/L27105-22	22	50	40	C6	27	105	80		

Bodies and assembly parts are included in the scope of delivery.
 The toolholders listed are designed for an inclination angle of 1.5°.
 For additional shims for gradient angle correction, see page A 324.

Assembly parts	Type	NTSI ... -16	NTSI ... -22
	Shim, left	YE3	YE4
	Shim, right	YI3	YI4
	Clamping screw for threading insert Tightening torque	FS2177 (Torx 10) 1,7 Nm	FS2178 (Torx 20) 3,8 Nm
	Clamping screw and washer for shim	FS2179 (Torx 10)	FS2180 (Torx 20)
	Torx key	FS1050 (Torx 10)	FS256 (Torx 20)



Walter NTS Capto™ threading C ... -NTS-OI

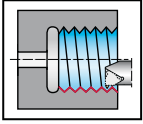

- internal thread

Tool	Designation		D_{min} mm	d_2 mm	d_1 mm	f mm	l_4 mm	l_{16} mm	Type
Walter Capto™ ISO 26623 Overhead position 	C3-NTS-OIR/L22085-16	16	40	32	C3	22	85	70	NTSI ... -16
	C4-NTS-OIR/L22090-16	16	40	32	C4	22	90	69	
	C5-NTS-OIR/L22090-16	16	40	32	C5	22	90	68	
	C6-NTS-OIR/L22090-16	16	40	32	C6	22	90	64	
	C4-NTS-OIR/L27080-16	16	50	39,5	C4	27	80	60	
	C5-NTS-OIR/L27105-16	16	50	40	C5	27	105	84	
	C6-NTS-OIR/L27105-16	16	50	40	C6	27	105	80	NTSI ... -22
	C4-NTS-OIR/L22090-22	22	40	31,5	C4	22	90	69	
	C5-NTS-OIR/L22090-22	22	40	31,5	C5	22	90	68	
	C6-NTS-OIR/L22090-22	22	40	31,5	C6	22	90	64	
	C4-NTS-OIR/L27080-22	22	50	39,5	C4	27	80	60	
	C5-NTS-OIR/L27105-22	22	50	40	C5	27	105	84	
	C6-NTS-OIR/L27105-22	22	50	40	C6	27	105	80	

Bodies and assembly parts are included in the scope of delivery.
 The toolholders listed are designed for an inclination angle of 1.5°.
 For additional shims for gradient angle correction, see page A 324.

Assembly parts		NTSI ... -16	NTSI ... -22
	Shim, left	YE3	YE4
	Shim, right	YI3	YI4
	Clamping screw for threading insert	FS2177 (Torx 10)	FS2178 (Torx 20)
	Tightening torque	1,7 Nm	3,8 Nm
	Clamping screw and washer for shim	FS2179 (Torx 10)	FS2180 (Torx 20)
	Torx key	FS1050 (Torx 10)	FS256 (Torx 20)

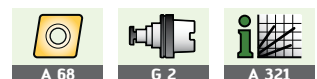

Cutting material application tables – turning

Walter grade designation	Standard designation	Workpiece material group							Application range							Coating procedure	Coating structure	Indexable insert example	
		P	M	K	N	S	H	O	01	05	10	15	20	25	30				35
		Steel	Stainless steel	Cast iron	NF metals	Difficult-to-machine materials	Hard materials	Other											
WPP 01	HC – P 01	●●																	
	HC – K 10	●		●															
WPP 05	HC – P 05	●●																	
WPP 10	HC – P 10	●●																	
	HC – K 20	●		●															
WPP 20	HC – P 20	●●																	
	HC – K 30	●		●															
WPP 30	HC – P 30	●●																	
WSM 10	HC – M 10	●	●●																
	HC – S 10	●				●●													
	HC – P 20	●																	
WSM 20	HC – M 20	●	●●																
	HC – S 20	●				●●													
	HC – P 20	●																	
WSM 30	HC – M 30	●	●●																
	HC – S 30	●				●●													
	HC – P 30	●																	
WSM 21	HC – M 20	●	●●																
	HC – S 20	●				●●													
	HC – P 20	●●																	
WS 10	HW – S 10					●●													
WAK 10	HC – K 10			●●															
	HC – H 30						●												
WAK 20	HC – K 20			●●															
	HC – P 10	●																	
WAK 30	HC – K 30			●●															
	HC – P 40	●																	
WSN 10	CN – K 20			●●															
WXN 10	HC – N 10				●●														
	HC – P 01	●																	
	HC – M 01		●																
WK 1	HW – N 10				●●														
	HW – S 10					●													
WCB 30	BL – H 05						●●												
WCB 50	BH – H 10						●●												
	BH – K 10			●															











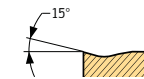
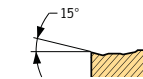

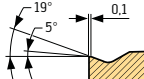
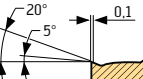
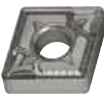

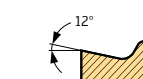

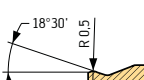
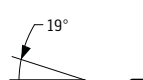
 HC = Coated carbide
 HW = Uncoated carbide

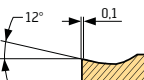
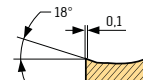
 BL = CBN with low CBN content
 BH = CBN with high CBN content

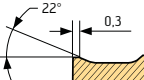
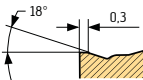
 CN = Silicon nitride Si₃N₄

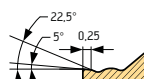
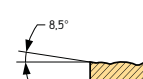
 ●● Primary application
 ● Other application

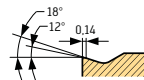
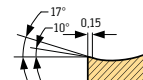
Geometry overview of turning inserts – negative basic shape

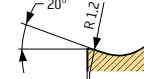
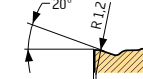



Finishing		Workpiece material group							Cut Main cutting edge	Cut Corner radius	a _p [mm]	f [mm]
		P	M	K	N	S	H	O				
Geometry	Remarks / field of applications	Steel	Stainless steel	Cast iron	NF metals	Difficult-to-machine materials	Hard materials	Other				
 Wiper	NF – Finishing with wiper technology – High surface quality – High feed rates	••	••	••		•					0,4–3,0	0,10–0,55
	NF3 – Finishing steel materials – Finishing cast iron workpieces with WPP01 – Can also be used in semi-finishing area	••		•							0,1–2,5	0,04–0,25
	NFT – Finishing titanium materials – Sharp, fully ground circumference cutting edge, first choice – 100° corner with roughing geometry implemented with CNMG basic shape			•		••					0,1–2,0	0,05–0,20
	NF4 – Finishing stainless materials – Finishing alloys with difficult cutting properties – Finishing long-chipping steel materials – Curved cutting edge for cutting pressure reduction	•	••			••					0,2–1,6	0,05–0,20
	NS6 – Semi-finishing – Machining of free cutting steel materials with low-pressure cut – Machining long, small diameter shafts – Low cutting forces	••									0,3–3,2	0,08–0,40
Medium machining												
 Wiper	NM – Medium machining with wiper technology – High surface quality – High feed rates	••	•	••		•					0,8–4,0	0,15–0,70
	NMT – Medium machining of titanium materials – Low cutting forces – Machining long-chipping steel materials – Machining forged parts with small amount of material removal	••				••					0,6–4,0	0,12–0,32
	NMS – Medium machining, especially for high-temperature alloys (Ni, Co, Fe-based alloys) – Precise cutting edge design – Alternative to NM4 stainless geometry			•		••					0,5–4,0	0,10–0,40
	NM4 Stainless – Universal geometry, stainless materials – Universal geometry, high temperature alloys – Machining long-chipping steel	•	••			••					0,5–4,5	0,10–0,40

•• Primary application
• Other application



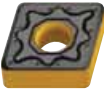
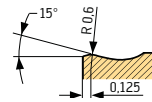
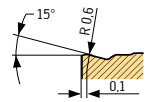

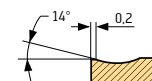
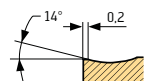

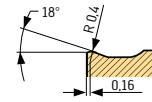
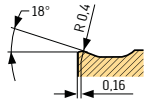
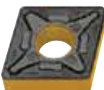
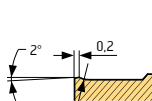
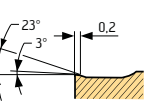

Comment: cross-sections show CNMG 120408 . .

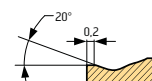
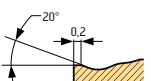
Geometry overview of turning inserts – negative basic shape

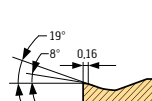
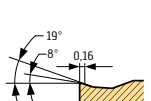
Medium machining – continued

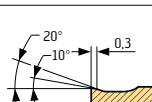
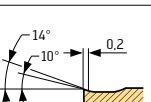
Geometry	Remarks / field of applications	Workpiece material group							Cut Main cutting edge	Cut Corner radius	a_p [mm]	f [mm]
		P	M	K	N	S	H	O				
	NM4 Steel – Universal geometry, steel materials	••									0,5–8,0	0,16–0,55
	NM5 – Universal geometry, cast iron materials – Machining high-strength steel materials	•		••							0,6–8,0	0,15–0,90
	NM6 – Interrupted cuts – Cast skins / forged skins – Stable cutting edge	••		••							0,8–8,0	0,16–0,70
	NM9 – Universal roughing of steel materials – Roughing of cast iron materials with WPP05 / WPP10	••		•							0,8–10,0	0,15–0,90

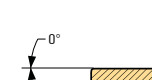

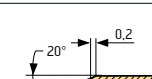
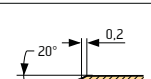

Roughing – double sided inserts

	NRT – Roughing of titanium materials – Stable cutting edge with protective chamfer										0,8–9,0	0,18–0,80
	NRS – Roughing, specially for high temperature alloy (Ni, Co, Fe-based alloys) – Precise cutting edge design – Alternative to NR4 geometry		•								1,0–6,0	0,15–0,70
	NR4 – Roughing of stainless materials – Roughing of high temperature alloys		••								1,2–8,5	0,22–0,80
	NMA – Universal geometry, cast iron materials			••							0,6–8,0	0,16–0,80
	T02020 – Cast iron machining with hard crust – Interrupted cuts – Hard machining of steel materials			••							0,8–8,0	0,25–0,80

- Primary application
- Other application

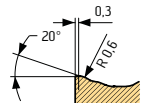
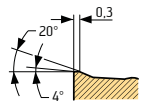
Comment: cross-sections show CNMG 120408 . .
or CNMA 120408 . .

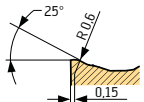
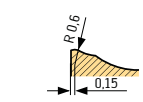

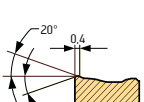
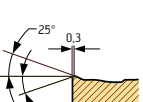

Roughing – single-sided inserts

Geometry	Remarks / field of applications	Workpiece material group							Cut Main cutting edge	Cut Corner radius	a _p [mm]	f [mm]
		P	M	K	N	S	H	O				
	NRF – Universal single-sided roughing insert – Forged parts with uneven material removal – Low power consumption – Easy-cutting geometry	••	•	•							0,8–12,0	0,25–1,20
	NR6 – Single-sided roughing geometry – Alternative to NRF geometry – Advantages in case of crater wear	••									1,5–12,0	0,35–1,40
	NRR – Heavy roughing – Machining of cast skins / forged parts – Interrupted cuts – Maximum cutting depths and feeds	••		•							2,0–17,0	0,50–1,80

Comment: cross-sections show SNMM 190616 . .

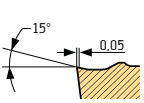
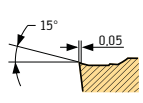
Geometry overview of turning inserts – positive basic shape

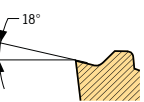
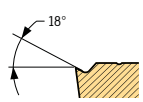
Finishing

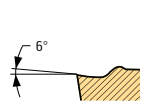
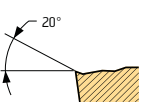
Geometry	Remarks / field of applications	Workpiece material group							Cut Main cutting edge	Cut Corner radius	a _p [mm]	f [mm]
		P	M	K	N	S	H	O				
 Wiper	PF – Finishing with wiper technology – High surface quality – High feed rates	••	••	••		•					0,30–3,0	0,12–0,60
	PF2 – Finishing insert with fully ground circumference – Long, small diameter shafts with vibration tendency – Low cutting forces	••	••	•	••	••					0,12–4,5	0,02–0,45
	PF4 – Finishing insert – Outstanding chip control – Can also be used for precision boring	••	••			••					0,1–5,0	0,04–0,40

•• Primary application
 • Other application



Comment: cross sections show CCMT 09T308 . . or CCGT 09T308 . .

Geometry overview of turning inserts – positive basic shape

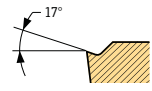
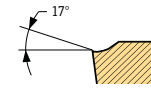
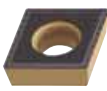
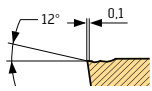
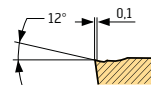

Finishing – continued

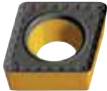
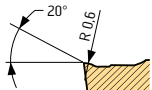
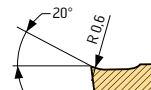
Geometry	Remarks / field of applications	Workpiece material group							Cut Main cutting edge	Cut Corner radius	a_p [mm]	f [mm]
		P	M	K	N	S	H	O				
 PF5 – Finishing insert with fully ground circumference – Can also be used for precision boring – Extremely narrow chip breaker groove	●● ●● ● ●									0,1–4,0	0,04–0,35	
 PS5 – Semifinishing – Universal insert for finishing up to medium machining – Can also be used for counterboring	●● ●● ●● ●									0,3–2,5	0,08–0,32	

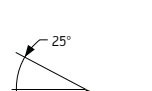
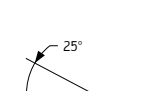
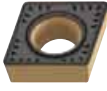
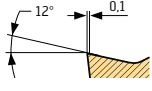
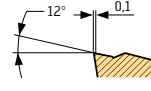
Medium machining

 PM – Finishing with wiper technology – High surface quality – High feed rates Wiper	●● ● ●● ●									0,5–4,0	0,12–0,60
 PM2 – Universal insert for non-ferrous materials – Sharp cutting edge with fully ground circumference – Polished rake face – Precision finishing on steel and stainless materials	● ● ●● ●									0,5–6,0	0,02–0,80
 PM5 – Universal geometry, medium machining to roughing – Extremely large chip breaking area	●● ●● ●● ●									0,6–5,0	0,12–0,50

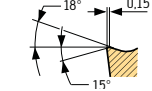
Roughing

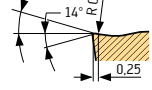
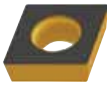
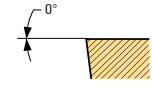
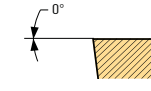







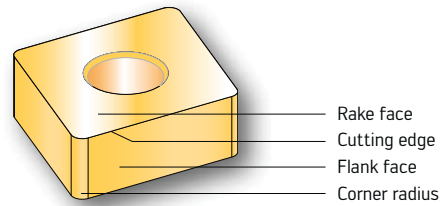

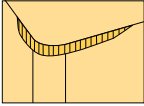

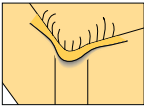
 M0T – Geometry especially for round inserts – Interrupted cuts	●● ●									1,0–11,0	0,12–1,3
 PR5 – Geometry especially for round inserts – Heavy roughing – Heavy industry, e.g. railways	●● ●									1,0–15,0	0,20–1,7
 CMW – Cast iron machining with hard crust – Interrupted cuts – Stable cutting edge design	●		●●							0,2–0,6	0,12–0,50

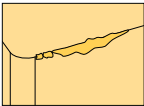
●● Primary application
 ● Other application

Comment: cross sections show CCMT 09T308 . . . CCGT 09T308 . . .
 CCMW 09T308 . . . and RCM . 2006 . . .

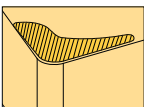
Usage information: Wear patterns from turning

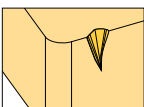

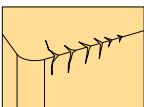
Types of wear		Characteristics	Action	
Flank face wear			Abrasion on the flank face of the indexable insert	<ul style="list-style-type: none"> – Use a more wear-resistant grade – Increase the feed – Reduce the cutting speed – Optimise cooling
Plastic deformation			Deformation of the cutting edge due to thermal overload and high cutting forces	<ul style="list-style-type: none"> – Use a more wear-resistant grade – Reduce feed – Reduce the cutting depth – Optimise cooling – Reduce the cutting speed
Fractures			Fractures along the cutting edge	<ul style="list-style-type: none"> – Use tougher grades of carbide – Use a more stable tool and reduce the projection length – Use more stable geometries – Reduce the cutting speed
Build-up on the cutting edge			Adhesion of material along the cutting edge on the rake face	<ul style="list-style-type: none"> – Increase the cutting speed – Use sharper geometry with a larger rake angle – Optimise cooling – Use an indexable insert with a treated surface (Tiger-tec®)
Crater wear			Crater-shaped cavities on the rake face of the indexable insert	<ul style="list-style-type: none"> – Reduce the cutting speed – Use a geometry with a larger rake angle – Use a cutting material that is more wear-resistant with high Al₂O₃ content – Optimise cooling
Notch or oxidation wear			Notching around the cutting depth on the indexable insert	<ul style="list-style-type: none"> – Vary the cutting depth – Use a tough cutting material (PVD coated) – Reduce the cutting speed – Use a more open geometry – Optimise cooling – Use a tool with a preceding cutting edge ($\kappa = 45^\circ / 75^\circ$) – With shear wear, select a smaller corner radius
Comb cracks			Multiple cracks running vertical to the cutting edge, due to thermal shock	<ul style="list-style-type: none"> – Possibly work the interrupted cut without coolant – Reduce the cutting speed – Reduce feed – Use a tougher cutting material – Use more stable geometries

Application information for wiper inserts

1. Achievable surface quality with Wiper

Wiper

One geometry for two applications!

- Same surface quality at double the feed rate
- Twice as good a surface quality at the same feed rate

A table containing the achievable surface qualities with the standard radius can be found on the next page.

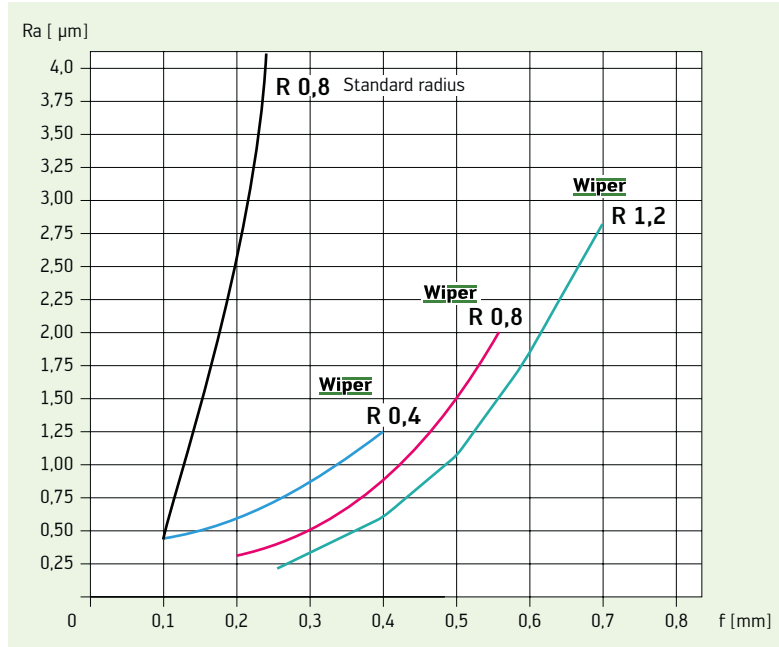

2. Cutting edge formation: comparison of Wiper inserts and standard inserts

The specified maximum feeds may not be exceeded with Wiper geometries:

R	f_{\max} [mm]
0,4	$\leq 0,4$
0,8	$\leq 0,55$
1,2	$\leq 0,7$

Wiper finishing operations with –NF / –NM and –PF / –PM geometry

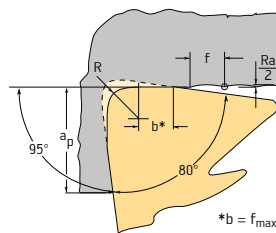

Standard finishing operations

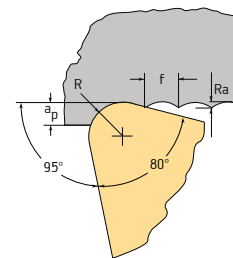

3. Usage recommendations

Use turning toolholders with an approach angle $\kappa = 95^\circ$ for CNMG / CCMT and WNMG / WCMT wiper inserts, and an approach angle $\kappa = 93^\circ$ for DNMG / DCMT wiper inserts, for example:

CNMG 120408–NM → DCLN R 2525M12
 WNMG 080408–NM → DWLN R 2525M08
 DNMG 150608–NM → DDJN R 2525M15

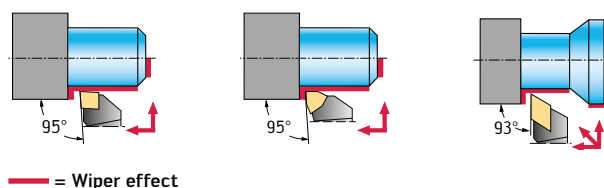



The wiper effect is achieved during longitudinal and face turning.
 The wiper effect is not achieved with angles and radii.
 Please note that radius compensation is required in the vicinity of radii and angles, otherwise contour distortion will occur.

Usage information: Surface quality

Achievable surface quality with standard radius

Select the maximum permissible corner radius, workpiece contour, system rigidity and chip control.
The larger the corner radius, the better the surface quality that can be achieved.

 Corner radius mm	 round insert \varnothing mm	Theoretical Ra / Rz values depending on the feed rate and corner radius						Feed ranges depending on corner radius and type of machining	
		Ra / Rz in μm						Medium machining to roughing	Finishing to medium machining
		0,4 / 1,6	1,6 / 6,3	3,2 / 12,5	6,3 / 25	8 / 32	32 / 100	Feed f in mm	
0,2		0,05	0,08	0,13					0,04–0,15
0,4		0,07	0,11	0,17	0,22				0,07–0,22
0,8		0,10	0,15	0,24	0,30	0,38		0,25–0,60	0,10–0,30
1,2			0,19	0,29	0,37	0,47		0,35–0,85	0,20–0,40
1,6				0,34	0,43	0,54	1,08	0,40–1,00	
2,4				0,42	0,53	0,66	1,32	0,50–1,20	
	6	0,20	0,31	0,49	0,62				0,20–0,60
	8	0,23	0,36	0,56	0,72				0,23–0,70
	10	0,25	0,40	0,63	0,80	1,00			0,25–0,80
	12		0,44	0,69	0,88	1,10		0,40–0,80	
	16		0,51	0,80	1,01	1,26	2,54	0,50–1,00	
	20			0,89	1,13	1,42	2,94	0,60–1,25	
	25				1,26	1,58	3,33	0,70–1,50	

Usage information: Vibration tendency

Vibration occurs when machining long, small diameter components or during internal machining with long overhang boring bars. This is particularly the case if $L/D > 4$.

As far as tool selection is concerned, the following parameters must be noted for reducing the risk of vibration.

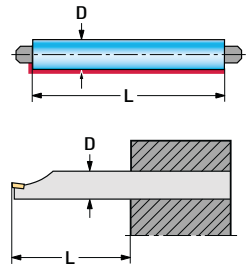

	Vibration tendency		
1. Basic insert shape	 Positive	 Negative, double-sided	 Negative, single-sided
2. Insert shape	 35°	 80°	
3. Clearance angle	 91°	 75°	 45°
4. Corner radius	 R = 0,2	 R = 0,4	 R = 0,8-1,2
5. Effective rake angle			
6. Coating	 uncoated	 PVD	 CVD

Once the tool / insert has been selected, other factors are decisive for reducing vibration:

1. Clamp tools and boring bars at the shortest length possible.
2. Select cutting depth 0.1 mm greater than the corner radius of the insert.
3. If vibration occurs, reduce cutting speed by 50–70 % in relation to the specified catalogue values.
4. Check clamping pressure at tail stock spindle during external machining.

Usage information: Walter Turn turning tools – effective rake angle

The effective rake angle of a tooling system is determined by the insert geometry and the inclination of the insert in the toolholder.

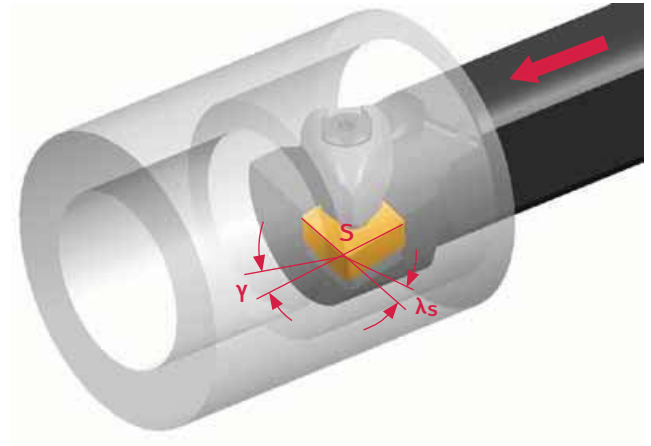
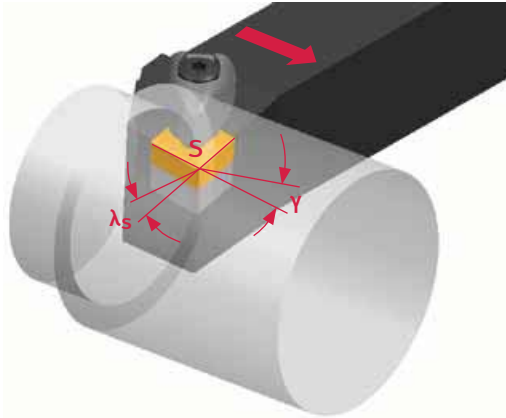

λ_s (inclination angle) The angle is tilted around the corner cutting edge (S) parallel to the main cutting edge.

γ (rake angle) This is the angle at right angles to the main cutting edge, measured with a smooth insert without chip breaker groove. In order to obtain the effective rake angle of the tooling system, the rake angle of the insert must also be taken into consideration.

Walter Capto™ – boring operations with turning toolholders for external machining

Walter Capto™ tools for external machining can also be used for internal machining of large diameters. This often takes place on mill-turn centres or automatic lathes.

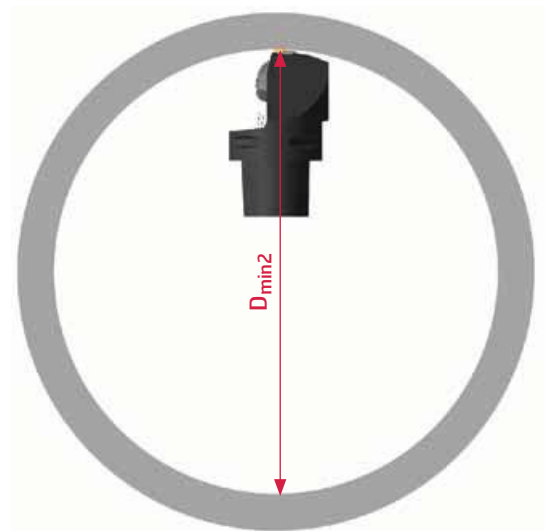
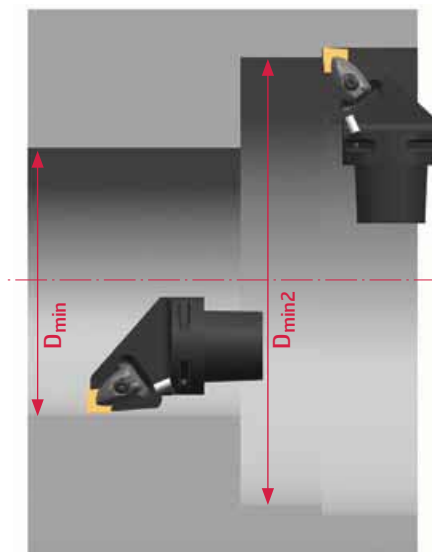
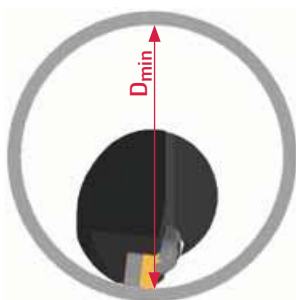

D_{min} Minimum internal machining diameter. Toolholder parallel to rotation axis.

D_{min2} Minimum internal machining diameter. Toolholder 90° at an angle in relation to the rotation axis.



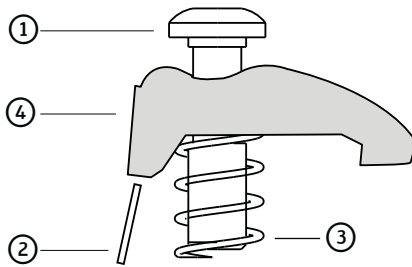
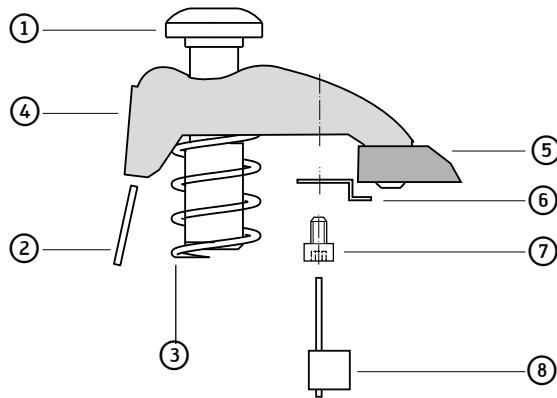

Usage information: Assembly parts and accessories for the Walter Turn rigid clamping system

Standard clamp

Strengthened clamp with carbide shoe

Basic shape and size of indexable insert	Standard clamp						Reinforced clamp with carbide shoe	
			CN 12 ..	CN 16 ..	CN 19 ..		CN 12 ..	CN 16 ..
	DN 11 ..		DN 15 ..	DN 15 ..			DN 15 ..	DN 15 ..
				SN 15 ..	SN 19 ..	SN 25 ..		SN 15 ..
	TN 16 ..		TN 22 ..				TN 22 ..	
		VN 16 ..						
	WN 06 ..		WN 08 ..	WN 10 ..			WN 08 ..	WN 10 ..
Set	PK 240-Set	PK 244-Set	PK 241-Set	PK 242-Set	PK 243-Set	PK 301-Set	PK 245-Set	PK 246-Set
① Clamp screw	FS 1472 (9 IP)	FS 1473 (15 IP)	FS 1473 (15 IP)	FS 1474 (20 IP)	FS 1474 (20 IP)	FS 1589 (25 IP)	FS 1473 (15 IP)	FS 1474 (20 IP)
② Pin (mounted in toolholder)	RS 116	RS 117	RS 117	RS 117	RS 117	RS 117	RS 117	RS 117
③ Pressure spring	FS 1469	FS 1470	FS 1470	FS 1471	FS 1471	FS 1590	FS 1470	FS 1471
④ Clamp	PK 240	PK 244	PK 241	PK 242	PK 243	PK 301	PK 245	PK 246
⑤ Carbide clamping plate							FK 371	FK 372
⑥ Clip for clamping plate							FK 373	FK 373
⑦ Screw for clamping plate							FS 1492	FS 1492
⑧ Key for clamping plate / clip screw							FS 1490 (7 IP)	FS 1490 (7 IP)

Usage information: Coolant nozzles and coolant adapters

Coolant nozzles – Walter Capto™

		Capto sizes		
		C3 + C4	C5 + C6	C6 + C 8
	Standard coolant nozzle up to 30 bar	FS 1477	FS 1476	FS 1479
	Brass high-pressure coolant nozzle up to 80 bar	FS 1477HP	FS 1476HP	FS 1479HP
	Inserts for changing the nozzles	FS 1477HEX (SW5)	FS 1476HEX (SW5)	FS 1479HEX (SW5)
	Key for insert	FS 2158 (SW5)	FS 2158 (SW5)	FS 2158 (SW5)

Please note:

A different coolant nozzle is installed in certain Walter Capto™ tools (C3–C8) than the one specified in the table above. This detailed information can be found on the relevant tool page.

Coolant adaptor K600 for Walter Turn boring bars with screw or rigid clamping system

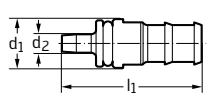



Designation	d ₁ mm	l ₁ mm	d ₂ mm
 K600.06.25.054	6	25	5,4
K600.08.28.066	8	28	6,6
K600.10.28.086	10	28	8,6
K600.12.38.086	12	38	8,6
K600.16.40.137	16	40	13,7
K600.20.40.137	20	40	13,7
K600.25.44.137	25	44	13,7

Comment: d₁ corresponds to the shank diameter of the boring bar.

Please note:

Coolant adapters can be cut off if necessary, approx. 3 mm after the O-ring. This makes shorter clamping possible when using the boring bar and coolant adapter in a Walter Capto™ or VDI boring bar holder. Furthermore, the escape of coolant via the clamping surface is avoided, and a higher pressure is also available for the internal supply of coolant.

Cutting data for Walter Cut – grooving and recessing Carbide grades

Material group	Structure of main material groups and identification letters		Brinell hardness HB	Tensile strength R _m N/mm ²	Machining group ¹			
	 = Cutting data for wet machining  = Dry machining is possible							
P	Unalloyed steel	C ≤ 0,25 %	annealed	125	428	P1	●●	●
		C > 0,25... ≤ 0,55 %	annealed	190	639	P2	●●	●
		C > 0,25... ≤ 0,55 %	tempered	210	708	P3	●●	●
		C > 0,55 %	annealed	190	639	P4	●●	●
		C > 0,55 %	tempered	300	1013	P5	●●	●
		Free cutting steel (short-chipping)	annealed	220	745	P6	●●	●
	Low-alloyed steel		annealed	175	591	P7	●●	●
			tempered	300	1013	P8	●●	●
			tempered	380	1282	P9	●●	●
			tempered	430	1477	P10	●●	●
	High-alloyed steel and high-alloyed tool steel		annealed	200	675	P11	●●	●
			hardened and tempered	300	1013	P12	●●	●
			hardened and tempered	400	1361	P13	●●	●
	Stainless steel		ferritic / martensitic, annealed	200	675	P14	●●	●
			martensitic, tempered	330	1114	P15	●●	●
M	Stainless steel		austenitic, quench hardened	200	675	M1	●●	●
			austenitic, precipitation hardened (PH)	300	1013	M2	●●	●
			austenitic / ferritic, duplex	230	778	M3	●●	●
K	Malleable cast iron		ferritic	200	675	K1	●●	●
			pearlitic	260	867	K2	●●	●
	Grey cast iron		low tensile strength	180	602	K3	●●	●
			high tensile strength / austenitic	245	825	K4	●●	●
	Cast iron with spheroidal graphite		ferritic	155	518	K5	●●	●
			pearlitic	265	885	K6	●●	●
	GGV (CGI)		200	675	K7	●●	●	
N	Aluminium wrought alloys		cannot be hardened	30	–	N1	●●	●
			hardenable, hardened	100	343	N2	●●	●
	Cast aluminium alloys		≤ 12 % Si, cannot be hardened	75	260	N3	●●	●
			≤ 12 % Si, hardenable, hardened	90	314	N4	●●	●
			> 12 % Si, cannot be hardened	130	447	N5		
	Magnesium alloys			70	250	N6		
		Copper and copper alloys (bronze / brass)		unalloyed, electrolytic copper	100	343	N7	●●
			Brass, bronze, red brass	90	314	N8	●●	●
	Cu-alloys, short-chipping		110	382	N9	●●	●	
	high-strength, Ampco		300	1013	N10			
S	Heat-resistant alloys	Fe-based	annealed	200	675	S1	●●	●
			hardened	280	943	S2	●●	●
		Ni or Co base	annealed	250	839	S3	●●	●
			hardened	350	1177	S4	●●	●
			cast	320	1076	S5	●●	●
	Titanium alloys		Pure titanium	200	675	S6	●●	●
			α and β alloys, hardened	375	1262	S7	●●	●
			β alloys	410	1396	S8	●●	●
		Tungsten alloys		300	1013	S9		
		Molybdenum alloys		300	1013	S10		
H	Hardened steel		hardened and tempered	50 HRC	–	H1		
			hardened and tempered	55 HRC	–	H2		
			hardened and tempered	60 HRC	–	H3		
	Hardened cast iron		hardened and tempered	55 HRC	–	H4		
O	Thermoplasts		without abrasive fillers			O1		
	Thermosetting plastics		without abrasive fillers			O2		
	Plastic, glass-fibre reinforced		GFRP			O3		
	Plastic, carbon-fibre reinforced		CFRP			O4		
	Plastic, aramid fibre reinforced		AFRP			O5		
	Graphite (technical)			80 Shore		O6		

- Recommended application (the specified cutting data are regarded as starting values for the recommended application).
- Possible application.

¹ The machining groups are assigned from H 8 onwards.

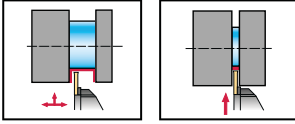

The specified cutting data are average recommended values. For special applications, adjustment is recommended.

Cutting material grades										
Starting values for cutting speed v_c [m/min]										
	HC								HW	
	WPP23	WSM23	WSM33	WSP43	WTA33	WAM20	WXM33	WAK20	WAK30	WK1
	200	190	180	170	190		180	190	180	
	180	170	170	160	180		180	180	170	
	170	160	150	140	160		160	170	160	
	180	180	170	160	180		180	180	170	
	150	150	140	130	120		100	160	150	
	180	180	170	160	180		180	180	170	
	180	180	160	150	180		160	180	160	
	150	150	110	100	150		130	160	150	
	150	150	100	100	130		90	150	130	
								80	60	
	130	130	120	110	180		100	180	160	
	110	110	90	80	140			160	140	
								80	60	
		180	160	140	180	180	170	200	180	
		100	80	60	100	110	80	130	110	
		170	150	130	150	160	140			
		100	80	60	100	110	80	130	110	
		150	130	110	130	140	120			
	190	180	170		100			160	140	
	170	160	150		60			130	100	
	250	220	220		260			350	330	
	210	190	180		210			310	290	
	220	210	200		240			300	280	
	180	170	160		190			260	240	
	200							220	180	
										900
										600
										350
										250
										400
										300
										200
		100	90	80						
		50	40	30						
		80	70	60						
		70	60	50						
		70	60	50						
		150	130	120						
		40	35	30						
		30	25							

HC = Coated carbide
HW = Uncoated carbide

Cutting data for Walter Cut – parting off Carbide grades

Material group	Structure of main material groups and identification letters		Brinell hardness HB	Tensile strength R _m N/mm ²	Machining group ¹			
	= Cutting data for wet machining = Dry machining is possible							
P	Unalloyed steel	C ≤ 0,25 %	annealed	125	428	P1	●●	●
		C > 0,25... ≤ 0,55 %	annealed	190	639	P2	●●	●
		C > 0,25... ≤ 0,55 %	tempered	210	708	P3	●●	●
		C > 0,55 %	annealed	190	639	P4	●●	●
		C > 0,55 %	tempered	300	1013	P5	●●	●
		Free cutting steel (short-chipping)	annealed	220	745	P6	●●	●
	Low-alloyed steel		annealed	175	591	P7	●●	●
			tempered	300	1013	P8	●●	●
			tempered	380	1282	P9	●●	●
			tempered	430	1477	P10		
	High-alloyed steel and high-alloyed tool steel		annealed	200	675	P11	●●	●
			hardened and tempered	300	1013	P12	●●	●
			hardened and tempered	400	1361	P13		
	Stainless steel		ferritic / martensitic, annealed	200	675	P14	●●	●
			martensitic, tempered	330	1114	P15	●●	●
M	Stainless steel	austenitic, quench hardened	200	675	M1	●●	●	
		austenitic, precipitation hardened (PH)	300	1013	M2	●●	●	
		austenitic / ferritic, duplex	230	778	M3	●●	●	
K	Malleable cast iron	ferritic	200	675	K1	●●	●	
		pearlitic	260	867	K2	●●	●	
	Grey cast iron	low tensile strength	180	602	K3	●●	●	
		high tensile strength / austenitic	245	825	K4	●●	●	
	Cast iron with spheroidal graphite	ferritic	155	518	K5	●●	●	
		pearlitic	265	885	K6	●●	●	
	GGV (CGI)		200	675	K7	●●	●	
N	Aluminium wrought alloys	cannot be hardened	30	–	N1	●●	●	
		hardenable, hardened	100	343	N2	●●	●	
	Cast aluminium alloys	≤ 12 % Si, cannot be hardened	75	260	N3	●●	●	
		≤ 12 % Si, hardenable, hardened	90	314	N4	●●	●	
		> 12 % Si, cannot be hardened	130	447	N5			
	Magnesium alloys		70	250	N6			
	Copper and copper alloys (bronze / brass)	unalloyed, electrolytic copper	100	343	N7	●●	●	
		Brass, bronze, red brass	90	314	N8	●●	●	
Cu-alloys, short-chipping		110	382	N9	●●	●		
high-strength, Ampco		300	1013	N10				
S	Heat-resistant alloys	Fe-based	annealed	200	675	S1	●●	●
			hardened	280	943	S2	●●	●
		Ni or Co base	annealed	250	839	S3	●●	●
			hardened	350	1177	S4	●●	●
			cast	320	1076	S5	●●	●
	Titanium alloys	Pure titanium	200	675	S6	●●	●	
		α and β alloys, hardened	375	1262	S7	●●	●	
		β alloys	410	1396	S8	●●	●	
	Tungsten alloys		300	1013	S9			
	Molybdenum alloys		300	1013	S10			
H	Hardened steel	hardened and tempered	50 HRC	–	H1			
		hardened and tempered	55 HRC	–	H2			
		hardened and tempered	60 HRC	–	H3			
Hardened cast iron	hardened and tempered	55 HRC	–	H4				
O	Thermoplasts	without abrasive fillers			O1			
	Thermosetting plastics	without abrasive fillers			O2			
	Plastic, glass-fibre reinforced	GFRP			O3			
	Plastic, carbon-fibre reinforced	CFRP			O4			
	Plastic, aramid fibre reinforced	AFRP			O5			
	Graphite (technical)		80 Shore		O6			

- Recommended application (the specified cutting data are regarded as starting values for the recommended application).
- Possible application.

¹ The machining groups are assigned from H 8 onwards.

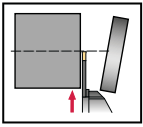

The specified cutting data are average recommended values.
For special applications, adjustment is recommended.

Cutting material grades							
Starting values for cutting speed v_c [m/min]							
HC						HW	
WPP23	WSM23	WSM33	WSP43	WAM20	WXM33	WK1	
190	180	170	160		170		
170	160	160	150		170		
160	150	140	130		150		
170	170	160	150		170		
140	140	130	120		90		
170	170	160	150		170		
170	170	150	140		150		
140	140	100	90		120		
140	140	90	90		80		
120	120	110	100		90		
100	100	80	70				
	170	150	130	170	160		
	90	70	50	100	70		
	160	140	120	150	130		
	90	70	50	100	70		
	140	120	100	130	110		
180	170	160					
160	150	140					
230	220	210					
190	180	170					
210	200	190					
170	160	150					
190							
							900
							600
							350
							250
							400
							300
							200
	90	80		70			
	40	30		20			
	70	60		50			
	60	50		40			
	60	50		40			
	140	130		120			
	40	30		25			
	35	25		20			

HC = Coated carbide
HW = Uncoated carbide

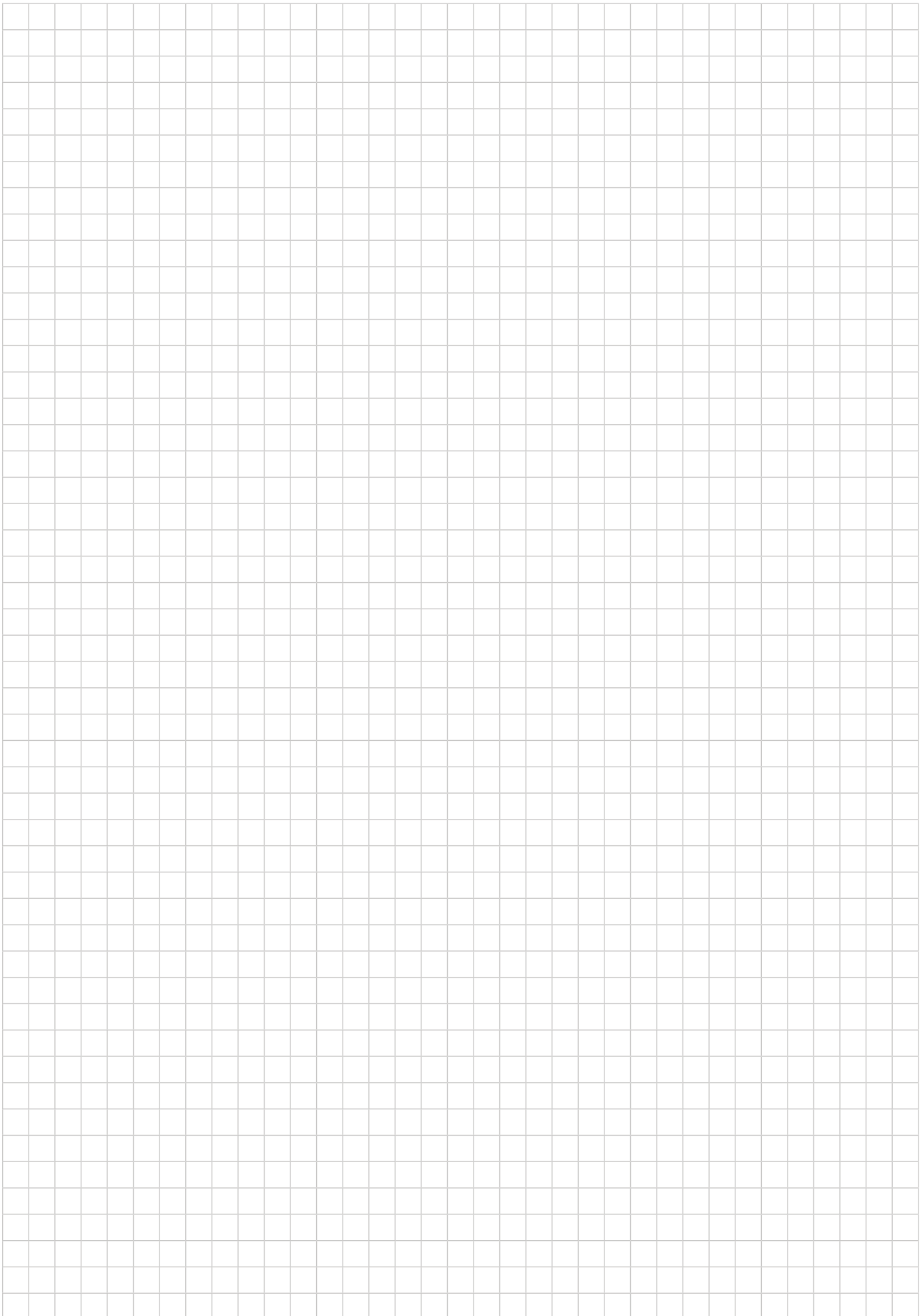









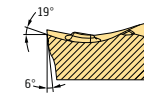

Cutting material application tables – grooving

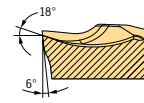

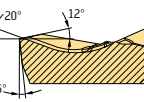
Walter grade designation	Standard designation	Workpiece material group							Application range							Coating procedure	Coating structure	Indexable insert example							
		P	M	K	N	S	H	O	01	10	20	30	40	05	15				25	35	45				
		Steel	Stainless steel	Cast iron	NF metals	Difficult-to-machine materials	Hard materials	Other																	
WPP 23	HC – P 20	●●																		CVD	TiCN + Al ₂ O ₃ (+TiN)				
	HC – K 30			●																					
WSM 23	HC – M 20		●●																	PVD	TiAlN + Al ₂ O ₃ (ZrCN)				
	HC – S 20					●●																			
	HC – P 20	●●																							
WSM 33	HC – S 30					●●														PVD	TiAlN + Al ₂ O ₃ (ZrCN)				
	HC – M 30		●●																						
	HC – P 35	●●																							
WSP 43	HC – S 45					●●														PVD	TiAlN + Al ₂ O ₃ (ZrCN)				
	HC – P 45	●●																							
	HC – M 45		●●																						
WAM 20	HC – M 20		●●																	CVD	TiCN + Al ₂ O ₃ + HfN				
	HC – S 20					●																			
WXM 33	HC – M 35		●●																	PVD	Multilayer TiAlN / TiN + ZrCN				
	HC – P 40	●																							
WAK 20	HC – K 20			●●																CVD	TiCN + Al ₂ O ₃ (+TiN)				
	HC – H 10							●																	
WAK 30	HC – K 30			●●																CVD	TiCN + Al ₂ O ₃ (+TiN)				
	HC – P 40	●																							
WK 1	HW – N 10				●●															-	-				
	HW – S 10					●																			
WTA 33	HC – P 10	●●																		CVD	TiCN + Al ₂ O ₃				
	HC – K 10			●																					

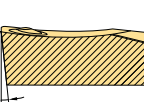
HC = Coated carbide
HW = Uncoated carbide

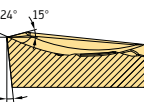
●● Primary application
● Other application



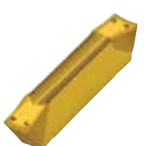
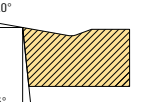



Geometry overview of inserts

GX system grooving and parting off													
Geometry	Remarks / field of applications	Workpiece material group						Section Main cutting edge	View Main cutting edge	s [mm]	f [mm]		
		P	M	K	N	S	H				O	min	max
 <p>CF6 – Low feeds – Minimal burr / pip at centre – Low cutting force</p>		Steel	Stainless steel	Cast iron	NF metals	Difficult-to-machine materials	Hard materials	Other			1,5	0,03	0,10
											2	0,03	0,12
											2,5	0,03	0,15
											3	0,04	0,20
 <p>CF5 – Grooving and parting off operations – Light to moderate feeds – Good chip control – Minimal burr / pip at centre</p>		Steel	Stainless steel	Cast iron	NF metals	Difficult-to-machine materials	Hard materials	Other			2	0,06	0,15
											2,5	0,07	0,18
											3	0,08	0,20
											4	0,10	0,22
											5	0,10	0,25
 <p>CE4 – Grooving and parting off operations – Moderate to high feeds – Excellent chip formation – Stable cutting edge</p>		Steel	Stainless steel	Cast iron	NF metals	Difficult-to-machine materials	Hard materials	Other			2	0,04	0,15
											2,5	0,05	0,15
											3	0,09	0,30
											4	0,10	0,32
											5	0,12	0,35
 <p>GD3 – Extremely soft cutting action – Light to moderate feeds – General parting off and grooving operations</p>		Steel	Stainless steel	Cast iron	NF metals	Difficult-to-machine materials	Hard materials	Other			2	0,04	0,12
											2,5	0,04	0,14
											3	0,06	0,18
											4	0,10	0,20
											5	0,12	0,25
 <p>GD6 – Medium feed rates – Long-chipping materials – Medium machining conditions</p>		Steel	Stainless steel	Cast iron	NF metals	Difficult-to-machine materials	Hard materials	Other			2	0,04	0,12
											2,5	0,06	0,17
											3	0,08	0,18
											4	0,10	0,22
											5	0,12	0,24
6	0,14	0,30											

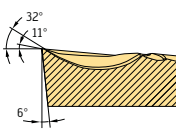

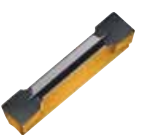
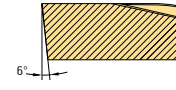

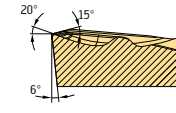

GX system, grooving of circlip grooves													
Geometry	Remarks / field of applications	Workpiece material group						Section Main cutting edge	View Main cutting edge	s [mm]	f [mm]		
		P	M	K	N	S	H				O	min	max
 <p>Inserts for circlip grooves – Excellent surface quality – All common circlip types – Minimal burr formation</p>		Steel	Stainless steel	Cast iron	NF metals	Difficult-to-machine materials	Hard materials	Other			0,6-1,99	0,05	0,10
											2-2,99	0,05	0,12
											3-3,99	0,07	0,14
											4-4,99	0,07	0,20
											5-5,99	0,08	0,20

●● Primary application
● Other application

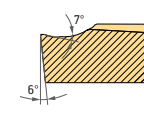
GX system, grooving, parting off and recessing

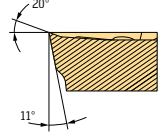
Geometry	Remarks / field of applications	Workpiece material group							Section Main cutting edge	View Main cutting edge	s [mm]	a _p [mm]		f [mm]	
		P Steel	M Stainless steel	K Cast iron	N NF metals	S Difficult-to-machine materials	H Hard materials	O Other				min	max	min	max
 <p>UF4 – All grooving operations – Good chip control – Average feed range – Positive cut</p>		●●	●●	●●		●				2	0,30	2,50	0,10	0,15	
										2,5	0,30	2,50	0,10	0,18	
										3	0,40	3,00	0,10	0,20	
										4	0,50	3,50	0,10	0,30	
										5	0,50	3,50	0,12	0,35	
										6	0,60	4,00	0,14	0,40	
 <p>UA4 – For cast iron machining – For middle to high machining parameters – For extremely high level of process reliability in cast iron machining</p>				●●		●			2	0,30	2,50	0,08	0,15		
									2,5	0,30	2,50	0,10	0,20		
									3	0,40	3,00	0,10	0,22		
									4	0,50	3,50	0,10	0,35		
									5	0,50	3,00	0,12	0,35		
									6	0,60	3,50	0,14	0,40		
 <p>UD6 – Grooving in rust-resistant steel – Average feed range – Soft cutting action</p>		●	●●						2	0,30	2,50	0,06	0,15		
									2,5	0,30	2,50	0,08	0,14		
									3	0,40	3,00	0,10	0,20		
									4	0,50	3,50	0,12	0,25		
									5	0,50	3,00	0,12	0,30		
									6	0,60	3,50	0,14	0,35		

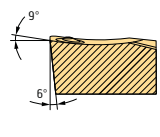
GX System, full radius inserts

Geometry	Remarks / field of applications	Workpiece material group							Section Main cutting edge	View Main cutting edge	s [mm]	a _p [mm]		f [mm]	
		P Steel	M Stainless steel	K Cast iron	N NF metals	S Difficult-to-machine materials	H Hard materials	O Other				min	max	min	max
 <p>RD4 – For copy turning – Outstanding chip control during grooving – For moderate to high feeds</p>		●●	●	●●		●				3	1,50	0,08	0,35		
										4	2,00	0,10	0,40		
										5	2,50	0,12	0,50		
										6	3,00	0,15	0,60		
 <p>RK8 – Polished rake face – Sharp cutting edge – Fully ground circumference – Extremely positive</p>				●●		●			6	4,00	0,10	0,30			
									8	5,00	0,10	0,35			
 <p>R – Sharp cutting edge – Fully ground circumference – High surface quality</p>		●●	●						1,6	0,80	0,05	0,15			
									2	1,00	0,05	0,17			
									2,4	1,20	0,05	0,17			
									3	1,50	0,10	0,20			
									4	2,00	0,10	0,30			
									5	2,50	0,15	0,35			
6	3,00	0,15	0,40												

●● Primary application
 ● Other application



Geometry overview of inserts

(continued)

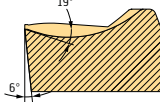
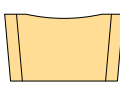



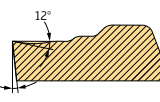

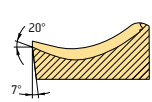

LX system, grooving, parting off and recessing

Geometry	Remarks / field of applications	Workpiece material group							Section Main cutting edge	View Main cutting edge	s [mm]	a _p [mm]		f [mm]	
		P Steel	M Stainless steel	K Cast iron	N NF metals	S Difficult-to-machine materials	H Hard materials	O Other				min	max	min	max
	UE4 – For grooving and recessing – Outstanding chip control – Moderate to high feeds	●●	●	●●		●					8	0,90	5,00	0,20	0,50

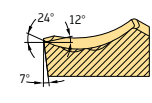
LX system, full radius inserts

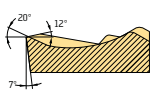
Geometry	Remarks / field of applications	Workpiece material group							Section Main cutting edge	View Main cutting edge	s [mm]	a _p [mm]		f [mm]	
		P Steel	M Stainless steel	K Cast iron	N NF metals	S Difficult-to-machine materials	H Hard materials	O Other				min	max	min	max
	RD3 – For copy turning – Stable cutting edge – For moderate to high feeds	●●	●	●●		●					8	4,00		0,15	0,50

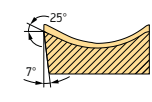
FX system, grooving and parting off

Geometry	Remarks / field of applications	Workpiece material group							Section Main cutting edge	View Main cutting edge	s [mm]	f [mm]	
		P Steel	M Stainless steel	K Cast iron	N NF metals	S Difficult-to-machine materials	H Hard materials	O Other				min	max
	CE6 – Light to moderate feeds – Long-chipping materials – Minimal pip at centre	●●	●●	●		●●				2,2	0,05	0,15	
										3,1	0,06	0,25	
										4,1	0,08	0,25	
	CD3 – Unfavourable machining conditions – Average feed range – Machining steel	●●	●●	●●					3,1	0,10	0,30		
									4,1	0,15	0,35		
	CE4 – Grooving and parting off operations – Moderate to high feeds – Excellent chip formation	●●	●	●●					2,2	0,05	0,15		
									3,1	0,09	0,30		
									4,1	0,10	0,32		
									5,1	0,12	0,35		
									6,5	0,12	0,40		
8,2	0,15	0,45											
9,7	0,15	0,50											
	CK8 – For small and moderate feeds – Polished rake face – Highly positive geometry				●●	●			2,2	0,05	0,10		
									3,1	0,05	0,15		
									4,1	0,05	0,20		

●● Primary application
 ● Other application

Usage information: Assembly instructions for Walter Cut

Walter Cut – the strong connection

The axial clamping with support face that occurs between the module and the basic holder when the clamping screws are tightened provides a backlash-free connection with maximum stability.

The graphics show the module in the clamped and unclamped condition, and the forces acting between the module and the tool.

Unclamped module

Gap between the module and the support face for axial clamping

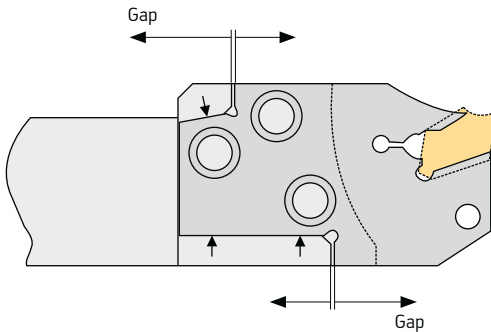

Clamped module

Axial clamping with support face
backlash-free connection ensuring maximum stability

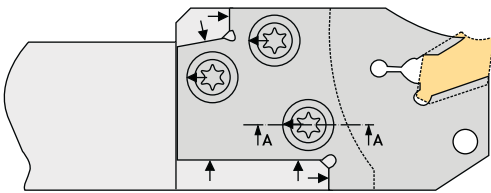

Clamping screw

Section A-A:
Clamping screw
with greater
clamping power

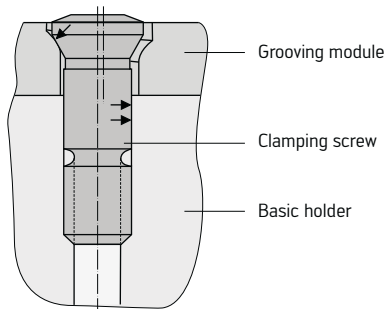

GX: for grooving and turning

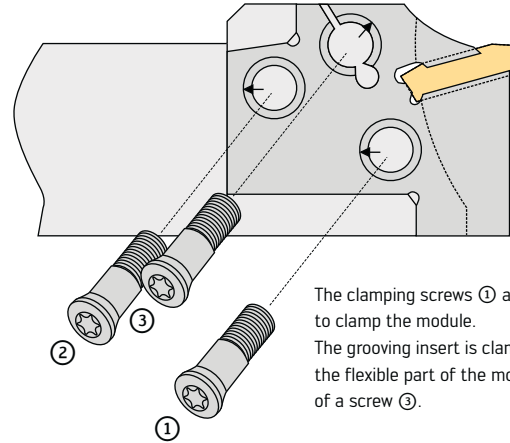

The clamping screws ① and ② are used to clamp the module.
The grooving insert is clamped through the flexible part of the module by means of a screw ③.

Important:

Observe the sequence for clamping the module.

Step	Operation	Screw no.
A	Pretension the module	1 – 2 (2 – 1)
B	Retension the module	1 – 2 (2 – 1)
C	Clamp the GX grooving insert	3

FX: for parting off and deep grooving

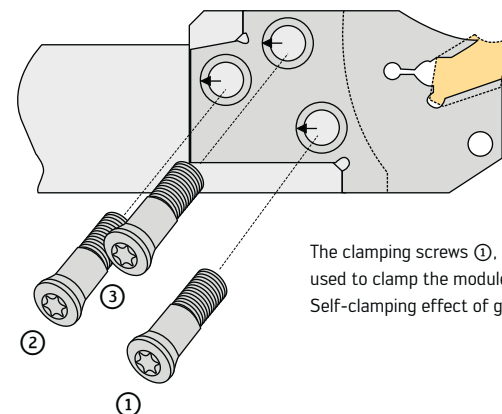

The clamping screws ①, ② and ③ are used to clamp the module.
Self-clamping effect of grooving insert.

Important:

Observe the sequence for clamping the module.

Step	Operation	Screw no.
A	Pretension the module	1 – 2 – 3
B	Retension the module	1 – 2 – 3
C	Clamp the FX grooving insert	Mounting wrench

Usage information: Replacing the cutting edge of Walter Cut tools

Installing GX inserts in G1042 parting blades

1. Insert the wrench



2. Open the clamp



3. Remove the old insert

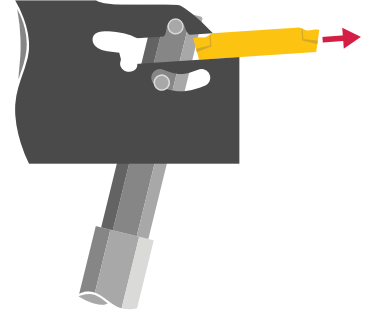

4. Insert the new insert

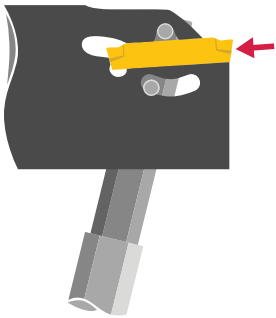

5. Close the clamp

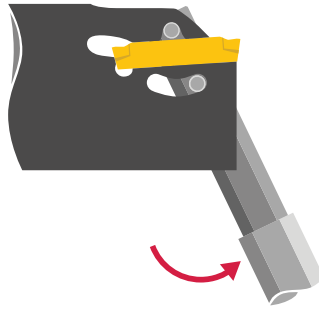

Mounting wrench FS 1494
must be ordered separately.



Installing FX inserts

Inserting the insert



Removing the insert

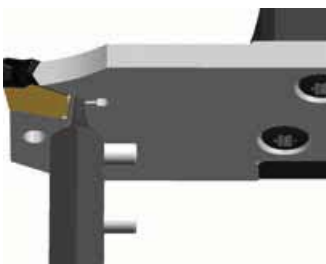

Mounting wrench	for size
FS 1493	FX 3,1–FX 6,5
FS 1494	FX 2,2

Mounting wrench must be ordered separately.

Usage information: Walter Cut tool standard / contra version

G1041 / G1041 ... -C

Right-hand version



Standard

Example: G1041.32R-3T32GX24



Contra

Example: G1041.32R-3T32GX24C

Left-hand version



Standard

Example: G1041.32L-3T32GX24



Contra

Example: G1041.32L-3T32GX24

XLDE / XLDE ... -C

Right-hand version



Standard

Example: XLDER1616K-GX16-2



Contra

Example: XLDER1616K-GX16-2C

Left-hand version



Standard

Example: XLDEL1616K-GX16-2



Contra

Example: XLDEL1616K-GX16-2C

NCFE / NCFE ... -C

Right-hand version



Standard

Example: NCFE25-2525R-GX24-4-3



Contra

Example: NCFE25-2525R-GX24-4-3C

Left-hand version

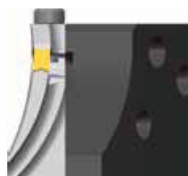

Standard

Example: NCFE25-2525L-GX24-4-3



Contra

Example: NCFE25-2525L-GX24-4-3C

Usage information: Groove depths depending on turning diameter

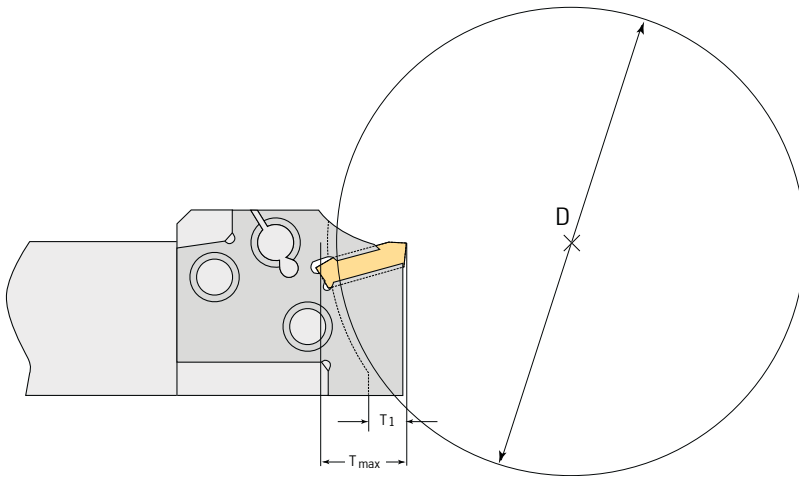

T_{max} = maximum cutting depth **depending**
on turning diameter D
 T_1 = groove depth **independent**
of turning diameter D

Groove depth T [mm]

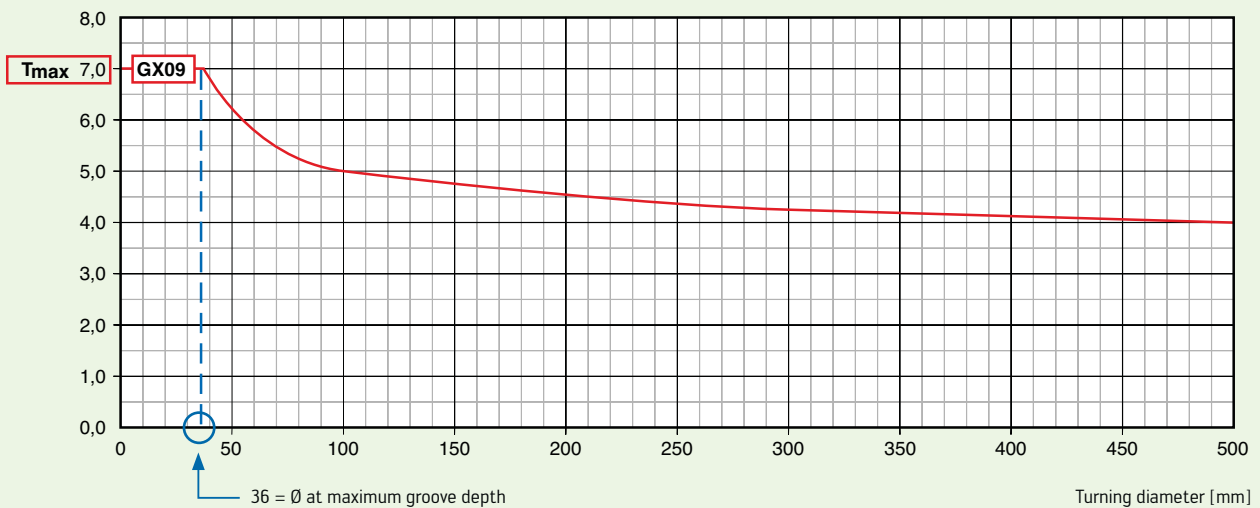
Module size MSS-E12 ..

Groove depth T [mm]

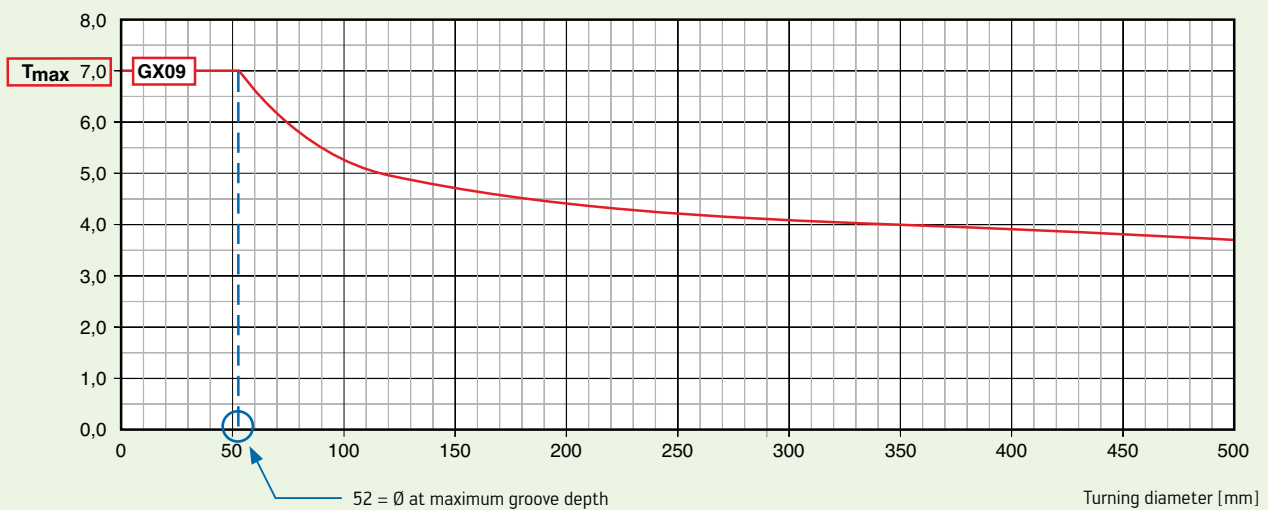
Module size MSS-E16 ...

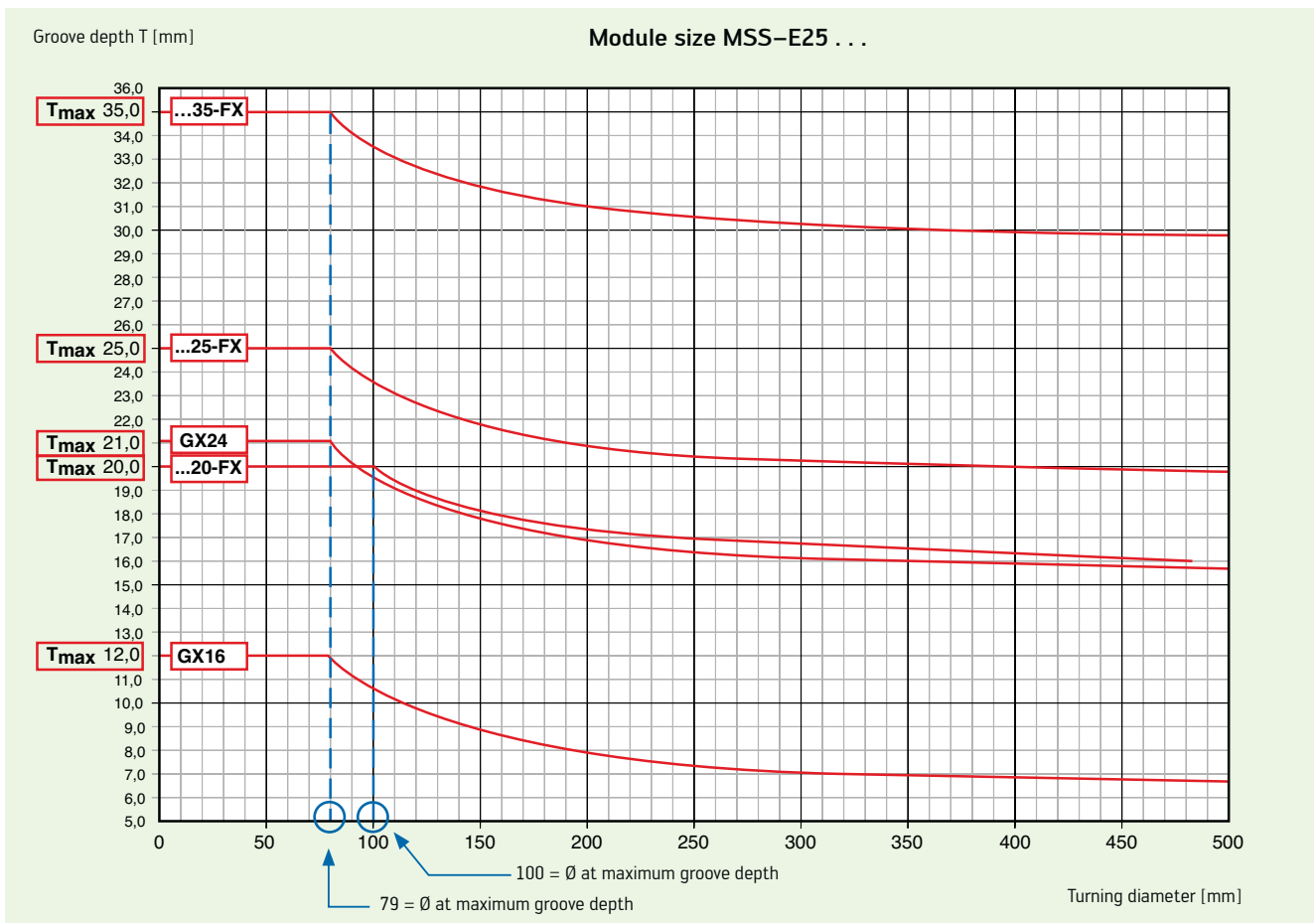
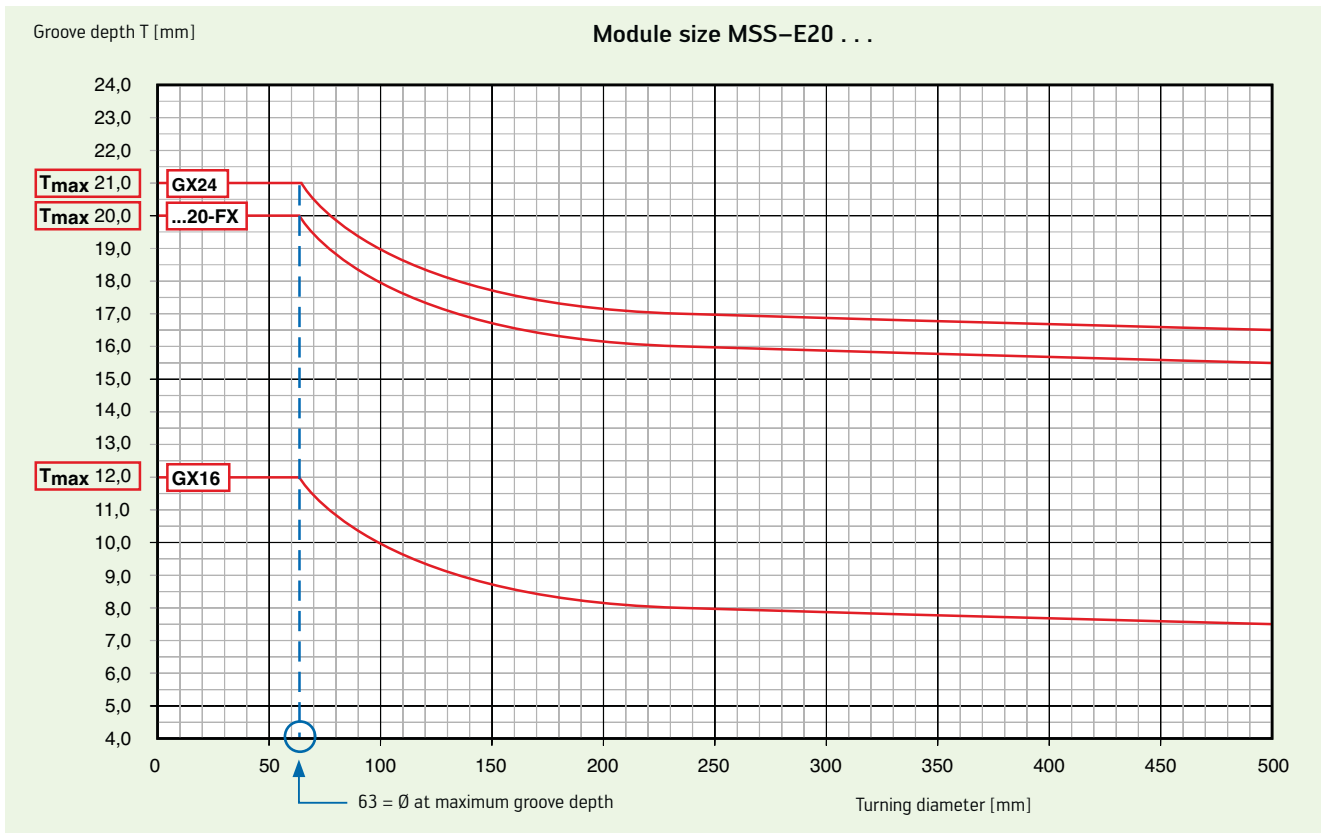

Application information: Groove depths dependent on turning diameter

(continued)

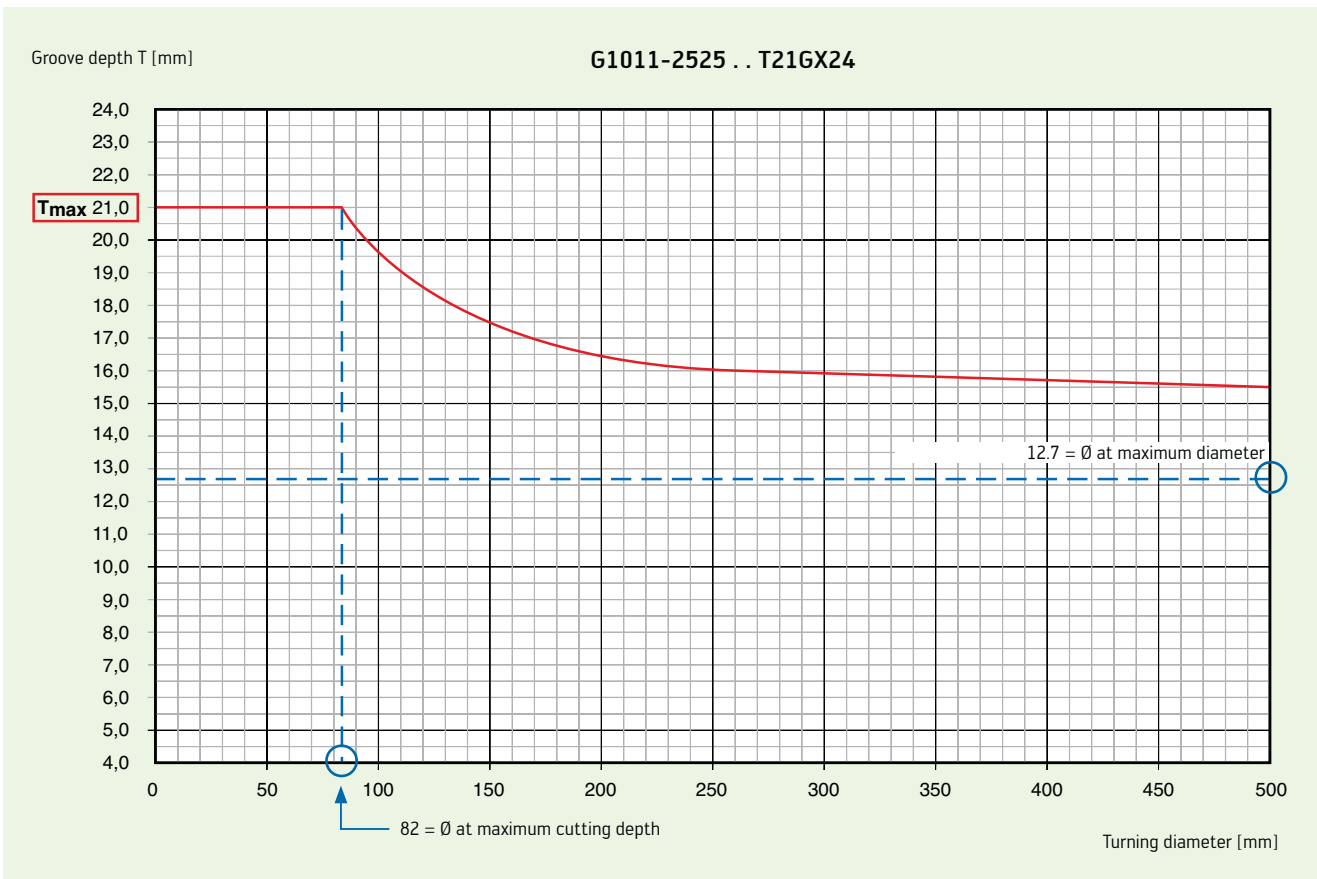
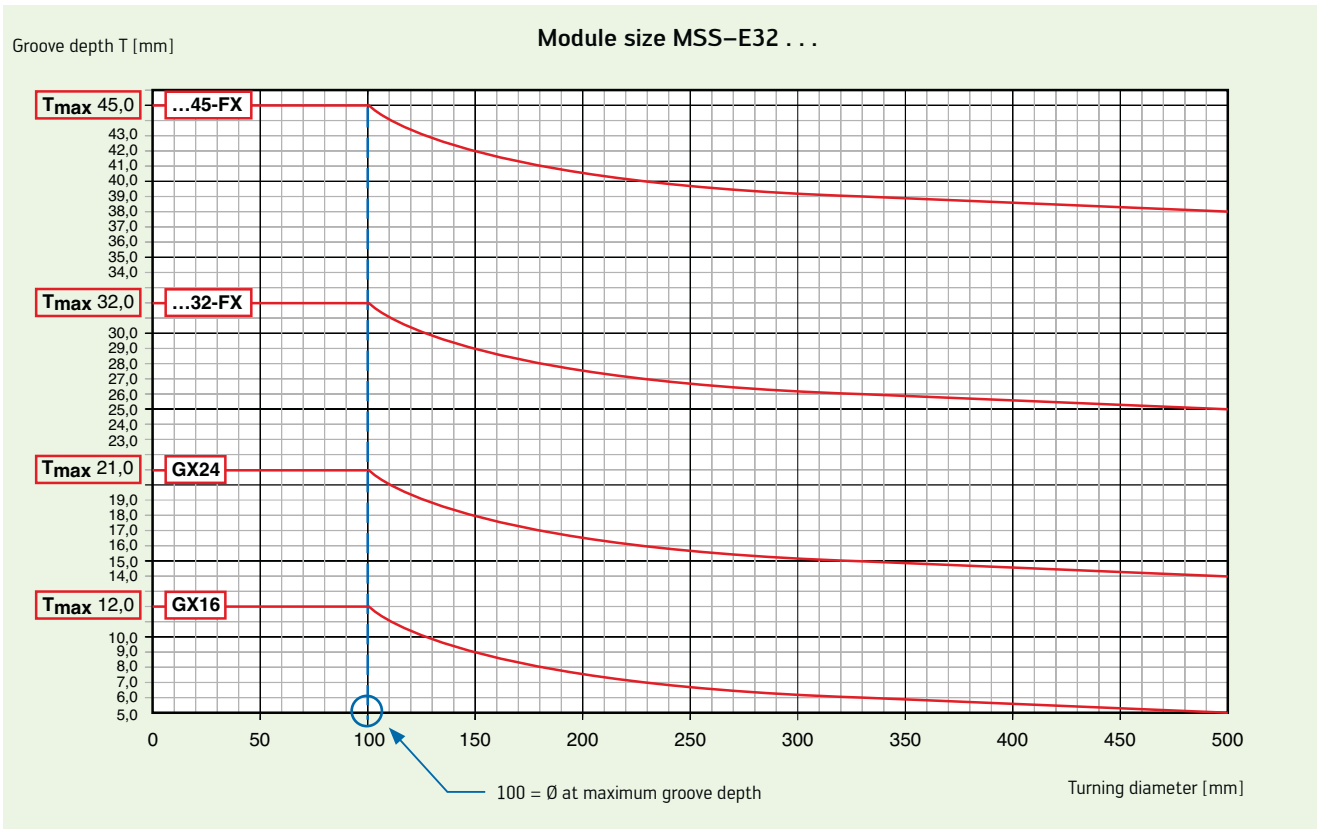

Cutting depth T [mm]

G1011-1616 .. T21GX24

G1011-2020 .. T21GX24

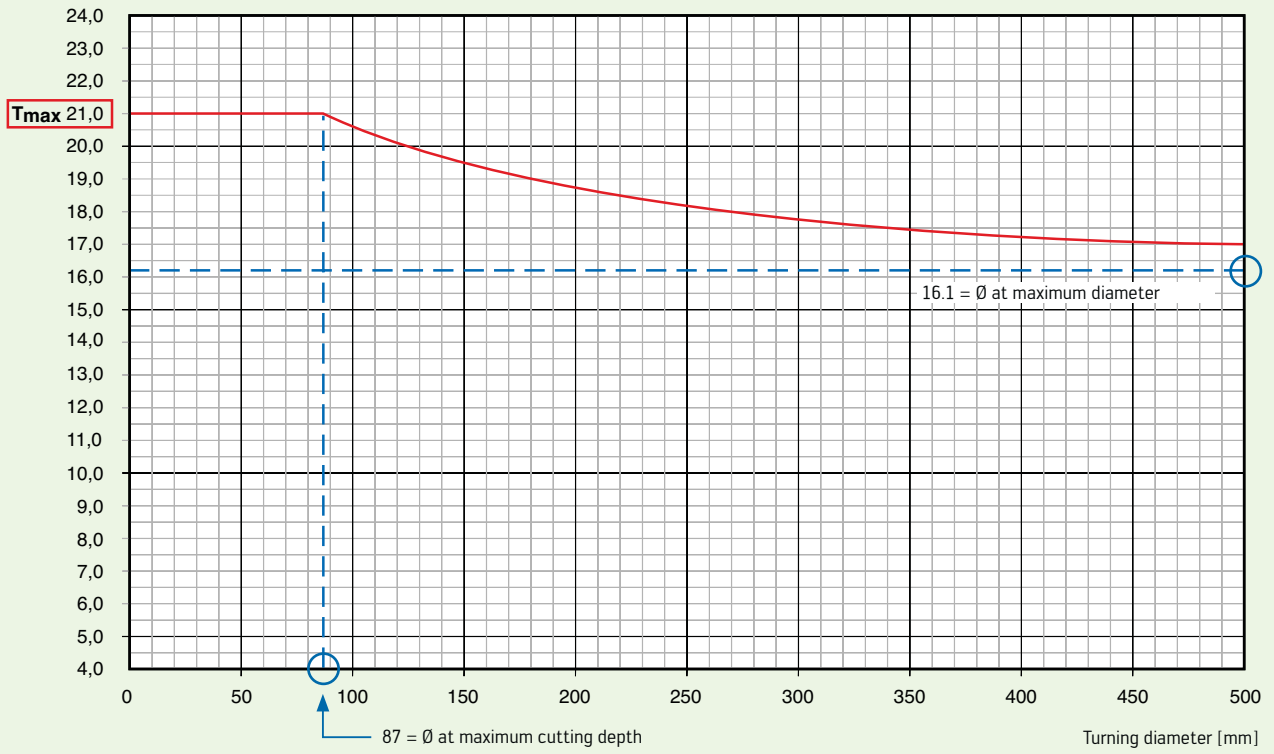

Cutting data for threading

Carbide grades

Material group	Structure of main material groups and identification letters		Brinell hardness HB	Tensile strength R _m N/mm ²	Machining group ¹				
	= Cutting data for wet machining = Dry machining is possible								
P	Unalloyed steel	C ≤ 0,25 %	annealed	125	428	P1	●●		
		C > 0,25... ≤ 0,55 %	annealed	190	639	P2	●●		
		C > 0,25... ≤ 0,55 %	tempered	210	708	P3	●●		
		C > 0,55 %	annealed	190	639	P4	●●		
		C > 0,55 %	tempered	300	1013	P5	●●		
		Free cutting steel (short-chipping)	annealed	220	745	P6	●●		
	Low-alloyed steel	annealed		175	591	P7	●●		
		tempered		300	1013	P8	●●		
		tempered		380	1282	P9	●●		
		tempered		430	1477	P10	●●		
	High-alloyed steel and high-alloyed tool steel	annealed		200	675	P11	●●		
		hardened and tempered		300	1013	P12	●●		
		hardened and tempered		400	1361	P13	●●		
	Stainless steel	ferritic / martensitic, annealed		200	675	P14	●●		
		martensitic, quenched and tempered		330	1114	P15	●●		
M	Stainless steel	austenitic, quench hardened		200	675	M1	●●		
		austenitic, precipitation hardened (PH)		300	1013	M2	●●		
		austenitic / ferritic, duplex		230	778	M3	●●		
K	Malleable cast iron	ferritic		200	675	K1	●●		
		pearlitic		260	867	K2	●●		
	Grey cast iron	low tensile strength		180	602	K3	●●		
		high tensile strength / austenitic		245	825	K4	●●		
	Cast iron with spheroidal graphite	ferritic		155	518	K5	●●		
GGV (CGI)	pearlitic		265	885	K6	●●			
N	Aluminium wrought alloys	cannot be hardened		30	-	N1	●●		
		hardenable, hardened		100	343	N2	●●		
	Cast aluminium alloys	≤ 12 % Si, cannot be hardened		75	260	N3	●●		
		≤ 12 % Si, hardenable, hardened		90	314	N4	●●		
		> 12 % Si, cannot be hardened		130	447	N5			
	Magnesium alloys				70	250	N6		
	Copper and copper alloys (bronze / brass)	unalloyed, electrolytic copper		100	343	N7	●●		
Brass, bronze, red brass		90	314	N8	●●				
Cu-alloys, short-chipping		110	382	N9	●●				
high-strength, Ampco		300	1013	N10					
S	Heat-resistant alloys	Fe-based	annealed	200	675	S1			
			hardened	280	943	S2			
		Ni or Co base	annealed	250	839	S3			
			hardened	350	1177	S4			
			cast	320	1076	S5			
	Titanium alloys	Pure titanium		200	675	S6			
		α and β alloys, hardened		375	1262	S7			
		β alloys		410	1396	S8			
Tungsten alloys				300	1013	S9			
Molybdenum alloys				300	1013	S10			
H	Hardened steel	hardened and tempered		50 HRC	-	H1			
		hardened and tempered		55 HRC	-	H2			
		hardened and tempered		60 HRC	-	H3			
	Hardened cast iron	hardened and tempered		55 HRC	-	H4			
O	Thermoplasts		without abrasive fillers				O1		
	Thermosetting plastics		without abrasive fillers				O2	●	
	Plastic, glass-fibre reinforced		GFRP				O3		
	Plastic, carbon-fibre reinforced		CFRP				O4		
	Plastic, aramid fibre reinforced		AFRP				O5		
	Graphite (technical)				80 Shore		O6		

- Recommended application (the specified cutting data are regarded as starting values for the recommended application).
- Possible application.

¹ The machining groups are assigned from H 8 onwards.

The specified cutting data are average recommended values.
For special applications, adjustment is recommended.

Cutting material grades							
Starting values for cutting speed v_c [m/min]							
Lead [mm]	HC						Lead [TPI]
	WXP20		WXM20		WMP32		
	0.5-1.25	1.5-3.0	0.5-1.25	1.5-6.0	0.5-1.25	1.5-6.0	
	48-19	18-10	48-19	18-5	48-19	18-10	
	200	240			180	215	
	180	200			160	180	
	150	180			135	160	
	160	180			145	160	
	80	100			70	90	
	180	220			160	200	
	150	170			135	155	
	80	120			70	110	
	60	80			55	70	
	50	65			45	60	
	90	100			80	90	
	50	60			45	55	
	50	65			45	60	
	110	130	150	180	100	115	
	40	50	120	150	35	45	
			180	220	180	220	
			60	70	60	70	
			150	190	150	190	
	100	120			90	110	
	80	100			70	90	
	170	200			155	180	
	120	150			110	135	
	100	120			90	110	
	80	90			70	80	
			350	400			
			250	300			
			380	400			
			270	320			
			220	250			
			220	250			
			180	200			
			220	250			

HC = Coated carbide

Cutting material usage tables – threading

Walter grade designation	Standard designation	Workpiece material group							Application range							Coating procedure	Coating structure	Indexable insert example				
		P	M	K	N	S	H	O	01	10	20	30	40	05	15				25	35	45	
		Steel	Stainless steel	Cast iron	NF metals	Difficult-to-machine materials	Hard materials	Other														
WXP 20	HC – P 20	●●													[Application range diagram: blue triangle from 10 to 30]				PVD	TiN		
	HC – K 20			●											[Application range diagram: pink triangle from 15 to 25]							
WXM 20	HC – M 20		●●												[Application range diagram: yellow triangle from 10 to 30]				PVD	TiCN		
	HC – N 20				●									[Application range diagram: green triangle from 15 to 25]								
WMP 32	HC – P 30	●●													[Application range diagram: blue triangle from 10 to 30]				PVD	TiAlN		
	HC – M 30		●●												[Application range diagram: yellow triangle from 10 to 30]							
	HC – K 30			●											[Application range diagram: pink triangle from 15 to 25]							

HC = Coated carbide

- Primary application
- Other application

Usage information: Walter NTS threading – application strategy

Performance features

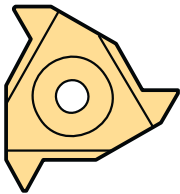

- Precision-ground profile
- Ground-in chip breaker
- Excellent cutting behaviour and reliable chip clearance due to the positive cutting edge shape
- Right-hand and left-hand version
- By changing the bottom shim, threads running in the opposite direction can be produced
- High repeat accuracy
- Great profile versatility
- Full profile and part profile
- PVD coated carbide grades

External machining

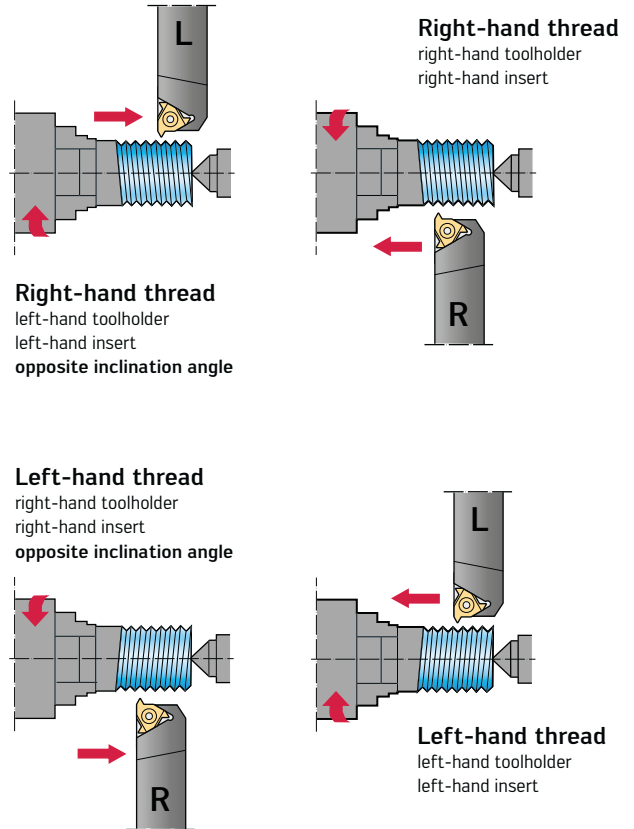

Internal machining

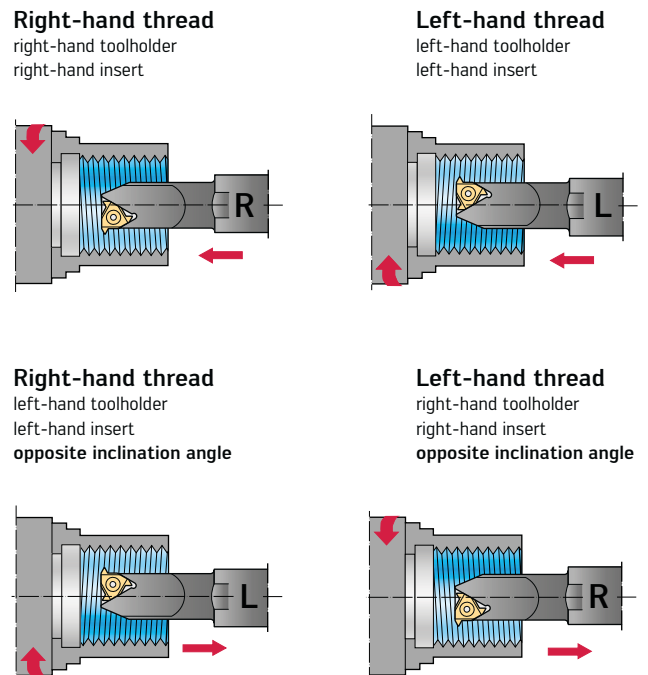

Usage information: Threading – inclination angle corrections

Inclination angle diagram

Standard inclination angle
Feed rate in head stock direction

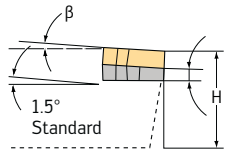

Opposite inclination angle
Feed rate in tail stock direction

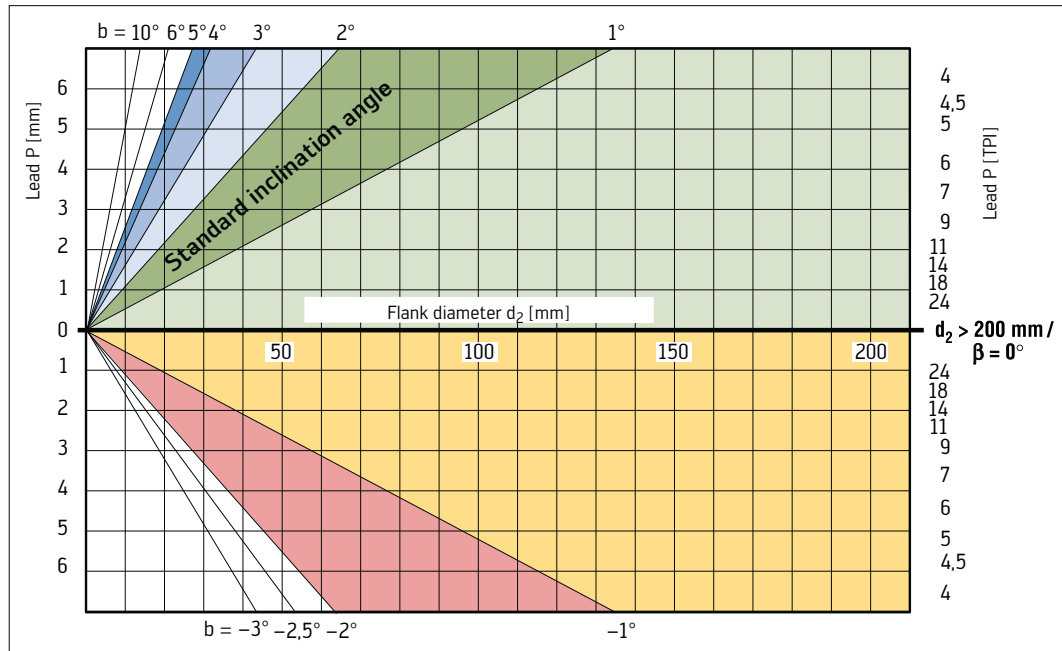
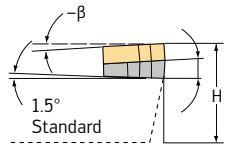

The colours in the inclination angle diagram correspond to the colours of the shim table.
No values must be read off.

Inclination angle calculation

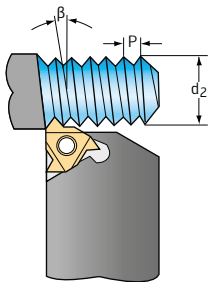

The inclination angle is calculated according to the following formula:

$$\beta = \arctan \frac{P}{\pi \times d_2}$$

β = inclination angle [°]
P = thread pitch [mm]
 d_2 = pitch diameter [mm]

The inclination angle can also be determined using the diagram.
The suitable shim is selected in acc. with the relevant table.

Shims

The inclination angle of standard toolholders (internal and external) is $\beta = 1.5^\circ$!

With an insert size of 1/4" (11 mm), the inclination angle correction takes place via the tool.

Insert size		Toolholder	Ordering code							
IC	L [mm]		$\beta = 4.5^\circ$	$\beta = 3.5^\circ$	$\beta = 2.5^\circ$	$\beta = 1.5^\circ$	$\beta = 0.5^\circ$	$\beta = 0$	$\beta = -0.5^\circ$	$\beta = -1.5^\circ$
3/8"	16	ER/IL	YE 3-3P	YE 3-2P	YE 3-1P	YE 3	YE 3-1N	YE 3-1.5N	YE 3-2N	YE 3-3N
		EL/IR	YI 3-3P	YI 3-2P	YI 3-1P	YI 3	YI 3-1N	YI 3-1.5N	YI 3-2N	YI 3-3N
1/2"	22	ER/IL	YE 4-3P	YE 4-2P	YE 4-1P	YE 4	YE 4-1N	YE 4-1.5N	YE 4-2N	YE 4-3N
		EL/IR	YI 4-3P	YI 4-2P	YI 4-1P	YI 4	YI 4-1N	YI 4-1.5N	YI 4-2N	YI 4-3N

Usage information: Recommended values for threading with Walter NTS

Feed types and their influence on machining

Radial feed

- Recommended with:**
- Short-chipping materials
 - Hard materials

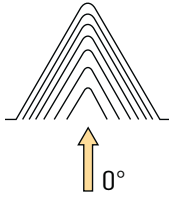

- Formation of V-shaped chips
- Both cutting edges engaged
- Increased cutting temperature

Feed via flank 27°–29°

- Recommended with:**
- Leads bigger than 1.5 mm or 16 TPI
 - In the manufacture of trapezoidal threads

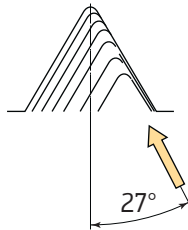

- Good chip formation
- Formation of helical swarf
- One cutting edge operating
- Chip removal away from the thread
- Thread flanks with excellent surface finish

Changing feed

- Recommended with:**
- Large leads
 - Long-chipping materials

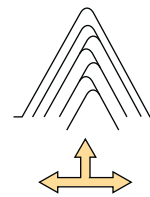

- Good chip formation
- Formation of flat chips
- Both cutting edges are evenly engaged, thus providing balanced wear

Recommended values for the number of radial feeds for each thread cutting pass on manual lathes

The recommended cut distributions must only be seen as recommended values. They were determined under good usage conditions with medium-strength steel materials. In the case of high-strength steels, the number of feeds should be increased. It is important to reduce the initial threading cuts in this case. If the working conditions are different, the feed should be modified accordingly. This applies to internal threading cuts with a projection length of more than 2.5 x the boring bar diameter.

Whitworth (WH), external and internal machining

No. of feeds	Lead (TPI)														
	28	26	20	19	18	16	14	12	11	10	9	8	7	6	5
16															
15														2,80	3,34
14														0,10	0,10
13												2,09	2,41	0,12	0,12
12											1,87	0,08	0,08	0,14	0,15
11										1,69	0,08	0,12	0,12	0,14	0,17
10									1,54	0,08	0,12	0,12	0,14	0,15	0,18
9						1,12	1,23	1,42	0,08	0,12	0,12	0,13	0,15	0,16	0,19
8					1,07	0,08	0,08	0,08	0,12	0,13	0,13	0,14	0,16	0,17	0,20
7			0,87	0,91	0,08	0,10	0,11	0,13	0,13	0,13	0,14	0,15	0,18	0,19	0,22
6	0,64	0,68	0,08	0,08	0,11	0,10	0,12	0,14	0,14	0,15	0,15	0,16	0,19	0,20	0,24
5	0,08	0,08	0,11	0,12	0,13	0,12	0,13	0,15	0,16	0,16	0,17	0,18	0,21	0,21	0,27
4	0,11	0,11	0,13	0,13	0,14	0,14	0,15	0,17	0,18	0,18	0,19	0,20	0,23	0,24	0,30
3	0,12	0,14	0,15	0,16	0,17	0,16	0,18	0,21	0,21	0,21	0,22	0,23	0,27	0,28	0,36
2	0,15	0,16	0,19	0,20	0,21	0,20	0,22	0,26	0,25	0,26	0,27	0,28	0,33	0,34	0,41
1	0,18	0,19	0,21	0,22	0,23	0,22	0,24	0,28	0,27	0,27	0,28	0,30	0,35	0,36	0,43

Radial infeed (mm)



Cutting speed reduction

Usage information: recommended values for threading with Walter NTS

(continued)

External machining, metric 60°

No. of feeds	Lead [mm]																	
	0,5	0,6	0,7	0,75	0,8	1,0	1,25	1,5	1,75	2,0	2,5	3,0	3,5	4,0	4,5	5,0	5,5	6,0
																	3,41	3,72
16																	0,10	0,10
15														2,50	2,80	3,12	0,12	0,12
14														0,08	0,10	0,10	0,13	0,14
13												1,89	2,20	0,11	0,12	0,12	0,13	0,15
12												0,08	0,08	0,12	0,13	0,15	0,15	0,16
11											1,58	0,10	0,11	0,12	0,14	0,16	0,16	0,18
10											0,08	0,11	0,12	0,13	0,15	0,17	0,17	0,19
9									1,14	1,28	0,11	0,12	0,14	0,14	0,16	0,18	0,18	0,20
8									0,08	0,08	0,11	0,12	0,14	0,15	0,17	0,19	0,19	0,21
7							0,80	0,94	0,10	0,11	0,12	0,13	0,15	0,16	0,18	0,20	0,20	0,22
6						0,67	0,08	0,08	0,10	0,12	0,13	0,14	0,17	0,17	0,20	0,22	0,22	0,24
5	0,34	0,40	0,47	0,50	0,54	0,08	0,10	0,12	0,12	0,14	0,15	0,16	0,18	0,19	0,22	0,24	0,24	0,27
4	0,07	0,07	0,07	0,07	0,08	0,11	0,11	0,14	0,14	0,16	0,17	0,18	0,21	0,22	0,24	0,27	0,27	0,30
3	0,07	0,08	0,10	0,11	0,12	0,13	0,14	0,17	0,17	0,18	0,20	0,21	0,25	0,25	0,28	0,32	0,32	0,35
2	0,09	0,11	0,14	0,15	0,16	0,16	0,17	0,21	0,21	0,24	0,24	0,26	0,31	0,32	0,34	0,39	0,40	0,43
1	0,11	0,14	0,16	0,17	0,18	0,19	0,20	0,22	0,22	0,25	0,27	0,28	0,34	0,34	0,37	0,41	0,43	0,46

Radial infeed (mm) ← Cutting speed reduction

Internal machining, metric 60°

No. of feeds	Lead [mm]																	
	0,5	0,6	0,7	0,75	0,8	1,0	1,25	1,5	1,75	2,0	2,5	3,0	3,5	4,0	4,5	5,0	5,5	6,0
																	3,20	3,46
16																	0,10	0,10
15														2,32	2,62	2,89	0,12	0,12
14														0,08	0,10	0,10	0,12	0,13
13												1,77	2,04	0,10	0,11	0,12	0,13	0,14
12												0,08	0,08	0,10	0,12	0,14	0,14	0,15
11											1,49	0,09	0,10	0,11	0,12	0,14	0,14	0,15
10											0,08	0,10	0,11	0,12	0,13	0,15	0,15	0,16
9									1,07	1,20	0,10	0,10	0,12	0,12	0,14	0,15	0,16	0,18
8									0,08	0,08	0,10	0,11	0,13	0,13	0,15	0,16	0,17	0,19
7							0,77	0,90	0,09	0,10	0,11	0,12	0,14	0,14	0,16	0,17	0,18	0,20
6						0,63	0,08	0,08	0,09	0,11	0,12	0,13	0,15	0,15	0,19	0,20	0,20	0,22
5	0,34	0,38	0,44	0,48	0,51	0,08	0,09	0,11	0,10	0,12	0,13	0,14	0,17	0,18	0,21	0,22	0,22	0,24
4	0,07	0,07	0,07	0,07	0,07	0,09	0,10	0,13	0,13	0,14	0,15	0,16	0,19	0,21	0,23	0,25	0,26	0,28
3	0,07	0,08	0,08	0,10	0,11	0,11	0,13	0,15	0,15	0,17	0,18	0,20	0,23	0,24	0,27	0,30	0,32	0,35
2	0,09	0,11	0,13	0,14	0,15	0,16	0,17	0,21	0,21	0,23	0,25	0,26	0,30	0,31	0,33	0,38	0,38	0,41
1	0,11	0,12	0,16	0,17	0,18	0,19	0,20	0,22	0,22	0,25	0,27	0,28	0,32	0,33	0,36	0,41	0,41	0,44

Radial infeed (mm) ← Cutting speed reduction

External machining, UN 60°

No. of feeds	Lead (TPI)															
	32	28	24	20	18	16	14	13	12	11	10	9	8	7	6	5
16																
15															2,66	3,19
14															0,10	0,10
13													2,01	2,28	0,11	0,12
12												1,79	0,08	0,08	0,12	0,15
11											1,63	0,08	0,11	0,11	0,13	0,17
10									1,48	0,08	0,11	0,12	0,12	0,12	0,14	0,18
9							1,17	1,26	1,36	0,08	0,11	0,12	0,12	0,14	0,15	0,19
8						1,03	0,08	0,08	0,08	0,11	0,12	0,12	0,13	0,15	0,16	0,19
7				0,83	0,93	0,08	0,10	0,11	0,12	0,12	0,12	0,13	0,13	0,14	0,16	0,20
6		0,62	0,71	0,08	0,08	0,11	0,11	0,12	0,13	0,13	0,14	0,14	0,15	0,17	0,18	0,22
5	0,52	0,08	0,08	0,10	0,12	0,12	0,12	0,13	0,14	0,15	0,15	0,16	0,17	0,19	0,20	0,24
4	0,08	0,10	0,12	0,12	0,13	0,13	0,14	0,15	0,16	0,17	0,17	0,18	0,19	0,22	0,23	0,28
3	0,12	0,12	0,15	0,14	0,16	0,16	0,17	0,18	0,20	0,20	0,20	0,21	0,22	0,26	0,27	0,32
2	0,15	0,15	0,17	0,19	0,21	0,21	0,22	0,24	0,26	0,25	0,26	0,26	0,28	0,33	0,34	0,40
1	0,17	0,17	0,19	0,20	0,23	0,22	0,23	0,25	0,27	0,27	0,27	0,28	0,30	0,35	0,36	0,43

Radial infeed (mm) ← Cutting speed reduction

Internal machining, UN 60°

No. of feeds	Lead (TPI)															
	32	28	24	20	18	16	14	13	12	11	10	9	8	7	6	5
16																
15															2,44	2,93
14															0,10	0,10
13													1,86	2,11	0,11	0,12
12												1,66	0,08	0,08	0,11	0,14
11											1,49	0,08	0,10	0,11	0,12	0,14
10										1,38	0,08	0,09	0,10	0,12	0,12	0,15
9							1,10	1,17	1,26	0,08	0,10	0,10	0,11	0,12	0,13	0,16
8						0,95	0,08	0,08	0,08	0,10	0,10	0,11	0,11	0,13	0,14	0,17
7				0,78	0,86	0,08	0,09	0,10	0,10	0,11	0,11	0,12	0,12	0,14	0,15	0,18
6		0,59	0,66	0,08	0,08	0,09	0,10	0,11	0,11	0,12	0,12	0,13	0,13	0,15	0,16	0,20
5	0,49	0,08	0,08	0,09	0,10	0,10	0,11	0,12	0,13	0,13	0,13	0,14	0,15	0,17	0,18	0,22
4	0,08	0,10	0,10	0,11	0,12	0,12	0,13	0,13	0,15	0,15	0,15	0,16	0,17	0,20	0,20	0,25
3	0,10	0,10	0,14	0,13	0,14	0,14	0,15	0,16	0,18	0,18	0,18	0,19	0,21	0,23	0,24	0,30
2	0,14	0,14	0,16	0,17	0,19	0,20	0,21	0,22	0,24	0,24	0,25	0,26	0,28	0,28	0,32	0,38
1	0,17	0,17	0,18	0,20	0,23	0,22	0,23	0,25	0,27	0,27	0,27	0,28	0,30	0,34	0,35	0,42

Radial infeed (mm) ← Cutting speed reduction



CONTENTS

Drilling and boring tools made from solid carbide and HSS

	Information	B 2
WALTER TITEX DRILLING AND BORING TOOLS	Programme overview	B 4
	Designation key	B 13
	Walter Select – Drilling	B 14
	Walter Titex Drills	B 36
	Walter Select – Counterboring, Countersinking and Centring	B 276
	Walter Titex Counterboring, Countersinking and Centring	B 284
	Walter Select – Reaming	B 310
	Walter Titex Reaming Tools	B 316
	Walter Titex Drill Sets	B 346
	TECHNICAL INFORMATION	Cutting data
RPM diagrams VCRR		B 382
Feed rating charts VRR		B 384
Cutting tool materials, surface treatment and coatings		B 386
Tool types		B 388
XD Technology drilling strategy		B 392
Dimensions		B 394

Tools for drilling and boring

The Walter and Walter Titex competence brands provide a full range of products for efficient drilling and boring operations. The standard range of drills starts with a diameter of 0.05 mm and ends at 100 mm. Various systems with inserts or exchangeable blades, and systems made from solid carbide or HSS are available.

Both analogue and digital solutions with balance compensation are available for re boring and precision boring operations. Maximum precision and easy handling increase process reliability and productivity. For reaming machining, Walter provides solid carbide or HSS tools with multiple cutting edges and pad-guided reamers with exchangeable cutting edges in different versions.

1 XD Technology

- Drilling without pecking up to $30 \times D_c$ as a standard tool and up to $70 \times D_c$ as a special tool
- For versatile use in many different materials

2 Xtra-tec® point drill

- Solid drill with exchangeable blade for all bores up to $10 \times D_c$
- Patented clamping provides maximum process reliability

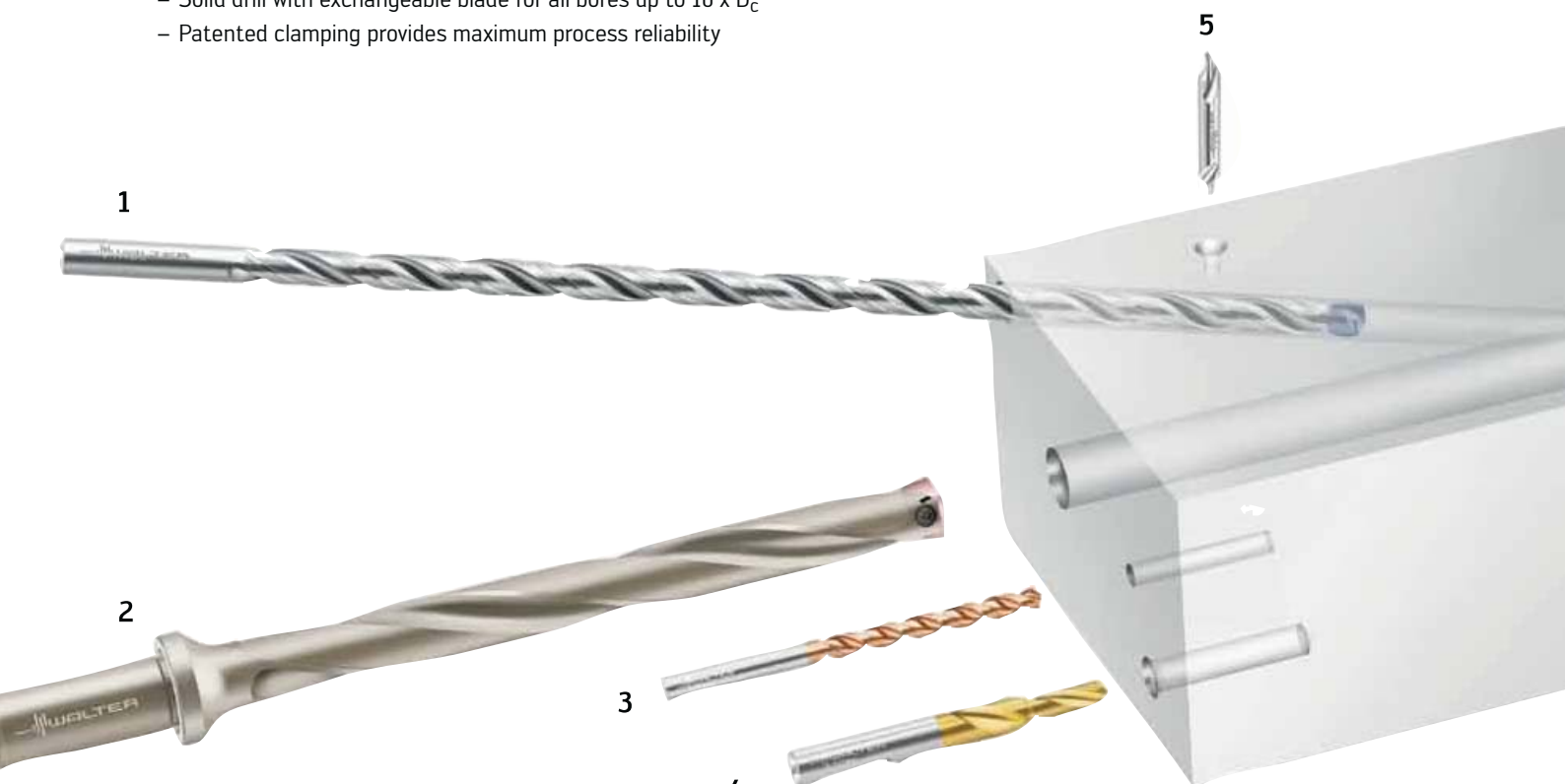

3 UFL® XPL high-performance drill made from HSS-E

- UFL® XPL tools provide a long tool life in universal use
- HSS-E provides good temperature resistance and XPL coating maximum wear resistance

4 Alpha® 2 solid carbide chamfering drill

- Core hole drilling and countersinking can be performed in a single operation
- Other dimensions and stages can be supplied via the Walter Xpress Service within 2 weeks



5 Solid carbide and HSS centre drill

- The product range includes dimensions in accordance with DIN 333 and forms A, R and B

6 X-treme Plus

- The patented DPL coating represents suitability for use in the HSC area for different materials
- Maximum cutting speeds increase productivity and improve component quality

7 Walter Precision

- Self-balancing precision boring tool for final hole machining
- Accuracy of 2 µm with v_c to 2000 m/min

8 Xtra-tec® Insert Drill

- Universally usable indexable insert drill for high productivity with excellent hole quality

9 Walter Boring

- Boring tool with a wide adjustment range
- Using Walter NCT, fits almost any machine spindle

10 X-treme D8–D12

- High-performance drill up to 12 x D_c with DPP double point coating for maximum process reliability and maximum productivity
- No centring or pilot holes required

11 Walter reaming

- Pad-guided HSC reamer for maximum precision
- Extremely universal because of indexable insert

12 Walter Titex reaming

- The comprehensive reaming product range made from solid carbide and HSS includes cylindrical and tapered versions
- 1/100 increments available from stock

Product range overview of solid carbide drills with internal cooling

Application									
Drilling depth	3 x D _c			5 x D _c					
Designation	A3289DPL	A3285TFL	A3885TFL	A3389DPL	A3382XPL	A3399XPL	A3999XPL	A3387	A3384
Type	X-treme Plus	Alpha® 4	Alpha® 4	X-treme Plus	X-treme Cl	X-treme	X-treme	Alpha® Jet	Alpha® Ni
Dia. range	3,00 – 20,00	3,00 – 20,00	3,00 – 20,00	3,00 – 20,00	3,00 – 20,00	3,00 – 25,00	3,00 – 25,00	4,00 – 20,00	3,00 – 12,00
Page	B 70	B 66	B 102	B 86	B 81	B 89	B 112	B 85	B 84

Application									
Drilling depth	8 x D _c				12 x D _c			16 x D _c	
Designation	A6488TML	A6489DPP	A3487	A3486TIP	A3586TIP	A6588TML	A6589DPP	A3687	A6685TFP
Type	Alpha® 4 Plus Micro	X-treme D8	Alpha® Jet	Alpha® 44	Alpha® 44	Alpha® 4 Plus Micro	X-treme D12	Alpha® Jet	Alpha® 4 XD16
Dia. range	0,75 – 2,95	3,00 – 20,00	5,00 – 20,00	5,00 – 12,00	5,00 – 12,00	1,00 – 2,90	3,00 – 20,00	5,00 – 20,00	3,00 – 16,00
Page	B 121	B 123	B 95	B 94	B 96	B 126	B 127	B 97	B 130

Application											
Drilling depth	20 x D _c		25 x D _c		30 x D _c		Pilot				
Designation	A6789AMP	A6794TFP	A6785TFP	A6889AMP	A6885TFP	A6994TFP	A6985TFP	A6181AML	A6181TFT	A7191TFT	K5191TFT
Type	X-treme DM20	X-treme DH20	Alpha® 4 XD20	X-treme DM25	Alpha® 4 XD25	X-treme DH30	Alpha® 4 XD30	X-treme Pilot 150	XD Pilot	X-treme Pilot 180	X-treme Pilot 180C
Dia. range	2,00 – 2,90	3,00 – 10,00	3,00 – 16,00	2,50 – 2,90	3,00 – 12,00	3,00 – 10,00	3,00 – 12,00	2,00 – 2,90	3,00 – 16,00	3,00 – 10,00	4,00 – 7,00
Page	B 132	B 133	B 131	B 135	B 134	B 137	B 136	B 117	B 118	B 138	B 140

Product range overview of solid carbide drills without internal cooling

Application										
Drilling depth	3 x D _c	3 x D _c								
Designation	K3164TIN	A3265TFL	A3865TFL	A3269TFL	A1164TIN	A1163	A1166TIN	A1166	A1167A	A1167B
Type	Alpha® 2	Alpha® 2	Alpha® 2	Alpha® Rc	Alpha® 2	N	Maximiza	Maximiza	Maximiza	Maximiza
Dia. range	3,30 – 14,50	3,00 – 20,00	3,00 – 20,00	3,40 – 10,40	1,50 – 20,00	1,00 – 12,00	3,00 – 20,00	3,00 – 20,00	3,00 – 20,00	3,00 – 20,00
Page	B 139	B 61	B 98	B 65	B 38	B 36	B 46	B 42	B 47	B 50

Application									
Drilling depth	5 x D _c						8 x D _c		
Designation	A3378TML	A3162	A3365TFT	A3965TFT	A3367	A3967	A6478TML	A1276TFL	A1263
Type	Alpha® 2 Plus Micro	ESU	Alpha® 2	Alpha® 2	BSX	BSX	Alpha® 2 Plus Micro	Alpha® 22	N
Dia. range	0,50 – 2,95	0,10 – 1,45	3,00 – 25,00	3,00 – 25,00	3,00 – 16,00	3,00 – 16,00	0,50 – 2,95	3,00 – 12,00	0,60 – 12,00
Page	B 79	B 59	B 73	B 106	B 77	B 110	B 119	B 57	B 55

Application			
Drilling depth	3 x D _c – Carbide-tipped		NC spot drill
Designation	A2971	A5971	A1174 A1174C
Type	HM	HM	90° 120°
Dia. range	3,00 – 16,00	8,00 – 32,00	3,00 – 20,00 3,00 – 20,00
Page	B 58	B 116	B 53 B 54

Product range overview of HSS drills

Application									
Drilling depth	~ 3 x D _c						~ 5 x D _c		
Designation	A1149XPL	A1149TFL	A1154TFT	A1148	A1111	A2258	A3143	A3153	A6292TIN
Dimensions	DIN 1897	DIN 1897	DIN 1897	DIN 1897	DIN 1897	Walter standard	DIN 1899	DIN 1899	Walter standard
Type	UFL®	UFL®	VA Inox	UFL®	N	UFL® left	ESU	ESU left	MegaJet
Dia. range	1,00 – 20,00	1,00 – 20,00	2,00 – 16,00	1,00 – 20,00	0,50 – 32,00	1,00 – 20,00	0,05 – 1,45	0,15 – 1,4	5,00 – 24,00
Page	B 163	B 158	B 168	B 153	B 141	B 239	B 243	B 245	B 269

Application									
Drilling depth	~ 12 x D _c					~ 16 x D _c	~ 22 x D _c	~ 30 x D _c	
Designation	A1549TFP	A1547	A1544	A1522	A1511	A1622	A1722	A1822	
Dimensions	DIN 340	DIN 340	DIN 340	DIN 340	DIN 340	DIN 1869 I	DIN 1869 II	DIN 1869 III	
Type	UFL®	Alpha® XE	VA	UFL®	N	UFL®	UFL®	UFL®	
Dia. range	1,00 – 12,00	1,00 – 12,70	1,00 – 12,00	1,00 – 22,225	0,50 – 22,00	2,00 – 12,70	3,00 – 12,00	3,50 – 12,00	
Page	B 230	B 227	B 225	B 221	B 218	B 232	B 235	B 236	

Application								
	NC spot drill		Bodywork drill	Multi-diameter step drill			Taper pin drill	
Designation	A1115 A1115S A1115L	A1114 A1114S A1114L	A1121	K6221	K6222	K6223	K2929	K4929
Dimensions	Walter standard	Walter standard	Walter standard	DIN 8374	DIN 8378	DIN 8376	DIN 1898 A	DIN 1898 B
Type	90°	120°		90°	90°	180°		
Dia. range	2,00 – 25,40	2,00 – 25,40	3,30 – 4,90	3,20 – 8,40	2,50 – 10,20	4,50 – 11,00	1,00 – 12,00	5,00 – 25,00
Page	B 149	B 146	B 152	B 273	B 274	B 275	B 271	B 272



~ 8 x D _c											
A1249XPL	A1249TFL	A1254TFT	A1247	A1244	A1222	A1211TIN	A1211	A1212	A1234	A1231	
DIN 338	DIN 338	DIN 338	DIN 338	DIN 338	DIN 338	DIN 338	DIN 338	DIN 338	DIN 338	DIN 338	DIN 338
UFL®	UFL®	VA Inox	Alpha® XE	VA	UFL®	N	N	H	UFL® left	N left	
1,00 – 16,00	1,00 – 20,00	3,00 – 16,00	1,00 – 16,00	0,30 – 15,00	1,00 – 16,00	0,50 – 16,00	0,20 – 22,00	0,40 – 16,00	1,016 – 12,70	0,20 – 20,00	
B 212	B 208	B 216	B 204	B 199	B 185	B 180	B 171	B 182	B 195	B 190	

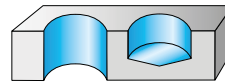

~ 60 x D _c	~ 85 x D _c	~ 8 x D _c					~ 12 x D _c		~ 16 x D _c		~ 22 x D _c
A1922S	A1922L	A4211TIN	A4211	A4244	A4247	A4422	A4411	A4622	A4611	A4722	
Walter standard	Walter standard	DIN 345	DIN 345	DIN 345	DIN 345	DIN 341	DIN 341	DIN 1870 I	DIN 1870 I	DIN 1870 II	
UFL®	UFL®	N	N	VA	Alpha® XE	UFL®	N	UFL®	N	UFL®	
6,00 – 14,00	8,00 – 12,00	5,00 – 30,00	3,00 – 100,00	10,00 – 32,00	10,00 – 40,00	10,00 – 31,00	5,00 – 50,00	12,00 – 30,00	8,00 – 50,00	8,00 – 40,00	
B 238	B 237	B 255	B 247	B 256	B 258	B 263	B 260	B 267	B 265	B 268	

Application	
	Twist drill set
Dimensions	DIN 338
Type	N; VA; UFL®
Page	B 346

Product range overview of core drilling and countersinking

Application		
Dimensions	DIN 344	DIN 343
Designation	E1111	E3111
Type	N	N
Dia. range	4,80 – 16,00	7,80 – 49,60
Page	B 284	B 285

Application					
Dimensions	DIN 335	DIN 335	DIN 334	DIN 335	DIN 334
Designation	E6819TIN	E6819	E6818	E7819	E7818
Type	90°	90°	60°	90°	60°
Form	C	C	C	D	D
Dia. range	6,00 – 31,00	4,30 – 31,00	6,30 – 25,00	15,00 – 80,00	16,00 – 80,00
Page	B 289	B 288	B 287	B 291	B 290

Application	
	Taper shank countersinks 90° E6819TN set
Designation	Z3711TIN
Type	90°
Form	C
Dia. range	6,3 – 20,5
Page	B 350





Product range overview of centre drills









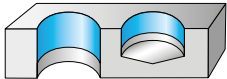

Application									
Dimensions	DIN 333					DIN 333			DIN 333
Designation	K1161	K1111TIN	K1111	K1112	K1131	K1113TIN	K1113	K1114	K1215
Type	Solid carbide	-	-	with flat	left-hand	-	-	with flat	-
Form	A	A	A	A	A	R	R	R	B
Dia. range	0,50 – 6,30	1,00 – 5,00	0,50 – 12,50	1,60 – 5,00	0,50 – 6,30	1,00 – 5,00	0,50 – 12,50	1,60 – 5,00	1,00 – 10,00
Page	B 298	B 292	B 292	B 293	B 297	B 295	B 294	B 296	B 299

Application								
Dimensions	Walter standard	Walter standard				ANSI B 94.11 M-1979	B.S. 328	
Designation	K1313	K1311	K1411S	K1411M	K1411L	K1811	K1911	
Form	R	A	A	A	A	A	A	
Dia. range	1,00 – 4,00	0,63 – 6,00	0,75 – 5,00	0,75 – 4,00	2,00 – 4,00	Nr.00 – Nr.8	B.S.1 – B.S.7	
Page	B 301	B 300	B 304	B 303	B 302	B 305	B 306	









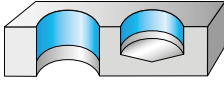

Application		
	Step centre drill	
Designation	K2511	K2513
Type	60°	Radius
Form	-	R
Dia. range	3,30 – 21,00	3,30 – 21,00
Page	B 307	B 308

Product range overview of reamers

Application				
Dimensions	Walter standard			
Designation	F1362	F1371	F4162	F4171
Type	Straight flute	Left-hand spiral	Straight flute	Left-hand spiral
Form	A / C	B / D	A	B
Dia. range	2,00 – 20,00	2,00 – 20,00	5,00 – 32,00	5,00 – 20,00
Page	B 332	B 333	B 341	B 342
Carbide reamers				

Application										
Dimensions	DIN 212				DIN 208			DIN 219		
Designation	F1342	F1352	F1352HUN	F1353	F4142	F4152	F4153	F7133	Z2311	
Type	Straight flute	Left-hand spiral	Left-hand spiral	Quick-helix	Straight flute	Left-hand spiral	Quick helix	Left-hand spiral	Adaptor:	
Form	A / C	B / D	B / D	E	A	B	C	B	–	
Dia. range	1,00 – 20,00	0,90 – 20,00	0,95 – 12,00	1,00 – 20,00	5,00 – 32,00	5,00 – 40,00	5,00 – 32,00	25,00 – 60,00	–	
Page	B 322	B 325	B 329	B 330	B 337	B 338	B 340	B 345	G 66	
HSS reamers										

Product range overview of reamers

Dimensions	DIN 9 A	DIN 2179	DIN 2180	DIN 311	Walter standard	DIN 206		DIN 859	
Application									
Designation	F3317	F3234	F6134	F4535	F3517	F1111	F1131	F1211	F1231
Type	Taper 1:50	Taper 1:50	Taper 1:50	Rivet hole	Taper 1:10	Hand reamer with straight flutes	Hand reamer with left-hand spiral	Adjustable reamer with straight flutes	Adjustable reamer with left-hand spiral
Form	A	–	–	–	–	A	B	A	B
Dia. range	1,00 – 30,00	1,00 – 12,00	5,00 – 20,00	6,40 – 32,00	5,00 – 23,00	1,00 – 30,00	1,00 – 50,00	4,00 – 30,00	8,00 – 30,00
Page	B 335	B 334	B 344	B 343	B 336	B 316	B 317	B 320	B 321
HSS reamers									



Designation key for drills

Example

A	3	3	89	DPL
1	2	3	4	5

1	
Tool type	
A	Twist drill, Maximiza
E	Counterboring tool and countersink
F	Reamers
K	Centre drill and multi-diameter step drill
Z	Drill sets and accessories

2	
Shank shape	
1	Cylindrical
2	Cylindrical
3	Cylindrical
4	with Morse taper (HSS)
5	with Morse taper (solid carbide)
6	MegaJet / Alpha® 4 XD

3	
Length in acc. with DIN or Walter standard	
Cylindrical	
1	DIN 1897 / 6539 / 1899
2	DIN 338 / 6537 K
3	DIN 334 / 6537 L
4	DIN 339
5	DIN 340
6	Series I DIN 1869
7	Series II DIN 1869
8	Series III DIN 1869 / 6537 K
9	Walter standard / DIN 6537 L / 8037
Morse taper	
1	Walter standard
2	DIN 345
3	DIN 346
4	DIN 341
5	DIN 8041
6	DIN 1870-I
7	DIN 1870-II

4			
Tool type			
11	Type N (HSS) – general use	53	Micro drill (HSS-LH)
12	Type H (HSS)	54	VA stainless steel (HSS-E)
13	Type W (HSS)	62	Solid carbide
14	NC spot drill (HSS) 120°	63	Type N (solid carbide)
15	NC spot drill (HSS) 90°	64	Alpha® 2 (solid carbide)
21	Double ended panel drill (HSS)	65	Alpha® 2 (solid carbide)
22	UFL® (HSS)	66	Maximiza
23	NC spot drill (HSS) 120°	67	Maximiza (wide flutes)
24	NC spot drill (HSS) 90°	69	Alpha® Rc (solid carbide)
31	Type N (HSS-LH)	71	Carbide-tipped
32	Type H (HSS-LH)	74	NC spot drill (solid carbide)
33	Type W (HSS-LH)	76	Alpha® 22 UFL® (solid carbide)
34	Type UFL (HSS-LH)	78	Alpha® 2 Plus (solid carbide)
41	Type NS (HSS-E)	79	X-treme without internal coolant
43	Micro drill (HSS-E)	81	XD Pilot (solid carbide)
44	Type VA (HSS-E)	85	Type Alpha® 4 (solid carbide)
47	Type Alpha® XE (HSS-E)		
48	Type UFL® (HSS-E)		
49	Type UFL® (HSS-E)		
		86	Type Alpha® 44 (solid carbide)
		87	Type Alpha® Jet (solid carbide)
		88	Alpha® 4 Plus (solid carbide)
		89	X-treme Plus (solid carbide)
		89	X-treme D8 and D12 (solid carbide)
		89	X-treme M and DM (solid carbide)
		92	MegaJet (HSS-E)
		94	X-treme DH (solid carbide)
		99	X-treme with internal coolant

5	
Coating	
TiN	TiN coating
TiP	TiN point coating
TFL	Tinal coating
TFT	Tinal TOP coating
TFP	Tinal point coating
TML	Tinal micro coating
XPL	AlCrN coating
DPL	Double coating
DPP	Double point coating
AML	AlTiN micro coating
AMP	AlTiN micro point coating

Walter Select for carbide and HSS drilling and boring tools

Step by step to the correct tool

STEP 1

Define the **material** to be machined from page H 8.

Make a note of the **machining group** corresponding to your material, e.g.: K5.

Code letter	Machining group	Groups of the materials to be machined	
P	P1–P15	Steel	All types of steel and cast steel, with the exception of steel with an austenitic structure
M	M1–M3	Stainless steel	Stainless austenitic steel and austenitic-ferritic steel and cast steel
K	K1–K7	Cast iron	Grey cast iron, cast iron with spheroidal graphite, malleable cast iron, cast iron with vermicular graphite
N	N1–N10	NF metals	Aluminium and other non-ferrous metals, non-ferrous materials
S	S1–S10	High temperature alloys and titanium alloys	Heat resisting special alloys based on iron, nickel and cobalt, titanium and titanium alloys
H	H1–H4	Hard materials	Hardened steel, hardened cast iron materials, chilled hard cast iron
O	O1–O6	Other	Plastics, glass and carbon fibre Reinforced plastics, graphite

STEP 2

Select the **machining conditions**:

Machine stability, clamping system and workpiece		
very good	good	moderate
		

STEP 3

Select the **cutting tool material** (HSS, carbide) and the **type of cooling**:

Tools made from **carbide with internal cooling**: from page B 16 onwards

Tools made from **carbide without internal cooling**: from page B 22 onwards

Tools made from **HSS**: from page B 26 onwards

STEP 4

Choose your tool:

- in accordance with the **drilling depth** or **DIN** (e.g. 3 x D_c or DIN 338)
- in accordance with the **machining conditions** (see step 2: 😊 😐 😞)
- for the relevant **machining group** (see step 1: P1–P15; M1–M3; ... O1–O6)

		Drilling depth		3 x D _c			
		Machining conditions	☺	☹			
Designation		A3289DPL		A3285TFL A3885TFL			
Type		X-treme Plus		Alpha ⁴			
Dimensions		DIN 6537 K		DIN 6537 K			
Dia. range (mm)		3.00 – 20.00		3.00 – 20.00			
Cutting tool material		K30F		K30F			
Coating		DPL		TFL			
Page		B 70		B 66/B 102			
Material group	Grouping of main material groups and identification letters	Workpiece material	Brinell hardness HB	Tensile strength R _m N/mm ²	Machining group		
P	Non-alloyed and low alloy steel	annealed (tempered)	210	700	P1, P2, P3, P4, P7	●●	●●
		machining steel	220	750	P6	●●	●●
		tempered	300	1010	P5, P8	●●	●●
		tempered	380	1280	P9	●●	●●
		tempered	430	1480	P10	●●	●●
	High-alloyed steel and high-alloyed tool steel	annealed	200	670	P11	●●	●●
		hardened and tempered	300	1010	P12	●●	●●
		hardened and tempered	400	1360	P13	●●	●●
	Stainless steel	ferritic/martensitic, annealed	200	670	P14	●●	●●
		martensitic, tempered	330	1110	P15	●●	●●
M	Stainless steel	austenitic, duplex	230	780		●●	●●
		austenitic, precipitation hardened (PH)				●●	●●

STEP 5

Choose your **cutting data** from the table from page B 352 onwards:

- **Cutting speed:**
v_c; VCRR (v_c rating chart for micro)
- **Feed:**
VRR (feed rating chart)

Go to the row of your machining group (e.g. K5) and the column of your selected drilling and boring tool. You will find the cutting speed v_c or the VCRR and VRR there.

The v_c rating chart (VCRR) and the feed rating chart (VRR) can be found from page B 382 onwards.

= cutting data for wet machining = dry machining is possible, cutting data must be selected from TEC E = Emulsion O = Oil M = MOL L = dry v _c = cutting speed VCRR = v _c rating chart from page B 382 VRR = feed rating chart from page B 384		Drilling depth		3 x D _c								
		Designation	A3289DPL		A3285TFL A3885TFL							
Type		X-treme Plus		Alpha ⁴								
Dimensions		DIN 6537 K		DIN 6537 K								
Dia. range (mm)		3.00 – 20.00		3.00 – 20.00								
Cutting tool material		K30F		K30F								
Coating		DPL		TFL								
Page		B 70		B 66/B 102								
Material group	Grouping of main material groups and identification letters	Workpiece material	Brinell hardness HB	Tensile strength R _m N/mm ²	Machining group ¹							
P	Non-alloyed steel	C ≤ 0.25 %	annealed	125	428	P1	200	15	E O M L	120	12	E O M L
		C > 0.25, ≤ 0.55 %	annealed	190	639	P2	180	12	E O M L	105	12	E O M L
		C > 0.25, ≤ 0.55 %	tempered	210	708	P3	170	12	E O M L	100	12	E O M L
		C > 0.55 %	annealed	190	639	P4	180	12	E O M L	105	12	E O M L
		C > 0.55 %	tempered	300	1013	P5	140	12	E O M L	75	9	E O M L
	Low alloy steel	machining steel (short-chipping)	annealed	220	745	P6	200	15	E O M L	120	12	E O M L
		annealed	175	591	P7	180	12	E O M L	105	12	E O M L	
		tempered	300	1013	P8	140	12	E O M L	75	9	E O M L	
		tempered	380	1282	P9	100	8	O E	50	6	O E	
		tempered	430	1477	P10	80	6	O E	42	4	O E	
High-alloyed steel and high-alloyed tool steel	annealed	200	675	P11	85	9	E O	67	9	E O		
	hardened and tempered	300	1013	P12	120	10	E O	80	7	E O		
	hardened and tempered	400	1361	P13	80	6	O E	42	4	O E		
Stainless steel	ferritic/martensitic, annealed	200	675	P14	85	9	E O	67	9	E O		
	martensitic, tempered	330	1114	P15	50	9	E O	42	7	E O		
M	Stainless steel	austenitic, quench hardened	200	675	M1	50	6	E O	42	5	E O	
		austenitic, precipitation hardened (PH)	300	1013	M2	63	6	E O	56	6	E O	
		austenitic, ferritic, duplex	230	778	M3	40	6	E O	34	5	E O	
	Malleable cast iron											

Walter Select – Drilling

Solid carbide drills with internal cooling

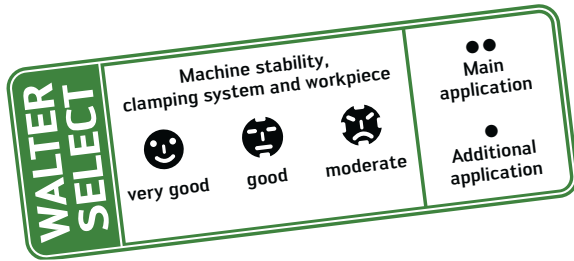

Drilling depth	3 x D _c	
Machining conditions		
Designation	A3289DPL	A3285TFL A3885TFL
Type	X-treme Plus	Alpha® 4
Dimensions	DIN 6537 K	DIN 6537 K
Dia. range (mm)	3,00 – 20,00	3,00 – 20,00
Cutting tool material	K30F	K30F
Coating	DPL	TFL
Page	B 70	B 66/B 102

Material group	Grouping of main material groups and identification letters		Brinell hardness HB	Tensile strength R _m N/mm ²	Machining group			
	Workpiece material							
P	Non-alloyed and low alloy steel	annealed (tempered)	210	700	P1, P2, P3, P4, P7	●●	●●	
		machining steel	220	750	P6	●●	●●	
		tempered	300	1010	P5, P8	●●	●●	
		tempered	380	1280	P9	●●	●●	
		tempered	430	1480	P10	●●	●●	
	High-alloyed steel and high-alloyed tool steel	annealed	200	670	P11	●●	●●	
hardened and tempered		300	1010	P12	●●	●●		
hardened and tempered		400	1360	P13	●●	●●		
Stainless steel	ferritic/martensitic, annealed	200	670	P14	●●	●●		
	martensitic, tempered	330	1110	P15	●●	●●		
M	Stainless steel	austenitic, duplex	230	780	M1, M3	●●	●●	
		austenitic, precipitation hardened (PH)	300	1010	M2	●●	●●	
K	Grey cast iron		245	–	K3, K4	●●	●●	
	Cast iron with spheroidal graphite	ferritic, pearlitic	365	–	K1, K2, K5, K6	●●	●●	
	GGV (CGI)		200	–	K7	●●	●●	
N	Aluminium wrought alloys	cannot be hardened	30	–	N1	●		
		hardenable, hardened	100	340	N2	●		
	Cast aluminium alloys	≤ 12 % Si	90	310	N3, N4	●	●	
		> 12 % Si	130	450	N5	●	●●	
	Magnesium alloys		70	250	N6			
	Copper and copper alloys (bronze/brass)	non-alloyed, electrolytic copper		100	340	N7	●	●●
brass, bronze, red brass			90	310	N8	●	●●	
Cu-alloys, short-chipping			110	380	N9	●	●●	
high-strength, Ampco			300	1010	N10	●●	●●	
S	Heat-resistant alloys	Fe-based	280	940	S1, S2	●●	●●	
		Ni or Co base	250	840	S3	●●	●●	
		Ni or Co base	350	1080	S4, S5	●	●●	
	Titanium alloys	pure titanium	200	670	S6	●●	●●	
		α and β alloys, hardened	375	1260	S7	●●	●●	
		β alloys	410	1400	S8	●●	●●	
Tungsten alloys		300	1010	S9	●	●		
Molybdenum alloys		300	1010	S10	●	●		
H	Hardened steel		50 HRC	–	H1	●●	●●	
			55 HRC	–	H2, H4	●	●	
			60 HRC	–	H3			
O	Thermoplasts	without abrasive fillers			O1	●		
	Thermosetting plastics	without abrasive fillers			O2			
	Fibre-reinforced plastic	GFRP, AFRP				O3, O5		
		CFRP				O4		
	Graphite (technical)			65		O6		



	5 x D _c					8 x D _c	
	☺	☹	☹	☺	☺	☹	☺
	A3389DPL	A3382XPL	A3399XPL A3999XPL	A3387	A3384	A6488TML	A6489DPP
	X-treme Plus	X-treme CI	X-treme	Alpha® Jet	Alpha® Ni	Alpha® 4 Plus Micro	X-treme D8
	DIN 6537 L	DIN 6537 L	DIN 6537 L	DIN 6537 L	DIN 6537 L	Walter standard	Walter standard
	3,00 – 20,00	3,00 – 20,00	3,00 – 25,00	4,00 – 20,00	3,00 – 12,00	0,75 – 2,95	3,00 – 20,00
	K30F	K30F	K30F	K20F	K20F	K30F	K30F
	DPL	XPL	XPL	uncoated	uncoated	TML	DPP
	B 86	B 81	B 89/B 112	B 85	B 84	B 121	B 123
	••		••			••	••
	••		••			••	••
	••		••			••	••
	••		••			••	••
	••		••		•	••	••
	••		••			••	••
	••		••		•	••	••
	••		••			••	••
	••		••			••	••
	••		••		•	••	••
	••		••			••	••
	••	••	••	••		••	••
	••	••	••	••		••	••
	•		••	•		••	•
	•		••	••		••	•
	•		••	••		••	•
	••		••	••		••	••
	••		••	••		••	••
	••		••	••		••	••
	••		••	••	••	••	•
	••		••	••	••	••	••
	••		••	••	••	••	••
	•	••	•	•	•	•	•
	•	••	•	•	•	•	•
	••		••		•	•	••
	•		•			•	
	•			••		••	•

Walter Select – Drilling

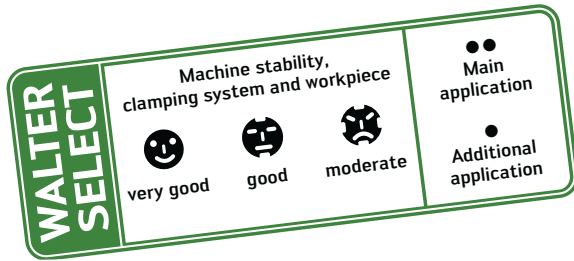
Solid carbide drills with internal cooling



Drilling depth	8 x D _c	
Machining conditions	☺	☺
Designation	A3487	A3486TIP A3586TIP
Type	Alpha® Jet	Alpha® 44
Dimensions	Walter standard	Walter standard
Dia. range (mm)	5,00 – 20,00	5,00 – 12,00
Cutting tool material	K20F	K30F
Coating	uncoated	TIP
Page	B 95	B 94/B 96

Material group	Grouping of main material groups and identification letters		Brinell hardness HB	Tensile strength R _m N/mm ²	Machining group		
	Workpiece material						
P	Non-alloyed and low alloy steel	annealed (hardened and tempered)	210	700	P1, P2, P3, P4, P7	••	••
		machining steels	220	750	P6	••	••
		tempered	300	1010	P5, P8	•	•
		tempered	380	1280	P9	•	•
		tempered	430	1480	P10	•	•
	High-alloyed steel and high-alloyed tool steel	annealed	200	670	P11	••	••
hardened and tempered		300	1010	P12	•	•	
hardened and tempered		400	1360	P13	•	•	
Stainless steel	ferritic/martensitic, annealed	200	670	P14	••	••	
	martensitic, tempered	330	1110	P15	•	•	
M	Stainless steel	austenitic, duplex	230	780	M1, M3	•	•
		austenitic, precipitation hardened (PH)	300	1010	M2	•	•
K	Grey cast iron		245	–	K3, K4	••	•
	Cast iron with spheroidal graphite	ferritic, pearlitic	365	–	K1, K2, K5, K6	•	•
	GGV (CGI)		200	–	K7	•	•
N	Aluminium wrought alloys	cannot be hardened	30	–	N1	•	••
		hardenable, hardened	100	340	N2	•	••
	Cast aluminium alloys	≤ 12 % Si	90	310	N3, N4	••	••
		> 12 % Si	130	450	N5	••	••
	Magnesium alloys		70	250	N6	•	•
	Copper and copper alloys (bronze/brass)	non-alloyed, electrolytic copper	100	340	N7	•	••
brass, bronze, red brass		90	310	N8	•	••	
Cu-alloys, short-chipping		110	380	N9	••	••	
high-strength, Ampco		300	1010	N10	•	••	
S	Heat-resistant alloys	Fe-based	280	940	S1, S2	•	•
		Ni or Co base	250	840	S3	•	•
		Ni or Co base	350	1080	S4, S5	•	•
	Titanium alloys	pure titanium	200	670	S6	•	••
		α and β alloys, hardened	375	1260	S7	•	••
		β alloys	410	1400	S8	•	••
	Tungsten alloys		300	1010	S9	•	•
Molybdenum alloys		300	1010	S10	•	•	
H	Hardened steel		50 HRC	–	H1	•	•
			55 HRC	–	H2, H4	•	•
			60 HRC	–	H3	•	•
O	Thermoplasts	without abrasive fillers			O1	••	••
	Thermosetting plastics	without abrasive fillers			O2	•	•
	Fibre-reinforced plastic	GFRP, AFRP			O3, O5	•	•
		CFRP			O4	•	•
	Graphite (technical)			65	O6	•	•

Walter Select – Drilling

Solid carbide drills with internal cooling

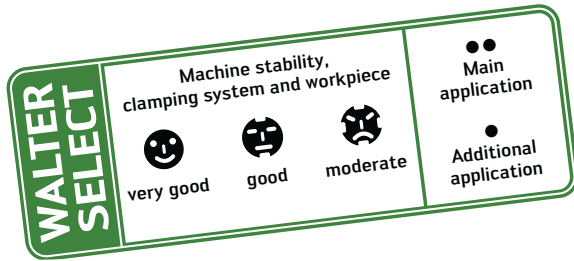

Drilling depth	25 x D _c	
Machining conditions		
Designation	A6889AMP	A6885TFP
Type	X-treme DM25	Alpha® 4 XD25
Dimensions	Walter standard	Walter standard
Dia. range (mm)	2,50 – 2,90	3,00 – 12,00
Cutting tool material	K30F	K30F
Coating	AMP	TFP
Page	B 135	B 134

Material group	Grouping of main material groups and identification letters	Workpiece material	Brinell hardness HB	Tensile strength R _m N/mm ²	Machining group	Drilling performance	
P	Non-alloyed and low alloy steel	annealed (tempered)	210	700	P1, P2, P3, P4, P7	●●	●●
		machining steel	220	750	P6	●●	●●
		tempered	300	1010	P5, P8	●●	●
		tempered	380	1280	P9	●	●
		tempered	430	1480	P10	●	●
	High-alloyed steel and high-alloyed tool steel	annealed	200	670	P11	●●	●
hardened and tempered		300	1010	P12	●●	●	
hardened and tempered		400	1360	P13	●	●	
Stainless steel	ferritic/martensitic, annealed	200	670	P14	●●	●	
	martensitic, tempered	330	1110	P15	●●	●	
M	Stainless steel	austenitic, duplex	230	780	M1, M3	●●	●●
		austenitic, precipitation hardened (PH)	300	1010	M2	●●	●
K	Grey cast iron		245	–	K3, K4	●●	●●
	Cast iron with spheroidal graphite	ferritic, pearlitic	365	–	K1, K2, K5, K6	●●	●●
	GGV (CGI)		200	–	K7	●●	●●
N	Aluminium wrought alloys	cannot be hardened	30	–	N1	●●	●●
		hardenable, hardened	100	340	N2	●●	●●
	Cast aluminium alloys	≤ 12 % Si	90	310	N3, N4	●●	●●
		> 12 % Si	130	450	N5	●●	●●
	Magnesium alloys		70	250	N6		
	Copper and copper alloys (bronze/brass)	non-alloyed, electrolytic copper		100	340	N7	●●
brass, bronze, red brass			90	310	N8	●●	●●
Cu-alloys, short-chipping			110	380	N9	●●	●●
high-strength, Ampco			300	1010	N10	●●	●●
S	Heat-resistant alloys	Fe-based	280	940	S1, S2	●●	●
		Ni or Co base	250	840	S3	●●	●●
		Ni or Co base	350	1080	S4, S5	●	●
	Titanium alloys	pure titanium	200	670	S6	●●	●●
		α and β alloys, hardened	375	1260	S7	●●	●●
		β alloys	410	1400	S8	●●	●●
Tungsten alloys		300	1010	S9	●●	●	
Molybdenum alloys		300	1010	S10	●●	●	
H	Hardened steel		50 HRC	–	H1	●	●
			55 HRC	–	H2, H4	●	
			60 HRC	–	H3		
O	Thermoplasts	without abrasive fillers			O1	●●	●●
	Thermosetting plastics	without abrasive fillers			O2		
	Fibre-reinforced plastic	GFRP, AFRP			O3, O5		
		CFRP			O4		
	Graphite (technical)			65	O6		

	30 x D _c		Pilot drill			
	A6994TFP	A6985TFP	A6181AML	A6181TFT	A7191TFT	K5191TFT
	X-treme DH30	Alpha® 4 XD30	X-treme Pilot 150	XD-Pilot	X-treme Pilot 180	X-treme Pilot 180C
	Walter standard	Walter standard	Walter standard	Walter standard	Walter standard	Walter standard
	3,00 – 10,00	3,00 – 12,00	2,00 – 2,90	3,00 – 16,00	3,00 – 10,00	4,00 – 7,00
	K30F	K30F	K30F	K30F	K30F	K30F
	TFP	TFP	AML	TFT	TFT	TFT
	B 137	B 136	B 117	B 118	B 138	B 140
		●●	●●	●●	●●	●●
		●●	●●	●●	●●	●●
	●●	●	●●	●●	●●	●●
	●●	●	●●	●●	●●	●●
	●●	●	●●	●●	●●	●●
	●●	●	●●	●●	●●	●●
	●●	●	●●	●●	●●	●●
	●●	●	●●	●●	●●	●●
	●●	●●	●●	●●	●●	●●
	●●	●	●●	●●	●●	●●
	●	●●	●●	●●	●●	●●
	●●	●●	●●	●●	●●	●●
		●●	●●	●●	●●	●●
		●	●●	●●	●●	●●
	●●	●●	●●	●●	●●	●●
	●	●	●●	●●	●●	●●
	●	●	●●	●	●●	●●
	●	●	●●	●●	●●	●●
		●●	●●	●●	●●	●●

Walter Select – Drilling

Solid carbide drills without internal cooling

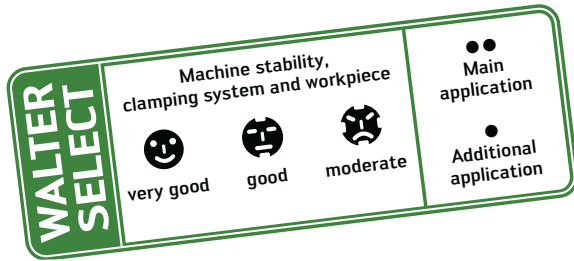

Drilling depth	3 x D _c	
Machining conditions		
Designation	K3164TIN	A3265TFL A3865TFL
Type	Alpha® 2	Alpha® 2
Dimensions	Walter standard	DIN 6537 K
Dia. range (mm)	3,30 – 14,50	3,00 – 20,00
Cutting tool material	K30F	K30F
Coating	TiN	TFL
Page	B 139	B 61/B 98

Material group	Grouping of main material groups and identification letters		Brinell hardness HB	Tensile strength R _m N/mm ²	Machining group		
	Workpiece material						
P	Non-alloyed and low alloy steel	annealed (hardened and tempered)	210	700	P1, P2, P3, P4, P7	●●	●●
		machining steels	220	750	P6	●●	●●
		tempered	300	1010	P5, P8	●●	●●
		tempered	380	1280	P9	●●	●●
		tempered	430	1480	P10	●●	●●
	High-alloyed steel and high-alloyed tool steel	annealed	200	670	P11	●●	●●
hardened and tempered		300	1010	P12	●●	●●	
hardened and tempered		400	1360	P13	●●	●●	
Stainless steel	ferritic/martensitic, annealed	200	670	P14	●●	●●	
	martensitic, tempered	330	1110	P15	●●	●●	
M	Stainless steel	austenitic, duplex	230	780	M1, M3	●●	●●
		austenitic, precipitation hardened (PH)	300	1010	M2	●●	●●
K	Grey cast iron		245	–	K3, K4	●●	●●
	Cast iron with spheroidal graphite	ferritic, pearlitic	365	–	K1, K2, K5, K6	●●	●●
	GGV (CGI)		200	–	K7	●●	●●
N	Aluminium wrought alloys	cannot be hardened	30	–	N1	●●	●●
		hardenable, hardened	100	340	N2	●●	●●
	Cast aluminium alloys	≤ 12 % Si	90	310	N3, N4	●●	●
		> 12 % Si	130	450	N5	●	●
	Magnesium alloys		70	250	N6	●	●
	Copper and copper alloys (bronze/brass)	non-alloyed, electrolytic copper		100	340	N7	●●
brass, bronze, red brass			90	310	N8	●●	●●
Cu-alloys, short-chipping			110	380	N9	●●	●●
high-strength, Ampco			300	1010	N10	●●	●●
S	Heat-resistant alloys	Fe-based	280	940	S1, S2		
		Ni or Co base	250	840	S3		
		Ni or Co base	350	1080	S4, S5		
	Titanium alloys	pure titanium	200	670	S6	●●	●●
		α and β alloys, hardened	375	1260	S7	●●	●●
		β alloys	410	1400	S8	●●	●●
Tungsten alloys		300	1010	S9	●	●	
Molybdenum alloys		300	1010	S10	●	●	
H	Hardened steel		50 HRC	–	H1	●	●●
			55 HRC	–	H2, H4		
			60 HRC	–	H3		
O	Thermoplasts	without abrasive fillers			O1	●●	
	Thermosetting plastics	without abrasive fillers			O2		
	Fibre-reinforced plastic	GFRP, AFRP			O3, O5		
		CFRP			O4		
	Graphite (technical)			65	O6		

Walter Select – Drilling

Solid carbide drills without internal cooling

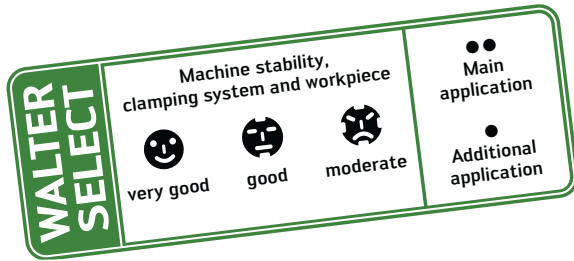

Drilling depth	5 x D _c	
Machining conditions		
Designation	A3378TML	A3162
Type	Alpha® 2 Plus Micro	ESU
Dimensions	Walter standard	DIN 1899
Dia. range (mm)	0,50 – 2,95	0,10 – 1,45
Cutting tool material	K30F	K30F
Coating	TML	uncoated
Page	B 79	B 59

Material group	Grouping of main material groups and identification letters		Brinell hardness HB	Tensile strength R _m N/mm ²	Machining group			
	Workpiece material							
P	Non-alloyed and low alloy steel	annealed (hardened and tempered)	210	700	P1, P2, P3, P4, P7	●●	●	
		machining steels	220	750	P6	●●	●	
		tempered	300	1010	P5, P8	●●	●●	
		tempered	380	1280	P9	●●	●●	
		tempered	430	1480	P10	●●	●●	
	High-alloyed steel and high-alloyed tool steel	annealed	200	670	P11	●●	●●	
hardened and tempered		300	1010	P12	●●	●●		
hardened and tempered		400	1360	P13	●●	●●		
Stainless steel	ferritic/martensitic, annealed	200	670	P14	●●	●●		
	martensitic, tempered	330	1110	P15	●●	●●		
M	Stainless steel	austenitic, duplex	230	780	M1, M3	●●	●●	
		austenitic, precipitation hardened (PH)	300	1010	M2	●●	●●	
K	Grey cast iron		245	–	K3, K4	●●	●●	
	Cast iron with spheroidal graphite	ferritic, pearlitic	365	–	K1, K2, K5, K6	●●	●●	
	GGV (CGI)		200	–	K7	●●	●●	
N	Aluminium wrought alloys	cannot be hardened	30	–	N1	●●	●●	
		hardenable, hardened	100	340	N2	●●	●●	
	Cast aluminium alloys	≤ 12 % Si	90	310	N3, N4	●●	●●	
		> 12 % Si	130	450	N5	●●	●●	
	Magnesium alloys		70	250	N6	●●	●●	
	Copper and copper alloys (bronze/brass)	non-alloyed, electrolytic copper		100	340	N7	●●	●●
brass, bronze, red brass			90	310	N8	●●	●●	
Cu-alloys, short-chipping			110	380	N9	●●	●●	
high-strength, Ampco			300	1010	N10	●●	●●	
S	Heat-resistant alloys	Fe-based	280	940	S1, S2	●●	●●	
		Ni or Co base	250	840	S3	●●	●●	
		Ni or Co base	350	1080	S4, S5	●●	●●	
	Titanium alloys	pure titanium	200	670	S6	●●	●●	
		α and β alloys, hardened	375	1260	S7	●●	●●	
		β alloys	410	1400	S8	●●	●●	
	Tungsten alloys		300	1010	S9	●●	●●	
Molybdenum alloys		300	1010	S10	●●	●●		
H	Hardened steel		50 HRC	–	H1	●		
			55 HRC	–	H2, H4			
			60 HRC	–	H3			
O	Thermoplasts	without abrasive fillers			O1	●●	●●	
	Thermosetting plastics	without abrasive fillers			O2	●●	●●	
	Fibre-reinforced plastic	GFRP, AFRP				O3, O5	●●	●●
		CFRP				O4	●●	●●
	Graphite (technical)			65		O6	●●	●●

Walter Select – Drilling HSS drills

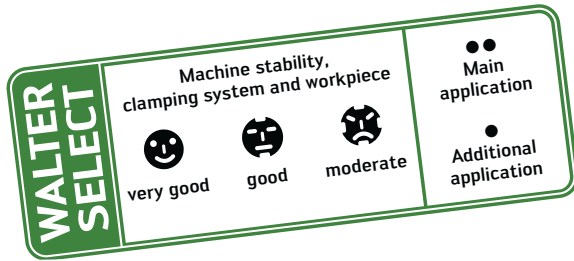

Drilling depth	~3 x D _c	
Machining conditions		
Designation	A1149XPL	A1149TFL
Type	UFL®	UFL®
Dimensions	DIN 1897	DIN 1897
Dia. range (mm)	1,00 – 20,00	1,00 – 20,00
Cutting tool material	HSS-E	HSS-E
Coating	XPL	TFL
Page	B 163	B 158

Material group	Grouping of main material groups and identification letters		Brinell hardness HB	Tensile strength R _m N/mm ²	Machining group			
	Workpiece material							
P	Non-alloyed and low alloy steel	annealed (hardened and tempered)	210	700	P1, P2, P3, P4, P7	●●	●●	
		machining steels	220	750	P6	●●	●●	
		tempered	300	1010	P5, P8	●●	●●	
		tempered	380	1280	P9	●●	●●	
		tempered	430	1480	P10	●●	●●	
	High-alloyed steel and high-alloyed tool steel	annealed	200	670	P11	●●	●●	
hardened and tempered		300	1010	P12	●●	●●		
hardened and tempered		400	1360	P13	●●	●●		
Stainless steel	ferritic/martensitic, annealed	200	670	P14	●●	●●		
	martensitic, tempered	330	1110	P15	●●	●●		
M	Stainless steel	austenitic, duplex	230	780	M1, M3	●●	●●	
		austenitic, precipitation hardened (PH)	300	1010	M2	●●	●●	
K	Grey cast iron		245	–	K3, K4	●●	●●	
	Cast iron with spheroidal graphite	ferritic, pearlitic	365	–	K1, K2, K5, K6	●●	●●	
	GGV (CGI)		200	–	K7	●●	●●	
N	Aluminium wrought alloys	cannot be hardened	30	–	N1			
		hardenable, hardened	100	340	N2			
	Cast aluminium alloys	≤ 12 % Si	90	310	N3, N4	●●	●	
		> 12 % Si	130	450	N5			
	Magnesium alloys		70	250	N6			
	Copper and copper alloys (bronze/brass)	non-alloyed, electrolytic copper		100	340	N7	●●	●●
brass, bronze, red brass			90	310	N8	●●	●●	
Cu-alloys, short-chipping			110	380	N9	●●	●●	
high-strength, Ampco			300	1010	N10	●●	●●	
S	Heat-resistant alloys	Fe-based	280	940	S1, S2	●●	●●	
		Ni or Co base	250	840	S3	●●	●●	
		Ni or Co base	350	1080	S4, S5			
	Titanium alloys	pure titanium	200	670	S6			
		α and β alloys, hardened	375	1260	S7			
		β alloys	410	1400	S8			
Tungsten alloys		300	1010	S9	●●	●●		
Molybdenum alloys		300	1010	S10	●●	●●		
H	Hardened steel		50 HRC	–	H1			
			55 HRC	–	H2, H4			
			60 HRC	–	H3			
O	Thermoplasts	without abrasive fillers			O1	●●	●●	
	Thermosetting plastics	without abrasive fillers			O2	●●	●●	
	Fibre-reinforced plastic	GFRP, AFRP				O3, O5		
		CFRP				O4		
	Graphite (technical)			65		O6		

	~3 x D _c				~5 x D _c		~8 x D _c	
	A1154TFT	A1148	A1111	A2258	A3143	A6292TIN	A1249XPL	A1249TFL
	VA Inox	UFL®	N	UFL® left	ESU	MegaJet	UFL®	UFL®
	DIN 1897	DIN 1897	DIN 1897	DIN 1897	DIN 1899	Walter standard	DIN 338	DIN 338
	2,00 - 16,00	1,00 - 20,00	0,50 - 32,00	1,00 - 20,00	0,05 - 1,45	5,00 - 24,00	1,00 - 16,00	1,00 - 16,00
	HSS-E	HSS-E	HSS	HSS-E	HSS-E	HSS-E	HSS-E	HSS-E
	TFT	Fibre-steamed	Steam treated	uncoated	uncoated	TiN	XPL	TFL
	B 168	B 153	B 141	B 239	B 243	B 269	B 212	B 208
						With internal cooling		
Material	●●	●●	●●	●●	●●	●●	●●	●●
Material	●●	●●	●●	●●	●●	●●	●●	●●
Material		●●	●	●			●●	●●
Material		●●	●				●●	●●
Material		●●	●			●●	●●	●●
Material		●●	●	●●	●●	●●	●●	●●
Material		●●	●	●			●●	●●
Material		●●	●	●●	●●	●●	●●	●●
Material		●●	●	●			●●	●●
Material		●●	●	●			●●	●●
Material	●●	●●	●	●●	●	●●	●●	●●
Material		●●	●	●●	●●	●●	●●	●●
Material		●●	●●	●●	●●	●●	●●	●●
Material		●●	●●	●●	●●	●●	●●	●●
Material		●●	●●	●●	●●	●●	●●	●●
Material		●●	●●	●●	●●	●●	●●	●●
Material		●●	●●	●●	●●	●●	●●	●●
Material		●●	●●	●●	●●	●●	●●	●●
Material		●●	●●	●●	●●	●●	●●	●●
Material		●●	●●	●●	●●	●●	●●	●●
Material		●●	●●	●●	●●	●●	●●	●●
Material	●●	●●	●	●●	●●	●●	●●	●●
Material	●●	●●	●●	●●	●●	●●	●●	●●

Walter Select – Drilling HSS drills

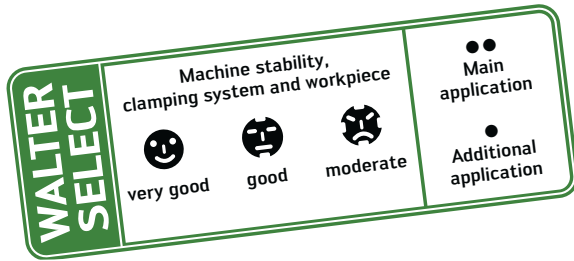

Drilling depth	~8 x D _c	
Machining conditions		
Designation	A1254TFT	A1247
Type	VA Incoz	Alpha® XE
Dimensions	DIN 338	DIN 338
Dia. range (mm)	3,00 – 16,00	1,00 – 16,00
Cutting tool material	HSS-E	HSS-E
Coating	TFT	Fibre-steamed
Page	B 216	B 204

Material group	Grouping of main material groups and identification letters		Brinell hardness HB	Tensile strength R _m N/mm ²	Machining group			
	Workpiece material							
P	Non-alloyed and low alloy steel	annealed (hardened and tempered)	210	700	P1, P2, P3, P4, P7	●●	●	
		machining steels	220	750	P6	●●	●	
		tempered	300	1010	P5, P8		●●	
		tempered	380	1280	P9		●●	
		tempered	430	1480	P10		●●	
	High-alloyed steel and high-alloyed tool steel	annealed	200	670	P11		●●	
hardened and tempered		300	1010	P12		●●		
hardened and tempered		400	1360	P13		●●		
Stainless steel	ferritic/martensitic, annealed	200	670	P14		●●		
	martensitic, tempered	330	1110	P15		●●		
M	Stainless steel	austenitic, duplex	230	780	M1, M3	●●	●●	
		austenitic, precipitation hardened (PH)	300	1010	M2		●●	
K	Grey cast iron		245	–	K3, K4		●●	
	Cast iron with spheroidal graphite	Ferritic, pearlitic	365	–	K1, K2, K5, K6		●●	
	GGV (CGI)		200	–	K7		●●	
N	Aluminium wrought alloys	cannot be hardened	30	–	N1	●●		
		hardenable, hardened	100	340	N2	●●		
	Cast aluminium alloys	≤ 12 % Si	90	310	N3, N4	●●	●●	
		> 12 % Si	130	450	N5			
	Magnesium alloys		70	250	N6	●●	●●	
	Copper and copper alloys (bronze/brass)	non-alloyed, electrolytic copper		100	340	N7	●●	●●
brass, bronze, red brass			90	310	N8	●●	●●	
Cu-alloys, short-chipping			110	380	N9	●●	●●	
high-strength, Ampco			300	1010	N10		●●	
S	Heat-resistant alloys	Fe-based	280	940	S1, S2		●●	
		Ni or Co base	250	840	S3		●●	
		Ni or Co base	350	1080	S4, S5		●●	
	Titanium alloys	pure titanium	200	670	S6	●●	●●	
		α and β alloys, hardened	375	1260	S7		●●	
		β alloys	410	1400	S8		●●	
Tungsten alloys		300	1010	S9		●●		
Molybdenum alloys		300	1010	S10		●●		
H	Hardened steel		50 HRC	–	H1			
			55 HRC	–	H2, H4			
			60 HRC	–	H3			
O	Thermoplasts	without abrasive fillers			O1	●●	●●	
	Thermosetting plastics	without abrasive fillers			O2	●●		
	Fibre-reinforced plastic	GFRP, AFRP				O3, O5		
		CFRP				O4		
	Graphite (technical)			65		O6		

	~8 x D _c						
	A1244	A1222	A1211TIN	A1211	A1212	A1234	A1231
	VA	UFL®	N	N	H	UFL® left	N left
	DIN 338	DIN 338	DIN 338	DIN 338	DIN 338	DIN 338	DIN 338
	0,30 – 15,00	1,00 – 16,00	0,50 – 16,00	0,20 – 22,00	0,4 – 16,00	1,016 – 12,70	0,20 – 20,00
	HSS-E	HSS	HSS	HSS	HSS	HSS	HSS
	uncoated	Fibre-steamed	TiN	Steam treated	uncoated	Fibre-steamed	Steam treated
	B 199	B 185	B 180	B 171	B 182	B 195	B 190
		••	••	••		••	••
		••	••	••		••	••
	••	•	••	•		•	
	••			•			
	••	••	••	•		••	•
	••	•	••	•		•	
	••	••	••	•		••	
	••	•	•	•		•	
	••	••	••	••		••	••
		•	••	••		•	••
		•	••	•		•	•
		••		•		••	
		••		•		••	
		••		•		••	
		••		•		••	
	••	••	••	••	••	••	
	••	••	••	••	••	••	
	••	•		•		•	
	••	•		•		•	
	••	•		•		•	
	••	•		•		•	
	••	•		•		•	
	••	•		•		•	
		••	••	•	••	••	•
		••	••	••	••	••	••

Walter Select – Drilling HSS drills

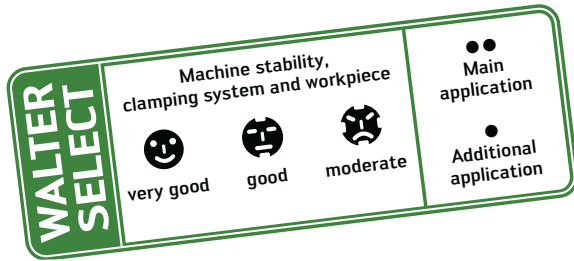

Drilling depth	~12 x D _c	
Machining conditions		
Designation	A1549TFP	A1547
Type	UFL®	Alpha® XE
Dimensions	DIN 340	DIN 340
Dia. range (mm)	1,00 – 12,00	1,00 – 12,70
Cutting tool material	HSS-E	HSS-E
Coating	TFP	Fibre-steamed
Page	B 230	B 227

Material group	Grouping of main material groups and identification letters		Brinell hardness HB	Tensile strength R _m N/mm ²	Machining group		
	Workpiece material						
P	Non-alloyed and low alloy steel	annealed (hardened and tempered)	210	700	P1, P2, P3, P4, P7	●	●
		machining steels	220	750	P6	●	●
		tempered	300	1010	P5, P8	●	●●
		tempered	380	1280	P9	●	●●
		tempered	430	1480	P10	●●	●●
	High-alloyed steel and high-alloyed tool steel	annealed	200	670	P11	●	●●
hardened and tempered		300	1010	P12	●	●●	
hardened and tempered		400	1360	P13	●●	●●	
Stainless steel	ferritic/martensitic, annealed	200	670	P14	●	●●	
	martensitic, tempered	330	1110	P15	●	●●	
M	Stainless steel	austenitic, duplex	230	780	M1, M3	●●	●●
		austenitic, precipitation hardened (PH)	300	1010	M2	●	●●
K	Grey cast iron		245	–	K3, K4	●●	●●
	Cast iron with spheroidal graphite	ferritic, pearlitic	365	–	K1, K2, K5, K6	●●	●●
	GGV (CGI)		200	–	K7	●●	●●
N	Aluminium wrought alloys	cannot be hardened	30	–	N1		
		hardenable, hardened	100	340	N2		
	Cast aluminium alloys	≤ 12 % Si	90	310	N3, N4	●	●●
		> 12 % Si	130	450	N5		
	Magnesium alloys		70	250	N6		●●
	Copper and copper alloys (bronze/brass)	non-alloyed, electrolytic copper	100	340	N7	●	●●
brass, bronze, red brass		90	310	N8	●●	●●	
Cu-alloys, short-chipping		110	380	N9	●●	●●	
high-strength, Ampco		300	1010	N10	●●	●●	
S	Heat-resistant alloys	Fe-based	280	940	S1, S2		●●
		Ni or Co base	250	840	S3	●●	●●
		Ni or Co base	350	1080	S4, S5		●●
	Titanium alloys	pure titanium	200	670	S6		●●
		α and β alloys, hardened	375	1260	S7		●●
		β alloys	410	1400	S8		●●
Tungsten alloys		300	1010	S9	●●	●●	
Molybdenum alloys		300	1010	S10	●●	●●	
H	Hardened steel		50 HRC	–	H1		
			55 HRC	–	H2, H4		
			60 HRC	–	H3		
O	Thermoplasts	without abrasive fillers			O1	●●	●●
	Thermosetting plastics	without abrasive fillers			O2	●●	
	Fibre-reinforced plastic	GFRP, AFRP			O3, O5		
		CFRP			O4		
Graphite (technical)			65		O6		

	~12 x D _c			~16 x D _c	~22 x D _c	~30 x D _c	~60 x D _c
	A1544	A1522	A1511	A1622	A1722	A1822	A1922S
	VA	UFL®	N	UFL®	UFL®	UFL®	UFL®
	DIN 340	DIN 340	DIN 340	DIN 1869 I	DIN 1869 II	DIN 1869 III	Walter standard
	1,00 – 12,00	1,00 – 12,7	0,50 – 22,00	2,00 – 12,70	3,00 – 12,00	3,50 – 12,00	6,00 – 14,00
	HSS-E	HSS	HSS	HSS	HSS	HSS	HSS
	uncoated	Fibre-steamed	Steam treated	Fibre-steamed	Fibre-steamed	Fibre-steamed	Fibre-steamed
	B 225	B 221	B 218	B 232	B 235	B 236	B 238
		••	•	••	••	••	••
		••		••	••	••	••
	•	•	•	•	•	•	•
	••		•				
	•	••	•	••	••	••	••
	••	•	•	•	•	•	•
	•	••	•	••	••	••	••
	••	•	•	•	•	•	•
	••	•	•	•	•	•	•
	••	••	••	••	••	••	••
		•	••	•	•	•	•
		•	•	•	•	•	•
		••	•	••	••	••	••
		••	•	••	••	••	••
		••	•	••	••	••	••
	••	••	•	••	••	••	••
	••	•	•	•	•	•	•
	••	•	•	•	•	•	•
	••	•	•	•	•	•	•
	••	•	•	•	•	•	•
		••	•	••	••	••	••
		••	••	••	••	••	••

Walter Select – Drilling HSS drills

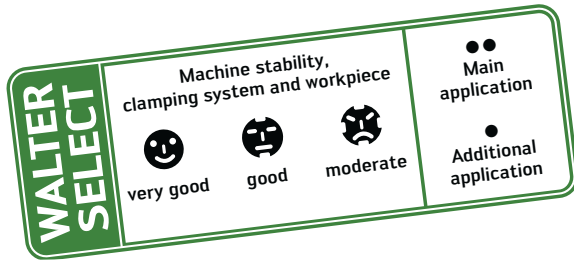

Drilling depth	~85 x D _c	~8 x D _c	
Machining conditions			
Designation	A1922L	A4211TIN	
Type	UFL®	N	
Dimensions	Walter standard	DIN 345	
Dia. range (mm)	8,00 – 12,00	5,00 – 30,00	
Cutting tool material	HSS	HSS	
Coating	Fibre-steamed	TiN	
Page	B 237	B 255	

Material group	Grouping of main material groups and identification letters		Brinell hardness HB	Tensile strength R _m N/mm ²	Machining group		
	Workpiece material						
P	Non-alloyed and low alloy steel	annealed (hardened and tempered)	210	700	P1, P2, P3, P4, P7	●●	●●
		machining steels	220	750	P6	●●	●●
		tempered	300	1010	P5, P8	●	●●
		tempered	380	1280	P9		
		tempered	430	1480	P10		
	High-alloyed steel and high-alloyed tool steel	annealed	200	670	P11	●●	●●
hardened and tempered		300	1010	P12	●	●●	
hardened and tempered		400	1360	P13			
Stainless steel	ferritic/martensitic, annealed	200	670	P14	●●		
	martensitic, tempered	330	1110	P15	●	●●	
M	Stainless steel	austenitic, duplex	230	780	M1, M3	●	
		austenitic, precipitation hardened (PH)	300	1010	M2	●	●
K	Grey cast iron		245	–	K3, K4	●●	●●
	Cast iron with spheroidal graphite	ferritic, pearlitic	365	–	K1, K2, K5, K6	●	●●
	GGV (CGI)		200	–	K7	●	●●
N	Aluminium wrought alloys	cannot be hardened	30	–	N1	●●	
		hardenable, hardened	100	340	N2	●●	
	Cast aluminium alloys	≤ 12 % Si	90	310	N3, N4	●●	
		> 12 % Si	130	450	N5		
	Magnesium alloys		70	250	N6	●●	
Copper and copper alloys (bronze/brass)	non-alloyed, electrolytic copper		100	340	N7	●●	●●
	brass, bronze, red brass		90	310	N8	●●	
	Cu-alloys, short-chipping		110	380	N9	●●	●●
	high-strength, Ampco		300	1010	N10	●	
S	Heat-resistant alloys	Fe-based	280	940	S1, S2	●	
		Ni or Co base	250	840	S3	●	
		Ni or Co base	350	1080	S4, S5		
	Titanium alloys	pure titanium	200	670	S6		
		α and β alloys, hardened	375	1260	S7		
		β alloys	410	1400	S8		
Tungsten alloys		300	1010	S9	●		
Molybdenum alloys		300	1010	S10	●		
H	Hardened steel		50 HRC	–	H1		
			55 HRC	–	H2, H4		
			60 HRC	–	H3		
O	Thermoplasts	without abrasive fillers			O1	●●	
	Thermosetting plastics	without abrasive fillers			O2	●●	●●
	Fibre-reinforced plastic	GFRP, AFRP			O3, O5		
		CFRP			O4		
Graphite (technical)			65		O6		

Walter Select – Drilling HSS drills

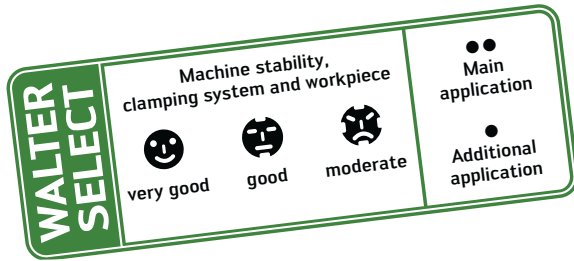

Type	NC spot drill	
Machining conditions		
Designation	A1115; A1115S; A1115L	A1114; A1114S; A1114L
Form	90°	120°
Dimensions	Walter standard	Walter standard
Dia. range (mm)	2,00 – 25,40	2,00 – 25,40
Cutting tool material	HSS	HSS
Coating	uncoated	uncoated
Page	B 149	B 146

Material group	Grouping of main material groups and identification letters	Workpiece material	Brinell hardness HB	Tensile strength R _m N/mm ²	Machining group	Drill images		
P	Non-alloyed and low alloy steel	annealed (hardened and tempered)	210	700	P1, P2, P3, P4, P7	●●	●●	
		machining steels	220	750	P6	●●	●●	
		tempered	300	1010	P5, P8	●	●	
		tempered	380	1280	P9	●	●	
		tempered	430	1480	P10	●	●	
	High-alloyed steel and high-alloyed tool steel	annealed	200	670	P11	●	●	
		hardened and tempered	300	1010	P12	●	●	
hardened and tempered		400	1360	P13	●	●		
Stainless steel	ferritic/martensitic, annealed	200	670	P14	●	●		
	martensitic, tempered	330	1110	P15	●	●		
M	Stainless steel	austenitic, duplex	230	780	M1, M3	●	●	
		austenitic, precipitation hardened (PH)	300	1010	M2	●	●	
K	Grey cast iron		245	–	K3, K4	●●	●●	
	Cast iron with spheroidal graphite	ferritic, pearlitic	365	–	K1, K2, K5, K6	●●	●●	
	GGV (CGI)		200	–	K7	●	●	
N	Aluminium wrought alloys	cannot be hardened	30	–	N1	●	●	
		hardenable, hardened	100	340	N2	●	●	
	Cast aluminium alloys	≤ 12 % Si	90	310	N3, N4	●	●	
		> 12 % Si	130	450	N5			
	Magnesium alloys		70	250	N6			
	Copper and copper alloys (bronze/brass)	non-alloyed, electrolytic copper		100	340	N7	●●	●●
brass, bronze, red brass			90	310	N8	●●	●●	
Cu-alloys, short-chipping			110	380	N9	●	●	
high-strength, Ampco			300	1010	N10	●	●	
S	Heat-resistant alloys	Fe-based	280	940	S1, S2	●	●	
		Ni or Co base	250	840	S3	●	●	
		Ni or Co base	350	1080	S4, S5			
	Titanium alloys	pure titanium	200	670	S6	●	●	
		α and β alloys, hardened	375	1260	S7	●	●	
		β alloys	410	1400	S8	●	●	
	Tungsten alloys		300	1010	S9	●	●	
Molybdenum alloys		300	1010	S10	●	●		
H	Hardened steel		50 HRC	–	H1			
			55 HRC	–	H2, H4			
			60 HRC	–	H3			
O	Thermoplasts	without abrasive fillers			O1	●	●	
	Thermosetting plastics	without abrasive fillers			O2	●●	●●	
	Fibre-reinforced plastic	GFRP, AFRP				O3, O5		
		CFRP				O4		
	Graphite (technical)			65		O6		

Solid carbide twist drill A1163

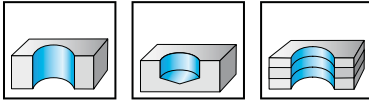

 3 x D_c

- K30F - uncoated
- Type N
- right-hand cutting
- 118° point angle

	P	M	K	N	S	H	O
uncoated			●	●●	●●		●●

DIN 6539

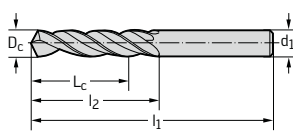
Cylindrical shank



D _c h7 mm	d ₁ h6 mm	L _c mm	l ₁ mm	l ₂ mm	Designation A1163
1	1	4	26	6	-1
1,1	1,1	5	28	7	-1.1
1,2	1,2	6	30	8	-1.2
1,3	1,3	6	30	8	-1.3
1,4	1,4	6	32	9	-1.4
1,5	1,5	6	32	9	-1.5
1,6	1,6	7	34	10	-1.6
1,7	1,7	7	34	10	-1.7
1,8	1,8	8	36	11	-1.8
1,9	1,9	8	36	11	-1.9
2	2	8	38	12	-2
2,1	2,1	8	38	12	-2.1
2,2	2,2	9	40	13	-2.2
2,3	2,3	9	40	13	-2.3
2,4	2,4	10	43	14	-2.4
2,5	2,5	10	43	14	-2.5
2,6	2,6	10	43	14	-2.6
2,7	2,7	11	46	16	-2.7
2,8	2,8	11	46	16	-2.8
2,9	2,9	11	46	16	-2.9
3	3	11	46	16	-3
3,1	3,1	12	49	18	-3.1
3,2	3,2	12	49	18	-3.2
3,3	3,3	12	49	18	-3.3
3,4	3,4	14	52	20	-3.4
3,5	3,5	14	52	20	-3.5
3,6	3,6	14	52	20	-3.6
3,7	3,7	14	52	20	-3.7
3,8	3,8	15	55	22	-3.8
3,9	3,9	15	55	22	-3.9
4	4	15	55	22	-4
4,1	4,1	15	55	22	-4.1
4,2	4,2	15	55	22	-4.2
4,3	4,3	16	58	24	-4.3
4,4	4,4	16	58	24	-4.4
4,5	4,5	16	58	24	-4.5
4,6	4,6	16	58	24	-4.6
4,7	4,7	16	58	24	-4.7
4,8	4,8	18	62	26	-4.8
4,9	4,9	18	62	26	-4.9
5	5	18	62	26	-5
5,1	5,1	18	62	26	-5.1
5,2	5,2	18	62	26	-5.2
5,3	5,3	18	62	26	-5.3
5,4	5,4	19	66	28	-5.4
5,5	5,5	19	66	28	-5.5
5,6	5,6	19	66	28	-5.6

Continued



Solid carbide twist drill A1163



3 x D_c

Continued

	P	M	K	N	S	H	O
uncoated			●	●●	●●●		●●

DIN 6539	D _c h7 mm	d ₁ h6 mm	L _c mm	l ₁ mm	l ₂ mm	Designation A1163
Cylindrical shank 	5,7	5,7	19	66	28	-5.7
	5,8	5,8	19	66	28	-5.8
	5,9	5,9	19	66	28	-5.9
	6	6	19	66	28	-6
	6,1	6,1	20	70	31	-6.1
	6,2	6,2	20	70	31	-6.2
	6,3	6,3	20	70	31	-6.3
	6,4	6,4	20	70	31	-6.4
	6,5	6,5	20	70	31	-6.5
	6,6	6,6	20	70	31	-6.6
	6,7	6,7	20	70	31	-6.7
	6,8	6,8	22	74	34	-6.8
6,9	6,9	22	74	34	-6.9	
7	7	22	74	34	-7	
7,1	7,1	22	74	34	-7.1	
7,2	7,2	22	74	34	-7.2	
7,3	7,3	22	74	34	-7.3	
7,4	7,4	22	74	34	-7.4	
7,5	7,5	22	74	34	-7.5	
7,6	7,6	25	79	37	-7.6	
7,7	7,7	25	79	37	-7.7	
7,8	7,8	25	79	37	-7.8	
7,9	7,9	25	79	37	-7.9	
8	8	25	79	37	-8	
8,1	8,1	24	79	37	-8.1	
8,2	8,2	24	79	37	-8.2	
8,3	8,3	24	79	37	-8.3	
8,4	8,4	24	79	37	-8.4	
8,5	8,5	24	79	37	-8.5	
8,6	8,6	25	84	40	-8.6	
8,7	8,7	25	84	40	-8.7	
8,8	8,8	25	84	40	-8.8	
8,9	8,9	25	84	40	-8.9	
9	9	25	84	40	-9	
9,1	9,1	25	84	40	-9.1	
9,2	9,2	25	84	40	-9.2	
9,3	9,3	25	84	40	-9.3	
9,4	9,4	25	84	40	-9.4	
9,5	9,5	25	84	40	-9.5	
9,6	9,6	28	89	43	-9.6	
9,7	9,7	28	89	43	-9.7	
9,8	9,8	28	89	43	-9.8	
9,9	9,9	28	89	43	-9.9	
10	10	28	89	43	-10	
10,2	10,2	27	89	43	-10.2	
10,5	10,5	27	89	43	-10.5	
11	11	29	95	47	-11	
11,5	11,5	29	95	47	-11.5	
12	12	33	102	51	-12	

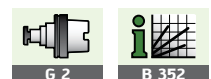

Solid carbide twist drill

A1164TIN

Alpha® 2



3 x D_c

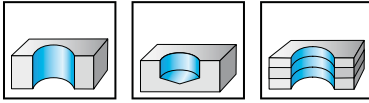

- K30F - TiN
- Type Alpha® 2
- right-hand cutting
- 140° point angle
- up to 1.9 mm dimensions in acc. with DIN 1897

Special features:
45 - 55 HRC

	P	M	K	N	S	H	O
TiN	●●	●●	●●	●●	●●	●	●●

DIN 6539	D _c h7 mm	D _c Inches/No	d ₁ h6 mm	L _c mm	l ₁ mm	l ₂ mm	Designation A1164TIN
Cylindrical shank 	1,5		1,5	6	32	9	-1.5
	1,588	1/16"	1,588	7	34	10	-1/16IN
	1,6		1,6	7	34	10	-1.6
	1,7		1,7	7	34	10	-1.7
	1,8		1,8	8	36	11	-1.8
	1,82		1,82	8	36	11	-1.82
	1,9		1,9	8	36	11	-1.9
	1,984	5/64"	1,984	8	38	12	-5/64IN
	2		2	8	38	12	-2
	2,05		2,05	8	38	12	-2.05
	2,1		2,1	8	38	12	-2.1
	2,2		2,2	9	40	13	-2.2
	2,3		2,3	9	40	13	-2.3
	2,381	3/32"	2,381	10	43	14	-3/32IN
	2,4		2,4	10	43	14	-2.4
	2,5		2,5	10	43	14	-2.5
	2,6		2,6	10	43	14	-2.6
	2,7		2,7	11	46	16	-2.7
	2,778	7/64"	2,778	11	46	16	-7/64IN
	2,8		2,8	11	46	16	-2.8
	2,9		2,9	11	46	16	-2.9
	3		3	11	46	16	-3
	3,1		3,1	12	49	18	-3.1
	3,175	1/8"	3,175	12	49	18	-1/8IN
	3,2		3,2	12	49	18	-3.2
	3,25		3,25	12	49	18	-3.25
	3,3		3,3	12	49	18	-3.3
	3,4		3,4	14	52	20	-3.4
	3,5		3,5	14	52	20	-3.5
	3,572	9/64"	3,572	14	52	20	-9/64IN
	3,6		3,6	14	52	20	-3.6
	3,65		3,65	14	52	20	-3.65
	3,7		3,7	14	52	20	-3.7
	3,8		3,8	15	55	22	-3.8
3,9		3,9	15	55	22	-3.9	
3,969	5/32"	3,969	15	55	22	-5/32IN	
4		4	15	55	22	-4	
4,1		4,1	15	55	22	-4.1	
4,2		4,2	15	55	22	-4.2	
4,3		4,3	16	58	24	-4.3	
4,366	11/64"	4,366	16	58	24	-11/64IN	
4,4		4,4	16	58	24	-4.4	
4,5		4,5	16	58	24	-4.5	
4,6		4,6	16	58	24	-4.6	
4,65		4,65	16	58	24	-4.65	
4,7		4,7	16	58	24	-4.7	
4,763	3/16"	4,763	18	62	26	-3/16IN	

Continued





Solid carbide twist drill
A1164TIN
Alpha® 2
3 x D_c

Continued

TiN	P	M	K	N	S	H	O
	●●	●●	●●	●●	●●	●	●●

DIN 6539	D _c h7 mm	D _c Inches/No	d ₁ h6 mm	L _c mm	l ₁ mm	l ₂ mm	Designation A1164TIN	
Cylindrical shank 	4,8		4,8	18	62	26	-4.8	
	4,9		4,9	18	62	26	-4.9	
	5		5	18	62	26	-5	
	5,1		5,1	18	62	62	26	-5.1
	5,159	13/64"	5,159	18	62	62	26	-13/64IN
	5,2		5,2	18	62	62	26	-5.2
	5,3		5,3	18	62	62	26	-5.3
	5,4		5,4	19	66	66	28	-5.4
	5,5		5,5	19	66	66	28	-5.5
	5,55		5,55	19	66	66	28	-5.55
	5,556	7/32"	5,556	19	66	66	28	-7/32IN
	5,6		5,6	19	66	66	28	-5.6
	5,7		5,7	19	66	66	28	-5.7
	5,8		5,8	19	66	66	28	-5.8
	5,9		5,9	19	66	66	28	-5.9
	5,953	15/64"	5,953	19	66	66	28	-15/64IN
	6		6	19	66	66	28	-6
	6,1		6,1	20	70	70	31	-6.1
	6,2		6,2	20	70	70	31	-6.2
	6,3		6,3	20	70	70	31	-6.3
	6,35	1/4"	6,35	20	70	70	31	-1/4IN
	6,4		6,4	20	70	70	31	-6.4
	6,5		6,5	20	70	70	31	-6.5
	6,6		6,6	20	70	70	31	-6.6
	6,7		6,7	20	70	70	31	-6.7
	6,747	17/64"	6,747	22	74	74	34	-17/64IN
	6,8		6,8	22	74	74	34	-6.8
	6,9		6,9	22	74	74	34	-6.9
	7		7	22	74	74	34	-7
	7,1		7,1	22	74	74	34	-7.1
	7,144	9/32"	7,144	22	74	74	34	-9/32IN
	7,2		7,2	22	74	74	34	-7.2
	7,3		7,3	22	74	74	34	-7.3
	7,4		7,4	22	74	74	34	-7.4
	7,5		7,5	22	74	74	34	-7.5
	7,541	19/64"	7,541	25	79	79	37	-19/64IN
7,55		7,55	25	79	79	37	-7.55	
7,6		7,6	25	79	79	37	-7.6	
7,7		7,7	25	79	79	37	-7.7	
7,8		7,8	25	79	79	37	-7.8	
7,9		7,9	25	79	79	37	-7.9	
7,938	5/16"	7,938	25	79	79	37	-5/16IN	
8		8	25	79	79	37	-8	
8,1		8,1	24	79	79	37	-8.1	
8,2		8,2	24	79	79	37	-8.2	
8,3		8,3	24	79	79	37	-8.3	
8,334	21/64"	8,334	24	79	79	37	-21/64IN	
8,4		8,4	24	79	79	37	-8.4	
8,5		8,5	24	79	79	37	-8.5	
8,6		8,6	25	84	84	40	-8.6	
8,7		8,7	25	84	84	40	-8.7	
8,731	11/32"	8,731	25	84	84	40	-11/32IN	
8,8		8,8	25	84	84	40	-8.8	
8,9		8,9	25	84	84	40	-8.9	
9		9	25	84	84	40	-9	

Continued



Solid carbide twist drill

A1164TIN

Alpha® 2

3 x D_c



Continued

	P	M	K	N	S	H	O
TiN	●●	●●	●●	●●	●●	●	●●

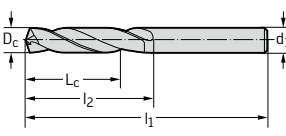
DIN 6539	D _c h7 mm	D _c Inches/No	d ₁ h6 mm	L _c mm	l ₁ mm	l ₂ mm	Designation A1164TIN
Cylindrical shank	9,1		9,1	25	84	40	-9.1
	9,128	23/64"	9,128	25	84	40	-23/64IN
	9,2		9,2	25	84	40	-9.2
	9,3		9,3	25	84	40	-9.3
	9,4		9,4	25	84	40	-9.4
	9,5		9,5	25	84	40	-9.5
	9,525	3/8"	9,525	28	89	43	-3/8IN
	9,55		9,55	28	89	43	-9.55
	9,6		9,6	28	89	43	-9.6
	9,7		9,7	28	89	43	-9.7
	9,8		9,8	28	89	43	-9.8
	9,9		9,9	28	89	43	-9.9
	9,922	25/64"	9,922	28	89	43	-25/64IN
	10		10	28	89	43	-10
	10,1		10,1	27	89	43	-10.1
	10,2		10,2	27	89	43	-10.2
	10,3		10,3	27	89	43	-10.3
	10,319	13/32"	10,319	27	89	43	-13/32IN
	10,4		10,4	27	89	43	-10.4
	10,5		10,5	27	89	43	-10.5
	10,6		10,6	27	89	43	-10.6
	10,7		10,7	29	95	47	-10.7
	10,716	27/64"	10,716	29	95	47	-27/64IN
	10,8		10,8	29	95	47	-10.8
	10,9		10,9	29	95	47	-10.9
	11		11	29	95	47	-11
	11,1		11,1	29	95	47	-11.1
	11,113	7/16"	11,113	29	95	47	-7/16IN
	11,2		11,2	29	95	47	-11.2
	11,3		11,3	29	95	47	-11.3
	11,4		11,4	29	95	47	-11.4
	11,5		11,5	29	95	47	-11.5
	11,509	29/64"	11,509	29	95	47	-29/64IN
	11,55		11,55	29	95	47	-11.55
	11,6		11,6	29	95	47	-11.6
	11,7		11,7	29	95	47	-11.7
	11,8		11,8	29	95	47	-11.8
	11,9		11,9	33	102	51	-11.9
	11,906	15/32"	11,906	33	102	51	-15/32IN
	12		12	33	102	51	-12
	12,1		12,1	37	102	51	-12.1
	12,2		12,2	37	102	51	-12.2
	12,25		12,25	37	102	51	-12.25
	12,3		12,3	37	102	51	-12.3
	12,303	31/64"	12,303	37	102	51	-31/64IN
	12,4		12,4	37	102	51	-12.4
	12,5		12,5	37	102	51	-12.5
	12,6		12,6	37	102	51	-12.6
	12,7	1/2"	12,7	37	102	51	-1/2IN
	12,75		12,75	37	102	51	-12.75
	12,8		12,8	37	102	51	-12.8
	12,9		12,9	37	102	51	-12.9
	13		13	37	102	51	-13
	13,1		13,1	37	102	51	-13.1
	13,2		13,2	37	102	51	-13.2

Continued





Solid carbide twist drill
A1164TIN
Alpha® 2
3 x D_c

Continued

	P	M	K	N	S	H	O
TiN	●●	●●	●●	●●	●●	●	●●

DIN 6539	D _c h7 mm	D _c Inches/No	d ₁ h6 mm	L _c mm	l ₁ mm	l ₂ mm	Designation A1164TIN
Cylindrical shank	13,3		13,3	40	107	54	-13.3
	13,4		13,4	40	107	54	-13.4
	13,494	17/32"	13,494	40	107	54	-17/32IN
	13,5		13,5	40	107	54	-13.5
	13,6		13,6	40	107	54	-13.6
	13,7		13,7	40	107	54	-13.7
	13,8		13,8	40	107	54	-13.8
	13,9		13,9	40	107	54	-13.9
	14		14	40	107	54	-14
	14,1		14,1	41	111	56	-14.1
	14,2		14,2	41	111	56	-14.2
	14,288	9/16"	14,288	41	111	56	-9/16IN
	14,3		14,3	41	111	56	-14.3
	14,4		14,4	41	111	56	-14.4
	14,5		14,5	41	111	56	-14.5
	14,6		14,6	41	111	56	-14.6
	14,7		14,7	41	111	56	-14.7
	14,75		14,75	41	111	56	-14.75
	14,8		14,8	41	111	56	-14.8
	14,9		14,9	41	111	56	-14.9
	15		15	41	111	56	-15
	15,1		15,1	42	115	58	-15.1
	15,2		15,2	42	115	58	-15.2
	15,3		15,3	42	115	58	-15.3
	15,4		15,4	42	115	58	-15.4
	15,5		15,5	42	115	58	-15.5
	15,6		15,6	42	115	58	-15.6
	15,7		15,7	42	115	58	-15.7
	15,8		15,8	42	115	58	-15.8
	15,875	5/8"	15,875	42	115	58	-5/8IN
	15,9		15,9	42	115	58	-15.9
	16		16	42	115	58	-16
	16,5		16,5	43	119	60	-16.5
	17		17	43	119	60	-17
	17,5		17,5	44	123	62	-17.5
	18		18	44	123	62	-18
	18,5		18,5	45	127	64	-18.5
	19		19	45	127	64	-19
	19,05	3/4"	19,05	46	131	66	-3/4IN
	19,5		19,5	46	131	66	-19.5
	20		20	46	131	66	-20

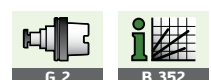
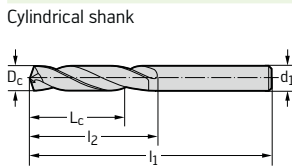

Solid carbide maximiza A1166



3 x D_c

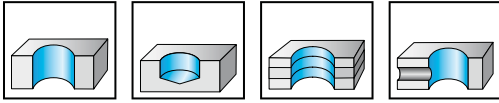

- K30F - uncoated
- right-hand cutting
- 150° point angle
- overall length DIN 6539, flutes lengthened compared to DIN 6539

Special features:
45 - 55 HRC

	P	M	K	N	S	H	O
uncoated	●	●	●	●	●	●	●

	D _c h7 mm	D _c Inches/No	d ₁ h6 mm	L _c mm	l ₁ mm	l ₂ mm	Designation A1166
Cylindrical shank 	3		3	17	46	22	-3
	3,1		3,1	18	49	24	-3.1
	3,175	1/8"	3,175	18	49	24	-1/8IN
	3,2		3,2	18	49	24	-3.2
	3,3		3,3	18	49	24	-3.3
	3,4		3,4	21	52	27	-3.4
	3,5		3,5	21	52	27	-3.5
	3,572	9/64"	3,572	21	52	27	-9/64IN
	3,6		3,6	21	52	27	-3.6
	3,7		3,7	21	52	27	-3.7
	3,8		3,8	23	55	30	-3.8
	3,9		3,9	23	55	30	-3.9
	3,969	5/32"	3,969	23	55	30	-5/32IN
	4		4	23	55	30	-4
	4,1		4,1	23	55	30	-4.1
	4,2		4,2	23	55	30	-4.2
	4,3		4,3	24	58	32	-4.3
	4,366	11/64"	4,366	24	58	32	-11/64IN
	4,4		4,4	24	58	32	-4.4
	4,5		4,5	24	58	32	-4.5
	4,6		4,6	24	58	32	-4.6
	4,7		4,7	24	58	32	-4.7
	4,763	3/16"	4,763	27	62	35	-3/16IN
	4,8		4,8	27	62	35	-4.8
	4,9		4,9	27	62	35	-4.9
	5		5	27	62	35	-5
	5,1		5,1	27	62	35	-5.1
	5,159	13/64"	5,159	27	62	35	-13/64IN
	5,2		5,2	27	62	35	-5.2
	5,3		5,3	27	62	35	-5.3
	5,4		5,4	30	66	39	-5.4
	5,5		5,5	30	66	39	-5.5
	5,556	7/32"	5,556	30	66	39	-7/32IN
5,6		5,6	30	66	39	-5.6	
5,7		5,7	30	66	39	-5.7	
5,8		5,8	30	66	39	-5.8	
5,9		5,9	30	66	39	-5.9	
5,953	15/64"	5,953	30	66	39	-15/64IN	
6		6	30	66	39	-6	
6,1		6,1	31	70	42	-6.1	
6,2		6,2	31	70	42	-6.2	
6,3		6,3	31	70	42	-6.3	
6,35	1/4"	6,35	31	70	42	-1/4IN	
6,4		6,4	31	70	42	-6.4	
6,5		6,5	31	70	42	-6.5	
6,6		6,6	31	70	42	-6.6	
6,7		6,7	31	70	42	-6.7	

Continued





Solid carbide maximiza A1166

3 x D_c

Continued

	P	M	K	N	S	H	O
uncoated	●	●	●	●	●	●	●

	D _c h7 mm	D _c Inches/No	d ₁ h6 mm	L _c mm	l ₁ mm	l ₂ mm	Designation A1166
Cylindrical shank 	6,747	17/64"	6,747	33	74	45	-17/64IN
	6,8		6,8	33	74	45	-6.8
	6,9		6,9	33	74	45	-6.9
	7		7	33	74	45	-7
	7,1		7,1	33	74	45	-7.1
	7,144	9/32"	7,144	33	74	45	-9/32IN
	7,2		7,2	33	74	45	-7.2
	7,3		7,3	33	74	45	-7.3
	7,4		7,4	33	74	45	-7.4
	7,5		7,5	33	74	45	-7.5
7,541	19/64"	7,541	35	79	48	-19/64IN	
7,6		7,6	35	79	48	-7.6	
7,7		7,7	35	79	48	-7.7	
7,8		7,8	35	79	48	-7.8	
7,9		7,9	35	79	48	-7.9	
7,938	5/16"	7,938	35	79	48	-5/16IN	
8		8	35	79	48	-8	
8,1		8,1	35	79	48	-8.1	
8,2		8,2	35	79	48	-8.2	
8,3		8,3	35	79	48	-8.3	
8,334	21/64"	8,334	35	79	48	-21/64IN	
8,4		8,4	35	79	48	-8.4	
8,5		8,5	35	79	48	-8.5	
8,6		8,6	37	84	52	-8.6	
8,7		8,7	37	84	52	-8.7	
8,731	11/32"	8,731	37	84	52	-11/32IN	
8,8		8,8	37	84	52	-8.8	
8,9		8,9	37	84	52	-8.9	
9		9	37	84	52	-9	
9,1		9,1	37	84	52	-9.1	
9,128	23/64"	9,128	37	84	52	-23/64IN	
9,2		9,2	37	84	52	-9.2	
9,3		9,3	37	84	52	-9.3	
9,4		9,4	37	84	52	-9.4	
9,5		9,5	37	84	52	-9.5	
9,525	3/8"	9,525	39	89	55	-3/8IN	
9,6		9,6	39	89	55	-9.6	
9,7		9,7	39	89	55	-9.7	
9,8		9,8	39	89	55	-9.8	
9,9		9,9	39	89	55	-9.9	
9,922	25/64"	9,922	39	89	55	-25/64IN	
10		10	39	89	55	-10	
10,1		10,1	39	89	55	-10.1	
10,2		10,2	39	89	55	-10.2	
10,3		10,3	39	89	55	-10.3	
10,319	13/32"	10,319	39	89	55	-13/32IN	
10,4		10,4	39	89	55	-10.4	
10,5		10,5	39	89	55	-10.5	
10,6		10,6	39	89	55	-10.6	
10,7		10,7	42	95	60	-10.7	
10,716	27/64"	10,716	42	95	60	-27/64IN	
10,8		10,8	42	95	60	-10.8	
10,9		10,9	42	95	60	-10.9	
11		11	42	95	60	-11	
11,1		11,1	42	95	60	-11.1	

Continued



Solid carbide maximiza A1166



3 x D_c

Continued

	P	M	K	N	S	H	O
uncoated	●	●	●	●	●	●	●

	D _c h7 mm	D _c Inches/No	d ₁ h6 mm	L _c mm	l ₁ mm	l ₂ mm	Designation A1166
Cylindrical shank 	11,113	7/16"	11,113	42	95	60	-7/16IN
	11,2		11,2	42	95	60	-11.2
	11,3		11,3	42	95	60	-11.3
	11,4		11,4	42	95	60	-11.4
	11,5		11,5	42	95	60	-11.5
	11,509	29/64"	11,509	42	95	60	-29/64IN
	11,6		11,6	42	95	60	-11.6
	11,7		11,7	42	95	60	-11.7
	11,8		11,8	42	95	60	-11.8
	11,9		11,9	51	102	65	-11.9
	11,906	15/32"	11,906	51	102	65	-15/32IN
	12		12	51	102	65	-12
	12,1		12,1	51	102	65	-12.1
	12,2		12,2	51	102	65	-12.2
	12,3		12,3	51	102	65	-12.3
	12,303	31/64"	12,303	51	102	65	-31/64IN
12,4		12,4	51	102	65	-12.4	
12,5		12,5	51	102	65	-12.5	
12,6		12,6	51	102	65	-12.6	
12,7	1/2"	12,7	51	102	65	-1/2IN	
12,8		12,8	51	102	65	-12.8	
12,9		12,9	51	102	65	-12.9	
13		13	51	102	65	-13	
13,1		13,1	51	102	65	-13.1	
13,2		13,2	51	102	65	-13.2	
13,3		13,3	52	107	66	-13.3	
13,4		13,4	52	107	66	-13.4	
13,5		13,5	52	107	66	-13.5	
13,6		13,6	52	107	66	-13.6	
13,7		13,7	52	107	66	-13.7	
13,8		13,8	52	107	66	-13.8	
13,9		13,9	52	107	66	-13.9	
14		14	52	107	66	-14	
14,1		14,1	55	111	70	-14.1	
14,2		14,2	55	111	70	-14.2	
14,288	9/16"	14,288	55	111	70	-9/16IN	
14,3		14,3	55	111	70	-14.3	
14,4		14,4	55	111	70	-14.4	
14,5		14,5	55	111	70	-14.5	
14,6		14,6	55	111	70	-14.6	
14,7		14,7	55	111	70	-14.7	
14,8		14,8	55	111	70	-14.8	
14,9		14,9	55	111	70	-14.9	
15		15	55	111	70	-15	
15,1		15,1	57	115	73	-15.1	
15,2		15,2	57	115	73	-15.2	
15,3		15,3	57	115	73	-15.3	
15,4		15,4	57	115	73	-15.4	
15,5		15,5	57	115	73	-15.5	
15,6		15,6	57	115	73	-15.6	
15,7		15,7	57	115	73	-15.7	
15,8		15,8	57	115	73	-15.8	
15,875	5/8"	15,875	57	115	73	-5/8IN	
15,9		15,9	57	115	73	-15.9	
16		16	57	115	73	-16	

Continued





Solid carbide maximiza A1166

3 x D_c

Continued

	P	M	K	N	S	H	O
uncoated	●	●	●	●	●	●	●

	D _c h7 mm	D _c Inches/No	d ₁ h6 mm	L _c mm	l ₁ mm	l ₂ mm	Designation A1166
	16,5		16,5	56	119	73	-16.5
	17		17	56	119	73	-17
	17,463	11/16"	17,463	58	123	76	-11/16IN
	17,5		17,5	58	123	76	-17.5
	18		18	58	123	76	-18
	18,5		18,5	57	127	76	-18.5
	19		19	57	127	76	-19
	19,05	3/4"	19,05	59	131	79	-3/4IN
	19,5		19,5	59	131	79	-19.5
	20		20	59	131	79	-20



Solid carbide maximiza A1166TIN



3 x D_c

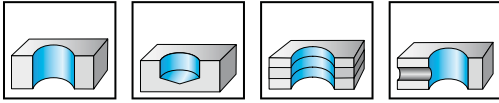

- K30F - TiN
- right-hand cutting
- 150° point angle
- overall length DIN 6539, flutes lengthened compared to DIN 6539

Special features:
45 - 55 HRC

	P	M	K	N	S	H	O
TiN	●					●	

	D _c h7 mm	d ₁ h6 mm	L _c mm	l ₁ mm	l ₂ mm	Designation A1166TiN
Cylindrical shank	3	3	17	46	22	-3
	3,3	3,3	18	49	24	-3.3
	3,5	3,5	21	52	27	-3.5
	4	4	23	55	30	-4
	4,2	4,2	23	55	30	-4.2
	4,5	4,5	24	58	32	-4.5
	4,6	4,6	24	58	32	-4.6
	5	5	27	62	35	-5
	5,5	5,5	30	66	39	-5.5
	6	6	30	66	39	-6
	6,5	6,5	31	70	42	-6.5
	6,8	6,8	33	74	45	-6.8
	7	7	33	74	45	-7
	7,4	7,4	33	74	45	-7.4
	7,5	7,5	33	74	45	-7.5
	7,8	7,8	35	79	48	-7.8
	8	8	35	79	48	-8
	8,5	8,5	35	79	48	-8.5
	9	9	37	84	52	-9
	9,3	9,3	37	84	52	-9.3
	9,5	9,5	37	84	52	-9.5
	10	10	39	89	55	-10
	10,2	10,2	39	89	55	-10.2
	10,5	10,5	39	89	55	-10.5
	11	11	42	95	60	-11
	11,2	11,2	42	95	60	-11.2
	11,5	11,5	42	95	60	-11.5
	12	12	51	102	65	-12
	12,5	12,5	51	102	65	-12.5
	13	13	51	102	65	-13
	13,5	13,5	52	107	66	-13.5
	14	14	52	107	66	-14
	14,5	14,5	55	111	70	-14.5
	15	15	55	111	70	-15
	15,5	15,5	57	115	73	-15.5
	16	16	57	115	73	-16
	16,5	16,5	56	119	73	-16.5
	17	17	56	119	73	-17
	17,5	17,5	58	123	76	-17.5
	18	18	58	123	76	-18
	18,5	18,5	57	127	76	-18.5
	19	19	57	127	76	-19
	19,5	19,5	59	131	79	-19.5
	20	20	59	131	79	-20

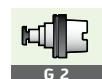



Solid carbide maximiza A1167A

3 x D_c

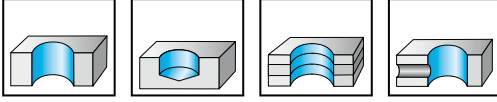

- K30F - uncoated
- right-hand cutting
- 150° point angle
- overall length DIN 6539, flutes lengthened compared to DIN 6539
- 0° rake angle

	P	M	K	N	S	H	O
uncoated			●	●●	●		●

	D _c h7 mm	d ₁ h6 mm	L _c mm	l ₁ mm	l ₂ mm	Designation A1167A
Cylindrical shank	3	3	17	46	22	-3
	3,1	3,1	18	49	24	-3.1
	3,2	3,2	18	49	24	-3.2
	3,3	3,3	18	49	24	-3.3
	3,4	3,4	21	52	27	-3.4
	3,5	3,5	21	52	27	-3.5
	3,6	3,6	21	52	27	-3.6
	3,7	3,7	21	52	27	-3.7
	3,8	3,8	23	55	30	-3.8
	3,9	3,9	23	55	30	-3.9
	4	4	23	55	30	-4
	4,1	4,1	23	55	30	-4.1
	4,2	4,2	23	55	30	-4.2
	4,3	4,3	24	58	32	-4.3
	4,4	4,4	24	58	32	-4.4
	4,5	4,5	24	58	32	-4.5
	4,6	4,6	24	58	32	-4.6
	4,7	4,7	24	58	32	-4.7
	4,8	4,8	27	62	35	-4.8
	4,9	4,9	27	62	35	-4.9
	5	5	27	62	35	-5
	5,1	5,1	27	62	35	-5.1
	5,2	5,2	27	62	35	-5.2
	5,3	5,3	27	62	35	-5.3
	5,4	5,4	30	66	39	-5.4
	5,5	5,5	30	66	39	-5.5
	5,6	5,6	30	66	39	-5.6
	5,7	5,7	30	66	39	-5.7
	5,8	5,8	30	66	39	-5.8
	5,9	5,9	30	66	39	-5.9
	6	6	30	66	39	-6
	6,1	6,1	31	70	42	-6.1
	6,2	6,2	31	70	42	-6.2
	6,3	6,3	31	70	42	-6.3
	6,4	6,4	31	70	42	-6.4
	6,5	6,5	31	70	42	-6.5
	6,6	6,6	31	70	42	-6.6
	6,7	6,7	31	70	42	-6.7
	6,8	6,8	33	74	45	-6.8
	6,9	6,9	33	74	45	-6.9
	7	7	33	74	45	-7
	7,1	7,1	33	74	45	-7.1
	7,2	7,2	33	74	45	-7.2
	7,3	7,3	33	74	45	-7.3
	7,4	7,4	33	74	45	-7.4
	7,5	7,5	33	74	45	-7.5
	7,6	7,6	35	79	48	-7.6

Continued



Solid carbide maximiza A1167A



3 x D_c

Continued

	P	M	K	N	S	H	O
uncoated			●	●●	●		●

	D _c h7 mm	d ₁ h6 mm	L _c mm	l ₁ mm	l ₂ mm	Designation A1167A
Cylindrical shank 	7,7	7,7	35	79	48	-7.7
	7,8	7,8	35	79	48	-7.8
	7,9	7,9	35	79	48	-7.9
	8	8	35	79	48	-8
	8,1	8,1	35	79	48	-8.1
	8,2	8,2	35	79	48	-8.2
	8,3	8,3	35	79	48	-8.3
	8,4	8,4	35	79	48	-8.4
	8,5	8,5	35	79	48	-8.5
	8,6	8,6	37	84	52	-8.6
	8,7	8,7	37	84	52	-8.7
	8,8	8,8	37	84	52	-8.8
	8,9	8,9	37	84	52	-8.9
9	9	37	84	52	-9	
9,1	9,1	37	84	52	-9.1	
9,2	9,2	37	84	52	-9.2	
9,3	9,3	37	84	52	-9.3	
9,4	9,4	37	84	52	-9.4	
9,5	9,5	37	84	52	-9.5	
9,6	9,6	39	89	55	-9.6	
9,7	9,7	39	89	55	-9.7	
9,8	9,8	39	89	55	-9.8	
9,9	9,9	39	89	55	-9.9	
10	10	39	89	55	-10	
10,1	10,1	39	89	55	-10.1	
10,2	10,2	39	89	55	-10.2	
10,3	10,3	39	89	55	-10.3	
10,4	10,4	39	89	55	-10.4	
10,5	10,5	39	89	55	-10.5	
10,6	10,6	39	89	55	-10.6	
10,7	10,7	42	95	60	-10.7	
10,8	10,8	42	95	60	-10.8	
10,9	10,9	42	95	60	-10.9	
11	11	42	95	60	-11	
11,1	11,1	42	95	60	-11.1	
11,2	11,2	42	95	60	-11.2	
11,3	11,3	42	95	60	-11.3	
11,4	11,4	42	95	60	-11.4	
11,5	11,5	42	95	60	-11.5	
11,6	11,6	42	95	60	-11.6	
11,7	11,7	42	95	60	-11.7	
11,8	11,8	42	95	60	-11.8	
11,9	11,9	51	102	65	-11.9	
12	12	51	102	65	-12	
12,1	12,1	51	102	65	-12.1	
12,2	12,2	51	102	65	-12.2	
12,3	12,3	51	102	65	-12.3	
12,4	12,4	51	102	65	-12.4	
12,5	12,5	51	102	65	-12.5	
12,6	12,6	51	102	65	-12.6	
12,7	12,7	51	102	65	-12.7	
12,8	12,8	51	102	65	-12.8	
12,9	12,9	51	102	65	-12.9	
13	13	51	102	65	-13	
13,1	13,1	51	102	65	-13.1	

Continued





Solid carbide maximiza A1167A

3 x D_c

Continued

	P	M	K	N	S	H	O
uncoated			●	●●	●		●

	D _c h7 mm	d ₁ h6 mm	L _c mm	l ₁ mm	l ₂ mm	Designation A1167A
Cylindrical shank	13,2	13,2	51	102	65	-13.2
	13,3	13,3	52	107	66	-13.3
	13,4	13,4	52	107	66	-13.4
	13,5	13,5	52	107	66	-13.5
	13,6	13,6	52	107	66	-13.6
	13,7	13,7	52	107	66	-13.7
	13,8	13,8	52	107	66	-13.8
	13,9	13,9	52	107	66	-13.9
	14	14	52	107	66	-14
	14,1	14,1	55	111	70	-14.1
	14,2	14,2	55	111	70	-14.2
	14,3	14,3	55	111	70	-14.3
	14,4	14,4	55	111	70	-14.4
	14,5	14,5	55	111	70	-14.5
	14,6	14,6	55	111	70	-14.6
	14,7	14,7	55	111	70	-14.7
	14,8	14,8	55	111	70	-14.8
	14,9	14,9	55	111	70	-14.9
	15	15	55	111	70	-15
	15,1	15,1	57	115	73	-15.1
	15,2	15,2	57	115	73	-15.2
	15,3	15,3	57	115	73	-15.3
	15,4	15,4	57	115	73	-15.4
	15,5	15,5	57	115	73	-15.5
	15,6	15,6	57	115	73	-15.6
	15,7	15,7	57	115	73	-15.7
	15,8	15,8	57	115	73	-15.8
	15,9	15,9	57	115	73	-15.9
	16	16	57	115	73	-16
	16,5	16,5	56	119	73	-16.5
	17	17	56	119	73	-17
	17,5	17,5	58	123	76	-17.5
	18	18	58	123	76	-18
	18,5	18,5	57	127	76	-18.5
	19	19	57	127	76	-19
	19,5	19,5	59	131	79	-19.5
	20	20	59	131	79	-20

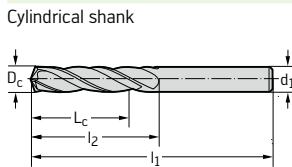

Solid carbide maximiza A1167B



3 x D_c

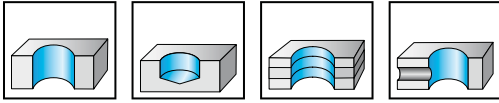

- K30F - uncoated
- right-hand cutting
- 150° point angle
- overall length DIN 6539, flutes lengthened compared to DIN 6539
- 15° rake angle

	P	M	K	N	S	H	O
uncoated				●			

	D _c h7 mm	d ₁ h6 mm	L _c mm	l ₁ mm	l ₂ mm	Designation A1167B
Cylindrical shank	3	3	17	46	22	-3
	3,1	3,1	18	49	24	-3.1
	3,2	3,2	18	49	24	-3.2
	3,3	3,3	18	49	24	-3.3
	3,4	3,4	21	52	27	-3.4
	3,5	3,5	21	52	27	-3.5
	3,6	3,6	21	52	27	-3.6
	3,7	3,7	21	52	27	-3.7
	3,8	3,8	23	55	30	-3.8
	3,9	3,9	23	55	30	-3.9
	4	4	23	55	30	-4
	4,1	4,1	23	55	30	-4.1
	4,2	4,2	23	55	30	-4.2
	4,3	4,3	24	58	32	-4.3
	4,4	4,4	24	58	32	-4.4
	4,5	4,5	24	58	32	-4.5
	4,6	4,6	24	58	32	-4.6
	4,7	4,7	24	58	32	-4.7
	4,8	4,8	27	62	35	-4.8
	4,9	4,9	27	62	35	-4.9
	5	5	27	62	35	-5
	5,1	5,1	27	62	35	-5.1
	5,2	5,2	27	62	35	-5.2
	5,3	5,3	27	62	35	-5.3
	5,4	5,4	30	66	39	-5.4
	5,5	5,5	30	66	39	-5.5
	5,6	5,6	30	66	39	-5.6
	5,7	5,7	30	66	39	-5.7
	5,8	5,8	30	66	39	-5.8
	5,9	5,9	30	66	39	-5.9
	6	6	30	66	39	-6
	6,1	6,1	31	70	42	-6.1
	6,2	6,2	31	70	42	-6.2
	6,3	6,3	31	70	42	-6.3
	6,4	6,4	31	70	42	-6.4
	6,5	6,5	31	70	42	-6.5
	6,6	6,6	31	70	42	-6.6
	6,7	6,7	31	70	42	-6.7
	6,8	6,8	33	74	45	-6.8
	6,9	6,9	33	74	45	-6.9
	7	7	33	74	45	-7
	7,1	7,1	33	74	45	-7.1
	7,2	7,2	33	74	45	-7.2
	7,3	7,3	33	74	45	-7.3
	7,4	7,4	33	74	45	-7.4
	7,5	7,5	33	74	45	-7.5
	7,6	7,6	35	79	48	-7.6

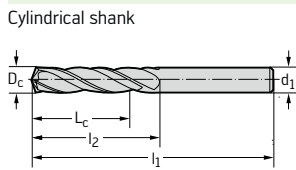

Continued



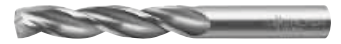

Solid carbide maximiza A1167B

3 x D_c

Continued

	P	M	K	N	S	H	O
uncoated				●			

	D _c h7 mm	d ₁ h6 mm	L _c mm	l ₁ mm	l ₂ mm	Designation A1167B
Cylindrical shank 	7,7	7,7	35	79	48	-7.7
	7,8	7,8	35	79	48	-7.8
	7,9	7,9	35	79	48	-7.9
	8	8	35	79	48	-8
	8,1	8,1	35	79	48	-8.1
	8,2	8,2	35	79	48	-8.2
	8,3	8,3	35	79	48	-8.3
	8,4	8,4	35	79	48	-8.4
	8,5	8,5	35	79	48	-8.5
	8,6	8,6	37	84	52	-8.6
	8,7	8,7	37	84	52	-8.7
	8,8	8,8	37	84	52	-8.8
	8,9	8,9	37	84	52	-8.9
	9	9	37	84	52	-9
	9,1	9,1	37	84	52	-9.1
	9,2	9,2	37	84	52	-9.2
	9,3	9,3	37	84	52	-9.3
	9,4	9,4	37	84	52	-9.4
	9,5	9,5	37	84	52	-9.5
	9,6	9,6	39	89	55	-9.6
	9,7	9,7	39	89	55	-9.7
	9,8	9,8	39	89	55	-9.8
	9,9	9,9	39	89	55	-9.9
	10	10	39	89	55	-10
	10,1	10,1	39	89	55	-10.1
	10,2	10,2	39	89	55	-10.2
	10,3	10,3	39	89	55	-10.3
	10,4	10,4	39	89	55	-10.4
	10,5	10,5	39	89	55	-10.5
	10,6	10,6	39	89	55	-10.6
	10,7	10,7	42	95	60	-10.7
10,8	10,8	42	95	60	-10.8	
10,9	10,9	42	95	60	-10.9	
11	11	42	95	60	-11	
11,1	11,1	42	95	60	-11.1	
11,2	11,2	42	95	60	-11.2	
11,3	11,3	42	95	60	-11.3	
11,4	11,4	42	95	60	-11.4	
11,5	11,5	42	95	60	-11.5	
11,6	11,6	42	95	60	-11.6	
11,7	11,7	42	95	60	-11.7	
11,8	11,8	42	95	60	-11.8	
11,9	11,9	51	102	65	-11.9	
12	12	51	102	65	-12	
12,1	12,1	51	102	65	-12.1	
12,2	12,2	51	102	65	-12.2	
12,3	12,3	51	102	65	-12.3	
12,4	12,4	51	102	65	-12.4	
12,5	12,5	51	102	65	-12.5	
12,6	12,6	51	102	65	-12.6	
12,7	12,7	51	102	65	-12.7	
12,8	12,8	51	102	65	-12.8	
12,9	12,9	51	102	65	-12.9	
13	13	51	102	65	-13	
13,1	13,1	51	102	65	-13.1	

Continued



Solid carbide maximiza A1167B



3 x D_c

Continued

	P	M	K	N	S	H	O
uncoated				●			

	D _c h7 mm	d ₁ h6 mm	L _c mm	l ₁ mm	l ₂ mm	Designation A1167B
Cylindrical shank 	13,2	13,2	51	102	65	-13.2
	13,3	13,3	52	107	66	-13.3
	13,4	13,4	52	107	66	-13.4
	13,5	13,5	52	107	66	-13.5
	13,6	13,6	52	107	66	-13.6
	13,7	13,7	52	107	66	-13.7
	13,8	13,8	52	107	66	-13.8
	13,9	13,9	52	107	66	-13.9
	14	14	52	107	66	-14
	14,1	14,1	55	111	70	-14.1
	14,2	14,2	55	111	70	-14.2
	14,3	14,3	55	111	70	-14.3
	14,4	14,4	55	111	70	-14.4
	14,5	14,5	55	111	70	-14.5
	14,6	14,6	55	111	70	-14.6
	14,7	14,7	55	111	70	-14.7
	14,8	14,8	55	111	70	-14.8
	14,9	14,9	55	111	70	-14.9
	15	15	55	111	70	-15
	15,1	15,1	57	115	73	-15.1
15,2	15,2	57	115	73	-15.2	
15,3	15,3	57	115	73	-15.3	
15,4	15,4	57	115	73	-15.4	
15,5	15,5	57	115	73	-15.5	
15,6	15,6	57	115	73	-15.6	
15,7	15,7	57	115	73	-15.7	
15,8	15,8	57	115	73	-15.8	
15,9	15,9	57	115	73	-15.9	
16	16	57	115	73	-16	
16,5	16,5	56	119	73	-16.5	
17	17	56	119	73	-17	
17,5	17,5	58	123	76	-17.5	
18	18	58	123	76	-18	
18,5	18,5	57	127	76	-18.5	
19	19	57	127	76	-19	
19,5	19,5	59	131	79	-19.5	
20	20	59	131	79	-20	

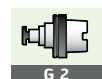

Solid carbide NC spot drill, 90° A1174 90°

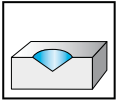

- K30F - uncoated
- Type NC
- right-hand cutting
- 90° point angle

	P	M	K	N	S	H	O
uncoated			●	●●	●●		●●

	D _c h6 mm	D _c Inches/No	d ₁ h6 mm	l ₁ mm	l ₂ mm	Designation A1174
Cylindrical shank	3		3	46	11	-3
	4		4	55	15	-4
	5		5	62	16	-5
	6		6	66	17	-6
	6,35	1/4"	6,35	70	18	-1/4IN
	8		8	79	22	-8
	9,525	3/8"	9,525	89	26	-3/8IN
	10		10	89	26	-10
	12		12	102	30	-12
	12,7	1/2"	12,7	102	30	-1/2IN
	15,875	5/8"	15,875	115	34	-5/8IN
	16		16	115	34	-16
	20		20	131	40	-20

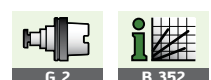
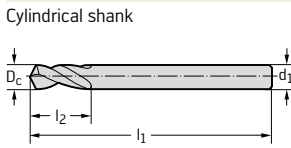

Solid carbide NC spot drill, 120°

A1174C

120°

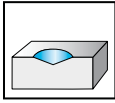

- K30F - uncoated
- Type NC
- right-hand cutting
- 120° point angle

	P	M	K	N	S	H	O
uncoated			●	●●	●●		●●

	D _c h6 mm	D _c Inches/No	d ₁ h6 mm	l ₁ mm	l ₂ mm	Designation A1174C
Cylindrical shank	3		3	46	11	-3
	4		4	55	15	-4
	5		5	62	16	-5
	6		6	66	17	-6
	6,35	1/4"	6,35	70	18	-1/4IN
	8		8	79	22	-8
	9,525	3/8"	9,525	89	26	-3/8IN
	10		10	89	26	-10
	12		12	102	30	-12
	12,7	1/2"	12,7	102	30	-1/2IN
	15,875	5/8"	15,875	115	34	-5/8IN
	16		16	115	34	-16
	20		20	131	40	-20

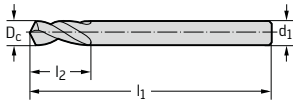

Solid carbide twist drill A1263



8 x D_c

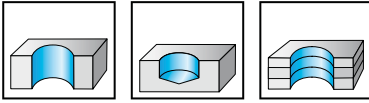

- K30F - uncoated
- Type N
- right-hand cutting
- 118° point angle

	P	M	K	N	S	H	O
uncoated			●	●●	●●		●●

DIN 338	D _c h7 mm	d ₁ h6 mm	L _c mm	l ₁ mm	l ₂ mm	Designation A1263
Cylindrical shank	0,6	0,6	6,1	24	7	-0,6
	0,7	0,7	7,8	28	9	-0,7
	0,8	0,8	8,7	30	10	-0,8
	0,9	0,9	9,5	32	11	-0,9
	1	1	10	34	12	-1
	1,1	1,1	12	36	14	-1,1
	1,2	1,2	14	38	16	-1,2
	1,3	1,3	14	38	16	-1,3
	1,4	1,4	15	40	18	-1,4
	1,5	1,5	15	40	18	-1,5
	1,6	1,6	17	43	20	-1,6
	1,7	1,7	17	43	20	-1,7
	1,8	1,8	19	46	22	-1,8
	1,9	1,9	19	46	22	-1,9
	2	2	20	49	24	-2
	2,1	2,1	20	49	24	-2,1
	2,2	2,2	23	53	27	-2,2
	2,3	2,3	23	53	27	-2,3
	2,4	2,4	26	57	30	-2,4
	2,5	2,5	26	57	30	-2,5
	2,6	2,6	26	57	30	-2,6
	2,7	2,7	28	61	33	-2,7
	2,8	2,8	28	61	33	-2,8
	2,9	2,9	28	61	33	-2,9
	3	3	28	61	33	-3
	3,1	3,1	30	65	36	-3,1
	3,2	3,2	30	65	36	-3,2
	3,3	3,3	30	65	36	-3,3
	3,4	3,4	33	70	39	-3,4
	3,5	3,5	33	70	39	-3,5
	3,6	3,6	33	70	39	-3,6
	3,7	3,7	33	70	39	-3,7
	3,8	3,8	36	75	43	-3,8
	3,9	3,9	36	75	43	-3,9
	4	4	36	75	43	-4
	4,1	4,1	36	75	43	-4,1
	4,2	4,2	36	75	43	-4,2
	4,3	4,3	39	80	47	-4,3
	4,4	4,4	39	80	47	-4,4
	4,5	4,5	39	80	47	-4,5
	4,6	4,6	39	80	47	-4,6
	4,7	4,7	39	80	47	-4,7
	4,8	4,8	44	86	52	-4,8
	4,9	4,9	44	86	52	-4,9
	5	5	44	86	52	-5
	5,1	5,1	44	86	52	-5,1
	5,2	5,2	44	86	52	-5,2

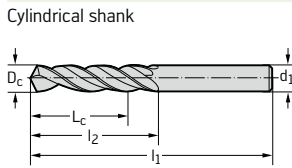

Continued



Solid carbide twist drill A1263

 8 x D_c

Continued

	P	M	K	N	S	H	O
uncoated			●	●●	●●●		●●

DIN 338	D _c h7 mm	d ₁ h6 mm	L _c mm	l ₁ mm	l ₂ mm	Designation A1263
Cylindrical shank	5,3	5,3	44	86	52	-5.3
	5,4	5,4	48	93	57	-5.4
	5,5	5,5	48	93	57	-5.5
	5,6	5,6	48	93	57	-5.6
	5,7	5,7	48	93	57	-5.7
	5,8	5,8	48	93	57	-5.8
	5,9	5,9	48	93	57	-5.9
	6	6	48	93	57	-6
	6,1	6,1	52	101	63	-6.1
	6,2	6,2	52	101	63	-6.2
	6,3	6,3	52	101	63	-6.3
	6,4	6,4	52	101	63	-6.4
	6,5	6,5	52	101	63	-6.5
	6,6	6,6	52	101	63	-6.6
	6,7	6,7	52	101	63	-6.7
	6,8	6,8	57	109	69	-6.8
	6,9	6,9	57	109	69	-6.9
	7	7	57	109	69	-7
	7,1	7,1	57	109	69	-7.1
	7,2	7,2	57	109	69	-7.2
	7,3	7,3	57	109	69	-7.3
	7,4	7,4	57	109	69	-7.4
	7,5	7,5	57	109	69	-7.5
	7,6	7,6	62	117	75	-7.6
	7,7	7,7	62	117	75	-7.7
	7,8	7,8	62	117	75	-7.8
	7,9	7,9	62	117	75	-7.9
	8	8	62	117	75	-8
	8,1	8,1	62	117	75	-8.1
	8,2	8,2	62	117	75	-8.2
	8,3	8,3	62	117	75	-8.3
	8,4	8,4	62	117	75	-8.4
	8,5	8,5	62	117	75	-8.5
	8,6	8,6	66	125	81	-8.6
	8,7	8,7	66	125	81	-8.7
	8,8	8,8	66	125	81	-8.8
	8,9	8,9	66	125	81	-8.9
	9	9	66	125	81	-9
	9,1	9,1	66	125	81	-9.1
	9,2	9,2	66	125	81	-9.2
	9,3	9,3	66	125	81	-9.3
	9,4	9,4	66	125	81	-9.4
	9,5	9,5	66	125	81	-9.5
	9,6	9,6	71	133	87	-9.6
	9,7	9,7	71	133	87	-9.7
	9,8	9,8	71	133	87	-9.8
	9,9	9,9	71	133	87	-9.9
	10	10	71	133	87	-10
	10,2	10,2	71	133	87	-10.2
	10,5	10,5	71	133	87	-10.5
	10,8	10,8	76	142	94	-10.8
	11	11	76	142	94	-11
	11,2	11,2	76	142	94	-11.2
	11,5	11,5	76	142	94	-11.5
	11,8	11,8	76	142	94	-11.8
	12	12	87	151	101	-12

Continued



Solid carbide twist drill A1276TFL Alpha® 22



8 x D_c

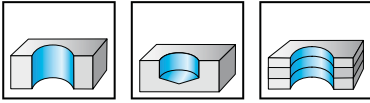

- K30F - TFL
- Type Alpha® 22
- right-hand cutting
- 140° point angle
- 40° right-hand helix

	P	M	K	N	S	H	O
TFL	●●		●●	●●	●●		

DIN 338	D _c h7 mm	d ₁ h6 mm	L _c mm	l ₁ mm	l ₂ mm	Designation A1276TFL
Cylindrical shank 	3	3	28	61	33	-3
	3,1	3,1	30	65	36	-3.1
	3,2	3,2	30	65	36	-3.2
	3,3	3,3	30	65	36	-3.3
	3,4	3,4	33	70	39	-3.4
	3,5	3,5	33	70	39	-3.5
	3,7	3,7	33	70	39	-3.7
	3,8	3,8	36	75	43	-3.8
	4	4	36	75	43	-4
	4,2	4,2	36	75	43	-4.2
	4,3	4,3	39	80	47	-4.3
	4,5	4,5	39	80	47	-4.5
	4,7	4,7	39	80	47	-4.7
	4,8	4,8	44	86	52	-4.8
	5	5	44	86	52	-5
	5,1	5,1	44	86	52	-5.1
	5,2	5,2	44	86	52	-5.2
	5,5	5,5	48	93	57	-5.5
	5,8	5,8	48	93	57	-5.8
	6	6	48	93	57	-6
	6,1	6,1	52	101	63	-6.1
	6,5	6,5	52	101	63	-6.5
	6,6	6,6	52	101	63	-6.6
	6,8	6,8	57	109	69	-6.8
7	7	57	109	69	-7	
7,5	7,5	57	109	69	-7.5	
7,8	7,8	62	117	75	-7.8	
8	8	62	117	75	-8	
8,1	8,1	62	117	75	-8.1	
8,5	8,5	62	117	75	-8.5	
9	9	66	125	81	-9	
9,5	9,5	66	125	81	-9.5	
10	10	71	133	87	-10	
10,2	10,2	71	133	87	-10.2	
10,5	10,5	71	133	87	-10.5	
11	11	76	142	94	-11	
11,5	11,5	76	142	94	-11.5	
12	12	87	151	101	-12	

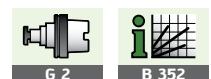

Carbide twist drill A2971



3 x D_c

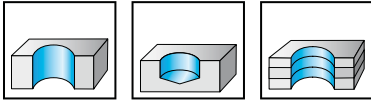

- K10/20 - uncoated
- Type HM
- right-hand cutting
- 118° point angle

	P	M	K	N	S	H	O
uncoated	●	●	●	●	●	●	●

DIN 8037	D _c h8 mm	d ₁ f11 mm	L _c mm	l ₁ mm	l ₂ mm	Designation A2971
Cylindrical shank	3	3	15	50	20	-3
	3,5	3,5	19	56	25	-3.5
	3,8	3,8	19	56	25	-3.8
	4	4	19	56	25	-4
	4,2	4,2	20	63	28	-4.2
	4,5	4,5	20	63	28	-4.5
	4,8	4,8	20	63	28	-4.8
	5	5	20	63	28	-5
	5,2	5,2	22	71	32	-5.2
	5,5	5,5	22	71	32	-5.5
	5,8	5,8	22	71	32	-5.8
	6	6	22	71	32	-6
	6,5	6,5	22	71	32	-6.5
	6,8	6,8	28	80	40	-6.8
	7	7	28	80	40	-7
	7,5	7,5	28	80	40	-7.5
	8	8	28	80	40	-8
	8,5	8,5	35	90	50	-8.5
	9	9	35	90	50	-9
	9,5	9,5	35	90	50	-9.5
	10	10	39	100	56	-10
	10,5	10,5	39	100	56	-10.5
	11	11	39	100	56	-11
	11,5	11,5	50	112	63	-11.5
	12	12	50	112	63	-12
	13	13	50	112	63	-13
	14	14	56	125	71	-14
	15	15	56	125	71	-15
	16	16	64	140	80	-16

Cylindrical shank

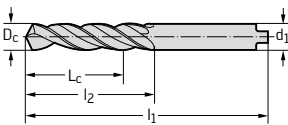

Solid carbide micro drill A3162



5 x D_c

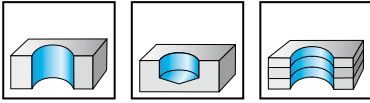

- K30F - uncoated
- Type ESU
- right-hand cutting
- 118° point angle

	P	M	K	N	S	H	O
uncoated	●●	●●	●●	●●	●●		●●

DIN 1899	D _c 0-0,004 mm	d ₁ h8 mm	L _c mm	l ₁ mm	l ₂ mm	Designation A3162
Cylindrical shank	0,1	1	0,3	25	0,5	-0,1
	0,11	1	0,3	25	0,5	-0,11
	0,12	1	0,3	25	0,5	-0,12
	0,13	1	0,5	25	0,8	-0,13
	0,14	1	0,5	25	0,8	-0,14
	0,15	1	0,5	25	0,8	-0,15
	0,16	1	0,8	25	1,1	-0,16
	0,17	1	0,8	25	1,1	-0,17
	0,18	1	0,8	25	1,1	-0,18
	0,19	1	0,8	25	1,1	-0,19
	0,2	1	1,1	25	1,5	-0,2
	0,21	1	1,1	25	1,5	-0,21
	0,22	1	1,1	25	1,5	-0,22
	0,23	1	1,1	25	1,5	-0,23
	0,24	1	1,1	25	1,5	-0,24
	0,25	1	1,4	25	1,9	-0,25
	0,26	1	1,4	25	1,9	-0,26
	0,27	1	1,4	25	1,9	-0,27
	0,28	1	1,4	25	1,9	-0,28
	0,29	1	1,4	25	1,9	-0,29
	0,3	1	1,4	25	1,9	-0,3
	0,31	1	1,8	25	2,4	-0,31
	0,32	1	1,8	25	2,4	-0,32
	0,33	1	1,8	25	2,4	-0,33
	0,34	1	1,8	25	2,4	-0,34
	0,35	1	1,8	25	2,4	-0,35
	0,36	1	1,8	25	2,4	-0,36
	0,37	1	1,8	25	2,4	-0,37
	0,38	1	1,8	25	2,4	-0,38
	0,39	1	2,2	25	3	-0,39
	0,4	1	2,2	25	3	-0,4
	0,41	1	2,2	25	3	-0,41
	0,42	1	2,2	25	3	-0,42
	0,43	1	2,2	25	3	-0,43
	0,44	1	2,2	25	3	-0,44
	0,45	1	2,2	25	3	-0,45
	0,46	1	2,2	25	3	-0,46
	0,47	1	2,2	25	3	-0,47
	0,48	1	2,2	25	3	-0,48
	0,49	1	2,6	25	3,4	-0,49
	0,5	1	2,6	25	3,4	-0,5
	0,51	1	2,6	25	3,4	-0,51
	0,52	1	2,6	25	3,4	-0,52
	0,53	1	2,6	25	3,4	-0,53
	0,54	1	3	25	3,9	-0,54
	0,55	1	3	25	3,9	-0,55
	0,56	1	3	25	3,9	-0,56

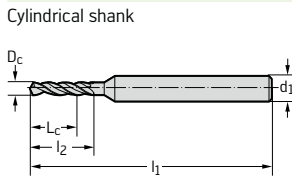

Continued



Solid carbide micro drill A3162

 5 x D_c

Continued

	P	M	K	N	S	H	O
uncoated	●●	●●	●●	●●	●●		●●

DIN 1899	D _c 0-0,004 mm	d ₁ h8 mm	L _c mm	l ₁ mm	l ₂ mm	Designation A3162
Cylindrical shank	0,57	1	3	25	3,9	-0,57
	0,58	1	3	25	3,9	-0,58
	0,59	1	3	25	3,9	-0,59
	0,6	1	3	25	3,9	-0,6
	0,61	1	3,1	25	4,2	-0,61
	0,62	1	3,1	25	4,2	-0,62
	0,63	1	3,1	25	4,2	-0,63
	0,64	1	3,1	25	4,2	-0,64
	0,65	1	3,1	25	4,2	-0,65
	0,66	1	3,1	25	4,2	-0,66
	0,67	1	3,1	25	4,2	-0,67
	0,68	1	3,6	25	4,8	-0,68
	0,69	1	3,6	25	4,8	-0,69
	0,7	1	3,6	25	4,8	-0,7
	0,71	1	3,6	25	4,8	-0,71
	0,72	1	3,6	25	4,8	-0,72
	0,73	1	3,6	25	4,8	-0,73
	0,74	1	3,6	25	4,8	-0,74
	0,75	1	3,6	25	4,8	-0,75
	0,76	1	4,1	25	5,3	-0,76
	0,77	1	4,1	25	5,3	-0,77
	0,78	1	4,1	25	5,3	-0,78
	0,79	1	4,1	25	5,3	-0,79
	0,8	1,5	4	25	5,3	-0,8
	0,81	1,5	4	25	5,3	-0,81
	0,82	1,5	4	25	5,3	-0,82
	0,83	1,5	4	25	5,3	-0,83
	0,84	1,5	4	25	5,3	-0,84
	0,85	1,5	4	25	5,3	-0,85
	0,86	1,5	4,5	25	6	-0,86
	0,87	1,5	4,5	25	6	-0,87
	0,88	1,5	4,5	25	6	-0,88
	0,89	1,5	4,5	25	6	-0,89
	0,9	1,5	4,5	25	6	-0,9
	0,91	1,5	4,5	25	6	-0,91
	0,92	1,5	4,5	25	6	-0,92
	0,93	1,5	4,5	25	6	-0,93
	0,94	1,5	4,5	25	6	-0,94
	0,95	1,5	4,5	25	6	-0,95
	0,96	1,5	5	25	6,8	-0,96
	0,97	1,5	5	25	6,8	-0,97
	0,98	1,5	5	25	6,8	-0,98
	0,99	1,5	5	25	6,8	-0,99
	1	1,5	5	25	6,8	-1
	1,05	1,5	5	25	6,8	-1,05
	1,1	1,5	5	25	7,6	-1,1
	1,15	1,5	5	25	7,6	-1,15
	1,2	1,5	6	25	8,5	-1,2
	1,25	1,5	6	25	8,5	-1,25
	1,3	1,5	6	25	8,5	-1,3
	1,35	1,5	7	25	9,5	-1,35
	1,4	1,5	7	25	9,5	-1,4
	1,45	1,5	7	25	9,5	-1,45

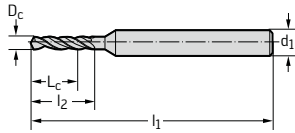

Solid carbide twist drill

A3265TFL

Alpha® 2



3 x D_c

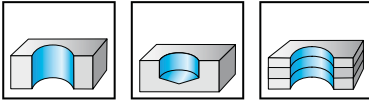

- K30F - TFL
- Type Alpha® 2
- right-hand cutting
- 140° point angle

Special features:
suitable for dry machining in steel
45 - 55 HRC

	P	M	K	N	S	H	O
TFL	●●	●●	●●	●●	●●	●●	

DIN 6537 short	D _c m7 mm	D _c Inches/No	d ₁ h6 mm	L _c mm	l ₁ mm	l ₂ mm	l ₅ mm	Designation A3265TFL
Shank DIN 6535 HA	3		6	14	62	20	36	-3
	3,1		6	14	62	20	36	-3.1
	3,175	1/8"	6	14	62	20	36	-1/8IN
	3,2		6	14	62	20	36	-3.2
	3,25		6	14	62	20	36	-3.25
	3,3		6	14	62	20	36	-3.3
	3,4		6	14	62	20	36	-3.4
	3,5		6	14	62	20	36	-3.5
	3,572	9/64"	6	14	62	20	36	-9/64IN
	3,6		6	14	62	20	36	-3.6
	3,65		6	14	62	20	36	-3.65
	3,7		6	14	62	20	36	-3.7
	3,8		6	17	66	24	36	-3.8
	3,9		6	17	66	24	36	-3.9
	3,969	5/32"	6	17	66	24	36	-5/32IN
	4		6	17	66	24	36	-4
	4,1		6	17	66	24	36	-4.1
	4,2		6	17	66	24	36	-4.2
	4,3		6	17	66	24	36	-4.3
	4,366	11/64"	6	17	66	24	36	-11/64IN
	4,4		6	17	66	24	36	-4.4
	4,5		6	17	66	24	36	-4.5
	4,6		6	17	66	24	36	-4.6
	4,65		6	17	66	24	36	-4.65
	4,7		6	17	66	24	36	-4.7
	4,763	3/16"	6	20	66	28	36	-3/16IN
	4,8		6	20	66	28	36	-4.8
	4,9		6	20	66	28	36	-4.9
	5		6	20	66	28	36	-5
	5,1		6	20	66	28	36	-5.1
	5,159	13/64"	6	20	66	28	36	-13/64IN
	5,2		6	20	66	28	36	-5.2
	5,3		6	20	66	28	36	-5.3
	5,4		6	20	66	28	36	-5.4
	5,5		6	20	66	28	36	-5.5
	5,55		6	20	66	28	36	-5.55
	5,556	7/32"	6	20	66	28	36	-7/32IN
	5,6		6	20	66	28	36	-5.6
	5,7		6	20	66	28	36	-5.7
	5,8		6	20	66	28	36	-5.8
	5,9		6	20	66	28	36	-5.9
	5,953	15/64"	6	20	66	28	36	-15/64IN
	6		6	20	66	28	36	-6
	6,1		8	24	79	34	36	-6.1
	6,2		8	24	79	34	36	-6.2
	6,3		8	24	79	34	36	-6.3
	6,35	1/4"	8	24	79	34	36	-1/4IN

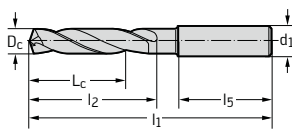

Continued

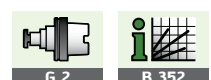

Solid carbide twist drill

A3265TFL

Alpha® 2

 3 x D_c

Continued

TFL	P	M	K	N	S	H	O
	●●	●●	●●	●●	●●	●●	●●

DIN 6537 short	D _c m7 mm	D _c Inches/No	d ₁ h6 mm	L _c mm	l ₁ mm	l ₂ mm	l ₅ mm	Designation A3265TFL
Shank DIN 6535 HA	6,4		8	24	79	34	36	-6.4
	6,5		8	24	79	34	36	-6.5
	6,6		8	24	79	34	36	-6.6
	6,7		8	24	79	34	36	-6.7
	6,747	17/64"	8	24	79	34	36	-17/64IN
	6,8		8	24	79	34	36	-6.8
	6,9		8	24	79	34	36	-6.9
	7		8	24	79	34	36	-7
	7,1		8	29	79	41	36	-7.1
	7,144	9/32"	8	29	79	41	36	-9/32IN
	7,2		8	29	79	41	36	-7.2
	7,3		8	29	79	41	36	-7.3
	7,4		8	29	79	41	36	-7.4
	7,5		8	29	79	41	36	-7.5
	7,541	19/64"	8	29	79	41	36	-19/64IN
	7,55		8	29	79	41	36	-7.55
	7,6		8	29	79	41	36	-7.6
	7,7		8	29	79	41	36	-7.7
	7,8		8	29	79	41	36	-7.8
	7,9		8	29	79	41	36	-7.9
	7,938	5/16"	8	29	79	41	36	-5/16IN
	8		8	29	79	41	36	-8
	8,1		10	35	89	47	40	-8.1
	8,2		10	35	89	47	40	-8.2
	8,3		10	35	89	47	40	-8.3
	8,334	21/64"	10	35	89	47	40	-21/64IN
	8,4		10	35	89	47	40	-8.4
	8,5		10	35	89	47	40	-8.5
	8,6		10	35	89	47	40	-8.6
	8,7		10	35	89	47	40	-8.7
	8,731	11/32"	10	35	89	47	40	-11/32IN
	8,8		10	35	89	47	40	-8.8
	8,9		10	35	89	47	40	-8.9
	9		10	35	89	47	40	-9
	9,1		10	35	89	47	40	-9.1
	9,128	23/64"	10	35	89	47	40	-23/64IN
	9,2		10	35	89	47	40	-9.2
	9,3		10	35	89	47	40	-9.3
	9,4		10	35	89	47	40	-9.4
	9,5		10	35	89	47	40	-9.5
	9,525	3/8"	10	35	89	47	40	-3/8IN
	9,55		10	35	89	47	40	-9.55
	9,6		10	35	89	47	40	-9.6
	9,7		10	35	89	47	40	-9.7
	9,8		10	35	89	47	40	-9.8
	9,9		10	35	89	47	40	-9.9
	9,922	25/64"	10	35	89	47	40	-25/64IN
	10		10	35	89	47	40	-10
	10,1		12	40	102	55	45	-10.1
	10,2		12	40	102	55	45	-10.2
	10,3		12	40	102	55	45	-10.3
	10,319	13/32"	12	40	102	55	45	-13/32IN
	10,4		12	40	102	55	45	-10.4
	10,5		12	40	102	55	45	-10.5
	10,6		12	40	102	55	45	-10.6

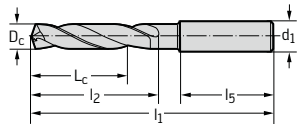

Continued





Solid carbide twist drill
A3265TFL
Alpha® 2
3 x D_c

Continued

	P	M	K	N	S	H	O
TFL	●●	●●	●●	●●	●●	●●	●●

DIN 6537 short	D _c m7 mm	D _c Inches/No	d ₁ h6 mm	L _c mm	l ₁ mm	l ₂ mm	l ₅ mm	Designation A3265TFL
Shank DIN 6535 HA	10,7		12	40	102	55	45	-10.7
	10,716	27/64"	12	40	102	55	45	-27/64IN
	10,8		12	40	102	55	45	-10.8
	10,9		12	40	102	55	45	-10.9
	11		12	40	102	55	45	-11
	11,1		12	40	102	55	45	-11.1
	11,113	7/16"	12	40	102	55	45	-7/16IN
	11,2		12	40	102	55	45	-11.2
	11,3		12	40	102	55	45	-11.3
	11,4		12	40	102	55	45	-11.4
	11,5		12	40	102	55	45	-11.5
	11,509	29/64"	12	40	102	55	45	-29/64IN
	11,55		12	40	102	55	45	-11.55
	11,6		12	40	102	55	45	-11.6
	11,7		12	40	102	55	45	-11.7
	11,8		12	40	102	55	45	-11.8
	11,9		12	40	102	55	45	-11.9
	11,906	15/32"	12	40	102	55	45	-15/32IN
	12		12	40	102	55	45	-12
	12,1		14	43	107	60	45	-12.1
	12,2		14	43	107	60	45	-12.2
	12,25		14	43	107	60	45	-12.25
	12,3		14	43	107	60	45	-12.3
	12,303	31/64"	14	43	107	60	45	-31/64IN
	12,4		14	43	107	60	45	-12.4
	12,5		14	43	107	60	45	-12.5
	12,6		14	43	107	60	45	-12.6
	12,7	1/2"	14	43	107	60	45	-1/2IN
	12,75		14	43	107	60	45	-12.75
	12,8		14	43	107	60	45	-12.8
	12,9		14	43	107	60	45	-12.9
	13		14	43	107	60	45	-13
	13,1		14	43	107	60	45	-13.1
	13,2		14	43	107	60	45	-13.2
	13,3		14	43	107	60	45	-13.3
	13,4		14	43	107	60	45	-13.4
	13,494	17/32"	14	43	107	60	45	-17/32IN
	13,5		14	43	107	60	45	-13.5
	13,6		14	43	107	60	45	-13.6
	13,7		14	43	107	60	45	-13.7
	13,8		14	43	107	60	45	-13.8
	13,9		14	43	107	60	45	-13.9
	14		14	43	107	60	45	-14
	14,1		16	45	115	65	48	-14.1
	14,2		16	45	115	65	48	-14.2
	14,288	9/16"	16	45	115	65	48	-9/16IN
	14,3		16	45	115	65	48	-14.3
	14,4		16	45	115	65	48	-14.4
	14,5		16	45	115	65	48	-14.5
	14,6		16	45	115	65	48	-14.6
	14,7		16	45	115	65	48	-14.7
	14,75		16	45	115	65	48	-14.75
	14,8		16	45	115	65	48	-14.8
	15		16	45	115	65	48	-15
	15,1		16	45	115	65	48	-15.1

Continued



Solid carbide twist drill

A3265TFL

Alpha® 2

 3 x D_c

Continued

	P	M	K	N	S	H	O
TFL	●●	●●	●●	●●	●●	●●	●●

DIN 6537 short	D _c m7 mm	D _c Inches/No	d ₁ h6 mm	L _c mm	l ₁ mm	l ₂ mm	l ₅ mm	Designation A3265TFL
Shank DIN 6535 HA	15,2		16	45	115	65	48	-15.2
	15,3		16	45	115	65	48	-15.3
	15,5		16	45	115	65	48	-15.5
	15,6		16	45	115	65	48	-15.6
	15,7		16	45	115	65	48	-15.7
	15,8		16	45	115	65	48	-15.8
	15,875	5/8"	16	45	115	65	48	-5/8IN
	15,9		16	45	115	65	48	-15.9
	16		16	45	115	65	48	-16
	16,1		18	51	123	73	48	-16.1
	16,2		18	51	123	73	48	-16.2
	16,3		18	51	123	73	48	-16.3
	16,4		18	51	123	73	48	-16.4
	16,5		18	51	123	73	48	-16.5
	16,6		18	51	123	73	48	-16.6
	16,7		18	51	123	73	48	-16.7
	16,75		18	51	123	73	48	-16.75
	16,8		18	51	123	73	48	-16.8
	17		18	51	123	73	48	-17
	17,2		18	51	123	73	48	-17.2
	17,3		18	51	123	73	48	-17.3
	17,5		18	51	123	73	48	-17.5
	17,6		18	51	123	73	48	-17.6
	17,7		18	51	123	73	48	-17.7
	17,8		18	51	123	73	48	-17.8
	18		18	51	123	73	48	-18
	18,2		20	55	131	79	50	-18.2
	18,5		20	55	131	79	50	-18.5
	18,7		20	55	131	79	50	-18.7
	18,8		20	55	131	79	50	-18.8
	19		20	55	131	79	50	-19
	19,05	3/4"	20	55	131	79	50	-3/4IN
	19,5		20	55	131	79	50	-19.5
	19,7		20	55	131	79	50	-19.7
	19,8		20	55	131	79	50	-19.8
	20		20	55	131	79	50	-20

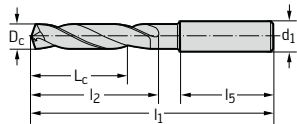

Solid carbide twist drill

A3269TFL

Alpha® Rc



3 x D_c

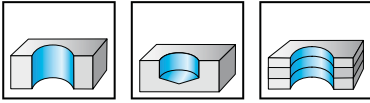

- K30F - TFL
- Type Alpha® Rc
- right-hand cutting
- 140° point angle
- for tapped holes M4 - M12

Special features:
specially for machining hardened materials up to 65 HRC

	P	M	K	N	S	H	O
TFL				●●	●●	●●	

DIN 6537 short	D _c m7 mm	d ₁ h6 mm	L _c mm	l ₁ mm	l ₂ mm	l ₅ mm	Designation A3269TFL
Shank DIN 6535 HA	3,4	6	14	62	20	36	-3.4
	4,3	6	17	66	24	36	-4.3
	5,1	6	20	66	28	36	-5.1
	6,9	8	24	79	34	36	-6.9
	8,6	10	35	89	47	40	-8.6
	10,4	12	40	102	55	45	-10.4

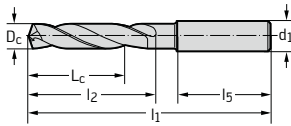

Solid carbide coolant through drills

A3285TFL

Alpha® 4



3 x D_c

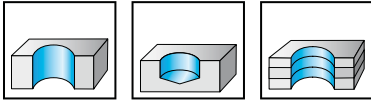

- K30F - TFL
- Type Alpha® 4
- right-hand cutting
- 140° point angle

Special features:
45 - 55 HRC

	P	M	K	N	S	H	O
TFL	●	●	●	●	●	●	●

DIN 6537 short	D _c m7 mm	D _c Inches/No	d ₁ h6 mm	L _c mm	l ₁ mm	l ₂ mm	l ₅ mm	Designation A3285TFL
Shank DIN 6535 HA	3		6	14	62	20	36	-3
	3,1		6	14	62	20	36	-3.1
	3,175	1/8"	6	14	62	20	36	-1/8IN
	3,2		6	14	62	20	36	-3.2
	3,25		6	14	62	20	36	-3.25
	3,3		6	14	62	20	36	-3.3
	3,4		6	14	62	20	36	-3.4
	3,5		6	14	62	20	36	-3.5
	3,572	9/64"	6	14	62	20	36	-9/64IN
	3,6		6	14	62	20	36	-3.6
	3,65		6	14	62	20	36	-3.65
	3,7		6	14	62	20	36	-3.7
	3,8		6	17	66	24	36	-3.8
	3,9		6	17	66	24	36	-3.9
	3,969	5/32"	6	17	66	24	36	-5/32IN
	4		6	17	66	24	36	-4
	4,1		6	17	66	24	36	-4.1
	4,2		6	17	66	24	36	-4.2
	4,3		6	17	66	24	36	-4.3
	4,366	11/64"	6	17	66	24	36	-11/64IN
	4,4		6	17	66	24	36	-4.4
	4,5		6	17	66	24	36	-4.5
	4,6		6	17	66	24	36	-4.6
	4,65		6	17	66	24	36	-4.65
	4,7		6	17	66	24	36	-4.7
	4,763	3/16"	6	20	66	28	36	-3/16IN
	4,8		6	20	66	28	36	-4.8
	4,9		6	20	66	28	36	-4.9
	5		6	20	66	28	36	-5
	5,1		6	20	66	28	36	-5.1
	5,159	13/64"	6	20	66	28	36	-13/64IN
	5,2		6	20	66	28	36	-5.2
	5,3		6	20	66	28	36	-5.3
	5,4		6	20	66	28	36	-5.4
	5,5		6	20	66	28	36	-5.5
	5,55		6	20	66	28	36	-5.55
	5,556	7/32"	6	20	66	28	36	-7/32IN
	5,6		6	20	66	28	36	-5.6
	5,7		6	20	66	28	36	-5.7
	5,8		6	20	66	28	36	-5.8
	5,9		6	20	66	28	36	-5.9
	5,953	15/64"	6	20	66	28	36	-15/64IN
	6		6	20	66	28	36	-6
	6,1		8	24	79	34	36	-6.1
	6,2		8	24	79	34	36	-6.2
	6,3		8	24	79	34	36	-6.3
	6,35	1/4"	8	24	79	34	36	-1/4IN

Continued



Solid carbide coolant through drills

A3285TFL

Alpha® 4



3 x D_c

	P	M	K	N	S	H	O
TFL	●●	●●	●●	●●	●●	●●	●●

Continued

DIN 6537 short	D _c m7 mm	D _c Inches/No	d ₁ h6 mm	L _c mm	l ₁ mm	l ₂ mm	l ₅ mm	Designation A3285TFL
Shank DIN 6535 HA	6,4		8	24	79	34	36	-6.4
	6,5		8	24	79	34	36	-6.5
	6,6		8	24	79	34	36	-6.6
	6,7		8	24	79	34	36	-6.7
	6,747	17/64"	8	24	79	34	36	-17/64IN
	6,8		8	24	79	34	36	-6.8
	6,9		8	24	79	34	36	-6.9
	7		8	24	79	34	36	-7
	7,1		8	29	79	41	36	-7.1
	7,144	9/32"	8	29	79	41	36	-9/32IN
	7,2		8	29	79	41	36	-7.2
	7,3		8	29	79	41	36	-7.3
	7,4		8	29	79	41	36	-7.4
	7,5		8	29	79	41	36	-7.5
	7,541	19/64"	8	29	79	41	36	-19/64IN
	7,55		8	29	79	41	36	-7.55
	7,6		8	29	79	41	36	-7.6
	7,7		8	29	79	41	36	-7.7
	7,8		8	29	79	41	36	-7.8
	7,9		8	29	79	41	36	-7.9
	7,938	5/16"	8	29	79	41	36	-5/16IN
	8		8	29	79	41	36	-8
	8,1		10	35	89	47	40	-8.1
	8,2		10	35	89	47	40	-8.2
	8,3		10	35	89	47	40	-8.3
	8,334	21/64"	10	35	89	47	40	-21/64IN
	8,4		10	35	89	47	40	-8.4
	8,5		10	35	89	47	40	-8.5
	8,6		10	35	89	47	40	-8.6
	8,7		10	35	89	47	40	-8.7
	8,731	11/32"	10	35	89	47	40	-11/32IN
	8,8		10	35	89	47	40	-8.8
	8,9		10	35	89	47	40	-8.9
	9		10	35	89	47	40	-9
	9,1		10	35	89	47	40	-9.1
	9,128	23/64"	10	35	89	47	40	-23/64IN
	9,2		10	35	89	47	40	-9.2
	9,3		10	35	89	47	40	-9.3
	9,4		10	35	89	47	40	-9.4
	9,5		10	35	89	47	40	-9.5
	9,525	3/8"	10	35	89	47	40	-3/8IN
	9,55		10	35	89	47	40	-9.55
	9,6		10	35	89	47	40	-9.6
	9,7		10	35	89	47	40	-9.7
	9,8		10	35	89	47	40	-9.8
	9,9		10	35	89	47	40	-9.9
	9,922	25/64"	10	35	89	47	40	-25/64IN
	10		10	35	89	47	40	-10
	10,1		12	40	102	55	45	-10.1
	10,2		12	40	102	55	45	-10.2
	10,3		12	40	102	55	45	-10.3
	10,319	13/32"	12	40	102	55	45	-13/32IN
	10,4		12	40	102	55	45	-10.4
	10,5		12	40	102	55	45	-10.5
	10,6		12	40	102	55	45	-10.6

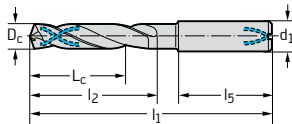

Continued



Solid carbide coolant through drills

A3285TFL

Alpha® 4

 3 x D_c

Continued

TFL	P	M	K	N	S	H	O
	●●	●●	●●	●●	●●	●●	●●

DIN 6537 short	D _c m7 mm	D _c Inches/No	d ₁ h6 mm	L _c mm	l ₁ mm	l ₂ mm	l ₅ mm	Designation A3285TFL
Shank DIN 6535 HA	10,7		12	40	102	55	45	-10.7
	10,716	27/64"	12	40	102	55	45	-27/64IN
	10,8		12	40	102	55	45	-10.8
	10,9		12	40	102	55	45	-10.9
	11		12	40	102	55	45	-11
	11,1		12	40	102	55	45	-11.1
	11,113	7/16"	12	40	102	55	45	-7/16IN
	11,2		12	40	102	55	45	-11.2
	11,3		12	40	102	55	45	-11.3
	11,4		12	40	102	55	45	-11.4
	11,5		12	40	102	55	45	-11.5
	11,509	29/64"	12	40	102	55	45	-29/64IN
	11,55		12	40	102	55	45	-11.55
	11,6		12	40	102	55	45	-11.6
	11,7		12	40	102	55	45	-11.7
	11,8		12	40	102	55	45	-11.8
	11,9		12	40	102	55	45	-11.9
	11,906	15/32"	12	40	102	55	45	-15/32IN
	12		12	40	102	55	45	-12
	12,1		14	43	107	60	45	-12.1
	12,2		14	43	107	60	45	-12.2
	12,25		14	43	107	60	45	-12.25
	12,3		14	43	107	60	45	-12.3
	12,303	31/64"	14	43	107	60	45	-31/64IN
	12,4		14	43	107	60	45	-12.4
	12,5		14	43	107	60	45	-12.5
	12,6		14	43	107	60	45	-12.6
	12,7	1/2"	14	43	107	60	45	-1/2IN
	12,75		14	43	107	60	45	-12.75
	12,8		14	43	107	60	45	-12.8
	12,9		14	43	107	60	45	-12.9
	13		14	43	107	60	45	-13
	13,1		14	43	107	60	45	-13.1
	13,2		14	43	107	60	45	-13.2
	13,3		14	43	107	60	45	-13.3
	13,4		14	43	107	60	45	-13.4
	13,494	17/32"	14	43	107	60	45	-17/32IN
	13,5		14	43	107	60	45	-13.5
	13,6		14	43	107	60	45	-13.6
	13,7		14	43	107	60	45	-13.7
	13,8		14	43	107	60	45	-13.8
	13,9		14	43	107	60	45	-13.9
	14		14	43	107	60	45	-14
	14,1		16	45	115	65	48	-14.1
	14,2		16	45	115	65	48	-14.2
	14,288	9/16"	16	45	115	65	48	-9/16IN
	14,3		16	45	115	65	48	-14.3
	14,4		16	45	115	65	48	-14.4
	14,5		16	45	115	65	48	-14.5
	14,6		16	45	115	65	48	-14.6
	14,7		16	45	115	65	48	-14.7
	14,75		16	45	115	65	48	-14.75
	14,8		16	45	115	65	48	-14.8
	15		16	45	115	65	48	-15
	15,1		16	45	115	65	48	-15.1

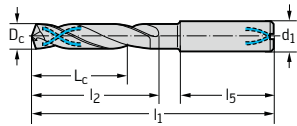

Continued



Solid carbide coolant through drills

A3285TFL

Alpha® 4



3 x D_c

Continued

	P	M	K	N	S	H	O
TFL	●●	●●	●●	●●	●●	●●	●●

DIN 6537 short	D _c m7 mm	D _c Inches/No	d ₁ h6 mm	L _c mm	l ₁ mm	l ₂ mm	l ₅ mm	Designation A3285TFL
Shank DIN 6535 HA	15,2		16	45	115	65	48	-15.2
	15,3		16	45	115	65	48	-15.3
	15,5		16	45	115	65	48	-15.5
	15,6		16	45	115	65	48	-15.6
	15,7		16	45	115	65	48	-15.7
	15,8		16	45	115	65	48	-15.8
	15,875	5/8"	16	45	115	65	48	-5/8IN
	15,9		16	45	115	65	48	-15.9
	16		16	45	115	65	48	-16
	16,1		18	51	123	73	48	-16.1
	16,2		18	51	123	73	48	-16.2
	16,3		18	51	123	73	48	-16.3
	16,4		18	51	123	73	48	-16.4
	16,5		18	51	123	73	48	-16.5
	16,6		18	51	123	73	48	-16.6
	16,7		18	51	123	73	48	-16.7
	16,75		18	51	123	73	48	-16.75
	16,8		18	51	123	73	48	-16.8
	17		18	51	123	73	48	-17
	17,2		18	51	123	73	48	-17.2
	17,3		18	51	123	73	48	-17.3
	17,5		18	51	123	73	48	-17.5
	17,6		18	51	123	73	48	-17.6
	17,7		18	51	123	73	48	-17.7
	17,8		18	51	123	73	48	-17.8
	18		18	51	123	73	48	-18
	18,2		20	55	131	79	50	-18.2
	18,5		20	55	131	79	50	-18.5
	18,7		20	55	131	79	50	-18.7
	18,8		20	55	131	79	50	-18.8
	19		20	55	131	79	50	-19
	19,05	3/4"	20	55	131	79	50	-3/4IN
	19,5		20	55	131	79	50	-19.5
	19,7		20	55	131	79	50	-19.7
	19,8		20	55	131	79	50	-19.8
	20		20	55	131	79	50	-20

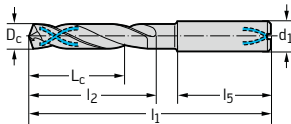

Solid carbide coolant through drills

A3289DPL

X-treme Plus



3 x D_c

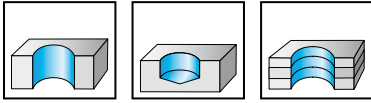

- K30F - DPL
- Type X-treme Plus
- right-hand cutting
- 140° point angle

Special features:
suitable for dry machining in steel
45 - 55 HRC

	P	M	K	N	S	H	O
DPL	●	●	●	●	●	●	●

DIN 6537 short	D _c m7 mm	D _c Inches/No	d ₁ h6 mm	L _c mm	l ₁ mm	l ₂ mm	l ₅ mm	Designation A3289DPL
Shank DIN 6535 HA	3		6	14	62	20	36	-3
	3,1		6	14	62	20	36	-3.1
	3,175	1/8"	6	14	62	20	36	-1/8IN
	3,2		6	14	62	20	36	-3.2
	3,3		6	14	62	20	36	-3.3
	3,4		6	14	62	20	36	-3.4
	3,5		6	14	62	20	36	-3.5
	3,572	9/64"	6	14	62	20	36	-9/64IN
	3,6		6	14	62	20	36	-3.6
	3,7		6	14	62	20	36	-3.7
	3,8		6	17	66	24	36	-3.8
	3,9		6	17	66	24	36	-3.9
	3,969	5/32"	6	17	66	24	36	-5/32IN
	4		6	17	66	24	36	-4
	4,1		6	17	66	24	36	-4.1
	4,2		6	17	66	24	36	-4.2
	4,3		6	17	66	24	36	-4.3
	4,366	11/64"	6	17	66	24	36	-11/64IN
	4,4		6	17	66	24	36	-4.4
	4,5		6	17	66	24	36	-4.5
	4,6		6	17	66	24	36	-4.6
	4,65		6	17	66	24	36	-4.65
	4,7		6	17	66	24	36	-4.7
	4,763	3/16"	6	20	66	28	36	-3/16IN
	4,8		6	20	66	28	36	-4.8
	4,9		6	20	66	28	36	-4.9
	5		6	20	66	28	36	-5
	5,1		6	20	66	28	36	-5.1
	5,159	13/64"	6	20	66	28	36	-13/64IN
	5,2		6	20	66	28	36	-5.2
	5,3		6	20	66	28	36	-5.3
	5,4		6	20	66	28	36	-5.4
	5,5		6	20	66	28	36	-5.5
	5,55		6	20	66	28	36	-5.55
	5,556	7/32"	6	20	66	28	36	-7/32IN
	5,6		6	20	66	28	36	-5.6
	5,7		6	20	66	28	36	-5.7
	5,8		6	20	66	28	36	-5.8
	5,9		6	20	66	28	36	-5.9
	5,953	15/64"	6	20	66	28	36	-15/64IN
	6		6	20	66	28	36	-6
	6,1		8	24	79	34	36	-6.1
	6,2		8	24	79	34	36	-6.2
	6,3		8	24	79	34	36	-6.3
	6,35	1/4"	8	24	79	34	36	-1/4IN
	6,4		8	24	79	34	36	-6.4
	6,5		8	24	79	34	36	-6.5

Continued





Solid carbide coolant through drills

A3289DPL

X-treme Plus

3 x D_c

Continued

	P	M	K	N	S	H	O
DPL	●●	●●	●●	●●	●●	●●	●

DIN 6537 short	D _c m7 mm	D _c Inches/No	d ₁ h6 mm	L _c mm	l ₁ mm	l ₂ mm	l ₅ mm	Designation A3289DPL
Shank DIN 6535 HA	6.6		8	24	79	34	36	-6.6
	6.7		8	24	79	34	36	-6.7
	6.747	17/64"	8	24	79	34	36	-17/64IN
	6.8		8	24	79	34	36	-6.8
	6.9		8	24	79	34	36	-6.9
	7		8	24	79	34	36	-7
	7.1		8	29	79	41	36	-7.1
	7.144	9/32"	8	29	79	41	36	-9/32IN
	7.2		8	29	79	41	36	-7.2
	7.3		8	29	79	41	36	-7.3
	7.4		8	29	79	41	36	-7.4
	7.5		8	29	79	41	36	-7.5
	7.541	19/64"	8	29	79	41	36	-19/64IN
	7.8		8	29	79	41	36	-7.8
	7.9		8	29	79	41	36	-7.9
	7.938	5/16"	8	29	79	41	36	-5/16IN
	8		8	29	79	41	36	-8
	8.1		10	35	89	47	40	-8.1
	8.2		10	35	89	47	40	-8.2
	8.3		10	35	89	47	40	-8.3
	8.334	21/64"	10	35	89	47	40	-21/64IN
	8.4		10	35	89	47	40	-8.4
	8.5		10	35	89	47	40	-8.5
	8.6		10	35	89	47	40	-8.6
	8.7		10	35	89	47	40	-8.7
	8.731	11/32"	10	35	89	47	40	-11/32IN
	8.8		10	35	89	47	40	-8.8
	9		10	35	89	47	40	-9
	9.128	23/64"	10	35	89	47	40	-23/64IN
	9.2		10	35	89	47	40	-9.2
	9.3		10	35	89	47	40	-9.3
	9.5		10	35	89	47	40	-9.5
	9.525	3/8"	10	35	89	47	40	-3/8IN
	9.6		10	35	89	47	40	-9.6
	9.7		10	35	89	47	40	-9.7
	9.8		10	35	89	47	40	-9.8
	9.922	25/64"	10	35	89	47	40	-25/64IN
	10		10	35	89	47	40	-10
	10.1		12	40	102	55	45	-10.1
	10.2		12	40	102	55	45	-10.2
	10.3		12	40	102	55	45	-10.3
	10.319	13/32"	12	40	102	55	45	-13/32IN
	10.4		12	40	102	55	45	-10.4
	10.5		12	40	102	55	45	-10.5
	10.716	27/64"	12	40	102	55	45	-27/64IN
	10.8		12	40	102	55	45	-10.8
	11		12	40	102	55	45	-11
	11.1		12	40	102	55	45	-11.1
	11.113	7/16"	12	40	102	55	45	-7/16IN
	11.2		12	40	102	55	45	-11.2
	11.5		12	40	102	55	45	-11.5
	11.509	29/64"	12	40	102	55	45	-29/64IN
	11.7		12	40	102	55	45	-11.7
	11.8		12	40	102	55	45	-11.8
	11.906	15/32"	12	40	102	55	45	-15/32IN

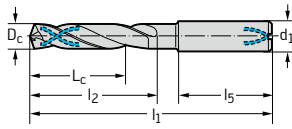

Continued



Solid carbide coolant through drills

A3289DPL

X-treme Plus



3 x D_c

Continued

	P	M	K	N	S	H	O
DPL	●●	●●	●●	●●	●●	●●	●

DIN 6537 short	D _c m7 mm	D _c Inches/No	d ₁ h6 mm	L _c mm	l ₁ mm	l ₂ mm	l ₅ mm	Designation A3289DPL
Shank DIN 6535 HA	12		12	40	102	55	45	-12
	12,1		14	43	107	60	45	-12.1
	12,2		14	43	107	60	45	-12.2
	12,3		14	43	107	60	45	-12.3
	12,303	31/64"	14	43	107	60	45	-31/64IN
	12,5		14	43	107	60	45	-12.5
	12,6		14	43	107	60	45	-12.6
	13		14	43	107	60	45	-13
	13,3		14	43	107	60	45	-13.3
	13,494	17/32"	14	43	107	60	45	-17/32IN
	13,5		14	43	107	60	45	-13.5
	14		14	43	107	60	45	-14
	14,288	9/16"	16	45	115	65	48	-9/16IN
	14,5		16	45	115	65	48	-14.5
	15		16	45	115	65	48	-15
	15,5		16	45	115	65	48	-15.5
	15,875	5/8"	16	45	115	65	48	-5/8IN
	16		16	45	115	65	48	-16
	16,5		18	51	123	73	48	-16.5
	17		18	51	123	73	48	-17
	17,5		18	51	123	73	48	-17.5
	18		18	51	123	73	48	-18
	19,05	3/4"	20	55	131	79	50	-3/4IN
	20		20	55	131	79	50	-20

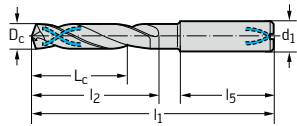

Solid carbide twist drill

A3365TFT

Alpha® 2



5 x D_c

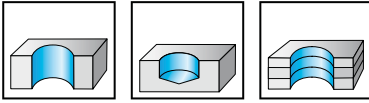

- K30F - TFT
- Type Alpha® 2
- right-hand cutting
- 140° point angle

Special features:
45 - 55 HRC

	P	M	K	N	S	H	O
TFT	●	●	●	●	●	●	●

DIN 6537 long	D _c m7 mm	D _c Inches/No	d ₁ h6 mm	L _c mm	l ₁ mm	l ₂ mm	l ₅ mm	Designation A3365TFT
Shank DIN 6535 HA	3		6	23	66	28	36	-3
	3,1		6	23	66	28	36	-3.1
	3,175	1/8"	6	23	66	28	36	-1/8IN
	3,2		6	23	66	28	36	-3.2
	3,25		6	23	66	28	36	-3.25
	3,3		6	23	66	28	36	-3.3
	3,4		6	23	66	28	36	-3.4
	3,5		6	23	66	28	36	-3.5
	3,572	9/64"	6	23	66	28	36	-9/64IN
	3,6		6	23	66	28	36	-3.6
	3,65		6	23	66	28	36	-3.65
	3,7		6	23	66	28	36	-3.7
	3,8		6	29	74	36	36	-3.8
	3,9		6	29	74	36	36	-3.9
	3,969	5/32"	6	29	74	36	36	-5/32IN
	4		6	29	74	36	36	-4
	4,1		6	29	74	36	36	-4.1
	4,2		6	29	74	36	36	-4.2
	4,3		6	29	74	36	36	-4.3
	4,366	11/64"	6	29	74	36	36	-11/64IN
	4,4		6	29	74	36	36	-4.4
	4,5		6	29	74	36	36	-4.5
	4,6		6	29	74	36	36	-4.6
	4,65		6	29	74	36	36	-4.65
	4,7		6	29	74	36	36	-4.7
	4,763	3/16"	6	35	82	44	36	-3/16IN
	4,8		6	35	82	44	36	-4.8
	4,9		6	35	82	44	36	-4.9
	5		6	35	82	44	36	-5
	5,1		6	35	82	44	36	-5.1
	5,159	13/64"	6	35	82	44	36	-13/64IN
	5,2		6	35	82	44	36	-5.2
	5,3		6	35	82	44	36	-5.3
	5,4		6	35	82	44	36	-5.4
	5,5		6	35	82	44	36	-5.5
	5,55		6	35	82	44	36	-5.55
	5,556	7/32"	6	35	82	44	36	-7/32IN
	5,6		6	35	82	44	36	-5.6
	5,7		6	35	82	44	36	-5.7
	5,8		6	35	82	44	36	-5.8
	5,9		6	35	82	44	36	-5.9
	5,953	15/64"	6	35	82	44	36	-15/64IN
	6		6	35	82	44	36	-6
	6,1		8	43	91	53	36	-6.1
	6,2		8	43	91	53	36	-6.2
	6,3		8	43	91	53	36	-6.3
	6,35	1/4"	8	43	91	53	36	-1/4IN

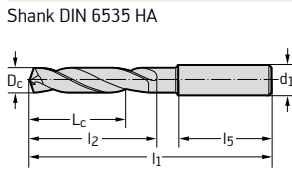

Continued



Solid carbide twist drill

A3365TFT

Alpha® 2

 5 x D_c

Continued

	P	M	K	N	S	H	O
TFT	●●	●●	●●	●●	●●	●●	●●

DIN 6537 long	D _c m7 mm	D _c Inches/No	d ₁ h6 mm	L _c mm	l ₁ mm	l ₂ mm	l ₅ mm	Designation A3365TFT
Shank DIN 6535 HA	6,4		8	43	91	53	36	-6.4
	6,5		8	43	91	53	36	-6.5
	6,6		8	43	91	53	36	-6.6
	6,7		8	43	91	53	36	-6.7
	6,747	17/64"	8	43	91	53	36	-17/64IN
	6,8		8	43	91	53	36	-6.8
	6,9		8	43	91	53	36	-6.9
	7		8	43	91	53	36	-7
	7,1		8	43	91	53	36	-7.1
	7,144	9/32"	8	43	91	53	36	-9/32IN
	7,2		8	43	91	53	36	-7.2
	7,3		8	43	91	53	36	-7.3
	7,4		8	43	91	53	36	-7.4
	7,5		8	43	91	53	36	-7.5
	7,541	19/64"	8	43	91	53	36	-19/64IN
	7,55		8	43	91	53	36	-7.55
	7,6		8	43	91	53	36	-7.6
	7,7		8	43	91	53	36	-7.7
	7,8		8	43	91	53	36	-7.8
	7,9		8	43	91	53	36	-7.9
	7,938	5/16"	8	43	91	53	36	-5/16IN
	8		8	43	91	53	36	-8
	8,1		10	49	103	61	40	-8.1
	8,2		10	49	103	61	40	-8.2
	8,3		10	49	103	61	40	-8.3
	8,334	21/64"	10	49	103	61	40	-21/64IN
	8,4		10	49	103	61	40	-8.4
	8,5		10	49	103	61	40	-8.5
	8,6		10	49	103	61	40	-8.6
	8,7		10	49	103	61	40	-8.7
	8,731	11/32"	10	49	103	61	40	-11/32IN
	8,8		10	49	103	61	40	-8.8
	8,9		10	49	103	61	40	-8.9
	9		10	49	103	61	40	-9
	9,1		10	49	103	61	40	-9.1
	9,128	23/64"	10	49	103	61	40	-23/64IN
	9,2		10	49	103	61	40	-9.2
	9,3		10	49	103	61	40	-9.3
	9,4		10	49	103	61	40	-9.4
	9,5		10	49	103	61	40	-9.5
	9,525	3/8"	10	49	103	61	40	-3/8IN
	9,55		10	49	103	61	40	-9.55
	9,6		10	49	103	61	40	-9.6
	9,7		10	49	103	61	40	-9.7
	9,8		10	49	103	61	40	-9.8
	9,9		10	49	103	61	40	-9.9
	9,922	25/64"	10	49	103	61	40	-25/64IN
	10		10	49	103	61	40	-10
	10,1		12	56	118	71	45	-10.1
	10,2		12	56	118	71	45	-10.2
	10,3		12	56	118	71	45	-10.3
	10,319	13/32"	12	56	118	71	45	-13/32IN
	10,4		12	56	118	71	45	-10.4
	10,5		12	56	118	71	45	-10.5
	10,6		12	56	118	71	45	-10.6

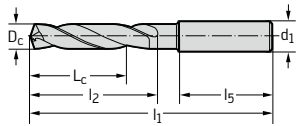

Continued



Solid carbide twist drill

A3365TFT

Alpha® 2

5 x D_c



Continued

	P	M	K	N	S	H	O
TFT	●●	●●	●●	●●	●●	●●	●●

DIN 6537 long	D _c m7 mm	D _c Inches/No	d ₁ h6 mm	L _c mm	l ₁ mm	l ₂ mm	l ₅ mm	Designation A3365TFT
Shank DIN 6535 HA	10,7		12	56	118	71	45	-10.7
	10,716	27/64"	12	56	118	71	45	-27/64IN
	10,8		12	56	118	71	45	-10.8
	10,9		12	56	118	71	45	-10.9
	11		12	56	118	71	45	-11
	11,1		12	56	118	71	45	-11.1
	11,113	7/16"	12	56	118	71	45	-7/16IN
	11,2		12	56	118	71	45	-11.2
	11,3		12	56	118	71	45	-11.3
	11,4		12	56	118	71	45	-11.4
	11,5		12	56	118	71	45	-11.5
	11,509	29/64"	12	56	118	71	45	-29/64IN
	11,55		12	56	118	71	45	-11.55
	11,6		12	56	118	71	45	-11.6
	11,7		12	56	118	71	45	-11.7
	11,8		12	56	118	71	45	-11.8
	11,9		12	56	118	71	45	-11.9
	11,906	15/32"	12	56	118	71	45	-15/32IN
	12		12	56	118	71	45	-12
	12,1		14	60	124	77	45	-12.1
	12,2		14	60	124	77	45	-12.2
	12,25		14	60	124	77	45	-12.25
	12,3		14	60	124	77	45	-12.3
	12,303	31/64"	14	60	124	77	45	-31/64IN
	12,4		14	60	124	77	45	-12.4
	12,5		14	60	124	77	45	-12.5
	12,6		14	60	124	77	45	-12.6
	12,7	1/2"	14	60	124	77	45	-1/2IN
	12,75		14	60	124	77	45	-12.75
	12,8		14	60	124	77	45	-12.8
	12,9		14	60	124	77	45	-12.9
	13		14	60	124	77	45	-13
	13,1		14	60	124	77	45	-13.1
	13,2		14	60	124	77	45	-13.2
	13,3		14	60	124	77	45	-13.3
	13,4		14	60	124	77	45	-13.4
	13,494	17/32"	14	60	124	77	45	-17/32IN
	13,5		14	60	124	77	45	-13.5
	13,6		14	60	124	77	45	-13.6
	13,7		14	60	124	77	45	-13.7
	13,8		14	60	124	77	45	-13.8
	13,9		14	60	124	77	45	-13.9
	14		14	60	124	77	45	-14
	14,1		16	63	133	83	48	-14.1
	14,2		16	63	133	83	48	-14.2
	14,288	9/16"	16	63	133	83	48	-9/16IN
	14,3		16	63	133	83	48	-14.3
	14,4		16	63	133	83	48	-14.4
	14,5		16	63	133	83	48	-14.5
	14,6		16	63	133	83	48	-14.6
	14,7		16	63	133	83	48	-14.7
	14,75		16	63	133	83	48	-14.75
	14,8		16	63	133	83	48	-14.8
	15		16	63	133	83	48	-15

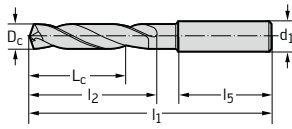

Continued



Solid carbide twist drill

A3365TFT

Alpha® 2

 5 x D_c

Continued

	P	M	K	N	S	H	O
TFT	●●	●●	●●	●●	●●	●●	●●

DIN 6537 long	D _c m7 mm	D _c Inches/No	d ₁ h6 mm	L _c mm	l ₁ mm	l ₂ mm	l ₅ mm	Designation A3365TFT
Shank DIN 6535 HA	15,1		16	63	133	83	48	-15.1
	15,2		16	63	133	83	48	-15.2
	15,3		16	63	133	83	48	-15.3
	15,5		16	63	133	83	48	-15.5
	15,6		16	63	133	83	48	-15.6
	15,7		16	63	133	83	48	-15.7
	15,8		16	63	133	83	48	-15.8
	15,875	5/8"	16	63	133	83	48	-5/8IN
	15,9		16	63	133	83	48	-15.9
	16		16	63	133	83	48	-16
	16,1		18	71	143	93	48	-16.1
	16,2		18	71	143	93	48	-16.2
	16,3		18	71	143	93	48	-16.3
	16,4		18	71	143	93	48	-16.4
	16,5		18	71	143	93	48	-16.5
	16,6		18	71	143	93	48	-16.6
	16,7		18	71	143	93	48	-16.7
	16,75		18	71	143	93	48	-16.75
	16,8		18	71	143	93	48	-16.8
	17		18	71	143	93	48	-17
	17,2		18	71	143	93	48	-17.2
	17,3		18	71	143	93	48	-17.3
	17,5		18	71	143	93	48	-17.5
	17,6		18	71	143	93	48	-17.6
	17,7		18	71	143	93	48	-17.7
	17,8		18	71	143	93	48	-17.8
	18		18	71	143	93	48	-18
	18,2		20	77	153	101	50	-18.2
	18,5		20	77	153	101	50	-18.5
	18,7		20	77	153	101	50	-18.7
	18,8		20	77	153	101	50	-18.8
	19		20	77	153	101	50	-19
	19,05	3/4"	20	77	153	101	50	-3/4IN
	19,5		20	77	153	101	50	-19.5
	19,7		20	77	153	101	50	-19.7
	19,8		20	77	153	101	50	-19.8
	20		20	77	153	101	50	-20
	20,5		25	86	166	108	56	-20.5
	21		25	86	166	108	56	-21
	21,5		25	86	166	108	56	-21.5
	22		25	86	166	108	56	-22
	22,5		25	91	173	115	56	-22.5
	23		25	91	173	115	56	-23
	23,5		25	91	173	115	56	-23.5
	24		25	91	173	115	56	-24
	24,5		25	97	180	122	56	-24.5
	25		25	97	180	122	56	-25

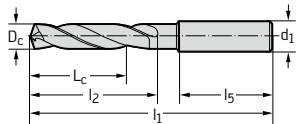



Solid carbide maximiza

A3367

BSX

5 x D_c

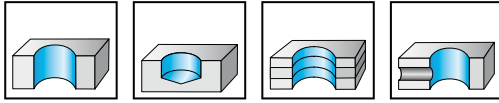

- K30F - uncoated
- Type BSX
- right-hand cutting
- 130° point angle
- Tip geometry SX

Special features:
suitable for dry machining in cast iron

	P	M	K	N	S	H	O
uncoated			●●	●●	●		●●

DIN 6537 long	D _c m7 mm	D _c Inches/No	d ₁ h6 mm	L _c mm	l ₁ mm	l ₂ mm	l ₅ mm	Designation A3367
Shank DIN 6535 HA	3		6	23	66	28	36	-3
	3,15		6	23	66	28	36	-3.15
	3,175	1/8"	6	23	66	28	36	-1/8IN
	3,3		6	23	66	28	36	-3.3
	3,5		6	23	66	28	36	-3.5
	3,572	9/64"	6	23	66	28	36	-9/64IN
	3,7		6	23	66	28	36	-3.7
	3,8		6	29	74	36	36	-3.8
	3,969	5/32"	6	29	74	36	36	-5/32IN
	4		6	29	74	36	36	-4
	4,2		6	29	74	36	36	-4.2
	4,3		6	29	74	36	36	-4.3
	4,366	11/64"	6	29	74	36	36	-11/64IN
	4,45		6	29	74	36	36	-4.45
	4,5		6	29	74	36	36	-4.5
	4,65		6	29	74	36	36	-4.65
	4,763	3/16"	6	35	82	44	36	-3/16IN
	5		6	35	82	44	36	-5
	5,159	13/64"	6	35	82	44	36	-13/64IN
	5,5		6	35	82	44	36	-5.5
	5,55		6	35	82	44	36	-5.55
	5,556	7/32"	6	35	82	44	36	-7/32IN
	5,75		6	35	82	44	36	-5.75
	5,9		6	35	82	44	36	-5.9
	5,953	15/64"	6	35	82	44	36	-15/64IN
	6		6	35	82	44	36	-6
	6,35	1/4"	8	43	91	53	36	-1/4IN
	6,5		8	43	91	53	36	-6.5
	6,55		8	43	91	53	36	-6.55
	6,747	17/64"	8	43	91	53	36	-17/64IN
	6,8		8	43	91	53	36	-6.8
	7		8	43	91	53	36	-7
	7,144	9/32"	8	43	91	53	36	-9/32IN
	7,25		8	43	91	53	36	-7.25
	7,4		8	43	91	53	36	-7.4
	7,45		8	43	91	53	36	-7.45
	7,5		8	43	91	53	36	-7.5
	7,541	19/64"	8	43	91	53	36	-19/64IN
	7,55		8	43	91	53	36	-7.55
	7,938	5/16"	8	43	91	53	36	-5/16IN
	8		8	43	91	53	36	-8
	8,334	21/64"	10	49	103	61	40	-21/64IN
	8,5		10	49	103	61	40	-8.5
	8,731	11/32"	10	49	103	61	40	-11/32IN
	8,75		10	49	103	61	40	-8.75
	9		10	49	103	61	40	-9
	9,128	23/64"	10	49	103	61	40	-23/64IN

Continued



Solid carbide maximiza

A3367

BSX



5 x D_c

Continued

	P	M	K	N	S	H	O
uncoated			●●	●●	●		●●

DIN 6537 long	D _c m7 mm	D _c Inches/No	d ₁ h6 mm	L _c mm	l ₁ mm	l ₂ mm	l ₅ mm	Designation A3367
Shank DIN 6535 HA	9,3		10	49	103	61	40	-9.3
	9,4		10	49	103	61	40	-9.4
	9,5		10	49	103	61	40	-9.5
	9,525	3/8"	10	49	103	61	40	-3/8IN
	9,55		10	49	103	61	40	-9.55
	9,922	25/64"	10	49	103	61	40	-25/64IN
	10		10	49	103	61	40	-10
	10,2		12	56	118	71	45	-10.2
	10,319	13/32"	12	56	118	71	45	-13/32IN
	10,5		12	56	118	71	45	-10.5
	10,716	27/64"	12	56	118	71	45	-27/64IN
	11		12	56	118	71	45	-11
	11,113	7/16"	12	56	118	71	45	-7/16IN
	11,2		12	56	118	71	45	-11.2
	11,3		12	56	118	71	45	-11.3
	11,5		12	56	118	71	45	-11.5
	11,509	29/64"	12	56	118	71	45	-29/64IN
	11,55		12	56	118	71	45	-11.55
	11,7		12	56	118	71	45	-11.7
	11,906	15/32"	12	56	118	71	45	-15/32IN
	12		12	56	118	71	45	-12
	12,303	31/64"	14	60	124	77	45	-31/64IN
	12,5		14	60	124	77	45	-12.5
	12,7	1/2"	14	60	124	77	45	-1/2IN
	13		14	60	124	77	45	-13
	13,1		14	60	124	77	45	-13.1
	13,3		14	60	124	77	45	-13.3
	13,5		14	60	124	77	45	-13.5
	14		14	60	124	77	45	-14
	14,288	9/16"	16	63	133	83	48	-9/16IN
	14,5		16	63	133	83	48	-14.5
	15		16	63	133	83	48	-15
	15,1		16	63	133	83	48	-15.1
	15,3		16	63	133	83	48	-15.3
	15,5		16	63	133	83	48	-15.5
	15,875	5/8"	16	63	133	83	48	-5/8IN
	16		16	63	133	83	48	-16

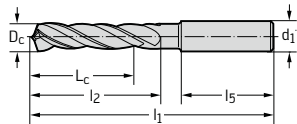

Solid carbide micro twist drill A3378TML Alpha® 2 Plus Micro



5 x D_c

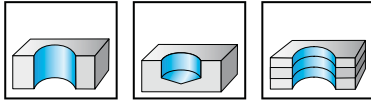

- K30F - TML
- Type Alpha® 2 Plus Micro
- right-hand cutting
- 140° point angle

	P	M	K	N	S	H	O
TML	●●	●	●●	●●	●●		●●

	D _c m7 mm	D _c Inches/No	d ₁ h6 mm	L _c mm	l ₁ mm	l ₂ mm	l ₅ mm	Designation A3378TML
Shank DIN 6535 HA	0,5		3	2,7	45	3,5	31	-0.5
	0,55		3	3,1	45	4	31	-0.55
	0,6		3	3,6	45	4,5	31	-0.6
	0,65		3	3,9	45	5	30	-0.65
	0,7		3	3,9	45	5	30	-0.7
	0,75		3	4,3	45	5,5	31	-0.75
	0,794	1/32"	3	4,7	45	6	30	-1/32IN
	0,8		3	4,7	45	6	30	-0.8
	0,85		3	4,7	45	6	30	-0.85
	0,88		3	5,1	45	6,5	29	-0.88
	0,9		3	5,1	45	6,5	30	-0.9
	0,95		3	5,5	45	7	29	-0.95
	1		3	5,5	45	7	29	-1
	1,05		3	5	45	7,5	29	-1.05
	1,08		3	6	45	8	29	-1.08
	1,1		3	6	45	8	29	-1.1
	1,15		3	6	45	8,5	28	-1.15
	1,191	3/64"	3	6	45	8,5	28	-3/64IN
	1,2		3	6	45	8,5	28	-1.2
	1,25		3	7	45	9	28	-1.25
	1,3		3	7	45	9,5	28	-1.3
	1,35		3	7	45	9,5	28	-1.35
	1,4		3	7	45	10	27	-1.4
	1,45		3	8	45	10,5	35	-1.45
	1,5		3	8	53	10,5	35	-1.5
	1,55		3	8	53	11	35	-1.55
	1,588	1/16"	3	9	53	11,5	34	-1/16IN
	1,6		3	9	53	11,5	35	-1.6
	1,65		3	9	53	12	34	-1.65
	1,7		3	9	53	12	34	-1.7
	1,75		3	9	53	12,5	34	-1.75
	1,8		3	10	53	13	34	-1.8
	1,82		3	10	53	13	34	-1.82
	1,85		3	10	53	13	34	-1.85
	1,9		3	10	53	13,5	33	-1.9
	1,95		3	11	53	14	33	-1.95
	1,984	5/64"	3	11	53	14	33	-5/64IN
	2		3	11	59	14	39	-2
	2,05		3	11	59	14,5	39	-2.05
	2,1		3	11	59	15	38	-2.1
	2,15		3	12	59	15,5	39	-2.15
	2,2		3	12	59	15,5	38	-2.2
	2,25		3	13	59	16,5	38	-2.25
	2,3		3	13	59	16,5	38	-2.3
	2,35		3	13	59	17	38	-2.35
	2,381	3/32"	3	13	59	17	37	-3/32IN
	2,4		3	13	59	17	37	-2.4

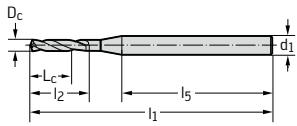

Continued



Solid carbide micro twist drill

A3378TML

Alpha® 2 Plus Micro



5 x D_c

	P	M	K	N	S	H	O
TML	●●		●●	●●	●●		●●

Continued

	D _c m7 mm	D _c Inches/No	d ₁ h6 mm	L _c mm	l ₁ mm	l ₂ mm	l ₅ mm	Designation A3378TML
Shank DIN 6535 HA	2,45		3	13	66	17,5	45	-2.45
	2,5		3	13	66	17,5	44	-2.5
	2,55		3	14	66	18,5	44	-2.55
	2,6		3	14	66	18,5	43	-2.6
	2,65		3	14	66	19	44	-2.65
	2,7		3	14	66	19	43	-2.7
	2,75		3	15	66	19,5	44	-2.75
	2,778	7/64"	3	15	66	19,5	43	-7/64IN
	2,8		3	15	66	20	42	-2.8
	2,85		3	16	66	20,5	43	-2.85
	2,9		3	16	66	20,5	42	-2.9
	2,95		3	16	66	21	36	-2.95

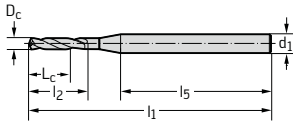

Solid carbide coolant through drills

A3382XPL

X-treme CI



5 x D_c

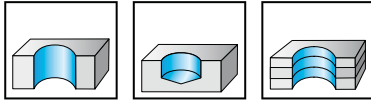

- K30F - XPL
- Type X-treme CI
- right-hand cutting
- 140° point angle

Special features:
specially for machining cast iron materials for dry machining in cast iron

	P	M	K	N	S	H	O
XPL			●●		●●		

DIN 6537 long	D _c mm	D _c Inches/No	d ₁ h6 mm	L _c mm	l ₁ mm	l ₂ mm	l ₅ mm	Designation A3382XPL
Shank DIN 6535 HA 	3		6	23	66	28	36	-3
	3,1		6	23	66	28	36	-3.1
	3,175	1/8"	6	23	66	28	36	-1/8IN
	3,2		6	23	66	28	36	-3.2
	3,3		6	23	66	28	36	-3.3
	3,4		6	23	66	28	36	-3.4
	3,5		6	23	66	28	36	-3.5
	3,572	9/64"	6	23	66	28	36	-9/64IN
	3,6		6	23	66	28	36	-3.6
	3,7		6	23	66	28	36	-3.7
	3,8		6	29	74	36	36	-3.8
	3,9		6	29	74	36	36	-3.9
	3,969	5/32"	6	29	74	36	36	-5/32IN
	4		6	29	74	36	36	-4
	4,1		6	29	74	36	36	-4.1
	4,2		6	29	74	36	36	-4.2
	4,3		6	29	74	36	36	-4.3
	4,366	11/64"	6	29	74	36	36	-11/64IN
	4,4		6	29	74	36	36	-4.4
	4,5		6	29	74	36	36	-4.5
	4,6		6	29	74	36	36	-4.6
	4,65		6	29	74	36	36	-4.65
	4,7		6	29	74	36	36	-4.7
	4,763	3/16"	6	35	82	44	36	-3/16IN
	4,8		6	35	82	44	36	-4.8
	4,9		6	35	82	44	36	-4.9
	5		6	35	82	44	36	-5
	5,1		6	35	82	44	36	-5.1
	5,159	13/64"	6	35	82	44	36	-13/64IN
	5,2		6	35	82	44	36	-5.2
	5,3		6	35	82	44	36	-5.3
	5,4		6	35	82	44	36	-5.4
	5,5		6	35	82	44	36	-5.5
5,55		6	35	82	44	36	-5.55	
5,556	7/32"	6	35	82	44	36	-7/32IN	
5,6		6	35	82	44	36	-5.6	
5,7		6	35	82	44	36	-5.7	
5,8		6	35	82	44	36	-5.8	
5,9		6	35	82	44	36	-5.9	
5,953	15/64"	6	35	82	44	36	-15/64IN	
6		6	35	82	44	36	-6	
6,1		8	43	91	53	36	-6.1	
6,2		8	43	91	53	36	-6.2	
6,3		8	43	91	53	36	-6.3	
6,35	1/4"	8	43	91	53	36	-1/4IN	
6,4		8	43	91	53	36	-6.4	
6,5		8	43	91	53	36	-6.5	

Continued



Solid carbide coolant through drills

A3382XPL

X-treme CI

 5 x D_c

Continued

	P	M	K	N	S	H	O
XPL			●●		●●		

DIN 6537 long	D _c m7 mm	D _c Inches/No	d ₁ h6 mm	L _c mm	l ₁ mm	l ₂ mm	l ₅ mm	Designation A3382XPL
Shank DIN 6535 HA	6,6		8	43	91	53	36	-6.6
	6,7		8	43	91	53	36	-6.7
	6,747	17/64"	8	43	91	53	36	-17/64IN
	6,8		8	43	91	53	36	-6.8
	6,9		8	43	91	53	36	-6.9
	7		8	43	91	53	36	-7
	7,1		8	43	91	53	36	-7.1
	7,144	9/32"	8	43	91	53	36	-9/32IN
	7,2		8	43	91	53	36	-7.2
	7,3		8	43	91	53	36	-7.3
	7,4		8	43	91	53	36	-7.4
	7,5		8	43	91	53	36	-7.5
	7,541	19/64"	8	43	91	53	36	-19/64IN
	7,8		8	43	91	53	36	-7.8
	7,9		8	43	91	53	36	-7.9
	7,938	5/16"	8	43	91	53	36	-5/16IN
	8		8	43	91	53	36	-8
	8,1		10	49	103	61	40	-8.1
	8,2		10	49	103	61	40	-8.2
	8,3		10	49	103	61	40	-8.3
	8,334	21/64"	10	49	103	61	40	-21/64IN
	8,4		10	49	103	61	40	-8.4
	8,5		10	49	103	61	40	-8.5
	8,6		10	49	103	61	40	-8.6
	8,7		10	49	103	61	40	-8.7
	8,731	11/32"	10	49	103	61	40	-11/32IN
	8,8		10	49	103	61	40	-8.8
	9		10	49	103	61	40	-9
	9,128	23/64"	10	49	103	61	40	-23/64IN
	9,2		10	49	103	61	40	-9.2
	9,3		10	49	103	61	40	-9.3
	9,5		10	49	103	61	40	-9.5
	9,525	3/8"	10	49	103	61	40	-3/8IN
	9,6		10	49	103	61	40	-9.6
	9,8		10	49	103	61	40	-9.8
	9,922	25/64"	10	49	103	61	40	-25/64IN
	10		10	49	103	61	40	-10
	10,1		12	56	118	71	45	-10.1
	10,2		12	56	118	71	45	-10.2
	10,3		12	56	118	71	45	-10.3
	10,319	13/32"	12	56	118	71	45	-13/32IN
	10,4		12	56	118	71	45	-10.4
	10,5		12	56	118	71	45	-10.5
	10,716	27/64"	12	56	118	71	45	-27/64IN
	10,8		12	56	118	71	45	-10.8
	11		12	56	118	71	45	-11
	11,1		12	56	118	71	45	-11.1
	11,113	7/16"	12	56	118	71	45	-7/16IN
	11,2		12	56	118	71	45	-11.2
	11,5		12	56	118	71	45	-11.5
	11,509	29/64"	12	56	118	71	45	-29/64IN
	11,7		12	56	118	71	45	-11.7
	11,8		12	56	118	71	45	-11.8
	11,906	15/32"	12	56	118	71	45	-15/32IN
	12		12	56	118	71	45	-12

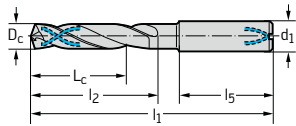

Continued



Solid carbide coolant through drills

A3382XPL

X-treme CI



5 x D_c

	P	M	K	N	S	H	O
XPL			●●		●●		

Continued

DIN 6537 long	D _c m7 mm	D _c Inches/No	d ₁ h6 mm	L _c mm	l ₁ mm	l ₂ mm	l ₅ mm	Designation A3382XPL
Shank DIN 6535 HA	12,1		14	60	124	77	45	-12.1
	12,2		14	60	124	77	45	-12.2
	12,3		14	60	124	77	45	-12.3
	12,303	31/64"	14	60	124	77	45	-31/64IN
	12,5		14	60	124	77	45	-12.5
	12,6		14	60	124	77	45	-12.6
	12,7	1/2"	14	60	124	77	45	-1/2IN
	13		14	60	124	77	45	-13
	13,3		14	60	124	77	45	-13.3
	13,494	17/32"	14	60	124	77	45	-17/32IN
	13,5		14	60	124	77	45	-13.5
	14		14	60	124	77	45	-14
	14,288	9/16"	16	63	133	83	48	-9/16IN
	14,5		16	63	133	83	48	-14.5
	15		16	63	133	83	48	-15
	15,3		16	63	133	83	48	-15.3
	15,5		16	63	133	83	48	-15.5
	15,875	5/8"	16	63	133	83	48	-5/8IN
	16		16	63	133	83	48	-16
	16,5		18	71	143	93	48	-16.5
	17		18	71	143	93	48	-17
	17,5		18	71	143	93	48	-17.5
	18		18	71	143	93	48	-18
	18,5		20	77	153	101	50	-18.5
	19		20	77	153	101	50	-19
	19,05	3/4"	20	77	153	101	50	-3/4IN
	20		20	77	153	101	50	-20

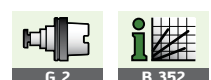
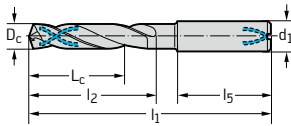

Solid carbide coolant through drills

A3384

Alpha® Ni



5 x D_c

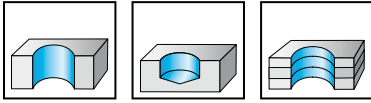

- K20F - uncoated
- Type Alpha® Ni
- right-hand cutting
- 140° point angle

Special features:
specially for machining nickel-based materials

	P	M	K	N	S	H	O
uncoated	●	●	●	●	●●	●	●

DIN 6537 long	D _c m7 mm	D _c Inches/No	d ₁ h6 mm	L _c mm	l ₁ mm	l ₂ mm	l ₅ mm	Designation A3384
Shank DIN 6535 HA	3		6	23	66	28	36	-3
	4		6	29	74	36	36	-4
	4,15		6	29	74	36	36	-4.15
	5		6	35	82	44	36	-5
	5,6		6	35	82	44	36	-5.6
	6		6	35	82	44	36	-6
	7		8	43	91	53	36	-7
	8		8	43	91	53	36	-8
	8,6		10	49	103	61	40	-8.6
	9		10	49	103	61	40	-9
	9,525	3/8"	10	49	103	61	40	-3/8IN
	10		10	49	103	61	40	-10
	11		12	56	118	71	45	-11
	12		12	56	118	71	45	-12

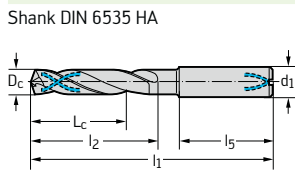

Solid carbide coolant through drill, straight flute

A3387

Alpha® Jet



5 x D_c

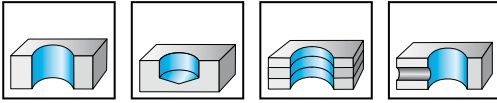

- K20F - uncoated
- Type Alpha® Jet
- right-hand cutting
- 120° point angle

	P	M	K	N	S	H	O
uncoated			●●	●●	●		●●

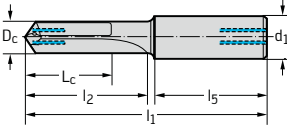
DIN 6537 long	D _c k6 mm	d ₁ h6 mm	L _c mm	l ₁ mm	l ₂ mm	l ₅ mm	Designation A3387
Shank DIN 6535 HA 	4	6	21	74	36	36	-4
	4,2	6	21	74	36	36	-4.2
	5	6	26	82	44	36	-5
	5,5	6	26	82	44	36	-5.5
	6	6	26	82	44	36	-6
	6,5	8	32	91	53	36	-6.5
	6,8	8	32	91	53	36	-6.8
	7	8	32	91	53	36	-7
	7,5	8	33	91	53	36	-7.5
	8	8	33	91	53	36	-8
	8,5	10	41	103	61	40	-8.5
	9	10	41	103	61	40	-9
	10	10	41	103	61	40	-10
	10,2	12	47	118	71	45	-10.2
	10,5	12	47	118	71	45	-10.5
	11	12	47	118	71	45	-11
	11,5	12	47	118	71	45	-11.5
	12	12	47	118	71	45	-12
	12,5	14	49	124	77	45	-12.5
	13	14	49	124	77	45	-13
14	14	49	124	77	45	-14	
15	16	59	133	83	48	-15	
15,5	16	59	133	83	48	-15.5	
16	16	59	133	83	48	-16	
17	18	66	143	93	48	-17	
17,5	18	66	143	93	48	-17.5	
18	18	66	143	93	48	-18	
19,5	20	71	153	101	50	-19.5	
20	20	71	153	101	50	-20	

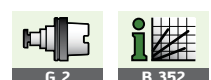

Solid carbide coolant through drills

A3389DPL

X-treme Plus



5 x D_c

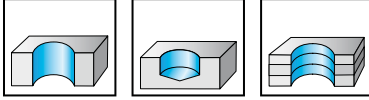

- K30F - DPL
- Type X-treme Plus
- right-hand cutting
- 140° point angle

Special features:
suitable for dry machining in steel
45 - 55 HRC

	P	M	K	N	S	H	O
DPL	●	●	●	●	●	●	●

DIN 6537 long	D _c m7 mm	D _c Inches/No	d ₁ h6 mm	L _c mm	l ₁ mm	l ₂ mm	l ₅ mm	Designation A3389DPL
Shank DIN 6535 HA	3		6	23	66	28	36	-3
	3,1		6	23	66	28	36	-3.1
	3,175	1/8"	6	23	66	28	36	-1/8IN
	3,2		6	23	66	28	36	-3.2
	3,3		6	23	66	28	36	-3.3
	3,4		6	23	66	28	36	-3.4
	3,5		6	23	66	28	36	-3.5
	3,572	9/64"	6	23	66	28	36	-9/64IN
	3,6		6	23	66	28	36	-3.6
	3,7		6	23	66	28	36	-3.7
	3,8		6	29	74	36	36	-3.8
	3,9		6	29	74	36	36	-3.9
	3,969	5/32"	6	29	74	36	36	-5/32IN
	4		6	29	74	36	36	-4
	4,1		6	29	74	36	36	-4.1
	4,2		6	29	74	36	36	-4.2
	4,3		6	29	74	36	36	-4.3
	4,366	11/64"	6	29	74	36	36	-11/64IN
	4,4		6	29	74	36	36	-4.4
	4,5		6	29	74	36	36	-4.5
	4,6		6	29	74	36	36	-4.6
	4,65		6	29	74	36	36	-4.65
	4,7		6	29	74	36	36	-4.7
	4,763	3/16"	6	35	82	44	36	-3/16IN
	4,8		6	35	82	44	36	-4.8
	4,9		6	35	82	44	36	-4.9
	5		6	35	82	44	36	-5
	5,1		6	35	82	44	36	-5.1
	5,159	13/64"	6	35	82	44	36	-13/64IN
	5,2		6	35	82	44	36	-5.2
	5,3		6	35	82	44	36	-5.3
	5,4		6	35	82	44	36	-5.4
	5,5		6	35	82	44	36	-5.5
	5,55		6	35	82	44	36	-5.55
	5,556	7/32"	6	35	82	44	36	-7/32IN
	5,6		6	35	82	44	36	-5.6
	5,7		6	35	82	44	36	-5.7
	5,8		6	35	82	44	36	-5.8
	5,9		6	35	82	44	36	-5.9
	5,953	15/64"	6	35	82	44	36	-15/64IN
	6		6	35	82	44	36	-6
	6,1		8	43	91	53	36	-6.1
	6,2		8	43	91	53	36	-6.2
	6,3		8	43	91	53	36	-6.3
	6,35	1/4"	8	43	91	53	36	-1/4IN
	6,4		8	43	91	53	36	-6.4
	6,5		8	43	91	53	36	-6.5

Continued



Solid carbide coolant through drills

A3389DPL

X-treme Plus



5 x D_c

P	M	K	N	S	H	O
●	●	●	●	●	●	●

Continued

DIN 6537 long	D _c m7 mm	D _c Inches/No	d ₁ h6 mm	L _c mm	l ₁ mm	l ₂ mm	l ₅ mm	Designation A3389DPL
Shank DIN 6535 HA	6,6		8	43	91	53	36	-6.6
	6,7		8	43	91	53	36	-6.7
	6,747	17/64"	8	43	91	53	36	-17/64IN
	6,8		8	43	91	53	36	-6.8
	6,9		8	43	91	53	36	-6.9
	7		8	43	91	53	36	-7
	7,1		8	43	91	53	36	-7.1
	7,144	9/32"	8	43	91	53	36	-9/32IN
	7,2		8	43	91	53	36	-7.2
	7,3		8	43	91	53	36	-7.3
	7,4		8	43	91	53	36	-7.4
	7,5		8	43	91	53	36	-7.5
	7,541	19/64"	8	43	91	53	36	-19/64IN
	7,8		8	43	91	53	36	-7.8
	7,9		8	43	91	53	36	-7.9
	7,938	5/16"	8	43	91	53	36	-5/16IN
	8		8	43	91	53	36	-8
	8,1		10	49	103	61	40	-8.1
	8,2		10	49	103	61	40	-8.2
	8,3		10	49	103	61	40	-8.3
	8,334	21/64"	10	49	103	61	40	-21/64IN
	8,4		10	49	103	61	40	-8.4
	8,5		10	49	103	61	40	-8.5
	8,6		10	49	103	61	40	-8.6
	8,7		10	49	103	61	40	-8.7
	8,731	11/32"	10	49	103	61	40	-11/32IN
	8,8		10	49	103	61	40	-8.8
	9		10	49	103	61	40	-9
	9,128	23/64"	10	49	103	61	40	-23/64IN
	9,2		10	49	103	61	40	-9.2
	9,3		10	49	103	61	40	-9.3
	9,5		10	49	103	61	40	-9.5
	9,525	3/8"	10	49	103	61	40	-3/8IN
	9,6		10	49	103	61	40	-9.6
	9,7		10	49	103	61	40	-9.7
	9,8		10	49	103	61	40	-9.8
	9,9		10	46	103	61	40	-9.9
	9,922	25/64"	10	49	103	61	40	-25/64IN
	10		10	49	103	61	40	-10
	10,1		12	56	118	71	45	-10.1
	10,2		12	56	118	71	45	-10.2
	10,3		12	56	118	71	45	-10.3
	10,319	13/32"	12	56	118	71	45	-13/32IN
	10,4		12	56	118	71	45	-10.4
	10,5		12	56	118	71	45	-10.5
	10,716	27/64"	12	56	118	71	45	-27/64IN
	10,8		12	56	118	71	45	-10.8
	11		12	56	118	71	45	-11
	11,1		12	56	118	71	45	-11.1
	11,113	7/16"	12	56	118	71	45	-7/16IN
	11,2		12	56	118	71	45	-11.2
	11,5		12	56	118	71	45	-11.5
	11,509	29/64"	12	56	118	71	45	-29/64IN
	11,7		12	56	118	71	45	-11.7
	11,8		12	56	118	71	45	-11.8

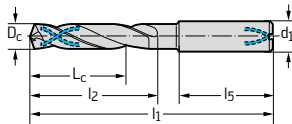

Continued



Solid carbide coolant through drills

A3389DPL

X-treme Plus

 5 x D_c

Continued

	P	M	K	N	S	H	O
DPL	●●	●●	●●	●●	●●	●●	●

DIN 6537 long	D _c m7 mm	D _c Inches/No	d ₁ h6 mm	L _c mm	l ₁ mm	l ₂ mm	l ₅ mm	Designation A3389DPL
Shank DIN 6535 HA	11,906	15/32"	12	56	118	71	45	-15/32IN
	12		12	56	118	71	45	-12
	12,1		14	60	124	77	45	-12.1
	12,2		14	60	124	77	45	-12.2
	12,3		14	60	124	77	45	-12.3
	12,303	31/64"	14	60	124	77	45	-31/64IN
	12,5		14	60	124	77	45	-12.5
	12,6		14	60	124	77	45	-12.6
	12,7	1/2"	14	60	124	77	45	-1/2IN
	13		14	60	124	77	45	-13
	13,3		14	60	124	77	45	-13.3
	13,494	17/32"	14	60	124	77	45	-17/32IN
	13,5		14	60	124	77	45	-13.5
	14		14	60	124	77	45	-14
	14,288	9/16"	16	63	133	83	48	-9/16IN
	14,5		16	63	133	83	48	-14.5
	15		16	63	133	83	48	-15
	15,5		16	63	133	83	48	-15.5
	15,875	5/8"	16	63	133	83	48	-5/8IN
	16		16	63	133	83	48	-16
	16,5		18	71	143	93	48	-16.5
	17		18	71	143	93	48	-17
	17,5		18	71	143	93	48	-17.5
	18		18	71	143	93	48	-18
	18,5		20	77	153	101	50	-18.5
	19		20	77	153	101	50	-19
	19,05	3/4"	20	77	153	101	50	-3/4IN
	20		20	77	153	101	50	-20

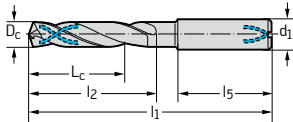

Solid carbide coolant through drills

A3399XPL

X-treme



5 x D_c

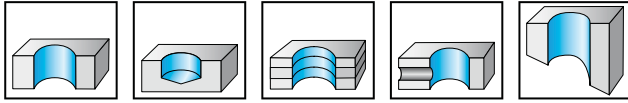

- K30F - XPL
- Type X-treme
- right-hand cutting
- 140° point angle

Special features:
suitable for dry machining in steel
45 - 55 HRC

	P	M	K	N	S	H	O
XPL	●	●	●	●	●	●	●

DIN 6537 long	D _c mm	D _c Inches/No	d ₁ h6 mm	L _c mm	l ₁ mm	l ₂ mm	l ₅ mm	Designation A3399XPL
Shank DIN 6535 HA 	3		6	23	66	28	36	-3
	3,1		6	23	66	28	36	-3.1
	3,175	1/8"	6	23	66	28	36	-1/8IN
	3,2		6	23	66	28	36	-3.2
	3,25		6	23	66	28	36	-3.25
	3,3		6	23	66	28	36	-3.3
	3,4		6	23	66	28	36	-3.4
	3,5		6	23	66	28	36	-3.5
	3,572	9/64"	6	23	66	28	36	-9/64IN
	3,6		6	23	66	28	36	-3.6
	3,65		6	23	66	28	36	-3.65
	3,7		6	23	66	28	36	-3.7
	3,8		6	29	74	36	36	-3.8
	3,9		6	29	74	36	36	-3.9
	3,969	5/32"	6	29	74	36	36	-5/32IN
	4		6	29	74	36	36	-4
	4,1		6	29	74	36	36	-4.1
	4,2		6	29	74	36	36	-4.2
	4,3		6	29	74	36	36	-4.3
	4,366	11/64"	6	29	74	36	36	-11/64IN
	4,4		6	29	74	36	36	-4.4
	4,5		6	29	74	36	36	-4.5
	4,6		6	29	74	36	36	-4.6
	4,65		6	29	74	36	36	-4.65
	4,7		6	29	74	36	36	-4.7
	4,763	3/16"	6	35	82	44	36	-3/16IN
	4,8		6	35	82	44	36	-4.8
	4,9		6	35	82	44	36	-4.9
	5		6	35	82	44	36	-5
	5,1		6	35	82	44	36	-5.1
	5,159	13/64"	6	35	82	44	36	-13/64IN
	5,2		6	35	82	44	36	-5.2
	5,3		6	35	82	44	36	-5.3
	5,4		6	35	82	44	36	-5.4
5,5		6	35	82	44	36	-5.5	
5,55		6	35	82	44	36	-5.55	
5,556	7/32"	6	35	82	44	36	-7/32IN	
5,6		6	35	82	44	36	-5.6	
5,7		6	35	82	44	36	-5.7	
5,8		6	35	82	44	36	-5.8	
5,9		6	35	82	44	36	-5.9	
5,953	15/64"	6	35	82	44	36	-15/64IN	
6		6	35	82	44	36	-6	
6,1		8	43	91	53	36	-6.1	
6,2		8	43	91	53	36	-6.2	
6,3		8	43	91	53	36	-6.3	
6,35	1/4"	8	43	91	53	36	-1/4IN	

Continued

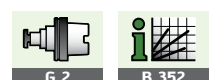

Solid carbide coolant through drills

A3399XPL

X-treme

 5 x D_c

Continued

	P	M	K	N	S	H	O
XPL	●●	●●	●●	●●	●●	●●	●●

DIN 6537 long	D _c m7 mm	D _c Inches/No	d ₁ h6 mm	L _c mm	l ₁ mm	l ₂ mm	l ₅ mm	Designation A3399XPL
Shank DIN 6535 HA	6,4		8	43	91	53	36	-6.4
	6,5		8	43	91	53	36	-6.5
	6,6		8	43	91	53	36	-6.6
	6,7		8	43	91	53	36	-6.7
	6,747	17/64"	8	43	91	53	36	-17/64IN
	6,8		8	43	91	53	36	-6.8
	6,9		8	43	91	53	36	-6.9
	7		8	43	91	53	36	-7
	7,1		8	43	91	53	36	-7.1
	7,144	9/32"	8	43	91	53	36	-9/32IN
	7,2		8	43	91	53	36	-7.2
	7,3		8	43	91	53	36	-7.3
	7,4		8	43	91	53	36	-7.4
	7,5		8	43	91	53	36	-7.5
	7,541	19/64"	8	43	91	53	36	-19/64IN
	7,55		8	43	91	53	36	-7.55
	7,6		8	43	91	53	36	-7.6
	7,7		8	43	91	53	36	-7.7
	7,8		8	43	91	53	36	-7.8
	7,9		8	43	91	53	36	-7.9
	7,938	5/16"	8	43	91	53	36	-5/16IN
	8		8	43	91	53	36	-8
	8,1		10	49	103	61	40	-8.1
	8,2		10	49	103	61	40	-8.2
	8,3		10	49	103	61	40	-8.3
	8,334	21/64"	10	49	103	61	40	-21/64IN
	8,4		10	49	103	61	40	-8.4
	8,5		10	49	103	61	40	-8.5
	8,6		10	49	103	61	40	-8.6
	8,7		10	49	103	61	40	-8.7
	8,731	11/32"	10	49	103	61	40	-11/32IN
	8,8		10	49	103	61	40	-8.8
	8,9		10	49	103	61	40	-8.9
	9		10	49	103	61	40	-9
	9,1		10	49	103	61	40	-9.1
	9,128	23/64"	10	49	103	61	40	-23/64IN
	9,2		10	49	103	61	40	-9.2
	9,3		10	49	103	61	40	-9.3
	9,4		10	49	103	61	40	-9.4
	9,5		10	49	103	61	40	-9.5
	9,525	3/8"	10	49	103	61	40	-3/8IN
	9,55		10	49	103	61	40	-9.55
	9,6		10	49	103	61	40	-9.6
	9,7		10	49	103	61	40	-9.7
	9,8		10	49	103	61	40	-9.8
	9,9		10	49	103	61	40	-9.9
	9,922	25/64"	10	49	103	61	40	-25/64IN
	10		10	49	103	61	40	-10
	10,1		12	56	118	71	45	-10.1
	10,2		12	56	118	71	45	-10.2
	10,3		12	56	118	71	45	-10.3
	10,319	13/32"	12	56	118	71	45	-13/32IN
	10,4		12	56	118	71	45	-10.4
	10,5		12	56	118	71	45	-10.5
	10,6		12	56	118	71	45	-10.6

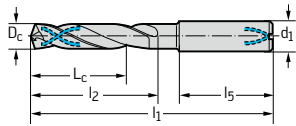

Continued



Solid carbide coolant through drills

A3399XPL

X-treme



5 x D_c

Continued

	P	M	K	N	S	H	O
XPL	●●	●●	●●	●●	●●	●●	●●

DIN 6537 long	D _c m7 mm	D _c Inches/No	d ₁ h6 mm	L _c mm	l ₁ mm	l ₂ mm	l ₅ mm	Designation A3399XPL
Shank DIN 6535 HA	10,7		12	56	118	71	45	-10.7
	10,716	27/64"	12	56	118	71	45	-27/64IN
	10,8		12	56	118	71	45	-10.8
	10,9		12	56	118	71	45	-10.9
	11		12	56	118	71	45	-11
	11,1		12	56	118	71	45	-11.1
	11,113	7/16"	12	56	118	71	45	-7/16IN
	11,2		12	56	118	71	45	-11.2
	11,3		12	56	118	71	45	-11.3
	11,4		12	56	118	71	45	-11.4
	11,5		12	56	118	71	45	-11.5
	11,509	29/64"	12	56	118	71	45	-29/64IN
	11,55		12	56	118	71	45	-11.55
	11,6		12	56	118	71	45	-11.6
	11,7		12	56	118	71	45	-11.7
	11,8		12	56	118	71	45	-11.8
	11,9		12	56	118	71	45	-11.9
	11,906	15/32"	12	56	118	71	45	-15/32IN
	12		12	56	118	71	45	-12
	12,1		14	60	124	77	45	-12.1
	12,2		14	60	124	77	45	-12.2
	12,25		14	60	124	77	45	-12.25
	12,3		14	60	124	77	45	-12.3
	12,303	31/64"	14	60	124	77	45	-31/64IN
	12,4		14	60	124	77	45	-12.4
	12,5		14	60	124	77	45	-12.5
	12,6		14	60	124	77	45	-12.6
	12,7	1/2"	14	60	124	77	45	-1/2IN
	12,75		14	60	124	77	45	-12.75
	12,8		14	60	124	77	45	-12.8
	12,9		14	60	124	77	45	-12.9
	13		14	60	124	77	45	-13
	13,1		14	60	124	77	45	-13.1
	13,2		14	60	124	77	45	-13.2
	13,3		14	60	124	77	45	-13.3
	13,4		14	60	124	77	45	-13.4
	13,494	17/32"	14	60	124	77	45	-17/32IN
	13,5		14	60	124	77	45	-13.5
	13,6		14	60	124	77	45	-13.6
	13,7		14	60	124	77	45	-13.7
	13,8		14	60	124	77	45	-13.8
	13,9		14	60	124	77	45	-13.9
	14		14	60	124	77	45	-14
	14,1		16	63	133	83	48	-14.1
	14,2		16	63	133	83	48	-14.2
	14,288	9/16"	16	63	133	83	48	-9/16IN
	14,3		16	63	133	83	48	-14.3
	14,4		16	63	133	83	48	-14.4
	14,5		16	63	133	83	48	-14.5
	14,6		16	63	133	83	48	-14.6
	14,7		16	63	133	83	48	-14.7
	14,75		16	63	133	83	48	-14.75
	14,8		16	63	133	83	48	-14.8
	14,9		16	63	133	83	48	-14.9
	15		16	63	133	83	48	-15

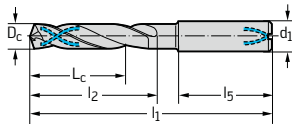

Continued



Solid carbide coolant through drills

A3399XPL

X-treme

 5 x D_c

Continued

	P	M	K	N	S	H	O
XPL	●●	●●	●●	●●	●●	●●	●●

DIN 6537 long	D _c m7 mm	D _c Inches/No	d ₁ h6 mm	L _c mm	l ₁ mm	l ₂ mm	l ₅ mm	Designation A3399XPL
Shank DIN 6535 HA	15,1		16	63	133	83	48	-15.1
	15,2		16	63	133	83	48	-15.2
	15,3		16	63	133	83	48	-15.3
	15,4		16	63	133	83	48	-15.4
	15,5		16	63	133	83	48	-15.5
	15,6		16	63	133	83	48	-15.6
	15,7		16	63	133	83	48	-15.7
	15,8		16	63	133	83	48	-15.8
	15,875	5/8"	16	63	133	83	48	-5/8IN
	15,9		16	63	133	83	48	-15.9
	16		16	63	133	83	48	-16
	16,1		18	71	143	93	48	-16.1
	16,2		18	71	143	93	48	-16.2
	16,3		18	71	143	93	48	-16.3
	16,4		18	71	143	93	48	-16.4
	16,5		18	71	143	93	48	-16.5
	16,6		18	71	143	93	48	-16.6
	16,7		18	71	143	93	48	-16.7
	16,75		18	71	143	93	48	-16.75
	16,8		18	71	143	93	48	-16.8
	16,9		18	71	143	93	48	-16.9
	17		18	71	143	93	48	-17
	17,1		18	71	143	93	48	-17.1
	17,2		18	71	143	93	48	-17.2
	17,3		18	71	143	93	48	-17.3
	17,4		18	71	143	93	48	-17.4
	17,5		18	71	143	93	48	-17.5
	17,6		18	71	143	93	48	-17.6
	17,7		18	71	143	93	48	-17.7
	17,8		18	71	143	93	48	-17.8
	17,9		18	71	143	93	48	-17.9
	18		18	71	143	93	48	-18
	18,1		20	77	153	101	50	-18.1
	18,2		20	77	153	101	50	-18.2
	18,3		20	77	153	101	50	-18.3
	18,4		20	77	153	101	50	-18.4
	18,5		20	77	153	101	50	-18.5
	18,6		20	77	153	101	50	-18.6
	18,7		20	77	153	101	50	-18.7
	18,8		20	77	153	101	50	-18.8
	18,9		20	77	153	101	50	-18.9
	19		20	77	153	101	50	-19
	19,05	3/4"	20	77	153	101	50	-3/4IN
	19,1		20	77	153	101	50	-19.1
	19,2		20	77	153	101	50	-19.2
	19,3		20	77	153	101	50	-19.3
	19,4		20	77	153	101	50	-19.4
	19,5		20	77	153	101	50	-19.5
	19,6		20	77	153	101	50	-19.6
	19,7		20	77	153	101	50	-19.7
	19,8		20	77	153	101	50	-19.8
	19,9		20	77	153	101	50	-19.9
	20		20	77	153	101	50	-20
	20,5		25	86	166	108	56	-20.5
	21		25	86	166	108	56	-21

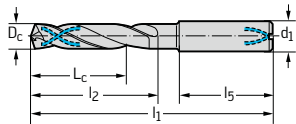

Continued



Solid carbide coolant through drills A3399XPL X-treme



5 x D_c

Continued

	P	M	K	N	S	H	O
XPL	●●	●●	●●	●●	●●	●●	

DIN 6537 long	D _c m7 mm	D _c Inches/No	d ₁ h6 mm	L _c mm	l ₁ mm	l ₂ mm	l ₅ mm	Designation A3399XPL
Shank DIN 6535 HA	21,5		25	86	166	108	56	-21.5
	22		25	86	166	108	56	-22
	22,5		25	91	173	115	56	-22.5
	23		25	91	173	115	56	-23
	23,5		25	91	173	115	56	-23.5
	24		25	91	173	115	56	-24
	24,5		25	97	180	122	56	-24.5
	25		25	97	180	122	56	-25

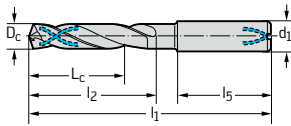

Solid carbide coolant through drills

A3486TIP

Alpha® 44



8 x D_c

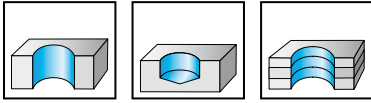

- K30F - TIP
- Type Alpha® 44
- right-hand cutting
- 130° point angle
- 40° right-hand helix

	P	M	K	N	S	H	O
TIP	●●	●●	●	●●	●●		●●

	D _c m7 mm	d ₁ h6 mm	L _c mm	l ₁ mm	l ₂ mm	l ₅ mm	Designation A3486TIP
Shank DIN 6535 HA	5	6	54	101	63	36	-5
	5,1	6	54	101	63	36	-5.1
	5,2	6	54	101	63	36	-5.2
	5,5	6	54	101	63	36	-5.5
	5,8	6	54	101	63	36	-5.8
	6	6	54	101	63	36	-6
	6,1	8	67	117	79	36	-6.1
	6,5	8	67	117	79	36	-6.5
	6,6	8	67	117	79	36	-6.6
	6,8	8	67	117	79	36	-6.8
	7	8	67	117	79	36	-7
	7,5	8	67	117	79	36	-7.5
	7,8	8	67	117	79	36	-7.8
	8	8	67	117	79	36	-8
	8,1	10	76	133	91	40	-8.1
	8,5	10	76	133	91	40	-8.5
	9	10	76	133	91	40	-9
	9,5	10	76	133	91	40	-9.5
	10	10	76	133	91	40	-10
	10,2	12	86	151	104	45	-10.2
	10,5	12	86	151	104	45	-10.5
	11	12	86	151	104	45	-11
	11,5	12	86	151	104	45	-11.5
	12	12	86	151	104	45	-12

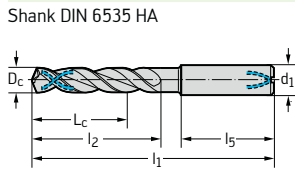

Solid carbide coolant through drill, straight flute

A3487

Alpha® Jet



8 x D_c

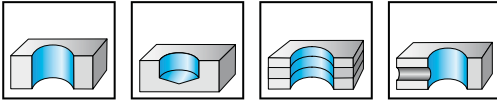

- K20F - uncoated
- Type Alpha® Jet
- right-hand cutting
- 120° point angle

	P	M	K	N	S	H	O
uncoated			●●	●●	●		●●

	D _c k6 mm	d ₁ h6 mm	L _c mm	l ₁ mm	l ₂ mm	l ₅ mm	Designation A3487
Shank DIN 6535 HA	5	6	45	101	63	36	-5
	6	6	45	101	63	36	-6
	7	8	59	117	79	36	-7
	8	8	59	117	79	36	-8
	9	10	71	133	91	40	-9
	10	10	71	133	91	40	-10
	11	12	80	151	104	45	-11
	12	12	80	151	104	45	-12
	14	14	85	160	113	45	-14
	15	16	104	178	128	48	-15
	16	16	104	178	128	48	-16
	17	18	114	191	141	48	-17
	17,5	18	114	191	141	48	-17.5
	18	18	114	191	141	48	-18
	20	20	123	205	153	50	-20

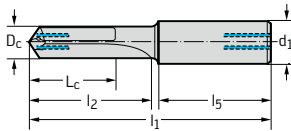

Solid carbide coolant through drills

A3586TIP

Alpha® 44



8 x D_c

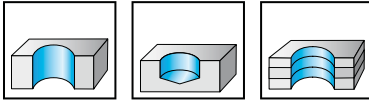

- K30F - TIP
- Type Alpha® 44
- right-hand cutting
- 130° point angle
- 40° right-hand helix

	P	M	K	N	S	H	O
TIP	●●	●●	●●	●●	●●		●●

	D _c m7 mm	d ₁ h6 mm	L _c mm	l ₁ mm	l ₂ mm	l ₅ mm	Designation A3586TIP
Shank DIN 6535 HE	5	6	54	101	63	36	-5
	5,1	6	54	101	63	36	-5.1
	5,2	6	54	101	63	36	-5.2
	5,5	6	54	101	63	36	-5.5
	5,8	6	54	101	63	36	-5.8
	6	6	54	101	63	36	-6
	6,1	8	67	117	79	36	-6.1
	6,5	8	67	117	79	36	-6.5
	6,6	8	67	117	79	36	-6.6
	6,8	8	67	117	79	36	-6.8
	7	8	67	117	79	36	-7
	7,5	8	67	117	79	36	-7.5
	7,8	8	67	117	79	36	-7.8
	8	8	67	117	79	36	-8
	8,1	10	76	133	91	40	-8.1
	8,5	10	76	133	91	40	-8.5
	9	10	76	133	91	40	-9
	9,5	10	76	133	91	40	-9.5
	10	10	76	133	91	40	-10
	10,2	12	86	151	104	45	-10.2
	10,5	12	86	151	104	45	-10.5
	11	12	86	151	104	45	-11
	11,5	12	86	151	104	45	-11.5
	12	12	86	151	104	45	-12

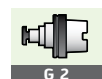
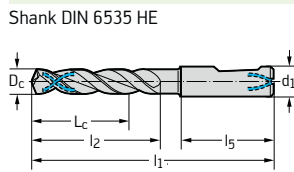

Solid carbide coolant through drill, straight flute A3687 Alpha® Jet



12 x D_c

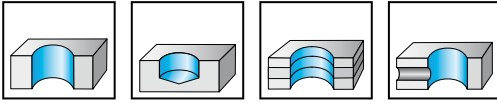

- K20F - uncoated
- Type Alpha® Jet
- right-hand cutting
- 120° point angle

	P	M	K	N	S	H	O
uncoated			●●	●●	●		●●

	D _c k6 mm	d ₁ h6 mm	L _c mm	l ₁ mm	l ₂ mm	l ₅ mm	Designation A3687
Shank DIN 6535 HA	5	6	79	132	94	36	-5
	5,5	6	83	139	101	36	-5.5
	6	6	83	139	101	36	-6
	6,5	8	107	165	127	36	-6.5
	6,8	8	107	165	127	36	-6.8
	7	8	107	165	127	36	-7
	7,5	8	107	165	127	36	-7.5
	8	8	107	165	127	36	-8
	8,5	10	122	184	142	40	-8.5
	9	10	122	184	142	40	-9
	10	10	122	184	142	40	-10
	10,2	12	134	205	158	45	-10.2
	10,5	12	134	205	158	45	-10.5
	11	12	134	205	158	45	-11
	11,5	12	134	205	158	45	-11.5
	12	12	134	205	158	45	-12
	12,5	14	139	214	167	45	-12.5
	13	14	139	214	167	45	-13
	14	14	139	214	167	45	-14
	15	16	153	227	177	48	-15
	16	16	153	227	177	48	-16
	17	18	164	241	191	48	-17
	18	18	164	241	191	48	-18
	20	20	172	254	202	50	-20

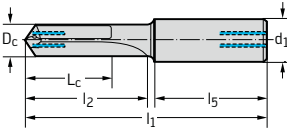

Solid carbide twist drill

A3865TFL

Alpha® 2



3 x D_c

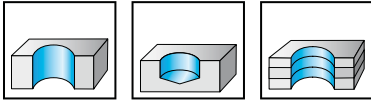

- K30F - TFL
- Type Alpha® 2
- right-hand cutting
- 140° point angle

Special features:
suitable for dry machining in steel
45 - 55 HRC

	P	M	K	N	S	H	O
TFL	●●	●●	●●	●●	●●	●●	

DIN 6537 short	D _c m7 mm	d ₁ h6 mm	L _c mm	l ₁ mm	l ₂ mm	l ₅ mm	Designation A3865TFL
Shank DIN 6535 HE	3	6	14	62	20	36	-3
	3,1	6	14	62	20	36	-3.1
	3,2	6	14	62	20	36	-3.2
	3,25	6	14	62	20	36	-3.25
	3,3	6	14	62	20	36	-3.3
	3,4	6	14	62	20	36	-3.4
	3,5	6	14	62	20	36	-3.5
	3,6	6	14	62	20	36	-3.6
	3,65	6	14	62	20	36	-3.65
	3,7	6	14	62	20	36	-3.7
	3,8	6	17	66	24	36	-3.8
	3,9	6	17	66	24	36	-3.9
	4	6	17	66	24	36	-4
	4,1	6	17	66	24	36	-4.1
	4,2	6	17	66	24	36	-4.2
	4,3	6	17	66	24	36	-4.3
	4,4	6	17	66	24	36	-4.4
	4,5	6	17	66	24	36	-4.5
	4,6	6	17	66	24	36	-4.6
	4,65	6	17	66	24	36	-4.65
	4,7	6	17	66	24	36	-4.7
	4,8	6	20	66	28	36	-4.8
	4,9	6	20	66	28	36	-4.9
	5	6	20	66	28	36	-5
	5,1	6	20	66	28	36	-5.1
	5,2	6	20	66	28	36	-5.2
	5,3	6	20	66	28	36	-5.3
	5,4	6	20	66	28	36	-5.4
	5,5	6	20	66	28	36	-5.5
	5,55	6	20	66	28	36	-5.55
	5,6	6	20	66	28	36	-5.6
	5,7	6	20	66	28	36	-5.7
	5,8	6	20	66	28	36	-5.8
	5,9	6	20	66	28	36	-5.9
	6	6	20	66	28	36	-6
	6,1	8	24	79	34	36	-6.1
	6,2	8	24	79	34	36	-6.2
	6,3	8	24	79	34	36	-6.3
	6,4	8	24	79	34	36	-6.4
	6,5	8	24	79	34	36	-6.5
	6,6	8	24	79	34	36	-6.6
	6,7	8	24	79	34	36	-6.7
	6,8	8	24	79	34	36	-6.8
	6,9	8	24	79	34	36	-6.9
	7	8	24	79	34	36	-7
	7,1	8	29	79	41	36	-7.1
	7,2	8	29	79	41	36	-7.2

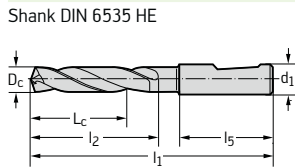

Continued



Solid carbide twist drill

A3865TFL

Alpha® 2



3 x D_c

Continued

TFL	P	M	K	N	S	H	O
	●●	●●	●●	●●	●●	●●	●●

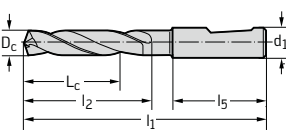
DIN 6537 short	D _c m7 mm	d ₁ h6 mm	L _c mm	l ₁ mm	l ₂ mm	l ₅ mm	Designation A3865TFL
Shank DIN 6535 HE	7,3	8	29	79	41	36	-7.3
	7,4	8	29	79	41	36	-7.4
	7,5	8	29	79	41	36	-7.5
	7,55	8	29	79	41	36	-7.55
	7,6	8	29	79	41	36	-7.6
	7,7	8	29	79	41	36	-7.7
	7,8	8	29	79	41	36	-7.8
	7,9	8	29	79	41	36	-7.9
	8	8	29	79	41	36	-8
	8,1	10	35	89	47	40	-8.1
	8,2	10	35	89	47	40	-8.2
	8,3	10	35	89	47	40	-8.3
	8,4	10	35	89	47	40	-8.4
	8,5	10	35	89	47	40	-8.5
	8,6	10	35	89	47	40	-8.6
	8,7	10	35	89	47	40	-8.7
	8,8	10	35	89	47	40	-8.8
	8,9	10	35	89	47	40	-8.9
	9	10	35	89	47	40	-9
	9,1	10	35	89	47	40	-9.1
	9,2	10	35	89	47	40	-9.2
	9,3	10	35	89	47	40	-9.3
	9,4	10	35	89	47	40	-9.4
	9,5	10	35	89	47	40	-9.5
	9,55	10	35	89	47	40	-9.55
	9,6	10	35	89	47	40	-9.6
	9,7	10	35	89	47	40	-9.7
	9,8	10	35	89	47	40	-9.8
	9,9	10	35	89	47	40	-9.9
	10	10	35	89	47	40	-10
	10,1	12	40	102	55	45	-10.1
	10,2	12	40	102	55	45	-10.2
	10,3	12	40	102	55	45	-10.3
	10,4	12	40	102	55	45	-10.4
	10,5	12	40	102	55	45	-10.5
	10,6	12	40	102	55	45	-10.6
	10,7	12	40	102	55	45	-10.7
	10,8	12	40	102	55	45	-10.8
	10,9	12	40	102	55	45	-10.9
	11	12	40	102	55	45	-11
	11,1	12	40	102	55	45	-11.1
	11,2	12	40	102	55	45	-11.2
	11,3	12	40	102	55	45	-11.3
	11,4	12	40	102	55	45	-11.4
	11,5	12	40	102	55	45	-11.5
	11,55	12	40	102	55	45	-11.55
	11,6	12	40	102	55	45	-11.6
	11,7	12	40	102	55	45	-11.7
	11,8	12	40	102	55	45	-11.8
	11,9	12	40	102	55	45	-11.9
	12	12	40	102	55	45	-12
	12,1	14	43	107	60	45	-12.1
	12,2	14	43	107	60	45	-12.2
	12,25	14	43	107	60	45	-12.25
	12,3	14	43	107	60	45	-12.3

Continued



Solid carbide twist drill

A3865TFL

Alpha® 2

3 x D_c



Continued

	P	M	K	N	S	H	O
TFL	●●	●●	●●	●●	●●	●●	●●

DIN 6537 short	D _c m7 mm	d ₁ h6 mm	L _c mm	l ₁ mm	l ₂ mm	l ₅ mm	Designation A3865TFL
Shank DIN 6535 HE	12,4	14	43	107	60	45	-12.4
	12,5	14	43	107	60	45	-12.5
	12,6	14	43	107	60	45	-12.6
	12,7	14	43	107	60	45	-12.7
	12,75	14	43	107	60	45	-12.75
	12,8	14	43	107	60	45	-12.8
	12,9	14	43	107	60	45	-12.9
	13	14	43	107	60	45	-13
	13,1	14	43	107	60	45	-13.1
	13,2	14	43	107	60	45	-13.2
	13,3	14	43	107	60	45	-13.3
	13,4	14	43	107	60	45	-13.4
	13,5	14	43	107	60	45	-13.5
	13,6	14	43	107	60	45	-13.6
	13,7	14	43	107	60	45	-13.7
	13,8	14	43	107	60	45	-13.8
	13,9	14	43	107	60	45	-13.9
	14	14	43	107	60	45	-14
	14,1	16	45	115	65	48	-14.1
	14,2	16	45	115	65	48	-14.2
	14,3	16	45	115	65	48	-14.3
	14,4	16	45	115	65	48	-14.4
	14,5	16	45	115	65	48	-14.5
	14,6	16	45	115	65	48	-14.6
	14,7	16	45	115	65	48	-14.7
	14,75	16	45	115	65	48	-14.75
	14,8	16	45	115	65	48	-14.8
	15	16	45	115	65	48	-15
	15,1	16	45	115	65	48	-15.1
	15,2	16	45	115	65	48	-15.2
	15,3	16	45	115	65	48	-15.3
	15,5	16	45	115	65	48	-15.5
	15,6	16	45	115	65	48	-15.6
	15,7	16	45	115	65	48	-15.7
	15,8	16	45	115	65	48	-15.8
	15,9	16	45	115	65	48	-15.9
	16	16	45	115	65	48	-16
	16,1	18	51	123	73	48	-16.1
	16,2	18	51	123	73	48	-16.2
	16,3	18	51	123	73	48	-16.3
	16,4	18	51	123	73	48	-16.4
	16,5	18	51	123	73	48	-16.5
	16,6	18	51	123	73	48	-16.6
	16,7	18	51	123	73	48	-16.7
	16,75	18	51	123	73	48	-16.75
	16,8	18	51	123	73	48	-16.8
	17	18	51	123	73	48	-17
	17,2	18	51	123	73	48	-17.2
	17,3	18	51	123	73	48	-17.3
	17,5	18	51	123	73	48	-17.5
	17,6	18	51	123	73	48	-17.6
	17,7	18	51	123	73	48	-17.7
	17,8	18	51	123	73	48	-17.8
	18	18	51	123	73	48	-18
	18,2	20	55	131	79	50	-18.2

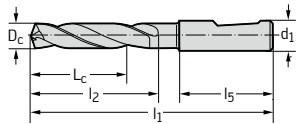

Solid carbide twist drill
A3865TFL
Alpha® 2



3 x D_c

Continued

	P	M	K	N	S	H	0
TFL	●●	●●	●●	●●	●●	●●	

DIN 6537 short	D _c m7 mm	d ₁ h6 mm	L _c mm	l ₁ mm	l ₂ mm	l ₅ mm	Designation A3865TFL
Shank DIN 6535 HE	18,5	20	55	131	79	50	-18.5
	18,7	20	55	131	79	50	-18.7
	18,8	20	55	131	79	50	-18.8
	19	20	55	131	79	50	-19
	19,5	20	55	131	79	50	-19.5
	19,7	20	55	131	79	50	-19.7
	19,8	20	55	131	79	50	-19.8
	20	20	55	131	79	50	-20

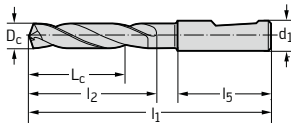

Solid carbide coolant through drills

A3885TFL

Alpha® 4



3 x D_c

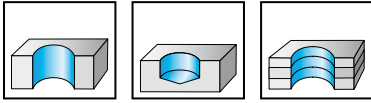

- K30F - TFL
- Type Alpha® 4
- right-hand cutting
- 140° point angle

Special features:
45 - 55 HRC

	P	M	K	N	S	H	O
TFL	●●	●●	●●	●●	●●	●●	●●

DIN 6537 short	D _c m7 mm	d ₁ h6 mm	L _c mm	l ₁ mm	l ₂ mm	l ₅ mm	Designation A3885TFL
Shank DIN 6535 HE	3	6	14	62	20	36	-3
	3,1	6	14	62	20	36	-3.1
	3,2	6	14	62	20	36	-3.2
	3,25	6	14	62	20	36	-3.25
	3,3	6	14	62	20	36	-3.3
	3,4	6	14	62	20	36	-3.4
	3,5	6	14	62	20	36	-3.5
	3,6	6	14	62	20	36	-3.6
	3,65	6	14	62	20	36	-3.65
	3,7	6	14	62	20	36	-3.7
	3,8	6	17	66	24	36	-3.8
	3,9	6	17	66	24	36	-3.9
	4	6	17	66	24	36	-4
	4,1	6	17	66	24	36	-4.1
	4,2	6	17	66	24	36	-4.2
	4,3	6	17	66	24	36	-4.3
	4,4	6	17	66	24	36	-4.4
	4,5	6	17	66	24	36	-4.5
	4,6	6	17	66	24	36	-4.6
	4,65	6	17	66	24	36	-4.65
	4,7	6	17	66	24	36	-4.7
	4,8	6	20	66	28	36	-4.8
	4,9	6	20	66	28	36	-4.9
	5	6	20	66	28	36	-5
	5,1	6	20	66	28	36	-5.1
	5,2	6	20	66	28	36	-5.2
	5,3	6	20	66	28	36	-5.3
	5,4	6	20	66	28	36	-5.4
	5,5	6	20	66	28	36	-5.5
	5,55	6	20	66	28	36	-5.55
	5,6	6	20	66	28	36	-5.6
	5,7	6	20	66	28	36	-5.7
	5,8	6	20	66	28	36	-5.8
	5,9	6	20	66	28	36	-5.9
	6	6	20	66	28	36	-6
	6,1	8	24	79	34	36	-6.1
	6,2	8	24	79	34	36	-6.2
	6,3	8	24	79	34	36	-6.3
	6,4	8	24	79	34	36	-6.4
	6,5	8	24	79	34	36	-6.5
	6,6	8	24	79	34	36	-6.6
	6,7	8	24	79	34	36	-6.7
	6,8	8	24	79	34	36	-6.8
	6,9	8	24	79	34	36	-6.9
	7	8	24	79	34	36	-7
	7,1	8	29	79	41	36	-7.1
	7,2	8	29	79	41	36	-7.2

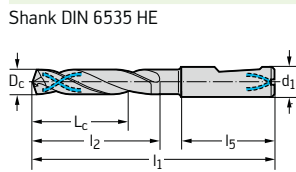

Continued





Solid carbide coolant through drills

A3885TFL

Alpha® 4

3 x D_c

Continued

	P	M	K	N	S	H	O
TFL	●●	●●	●●	●●	●●	●●	●●

DIN 6537 short	D _c m7 mm	d ₁ h6 mm	L _c mm	l ₁ mm	l ₂ mm	l ₅ mm	Designation A3885TFL
Shank DIN 6535 HE	7,3	8	29	79	41	36	-7.3
	7,4	8	29	79	41	36	-7.4
	7,5	8	29	79	41	36	-7.5
	7,55	8	29	79	41	36	-7.55
	7,6	8	29	79	41	36	-7.6
	7,7	8	29	79	41	36	-7.7
	7,8	8	29	79	41	36	-7.8
	7,9	8	29	79	41	36	-7.9
	8	8	29	79	41	36	-8
	8,1	10	35	89	47	40	-8.1
	8,2	10	35	89	47	40	-8.2
	8,3	10	35	89	47	40	-8.3
	8,4	10	35	89	47	40	-8.4
	8,5	10	35	89	47	40	-8.5
	8,6	10	35	89	47	40	-8.6
	8,7	10	35	89	47	40	-8.7
	8,8	10	35	89	47	40	-8.8
	8,9	10	35	89	47	40	-8.9
	9	10	35	89	47	40	-9
	9,1	10	35	89	47	40	-9.1
	9,2	10	35	89	47	40	-9.2
	9,3	10	35	89	47	40	-9.3
	9,4	10	35	89	47	40	-9.4
	9,5	10	35	89	47	40	-9.5
	9,55	10	35	89	47	40	-9.55
	9,6	10	35	89	47	40	-9.6
	9,7	10	35	89	47	40	-9.7
	9,8	10	35	89	47	40	-9.8
	9,9	10	35	89	47	40	-9.9
	10	10	35	89	47	40	-10
	10,1	12	40	102	55	45	-10.1
	10,2	12	40	102	55	45	-10.2
	10,3	12	40	102	55	45	-10.3
	10,4	12	40	102	55	45	-10.4
	10,5	12	40	102	55	45	-10.5
	10,6	12	40	102	55	45	-10.6
	10,7	12	40	102	55	45	-10.7
	10,8	12	40	102	55	45	-10.8
	10,9	12	40	102	55	45	-10.9
	11	12	40	102	55	45	-11
	11,1	12	40	102	55	45	-11.1
	11,2	12	40	102	55	45	-11.2
	11,3	12	40	102	55	45	-11.3
	11,4	12	40	102	55	45	-11.4
	11,5	12	40	102	55	45	-11.5
	11,55	12	40	102	55	45	-11.55
	11,6	12	40	102	55	45	-11.6
	11,7	12	40	102	55	45	-11.7
	11,8	12	40	102	55	45	-11.8
	11,9	12	40	102	55	45	-11.9
	12	12	40	102	55	45	-12
	12,1	14	43	107	60	45	-12.1
	12,2	14	43	107	60	45	-12.2
	12,25	14	43	107	60	45	-12.25
	12,3	14	43	107	60	45	-12.3

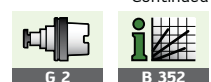
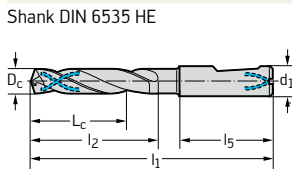

Continued

Solid carbide coolant through drills

A3885TFL

Alpha® 4

 3 x D_c

Continued

	P	M	K	N	S	H	O
TFL	●●	●●	●●	●●	●●	●●	●●

DIN 6537 short	D _c m7 mm	d ₁ h6 mm	L _c mm	l ₁ mm	l ₂ mm	l ₅ mm	Designation A3885TFL
Shank DIN 6535 HE	12,4	14	43	107	60	45	-12.4
	12,5	14	43	107	60	45	-12.5
	12,6	14	43	107	60	45	-12.6
	12,7	14	43	107	60	45	-12.7
	12,75	14	43	107	60	45	-12.75
	12,8	14	43	107	60	45	-12.8
	12,9	14	43	107	60	45	-12.9
	13	14	43	107	60	45	-13
	13,1	14	43	107	60	45	-13.1
	13,2	14	43	107	60	45	-13.2
	13,3	14	43	107	60	45	-13.3
	13,4	14	43	107	60	45	-13.4
	13,5	14	43	107	60	45	-13.5
	13,6	14	43	107	60	45	-13.6
	13,7	14	43	107	60	45	-13.7
	13,8	14	43	107	60	45	-13.8
	13,9	14	43	107	60	45	-13.9
	14	14	43	107	60	45	-14
	14,1	16	45	115	65	48	-14.1
	14,2	16	45	115	65	48	-14.2
	14,3	16	45	115	65	48	-14.3
	14,4	16	45	115	65	48	-14.4
	14,5	16	45	115	65	48	-14.5
	14,6	16	45	115	65	48	-14.6
	14,7	16	45	115	65	48	-14.7
	14,75	16	45	115	65	48	-14.75
	14,8	16	45	115	65	48	-14.8
	15	16	45	115	65	48	-15
	15,1	16	45	115	65	48	-15.1
	15,2	16	45	115	65	48	-15.2
	15,3	16	45	115	65	48	-15.3
	15,5	16	45	115	65	48	-15.5
	15,6	16	45	115	65	48	-15.6
	15,7	16	45	115	65	48	-15.7
	15,8	16	45	115	65	48	-15.8
	15,9	16	45	115	65	48	-15.9
	16	16	45	115	65	48	-16
	16,1	18	51	123	73	48	-16.1
	16,2	18	51	123	73	48	-16.2
	16,3	18	51	123	73	48	-16.3
	16,4	18	51	123	73	48	-16.4
	16,5	18	51	123	73	48	-16.5
	16,6	18	51	123	73	48	-16.6
	16,7	18	51	123	73	48	-16.7
	16,75	18	51	123	73	48	-16.75
	16,8	18	51	123	73	48	-16.8
	17	18	51	123	73	48	-17
	17,2	18	51	123	73	48	-17.2
	17,3	18	51	123	73	48	-17.3
	17,5	18	51	123	73	48	-17.5
	17,6	18	51	123	73	48	-17.6
	17,7	18	51	123	73	48	-17.7
	17,8	18	51	123	73	48	-17.8
	18	18	51	123	73	48	-18
	18,2	20	55	131	79	50	-18.2

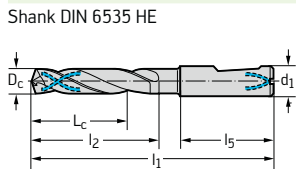

Continued





Solid carbide coolant through drills

A3885TFL

Alpha® 4

3 x D_c

Continued

	P	M	K	N	S	H	O
TFL	●●	●●	●●	●●	●●	●●	

DIN 6537 short	D _c m7 mm	d ₁ h6 mm	L _c mm	l ₁ mm	l ₂ mm	l ₅ mm	Designation A3885TFL
Shank DIN 6535 HE	18,5	20	55	131	79	50	-18.5
	18,7	20	55	131	79	50	-18.7
	18,8	20	55	131	79	50	-18.8
	19	20	55	131	79	50	-19
	19,5	20	55	131	79	50	-19.5
	19,7	20	55	131	79	50	-19.7
	19,8	20	55	131	79	50	-19.8
	20	20	55	131	79	50	-20

Solid carbide twist drill

A3965TFT

Alpha® 2



5 x D_c

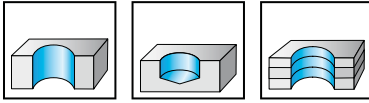

- K30F - TFT
- Type Alpha® 2
- right-hand cutting
- 140° point angle

Special features:
45 - 55 HRC

	P	M	K	N	S	H	O
TFT	●●	●●	●●	●●	●●	●●	●●

DIN 6537 long	D _c m7 mm	d ₁ h6 mm	L _c mm	l ₁ mm	l ₂ mm	l ₅ mm	Designation A3965TFT
Shank DIN 6535 HE	3	6	23	66	28	36	-3
	3,1	6	23	66	28	36	-3.1
	3,2	6	23	66	28	36	-3.2
	3,25	6	23	66	28	36	-3.25
	3,3	6	23	66	28	36	-3.3
	3,4	6	23	66	28	36	-3.4
	3,5	6	23	66	28	36	-3.5
	3,6	6	23	66	28	36	-3.6
	3,65	6	23	66	28	36	-3.65
	3,7	6	23	66	28	36	-3.7
	3,8	6	29	74	36	36	-3.8
	3,9	6	29	74	36	36	-3.9
	4	6	29	74	36	36	-4
	4,1	6	29	74	36	36	-4.1
	4,2	6	29	74	36	36	-4.2
	4,3	6	29	74	36	36	-4.3
	4,4	6	29	74	36	36	-4.4
	4,5	6	29	74	36	36	-4.5
	4,6	6	29	74	36	36	-4.6
	4,65	6	29	74	36	36	-4.65
	4,7	6	29	74	36	36	-4.7
	4,8	6	35	82	44	36	-4.8
	4,9	6	35	82	44	36	-4.9
	5	6	35	82	44	36	-5
	5,1	6	35	82	44	36	-5.1
	5,2	6	35	82	44	36	-5.2
	5,3	6	35	82	44	36	-5.3
	5,4	6	35	82	44	36	-5.4
	5,5	6	35	82	44	36	-5.5
	5,55	6	35	82	44	36	-5.55
	5,6	6	35	82	44	36	-5.6
	5,7	6	35	82	44	36	-5.7
	5,8	6	35	82	44	36	-5.8
	5,9	6	35	82	44	36	-5.9
	6	6	35	82	44	36	-6
	6,1	8	43	91	53	36	-6.1
	6,2	8	43	91	53	36	-6.2
	6,3	8	43	91	53	36	-6.3
	6,4	8	43	91	53	36	-6.4
	6,5	8	43	91	53	36	-6.5
	6,6	8	43	91	53	36	-6.6
	6,7	8	43	91	53	36	-6.7
	6,8	8	43	91	53	36	-6.8
	6,9	8	43	91	53	36	-6.9
	7	8	43	91	53	36	-7
	7,1	8	43	91	53	36	-7.1
	7,2	8	43	91	53	36	-7.2

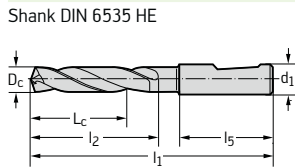

Continued





Solid carbide twist drill
A3965TFT
Alpha® 2
5 x D_c

Continued

	P	M	K	N	S	H	O
TFT	●●	●●	●●	●●	●●	●●	●●

DIN 6537 long	D _c m7 mm	d ₁ h6 mm	L _c mm	l ₁ mm	l ₂ mm	l ₅ mm	Designation A3965TFT
Shank DIN 6535 HE	7,3	8	43	91	53	36	-7.3
	7,4	8	43	91	53	36	-7.4
	7,5	8	43	91	53	36	-7.5
	7,55	8	43	91	53	36	-7.55
	7,6	8	43	91	53	36	-7.6
	7,7	8	43	91	53	36	-7.7
	7,8	8	43	91	53	36	-7.8
	7,9	8	43	91	53	36	-7.9
	8	8	43	91	53	36	-8
	8,1	10	49	103	61	40	-8.1
	8,2	10	49	103	61	40	-8.2
	8,3	10	49	103	61	40	-8.3
	8,4	10	49	103	61	40	-8.4
	8,5	10	49	103	61	40	-8.5
	8,6	10	49	103	61	40	-8.6
	8,7	10	49	103	61	40	-8.7
	8,8	10	49	103	61	40	-8.8
	8,9	10	49	103	61	40	-8.9
	9	10	49	103	61	40	-9
	9,1	10	49	103	61	40	-9.1
	9,2	10	49	103	61	40	-9.2
	9,3	10	49	103	61	40	-9.3
	9,4	10	49	103	61	40	-9.4
	9,5	10	49	103	61	40	-9.5
	9,55	10	49	103	61	40	-9.55
	9,6	10	49	103	61	40	-9.6
	9,7	10	49	103	61	40	-9.7
	9,8	10	49	103	61	40	-9.8
	9,9	10	49	103	61	40	-9.9
	10	10	49	103	61	40	-10
	10,1	12	56	118	71	45	-10.1
	10,2	12	56	118	71	45	-10.2
	10,3	12	56	118	71	45	-10.3
	10,4	12	56	118	71	45	-10.4
	10,5	12	56	118	71	45	-10.5
	10,6	12	56	118	71	45	-10.6
	10,7	12	56	118	71	45	-10.7
	10,8	12	56	118	71	45	-10.8
	10,9	12	56	118	71	45	-10.9
	11	12	56	118	71	45	-11
	11,1	12	56	118	71	45	-11.1
	11,2	12	56	118	71	45	-11.2
	11,3	12	56	118	71	45	-11.3
	11,4	12	56	118	71	45	-11.4
	11,5	12	56	118	71	45	-11.5
	11,55	12	56	118	71	45	-11.55
	11,6	12	56	118	71	45	-11.6
	11,7	12	56	118	71	45	-11.7
	11,8	12	56	118	71	45	-11.8
	11,9	12	56	118	71	45	-11.9
	12	12	56	118	71	45	-12
	12,1	14	60	124	77	45	-12.1
	12,2	14	60	124	77	45	-12.2
	12,25	14	60	124	77	45	-12.25
	12,3	14	60	124	77	45	-12.3

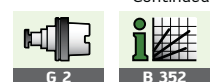
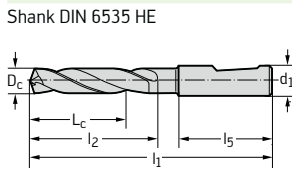

Continued

Solid carbide twist drill

A3965TFT

Alpha® 2



5 x D_c

Continued

	P	M	K	N	S	H	O
TFT	●●	●●	●●	●●	●●	●●	●●

DIN 6537 long	D _c m7 mm	d ₁ h6 mm	L _c mm	l ₁ mm	l ₂ mm	l ₅ mm	Designation A3965TFT
Shank DIN 6535 HE	12,4	14	60	124	77	45	-12.4
	12,5	14	60	124	77	45	-12.5
	12,6	14	60	124	77	45	-12.6
	12,7	14	60	124	77	45	-12.7
	12,75	14	60	124	77	45	-12.75
	12,8	14	60	124	77	45	-12.8
	12,9	14	60	124	77	45	-12.9
	13	14	60	124	77	45	-13
	13,1	14	60	124	77	45	-13.1
	13,2	14	60	124	77	45	-13.2
	13,3	14	60	124	77	45	-13.3
	13,4	14	60	124	77	45	-13.4
	13,5	14	60	124	77	45	-13.5
	13,6	14	60	124	77	45	-13.6
	13,7	14	60	124	77	45	-13.7
	13,8	14	60	124	77	45	-13.8
	13,9	14	60	124	77	45	-13.9
	14	14	60	124	77	45	-14
	14,1	16	63	133	83	48	-14.1
	14,2	16	63	133	83	48	-14.2
	14,3	16	63	133	83	48	-14.3
	14,4	16	63	133	83	48	-14.4
	14,5	16	63	133	83	48	-14.5
	14,6	16	63	133	83	48	-14.6
	14,7	16	63	133	83	48	-14.7
	14,75	16	63	133	83	48	-14.75
	14,8	16	63	133	83	48	-14.8
	15	16	63	133	83	48	-15
	15,1	16	63	133	83	48	-15.1
	15,2	16	63	133	83	48	-15.2
	15,3	16	63	133	83	48	-15.3
	15,5	16	63	133	83	48	-15.5
	15,6	16	63	133	83	48	-15.6
	15,7	16	63	133	83	48	-15.7
	15,8	16	63	133	83	48	-15.8
	15,9	16	63	133	83	48	-15.9
	16	16	63	133	83	48	-16
	16,1	18	71	143	93	48	-16.1
	16,2	18	71	143	93	48	-16.2
	16,3	18	71	143	93	48	-16.3
	16,4	18	71	143	93	48	-16.4
	16,5	18	71	143	93	48	-16.5
	16,6	18	71	143	93	48	-16.6
	16,7	18	71	143	93	48	-16.7
	16,75	18	71	143	93	48	-16.75
	16,8	18	71	143	93	48	-16.8
	17	18	71	143	93	48	-17
	17,2	18	71	143	93	48	-17.2
	17,3	18	71	143	93	48	-17.3
	17,5	18	71	143	93	48	-17.5
	17,6	18	71	143	93	48	-17.6
	17,7	18	71	143	93	48	-17.7
	17,8	18	71	143	93	48	-17.8
	18	18	71	143	93	48	-18
	18,2	20	77	153	101	50	-18.2

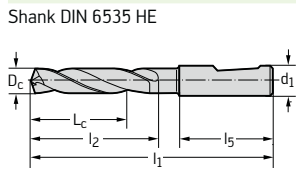



Solid carbide twist drill
A3965TFT
Alpha® 2

5 x D_c

Continued

	P	M	K	N	S	H	O
TFT	●●	●●	●●	●●	●●	●●	●●

DIN 6537 long	D _c m7 mm	d ₁ h6 mm	L _c mm	l ₁ mm	l ₂ mm	l ₅ mm	Designation A3965TFT
Shank DIN 6535 HE	18,5	20	77	153	101	50	-18.5
	18,7	20	77	153	101	50	-18.7
	18,8	20	77	153	101	50	-18.8
	19	20	77	153	101	50	-19
	19,5	20	77	153	101	50	-19.5
	19,7	20	77	153	101	50	-19.7
	19,8	20	77	153	101	50	-19.8
	20	20	77	153	101	50	-20
	20,5	25	86	166	108	56	-20.5
	21	25	86	166	108	56	-21
	21,5	25	86	166	108	56	-21.5
	22	25	86	166	108	56	-22
	22,5	25	91	173	115	56	-22.5
	23	25	91	173	115	56	-23
	23,5	25	91	173	115	56	-23.5
	24	25	91	173	115	56	-24
	24,5	25	97	180	122	56	-24.5
	25	25	97	180	122	56	-25

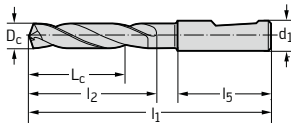

Solid carbide maximiza

A3967

BSX



5 x D_c

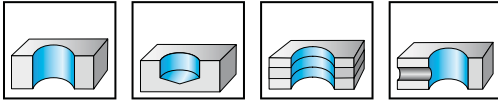

- K30F - uncoated
- Type BSX
- right-hand cutting
- 130° point angle
- Tip geometry SX

Special features:
suitable for dry machining in cast iron

	P	M	K	N	S	H	O
uncoated			●●	●●	●		●●

DIN 6537 long	D _c m7 mm	d ₁ h6 mm	L _c mm	l ₁ mm	l ₂ mm	l ₅ mm	Designation A3967
Shank DIN 6535 HE	3	6	23	66	28	36	-3
	3,15	6	23	66	28	36	-3.15
	3,3	6	23	66	28	36	-3.3
	3,5	6	23	66	28	36	-3.5
	3,7	6	23	66	28	36	-3.7
	3,8	6	29	74	36	36	-3.8
	4	6	29	74	36	36	-4
	4,2	6	29	74	36	36	-4.2
	4,3	6	29	74	36	36	-4.3
	4,45	6	29	74	36	36	-4.45
	4,5	6	29	74	36	36	-4.5
	4,65	6	29	74	36	36	-4.65
	5	6	35	82	44	36	-5
	5,5	6	35	82	44	36	-5.5
	5,55	6	35	82	44	36	-5.55
	5,75	6	35	82	44	36	-5.75
	5,9	6	35	82	44	36	-5.9
	6	6	35	82	44	36	-6
	6,5	8	43	91	53	36	-6.5
	6,55	8	43	91	53	36	-6.55
	6,8	8	43	91	53	36	-6.8
	7	8	43	91	53	36	-7
	7,25	8	43	91	53	36	-7.25
	7,4	8	43	91	53	36	-7.4
	7,45	8	43	91	53	36	-7.45
	7,5	8	43	91	53	36	-7.5
	7,55	8	43	91	53	36	-7.55
	8	8	43	91	53	36	-8
	8,5	10	49	103	61	40	-8.5
	8,75	10	49	103	61	40	-8.75
	9	10	49	103	61	40	-9
	9,3	10	49	103	61	40	-9.3
	9,4	10	49	103	61	40	-9.4
	9,5	10	49	103	61	40	-9.5
	9,55	10	49	103	61	40	-9.55
	10	10	49	103	61	40	-10
	10,2	12	56	118	71	45	-10.2
	10,5	12	56	118	71	45	-10.5
	11	12	56	118	71	45	-11
	11,2	12	56	118	71	45	-11.2
	11,3	12	56	118	71	45	-11.3
	11,5	12	56	118	71	45	-11.5
	11,55	12	56	118	71	45	-11.55
	11,7	12	56	118	71	45	-11.7
	12	12	56	118	71	45	-12
	12,5	14	60	124	77	45	-12.5
	13	14	60	124	77	45	-13

Continued



Solid carbide maximiza
A3967
BSX



5 x D_c

Continued

	P	M	K	N	S	H	O
uncoated			●●	●●	●		●●

DIN 6537 long	D _c m7 mm	d ₁ h6 mm	L _c mm	l ₁ mm	l ₂ mm	l ₅ mm	Designation A3967
Shank DIN 6535 HE	13,1	14	60	124	77	45	-13.1
	13,3	14	60	124	77	45	-13.3
	13,5	14	60	124	77	45	-13.5
	14	14	60	124	77	45	-14
	14,5	16	63	133	83	48	-14.5
	15	16	63	133	83	48	-15
	15,1	16	63	133	83	48	-15.1
	15,3	16	63	133	83	48	-15.3
	15,5	16	63	133	83	48	-15.5
	16	16	63	133	83	48	-16

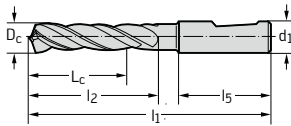

Solid carbide coolant through drills

A3999XPL

X-treme



5 x D_c

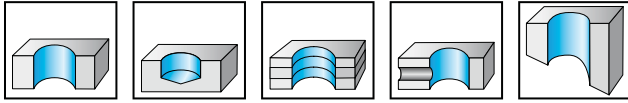

- K30F - XPL
- Type X-treme
- right-hand cutting
- 140° point angle

Special features:
suitable for dry machining in steel
45 - 55 HRC

	P	M	K	N	S	H	O
XPL	●	●	●	●	●	●	●

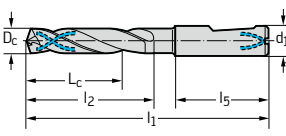
DIN 6537 long	D _c m7 mm	d ₁ h6 mm	L _c mm	l ₁ mm	l ₂ mm	l ₅ mm	Designation A3999XPL
Shank DIN 6535 HE 	3	6	23	66	28	36	-3
	3,1	6	23	66	28	36	-3.1
	3,2	6	23	66	28	36	-3.2
	3,25	6	23	66	28	36	-3.25
	3,3	6	23	66	28	36	-3.3
	3,4	6	23	66	28	36	-3.4
	3,5	6	23	66	28	36	-3.5
	3,6	6	23	66	28	36	-3.6
	3,65	6	23	66	28	36	-3.65
	3,7	6	23	66	28	36	-3.7
	3,8	6	29	74	36	36	-3.8
	3,9	6	29	74	36	36	-3.9
	4	6	29	74	36	36	-4
	4,1	6	29	74	36	36	-4.1
	4,2	6	29	74	36	36	-4.2
	4,3	6	29	74	36	36	-4.3
	4,4	6	29	74	36	36	-4.4
	4,5	6	29	74	36	36	-4.5
	4,6	6	29	74	36	36	-4.6
	4,65	6	29	74	36	36	-4.65
	4,7	6	29	74	36	36	-4.7
	4,8	6	35	82	44	36	-4.8
	4,9	6	35	82	44	36	-4.9
	5	6	35	82	44	36	-5
	5,1	6	35	82	44	36	-5.1
	5,2	6	35	82	44	36	-5.2
	5,3	6	35	82	44	36	-5.3
	5,4	6	35	82	44	36	-5.4
5,5	6	35	82	44	36	-5.5	
5,55	6	35	82	44	36	-5.55	
5,6	6	35	82	44	36	-5.6	
5,7	6	35	82	44	36	-5.7	
5,8	6	35	82	44	36	-5.8	
5,9	6	35	82	44	36	-5.9	
6	6	35	82	44	36	-6	
6,1	8	43	91	53	36	-6.1	
6,2	8	43	91	53	36	-6.2	
6,3	8	43	91	53	36	-6.3	
6,4	8	43	91	53	36	-6.4	
6,5	8	43	91	53	36	-6.5	
6,6	8	43	91	53	36	-6.6	
6,7	8	43	91	53	36	-6.7	
6,8	8	43	91	53	36	-6.8	
6,9	8	43	91	53	36	-6.9	
7	8	43	91	53	36	-7	
7,1	8	43	91	53	36	-7.1	
7,2	8	43	91	53	36	-7.2	

Continued



Solid carbide coolant through drills

A3999XPL

X-treme



5 x D_c

Continued

	P	M	K	N	S	H	O
XPL	●●	●●	●●	●●	●●	●●	●●

DIN 6537 long	D _c m7 mm	d ₁ h6 mm	L _c mm	l ₁ mm	l ₂ mm	l ₅ mm	Designation A3999XPL
Shank DIN 6535 HE	7,3	8	43	91	53	36	-7.3
	7,4	8	43	91	53	36	-7.4
	7,5	8	43	91	53	36	-7.5
	7,55	8	43	91	53	36	-7.55
	7,6	8	43	91	53	36	-7.6
	7,7	8	43	91	53	36	-7.7
	7,8	8	43	91	53	36	-7.8
	7,9	8	43	91	53	36	-7.9
	8	8	43	91	53	36	-8
	8,1	10	49	103	61	40	-8.1
	8,2	10	49	103	61	40	-8.2
	8,3	10	49	103	61	40	-8.3
	8,4	10	49	103	61	40	-8.4
	8,5	10	49	103	61	40	-8.5
	8,6	10	49	103	61	40	-8.6
	8,7	10	49	103	61	40	-8.7
	8,8	10	49	103	61	40	-8.8
	8,9	10	49	103	61	40	-8.9
	9	10	49	103	61	40	-9
	9,1	10	49	103	61	40	-9.1
	9,2	10	49	103	61	40	-9.2
	9,3	10	49	103	61	40	-9.3
	9,4	10	49	103	61	40	-9.4
	9,5	10	49	103	61	40	-9.5
	9,55	10	49	103	61	40	-9.55
	9,6	10	49	103	61	40	-9.6
	9,7	10	49	103	61	40	-9.7
	9,8	10	49	103	61	40	-9.8
	9,9	10	49	103	61	40	-9.9
	10	10	49	103	61	40	-10
	10,1	12	56	118	71	45	-10.1
	10,2	12	56	118	71	45	-10.2
	10,3	12	56	118	71	45	-10.3
	10,4	12	56	118	71	45	-10.4
	10,5	12	56	118	71	45	-10.5
	10,6	12	56	118	71	45	-10.6
	10,7	12	56	118	71	45	-10.7
	10,8	12	56	118	71	45	-10.8
	10,9	12	56	118	71	45	-10.9
	11	12	56	118	71	45	-11
	11,1	12	56	118	71	45	-11.1
	11,2	12	56	118	71	45	-11.2
	11,3	12	56	118	71	45	-11.3
	11,4	12	56	118	71	45	-11.4
	11,5	12	56	118	71	45	-11.5
	11,55	12	56	118	71	45	-11.55
	11,6	12	56	118	71	45	-11.6
	11,7	12	56	118	71	45	-11.7
	11,8	12	56	118	71	45	-11.8
	11,9	12	56	118	71	45	-11.9
	12	12	56	118	71	45	-12
	12,1	14	60	124	77	45	-12.1
	12,2	14	60	124	77	45	-12.2
	12,25	14	60	124	77	45	-12.25
	12,3	14	60	124	77	45	-12.3

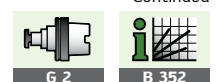
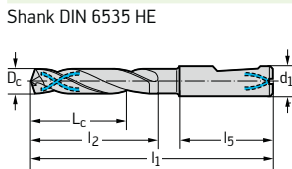

Solid carbide coolant through drills

A3999XPL

X-treme

 5 x D_c

Continued

	P	M	K	N	S	H	O
XPL	●●	●●	●●	●●	●●	●●	●●

DIN 6537 long	D _c m7 mm	d ₁ h6 mm	L _c mm	l ₁ mm	l ₂ mm	l ₅ mm	Designation A3999XPL
Shank DIN 6535 HE	12,4	14	60	124	77	45	-12.4
	12,5	14	60	124	77	45	-12.5
	12,6	14	60	124	77	45	-12.6
	12,7	14	60	124	77	45	-12.7
	12,75	14	60	124	77	45	-12.75
	12,8	14	60	124	77	45	-12.8
	12,9	14	60	124	77	45	-12.9
	13	14	60	124	77	45	-13
	13,1	14	60	124	77	45	-13.1
	13,2	14	60	124	77	45	-13.2
	13,3	14	60	124	77	45	-13.3
	13,4	14	60	124	77	45	-13.4
	13,5	14	60	124	77	45	-13.5
	13,6	14	60	124	77	45	-13.6
	13,7	14	60	124	77	45	-13.7
	13,8	14	60	124	77	45	-13.8
	13,9	14	60	124	77	45	-13.9
	14	14	60	124	77	45	-14
	14,1	16	63	133	83	48	-14.1
	14,2	16	63	133	83	48	-14.2
	14,3	16	63	133	83	48	-14.3
	14,4	16	63	133	83	48	-14.4
	14,5	16	63	133	83	48	-14.5
	14,6	16	63	133	83	48	-14.6
	14,7	16	63	133	83	48	-14.7
	14,75	16	63	133	83	48	-14.75
	14,8	16	63	133	83	48	-14.8
	14,9	16	63	133	83	48	-14.9
	15	16	63	133	83	48	-15
	15,1	16	63	133	83	48	-15.1
	15,2	16	63	133	83	48	-15.2
	15,3	16	63	133	83	48	-15.3
	15,4	16	63	133	83	48	-15.4
	15,5	16	63	133	83	48	-15.5
	15,6	16	63	133	83	48	-15.6
	15,7	16	63	133	83	48	-15.7
	15,8	16	63	133	83	48	-15.8
	15,9	16	63	133	83	48	-15.9
	16	16	63	133	83	48	-16
	16,1	18	71	143	93	48	-16.1
	16,2	18	71	143	93	48	-16.2
	16,3	18	71	143	93	48	-16.3
	16,4	18	71	143	93	48	-16.4
	16,5	18	71	143	93	48	-16.5
	16,6	18	71	143	93	48	-16.6
	16,7	18	71	143	93	48	-16.7
	16,75	18	71	143	93	48	-16.75
	16,8	18	71	143	93	48	-16.8
	16,9	18	71	143	93	48	-16.9
	17	18	71	143	93	48	-17
	17,1	18	71	143	93	48	-17.1
	17,2	18	71	143	93	48	-17.2
	17,3	18	71	143	93	48	-17.3
	17,4	18	71	143	93	48	-17.4
	17,5	18	71	143	93	48	-17.5

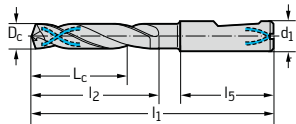

Solid carbide coolant through drills

A3999XPL

X-treme



5 x D_c

	P	M	K	N	S	H	O
XPL	●●	●●	●●	●●	●●	●●	●●

Continued

DIN 6537 long	D _c m7 mm	d ₁ h6 mm	L _c mm	l ₁ mm	l ₂ mm	l ₅ mm	Designation A3999XPL
Shank DIN 6535 HE	17,6	18	71	143	93	48	-17.6
	17,7	18	71	143	93	48	-17.7
	17,8	18	71	143	93	48	-17.8
	17,9	18	71	143	93	48	-17.9
	18	18	71	143	93	48	-18
	18,1	20	77	153	101	50	-18.1
	18,2	20	77	153	101	50	-18.2
	18,3	20	77	153	101	50	-18.3
	18,4	20	77	153	101	50	-18.4
	18,5	20	77	153	101	50	-18.5
	18,6	20	77	153	101	50	-18.6
	18,7	20	77	153	101	50	-18.7
	18,8	20	77	153	101	50	-18.8
	18,9	20	77	153	101	50	-18.9
	19	20	77	153	101	50	-19
	19,1	20	77	153	101	50	-19.1
	19,2	20	77	153	101	50	-19.2
	19,3	20	77	153	101	50	-19.3
	19,4	20	77	153	101	50	-19.4
	19,5	20	77	153	101	50	-19.5
	19,6	20	77	153	101	50	-19.6
	19,7	20	77	153	101	50	-19.7
	19,8	20	77	153	101	50	-19.8
	19,9	20	77	153	101	50	-19.9
	20	20	77	153	101	50	-20
	20,5	25	86	166	108	56	-20.5
	21	25	86	166	108	56	-21
	21,5	25	86	166	108	56	-21.5
	22	25	86	166	108	56	-22
	22,5	25	91	173	115	56	-22.5
	23	25	91	173	115	56	-23
	23,5	25	91	173	115	56	-23.5
	24	25	91	173	115	56	-24
	24,5	25	97	180	122	56	-24.5
	25	25	97	180	122	56	-25

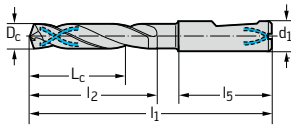

Short twist drill with taper shank A5971



3 x D_c

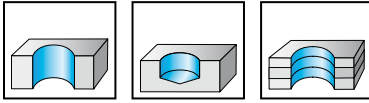

- K10/20 - uncoated
- Type HM
- right-hand cutting
- 118° point angle
- carbide-tipped, basic body HSS

Special features:
45 - 55 HRC

	P	M	K	N	S	H	O
uncoated	●	●	●	●	●	●	●

DIN 8041	D _c h8 mm	L _c mm	l ₁ mm	l ₂ mm	MK	Designation A5971
Morse taper	8	33	140	50	MK1 B	-8
	8,5	33	140	50	MK1 B	-8.5
	9	33	140	50	MK1 B	-9
	9,5	33	140	50	MK1 B	-9.5
	10	33	140	50	MK1 B	-10
	10,5	33	140	50	MK1 B	-10.5
	11	33	140	50	MK1 B	-11
	11,5	43	146	56	MK1 B	-11.5
	12	43	146	56	MK1 B	-12
	12,5	43	146	56	MK1 B	-12.5
	13	43	146	56	MK1 B	-13
	13,5	48	168	63	MK2 B	-13.5
	14	48	168	63	MK2 B	-14
	14,5	48	168	63	MK2 B	-14.5
	15	48	168	63	MK2 B	-15
	15,5	53	175	70	MK2 B	-15.5
	16	53	175	70	MK2 B	-16
	16,5	53	175	70	MK2 B	-16.5
	17	53	175	70	MK2 B	-17
	17,5	61	185	80	MK2 B	-17.5
	18	61	185	80	MK2 B	-18
	18,5	61	185	80	MK2 B	-18.5
	19	61	185	80	MK2 B	-19
	19,5	68	215	90	MK3 B	-19.5
	20	68	215	90	MK3 B	-20
	21	68	215	90	MK3 B	-21
	22	68	215	90	MK3 B	-22
	23	75	225	100	MK3 B	-23
	24	75	225	100	MK3 B	-24
	25	75	225	100	MK3 B	-25
	26	82	260	110	MK4 B	-26
	27	82	260	110	MK4 B	-27
	28	82	260	110	MK4 B	-28
	29	93	275	125	MK4 B	-29
	30	93	275	125	MK4 B	-30
	31	93	275	125	MK4 B	-31
	32	93	275	125	MK4 B	-32

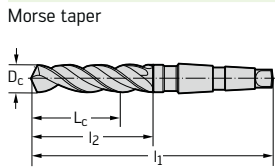



Solid carbide Micro-Pilot drill A6181AML X-treme Pilot 150

3 x D_c

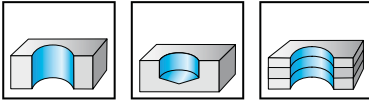

- K30F - AML
- Type X-treme Pilot 150
- right-hand cutting
- 150° point angle
- special diameter tolerance for X-treme DM... tools

	P	M	K	N	S	H	O
AML	●●	●●	●●	●●	●●	●●	●●

	D _c p7 mm	d ₁ h6 mm	L _c mm	l ₁ mm	l ₂ mm	l ₅ mm	Designation A6181AML
Shank DIN 6535 HA	2	3	6	57	10	42	-2
	2,1	3	6	57	11	42	-2.1
	2,2	3	6	57	11	42	-2.2
	2,3	3	7	59	12	43	-2.3
	2,4	3	7	59	12	43	-2.4
	2,5	3	8	59	13	42	-2.5
	2,6	3	7	62	13	45	-2.6
	2,7	3	8	62	14	45	-2.7
	2,8	3	8	62	14	45	-2.8
	2,9	3	9	62	15	44	-2.9

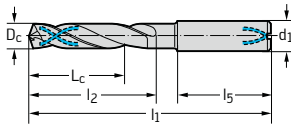

Solid carbide coolant through pilot drill

A6181TFT

XD Pilot



3 x D_c

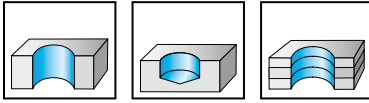

- K30F - TFT
- Type XD Pilot
- right-hand cutting
- 150° point angle
- special diameter tolerance for XD technology

Special features:
45 - 55 HRC

	P	M	K	N	S	H	O
TFT	●	●	●	●	●	●	●

	D _c p7 mm	D _c Inches/No	d ₁ h6 mm	L _c mm	l ₁ mm	l ₂ mm	l ₅ mm	Designation A6181TFT
Shank DIN 6535 HA 	3		6	12	66	20	36	-3
	3,175	1/8"	6	12	66	20	36	-1/8IN
	3,5		6	12	66	20	36	-3.5
	3,572	9/64"	6	12	66	20	36	-9/64IN
	3,969	5/32"	6	14	74	24	36	-5/32IN
	4		6	14	74	24	36	-4
	4,5		6	14	74	24	36	-4.5
	4,763	3/16"	6	16	82	28	36	-3/16IN
	4,8		6	16	82	28	36	-4.8
	5		6	16	82	28	36	-5
	5,5		6	16	82	28	36	-5.5
	5,556	7/32"	6	16	82	28	36	-7/32IN
	5,8		6	16	82	28	36	-5.8
	6		6	16	82	28	36	-6
	6,1		8	20	91	34	36	-6.1
	6,35	1/4"	8	20	91	34	36	-1/4IN
	6,5		8	20	91	34	36	-6.5
	6,8		8	20	91	34	36	-6.8
	7		8	20	91	34	36	-7
	7,144	9/32"	8	25	91	41	36	-9/32IN
	7,4		8	25	91	41	36	-7.4
	7,5		8	25	91	41	36	-7.5
	7,938	5/16"	8	25	91	41	36	-5/16IN
	8		8	25	91	41	36	-8
	8,3		10	27	103	47	40	-8.3
	8,5		10	27	103	47	40	-8.5
	8,731	11/32"	10	27	103	47	40	-11/32IN
	9		10	27	103	47	40	-9
	9,525	3/8"	10	27	103	47	40	-3/8IN
	9,8		10	27	103	47	40	-9.8
	10		10	27	103	47	40	-10
	10,2		12	31	118	55	45	-10.2
10,319	13/32"	12	31	118	55	45	-13/32IN	
11		12	31	118	55	45	-11	
11,113	7/16"	12	31	118	55	45	-7/16IN	
11,5		12	31	118	55	45	-11.5	
11,8		12	31	118	55	45	-11.8	
11,906	15/32"	12	31	118	55	45	-15/32IN	
12		12	31	118	55	45	-12	
12,7	1/2"	14	32	124	60	45	-1/2IN	
13		14	32	124	60	45	-13	
14		14	32	124	60	45	-14	
14,288	9/16"	16	33	133	65	48	-9/16IN	
15		16	33	133	65	48	-15	
16		16	33	133	65	48	-16	



Solid carbide micro twist drill A6478TML Alpha® 2 Plus Micro



8 x D_c

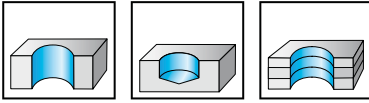

- K30F - TML
- Type Alpha® 2 Plus Micro
- right-hand cutting
- 140° point angle

	P	M	K	N	S	H	O
TML	●●	●	●●	●●	●●	●	●●

	D _c m7 mm	D _c Inches/No	d ₁ h6 mm	L _c mm	l ₁ mm	l ₂ mm	l ₅ mm	Designation A6478TML
Shank DIN 6535 HA 	0,5		3	4,2	55	5	40	-0.5
	0,6		3	5,1	55	6	39	-0.6
	0,7		3	5,9	55	7	38	-0.7
	0,75		3	6,3	55	7,5	38	-0.75
	0,794	1/32"	3	6,8	55	8	39	-1/32IN
	0,8		3	6,8	55	8	38	-0.8
	0,88		3	7,6	55	9	37	-0.88
	0,9		3	7,6	55	9	37	-0.9
	0,95		3	8	55	9,5	37	-0.95
	1		3	8,5	55	10	36	-1
	1,05		3	9	55	11	36	-1.05
	1,08		3	9	55	11	36	-1.08
	1,1		3	9	55	11	36	-1.1
	1,15		3	10	55	12	36	-1.15
	1,191	3/64"	3	10	55	12	35	-3/64IN
	1,2		3	10	55	12	35	-1.2
	1,25		3	10	55	12,5	35	-1.25
	1,3		3	11	55	13	34	-1.3
	1,35		3	11	55	13,5	34	-1.35
	1,4		3	11	55	14	33	-1.4
	1,45		3	12	55	14,5	33	-1.45
	1,5		3	12	68	15	46	-1.5
	1,55		3	13	68	16	46	-1.55
	1,588	1/16"	3	13	68	16	45	-1/16IN
	1,6		3	13	68	16	45	-1.6
	1,65		3	14	68	16,5	45	-1.65
	1,7		3	14	68	17	44	-1.7
	1,75		3	15	68	18	44	-1.75
1,8		3	15	68	18	44	-1.8	
1,82		3	15	68	18,5	43	-1.82	
1,85		3	15	68	18,5	44	-1.85	
1,9		3	16	68	19	43	-1.9	
1,95		3	17	68	20	43	-1.95	
1,984	5/64"	3	17	68	20	42	-5/64IN	
2		3	17	74	20	48	-2	
2,05		3	17	74	20,5	48	-2.05	
2,1		3	17	74	21	47	-2.1	
2,15		3	18	74	22	48	-2.15	
2,2		3	18	74	22	47	-2.2	
2,25		3	19	74	23	47	-2.25	
2,3		3	19	74	23	46	-2.3	
2,35		3	20	74	24	46	-2.35	
2,381	3/32"	3	20	74	24	45	-3/32IN	
2,4		3	20	74	24	45	-2.4	
2,45		3	21	74	25	45	-2.45	
2,5		3	21	81	25	52	-2.5	
2,55		3	22	81	26	52	-2.55	

Continued



Solid carbide micro twist drill

A6478TML

Alpha® 2 Plus Micro



8 x D_c

Continued

	P	M	K	N	S	H	O
TML	●●		●●	●●	●●	●	●●

	D _c m7 mm	D _c Inches/No	d ₁ h6 mm	L _c mm	l ₁ mm	l ₂ mm	l ₅ mm	Designation A6478TML
Shank DIN 6535 HA	2,6		3	22	81	26	51	-2.6
	2,65		3	22	81	27	51	-2.65
	2,7		3	22	81	27	50	-2.7
	2,75		3	23	81	28	50	-2.75
	2,778	7/64"	3	23	81	28	49	-7/64IN
	2,8		3	23	81	28	49	-2.8
	2,85		3	24	81	29	50	-2.85
	2,9		3	24	81	29	49	-2.9
	2,95		3	25	81	30	49	-2.95

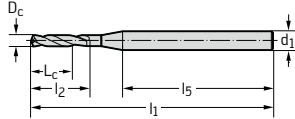

Solid carbide coolant through drill Micro A6488TML Alpha® 4 Plus Micro



8 x D_c

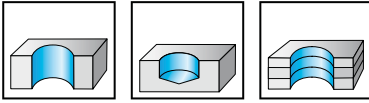

- K30F - TML
- Type Alpha® 4 Plus Micro
- right-hand cutting
- 140° point angle

	P	M	K	N	S	H	O
TML	●●	●●	●●	●●	●●	●	●●

	D _c m7 mm	D _c Inches/No	d ₁ h6 mm	L _c mm	l ₁ mm	l ₂ mm	l ₅ mm	Designation A6488TML
Shank DIN 6535 HA 	0,75		3	8,5	55	10	38	-0.75
	0,794	1/32"	3	8,5	55	10	39	-1/32IN
	0,8		3	8,5	55	10	38	-0.8
	0,88		3	8,5	55	10	37	-0.88
	0,9		3	8,5	55	10	37	-0.9
	0,95		3	8,5	55	10	37	-0.95
	1		3	12	55	15	36	-1
	1,05		3	12	55	15	36	-1.05
	1,08		3	12	55	15	36	-1.08
	1,1		3	12	55	15	36	-1.1
	1,15		3	12	55	15	36	-1.15
	1,191	3/64"	3	12	55	15	35	-3/64IN
	1,2		3	12	55	15	35	-1.2
	1,25		3	12	55	15	35	-1.25
	1,3		3	12	55	15	34	-1.3
	1,35		3	12	55	15	34	-1.35
	1,4		3	12	55	15	33	-1.4
	1,45		3	12	55	15	33	-1.45
	1,5		3	17	68	20	46	-1.5
	1,55		3	17	68	20	46	-1.55
	1,588	1/16"	3	17	68	20	45	-1/16IN
	1,6		3	17	68	20	45	-1.6
	1,65		3	17	68	20	45	-1.65
	1,7		3	17	68	20	44	-1.7
	1,75		3	17	68	20	44	-1.75
	1,8		3	17	68	20	44	-1.8
	1,82		3	17	68	20	43	-1.82
	1,85		3	17	68	20	44	-1.85
	1,9		3	17	68	20	43	-1.9
	1,95		3	17	68	20	43	-1.95
	1,984	5/64"	3	17	68	20	43	-5/64IN
	2		3	21	74	25	48	-2
	2,05		3	21	74	25	48	-2.05
	2,1		3	21	74	25	47	-2.1
2,15		3	21	74	25	48	-2.15	
2,2		3	21	74	25	47	-2.2	
2,25		3	21	74	25	47	-2.25	
2,3		3	21	74	25	46	-2.3	
2,35		3	21	74	25	46	-2.35	
2,381	3/32"	3	21	74	25	45	-3/32IN	
2,4		3	21	74	25	45	-2.4	
2,45		3	21	74	25	45	-2.45	
2,5		3	25	81	30	52	-2.5	
2,55		3	25	81	30	52	-2.55	
2,6		3	25	81	30	51	-2.6	
2,65		3	25	81	30	51	-2.65	
2,7		3	25	81	30	50	-2.7	

Continued



Solid carbide coolant through drill Micro A6488TML

Alpha® 4 Plus Micro



8 x D_c

Continued

	P	M	K	N	S	H	O
TML	●●	●●	●●	●●	●●	●	●●

	D _c m7 mm	D _c Inches/No	d ₁ h6 mm	L _c mm	l ₁ mm	l ₂ mm	l ₅ mm	Designation A6488TML
Shank DIN 6535 HA	2,75		3	25	81	30	50	-2.75
	2,778	7/64"	3	25	81	30	49	-7/64IN
	2,8		3	25	81	30	49	-2.8
	2,85		3	25	81	30	50	-2.85
	2,9		3	25	81	30	49	-2.9
	2,95		3	25	81	30	49	-2.95

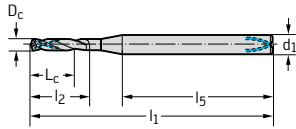

Solid carbide coolant through drills

A6489DPP

X-treme D8



8 x D_c

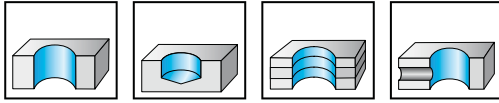

- K30F - DPP
- Type X-treme D8
- right-hand cutting
- 140° point angle

Special features:
45 - 55 HRC

	P	M	K	N	S	H	O
DPP	●	●	●	●	●	●	●

	D _c m7 mm	D _c Inches/No	d ₁ h6 mm	L _c mm	l ₁ mm	l ₂ mm	l ₅ mm	Designation A6489DPP	
Shank DIN 6535 HA 	3		6	28	74	34	36	-3	
	3,1		6	28	74	34	36	-3.1	
	3,175	1/8"	6	28	74	34	36	-1/8IN	
	3,2		6	28	74	34	36	-3.2	
	3,3		6	28	74	34	36	-3.3	
	3,4		6	28	74	34	36	-3.4	
	3,5		6	28	74	34	36	-3.5	
	3,572	9/64"	6	28	74	74	34	36	-9/64IN
	3,6		6	28	74	74	34	36	-3.6
	3,7		6	28	74	74	34	36	-3.7
	3,8		6	37	85	85	45	36	-3.8
	3,9		6	37	85	85	45	36	-3.9
	3,969	5/32"	6	37	85	85	45	36	-5/32IN
	4		6	37	85	85	45	36	-4
	4,1		6	37	85	85	45	36	-4.1
	4,2		6	37	85	85	45	36	-4.2
	4,3		6	37	85	85	45	36	-4.3
	4,366	11/64"	6	37	85	85	45	36	-11/64IN
	4,4		6	37	85	85	45	36	-4.4
	4,5		6	37	85	85	45	36	-4.5
	4,6		6	37	85	85	45	36	-4.6
	4,7		6	37	85	85	45	36	-4.7
	4,763	3/16"	6	48	97	97	57	36	-3/16IN
	4,8		6	48	97	97	57	36	-4.8
	4,9		6	48	97	97	57	36	-4.9
	5		6	48	97	97	57	36	-5
	5,1		6	48	97	97	57	36	-5.1
	5,159	13/64"	6	48	97	97	57	36	-13/64IN
	5,2		6	48	97	97	57	36	-5.2
	5,3		6	48	97	97	57	36	-5.3
5,4		6	48	97	97	57	36	-5.4	
5,5		6	48	97	97	57	36	-5.5	
5,556	7/32"	6	48	97	97	57	36	-7/32IN	
5,6		6	48	97	97	57	36	-5.6	
5,7		6	48	97	97	57	36	-5.7	
5,8		6	48	97	97	57	36	-5.8	
5,9		6	48	97	97	57	36	-5.9	
5,953	15/64"	6	48	97	97	57	36	-15/64IN	
6		6	48	97	97	57	36	-6	
6,1		8	55	106	106	66	36	-6.1	
6,2		8	55	106	106	66	36	-6.2	
6,3		8	55	106	106	66	36	-6.3	
6,35	1/4"	8	55	106	106	66	36	-1/4IN	
6,4		8	55	106	106	66	36	-6.4	
6,5		8	55	106	106	66	36	-6.5	
6,6		8	55	106	106	66	36	-6.6	
6,7		8	55	106	106	66	36	-6.7	

Continued



Solid carbide coolant through drills

A6489DPP

X-treme D8

 8 x D_c

Continued

	P	M	K	N	S	H	O
DPP	●●	●●	●●	●●	●●	●●	●

	D _c m7 mm	D _c Inches/No	d ₁ h6 mm	L _c mm	l ₁ mm	l ₂ mm	l ₅ mm	Designation A6489DPP
Shank DIN 6535 HA	6,747	17/64"	8	55	106	66	36	-17/64IN
	6,8		8	55	106	66	36	-6.8
	6,9		8	55	106	66	36	-6.9
	7		8	55	106	66	36	-7
	7,1		8	64	116	76	36	-7.1
	7,144	9/32"	8	64	116	76	36	-9/32IN
	7,2		8	64	116	76	36	-7.2
	7,3		8	64	116	76	36	-7.3
	7,4		8	64	116	76	36	-7.4
	7,5		8	64	116	76	36	-7.5
	7,541	19/64"	8	64	116	76	36	-19/64IN
	7,6		8	64	116	76	36	-7.6
	7,7		8	64	116	76	36	-7.7
	7,8		8	64	116	76	36	-7.8
	7,9		8	64	116	76	36	-7.9
	7,938	5/16"	8	64	116	76	36	-5/16IN
	8		8	64	116	76	36	-8
	8,1		10	80	139	95	40	-8.1
	8,2		10	80	139	95	40	-8.2
	8,3		10	80	139	95	40	-8.3
	8,334	21/64"	10	80	139	95	40	-21/64IN
	8,4		10	80	139	95	40	-8.4
	8,5		10	80	139	95	40	-8.5
	8,6		10	80	139	95	40	-8.6
	8,7		10	80	139	95	40	-8.7
	8,731	11/32"	10	80	139	95	40	-11/32IN
	8,8		10	80	139	95	40	-8.8
	8,9		10	80	139	95	40	-8.9
	9		10	80	139	95	40	-9
	9,1		10	80	139	95	40	-9.1
	9,128	23/64"	10	80	139	95	40	-23/64IN
	9,2		10	80	139	95	40	-9.2
	9,3		10	80	139	95	40	-9.3
	9,4		10	80	139	95	40	-9.4
	9,5		10	80	139	95	40	-9.5
	9,525	3/8"	10	80	139	95	40	-3/8IN
	9,6		10	80	139	95	40	-9.6
	9,7		10	80	139	95	40	-9.7
	9,8		10	80	139	95	40	-9.8
	9,9		10	80	139	95	40	-9.9
	9,922	25/64"	10	80	139	95	40	-25/64IN
	10		10	80	139	95	40	-10
	10,1		12	96	163	114	45	-10.1
	10,2		12	96	163	114	45	-10.2
	10,3		12	96	163	114	45	-10.3
	10,319	13/32"	12	96	163	114	45	-13/32IN
	10,4		12	96	163	114	45	-10.4
	10,5		12	96	163	114	45	-10.5
	10,6		12	96	163	114	45	-10.6
	10,7		12	96	163	114	45	-10.7
	10,716	27/64"	12	96	163	114	45	-27/64IN
	10,8		12	96	163	114	45	-10.8
	10,9		12	96	163	114	45	-10.9
	11		12	96	163	114	45	-11
	11,1		12	96	163	114	45	-11.1

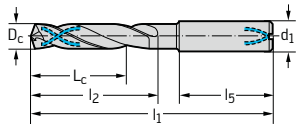

Continued



Solid carbide coolant through drills A6489DPP X-treme D8



8 x D_c

	P	M	K	N	S	H	O
DPP	●●	●●	●●	●●	●●	●●	●

Continued

	D _c m7 mm	D _c Inches/No	d ₁ h6 mm	L _c mm	l ₁ mm	l ₂ mm	l ₅ mm	Designation A6489DPP
Shank DIN 6535 HA	11,113	7/16"	12	96	163	114	45	-7/16IN
	11,2		12	96	163	114	45	-11.2
	11,3		12	96	163	114	45	-11.3
	11,4		12	96	163	114	45	-11.4
	11,5		12	96	163	114	45	-11.5
	11,509	29/64"	12	96	163	114	45	-29/64IN
	11,6		12	96	163	114	45	-11.6
	11,7		12	96	163	114	45	-11.7
	11,8		12	96	163	114	45	-11.8
	11,9		12	96	163	114	45	-11.9
	11,906	15/32"	12	96	163	114	45	-15/32IN
	12		12	96	163	114	45	-12
	12,303	31/64"	14	119	182	133	45	-31/64IN
	12,5		14	119	182	133	45	-12.5
	12,7	1/2"	14	119	182	133	45	-1/2IN
	13		14	119	182	133	45	-13
	13,494	17/32"	14	119	182	133	45	-17/32IN
	13,5		14	119	182	133	45	-13.5
	14		14	119	182	133	45	-14
	14,288	9/16"	16	136	204	152	48	-9/16IN
	14,5		16	136	204	152	48	-14.5
	15		16	136	204	152	48	-15
	15,5		16	136	204	152	48	-15.5
	15,875	5/8"	16	136	204	152	48	-5/8IN
	16		16	136	204	152	48	-16
	16,5		18	153	223	171	48	-16.5
	17		18	153	223	171	48	-17
	17,5		18	153	223	171	48	-17.5
	18		18	153	223	171	48	-18
	18,5		20	170	244	190	50	-18.5
	19		20	170	244	190	50	-19
	19,05	3/4"	20	170	244	190	50	-3/4IN
	19,5		20	170	244	190	50	-19.5
	20		20	170	244	190	50	-20

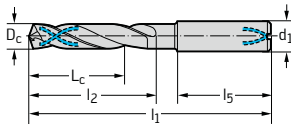

Solid carbide micro coolant through drill

A6588TML

Alpha® 4 Plus Micro

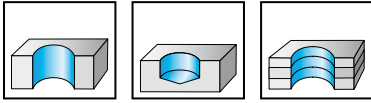
 12 x D_c

- K30F - TML
- Type Alpha® 4 Plus Micro
- right-hand cutting
- 140° point angle

	P	M	K	N	S	H	O
TML	●	●	●	●	●	●	●

	D _c m7 mm	D _c Inches/No	d ₁ h6 mm	L _c mm	l ₁ mm	l ₂ mm	l ₅ mm	Designation A6588TML
Shank DIN 6535 HA	1		3	18	55	21	25	-1
	1.1		3	18	55	21	26	-1.1
	1.191	3/64"	3	18	55	21	26	-3/64IN
	1.2		3	18	55	21	26	-1.2
	1.3		3	18	55	21	26	-1.3
	1.4		3	18	55	21	26	-1.4
	1.5		3	25	68	28	33	-1.5
	1.588	1/16"	3	25	68	28	33	-1/16IN
	1.6		3	25	68	28	33	-1.6
	1.7		3	25	68	28	33	-1.7
	1.8		3	25	68	28	34	-1.8
	1.9		3	25	68	28	34	-1.9
	2		3	31	74	35	33	-2
	2.1		3	31	74	35	33	-2.1
	2.2		3	31	74	35	34	-2.2
	2.3		3	31	74	35	34	-2.3
	2.381	3/32"	3	31	74	35	34	-3/32IN
	2.4		3	31	74	35	34	-2.4
	2.5		3	37	81	42	35	-2.5
	2.6		3	37	81	42	35	-2.6
	2.7		3	37	81	42	35	-2.7
	2.778	7/64"	3	37	81	42	35	-7/64IN
	2.8		3	37	81	42	35	-2.8
	2.9		3	37	81	42	36	-2.9

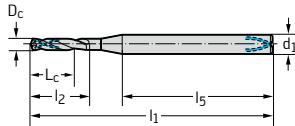

Solid carbide coolant through drills

A6589DPP

X-treme D12



12 x D_c

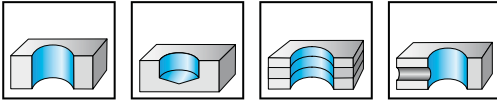

- K30F - DPP
- Type X-treme D12
- right-hand cutting
- 140° point angle

Special features:
45 - 55 HRC

	P	M	K	N	S	H	O
DPP	●●	●●	●●	●●	●●	●●	●

	D _c m7 mm	D _c Inches/No	d ₁ h6 mm	L _c mm	l ₁ mm	l ₂ mm	l ₅ mm	Designation A6589DPP
Shank DIN 6535 HA 	3		6	48	92	54	36	-3
	3,1		6	48	92	54	36	-3.1
	3,175	1/8"	6	48	92	54	36	-1/8IN
	3,2		6	48	92	54	36	-3.2
	3,3		6	48	92	54	36	-3.3
	3,4		6	48	92	54	36	-3.4
	3,5		6	48	92	54	36	-3.5
	3,572	9/64"	6	48	92	54	36	-9/64IN
	3,6		6	48	92	54	36	-3.6
	3,7		6	48	92	54	36	-3.7
	3,8		6	56	102	64	36	-3.8
	3,9		6	56	102	64	36	-3.9
	3,969	5/32"	6	56	102	64	36	-5/32IN
	4		6	56	102	64	36	-4
	4,1		6	56	102	64	36	-4.1
	4,2		6	56	102	64	36	-4.2
	4,3		6	56	102	64	36	-4.3
	4,366	11/64"	6	56	102	64	36	-11/64IN
	4,4		6	56	102	64	36	-4.4
	4,5		6	56	102	64	36	-4.5
	4,6		6	56	102	64	36	-4.6
	4,7		6	56	102	64	36	-4.7
	4,763	3/16"	6	74	121	83	36	-3/16IN
	4,8		6	74	121	83	36	-4.8
	4,9		6	74	121	83	36	-4.9
	5		6	74	121	83	36	-5
	5,1		6	74	121	83	36	-5.1
	5,159	13/64"	6	74	121	83	36	-13/64IN
5,2		6	74	121	83	36	-5.2	
5,3		6	74	121	83	36	-5.3	
5,4		6	74	121	83	36	-5.4	
5,5		6	74	121	83	36	-5.5	
5,55		6	74	121	83	36	-5.55	
5,556	7/32"	6	74	121	83	36	-7/32IN	
5,6		6	74	121	83	36	-5.6	
5,7		6	74	121	83	36	-5.7	
5,8		6	74	121	83	36	-5.8	
5,9		6	74	121	83	36	-5.9	
6		6	74	121	83	36	-6	
6,1		8	98	148	110	36	-6.1	
6,2		8	98	148	110	36	-6.2	
6,3		8	98	148	110	36	-6.3	
6,35	1/4"	8	98	148	110	36	-1/4IN	
6,4		8	98	148	110	36	-6.4	
6,5		8	98	148	110	36	-6.5	
6,6		8	98	148	110	36	-6.6	
6,7		8	98	148	110	36	-6.7	

Continued



Solid carbide coolant through drills

A6589DPP

X-treme D12

 12 x D_c

	P	M	K	N	S	H	O
DPP	●●	●●	●●	●●	●●	●●	●

Continued

	D _c m7 mm	D _c Inches/No	d ₁ h6 mm	L _c mm	l ₁ mm	l ₂ mm	l ₅ mm	Designation A6589DPP
Shank DIN 6535 HA	6,747	17/64"	8	98	148	110	36	-17/64IN
	6,8		8	98	148	110	36	-6.8
	6,9		8	98	148	110	36	-6.9
	7		8	98	148	110	36	-7
	7,1		8	98	148	110	36	-7.1
	7,144	9/32"	8	98	148	110	36	-9/32IN
	7,2		8	98	148	110	36	-7.2
	7,3		8	98	148	110	36	-7.3
	7,4		8	98	148	110	36	-7.4
	7,5		8	98	148	110	36	-7.5
	7,541	19/64"	8	98	148	110	36	-19/64IN
	7,8		8	98	148	110	36	-7.8
	7,9		8	98	148	110	36	-7.9
	7,938	5/16"	8	98	148	110	36	-5/16IN
	8		8	98	148	110	36	-8
	8,1		10	123	180	138	40	-8.1
	8,2		10	123	180	138	40	-8.2
	8,3		10	123	180	138	40	-8.3
	8,4		10	123	180	138	40	-8.4
	8,5		10	123	180	138	40	-8.5
	8,6		10	123	180	138	40	-8.6
	8,7		10	123	180	138	40	-8.7
	8,731	11/32"	10	123	180	138	40	-11/32IN
	8,8		10	123	180	138	40	-8.8
	9		10	123	180	138	40	-9
	9,128	23/64"	10	123	180	138	40	-23/64IN
	9,2		10	123	180	138	40	-9.2
	9,3		10	123	180	138	40	-9.3
	9,5		10	123	180	138	40	-9.5
	9,525	3/8"	10	123	180	138	40	-3/8IN
	9,6		10	123	180	138	40	-9.6
	9,7		10	123	180	138	40	-9.7
	9,8		10	123	180	138	40	-9.8
	9,922	25/64"	10	123	180	138	40	-25/64IN
	10		10	123	180	138	40	-10
	10,1		12	140	206	158	45	-10.1
	10,2		12	140	206	158	45	-10.2
	10,3		12	140	206	158	45	-10.3
	10,319	13/32"	12	140	206	158	45	-13/32IN
	10,4		12	140	206	158	45	-10.4
	10,5		12	140	206	158	45	-10.5
	10,716	27/64"	12	140	206	158	45	-27/64IN
	10,8		12	140	206	158	45	-10.8
	11		12	140	206	158	45	-11
	11,1		12	140	206	158	45	-11.1
	11,113	7/16"	12	140	206	158	45	-7/16IN
	11,2		12	140	206	158	45	-11.2
	11,5		12	140	206	158	45	-11.5
	11,509	29/64"	12	140	206	158	45	-29/64IN
	11,7		12	140	206	158	45	-11.7
	11,8		12	140	206	158	45	-11.8
	11,906	15/32"	12	140	206	158	45	-15/32IN
	12		12	140	206	158	45	-12
	12,1		14	168	230	182	45	-12.1
	12,2		14	168	230	182	45	-12.2

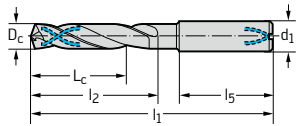

Continued



Solid carbide coolant through drills A6589DPP X-treme D12



12 x D_c

	P	M	K	N	S	H	O
DPP	●●	●●	●●	●●	●●	●●	●

Continued

	D _c m7 mm	D _c Inches/No	d ₁ h6 mm	L _c mm	l ₁ mm	l ₂ mm	l ₅ mm	Designation A6589DPP
Shank DIN 6535 HA	12,3		14	168	230	182	45	-12.3
	12,303	31/64"	14	168	230	182	45	-31/64IN
	12,5		14	168	230	182	45	-12.5
	12,6		14	168	230	182	45	-12.6
	12,7	1/2"	14	168	230	182	45	-1/2IN
	13		14	168	230	182	45	-13
	13,494	17/32"	14	168	230	182	45	-17/32IN
	13,5		14	168	230	182	45	-13.5
	14		14	168	230	182	45	-14
	14,288	9/16"	16	192	260	208	48	-9/16IN
	14,5		16	192	260	208	48	-14.5
	15		16	192	260	208	48	-15
	15,5		16	192	260	208	48	-15.5
	15,875	5/8"	16	192	260	208	48	-5/8IN
	16		16	192	260	208	48	-16
	16,5		18	216	285	234	48	-16.5
	17		18	216	285	234	48	-17
	17,5		18	216	285	234	48	-17.5
	18		18	216	285	234	48	-18
	18,5		20	238	310	258	50	-18.5
	19		20	238	310	258	50	-19
	19,5		20	238	310	258	50	-19.5
	20		20	238	310	258	50	-20

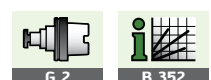
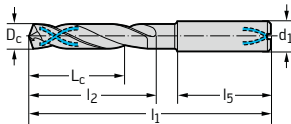

Solid carbide coolant through drills

A6685TFP

Alpha® 4 XD16



16 x D_c

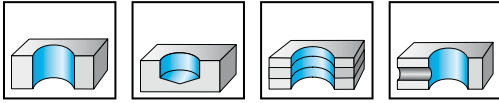

- K30F - TFP
- Type Alpha® 4 XD16
- right-hand cutting
- 140° point angle

Special features:
45 - 55 HRC

	P	M	K	N	S	H	O
TFP	●	●	●	●	●	●	●

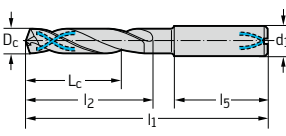
	D _c h7 mm	D _c Inches/No	d ₁ h6 mm	L _c mm	l ₁ mm	l ₂ mm	l ₅ mm	Designation A6685TFP
Shank DIN 6535 HA 	3		6	52	100	57	36	-3
	3,175	1/8"	6	72	120	78	36	-1/8IN
	3,5		6	72	120	78	36	-3.5
	3,572	9/64"	6	72	120	78	36	-9/64IN
	3,969	5/32"	6	72	120	78	36	-5/32IN
	4		6	72	120	78	36	-4
	4,5		6	92	140	100	36	-4.5
	4,763	3/16"	6	92	140	100	36	-3/16IN
	4,8		6	92	140	100	36	-4.8
	5		6	92	140	100	36	-5
	5,5		6	101	150	110	36	-5.5
	5,556	7/32"	6	111	160	120	36	-7/32IN
	5,8		6	111	160	120	36	-5.8
	6		6	111	160	120	36	-6
	6,1		8	124	175	135	36	-6.1
	6,35	1/4"	8	124	175	135	36	-1/4IN
6,5		8	124	175	135	36	-6.5	
6,8		8	124	175	135	36	-6.8	
7		8	124	175	135	36	-7	
7,144	9/32"	8	140	192	152	36	-9/32IN	
7,4		8	140	192	152	36	-7.4	
7,5		8	140	192	152	36	-7.5	
7,938	5/16"	8	140	192	152	36	-5/16IN	
8		8	140	192	152	36	-8	
8,3		10	148	206	162	40	-8.3	
8,5		10	148	206	162	40	-8.5	
8,731	11/32"	10	148	206	162	40	-11/32IN	
9		10	148	206	162	40	-9	
9,525	3/8"	10	165	224	180	40	-3/8IN	
9,8		10	165	224	180	40	-9.8	
10		10	165	224	180	40	-10	
10,2		12	181	247	198	45	-10.2	
10,319	13/32"	12	181	247	198	45	-13/32IN	
11		12	181	247	198	45	-11	
11,113	7/16"	12	198	265	216	45	-7/16IN	
11,5		12	198	265	216	45	-11.5	
11,8		12	198	265	216	45	-11.8	
11,906	15/32"	12	198	265	216	45	-15/32IN	
12		12	198	265	216	45	-12	
12,7	1/2"	14	238	301	252	45	-1/2IN	
13		14	238	301	252	45	-13	
14		14	238	301	252	45	-14	
14,288	9/16"	16	272	340	288	48	-9/16IN	
15		16	272	340	288	48	-15	
16		16	272	340	288	48	-16	

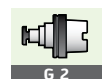

Solid carbide coolant through drills

A6785TFP

Alpha® 4 XD20



20 x D_c

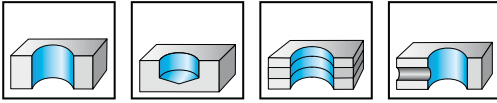

- K30F - TFP
- Type Alpha® 4 XD20
- right-hand cutting
- 140° point angle

Special features:
45 - 55 HRC

	P	M	K	N	S	H	O
TFP	●●	●●	●●	●●	●●	●	●●

	D _c h7 mm	D _c Inches/No	d ₁ h6 mm	L _c mm	l ₁ mm	l ₂ mm	l ₅ mm	Designation A6785TFP
Shank DIN 6535 HA 	3		6	60	107	65	36	-3
	3,175	1/8"	6	86	134	92	36	-1/8IN
	3,5		6	86	134	92	36	-3.5
	3,572	9/64"	6	86	134	92	36	-9/64IN
	3,969	5/32"	6	86	134	92	36	-5/32IN
	4		6	86	134	92	36	-4
	4,5		6	110	158	118	36	-4.5
	4,763	3/16"	6	110	158	118	36	-3/16IN
	4,8		6	110	158	118	36	-4.8
	5		6	110	158	118	36	-5
	5,5		6	123	170	132	36	-5.5
	5,556	7/32"	6	135	182	144	36	-7/32IN
	5,8		6	135	182	144	36	-5.8
	6		6	135	182	144	36	-6
	6,1		8	151	200	162	36	-6.1
	6,35	1/4"	8	151	200	162	36	-1/4IN
	6,5		8	151	200	162	36	-6.5
	6,8		8	151	200	162	36	-6.8
	7		8	151	200	162	36	-7
	7,144	9/32"	8	172	222	184	36	-9/32IN
	7,4		8	172	222	184	36	-7.4
	7,5		8	172	222	184	36	-7.5
	7,938	5/16"	8	172	222	184	36	-5/16IN
	8		8	172	222	184	36	-8
	8,3		10	184	240	198	40	-8.3
	8,5		10	184	240	198	40	-8.5
	8,731	11/32"	10	184	240	198	40	-11/32IN
	9		10	184	240	198	40	-9
9,525	3/8"	10	205	262	220	40	-3/8IN	
9,8		10	205	262	220	40	-9.8	
10		10	205	262	220	40	-10	
10,2		12	225	289	242	45	-10.2	
10,319	13/32"	12	225	289	242	45	-13/32IN	
11		12	225	289	242	45	-11	
11,113	7/16"	12	246	311	264	45	-7/16IN	
11,5		12	246	311	264	45	-11.5	
11,8		12	246	311	264	45	-11.8	
11,906	15/32"	12	246	311	264	45	-15/32IN	
12		12	246	311	264	45	-12	
12,7	1/2"	14	294	357	308	45	-1/2IN	
13		14	294	357	308	45	-13	
14		14	294	357	308	45	-14	
14,288	9/16"	16	336	404	352	48	-9/16IN	
15		16	336	404	352	48	-15	
16		16	336	404	352	48	-16	



G 2

B 352

Solid carbide coolant through drill Micro A6789AMP X-treme DM20



20 x D_c

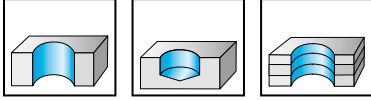

- K30F - AMP
- Type X-treme DM20
- right-hand cutting
- 140° point angle

	P	M	K	N	S	H	O
AMP	●	●	●	●	●	●	●

	D _c h7 mm	d ₁ h6 mm	L _c mm	l ₁ mm	l ₂ mm	l ₅ mm	Designation A6789AMP
Shank DIN 6535 HA	2	3	44	90	47	38	-2
	2,1	3	45	90	49	37	-2.1
	2,2	3	48	90	52	34	-2.2
	2,3	3	50	97	54	39	-2.3
	2,4	3	52	97	56	37	-2.4
	2,5	3	55	97	59	34	-2.5
	2,6	3	57	107	61	42	-2.6
	2,7	3	58	107	63	41	-2.7
	2,8	3	61	107	66	38	-2.8
	2,9	3	63	107	68	36	-2.9

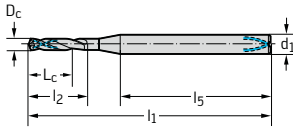

Solid carbide coolant through drills

A6794TFP

X-treme DH20



20 x D_c

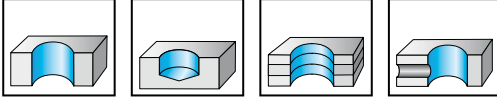

- K30F - TFP
- Type X-treme DH20
- right-hand cutting
- 140° point angle

Special features:
45 - 55 HRC

	P	M	K	N	S	H	O
TFP	●●	●●	●●	●	●●	●	

	D _c h7 mm	D _c Inches/No	d ₁ h6 mm	L _c mm	l ₁ mm	l ₂ mm	l ₅ mm	Designation A6794TFP
<p>Shank DIN 6535 HA</p>	3		6	60	107	65	36	-3
	3,175	1/8"	6	86	134	92	36	-1/8IN
	3,5		6	86	134	92	36	-3.5
	3,572	9/64"	6	86	134	92	36	-9/64IN
	3,969	5/32"	6	86	134	92	36	-5/32IN
	4		6	86	134	92	36	-4
	4,5		6	110	158	118	36	-4.5
	4,763	3/16"	6	110	158	118	36	-3/16IN
	4,8		6	110	158	118	36	-4.8
	5		6	110	158	118	36	-5
	5,5		6	123	170	132	36	-5.5
	5,556	7/32"	6	135	182	144	36	-7/32IN
	5,8		6	135	182	144	36	-5.8
	6		6	135	182	144	36	-6
	6,1		8	151	200	162	36	-6.1
	6,35	1/4"	8	151	200	162	36	-1/4IN
	6,5		8	151	200	162	36	-6.5
	6,8		8	151	200	162	36	-6.8
	7		8	151	200	162	36	-7
	7,144	9/32"	8	172	222	184	36	-9/32IN
7,4		8	172	222	184	36	-7.4	
7,5		8	172	222	184	36	-7.5	
7,938	5/16"	8	172	222	184	36	-5/16IN	
8		8	172	222	184	36	-8	
8,3		10	184	240	198	40	-8.3	
8,5		10	184	240	198	40	-8.5	
8,731	11/32"	10	184	240	198	40	-11/32IN	
9		10	184	240	198	40	-9	
9,525	3/8"	10	205	262	220	40	-3/8IN	
9,8		10	205	262	220	40	-9.8	
10		10	205	262	220	40	-10	



Solid carbide coolant through drills

A6885TFP

Alpha® 4 XD25



25 x D_c

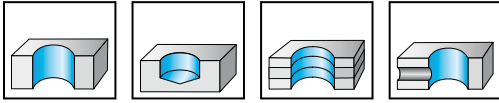

- K30F - TFP
- Type Alpha® 4 XD25
- right-hand cutting
- 140° point angle

Special features:
45 - 55 HRC

	P	M	K	N	S	H	O
TFP	●	●	●	●	●	●	●

	D _c h7 mm	D _c Inches/No	d ₁ h6 mm	L _c mm	l ₁ mm	l ₂ mm	l ₅ mm	Designation A6885TFP
Shank DIN 6535 HA	3		6	79	127	84	36	-3
	3,175	1/8"	6	108	156	114	36	-1/8IN
	3,5		6	108	156	114	36	-3.5
	3,572	9/64"	6	108	156	114	36	-9/64IN
	3,969	5/32"	6	108	156	114	36	-5/32IN
	4		6	108	156	114	36	-4
	4,5		6	137	185	145	36	-4.5
	4,763	3/16"	6	137	185	145	36	-3/16IN
	4,8		6	137	185	145	36	-4.8
	5		6	137	185	145	36	-5
	5,5		6	151	200	160	36	-5.5
	5,556	7/32"	6	165	214	174	36	-7/32IN
	5,8		6	165	214	174	36	-5.8
	6		6	165	214	174	36	-6
	6,1		8	183	234	194	36	-6.1
	6,35	1/4"	8	183	234	194	36	-1/4IN
	6,5		8	183	234	194	36	-6.5
	6,8		8	183	234	194	36	-6.8
	7		8	183	234	194	36	-7
	7,144	9/32"	8	208	260	220	36	-9/32IN
	7,4		8	208	260	220	36	-7.4
	7,5		8	208	260	220	36	-7.5
	7,938	5/16"	8	208	260	220	36	-5/16IN
	8		8	208	260	220	36	-8
	8,3		10	229	289	243	40	-8.3
	8,5		10	229	289	243	40	-8.5
	8,731	11/32"	10	229	289	243	40	-11/32IN
	9		10	229	289	243	40	-9
	9,525	3/8"	10	255	314	270	40	-3/8IN
	9,8		10	255	314	270	40	-9.8
	10		10	255	314	270	40	-10
	10,2		12	280	346	297	45	-10.2
	10,319	13/32"	12	280	346	297	45	-13/32IN
	11		12	280	346	297	45	-11
	11,113	7/16"	12	306	373	324	45	-7/16IN
	11,5		12	306	373	324	45	-11.5
	11,8		12	306	373	324	45	-11.8
	11,906	15/32"	12	306	373	324	45	-15/32IN
	12		12	306	373	324	45	-12

Shank DIN 6535 HA

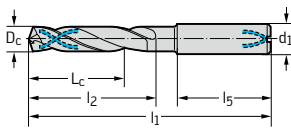

Solid carbide coolant through drill Micro A6889AMP X-treme DM25



25 x D_c

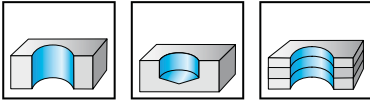

- K30F - AMP
- Type X-treme DM25
- right-hand cutting
- 140° point angle

	P	M	K	N	S	H	O
AMP	●●	●●	●●	●●	●●	●	●●

	D _c h7 mm	d ₁ h6 mm	L _c mm	l ₁ mm	l ₂ mm	l ₅ mm	Designation A6889AMP
Shank DIN 6535 HA	2.5	3	67	107	71	32	-2.5
	2.6	3	70	122	74	44	-2.6
	2.7	3	72	122	77	41	-2.7
	2.8	3	75	122	80	38	-2.8
	2.9	3	78	122	83	36	-2.9

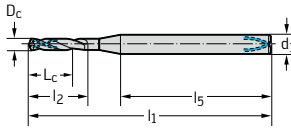

Solid carbide coolant through drills

A6985TFP

Alpha® 4 XD30



30 x D_c

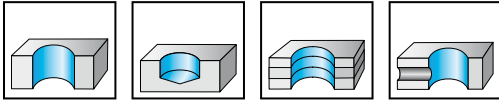

- K30F - TFP
- Type Alpha® 4 XD30
- right-hand cutting
- 140° point angle

Special features:
45 - 55 HRC

	P	M	K	N	S	H	O
TFP	●	●	●	●	●	●	●

	D _c h7 mm	D _c Inches/No	d ₁ h6 mm	L _c mm	l ₁ mm	l ₂ mm	l ₅ mm	Designation A6985TFP
Shank DIN 6535 HA 	3		6	92	140	97	36	-3
	3,175	1/8"	6	127	174	133	36	-1/8IN
	3,5		6	127	174	133	36	-3.5
	3,572	9/64"	6	127	174	133	36	-9/64IN
	3,969	5/32"	6	127	174	133	36	-5/32IN
	4		6	127	174	133	36	-4
	4,5		6	161	208	169	36	-4.5
	4,763	3/16"	6	161	208	169	36	-3/16IN
	4,8		6	161	208	169	36	-4.8
	5		6	161	208	169	36	-5
	5,5		6	178	225	187	36	-5.5
	5,556	7/32"	6	195	242	204	36	-7/32IN
	5,8		6	195	242	204	36	-5.8
	6		6	195	242	204	36	-6
	6,1		8	217	268	228	36	-6.1
	6,35	1/4"	8	217	268	228	36	-1/4IN
	6,5		8	217	268	228	36	-6.5
	6,8		8	217	268	228	36	-6.8
	7		8	217	268	228	36	-7
	7,144	9/32"	8	244	294	256	36	-9/32IN
	7,4		8	244	294	256	36	-7.4
	7,5		8	244	294	256	36	-7.5
	7,938	5/16"	8	244	294	256	36	-5/16IN
	8		8	244	294	256	36	-8
	8,3		10	273	330	287	40	-8.3
	8,5		10	273	330	287	40	-8.5
	8,731	11/32"	10	273	330	287	40	-11/32IN
	9		10	273	330	287	40	-9
9,525	3/8"	10	305	364	320	40	-3/8IN	
9,8		10	305	364	320	40	-9.8	
10		10	305	364	320	40	-10	
10,2		12	335	401	352	45	-10.2	
10,319	13/32"	12	335	401	352	45	-13/32IN	
11		12	335	401	352	45	-11	
11,113	7/16"	12	364	430	382	45	-7/16IN	
11,5		12	364	430	382	45	-11.5	
11,8		12	364	430	382	45	-11.8	
11,906	15/32"	12	364	430	382	45	-15/32IN	
12		12	364	430	382	45	-12	



Solid carbide coolant through drills

A6994TFP

X-treme DH30



30 x D_c

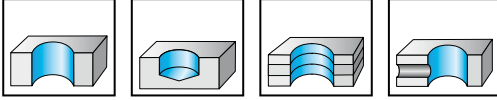

- K30F - TFP
- Type X-treme DH30
- right-hand cutting
- 140° point angle

Special features:
45 - 55 HRC

	P	M	K	N	S	H	O
TFP	●●	●●	●●	●	●●	●	

	D _c h7 mm	D _c Inches/No	d ₁ h6 mm	L _c mm	l ₁ mm	l ₂ mm	l ₅ mm	Designation A6994TFP
Shank DIN 6535 HA	3		6	92	140	97	36	-3
	3,175	1/8"	6	127	174	133	36	-1/8IN
	3,5		6	127	174	133	36	-3.5
	3,572	9/64"	6	127	174	133	36	-9/64IN
	3,969	5/32"	6	127	174	133	36	-5/32IN
	4		6	127	174	133	36	-4
	4,5		6	161	208	169	36	-4.5
	4,763	3/16"	6	161	208	169	36	-3/16IN
	4,8		6	161	208	169	36	-4.8
	5		6	161	208	169	36	-5
	5,5		6	178	225	187	36	-5.5
	5,556	7/32"	6	195	242	204	36	-7/32IN
	5,8		6	195	242	204	36	-5.8
	6		6	195	242	204	36	-6
	6,1		8	217	268	228	36	-6.1
	6,35	1/4"	8	217	268	228	36	-1/4IN
	6,5		8	217	268	228	36	-6.5
	6,8		8	217	268	228	36	-6.8
	7		8	217	268	228	36	-7
	7,144	9/32"	8	244	294	256	36	-9/32IN
	7,4		8	244	294	256	36	-7.4
	7,5		8	244	294	256	36	-7.5
	7,938	5/16"	8	244	294	256	36	-5/16IN
	8		8	244	294	256	36	-8
	8,3		10	273	330	287	40	-8.3
	8,5		10	273	330	287	40	-8.5
	8,731	11/32"	10	273	330	287	40	-11/32IN
	9		10	273	330	287	40	-9
	9,525	3/8"	10	305	364	320	40	-3/8IN
	9,8		10	305	364	320	40	-9.8
	10		10	305	364	320	40	-10

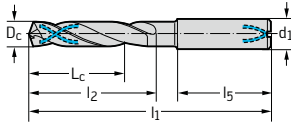

Solid carbide coolant through pilot drill

A7191TFT

X-treme Pilot 180



3 x D_c

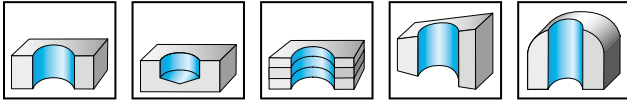

- K30F - TFT
- Type X-treme Pilot 180
- right-hand cutting
- 180° point angle

Special features:
45 - 55 HRC

	P	M	K	N	S	H	O
TFT	●	●	●	●	●	●	●

	D _c p7 mm	D _c Inches/No	d ₁ h6 mm	L _c mm	l ₁ mm	l ₂ mm	l ₅ mm	Designation A7191TFT
Shank DIN 6535 HA	3		6	5	62	12	42	-3
	3,175	1/8"	6	5	62	12	42	-1/8IN
	3,5		6	5	62	13	42	-3.5
	3,572	9/64"	6	5	62	13	42	-9/64IN
	3,969	5/32"	6	6	66	14	42	-5/32IN
	4		6	6	66	14	42	-4
	4,5		6	7	66	16	42	-4.5
	4,763	3/16"	6	8	66	18	42	-3/16IN
	4,8		6	8	66	18	42	-4.8
	5		6	8	66	18	42	-5
	5,5		6	9	66	20	42	-5.5
	5,556	7/32"	6	9	66	21	42	-7/32IN
	5,8		6	9	66	21	42	-5.8
	6		6	9	66	21	42	-6
	6,1		8	10	79	23	47	-6.1
	6,35	1/4"	8	10	79	23	47	-1/4IN
	6,5		8	10	79	23	47	-6.5
	6,8		8	11	79	25	47	-6.8
	7		8	11	79	25	47	-7
	7,144	9/32"	8	12	79	28	47	-9/32IN
	7,4		8	12	79	28	47	-7.4
	7,5		8	12	79	28	47	-7.5
	7,938	5/16"	8	12	79	28	47	-5/16IN
	8		8	12	79	28	47	-8
	8,3		10	14	89	32	50	-8.3
	8,5		10	14	89	32	50	-8.5
	8,731	11/32"	10	14	89	32	50	-11/32IN
	9		10	14	89	32	50	-9
	9,525	3/8"	10	15	89	35	50	-3/8IN
	9,8		10	15	89	35	50	-9.8
	10		10	15	89	35	50	-10

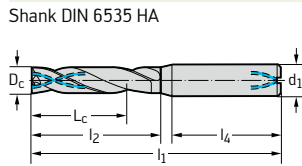

Solid carbide chamfering drill K3164TIN Alpha® 2



3 x D_c

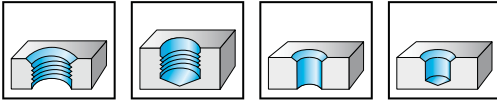

- K30F - TiN
- right-hand cutting
- 140° point angle
- 90° countersink angle
- step length in accordance with DIN 8378

	P	M	K	N	S	H	O
TiN	●●	●●	●●	●●	●●	●	●●

	for thread	D _c m8 mm	d ₁ h6 mm	d ₁₀ h8 mm	L _c mm	l ₁ mm	l ₂ mm	l ₅ mm	Designation K3164TIN
Shank DIN 6535 HE 	M 4	3,3	6	4,5	11,4	66	28	36	-M4
	M 5	4,2	6	6	13,6	66	28	36	-M5
	M 6	5	8	7	16,5	79	41	36	-M6
	M 8	6,8	10	9,5	21	89	47	40	-M8
	M 8 x 1	7	10	9,8	21	89	47	40	-M8X1
	M 10	8,5	12	12	25,5	102	55	45	-M10
	M 10 x 1	9	12	12	25,5	102	55	45	-M10X1
	M 12	10,2	14	14	30	107	60	45	-M12
	M 12 x 1,5	10,5	14	14	30	107	60	45	-M12X1.5
	M 14	12	16	16	34,5	115	65	48	-M14
	M 14 x 1,5	12,5	16	16	34,5	115	65	48	-M14X1.5
	M 16	14	18	18	38,5	123	73	48	-M16
	M 16 x 1,5	14,5	18	18	38,5	123	73	48	-M16X1.5

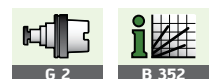

Solid carbide coolant through pilot drill
K5191TFT
X-treme Pilot 180C



3 x D_c

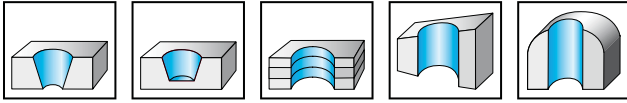

- K30F - TFT
- Type X-treme Pilot 180C
- right-hand cutting
- 180° point angle
- for angled and round surfaces (e.g. crankshafts)
- conical contour 1:30 for step-free piloting

Special features:
45 - 55 HRC

	P	M	K	N	S	H	O
TFT	●	●	●	●	●	●	●

	D _c h10 mm	d ₁ h6 mm	d ₃ mm	L _c mm	l ₁ mm	l ₂ mm	l ₅ mm	l ₁₅ mm	Designation K5191TFT
Shank DIN 6535 HA	4	6	3,9	10	59	16	36	3	-4
	5	6	4,9	11	63	19	36	3	-5
	6	8	5,85	13	68	22	36	4,5	-6
	7	8	6,85	15	73	26	36	4,5	-7

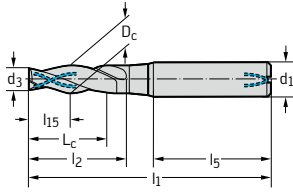



Stub length drill A1111

~ 3 x D_c

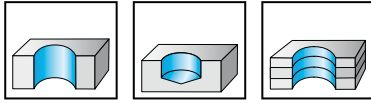

- HSS - steam treated
- Type N
- right-hand cutting
- 118° point angle
- up to 3 mm bright finish

	P	M	K	N	S	H	O
uncoated	●●	●	●●	●●	●		●●

DIN 1897	D _c h8 mm	d ₁ f11 mm	L _c mm	l ₁ mm	l ₂ mm	Designation A1111
Cylindrical shank	0,5	0,5	2,2	20	3	-0,5
	0,55	0,55	2,6	21	3,5	-0,55
	0,6	0,6	2,6	21	3,5	-0,6
	0,65	0,65	2,9	22	4	-0,65
	0,7	0,7	3,3	23	4,5	-0,7
	0,75	0,75	3,3	23	4,5	-0,75
	0,8	0,8	3,7	24	5	-0,8
	0,85	0,85	3,7	24	5	-0,85
	0,9	0,9	4	25	5,5	-0,9
	0,95	0,95	4	25	5,5	-0,95
	1	1	4	26	6	-1
	1,05	1,05	4	26	6	-1,05
	1,1	1,1	5	28	7	-1,1
	1,15	1,15	5	28	7	-1,15
	1,2	1,2	6	30	8	-1,2
	1,25	1,25	6	30	8	-1,25
	1,3	1,3	6	30	8	-1,3
	1,35	1,35	6	32	9	-1,35
	1,4	1,4	6	32	9	-1,4
	1,45	1,45	6	32	9	-1,45
	1,5	1,5	6	32	9	-1,5
	1,55	1,55	7	34	10	-1,55
	1,6	1,6	7	34	10	-1,6
	1,65	1,65	7	34	10	-1,65
	1,7	1,7	7	34	10	-1,7
	1,75	1,75	8	36	11	-1,75
	1,8	1,8	8	36	11	-1,8
	1,85	1,85	8	36	11	-1,85
	1,9	1,9	8	36	11	-1,9
	1,95	1,95	8	38	12	-1,95
	2	2	8	38	12	-2
	2,05	2,05	8	38	12	-2,05
	2,1	2,1	8	38	12	-2,1
	2,15	2,15	9	40	13	-2,15
	2,2	2,2	9	40	13	-2,2
	2,25	2,25	9	40	13	-2,25
	2,3	2,3	9	40	13	-2,3
	2,35	2,35	9	40	13	-2,35
	2,4	2,4	10	43	14	-2,4
	2,45	2,45	10	43	14	-2,45
	2,5	2,5	10	43	14	-2,5
	2,55	2,55	10	43	14	-2,55
	2,6	2,6	10	43	14	-2,6
	2,65	2,65	10	43	14	-2,65
	2,7	2,7	11	46	16	-2,7
	2,75	2,75	11	46	16	-2,75
	2,8	2,8	11	46	16	-2,8

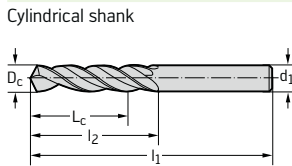

Continued

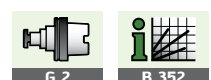

Stub length drill A1111



~ 3 x D_c

Continued

	P	M	K	N	S	H	O
uncoated	●●	●	●●	●●	●		●●

DIN 1897	D _c h8 mm	d ₁ f11 mm	L _c mm	l ₁ mm	l ₂ mm	Designation A1111
Cylindrical shank	2,85	2,85	11	46	16	-2,85
	2,9	2,9	11	46	16	-2,9
	2,95	2,95	11	46	16	-2,95
	3	3	11	46	16	-3
	3,1	3,1	12	49	18	-3,1
	3,2	3,2	12	49	18	-3,2
	3,25	3,25	12	49	18	-3,25
	3,3	3,3	12	49	18	-3,3
	3,4	3,4	14	52	20	-3,4
	3,5	3,5	14	52	20	-3,5
	3,6	3,6	14	52	20	-3,6
	3,7	3,7	14	52	20	-3,7
	3,75	3,75	14	52	20	-3,75
	3,8	3,8	15	55	22	-3,8
	3,9	3,9	15	55	22	-3,9
	4	4	15	55	22	-4
	4,1	4,1	15	55	22	-4,1
	4,2	4,2	15	55	22	-4,2
	4,25	4,25	15	55	22	-4,25
	4,3	4,3	16	58	24	-4,3
	4,4	4,4	16	58	24	-4,4
	4,5	4,5	16	58	24	-4,5
	4,6	4,6	16	58	24	-4,6
	4,7	4,7	16	58	24	-4,7
	4,75	4,75	16	58	24	-4,75
	4,8	4,8	18	62	26	-4,8
	4,9	4,9	18	62	26	-4,9
	5	5	18	62	26	-5
	5,1	5,1	18	62	26	-5,1
	5,2	5,2	18	62	26	-5,2
	5,25	5,25	18	62	26	-5,25
	5,3	5,3	18	62	26	-5,3
	5,4	5,4	19	66	28	-5,4
	5,5	5,5	19	66	28	-5,5
	5,6	5,6	19	66	28	-5,6
	5,7	5,7	19	66	28	-5,7
	5,75	5,75	19	66	28	-5,75
	5,8	5,8	19	66	28	-5,8
	5,9	5,9	19	66	28	-5,9
	6	6	19	66	28	-6
	6,1	6,1	20	70	31	-6,1
	6,2	6,2	20	70	31	-6,2
	6,25	6,25	20	70	31	-6,25
	6,3	6,3	20	70	31	-6,3
	6,4	6,4	20	70	31	-6,4
	6,5	6,5	20	70	31	-6,5
	6,6	6,6	20	70	31	-6,6
	6,7	6,7	20	70	31	-6,7
	6,75	6,75	22	74	34	-6,75
	6,8	6,8	22	74	34	-6,8
	6,9	6,9	22	74	34	-6,9
	7	7	22	74	34	-7
	7,1	7,1	22	74	34	-7,1
	7,2	7,2	22	74	34	-7,2
	7,25	7,25	22	74	34	-7,25

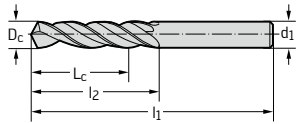

Continued



Stub length drill A1111



~ 3 x D_c

Continued

	P	M	K	N	S	H	O
uncoated	●●	●	●●	●●	●		●●

DIN 1897	D _c h8 mm	d ₁ f11 mm	L _c mm	l ₁ mm	l ₂ mm	Designation A1111
Cylindrical shank 	7,3	7,3	22	74	34	-7.3
	7,4	7,4	22	74	34	-7.4
	7,5	7,5	22	74	34	-7.5
	7,6	7,6	24	79	37	-7.6
	7,7	7,7	24	79	37	-7.7
	7,75	7,75	24	79	37	-7.75
	7,8	7,8	24	79	37	-7.8
	7,9	7,9	24	79	37	-7.9
	8	8	24	79	37	-8
	8,1	8,1	24	79	37	-8.1
	8,2	8,2	24	79	37	-8.2
	8,25	8,25	24	79	37	-8.25
	8,3	8,3	24	79	37	-8.3
	8,4	8,4	24	79	37	-8.4
	8,5	8,5	24	79	37	-8.5
	8,6	8,6	25	84	40	-8.6
	8,7	8,7	25	84	40	-8.7
	8,75	8,75	25	84	40	-8.75
	8,8	8,8	25	84	40	-8.8
	8,9	8,9	25	84	40	-8.9
	9	9	25	84	40	-9
	9,1	9,1	25	84	40	-9.1
	9,2	9,2	25	84	40	-9.2
	9,25	9,25	25	84	40	-9.25
	9,3	9,3	25	84	40	-9.3
	9,4	9,4	25	84	40	-9.4
	9,5	9,5	25	84	40	-9.5
	9,6	9,6	27	89	43	-9.6
9,7	9,7	27	89	43	-9.7	
9,75	9,75	27	89	43	-9.75	
9,8	9,8	27	89	43	-9.8	
9,9	9,9	27	89	43	-9.9	
10	10	27	89	43	-10	
10,1	10,1	27	89	43	-10.1	
10,2	10,2	27	89	43	-10.2	
10,25	10,25	27	89	43	-10.25	
10,3	10,3	27	89	43	-10.3	
10,4	10,4	27	89	43	-10.4	
10,5	10,5	27	89	43	-10.5	
10,6	10,6	27	89	43	-10.6	
10,7	10,7	29	95	47	-10.7	
10,75	10,75	29	95	47	-10.75	
10,8	10,8	29	95	47	-10.8	
10,9	10,9	29	95	47	-10.9	
11	11	29	95	47	-11	
11,1	11,1	29	95	47	-11.1	
11,2	11,2	29	95	47	-11.2	
11,25	11,25	29	95	47	-11.25	
11,3	11,3	29	95	47	-11.3	
11,4	11,4	29	95	47	-11.4	
11,5	11,5	29	95	47	-11.5	
11,6	11,6	29	95	47	-11.6	
11,7	11,7	29	95	47	-11.7	
11,75	11,75	29	95	47	-11.75	
11,8	11,8	29	95	47	-11.8	

Continued



Stub length drill A1111



~ 3 x D_c

Continued

	P	M	K	N	S	H	O
uncoated	●●	●	●●	●●	●		●●

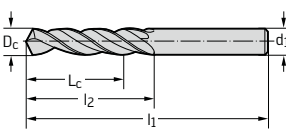
DIN 1897	D _c h8 mm	d ₁ f11 mm	L _c mm	l ₁ mm	l ₂ mm	Designation A1111
Cylindrical shank 	11,9	11,9	37	102	51	-11.9
	12	12	37	102	51	-12
	12,1	12,1	37	102	51	-12.1
	12,2	12,2	37	102	51	-12.2
	12,25	12,25	37	102	51	-12.25
	12,3	12,3	37	102	51	-12.3
	12,4	12,4	37	102	51	-12.4
	12,5	12,5	37	102	51	-12.5
	12,6	12,6	37	102	51	-12.6
	12,7	12,7	37	102	51	-12.7
	12,75	12,75	37	102	51	-12.75
	12,8	12,8	37	102	51	-12.8
	12,9	12,9	37	102	51	-12.9
	13	13	37	102	51	-13
	13,1	13,1	37	102	51	-13.1
	13,2	13,2	37	102	51	-13.2
	13,25	13,25	40	107	54	-13.25
	13,3	13,3	40	107	54	-13.3
	13,4	13,4	40	107	54	-13.4
	13,5	13,5	40	107	54	-13.5
	13,6	13,6	40	107	54	-13.6
	13,7	13,7	40	107	54	-13.7
	13,75	13,75	40	107	54	-13.75
	13,8	13,8	40	107	54	-13.8
	13,9	13,9	40	107	54	-13.9
	14	14	40	107	54	-14
	14,1	14,1	41	111	56	-14.1
	14,2	14,2	41	111	56	-14.2
	14,25	14,25	41	111	56	-14.25
	14,3	14,3	41	111	56	-14.3
	14,4	14,4	41	111	56	-14.4
	14,5	14,5	41	111	56	-14.5
	14,6	14,6	41	111	56	-14.6
	14,7	14,7	41	111	56	-14.7
14,75	14,75	41	111	56	-14.75	
14,8	14,8	41	111	56	-14.8	
14,9	14,9	41	111	56	-14.9	
15	15	41	111	56	-15	
15,5	15,5	42	115	58	-15.5	
16	16	42	115	58	-16	
16,5	16,5	43	119	60	-16.5	
17	17	43	119	60	-17	
17,5	17,5	44	123	62	-17.5	
18	18	44	123	62	-18	
18,5	18,5	45	127	64	-18.5	
19	19	45	127	64	-19	
19,5	19,5	46	131	66	-19.5	
20	20	46	131	66	-20	
20,5	20,5	46	136	68	-20.5	
21	21	46	136	68	-21	
21,5	21,5	47	141	70	-21.5	
22	22	47	141	70	-22	
22,5	22,5	48	146	72	-22.5	
23	23	48	146	72	-23	
23,5	23,5	48	146	72	-23.5	

Continued





Stub length drill A1111

~ 3 x D_c

Continued

	P	M	K	N	S	H	O
uncoated	●●	●	●●	●●	●		●●

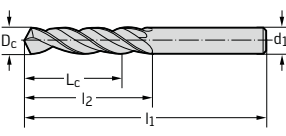
DIN 1897	D _c h8 mm	d ₁ f11 mm	L _c mm	l ₁ mm	l ₂ mm	Designation A1111
Cylindrical shank	24	24	50	151	75	-24
	24,5	24,5	50	151	75	-24.5
	25	25	50	151	75	-25
	25,5	25,5	51	156	78	-25.5
	26	26	51	156	78	-26
	26,5	26,5	51	156	78	-26.5
	27	27	53	162	81	-27
	27,5	27,5	53	162	81	-27.5
	28	28	53	162	81	-28
	28,5	28,5	54	168	84	-28.5
	29	29	54	168	84	-29
	29,5	29,5	54	168	84	-29.5
	30	30	54	168	84	-30
	31	31	55	174	87	-31
	32	32	56	180	90	-32

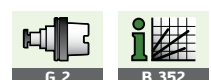

**NC spot drill, 120°
A1114
120°**

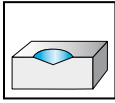

- HSS - uncoated
- Type NC
- right-hand cutting
- 120° point angle

	P	M	K	N	S	H	O
uncoated	●●	●	●●	●●	●		●●

	D _c h8 mm	d ₁ f11 mm	l ₁ mm	l ₂ mm	Designation A1114
Cylindrical shank	4	4	55	18	-4
	5	5	62	21	-5
	6	6	66	22	-6
	8	8	79	30	-8
	10	10	89	34	-10
	12	12	102	41	-12
	16	16	115	46	-16
	20	20	131	53	-20

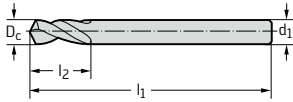

NC spot drill, 120° A1114L 120°

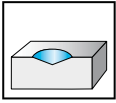

- HSS - uncoated
- Type NC
- right-hand cutting
- 120° point angle

	P	M	K	N	S	H	O
uncoated	●●	●	●●	●●	●		●●

	D _c h8 mm	D _c Inches/No	d ₁ h6 mm	l ₁ mm	l ₂ mm	Designation A1114L
Cylindrical shank	4		4	100	12	-4
	5		5	120	15	-5
	6		6	140	20	-6
	6,35	1/4"	6,35	140	20	-1/4IN
	8		8	140	25	-8
	9,525	3/8"	9,525	170	25	-3/8IN
	10		10	170	25	-10
	12		12	170	30	-12
	12,7	1/2"	12,7	170	30	-1/2IN

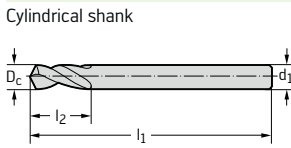

NC spot drill, 120° A1114S 120°

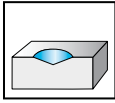

- HSS - uncoated
- Type NC
- right-hand cutting
- 120° point angle

	P	M	K	N	S	H	O
uncoated	●●	●	●●	●●	●		●●

	D _c h8 mm	D _c Inches/No	d ₁ h6 mm	l ₁ mm	l ₂ mm	Designation A1114S
Cylindrical shank	2		2	40	8	-2
	3		3	50	10	-3
	4		4	52	12	-4
	5		5	60	15	-5
	6		6	66	20	-6
	6,35	1/4"	6,35	66	20	-1/4IN
	8		8	79	25	-8
	9,525	3/8"	9,525	89	25	-3/8IN
	10		10	89	25	-10
	12		12	102	30	-12
	12,7	1/2"	12,7	102	35	-1/2IN
	14		14	115	35	-14
	15,875	5/8"	15,875	115	35	-5/8IN
	19,05	3/4"	19,05	131	40	-3/4IN
	25,4	1"	25,4	138	45	-1IN

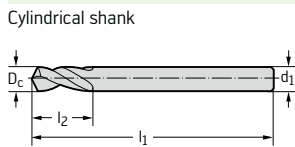

**NC spot drill, 90°
A1115
90°**

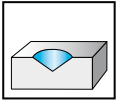

- HSS - uncoated
- Type NC
- right-hand cutting
- 90° point angle

	P	M	K	N	S	H	O
uncoated	●●	●	●●	●●	●		●●

	D _c h8 mm	d ₁ f11 mm	l ₁ mm	l ₂ mm	Designation A1115
Cylindrical shank	4	4	55	18	-4
	5	5	62	21	-5
	6	6	66	22	-6
	8	8	79	30	-8
	10	10	89	34	-10
	12	12	102	41	-12
	16	16	115	46	-16
	20	20	131	53	-20

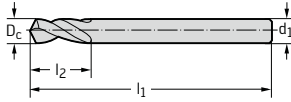

NC spot drill, 90° A1115L 90°

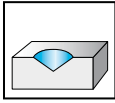

- HSS - uncoated
- Type NC
- right-hand cutting
- 90° point angle

	P	M	K	N	S	H	O
uncoated	●●	●	●●	●●	●		●●

	D _c h8 mm	D _c Inches/No	d ₁ h6 mm	l ₁ mm	l ₂ mm	Designation A1115L
Cylindrical shank	4		4	100	12	-4
	5		5	120	15	-5
	6		6	140	20	-6
	6,35	1/4"	6,35	140	20	-1/4IN
	8		8	140	25	-8
	9,525	3/8"	9,525	170	25	-3/8IN
	10		10	170	25	-10
	12		12	170	30	-12
	12,7	1/2"	12,7	170	30	-1/2IN
	15,875	5/8"	15,875	200	35	-5/8IN
	19,05	3/4"	19,05	200	40	-3/4IN
	20		20	200	40	-20
	25,4	1"	25,4	200	40	-1IN

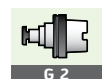
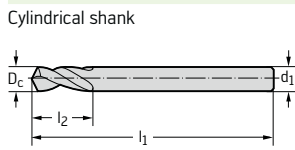



**NC spot drill, 90°
A1115S
90°**

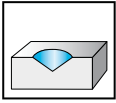

- HSS - uncoated
- Type NC
- right-hand cutting
- 90° point angle

	P	M	K	N	S	H	O
uncoated	●●	●	●●	●●	●		●●

	D _c h8 mm	D _c Inches/No	d ₁ h6 mm	l ₁ mm	l ₂ mm	Designation A1115S
Cylindrical shank 	2		2	40	8	-2
	3		3	50	10	-3
	4		4	52	12	-4
	5		5	60	15	-5
	6		6	66	20	-6
	6,35	1/4"	6,35	66	20	-1/4IN
	8		8	79	25	-8
	9,525	3/8"	9,525	89	25	-3/8IN
	10		10	89	25	-10
	12		12	102	30	-12
	12,7	1/2"	12,7	102	35	-1/2IN
	14		14	115	35	-14
	15,875	5/8"	15,875	115	35	-5/8IN
	16		16	115	35	-16
	18		18	130	40	-18
	19,05	3/4"	19,05	131	40	-3/4IN
	20		20	131	40	-20
25,4	1"	25,4	138	45	-1IN	

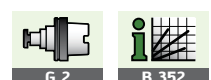

Double ended panel drill A1121

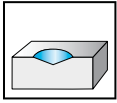

- HSS - steam treated
- Type DSK
- right-hand cutting
- 130° point angle
- Special point grinding form C

	P	M	K	N	S	H	O
uncoated	●●	●	●●	●●	●		●●

	D _c h8 mm	d ₁ mm	l ₁ mm	l ₂ mm	Designation A1121
Cylindrical shank	3,3	3,3	49	18	-3.3
	4,1	4,1	55	22	-4.1
	4,9	4,9	62	26	-4.9

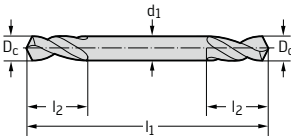



Stub length drill A1148 UFL®

~ 3 x D_c

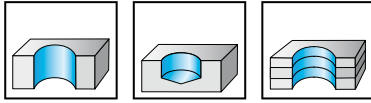

- HSS-E - fibre-steamed
- Type UFL®
- right-hand cutting
- 130° point angle
- up to 1.9 mm bright finish

	P	M	K	N	S	H	O
uncoated	●●	●●	●●	●●	●●		●●

DIN 1897	D _c h8 mm	D _c Inches/No	d ₁ f11 mm	L _c mm	l ₁ mm	l ₂ mm	Designation A1148
Cylindrical shank 	1		1	4	26	6	-1
	1,016	No. 60	1,016	4	26	6	-NO60
	1,041	No. 59	1,041	4	26	6	-NO59
	1,067	No. 58	1,067	5	28	7	-NO58
	1,092	No. 57	1,092	5	28	7	-NO57
	1,1		1,1	5	28	7	-1.1
	1,181	No. 56	1,181	6	30	8	-NO56
	1,191	3/64"	1,191	6	30	8	-3/64IN
	1,2		1,2	6	30	8	-1.2
	1,3		1,3	6	30	8	-1.3
	1,321	No. 55	1,321	6	32	9	-NO55
	1,397	No. 54	1,397	6	32	9	-NO54
	1,4		1,4	6	32	9	-1.4
	1,5		1,5	6	32	9	-1.5
	1,511	No. 53	1,511	7	34	10	-NO53
	1,588	1/16"	1,588	7	34	10	-1/16IN
	1,6		1,6	7	34	10	-1.6
	1,613	No. 52	1,613	7	34	10	-NO52
	1,7		1,7	7	34	10	-1.7
	1,702	No. 51	1,702	8	36	11	-NO51
	1,778	No. 50	1,778	8	36	11	-NO50
	1,8		1,8	8	36	11	-1.8
	1,854	No. 49	1,854	8	36	11	-NO49
	1,9		1,9	8	36	11	-1.9
	1,93	No. 48	1,93	8	38	12	-NO48
	1,984	5/64"	1,984	8	38	12	-5/64IN
	1,994	No. 47	1,994	8	38	12	-NO47
	2		2	8	38	12	-2
	2,057	No. 46	2,057	8	38	12	-NO46
	2,083	No. 45	2,083	8	38	12	-NO45
	2,1		2,1	8	38	12	-2.1
	2,184	No. 44	2,184	9	40	13	-NO44
	2,2		2,2	9	40	13	-2.2
	2,261	No. 43	2,261	9	40	13	-NO43
2,3		2,3	9	40	13	-2.3	
2,375	No. 42	2,375	10	43	14	-NO42	
2,381	3/32"	2,381	10	43	14	-3/32IN	
2,4		2,4	10	43	14	-2.4	
2,438	No. 41	2,438	10	43	14	-NO41	
2,489	No. 40	2,489	10	43	14	-NO40	
2,5		2,5	10	43	14	-2.5	
2,527	No. 39	2,527	10	43	14	-NO39	
2,578	No. 38	2,578	10	43	14	-NO38	
2,6		2,6	10	43	14	-2.6	
2,642	No. 37	2,642	10	43	14	-NO37	
2,7		2,7	11	46	16	-2.7	
2,705	No. 36	2,705	11	46	16	-NO36	

Continued



Stub length drill

A1148

UFL®

~ 3 x D_c



Continued

	P	M	K	N	S	H	O
uncoated	●●	●●	●●	●●	●●		●●

DIN 1897	D _c h8 mm	D _c Inches/No	d ₁ f11 mm	L _c mm	l ₁ mm	l ₂ mm	Designation A1148
Cylindrical shank	2,778	7/64"	2,778	11	46	16	-7/64IN
	2,794	No. 35	2,794	11	46	16	-N035
	2,8		2,8	11	46	16	-2.8
	2,819	No. 34	2,819	11	46	16	-N034
	2,87	No. 33	2,87	11	46	16	-N033
	2,9		2,9	11	46	16	-2.9
	2,946	No. 32	2,946	11	46	16	-N032
	3		3	11	46	16	-3
	3,048	No. 31	3,048	12	49	18	-N031
	3,1		3,1	12	49	18	-3.1
	3,175	1/8"	3,175	12	49	18	-1/8IN
	3,2		3,2	12	49	18	-3.2
	3,264	No. 30	3,264	12	49	18	-N030
	3,3		3,3	12	49	18	-3.3
	3,4		3,4	14	52	20	-3.4
	3,454	No. 29	3,454	14	52	20	-N029
	3,5		3,5	14	52	20	-3.5
	3,569	No. 28	3,569	14	52	20	-N028
	3,572	9/64"	3,572	14	52	20	-9/64IN
	3,6		3,6	14	52	20	-3.6
	3,658	No. 27	3,658	14	52	20	-N027
	3,7		3,7	14	52	20	-3.7
	3,734	No. 26	3,734	14	52	20	-N026
	3,797	No. 25	3,797	15	55	22	-N025
	3,8		3,8	15	55	22	-3.8
	3,861	No. 24	3,861	15	55	22	-N024
	3,9		3,9	15	55	22	-3.9
	3,912	No. 23	3,912	15	55	22	-N023
	3,969	5/32"	3,969	15	55	22	-5/32IN
	3,988	No. 22	3,988	15	55	22	-N022
	4		4	15	55	22	-4
	4,039	No. 21	4,039	15	55	22	-N021
	4,089	No. 20	4,089	15	55	22	-N020
	4,1		4,1	15	55	22	-4.1
	4,2		4,2	15	55	22	-4.2
	4,216	No. 19	4,216	15	55	22	-N019
	4,3		4,3	16	58	24	-4.3
	4,305	No. 18	4,305	16	58	24	-N018
	4,366	11/64"	4,366	16	58	24	-11/64IN
	4,394	No. 17	4,394	16	58	24	-N017
	4,4		4,4	16	58	24	-4.4
	4,496	No. 16	4,496	16	58	24	-N016
	4,5		4,5	16	58	24	-4.5
	4,572	No. 15	4,572	16	58	24	-N015
	4,6		4,6	16	58	24	-4.6
	4,623	No. 14	4,623	16	58	24	-N014
	4,699	No. 13	4,699	16	58	24	-N013
	4,7		4,7	16	58	24	-4.7
	4,763	3/16"	4,763	18	62	26	-3/16IN
	4,8		4,8	18	62	26	-4.8
	4,801	No. 12	4,801	18	62	26	-N012
	4,851	No. 11	4,851	18	62	26	-N011
	4,9		4,9	18	62	26	-4.9
	4,915	No. 10	4,915	18	62	26	-N010
	4,978	No. 9	4,978	18	62	26	-N09

Continued





Stub length drill A1148 UFL®

~ 3 x D_c

	P	M	K	N	S	H	O
uncoated	●●	●●	●●	●●	●●		●●

Continued

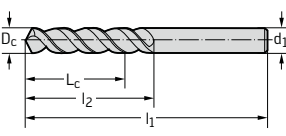
DIN 1897	D _c h8 mm	D _c Inches/No	d ₁ f11 mm	L _c mm	l ₁ mm	l ₂ mm	Designation A1148
Cylindrical shank	5		5	18	62	26	-5
	5,055	No. 8	5,055	18	62	26	-N08
	5,1		5,1	18	62	26	-5.1
	5,105	No. 7	5,105	18	62	26	-N07
	5,159	13/64"	5,159	18	62	26	-13/64IN
	5,182	No. 6	5,182	18	62	26	-N06
	5,2		5,2	18	62	26	-5.2
	5,22	No. 5	5,22	18	62	26	-N05
	5,3		5,3	18	62	26	-5.3
	5,309	No. 4	5,309	19	66	28	-N04
	5,4		5,4	19	66	28	-5.4
	5,41	No. 3	5,41	19	66	28	-N03
	5,5		5,5	19	66	28	-5.5
	5,556	7/32"	5,556	19	66	28	-7/32IN
	5,6		5,6	19	66	28	-5.6
	5,613	No. 2	5,613	19	66	28	-N02
	5,7		5,7	19	66	28	-5.7
	5,791	No. 1	5,791	19	66	28	-N01
	5,8		5,8	19	66	28	-5.8
	5,9		5,9	19	66	28	-5.9
	5,944	Let.A	5,944	19	66	28	-LET.A
	5,953	15/64"	5,953	19	66	28	-15/64IN
	6		6	19	66	28	-6
	6,045	Let.B	6,045	20	70	31	-LET.B
	6,1		6,1	20	70	31	-6.1
	6,147	Let.C	6,147	20	70	31	-LET.C
	6,2		6,2	20	70	31	-6.2
	6,248	Let.D	6,248	20	70	31	-LET.D
	6,3		6,3	20	70	31	-6.3
	6,35	1/4"	6,35	20	70	31	-1/4IN
	6,4		6,4	20	70	31	-6.4
	6,5		6,5	20	70	31	-6.5
	6,528	Let.F	6,528	20	70	31	-LET.F
	6,6		6,6	20	70	31	-6.6
	6,629	Let.G	6,629	20	70	31	-LET.G
	6,7		6,7	20	70	31	-6.7
	6,747	17/64"	6,747	22	74	34	-17/64IN
	6,756	Let.H	6,756	22	74	34	-LET.H
	6,8		6,8	22	74	34	-6.8
	6,9		6,9	22	74	34	-6.9
	6,909	Let.I	6,909	22	74	34	-LET.I
	7		7	22	74	34	-7
	7,036	Let.J	7,036	22	74	34	-LET.J
	7,1		7,1	22	74	34	-7.1
	7,137	Let.K	7,137	22	74	34	-LET.K
	7,144	9/32"	7,144	22	74	34	-9/32IN
	7,2		7,2	22	74	34	-7.2
	7,3		7,3	22	74	34	-7.3
	7,366	Let.L	7,366	22	74	34	-LET.L
	7,4		7,4	22	74	34	-7.4
	7,493	Let.M	7,493	22	74	34	-LET.M
	7,5		7,5	22	74	34	-7.5
	7,541	19/64"	7,541	24	79	37	-19/64IN
	7,6		7,6	24	79	37	-7.6

Continued



Stub length drill

A1148

UFL®

~ 3 x D_c



Continued

	P	M	K	N	S	H	O
uncoated	●●	●●	●●	●●	●●		●●

DIN 1897	D _c h8 mm	D _c Inches/No	d ₁ f11 mm	L _c mm	l ₁ mm	l ₂ mm	Designation A1148
Cylindrical shank 	7,671	Let.N	7,671	24	79	37	-LET.N
	7,7		7,7	24	79	37	-7.7
	7,8		7,8	24	79	37	-7.8
	7,9		7,9	24	79	37	-7.9
	7,938	5/16"	7,938	24	79	37	-5/16IN
	8		8	24	79	37	-8
	8,026	Let.O	8,026	24	79	37	-LET.O
	8,1		8,1	24	79	37	-8.1
	8,2		8,2	24	79	37	-8.2
	8,204	Let.P	8,204	24	79	37	-LET.P
	8,3		8,3	24	79	37	-8.3
	8,334	21/64"	8,334	24	79	37	-21/64IN
	8,4		8,4	24	79	37	-8.4
	8,433	Let.Q	8,433	24	79	37	-LET.Q
	8,5		8,5	24	79	37	-8.5
	8,6		8,6	25	84	40	-8.6
	8,611	Let.R	8,611	25	84	40	-LET.R
	8,7		8,7	25	84	40	-8.7
	8,731	11/32"	8,731	25	84	40	-11/32IN
	8,8		8,8	25	84	40	-8.8
	8,839	Let.S	8,839	25	84	40	-LET.S
	8,9		8,9	25	84	40	-8.9
	9		9	25	84	40	-9
	9,093	Let.T	9,093	25	84	40	-LET.T
	9,1		9,1	25	84	40	-9.1
	9,128	23/64"	9,128	25	84	40	-23/64IN
	9,2		9,2	25	84	40	-9.2
	9,3		9,3	25	84	40	-9.3
9,347	Let.U	9,347	25	84	40	-LET.U	
9,4		9,4	25	84	40	-9.4	
9,5		9,5	25	84	40	-9.5	
9,525	3/8"	9,525	27	89	43	-3/8IN	
9,576	Let.V	9,576	27	89	43	-LET.V	
9,6		9,6	27	89	43	-9.6	
9,7		9,7	27	89	43	-9.7	
9,8		9,8	27	89	43	-9.8	
9,804	Let.W	9,804	27	89	43	-LET.W	
9,9		9,9	27	89	43	-9.9	
9,922	25/64"	9,922	27	89	43	-25/64IN	
10		10	27	89	43	-10	
10,084	Let.X	10,084	27	89	43	-LET.X	
10,2		10,2	27	89	43	-10.2	
10,262	Let.Y	10,262	27	89	43	-LET.Y	
10,319	13/32"	10,319	27	89	43	-13/32IN	
10,49	Let.Z	10,49	27	89	43	-LET.Z	
10,5		10,5	27	89	43	-10.5	
10,716	27/64"	10,716	29	95	47	-27/64IN	
10,8		10,8	29	95	47	-10.8	
11		11	29	95	47	-11	
11,113	7/16"	11,113	29	95	47	-7/16IN	
11,2		11,2	29	95	47	-11.2	
11,5		11,5	29	95	47	-11.5	
11,509	29/64"	11,509	29	95	47	-29/64IN	
11,8		11,8	29	95	47	-11.8	
11,906	15/32"	11,906	37	102	51	-15/32IN	

Continued





Stub length drill A1148 UFL®

~ 3 x D_c

	P	M	K	N	S	H	O
uncoated	●●	●●	●●	●●	●●		●●

Continued

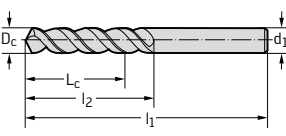
DIN 1897	D _c h8 mm	D _c Inches/No	d ₁ f11 mm	L _c mm	l ₁ mm	l ₂ mm	Designation A1148
Cylindrical shank	12		12	37	102	51	-12
	12,303	31/64"	12,303	37	102	51	-31/64IN
	12,5		12,5	37	102	51	-12.5
	12,7	1/2"	12,7	37	102	51	-1/2IN
	12,8		12,8	37	102	51	-12.8
	13		13	37	102	51	-13
	13,097	33/64"	13,097	37	102	51	-33/64IN
	13,3		13,3	40	107	54	-13.3
	13,494	17/32"	13,494	40	107	54	-17/32IN
	13,5		13,5	40	107	54	-13.5
	13,891	35/64"	13,891	40	107	54	-35/64IN
	14		14	40	107	54	-14
	14,288	9/16"	14,288	41	111	56	-9/16IN
	14,5		14,5	41	111	56	-14.5
	14,684	37/64"	14,684	41	111	56	-37/64IN
	15		15	41	111	56	-15
	15,081	19/32"	15,081	42	115	58	-19/32IN
	15,3		15,3	42	115	58	-15.3
	15,478	39/64"	15,478	42	115	58	-39/64IN
	15,5		15,5	42	115	58	-15.5
	15,875	5/8"	15,875	42	115	58	-5/8IN
	16		16	42	115	58	-16
	16,272	41/64"	16,272	43	119	60	-41/64IN
	16,5		16,5	43	119	60	-16.5
	16,669	21/32"	16,669	43	119	60	-21/32IN
	17		17	43	119	60	-17
	17,066	43/64"	17,066	44	123	62	-43/64IN
	17,463	11/16"	17,463	44	123	62	-11/16IN
	17,5		17,5	44	123	62	-17.5
	17,859	45/64"	17,859	44	123	62	-45/64IN
	18		18	44	123	62	-18
	18,256	23/32"	18,256	45	127	64	-23/32IN
	18,5		18,5	45	127	64	-18.5
	18,653	47/64"	18,653	45	127	64	-47/64IN
	19		19	45	127	64	-19
	19,05	3/4"	19,05	46	131	66	-3/4IN
	19,5		19,5	46	131	66	-19.5
	20		20	46	131	66	-20

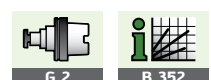

Stub length drill

A1149TFL

UFL®



~ 3 x D_c

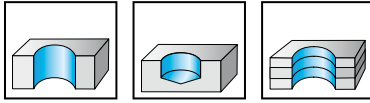

- HSS-E - TFL
- Type UFL®
- right-hand cutting
- 130° point angle

Special features:
suitable for dry machining in steel

	P	M	K	N	S	H	O
TFL	●●	●●	●●	●●	●●		●●

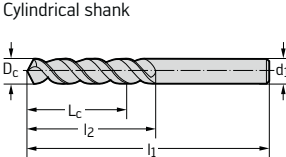
DIN 1897	D _c h8 mm	D _c Inches/No	d ₁ f11 mm	L _c mm	l ₁ mm	l ₂ mm	Designation A1149TFL
Cylindrical shank	1		1	4	26	6	-1
	1,016	No. 60	1,016	4	26	6	-NO60
	1,041	No. 59	1,041	4	26	6	-NO59
	1,067	No. 58	1,067	5	28	7	-NO58
	1,092	No. 57	1,092	5	28	7	-NO57
	1,1		1,1	5	28	7	-1.1
	1,181	No. 56	1,181	6	30	8	-NO56
	1,191	3/64"	1,191	6	30	8	-3/64IN
	1,2		1,2	6	30	8	-1.2
	1,3		1,3	6	30	8	-1.3
	1,321	No. 55	1,321	6	32	9	-NO55
	1,397	No. 54	1,397	6	32	9	-NO54
	1,4		1,4	6	32	9	-1.4
	1,5		1,5	6	32	9	-1.5
	1,511	No. 53	1,511	7	34	10	-NO53
	1,588	1/16"	1,588	7	34	10	-1/16IN
	1,6		1,6	7	34	10	-1.6
	1,613	No. 52	1,613	7	34	10	-NO52
	1,7		1,7	7	34	10	-1.7
	1,702	No. 51	1,702	8	36	11	-NO51
	1,778	No. 50	1,778	8	36	11	-NO50
	1,8		1,8	8	36	11	-1.8
	1,854	No. 49	1,854	8	36	11	-NO49
	1,9		1,9	8	36	11	-1.9
	1,93	No. 48	1,93	8	38	12	-NO48
	1,984	5/64"	1,984	8	38	12	-5/64IN
	1,994	No. 47	1,994	8	38	12	-NO47
	2		2	8	38	12	-2
	2,057	No. 46	2,057	8	38	12	-NO46
	2,083	No. 45	2,083	8	38	12	-NO45
	2,1		2,1	8	38	12	-2.1
	2,184	No. 44	2,184	9	40	13	-NO44
	2,2		2,2	9	40	13	-2.2
	2,261	No. 43	2,261	9	40	13	-NO43
	2,3		2,3	9	40	13	-2.3
	2,375	No. 42	2,375	10	43	14	-NO42
	2,381	3/32"	2,381	10	43	14	-3/32IN
	2,4		2,4	10	43	14	-2.4
	2,438	No. 41	2,438	10	43	14	-NO41
	2,489	No. 40	2,489	10	43	14	-NO40
	2,5		2,5	10	43	14	-2.5
	2,527	No. 39	2,527	10	43	14	-NO39
	2,578	No. 38	2,578	10	43	14	-NO38
	2,6		2,6	10	43	14	-2.6
	2,642	No. 37	2,642	10	43	14	-NO37
	2,7		2,7	11	46	16	-2.7
	2,705	No. 36	2,705	11	46	16	-NO36

Continued





Stub length drill A1149TFL UFL®

~ 3 x D_c

Continued

TFL	P	M	K	N	S	H	O
	●●	●●	●●	●●	●●		●●

DIN 1897	D _c h8 mm	D _c Inches/No	d ₁ f11 mm	L _c mm	l ₁ mm	l ₂ mm	Designation A1149TFL
Cylindrical shank 	2,778	7/64"	2,778	11	46	16	-7/64IN
	2,794	No. 35	2,794	11	46	16	-N035
	2,8		2,8	11	46	16	-2.8
	2,819	No. 34	2,819	11	46	16	-N034
	2,87	No. 33	2,87	11	46	16	-N033
	2,9		2,9	11	46	16	-2.9
	2,946	No. 32	2,946	11	46	16	-N032
	3		3	11	46	16	-3
	3,048	No. 31	3,048	12	49	18	-N031
	3,1		3,1	12	49	18	-3.1
	3,175	1/8"	3,175	12	49	18	-1/8IN
	3,2		3,2	12	49	18	-3.2
	3,264	No. 30	3,264	12	49	18	-N030
	3,3		3,3	12	49	18	-3.3
	3,4		3,4	14	52	20	-3.4
	3,454	No. 29	3,454	14	52	20	-N029
	3,5		3,5	14	52	20	-3.5
	3,569	No. 28	3,569	14	52	20	-N028
	3,572	9/64"	3,572	14	52	20	-9/64IN
	3,6		3,6	14	52	20	-3.6
	3,658	No. 27	3,658	14	52	20	-N027
	3,7		3,7	14	52	20	-3.7
	3,734	No. 26	3,734	14	52	20	-N026
	3,797	No. 25	3,797	15	55	22	-N025
	3,8		3,8	15	55	22	-3.8
	3,861	No. 24	3,861	15	55	22	-N024
	3,9		3,9	15	55	22	-3.9
	3,912	No. 23	3,912	15	55	22	-N023
	3,969	5/32"	3,969	15	55	22	-5/32IN
	3,988	No. 22	3,988	15	55	22	-N022
4		4	15	55	22	-4	
4,039	No. 21	4,039	15	55	22	-N021	
4,089	No. 20	4,089	15	55	22	-N020	
4,1		4,1	15	55	22	-4.1	
4,2		4,2	15	55	22	-4.2	
4,216	No. 19	4,216	15	55	22	-N019	
4,3		4,3	16	58	24	-4.3	
4,305	No. 18	4,305	16	58	24	-N018	
4,366	11/64"	4,366	16	58	24	-11/64IN	
4,394	No. 17	4,394	16	58	24	-N017	
4,4		4,4	16	58	24	-4.4	
4,496	No. 16	4,496	16	58	24	-N016	
4,5		4,5	16	58	24	-4.5	
4,572	No. 15	4,572	16	58	24	-N015	
4,6		4,6	16	58	24	-4.6	
4,623	No. 14	4,623	16	58	24	-N014	
4,65		4,65	16	58	24	-4.65	
4,699	No. 13	4,699	16	58	24	-N013	
4,7		4,7	16	58	24	-4.7	
4,763	3/16"	4,763	18	62	26	-3/16IN	
4,8		4,8	18	62	26	-4.8	
4,801	No. 12	4,801	18	62	26	-N012	
4,851	No. 11	4,851	18	62	26	-N011	
4,9		4,9	18	62	26	-4.9	
4,915	No. 10	4,915	18	62	26	-N010	

Continued



Stub length drill A1149TFL UFL®



~ 3 x D_c

Continued

	P	M	K	N	S	H	O
TFL	●●	●●	●●	●●	●●		●●

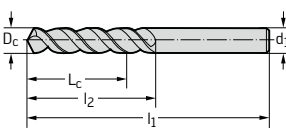
DIN 1897	D _c h8 mm	D _c Inches/No	d ₁ f11 mm	L _c mm	l ₁ mm	l ₂ mm	Designation A1149TFL
Cylindrical shank	4,978	No. 9	4,978	18	62	26	-N09
	5		5	18	62	26	-5
	5,055	No. 8	5,055	18	62	26	-N08
	5,1		5,1	18	62	26	-5.1
	5,105	No. 7	5,105	18	62	26	-N07
	5,159	13/64"	5,159	18	62	26	-13/64IN
	5,182	No. 6	5,182	18	62	26	-N06
	5,2		5,2	18	62	26	-5.2
	5,22	No. 5	5,22	18	62	26	-N05
	5,3		5,3	18	62	26	-5.3
	5,309	No. 4	5,309	19	66	28	-N04
	5,4		5,4	19	66	28	-5.4
	5,41	No. 3	5,41	19	66	28	-N03
	5,5		5,5	19	66	28	-5.5
	5,55		5,55	19	66	28	-5.55
	5,556	7/32"	5,556	19	66	28	-7/32IN
	5,6		5,6	19	66	28	-5.6
	5,613	No. 2	5,613	19	66	28	-N02
	5,7		5,7	19	66	28	-5.7
	5,791	No. 1	5,791	19	66	28	-N01
	5,8		5,8	19	66	28	-5.8
	5,9		5,9	19	66	28	-5.9
	5,944	Let.A	5,944	19	66	28	-LET.A
	5,953	15/64"	5,953	19	66	28	-15/64IN
	6		6	19	66	28	-6
	6,045	Let.B	6,045	20	70	31	-LET.B
	6,1		6,1	20	70	31	-6.1
	6,147	Let.C	6,147	20	70	31	-LET.C
	6,2		6,2	20	70	31	-6.2
	6,248	Let.D	6,248	20	70	31	-LET.D
	6,3		6,3	20	70	31	-6.3
	6,35	1/4"	6,35	20	70	31	-1/4IN
	6,4		6,4	20	70	31	-6.4
	6,5		6,5	20	70	31	-6.5
	6,528	Let.F	6,528	20	70	31	-LET.F
	6,6		6,6	20	70	31	-6.6
	6,629	Let.G	6,629	20	70	31	-LET.G
	6,7		6,7	20	70	31	-6.7
	6,747	17/64"	6,747	22	74	34	-17/64IN
	6,756	Let.H	6,756	22	74	34	-LET.H
	6,8		6,8	22	74	34	-6.8
	6,9		6,9	22	74	34	-6.9
	6,909	Let.I	6,909	22	74	34	-LET.I
	7		7	22	74	34	-7
	7,036	Let.J	7,036	22	74	34	-LET.J
	7,1		7,1	22	74	34	-7.1
	7,137	Let.K	7,137	22	74	34	-LET.K
	7,144	9/32"	7,144	22	74	34	-9/32IN
	7,2		7,2	22	74	34	-7.2
	7,3		7,3	22	74	34	-7.3
	7,366	Let.L	7,366	22	74	34	-LET.L
	7,4		7,4	22	74	34	-7.4
	7,493	Let.M	7,493	22	74	34	-LET.M
	7,5		7,5	22	74	34	-7.5

Continued





Stub length drill A1149TFL UFL®

~ 3 x D_c

	P	M	K	N	S	H	O
TFL	●●	●●	●●	●●	●●		●●

Continued

DIN 1897	D _c h8 mm	D _c Inches/No	d ₁ f11 mm	L _c mm	l ₁ mm	l ₂ mm	Designation A1149TFL	
Cylindrical shank 	7,541	19/64"	7,541	24	79	37	-19/64IN	
	7,6		7,6	24	79	37	-7.6	
	7,671	Let.N	7,671	24	79	37	-LET.N	
	7,7		7,7	24	79	37	-7.7	
	7,8		7,8	24	79	37	-7.8	
	7,9		7,9	24	79	37	-7.9	
	7,938	5/16"	7,938	24	79	79	37	-5/16IN
	8		8	24	79	79	37	-8
	8,026	Let.O	8,026	24	79	79	37	-LET.O
	8,1		8,1	24	79	79	37	-8.1
	8,2		8,2	24	79	79	37	-8.2
	8,204	Let.P	8,204	24	79	79	37	-LET.P
	8,3		8,3	24	79	79	37	-8.3
	8,334	21/64"	8,334	24	79	79	37	-21/64IN
	8,4		8,4	24	79	79	37	-8.4
	8,433	Let.Q	8,433	24	79	79	37	-LET.Q
	8,5		8,5	24	79	79	37	-8.5
	8,6		8,6	25	84	84	40	-8.6
	8,611	Let.R	8,611	25	84	84	40	-LET.R
	8,7		8,7	25	84	84	40	-8.7
	8,731	11/32"	8,731	25	84	84	40	-11/32IN
	8,8		8,8	25	84	84	40	-8.8
	8,839	Let.S	8,839	25	84	84	40	-LET.S
	8,9		8,9	25	84	84	40	-8.9
	9		9	25	84	84	40	-9
	9,093	Let.T	9,093	25	84	84	40	-LET.T
	9,1		9,1	25	84	84	40	-9.1
	9,128	23/64"	9,128	25	84	84	40	-23/64IN
	9,2		9,2	25	84	84	40	-9.2
	9,3		9,3	25	84	84	40	-9.3
	9,347	Let.U	9,347	25	84	84	40	-LET.U
	9,4		9,4	25	84	84	40	-9.4
	9,5		9,5	25	84	84	40	-9.5
	9,525	3/8"	9,525	27	89	89	43	-3/8IN
9,576	Let.V	9,576	27	89	89	43	-LET.V	
9,6		9,6	27	89	89	43	-9.6	
9,7		9,7	27	89	89	43	-9.7	
9,8		9,8	27	89	89	43	-9.8	
9,804	Let.W	9,804	27	89	89	43	-LET.W	
9,9		9,9	27	89	89	43	-9.9	
9,922	25/64"	9,922	27	89	89	43	-25/64IN	
10		10	27	89	89	43	-10	
10,084	Let.X	10,084	27	89	89	43	-LET.X	
10,2		10,2	27	89	89	43	-10.2	
10,262	Let.Y	10,262	27	89	89	43	-LET.Y	
10,319	13/32"	10,319	27	89	89	43	-13/32IN	
10,49	Let.Z	10,49	27	89	89	43	-LET.Z	
10,5		10,5	27	89	89	43	-10.5	
10,716	27/64"	10,716	29	95	95	47	-27/64IN	
10,8		10,8	29	95	95	47	-10.8	
11		11	29	95	95	47	-11	
11,113	7/16"	11,113	29	95	95	47	-7/16IN	
11,2		11,2	29	95	95	47	-11.2	
11,3		11,3	29	95	95	47	-11.3	
11,5		11,5	29	95	95	47	-11.5	

Continued



Stub length drill

A1149TFL

UFL®



~ 3 x D_c

Continued

	P	M	K	N	S	H	O
TFL	●●	●●	●●	●●	●●		●●

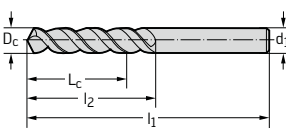
DIN 1897	D _c h8 mm	D _c Inches/No	d ₁ f11 mm	L _c mm	l ₁ mm	l ₂ mm	Designation A1149TFL
Cylindrical shank 	11,509	29/64"	11,509	29	95	47	-29/64IN
	11,8		11,8	29	95	47	-11.8
	11,906	15/32"	11,906	37	102	51	-15/32IN
	12		12	37	102	51	-12
	12,303	31/64"	12,303	37	102	51	-31/64IN
	12,5		12,5	37	102	51	-12.5
	12,7	1/2"	12,7	37	102	51	-1/2IN
	13		13	37	102	51	-13
	13,097	33/64"	13,097	37	102	51	-33/64IN
	13,1		13,1	37	102	51	-13.1
	13,3		13,3	40	107	54	-13.3
	13,494	17/32"	13,494	40	107	54	-17/32IN
	13,5		13,5	40	107	54	-13.5
	13,891	35/64"	13,891	40	107	54	-35/64IN
	14		14	40	107	54	-14
	14,288	9/16"	14,288	41	111	56	-9/16IN
	14,5		14,5	41	111	56	-14.5
	14,684	37/64"	14,684	41	111	56	-37/64IN
	15		15	41	111	56	-15
	15,1		15,1	42	115	58	-15.1
15,3		15,3	42	115	58	-15.3	
15,478	39/64"	15,478	42	115	58	-39/64IN	
15,5		15,5	42	115	58	-15.5	
15,875	5/8"	15,875	42	115	58	-5/8IN	
16		16	42	115	58	-16	
16,272	41/64"	16,272	43	119	60	-41/64IN	
16,5		16,5	43	119	60	-16.5	
16,669	21/32"	16,669	43	119	60	-21/32IN	
17		17	43	119	60	-17	
17,066	43/64"	17,066	44	123	62	-43/64IN	
17,463	11/16"	17,463	44	123	62	-11/16IN	
17,5		17,5	44	123	62	-17.5	
17,859	45/64"	17,859	44	123	62	-45/64IN	
18		18	44	123	62	-18	
18,256	23/32"	18,256	45	127	64	-23/32IN	
18,5		18,5	45	127	64	-18.5	
18,653	47/64"	18,653	45	127	64	-47/64IN	
19		19	45	127	64	-19	
19,05	3/4"	19,05	46	131	66	-3/4IN	
19,5		19,5	46	131	66	-19.5	
20		20	46	131	66	-20	

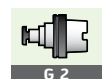



Stub length drill A1149XPL UFL®

~ 3 x D_c

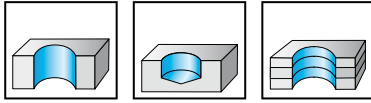

- HSS-E - XPL
- Type UFL®
- right-hand cutting
- 130° point angle

	P	M	K	N	S	H	O
XPL	●●	●●	●●	●●	●●		●●

DIN 1897	D _c h8 mm	D _c Inches/No	d ₁ f11 mm	L _c mm	l ₁ mm	l ₂ mm	Designation A1149XPL
Cylindrical shank 	1		1	4	26	6	-1
	1,016	No. 60	1,016	4	26	6	-NO60
	1,041	No. 59	1,041	4	26	6	-NO59
	1,067	No. 58	1,067	5	28	7	-NO58
	1,092	No. 57	1,092	5	28	7	-NO57
	1,1		1,1	5	28	7	-1.1
	1,181	No. 56	1,181	6	30	8	-NO56
	1,191	3/64"	1,191	6	30	8	-3/64IN
	1,2		1,2	6	30	8	-1.2
	1,3		1,3	6	30	8	-1.3
	1,321	No. 55	1,321	6	32	9	-NO55
	1,397	No. 54	1,397	6	32	9	-NO54
	1,4		1,4	6	32	9	-1.4
	1,5		1,5	6	32	9	-1.5
	1,511	No. 53	1,511	7	34	10	-NO53
	1,588	1/16"	1,588	7	34	10	-1/16IN
	1,6		1,6	7	34	10	-1.6
	1,613	No. 52	1,613	7	34	10	-NO52
	1,7		1,7	7	34	10	-1.7
	1,702	No. 51	1,702	8	36	11	-NO51
	1,778	No. 50	1,778	8	36	11	-NO50
	1,8		1,8	8	36	11	-1.8
	1,854	No. 49	1,854	8	36	11	-NO49
	1,9		1,9	8	36	11	-1.9
	1,93	No. 48	1,93	8	38	12	-NO48
	1,984	5/64"	1,984	8	38	12	-5/64IN
	1,994	No. 47	1,994	8	38	12	-NO47
	2		2	8	38	12	-2
	2,057	No. 46	2,057	8	38	12	-NO46
	2,083	No. 45	2,083	8	38	12	-NO45
	2,1		2,1	8	38	12	-2.1
	2,184	No. 44	2,184	9	40	13	-NO44
	2,2		2,2	9	40	13	-2.2
	2,261	No. 43	2,261	9	40	13	-NO43
2,3		2,3	9	40	13	-2.3	
2,375	No. 42	2,375	10	43	14	-NO42	
2,381	3/32"	2,381	10	43	14	-3/32IN	
2,4		2,4	10	43	14	-2.4	
2,438	No. 41	2,438	10	43	14	-NO41	
2,489	No. 40	2,489	10	43	14	-NO40	
2,5		2,5	10	43	14	-2.5	
2,527	No. 39	2,527	10	43	14	-NO39	
2,578	No. 38	2,578	10	43	14	-NO38	
2,6		2,6	10	43	14	-2.6	
2,642	No. 37	2,642	10	43	14	-NO37	
2,7		2,7	11	46	16	-2.7	
2,705	No. 36	2,705	11	46	16	-NO36	

Continued



Stub length drill

A1149XPL

UFL®



~ 3 x D_c

Continued

	P	M	K	N	S	H	O
XPL	●●	●●	●●	●●	●●		●●

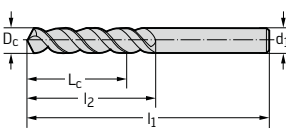
DIN 1897	D _c h8 mm	D _c Inches/No	d ₁ f11 mm	L _c mm	l ₁ mm	l ₂ mm	Designation A1149XPL
Cylindrical shank	2,778	7/64"	2,778	11	46	16	-7/64IN
	2,794	No. 35	2,794	11	46	16	-N035
	2,8		2,8	11	46	16	-2.8
	2,819	No. 34	2,819	11	46	16	-N034
	2,87	No. 33	2,87	11	46	16	-N033
	2,9		2,9	11	46	16	-2.9
	2,946	No. 32	2,946	11	46	16	-N032
	3		3	11	46	16	-3
	3,048	No. 31	3,048	12	49	18	-N031
	3,1		3,1	12	49	18	-3.1
	3,175	1/8"	3,175	12	49	18	-1/8IN
	3,2		3,2	12	49	18	-3.2
	3,264	No. 30	3,264	12	49	18	-N030
	3,3		3,3	12	49	18	-3.3
	3,4		3,4	14	52	20	-3.4
	3,454	No. 29	3,454	14	52	20	-N029
	3,5		3,5	14	52	20	-3.5
	3,569	No. 28	3,569	14	52	20	-N028
	3,572	9/64"	3,572	14	52	20	-9/64IN
	3,6		3,6	14	52	20	-3.6
	3,658	No. 27	3,658	14	52	20	-N027
	3,7		3,7	14	52	20	-3.7
	3,734	No. 26	3,734	14	52	20	-N026
	3,797	No. 25	3,797	15	55	22	-N025
	3,8		3,8	15	55	22	-3.8
	3,861	No. 24	3,861	15	55	22	-N024
	3,9		3,9	15	55	22	-3.9
	3,912	No. 23	3,912	15	55	22	-N023
	3,969	5/32"	3,969	15	55	22	-5/32IN
	3,988	No. 22	3,988	15	55	22	-N022
	4		4	15	55	22	-4
	4,039	No. 21	4,039	15	55	22	-N021
	4,089	No. 20	4,089	15	55	22	-N020
	4,1		4,1	15	55	22	-4.1
	4,2		4,2	15	55	22	-4.2
	4,216	No. 19	4,216	15	55	22	-N019
	4,3		4,3	16	58	24	-4.3
	4,305	No. 18	4,305	16	58	24	-N018
	4,366	11/64"	4,366	16	58	24	-11/64IN
	4,394	No. 17	4,394	16	58	24	-N017
	4,4		4,4	16	58	24	-4.4
	4,496	No. 16	4,496	16	58	24	-N016
	4,5		4,5	16	58	24	-4.5
	4,572	No. 15	4,572	16	58	24	-N015
	4,6		4,6	16	58	24	-4.6
	4,623	No. 14	4,623	16	58	24	-N014
	4,65		4,65	16	58	24	-4.65
	4,699	No. 13	4,699	16	58	24	-N013
	4,7		4,7	16	58	24	-4.7
	4,763	3/16"	4,763	18	62	26	-3/16IN
	4,8		4,8	18	62	26	-4.8
	4,801	No. 12	4,801	18	62	26	-N012
	4,851	No. 11	4,851	18	62	26	-N011
	4,9		4,9	18	62	26	-4.9
	4,915	No. 10	4,915	18	62	26	-N010

Continued





Stub length drill A1149XPL UFL®

~ 3 x D_c

Continued

	P	M	K	N	S	H	O
XPL	●●	●●	●●	●●	●●		●●

DIN 1897	D _c h8 mm	D _c Inches/No	d ₁ f11 mm	L _c mm	l ₁ mm	l ₂ mm	Designation A1149XPL
Cylindrical shank 	4,978	No. 9	4,978	18	62	26	-N09
	5		5	18	62	26	-5
	5,055	No. 8	5,055	18	62	26	-N08
	5,1		5,1	18	62	26	-5.1
	5,105	No. 7	5,105	18	62	26	-N07
	5,159	13/64"	5,159	18	62	26	-13/64IN
	5,182	No. 6	5,182	18	62	26	-N06
	5,2		5,2	18	62	26	-5.2
	5,22	No. 5	5,22	18	62	26	-N05
	5,3		5,3	18	62	26	-5.3
	5,309	No. 4	5,309	19	66	28	-N04
	5,4		5,4	19	66	28	-5.4
	5,41	No. 3	5,41	19	66	28	-N03
	5,5		5,5	19	66	28	-5.5
	5,55		5,55	19	66	28	-5.55
	5,556	7/32"	5,556	19	66	28	-7/32IN
	5,6		5,6	19	66	28	-5.6
	5,613	No. 2	5,613	19	66	28	-N02
	5,7		5,7	19	66	28	-5.7
	5,791	No. 1	5,791	19	66	28	-N01
	5,8		5,8	19	66	28	-5.8
	5,9		5,9	19	66	28	-5.9
	5,944	Let.A	5,944	19	66	28	-LET.A
	5,953	15/64"	5,953	19	66	28	-15/64IN
	6		6	19	66	28	-6
	6,045	Let.B	6,045	20	70	31	-LET.B
	6,1		6,1	20	70	31	-6.1
	6,147	Let.C	6,147	20	70	31	-LET.C
	6,2		6,2	20	70	31	-6.2
	6,248	Let.D	6,248	20	70	31	-LET.D
6,3		6,3	20	70	31	-6.3	
6,35	1/4"	6,35	20	70	31	-1/4IN	
6,4		6,4	20	70	31	-6.4	
6,5		6,5	20	70	31	-6.5	
6,528	Let.F	6,528	20	70	31	-LET.F	
6,6		6,6	20	70	31	-6.6	
6,629	Let.G	6,629	20	70	31	-LET.G	
6,7		6,7	20	70	31	-6.7	
6,747	17/64"	6,747	22	74	34	-17/64IN	
6,756	Let.H	6,756	22	74	34	-LET.H	
6,8		6,8	22	74	34	-6.8	
6,9		6,9	22	74	34	-6.9	
6,909	Let.I	6,909	22	74	34	-LET.I	
7		7	22	74	34	-7	
7,036	Let.J	7,036	22	74	34	-LET.J	
7,1		7,1	22	74	34	-7.1	
7,137	Let.K	7,137	22	74	34	-LET.K	
7,144	9/32"	7,144	22	74	34	-9/32IN	
7,2		7,2	22	74	34	-7.2	
7,3		7,3	22	74	34	-7.3	
7,366	Let.L	7,366	22	74	34	-LET.L	
7,4		7,4	22	74	34	-7.4	
7,493	Let.M	7,493	22	74	34	-LET.M	
7,5		7,5	22	74	34	-7.5	

Continued



Stub length drill A1149XPL UFL®

~ 3 x D_c



Continued

	P	M	K	N	S	H	O
XPL	●●	●●	●●	●●	●●		●●

DIN 1897	D _c h8 mm	D _c Inches/No	d ₁ f11 mm	L _c mm	l ₁ mm	l ₂ mm	Designation A1149XPL
Cylindrical shank	7,541	19/64"	7,541	24	79	37	-19/64IN
	7,6		7,6	24	79	37	-7.6
	7,671	Let.N	7,671	24	79	37	-LET.N
	7,7		7,7	24	79	37	-7.7
	7,8		7,8	24	79	37	-7.8
	7,9		7,9	24	79	37	-7.9
	7,938	5/16"	7,938	24	79	37	-5/16IN
	8		8	24	79	37	-8
	8,026	Let.O	8,026	24	79	37	-LET.O
	8,1		8,1	24	79	37	-8.1
	8,2		8,2	24	79	37	-8.2
	8,204	Let.P	8,204	24	79	37	-LET.P
	8,3		8,3	24	79	37	-8.3
	8,334	21/64"	8,334	24	79	37	-21/64IN
	8,4		8,4	24	79	37	-8.4
	8,433	Let.Q	8,433	24	79	37	-LET.Q
	8,5		8,5	24	79	37	-8.5
	8,6		8,6	25	84	40	-8.6
	8,611	Let.R	8,611	25	84	40	-LET.R
	8,7		8,7	25	84	40	-8.7
	8,731	11/32"	8,731	25	84	40	-11/32IN
	8,8		8,8	25	84	40	-8.8
	8,839	Let.S	8,839	25	84	40	-LET.S
	8,9		8,9	25	84	40	-8.9
	9		9	25	84	40	-9
	9,093	Let.T	9,093	25	84	40	-LET.T
	9,1		9,1	25	84	40	-9.1
	9,128	23/64"	9,128	25	84	40	-23/64IN
	9,2		9,2	25	84	40	-9.2
	9,3		9,3	25	84	40	-9.3
	9,347	Let.U	9,347	25	84	40	-LET.U
	9,4		9,4	25	84	40	-9.4
	9,5		9,5	25	84	40	-9.5
	9,525	3/8"	9,525	27	89	43	-3/8IN
	9,576	Let.V	9,576	27	89	43	-LET.V
	9,6		9,6	27	89	43	-9.6
	9,7		9,7	27	89	43	-9.7
	9,8		9,8	27	89	43	-9.8
	9,804	Let.W	9,804	27	89	43	-LET.W
	9,9		9,9	27	89	43	-9.9
	9,922	25/64"	9,922	27	89	43	-25/64IN
	10		10	27	89	43	-10
	10,084	Let.X	10,084	27	89	43	-LET.X
	10,2		10,2	27	89	43	-10.2
	10,262	Let.Y	10,262	27	89	43	-LET.Y
	10,319	13/32"	10,319	27	89	43	-13/32IN
	10,49	Let.Z	10,49	27	89	43	-LET.Z
	10,5		10,5	27	89	43	-10.5
	10,716	27/64"	10,716	29	95	47	-27/64IN
	10,8		10,8	29	95	47	-10.8
	11		11	29	95	47	-11
	11,113	7/16"	11,113	29	95	47	-7/16IN
	11,2		11,2	29	95	47	-11.2
	11,3		11,3	29	95	47	-11.3
	11,5		11,5	29	95	47	-11.5

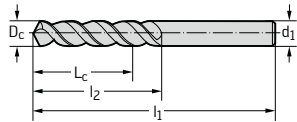

Continued





Stub length drill A1149XPL UFL®

~ 3 x D_c

Continued

	P	M	K	N	S	H	O
XPL	●●	●●	●●	●●	●●		●●

DIN 1897	D _c h8 mm	D _c Inches/No	d ₁ f11 mm	L _c mm	l ₁ mm	l ₂ mm	Designation A1149XPL
Cylindrical shank 	11,509	29/64"	11,509	29	95	47	-29/64IN
	11,8		11,8	29	95	47	-11.8
	11,906	15/32"	11,906	37	102	51	-15/32IN
	12		12	37	102	51	-12
	12,303	31/64"	12,303	37	102	51	-31/64IN
	12,5		12,5	37	102	51	-12.5
	12,7	1/2"	12,7	37	102	51	-1/2IN
	12,8		12,8	37	102	51	-12.8
	13		13	37	102	51	-13
	13,097	33/64"	13,097	37	102	51	-33/64IN
	13,1		13,1	37	102	51	-13.1
	13,3		13,3	40	107	54	-13.3
	13,494	17/32"	13,494	40	107	54	-17/32IN
	13,5		13,5	40	107	54	-13.5
	13,891	35/64"	13,891	40	107	54	-35/64IN
	14		14	40	107	54	-14
	14,288	9/16"	14,288	41	111	56	-9/16IN
	14,5		14,5	41	111	56	-14.5
	14,684	37/64"	14,684	41	111	56	-37/64IN
	15		15	41	111	56	-15
15,081	19/32"	15,081	42	115	58	-19/32IN	
15,1		15,1	42	115	58	-15.1	
15,3		15,3	42	115	58	-15.3	
15,478	39/64"	15,478	42	115	58	-39/64IN	
15,5		15,5	42	115	58	-15.5	
15,875	5/8"	15,875	42	115	58	-5/8IN	
16		16	42	115	58	-16	
16,272	41/64"	16,272	43	119	60	-41/64IN	
16,5		16,5	43	119	60	-16.5	
16,669	21/32"	16,669	43	119	60	-21/32IN	
17		17	43	119	60	-17	
17,066	43/64"	17,066	44	123	62	-43/64IN	
17,463	11/16"	17,463	44	123	62	-11/16IN	
17,5		17,5	44	123	62	-17.5	
17,859	45/64"	17,859	44	123	62	-45/64IN	
18		18	44	123	62	-18	
18,256	23/32"	18,256	45	127	64	-23/32IN	
18,5		18,5	45	127	64	-18.5	
18,653	47/64"	18,653	45	127	64	-47/64IN	
19		19	45	127	64	-19	
19,05	3/4"	19,05	46	131	66	-3/4IN	
19,5		19,5	46	131	66	-19.5	
20		20	46	131	66	-20	





Short series jobber drill

A1154TFT

VA Inox

~ 3 x D_c

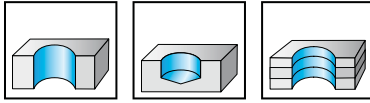

- HSS-E - TFT
- Type VA Inox
- right-hand cutting
- 118° point angle

	P	M	K	N	S	H	O
TFT	●●	●●	●●	●●	●●		●●

DIN 1897	D _c h8 mm	d ₁ f11 mm	L _c mm	l ₁ mm	l ₂ mm	Designation A1154TFT
Cylindrical shank	2	2	8	38	12	-2
	2,1	2,1	8	38	12	-2.1
	2,2	2,2	9	40	13	-2.2
	2,3	2,3	9	40	13	-2.3
	2,4	2,4	10	43	14	-2.4
	2,5	2,5	10	43	14	-2.5
	2,6	2,6	10	43	14	-2.6
	2,7	2,7	11	46	16	-2.7
	2,8	2,8	11	46	16	-2.8
	2,9	2,9	11	46	16	-2.9
	3	3	11	46	16	-3
	3,1	3,1	12	49	18	-3.1
	3,2	3,2	12	49	18	-3.2
	3,3	3,3	12	49	18	-3.3
	3,4	3,4	14	52	20	-3.4
	3,5	3,5	14	52	20	-3.5
	3,6	3,6	14	52	20	-3.6
	3,7	3,7	14	52	20	-3.7
	3,8	3,8	15	55	22	-3.8
	3,9	3,9	15	55	22	-3.9
	4	4	15	55	22	-4
	4,1	4,1	15	55	22	-4.1
	4,2	4,2	15	55	22	-4.2
	4,3	4,3	16	58	24	-4.3
	4,4	4,4	16	58	24	-4.4
	4,5	4,5	16	58	24	-4.5
	4,6	4,6	16	58	24	-4.6
	4,65	4,65	16	58	24	-4.65
	4,7	4,7	16	58	24	-4.7
	4,8	4,8	18	62	26	-4.8
	4,9	4,9	18	62	26	-4.9
	5	5	18	62	26	-5
	5,1	5,1	18	62	26	-5.1
	5,2	5,2	18	62	26	-5.2
	5,3	5,3	18	62	26	-5.3
	5,4	5,4	19	66	28	-5.4
	5,5	5,5	19	66	28	-5.5
	5,55	5,55	19	66	28	-5.55
	5,6	5,6	19	66	28	-5.6
	5,7	5,7	19	66	28	-5.7
	5,8	5,8	19	66	28	-5.8
	5,9	5,9	19	66	28	-5.9
	6	6	19	66	28	-6
	6,1	6,1	20	70	31	-6.1
	6,2	6,2	20	70	31	-6.2
	6,3	6,3	20	70	31	-6.3
	6,4	6,4	20	70	31	-6.4

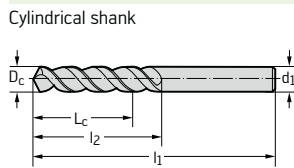

Continued

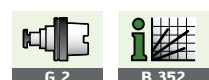



Short series jobber drill A1154TFT VA Inox

~ 3 x D_c

	P	M	K	N	S	H	O
TFT	●●	●●	●●	●●	●●	●●	●●

Continued

DIN 1897	D _c h8 mm	d ₁ f11 mm	L _c mm	l ₁ mm	l ₂ mm	Designation A1154TFT
Cylindrical shank	6,5	6,5	20	70	31	-6.5
	6,6	6,6	20	70	31	-6.6
	6,7	6,7	20	70	31	-6.7
	6,8	6,8	22	74	34	-6.8
	6,9	6,9	22	74	34	-6.9
	7	7	22	74	34	-7
	7,1	7,1	22	74	34	-7.1
	7,2	7,2	22	74	34	-7.2
	7,3	7,3	22	74	34	-7.3
	7,4	7,4	22	74	34	-7.4
	7,5	7,5	22	74	34	-7.5
	7,6	7,6	24	79	37	-7.6
	7,7	7,7	24	79	37	-7.7
	7,8	7,8	24	79	37	-7.8
	7,9	7,9	24	79	37	-7.9
	8	8	24	79	37	-8
	8,1	8,1	24	79	37	-8.1
	8,2	8,2	24	79	37	-8.2
	8,3	8,3	24	79	37	-8.3
	8,4	8,4	24	79	37	-8.4
	8,5	8,5	24	79	37	-8.5
	8,6	8,6	25	84	40	-8.6
	8,7	8,7	25	84	40	-8.7
	8,8	8,8	25	84	40	-8.8
	8,9	8,9	25	84	40	-8.9
	9	9	25	84	40	-9
	9,1	9,1	25	84	40	-9.1
	9,2	9,2	25	84	40	-9.2
	9,3	9,3	25	84	40	-9.3
	9,4	9,4	25	84	40	-9.4
	9,5	9,5	25	84	40	-9.5
	9,6	9,6	27	89	43	-9.6
	9,7	9,7	27	89	43	-9.7
	9,8	9,8	27	89	43	-9.8
	9,9	9,9	27	89	43	-9.9
	10	10	27	89	43	-10
	10,2	10,2	27	89	43	-10.2
	10,3	10,3	27	89	43	-10.3
	10,5	10,5	27	89	43	-10.5
	10,6	10,6	27	89	43	-10.6
	10,7	10,7	29	95	47	-10.7
	10,8	10,8	29	95	47	-10.8
	10,9	10,9	29	95	47	-10.9
	11	11	29	95	47	-11
	11,1	11,1	29	95	47	-11.1
	11,2	11,2	29	95	47	-11.2
	11,3	11,3	29	95	47	-11.3
	11,5	11,5	29	95	47	-11.5
	11,6	11,6	29	95	47	-11.6
	11,8	11,8	29	95	47	-11.8
	11,9	11,9	37	102	51	-11.9
	12	12	37	102	51	-12
	12,1	12,1	37	102	51	-12.1
	12,3	12,3	37	102	51	-12.3
	12,5	12,5	37	102	51	-12.5

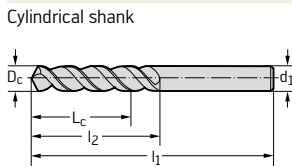

Continued



Short series jobber drill

A1154TFT

VA Inox



~ 3 x D_c

Continued

	P	M	K	N	S	H	O
TFT	●●	●●	●●	●●	●●	●●	●●

DIN 1897	D _c h8 mm	d ₁ f11 mm	L _c mm	l ₁ mm	l ₂ mm	Designation A1154TFT
Cylindrical shank	12,6	12,6	37	102	51	-12.6
	12,7	12,7	37	102	51	-12.7
	13	13	37	102	51	-13
	13,1	13,1	37	102	51	-13.1
	13,2	13,2	37	102	51	-13.2
	13,3	13,3	40	107	54	-13.3
	13,4	13,4	40	107	54	-13.4
	13,5	13,5	40	107	54	-13.5
	13,6	13,6	40	107	54	-13.6
	14	14	40	107	54	-14
	14,1	14,1	41	111	56	-14.1
	14,2	14,2	41	111	56	-14.2
	14,5	14,5	41	111	56	-14.5
	14,8	14,8	41	111	56	-14.8
	15	15	41	111	56	-15
	15,1	15,1	42	115	58	-15.1
	15,2	15,2	42	115	58	-15.2
	15,3	15,3	42	115	58	-15.3
	15,4	15,4	42	115	58	-15.4
	15,5	15,5	42	115	58	-15.5
	15,8	15,8	42	115	58	-15.8
	16	16	42	115	58	-16

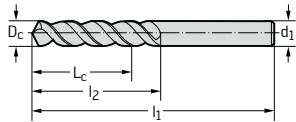

Jobber drill A1211



~ 8 x D_c

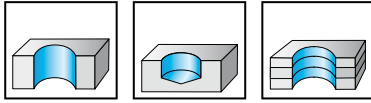

- HSS - steam treated
- Type N
- right-hand cutting
- 118° point angle
- up to 3 mm bright finish
- available as set

	P	M	K	N	S	H	O
uncoated	●●	●	●●	●●	●		●●

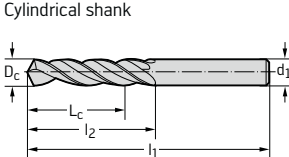
DIN 338	D _c h8 mm	D _c Inches/No	d ₁ f11 mm	L _c mm	l ₁ mm	l ₂ mm	Designation A1211	
Cylindrical shank 	0,2		0,2	2,1	19	2,5	-0.2	
	0,22		0,22	2,1	19	2,5	-0.22	
	0,23		0,23	2,1	19	2,5	-0.23	
	0,25		0,25	2,5	19	3	-0.25	
	0,27		0,27	2,5	19	3	-0.27	
	0,28		0,28	2,5	19	3	-0.28	
	0,29		0,29	2,5	19	3	-0.29	
	0,3		0,3	2,5	19	3	-0.3	
	0,31		0,31	3,4	19	4	-0.31	
	0,318		No. 82	0,318	3,4	19	4	-N082
	0,32		0,32	3,4	19	4	-0.32	
	0,33		No. 81	0,33	3,4	19	4	-0.33
	0,34		0,34	3,4	19	4	-0.34	
	0,343		No. 80	0,343	3,4	19	4	-N080
	0,35		0,35	3,4	19	4	-0.35	
	0,368		No. 79	0,368	3,4	19	4	-N079
	0,38		0,38	3,4	19	4	-0.38	
	0,397		1/64"	0,397	4,2	20	5	-1/64IN
	0,4		0,4	4,2	20	5	-0.4	
	0,406		No. 78	0,406	4,2	20	5	-N078
	0,42		0,42	4,2	20	5	-0.42	
	0,43		0,43	4,2	20	5	-0.43	
	0,45		0,45	4,2	20	5	-0.45	
	0,457		No. 77	0,457	4,2	20	5	-N077
	0,47		0,47	4,2	20	5	-0.47	
	0,48		0,48	4,2	20	5	-0.48	
	0,49		0,49	5,2	22	6	-0.49	
	0,5		0,5	5,2	22	6	-0.5	
	0,508		No. 76	0,508	5,2	22	6	-N076
	0,51		0,51	5,2	22	6	-0.51	
	0,52		0,52	5,2	22	6	-0.52	
	0,53		0,53	5,2	22	6	-0.53	
	0,533		No. 75	0,533	6,1	24	7	-N075
	0,54		0,54	6,1	24	7	-0.54	
	0,55		0,55	6,1	24	7	-0.55	
	0,57		0,57	6,1	24	7	-0.57	
0,572		No. 74	0,572	6,1	24	7	-N074	
0,58		0,58	6,1	24	7	-0.58		
0,59		0,59	6,1	24	7	-0.59		
0,6		0,6	6,1	24	7	-0.6		
0,61		No. 73	0,61	6,9	26	8	-0.61	
0,61		No. 73	0,61	6,9	26	8	-N073	
0,62		0,62	6,9	26	8	-0.62		
0,63		0,63	6,9	26	8	-0.63		
0,635		No. 72	0,635	6,9	26	8	-N072	
0,65		0,65	6,9	26	8	-0.65		
0,66		No. 71	0,66	6,9	26	8	-N071	

Continued



Jobber drill A1211



~ 8 x D_c

Continued

	P	M	K	N	S	H	O
uncoated	●●	●	●●	●●	●		●●

DIN 338	D _c h8 mm	D _c Inches/No	d ₁ f11 mm	L _c mm	l ₁ mm	l ₂ mm	Designation A1211
Cylindrical shank 	0,67		0,67	6,9	26	8	-0.67
	0,68		0,68	7,8	28	9	-0.68
	0,7		0,7	7,8	28	9	-0.7
	0,711	No. 70	0,711	7,8	28	9	-NO70
	0,72		0,72	7,8	28	9	-0.72
	0,73		0,73	7,8	28	9	-0.73
	0,742	No. 69	0,742	7,8	28	9	-NO69
	0,75		0,75	7,8	28	9	-0.75
	0,76		0,76	8,7	30	10	-0.76
	0,78		0,78	8,7	30	10	-0.78
	0,787	No. 68	0,787	8,7	30	10	-NO68
	0,794	1/32"	0,794	8,7	30	10	-1/32IN
	0,8		0,8	8,7	30	10	-0.8
	0,81		0,81	8,7	30	10	-0.81
	0,813	No. 67	0,813	8,7	30	10	-NO67
	0,82		0,82	8,7	30	10	-0.82
	0,83		0,83	8,7	30	10	-0.83
	0,838	No. 66	0,838	8,7	30	10	-NO66
	0,85		0,85	8,7	30	10	-0.85
	0,87		0,87	9,5	32	11	-0.87
	0,88		0,88	9,5	32	11	-0.88
	0,889	No. 65	0,889	9,5	32	11	-NO65
	0,9		0,9	9,5	32	11	-0.9
	0,91		0,91	9,5	32	11	-0.91
	0,914	No. 64	0,914	9,5	32	11	-NO64
	0,92		0,92	9,5	32	11	-0.92
	0,94	No. 63	0,94	9,5	32	11	-NO63
	0,95		0,95	9,5	32	11	-0.95
0,96		0,96	10	34	12	-0.96	
0,965	No. 62	0,965	10	34	12	-NO62	
0,97		0,97	10	34	12	-0.97	
0,98		0,98	10	34	12	-0.98	
0,99		0,99	10	34	12	-0.99	
0,991	No. 61	0,991	10	34	12	-NO61	
1		1	10	34	12	-1	
1,01		1,01	10	34	12	-1.01	
1,016	No. 60	1,016	10	34	12	-NO60	
1,02		1,02	10	34	12	-1.02	
1,03		1,03	10	34	12	-1.03	
1,04		1,04	10	34	12	-1.04	
1,041	No. 59	1,041	10	34	12	-NO59	
1,05		1,05	10	34	12	-1.05	
1,067	No. 58	1,067	12	36	14	-NO58	
1,092	No. 57	1,092	12	36	14	-NO57	
1,1		1,1	12	36	14	-1.1	
1,12		1,12	12	36	14	-1.12	
1,13		1,13	12	36	14	-1.13	
1,15		1,15	12	36	14	-1.15	
1,18		1,18	12	36	14	-1.18	
1,181	No. 56	1,181	14	38	16	-NO56	
1,191	3/64"	1,191	14	38	16	-3/64IN	
1,2		1,2	14	38	16	-1.2	
1,21		1,21	14	38	16	-1.21	
1,22		1,22	14	38	16	-1.22	
1,23		1,23	14	38	16	-1.23	

Continued



Jobber drill A1211



~ 8 x D_c

Continued

	P	M	K	N	S	H	O
uncoated	●●	●	●●	●●	●		●●

DIN 338	D _c h8 mm	D _c Inches/No	d ₁ f11 mm	L _c mm	l ₁ mm	l ₂ mm	Designation A1211
Cylindrical shank 	1,24		1,24	14	38	16	-1.24
	1,25		1,25	14	38	16	-1.25
	1,27		1,27	14	38	16	-1.27
	1,28		1,28	14	38	16	-1.28
	1,3		1,3	14	38	16	-1.3
	1,321	No. 55	1,321	15	40	18	-N055
	1,33		1,33	15	40	18	-1.33
	1,35		1,35	15	40	18	-1.35
	1,36		1,36	15	40	18	-1.36
	1,37		1,37	15	40	18	-1.37
	1,397	No. 54	1,397	15	40	18	-N054
	1,4		1,4	15	40	18	-1.4
	1,42		1,42	15	40	18	-1.42
	1,43		1,43	15	40	18	-1.43
	1,45		1,45	15	40	18	-1.45
	1,49		1,49	15	40	18	-1.49
	1,5		1,5	15	40	18	-1.5
	1,51		1,51	17	43	20	-1.51
	1,511	No. 53	1,511	17	43	20	-N053
	1,52		1,52	17	43	20	-1.52
	1,53		1,53	17	43	20	-1.53
	1,55		1,55	17	43	20	-1.55
	1,57		1,57	17	43	20	-1.57
	1,588	1/16"	1,588	17	43	20	-1/16IN
	1,6		1,6	17	43	20	-1.6
	1,613	No. 52	1,613	17	43	20	-N052
	1,63		1,63	17	43	20	-1.63
	1,65		1,65	17	43	20	-1.65
1,7		1,7	17	43	20	-1.7	
1,702	No. 51	1,702	19	46	22	-N051	
1,75		1,75	19	46	22	-1.75	
1,778	No. 50	1,778	19	46	22	-N050	
1,8		1,8	19	46	22	-1.8	
1,85		1,85	19	46	22	-1.85	
1,854	No. 49	1,854	19	46	22	-N049	
1,9		1,9	19	46	22	-1.9	
1,93	No. 48	1,93	20	49	24	-N048	
1,95		1,95	20	49	24	-1.95	
1,984	5/64"	1,984	20	49	24	-5/64IN	
1,994	No. 47	1,994	20	49	24	-N047	
2		2	20	49	24	-2	
2,05		2,05	20	49	24	-2.05	
2,057	No. 46	2,057	20	49	24	-N046	
2,083	No. 45	2,083	20	49	24	-N045	
2,1		2,1	20	49	24	-2.1	
2,15		2,15	23	53	27	-2.15	
2,184	No. 44	2,184	23	53	27	-N044	
2,2		2,2	23	53	27	-2.2	
2,25		2,25	23	53	27	-2.25	
2,261	No. 43	2,261	23	53	27	-N043	
2,3		2,3	23	53	27	-2.3	
2,35		2,35	23	53	27	-2.35	
2,375	No. 42	2,375	26	57	30	-N042	
2,381	3/32"	2,381	26	57	30	-3/32IN	
2,4		2,4	26	57	30	-2.4	

Continued



Jobber drill A1211



~ 8 x D_c

Continued

	P	M	K	N	S	H	O
uncoated	●●	●	●●	●●	●		●●

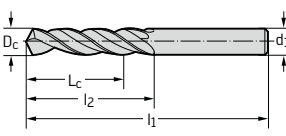
DIN 338	D _c h8 mm	D _c Inches/No	d ₁ f11 mm	L _c mm	l ₁ mm	l ₂ mm	Designation A1211
Cylindrical shank 	2,438	No. 41	2,438	26	57	30	-NO41
	2,45		2,45	26	57	30	-2.45
	2,489	No. 40	2,489	26	57	30	-NO40
	2,5		2,5	26	57	30	-2.5
	2,527	No. 39	2,527	26	57	30	-NO39
	2,55		2,55	26	57	30	-2.55
	2,578	No. 38	2,578	26	57	30	-NO38
	2,6		2,6	26	57	30	-2.6
	2,642	No. 37	2,642	26	57	30	-NO37
	2,65		2,65	26	57	30	-2.65
	2,7		2,7	28	61	33	-2.7
	2,705	No. 36	2,705	28	61	33	-NO36
	2,75		2,75	28	61	33	-2.75
	2,778	7/64"	2,778	28	61	33	-7/64IN
	2,794	No. 35	2,794	28	61	33	-NO35
	2,8		2,8	28	61	33	-2.8
	2,819	No. 34	2,819	28	61	33	-NO34
	2,85		2,85	28	61	33	-2.85
	2,87	No. 33	2,87	28	61	33	-NO33
	2,9		2,9	28	61	33	-2.9
	2,946	No. 32	2,946	28	61	33	-NO32
	2,95		2,95	28	61	33	-2.95
	3		3	28	61	33	-3
	3,048	No. 31	3,048	30	65	36	-NO31
	3,05		3,05	30	65	36	-3.05
	3,1		3,1	30	65	36	-3.1
	3,15		3,15	30	65	36	-3.15
	3,175	1/8"	3,175	30	65	36	-1/8IN
3,2		3,2	30	65	36	-3.2	
3,25		3,25	30	65	36	-3.25	
3,264	No. 30	3,264	30	65	36	-NO30	
3,3		3,3	30	65	36	-3.3	
3,35		3,35	30	65	36	-3.35	
3,4		3,4	33	70	39	-3.4	
3,45		3,45	33	70	39	-3.45	
3,454	No. 29	3,454	33	70	39	-NO29	
3,5		3,5	33	70	39	-3.5	
3,55		3,55	33	70	39	-3.55	
3,569	No. 28	3,569	33	70	39	-NO28	
3,572	9/64"	3,572	33	70	39	-9/64IN	
3,6		3,6	33	70	39	-3.6	
3,65		3,65	33	70	39	-3.65	
3,658	No. 27	3,658	33	70	39	-NO27	
3,7		3,7	33	70	39	-3.7	
3,734	No. 26	3,734	33	70	39	-NO26	
3,75		3,75	33	70	39	-3.75	
3,797	No. 25	3,797	36	75	43	-NO25	
3,8		3,8	36	75	43	-3.8	
3,861	No. 24	3,861	36	75	43	-NO24	
3,9		3,9	36	75	43	-3.9	
3,912	No. 23	3,912	36	75	43	-NO23	
3,95		3,95	36	75	43	-3.95	
3,969	5/32"	3,969	36	75	43	-5/32IN	
3,988	No. 22	3,988	36	75	43	-NO22	
4		4	36	75	43	-4	

Continued



Jobber drill A1211



~ 8 x D_c

Continued

	P	M	K	N	S	H	O
uncoated	●●	●	●●	●●	●		●●

DIN 338	D _c h8 mm	D _c Inches/No	d ₁ f11 mm	L _c mm	l ₁ mm	l ₂ mm	Designation A1211
Cylindrical shank 	4,039	No. 21	4,039	36	75	43	-N021
	4,05		4,05	36	75	43	-4.05
	4,089	No. 20	4,089	36	75	43	-N020
	4,1		4,1	36	75	43	-4.1
	4,15		4,15	36	75	43	-4.15
	4,2		4,2	36	75	43	-4.2
	4,216	No. 19	4,216	36	75	43	-N019
	4,25		4,25	36	75	43	-4.25
	4,3		4,3	39	80	47	-4.3
	4,305	No. 18	4,305	39	80	47	-N018
	4,35		4,35	39	80	47	-4.35
	4,366	11/64"	4,366	39	80	47	-11/64IN
	4,394	No. 17	4,394	39	80	47	-N017
	4,4		4,4	39	80	47	-4.4
	4,45		4,45	39	80	47	-4.45
	4,496	No. 16	4,496	39	80	47	-N016
	4,5		4,5	39	80	47	-4.5
	4,55		4,55	39	80	47	-4.55
	4,572	No. 15	4,572	39	80	47	-N015
	4,6		4,6	39	80	47	-4.6
	4,623	No. 14	4,623	39	80	47	-N014
	4,65		4,65	39	80	47	-4.65
	4,699	No. 13	4,699	39	80	47	-N013
	4,7		4,7	39	80	47	-4.7
	4,75		4,75	39	80	47	-4.75
	4,763	3/16"	4,763	44	86	52	-3/16IN
	4,8		4,8	44	86	52	-4.8
	4,801	No. 12	4,801	44	86	52	-N012
4,85		4,85	44	86	52	-4.85	
4,851	No. 11	4,851	44	86	52	-N011	
4,9		4,9	44	86	52	-4.9	
4,915	No. 10	4,915	44	86	52	-N010	
4,95		4,95	44	86	52	-4.95	
4,978	No. 9	4,978	44	86	52	-N09	
5		5	44	86	52	-5	
5,05		5,05	44	86	52	-5.05	
5,055	No. 8	5,055	44	86	52	-N08	
5,1		5,1	44	86	52	-5.1	
5,105	No. 7	5,105	44	86	52	-N07	
5,15		5,15	44	86	52	-5.15	
5,159	13/64"	5,159	44	86	52	-13/64IN	
5,182	No. 6	5,182	44	86	52	-N06	
5,2		5,2	44	86	52	-5.2	
5,22	No. 5	5,22	44	86	52	-N05	
5,25		5,25	44	86	52	-5.25	
5,3		5,3	44	86	52	-5.3	
5,309	No. 4	5,309	48	93	57	-N04	
5,4		5,4	48	93	57	-5.4	
5,41	No. 3	5,41	48	93	57	-N03	
5,5		5,5	48	93	57	-5.5	
5,55		5,55	48	93	57	-5.55	
5,556	7/32"	5,556	48	93	57	-7/32IN	
5,6		5,6	48	93	57	-5.6	
5,613	No. 2	5,613	48	93	57	-N02	
5,7		5,7	48	93	57	-5.7	

Continued



Jobber drill A1211



~ 8 x D_c

Continued

	P	M	K	N	S	H	O
uncoated	●●	●	●●	●●	●		●●

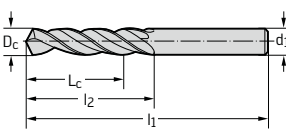
DIN 338	D _c h8 mm	D _c Inches/No	d ₁ f11 mm	L _c mm	l ₁ mm	l ₂ mm	Designation A1211
Cylindrical shank	5,75		5,75	48	93	57	-5.75
	5,791	No. 1	5,791	48	93	57	-N01
	5,8		5,8	48	93	57	-5.8
	5,9		5,9	48	93	57	-5.9
	5,944	Let.A	5,944	48	93	57	-LET.A
	5,95		5,95	48	93	57	-5.95
	5,953	15/64"	5,953	48	93	57	-15/64IN
	6		6	48	93	57	-6
	6,045	Let.B	6,045	52	101	63	-LET.B
	6,05		6,05	52	101	63	-6.05
	6,1		6,1	52	101	63	-6.1
	6,147	Let.C	6,147	52	101	63	-LET.C
	6,15		6,15	52	101	63	-6.15
	6,2		6,2	52	101	63	-6.2
	6,248	Let.D	6,248	52	101	63	-LET.D
	6,25		6,25	52	101	63	-6.25
	6,3		6,3	52	101	63	-6.3
	6,35	1/4"	6,35	52	101	63	-1/4IN
	6,4		6,4	52	101	63	-6.4
	6,45		6,45	52	101	63	-6.45
	6,5		6,5	52	101	63	-6.5
	6,528	Let.F	6,528	52	101	63	-LET.F
	6,55		6,55	52	101	63	-6.55
	6,6		6,6	52	101	63	-6.6
	6,629	Let.G	6,629	52	101	63	-LET.G
	6,65		6,65	52	101	63	-6.65
	6,7		6,7	52	101	63	-6.7
	6,747	17/64"	6,747	57	109	69	-17/64IN
	6,75		6,75	57	109	69	-6.75
	6,756	Let.H	6,756	57	109	69	-LET.H
	6,8		6,8	57	109	69	-6.8
	6,9		6,9	57	109	69	-6.9
	6,909	Let.I	6,909	57	109	69	-LET.I
	7		7	57	109	69	-7
	7,036	Let.J	7,036	57	109	69	-LET.J
	7,05		7,05	57	109	69	-7.05
	7,1		7,1	57	109	69	-7.1
	7,137	Let.K	7,137	57	109	69	-LET.K
	7,144	9/32"	7,144	57	109	69	-9/32IN
	7,2		7,2	57	109	69	-7.2
	7,25		7,25	57	109	69	-7.25
	7,3		7,3	57	109	69	-7.3
	7,366	Let.L	7,366	57	109	69	-LET.L
	7,4		7,4	57	109	69	-7.4
	7,493	Let.M	7,493	57	109	69	-LET.M
	7,5		7,5	57	109	69	-7.5
	7,541	19/64"	7,541	62	117	75	-19/64IN
	7,6		7,6	62	117	75	-7.6
	7,671	Let.N	7,671	62	117	75	-LET.N
	7,7		7,7	62	117	75	-7.7
	7,75		7,75	62	117	75	-7.75
	7,8		7,8	62	117	75	-7.8
	7,9		7,9	62	117	75	-7.9

Continued



Jobber drill A1211



~ 8 x D_c

Continued

	P	M	K	N	S	H	O
uncoated	●●	●	●●	●●	●		●●

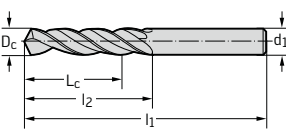
DIN 338	D _c h8 mm	D _c Inches/No	d ₁ f11 mm	L _c mm	l ₁ mm	l ₂ mm	Designation A1211
Cylindrical shank	7,938	5/16"	7,938	62	117	75	-5/16IN
	8		8	62	117	75	-8
	8,026	Let.O	8,026	62	117	75	-LET.O
	8,05		8,05	62	117	75	-8.05
	8,1		8,1	62	117	75	-8.1
	8,2		8,2	62	117	75	-8.2
	8,204	Let.P	8,204	62	117	75	-LET.P
	8,25		8,25	62	117	75	-8.25
	8,3		8,3	62	117	75	-8.3
	8,334	21/64"	8,334	62	117	75	-21/64IN
	8,4		8,4	62	117	75	-8.4
	8,433	Let.Q	8,433	62	117	75	-LET.Q
	8,5		8,5	62	117	75	-8.5
	8,6		8,6	66	125	81	-8.6
	8,611	Let.R	8,611	66	125	81	-LET.R
	8,7		8,7	66	125	81	-8.7
	8,731	11/32"	8,731	66	125	81	-11/32IN
	8,75		8,75	66	125	81	-8.75
	8,8		8,8	66	125	81	-8.8
	8,839	Let.S	8,839	66	125	81	-LET.S
	8,9		8,9	66	125	81	-8.9
	9		9	66	125	81	-9
	9,093	Let.T	9,093	66	125	81	-LET.T
	9,1		9,1	66	125	81	-9.1
	9,128	23/64"	9,128	66	125	81	-23/64IN
	9,2		9,2	66	125	81	-9.2
	9,25		9,25	66	125	81	-9.25
	9,3		9,3	66	125	81	-9.3
	9,347	Let.U	9,347	66	125	81	-LET.U
	9,4		9,4	66	125	81	-9.4
	9,5		9,5	66	125	81	-9.5
	9,525	3/8"	9,525	71	133	87	-3/8IN
	9,576	Let.V	9,576	71	133	87	-LET.V
	9,6		9,6	71	133	87	-9.6
	9,7		9,7	71	133	87	-9.7
	9,75		9,75	71	133	87	-9.75
	9,8		9,8	71	133	87	-9.8
	9,804	Let.W	9,804	71	133	87	-LET.W
	9,9		9,9	71	133	87	-9.9
	9,922	25/64"	9,922	71	133	87	-25/64IN
	10		10	71	133	87	-10
	10,084	Let.X	10,084	71	133	87	-LET.X
	10,1		10,1	71	133	87	-10.1
	10,2		10,2	71	133	87	-10.2
	10,25		10,25	71	133	87	-10.25
	10,262	Let.Y	10,262	71	133	87	-LET.Y
	10,3		10,3	71	133	87	-10.3
	10,319	13/32"	10,319	71	133	87	-13/32IN
	10,4		10,4	71	133	87	-10.4
	10,49	Let.Z	10,49	71	133	87	-LET.Z
	10,5		10,5	71	133	87	-10.5
	10,6		10,6	71	133	87	-10.6
	10,7		10,7	76	142	94	-10.7
	10,716	27/64"	10,716	76	142	94	-27/64IN
	10,75		10,75	76	142	94	-10.75

Continued



Jobber drill A1211



~ 8 x D_c

Continued

	P	M	K	N	S	H	O
uncoated	●●	●	●●	●●	●		●●

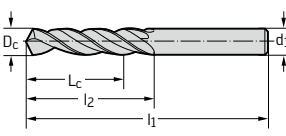
DIN 338	D _c h8 mm	D _c Inches/No	d ₁ f11 mm	L _c mm	l ₁ mm	l ₂ mm	Designation A1211
Cylindrical shank 	10,8		10,8	76	142	94	-10.8
	10,9		10,9	76	142	94	-10.9
	11		11	76	142	94	-11
	11,1		11,1	76	142	94	-11.1
	11,113	7/16"	11,113	76	142	94	-7/16IN
	11,2		11,2	76	142	94	-11.2
	11,25		11,25	76	142	94	-11.25
	11,3		11,3	76	142	94	-11.3
	11,4		11,4	76	142	94	-11.4
	11,5		11,5	76	142	94	-11.5
	11,509	29/64"	11,509	76	142	94	-29/64IN
	11,6		11,6	76	142	94	-11.6
	11,7		11,7	76	142	94	-11.7
	11,75		11,75	76	142	94	-11.75
	11,8		11,8	76	142	94	-11.8
	11,9		11,9	87	151	101	-11.9
	11,906	15/32"	11,906	87	151	101	-15/32IN
	12		12	87	151	101	-12
	12,1		12,1	87	151	101	-12.1
	12,2		12,2	87	151	101	-12.2
	12,25		12,25	87	151	101	-12.25
	12,3		12,3	87	151	101	-12.3
	12,303	31/64"	12,303	87	151	101	-31/64IN
	12,4		12,4	87	151	101	-12.4
	12,5		12,5	87	151	101	-12.5
	12,6		12,6	87	151	101	-12.6
	12,7	1/2"	12,7	87	151	101	-1/2IN
	12,75		12,75	87	151	101	-12.75
12,8		12,8	87	151	101	-12.8	
12,9		12,9	87	151	101	-12.9	
13		13	87	151	101	-13	
13,097	33/64"	13,097	87	151	101	-33/64IN	
13,1		13,1	87	151	101	-13.1	
13,2		13,2	87	151	101	-13.2	
13,25		13,25	94	160	108	-13.25	
13,3		13,3	94	160	108	-13.3	
13,4		13,4	94	160	108	-13.4	
13,494	17/32"	13,494	94	160	108	-17/32IN	
13,5		13,5	94	160	108	-13.5	
13,6		13,6	94	160	108	-13.6	
13,7		13,7	94	160	108	-13.7	
13,75		13,75	94	160	108	-13.75	
13,8		13,8	94	160	108	-13.8	
13,891	35/64"	13,891	94	160	108	-35/64IN	
13,9		13,9	94	160	108	-13.9	
14		14	94	160	108	-14	
14,1		14,1	99	169	114	-14.1	
14,2		14,2	99	169	114	-14.2	
14,25		14,25	99	169	114	-14.25	
14,288	9/16"	14,288	99	169	114	-9/16IN	
14,3		14,3	99	169	114	-14.3	
14,5		14,5	99	169	114	-14.5	
14,684	37/64"	14,684	99	169	114	-37/64IN	
14,75		14,75	99	169	114	-14.75	

Continued



Jobber drill A1211



~ 8 x D_c

Continued

	P	M	K	N	S	H	O
uncoated	●●	●	●●	●●	●		●●

DIN 338	D _c h8 mm	D _c Inches/No	d ₁ f11 mm	L _c mm	l ₁ mm	l ₂ mm	Designation A1211
Cylindrical shank 	15		15	99	169	114	-15
	15,081	19/32"	15,081	104	178	120	-19/32IN
	15,2		15,2	104	178	120	-15.2
	15,25		15,25	104	178	120	-15.25
	15,478	39/64"	15,478	104	178	120	-39/64IN
	15,5		15,5	104	178	120	-15.5
	15,75		15,75	104	178	120	-15.75
	15,875	5/8"	15,875	104	178	120	-5/8IN
	16		16	104	178	120	-16
	16,272	41/64"	16,272	108	184	125	-41/64IN
	16,5		16,5	108	184	125	-16.5
	16,669	21/32"	16,669	108	184	125	-21/32IN
	17		17	108	184	125	-17
	17,066	43/64"	17,066	112	191	130	-43/64IN
	17,463	11/16"	17,463	112	191	130	-11/16IN
	17,5		17,5	112	191	130	-17.5
	18		18	112	191	130	-18
	18,5		18,5	116	198	135	-18.5
	19		19	116	198	135	-19
	19,5		19,5	120	205	140	-19.5
	20		20	120	205	140	-20
	21		21	123	213	145	-21
22		22	127	221	150	-22	



Jobber drill A1211TIN



~ 8 x D_c

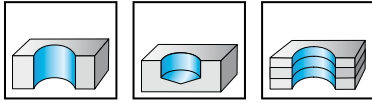

- HSS - TiN
- Type N
- right-hand cutting
- 118° point angle
- available as set

	P	M	K	N	S	H	O
TiN	●●	●	●●	●●			●●

DIN 338	D _c h8 mm	d ₁ f11 mm	L _c mm	l ₁ mm	l ₂ mm	Designation A1211TIN
Cylindrical shank	0,5	0,5	5,2	22	6	-0.5
	0,6	0,6	6,1	24	7	-0.6
	0,7	0,7	7,8	28	9	-0.7
	0,8	0,8	8,7	30	10	-0.8
	0,9	0,9	9,5	32	11	-0.9
	1	1	10	34	12	-1
	1,1	1,1	12	36	14	-1.1
	1,2	1,2	14	38	16	-1.2
	1,3	1,3	14	38	16	-1.3
	1,4	1,4	15	40	18	-1.4
	1,5	1,5	15	40	18	-1.5
	1,6	1,6	17	43	20	-1.6
	1,7	1,7	17	43	20	-1.7
	1,8	1,8	19	46	22	-1.8
	1,9	1,9	19	46	22	-1.9
	2	2	20	49	24	-2
	2,1	2,1	20	49	24	-2.1
	2,2	2,2	23	53	27	-2.2
	2,3	2,3	23	53	27	-2.3
	2,4	2,4	26	57	30	-2.4
	2,5	2,5	26	57	30	-2.5
	2,6	2,6	26	57	30	-2.6
	2,7	2,7	28	61	33	-2.7
	2,8	2,8	28	61	33	-2.8
	2,9	2,9	28	61	33	-2.9
	3	3	28	61	33	-3
	3,1	3,1	30	65	36	-3.1
	3,2	3,2	30	65	36	-3.2
	3,3	3,3	30	65	36	-3.3
	3,4	3,4	33	70	39	-3.4
	3,5	3,5	33	70	39	-3.5
	3,6	3,6	33	70	39	-3.6
	3,7	3,7	33	70	39	-3.7
	3,8	3,8	36	75	43	-3.8
	3,9	3,9	36	75	43	-3.9
	4	4	36	75	43	-4
	4,1	4,1	36	75	43	-4.1
	4,2	4,2	36	75	43	-4.2
	4,3	4,3	39	80	47	-4.3
	4,4	4,4	39	80	47	-4.4
	4,5	4,5	39	80	47	-4.5
	4,6	4,6	39	80	47	-4.6
	4,7	4,7	39	80	47	-4.7
	4,8	4,8	44	86	52	-4.8
	4,9	4,9	44	86	52	-4.9
	5	5	44	86	52	-5
	5,1	5,1	44	86	52	-5.1
	5,2	5,2	44	86	52	-5.2
	5,3	5,3	44	86	52	-5.3
	5,4	5,4	48	93	57	-5.4

Continued

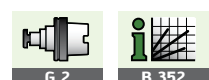

Jobber drill A1211TIN



~ 8 x D_c

Continued

TiN	P	M	K	N	S	H	O
	●●	●	●●	●●			●●

DIN 338	D _c h8 mm	d ₁ f11 mm	L _c mm	l ₁ mm	l ₂ mm	Designation A1211TIN
Cylindrical shank 	5,5	5,5	48	93	57	-5.5
	5,6	5,6	48	93	57	-5.6
	5,7	5,7	48	93	57	-5.7
	5,8	5,8	48	93	57	-5.8
	5,9	5,9	48	93	57	-5.9
	6	6	48	93	57	-6
	6,1	6,1	52	101	63	-6.1
	6,2	6,2	52	101	63	-6.2
	6,3	6,3	52	101	63	-6.3
	6,4	6,4	52	101	63	-6.4
	6,5	6,5	52	101	63	-6.5
	6,6	6,6	52	101	63	-6.6
	6,7	6,7	52	101	63	-6.7
	6,8	6,8	57	109	69	-6.8
	6,9	6,9	57	109	69	-6.9
	7	7	57	109	69	-7
7,1	7,1	57	109	69	-7.1	
7,2	7,2	57	109	69	-7.2	
7,3	7,3	57	109	69	-7.3	
7,4	7,4	57	109	69	-7.4	
7,5	7,5	57	109	69	-7.5	
7,6	7,6	62	117	75	-7.6	
7,7	7,7	62	117	75	-7.7	
7,8	7,8	62	117	75	-7.8	
7,9	7,9	62	117	75	-7.9	
8	8	62	117	75	-8	
8,1	8,1	62	117	75	-8.1	
8,2	8,2	62	117	75	-8.2	
8,3	8,3	62	117	75	-8.3	
8,4	8,4	62	117	75	-8.4	
8,5	8,5	62	117	75	-8.5	
8,6	8,6	66	125	81	-8.6	
8,7	8,7	66	125	81	-8.7	
8,8	8,8	66	125	81	-8.8	
8,9	8,9	66	125	81	-8.9	
9	9	66	125	81	-9	
9,1	9,1	66	125	81	-9.1	
9,2	9,2	66	125	81	-9.2	
9,3	9,3	66	125	81	-9.3	
9,4	9,4	66	125	81	-9.4	
9,5	9,5	66	125	81	-9.5	
9,6	9,6	71	133	87	-9.6	
9,7	9,7	71	133	87	-9.7	
9,8	9,8	71	133	87	-9.8	
9,9	9,9	71	133	87	-9.9	
10	10	71	133	87	-10	
10,2	10,2	71	133	87	-10.2	
10,5	10,5	71	133	87	-10.5	
11	11	76	142	94	-11	
11,5	11,5	76	142	94	-11.5	
12	12	87	151	101	-12	
12,5	12,5	87	151	101	-12.5	
13	13	87	151	101	-13	
13,5	13,5	94	160	108	-13.5	
14	14	94	160	108	-14	
14,5	14,5	99	169	114	-14.5	
15	15	99	169	114	-15	
16	16	104	178	120	-16	



Jobber drill A1212



~ 8 x D_c

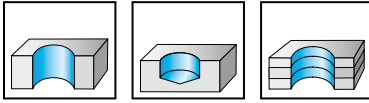

- HSS - uncoated
- Type H
- right-hand cutting
- 118° point angle

	P	M	K	N	S	H	O
uncoated				●●			●●

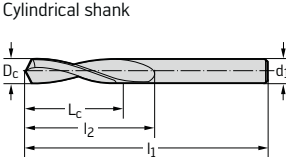
DIN 338	D _c h8 mm	d ₁ f11 mm	L _c mm	l ₁ mm	l ₂ mm	Designation A1212
Cylindrical shank 	0,4	0,4	4,2	20	5	-0,4
	0,5	0,5	5,2	22	6	-0,5
	0,55	0,55	6,1	24	7	-0,55
	0,6	0,6	6,1	24	7	-0,6
	0,7	0,7	7,8	28	9	-0,7
	0,75	0,75	7,8	28	9	-0,75
	0,8	0,8	8,7	30	10	-0,8
	0,9	0,9	9,5	32	11	-0,9
	1	1	10	34	12	-1
	1,05	1,05	10	34	12	-1,05
	1,1	1,1	12	36	14	-1,1
	1,15	1,15	12	36	14	-1,15
	1,2	1,2	14	38	16	-1,2
	1,25	1,25	14	38	16	-1,25
	1,3	1,3	14	38	16	-1,3
	1,4	1,4	15	40	18	-1,4
	1,5	1,5	15	40	18	-1,5
	1,55	1,55	17	43	20	-1,55
	1,6	1,6	17	43	20	-1,6
	1,7	1,7	17	43	20	-1,7
	1,8	1,8	19	46	22	-1,8
	1,85	1,85	19	46	22	-1,85
	1,9	1,9	19	46	22	-1,9
	2	2	20	49	24	-2
	2,05	2,05	20	49	24	-2,05
	2,1	2,1	20	49	24	-2,1
	2,15	2,15	23	53	27	-2,15
	2,2	2,2	23	53	27	-2,2
2,3	2,3	23	53	27	-2,3	
2,4	2,4	26	57	30	-2,4	
2,5	2,5	26	57	30	-2,5	
2,55	2,55	26	57	30	-2,55	
2,6	2,6	26	57	30	-2,6	
2,7	2,7	28	61	33	-2,7	
2,75	2,75	28	61	33	-2,75	
2,8	2,8	28	61	33	-2,8	
2,9	2,9	28	61	33	-2,9	
3	3	28	61	33	-3	
3,1	3,1	30	65	36	-3,1	
3,2	3,2	30	65	36	-3,2	
3,3	3,3	30	65	36	-3,3	
3,35	3,35	30	65	36	-3,35	
3,4	3,4	33	70	39	-3,4	
3,5	3,5	33	70	39	-3,5	
3,6	3,6	33	70	39	-3,6	
3,65	3,65	33	70	39	-3,65	
3,7	3,7	33	70	39	-3,7	

Continued



Jobber drill A1212



~ 8 x D_c

Continued

	P	M	K	N	S	H	O
uncoated				●●			●●

DIN 338	D _c h8 mm	d ₁ f11 mm	L _c mm	l ₁ mm	l ₂ mm	Designation A1212
Cylindrical shank	3,8	3,8	36	75	43	-3.8
	3,85	3,85	36	75	43	-3.85
	3,9	3,9	36	75	43	-3.9
	4	4	36	75	43	-4
	4,1	4,1	36	75	43	-4.1
	4,2	4,2	36	75	43	-4.2
	4,3	4,3	39	80	47	-4.3
	4,4	4,4	39	80	47	-4.4
	4,5	4,5	39	80	47	-4.5
	4,6	4,6	39	80	47	-4.6
	4,7	4,7	39	80	47	-4.7
	4,8	4,8	44	86	52	-4.8
	4,9	4,9	44	86	52	-4.9
	5	5	44	86	52	-5
	5,1	5,1	44	86	52	-5.1
	5,2	5,2	44	86	52	-5.2
	5,3	5,3	44	86	52	-5.3
	5,4	5,4	48	93	57	-5.4
	5,5	5,5	48	93	57	-5.5
	5,6	5,6	48	93	57	-5.6
	5,7	5,7	48	93	57	-5.7
	5,8	5,8	48	93	57	-5.8
	5,9	5,9	48	93	57	-5.9
	6	6	48	93	57	-6
	6,1	6,1	52	101	63	-6.1
	6,2	6,2	52	101	63	-6.2
	6,3	6,3	52	101	63	-6.3
	6,4	6,4	52	101	63	-6.4
	6,5	6,5	52	101	63	-6.5
	6,6	6,6	52	101	63	-6.6
	6,7	6,7	52	101	63	-6.7
	6,8	6,8	57	109	69	-6.8
	6,9	6,9	57	109	69	-6.9
	7	7	57	109	69	-7
	7,1	7,1	57	109	69	-7.1
	7,2	7,2	57	109	69	-7.2
	7,3	7,3	57	109	69	-7.3
	7,4	7,4	57	109	69	-7.4
	7,5	7,5	57	109	69	-7.5
	7,6	7,6	62	117	75	-7.6
	7,7	7,7	62	117	75	-7.7
	7,8	7,8	62	117	75	-7.8
	7,9	7,9	62	117	75	-7.9
	8	8	62	117	75	-8
	8,1	8,1	62	117	75	-8.1
	8,2	8,2	62	117	75	-8.2
	8,3	8,3	62	117	75	-8.3
	8,4	8,4	62	117	75	-8.4
	8,5	8,5	62	117	75	-8.5
	8,8	8,8	66	125	81	-8.8
	9	9	66	125	81	-9
	9,1	9,1	66	125	81	-9.1
	9,5	9,5	66	125	81	-9.5
	9,8	9,8	71	133	87	-9.8
	10	10	71	133	87	-10

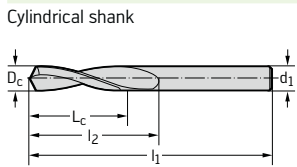

Continued

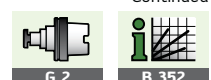

Jobber drill A1212



~ 8 x D_c

Continued

	P	M	K	N	S	H	O
uncoated				●●			●●

DIN 338	D _c h8 mm	d ₁ f11 mm	L _c mm	l ₁ mm	l ₂ mm	Designation A1212
Cylindrical shank 	10,5	10,5	71	133	87	-10.5
	11	11	76	142	94	-11
	11,5	11,5	76	142	94	-11.5
	12	12	87	151	101	-12
	12,5	12,5	87	151	101	-12.5
	13	13	87	151	101	-13
	14	14	94	160	108	-14
	15	15	99	169	114	-15
	16	16	104	178	120	-16

Deep-hole twist drill A1222 UFL®



~ 8 x D_c

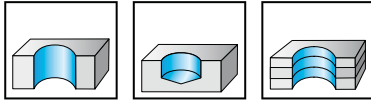

- HSS - Fibre-steamed
- Type UFL®
- right-hand cutting
- 130° point angle
- up to 1.9 mm bright finish
- available as set

	P	M	K	N	S	H	O
uncoated	●●	●	●●	●●	●		●●

DIN 338	D _c h8 mm	D _c Inches/No	d ₁ f11 mm	L _c mm	l ₁ mm	l ₂ mm	Designation A1222
Cylindrical shank 	1		1	10	34	12	-1
	1,016	No. 60	1,016	10	34	12	-NO60
	1,041	No. 59	1,041	10	34	12	-NO59
	1,067	No. 58	1,067	12	36	14	-NO58
	1,092	No. 57	1,092	12	36	14	-NO57
	1,1		1,1	12	36	14	-1.1
	1,181	No. 56	1,181	14	38	16	-NO56
	1,191	3/64"	1,191	14	38	16	-3/64IN
	1,2		1,2	14	38	16	-1.2
	1,25		1,25	14	38	16	-1.25
	1,3		1,3	14	38	16	-1.3
	1,321	No. 55	1,321	15	40	18	-NO55
	1,397	No. 54	1,397	15	40	18	-NO54
	1,4		1,4	15	40	18	-1.4
	1,5		1,5	15	40	18	-1.5
	1,511	No. 53	1,511	17	43	20	-NO53
	1,588	1/16"	1,588	17	43	20	-1/16IN
	1,6		1,6	17	43	20	-1.6
	1,613	No. 52	1,613	17	43	20	-NO52
	1,7		1,7	17	43	20	-1.7
	1,702	No. 51	1,702	19	46	22	-NO51
	1,778	No. 50	1,778	19	46	22	-NO50
	1,8		1,8	19	46	22	-1.8
	1,854	No. 49	1,854	19	46	22	-NO49
	1,9		1,9	19	46	22	-1.9
	1,93	No. 48	1,93	20	49	24	-NO48
	1,984	5/64"	1,984	20	49	24	-5/64IN
	1,994	No. 47	1,994	20	49	24	-NO47
	2		2	20	49	24	-2
	2,057	No. 46	2,057	20	49	24	-NO46
	2,083	No. 45	2,083	20	49	24	-NO45
	2,1		2,1	20	49	24	-2.1
	2,184	No. 44	2,184	23	53	27	-NO44
2,2		2,2	23	53	27	-2.2	
2,261	No. 43	2,261	23	53	27	-NO43	
2,3		2,3	23	53	27	-2.3	
2,375	No. 42	2,375	26	57	30	-NO42	
2,381	3/32"	2,381	26	57	30	-3/32IN	
2,4		2,4	26	57	30	-2.4	
2,438	No. 41	2,438	26	57	30	-NO41	
2,489	No. 40	2,489	26	57	30	-NO40	
2,5		2,5	26	57	30	-2.5	
2,527	No. 39	2,527	26	57	30	-NO39	
2,578	No. 38	2,578	26	57	30	-NO38	
2,6		2,6	26	57	30	-2.6	
2,642	No. 37	2,642	26	57	30	-NO37	
2,7		2,7	28	61	33	-2.7	

Continued



Deep-hole twist drill

A1222

UFL®

~ 8 x D_c



Continued

	P	M	K	N	S	H	O
uncoated	●●	●	●●	●●	●		●●

DIN 338	D _c h8 mm	D _c Inches/No	d ₁ f11 mm	L _c mm	l ₁ mm	l ₂ mm	Designation A1222
Cylindrical shank 	2,705	No. 36	2,705	28	61	33	-N036
	2,778	7/64"	2,778	28	61	33	-7/64IN
	2,794	No. 35	2,794	28	61	33	-N035
	2,8		2,8	28	61	33	-2.8
	2,819	No. 34	2,819	28	61	33	-N034
	2,87	No. 33	2,87	28	61	33	-N033
	2,9		2,9	28	61	33	-2.9
	2,946	No. 32	2,946	28	61	33	-N032
	3		3	28	61	33	-3
	3,048	No. 31	3,048	30	65	36	-N031
	3,1		3,1	30	65	36	-3.1
	3,175	1/8"	3,175	30	65	36	-1/8IN
	3,2		3,2	30	65	36	-3.2
	3,264	No. 30	3,264	30	65	36	-N030
	3,3		3,3	30	65	36	-3.3
	3,4		3,4	33	70	39	-3.4
	3,454	No. 29	3,454	33	70	39	-N029
	3,5		3,5	33	70	39	-3.5
	3,569	No. 28	3,569	33	70	39	-N028
	3,572	9/64"	3,572	33	70	39	-9/64IN
	3,6		3,6	33	70	39	-3.6
	3,658	No. 27	3,658	33	70	39	-N027
	3,7		3,7	33	70	39	-3.7
	3,734	No. 26	3,734	33	70	39	-N026
	3,797	No. 25	3,797	36	75	43	-N025
	3,8		3,8	36	75	43	-3.8
	3,861	No. 24	3,861	36	75	43	-N024
	3,9		3,9	36	75	43	-3.9
3,912	No. 23	3,912	36	75	43	-N023	
3,969	5/32"	3,969	36	75	43	-5/32IN	
3,988	No. 22	3,988	36	75	43	-N022	
4		4	36	75	43	-4	
4,039	No. 21	4,039	36	75	43	-N021	
4,089	No. 20	4,089	36	75	43	-N020	
4,1		4,1	36	75	43	-4.1	
4,2		4,2	36	75	43	-4.2	
4,216	No. 19	4,216	36	75	43	-N019	
4,3		4,3	39	80	47	-4.3	
4,305	No. 18	4,305	39	80	47	-N018	
4,366	11/64"	4,366	39	80	47	-11/64IN	
4,394	No. 17	4,394	39	80	47	-N017	
4,4		4,4	39	80	47	-4.4	
4,496	No. 16	4,496	39	80	47	-N016	
4,5		4,5	39	80	47	-4.5	
4,572	No. 15	4,572	39	80	47	-N015	
4,6		4,6	39	80	47	-4.6	
4,623	No. 14	4,623	39	80	47	-N014	
4,699	No. 13	4,699	39	80	47	-N013	
4,7		4,7	39	80	47	-4.7	
4,763	3/16"	4,763	44	86	52	-3/16IN	
4,8		4,8	44	86	52	-4.8	
4,801	No. 12	4,801	44	86	52	-N012	
4,851	No. 11	4,851	44	86	52	-N011	
4,9		4,9	44	86	52	-4.9	
4,915	No. 10	4,915	44	86	52	-N010	

Continued



Deep-hole twist drill A1222 UFL®



~ 8 x D_c

	P	M	K	N	S	H	O
uncoated	●●	●	●●	●●	●		●●

Continued

DIN 338	D _c h8 mm	D _c Inches/No	d ₁ f11 mm	L _c mm	l ₁ mm	l ₂ mm	Designation A1222
Cylindrical shank 	4,978	No. 9	4,978	44	86	52	-N09
	5		5	44	86	52	-5
	5,055	No. 8	5,055	44	86	52	-N08
	5,1		5,1	44	86	52	-5.1
	5,105	No. 7	5,105	44	86	52	-N07
	5,159	13/64"	5,159	44	86	52	-13/64IN
	5,182	No. 6	5,182	44	86	52	-N06
	5,2		5,2	44	86	52	-5.2
	5,22	No. 5	5,22	44	86	52	-N05
	5,3		5,3	44	86	52	-5.3
	5,309	No. 4	5,309	48	93	57	-N04
	5,4		5,4	48	93	57	-5.4
	5,41	No. 3	5,41	48	93	57	-N03
	5,5		5,5	48	93	57	-5.5
	5,556	7/32"	5,556	48	93	57	-7/32IN
	5,6		5,6	48	93	57	-5.6
	5,613	No. 2	5,613	48	93	57	-N02
	5,7		5,7	48	93	57	-5.7
	5,791	No. 1	5,791	48	93	57	-N01
	5,8		5,8	48	93	57	-5.8
	5,9		5,9	48	93	57	-5.9
	5,944	Let.A	5,944	48	93	57	-LET.A
	5,953	15/64"	5,953	48	93	57	-15/64IN
	6		6	48	93	57	-6
	6,045	Let.B	6,045	52	101	63	-LET.B
	6,1		6,1	52	101	63	-6.1
	6,147	Let.C	6,147	52	101	63	-LET.C
	6,2		6,2	52	101	63	-6.2
6,248	Let.D	6,248	52	101	63	-LET.D	
6,3		6,3	52	101	63	-6.3	
6,35	1/4"/Let.E	6,35	52	101	63	-1/4IN	
6,4		6,4	52	101	63	-6.4	
6,5		6,5	52	101	63	-6.5	
6,528	Let.F	6,528	52	101	63	-LET.F	
6,6		6,6	52	101	63	-6.6	
6,629	Let.G	6,629	52	101	63	-LET.G	
6,7		6,7	52	101	63	-6.7	
6,747	17/64"	6,747	57	109	69	-17/64IN	
6,756	Let.H	6,756	57	109	69	-LET.H	
6,8		6,8	57	109	69	-6.8	
6,9		6,9	57	109	69	-6.9	
6,909	Let.I	6,909	57	109	69	-LET.I	
7		7	57	109	69	-7	
7,036	Let.J	7,036	57	109	69	-LET.J	
7,1		7,1	57	109	69	-7.1	
7,137	Let.K	7,137	57	109	69	-LET.K	
7,144	9/32"	7,144	57	109	69	-9/32IN	
7,2		7,2	57	109	69	-7.2	
7,3		7,3	57	109	69	-7.3	
7,366	Let.L	7,366	57	109	69	-LET.L	
7,4		7,4	57	109	69	-7.4	
7,493	Let.M	7,493	57	109	69	-LET.M	
7,5		7,5	57	109	69	-7.5	
7,541	19/64"	7,541	62	117	75	-19/64IN	

Continued



Deep-hole twist drill

A1222

UFL®

~ 8 x D_c



Continued

	P	M	K	N	S	H	O
uncoated	●●	●	●●	●●	●		●●

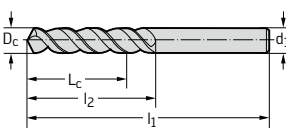
DIN 338	D _c h8 mm	D _c Inches/No	d ₁ f11 mm	L _c mm	l ₁ mm	l ₂ mm	Designation A1222
Cylindrical shank 	7,6		7,6	62	117	75	-7.6
	7,671	Let.N	7,671	62	117	75	-LET.N
	7,7		7,7	62	117	75	-7.7
	7,8		7,8	62	117	75	-7.8
	7,9		7,9	62	117	75	-7.9
	7,938	5/16"	7,938	62	117	75	-5/16IN
	8		8	62	117	75	-8
	8,026	Let.O	8,026	62	117	75	-LET.O
	8,1		8,1	62	117	75	-8.1
	8,2		8,2	62	117	75	-8.2
	8,204	Let.P	8,204	62	117	75	-LET.P
	8,3		8,3	62	117	75	-8.3
	8,334	21/64"	8,334	62	117	75	-21/64IN
	8,4		8,4	62	117	75	-8.4
	8,433	Let.Q	8,433	62	117	75	-LET.Q
	8,5		8,5	62	117	75	-8.5
	8,6		8,6	66	125	81	-8.6
	8,611	Let.R	8,611	66	125	81	-LET.R
8,7		8,7	66	125	81	-8.7	
8,731	11/32"	8,731	66	125	81	-11/32IN	
8,8		8,8	66	125	81	-8.8	
8,839	Let.S	8,839	66	125	81	-LET.S	
8,9		8,9	66	125	81	-8.9	
9		9	66	125	81	-9	
9,093	Let.T	9,093	66	125	81	-LET.T	
9,1		9,1	66	125	81	-9.1	
9,128	23/64"	9,128	66	125	81	-23/64IN	
9,2		9,2	66	125	81	-9.2	
9,3		9,3	66	125	81	-9.3	
9,347	Let.U	9,347	66	125	81	-LET.U	
9,4		9,4	66	125	81	-9.4	
9,5		9,5	66	125	81	-9.5	
9,525	3/8"	9,525	71	133	87	-3/8IN	
9,576	Let.V	9,576	71	133	87	-LET.V	
9,6		9,6	71	133	87	-9.6	
9,7		9,7	71	133	87	-9.7	
9,8		9,8	71	133	87	-9.8	
9,804	Let.W	9,804	71	133	87	-LET.W	
9,9		9,9	71	133	87	-9.9	
9,922	25/64"	9,922	71	133	87	-25/64IN	
10		10	71	133	87	-10	
10,084	Let.X	10,084	71	133	87	-LET.X	
10,2		10,2	71	133	87	-10.2	
10,262	Let.Y	10,262	71	133	87	-LET.Y	
10,319	13/32"	10,319	71	133	87	-13/32IN	
10,49	Let.Z	10,49	71	133	87	-LET.Z	
10,5		10,5	71	133	87	-10.5	
10,716	27/64"	10,716	76	142	94	-27/64IN	
10,8		10,8	76	142	94	-10.8	
11		11	76	142	94	-11	
11,113	7/16"	11,113	76	142	94	-7/16IN	
11,2		11,2	76	142	94	-11.2	
11,5		11,5	76	142	94	-11.5	
11,509	29/64"	11,509	76	142	94	-29/64IN	
11,8		11,8	76	142	94	-11.8	

Continued



Deep-hole twist drill

A1222

UFL®



~ 8 x D_c

	P	M	K	N	S	H	O
uncoated	●●	●	●●	●●	●		●●

Continued

DIN 338	D _c h8 mm	D _c Inches/No	d ₁ f11 mm	L _c mm	l ₁ mm	l ₂ mm	Designation A1222
Cylindrical shank 	11,906	15/32"	11,906	87	151	101	-15/32IN
	12		12	87	151	101	-12
	12,303	31/64"	12,303	87	151	101	-31/64IN
	12,5		12,5	87	151	101	-12.5
	12,7	1/2"	12,7	87	151	101	-1/2IN
	13		13	87	151	101	-13
	13,097	33/64"	13,097	87	151	101	-33/64IN
	13,1		13,1	87	151	101	-13.1
	13,3		13,3	94	160	108	-13.3
	13,494	17/32"	13,494	94	160	108	-17/32IN
	13,5		13,5	94	160	108	-13.5
	13,891	35/64"	13,891	94	160	108	-35/64IN
	14		14	94	160	108	-14
	14,288	9/16"	14,288	99	169	114	-9/16IN
	14,5		14,5	99	169	114	-14.5
	14,684	37/64"	14,684	99	169	114	-37/64IN
	15		15	99	169	114	-15
	15,081	19/32"	15,081	104	178	120	-19/32IN
15,1		15,1	104	178	120	-15.1	
15,3		15,3	104	178	120	-15.3	
15,478	39/64"	15,478	104	178	120	-39/64IN	
15,5		15,5	104	178	120	-15.5	
15,875	5/8"	15,875	104	178	120	-5/8IN	
16		16	104	178	120	-16	



Twist drill A1231



~ 8 x D_c

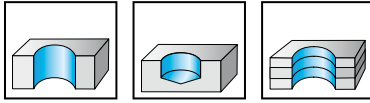

- HSS - steam treated
- Type N
- left-hand cutting
- 118° point angle
- up to 3 mm bright finish

	P	M	K	N	S	H	O
uncoated	●●	●	●●	●	●	●	●●

DIN 338	D _c h8 mm	d ₁ f11 mm	L _c mm	l ₁ mm	l ₂ mm	Designation A1231
Cylindrical shank 	0,2	0,2	2,1	19	2,5	-0,2
	0,25	0,25	2,5	19	3	-0,25
	0,3	0,3	2,5	19	3	-0,3
	0,35	0,35	3,4	19	4	-0,35
	0,4	0,4	4,2	20	5	-0,4
	0,45	0,45	4,2	20	5	-0,45
	0,5	0,5	5,2	22	6	-0,5
	0,55	0,55	6,1	24	7	-0,55
	0,6	0,6	6,1	24	7	-0,6
	0,65	0,65	6,9	26	8	-0,65
	0,7	0,7	7,8	28	9	-0,7
	0,75	0,75	7,8	28	9	-0,75
	0,8	0,8	8,7	30	10	-0,8
	0,85	0,85	8,7	30	10	-0,85
	0,9	0,9	9,5	32	11	-0,9
	0,95	0,95	9,5	32	11	-0,95
	1	1	10	34	12	-1
	1,05	1,05	10	34	12	-1,05
	1,1	1,1	12	36	14	-1,1
	1,15	1,15	12	36	14	-1,15
	1,2	1,2	14	38	16	-1,2
	1,25	1,25	14	38	16	-1,25
	1,3	1,3	14	38	16	-1,3
	1,35	1,35	15	40	18	-1,35
	1,4	1,4	15	40	18	-1,4
1,45	1,45	15	40	18	-1,45	
1,5	1,5	15	40	18	-1,5	
1,55	1,55	17	43	20	-1,55	
1,6	1,6	17	43	20	-1,6	
1,65	1,65	17	43	20	-1,65	
1,7	1,7	17	43	20	-1,7	
1,75	1,75	19	46	22	-1,75	
1,8	1,8	19	46	22	-1,8	
1,85	1,85	19	46	22	-1,85	
1,9	1,9	19	46	22	-1,9	
1,95	1,95	20	49	24	-1,95	
2	2	20	49	24	-2	
2,05	2,05	20	49	24	-2,05	
2,1	2,1	20	49	24	-2,1	
2,15	2,15	23	53	27	-2,15	
2,2	2,2	23	53	27	-2,2	
2,25	2,25	23	53	27	-2,25	
2,3	2,3	23	53	27	-2,3	
2,35	2,35	23	53	27	-2,35	
2,4	2,4	26	57	30	-2,4	
2,45	2,45	26	57	30	-2,45	
2,5	2,5	26	57	30	-2,5	

Continued



Twist drill A1231



~ 8 x D_c

Continued

	P	M	K	N	S	H	O
uncoated	●●		●●	●			●●

DIN 338	D _c h8 mm	d ₁ f11 mm	L _c mm	l ₁ mm	l ₂ mm	Designation A1231
Cylindrical shank 	2,55	2,55	26	57	30	-2,55
	2,6	2,6	26	57	30	-2,6
	2,65	2,65	26	57	30	-2,65
	2,7	2,7	28	61	33	-2,7
	2,75	2,75	28	61	33	-2,75
	2,8	2,8	28	61	33	-2,8
	2,85	2,85	28	61	33	-2,85
	2,9	2,9	28	61	33	-2,9
	2,95	2,95	28	61	33	-2,95
	3	3	28	61	33	-3
	3,05	3,05	30	65	36	-3,05
	3,1	3,1	30	65	36	-3,1
	3,15	3,15	30	65	36	-3,15
	3,2	3,2	30	65	36	-3,2
	3,25	3,25	30	65	36	-3,25
	3,3	3,3	30	65	36	-3,3
	3,35	3,35	30	65	36	-3,35
	3,4	3,4	33	70	39	-3,4
	3,45	3,45	33	70	39	-3,45
	3,5	3,5	33	70	39	-3,5
	3,55	3,55	33	70	39	-3,55
	3,6	3,6	33	70	39	-3,6
	3,65	3,65	33	70	39	-3,65
	3,7	3,7	33	70	39	-3,7
	3,75	3,75	33	70	39	-3,75
	3,8	3,8	36	75	43	-3,8
	3,85	3,85	36	75	43	-3,85
	3,9	3,9	36	75	43	-3,9
3,95	3,95	36	75	43	-3,95	
4	4	36	75	43	-4	
4,05	4,05	36	75	43	-4,05	
4,1	4,1	36	75	43	-4,1	
4,15	4,15	36	75	43	-4,15	
4,2	4,2	36	75	43	-4,2	
4,25	4,25	36	75	43	-4,25	
4,3	4,3	39	80	47	-4,3	
4,35	4,35	39	80	47	-4,35	
4,4	4,4	39	80	47	-4,4	
4,45	4,45	39	80	47	-4,45	
4,5	4,5	39	80	47	-4,5	
4,55	4,55	39	80	47	-4,55	
4,6	4,6	39	80	47	-4,6	
4,65	4,65	39	80	47	-4,65	
4,7	4,7	39	80	47	-4,7	
4,75	4,75	39	80	47	-4,75	
4,8	4,8	44	86	52	-4,8	
4,85	4,85	44	86	52	-4,85	
4,9	4,9	44	86	52	-4,9	
4,95	4,95	44	86	52	-4,95	
5	5	44	86	52	-5	
5,1	5,1	44	86	52	-5,1	
5,2	5,2	44	86	52	-5,2	
5,25	5,25	44	86	52	-5,25	
5,3	5,3	44	86	52	-5,3	
5,4	5,4	48	93	57	-5,4	

Continued



Twist drill A1231



~ 8 x D_c

Continued

	P	M	K	N	S	H	O
uncoated	●●	●	●●	●	●	●	●●

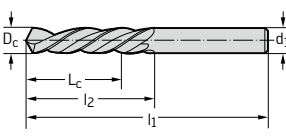
DIN 338	D _c h8 mm	d ₁ f11 mm	L _c mm	l ₁ mm	l ₂ mm	Designation A1231
Cylindrical shank 	5,5	5,5	48	93	57	-5.5
	5,6	5,6	48	93	57	-5.6
	5,7	5,7	48	93	57	-5.7
	5,75	5,75	48	93	57	-5.75
	5,8	5,8	48	93	57	-5.8
	5,9	5,9	48	93	57	-5.9
	6	6	48	93	57	-6
	6,1	6,1	52	101	63	-6.1
	6,2	6,2	52	101	63	-6.2
	6,25	6,25	52	101	63	-6.25
6,3	6,3	52	101	63	-6.3	
6,4	6,4	52	101	63	-6.4	
6,5	6,5	52	101	63	-6.5	
6,6	6,6	52	101	63	-6.6	
6,7	6,7	52	101	63	-6.7	
6,75	6,75	57	109	69	-6.75	
6,8	6,8	57	109	69	-6.8	
6,9	6,9	57	109	69	-6.9	
7	7	57	109	69	-7	
7,1	7,1	57	109	69	-7.1	
7,2	7,2	57	109	69	-7.2	
7,25	7,25	57	109	69	-7.25	
7,3	7,3	57	109	69	-7.3	
7,4	7,4	57	109	69	-7.4	
7,5	7,5	57	109	69	-7.5	
7,6	7,6	62	117	75	-7.6	
7,7	7,7	62	117	75	-7.7	
7,75	7,75	62	117	75	-7.75	
7,8	7,8	62	117	75	-7.8	
7,9	7,9	62	117	75	-7.9	
8	8	62	117	75	-8	
8,1	8,1	62	117	75	-8.1	
8,2	8,2	62	117	75	-8.2	
8,25	8,25	62	117	75	-8.25	
8,3	8,3	62	117	75	-8.3	
8,4	8,4	62	117	75	-8.4	
8,5	8,5	62	117	75	-8.5	
8,6	8,6	66	125	81	-8.6	
8,7	8,7	66	125	81	-8.7	
8,75	8,75	66	125	81	-8.75	
8,8	8,8	66	125	81	-8.8	
8,9	8,9	66	125	81	-8.9	
9	9	66	125	81	-9	
9,1	9,1	66	125	81	-9.1	
9,2	9,2	66	125	81	-9.2	
9,25	9,25	66	125	81	-9.25	
9,3	9,3	66	125	81	-9.3	
9,4	9,4	66	125	81	-9.4	
9,5	9,5	66	125	81	-9.5	
9,6	9,6	71	133	87	-9.6	
9,7	9,7	71	133	87	-9.7	
9,75	9,75	71	133	87	-9.75	
9,8	9,8	71	133	87	-9.8	
9,9	9,9	71	133	87	-9.9	
10	10	71	133	87	-10	

Continued



Twist drill A1231



~ 8 x D_c

Continued

	P	M	K	N	S	H	O
uncoated	●●		●●	●			●●

DIN 338	D _c h8 mm	d ₁ f11 mm	L _c mm	l ₁ mm	l ₂ mm	Designation A1231
Cylindrical shank 	10,1	10,1	71	133	87	-10.1
	10,2	10,2	71	133	87	-10.2
	10,25	10,25	71	133	87	-10.25
	10,3	10,3	71	133	87	-10.3
	10,4	10,4	71	133	87	-10.4
	10,5	10,5	71	133	87	-10.5
	10,6	10,6	71	133	87	-10.6
	10,7	10,7	76	142	94	-10.7
	10,75	10,75	76	142	94	-10.75
	10,8	10,8	76	142	94	-10.8
	10,9	10,9	76	142	94	-10.9
	11	11	76	142	94	-11
	11,1	11,1	76	142	94	-11.1
	11,2	11,2	76	142	94	-11.2
	11,25	11,25	76	142	94	-11.25
	11,3	11,3	76	142	94	-11.3
	11,4	11,4	76	142	94	-11.4
	11,5	11,5	76	142	94	-11.5
	11,6	11,6	76	142	94	-11.6
	11,7	11,7	76	142	94	-11.7
	11,75	11,75	76	142	94	-11.75
	11,8	11,8	76	142	94	-11.8
	11,9	11,9	87	151	101	-11.9
	12	12	87	151	101	-12
	12,1	12,1	87	151	101	-12.1
	12,2	12,2	87	151	101	-12.2
	12,25	12,25	87	151	101	-12.25
	12,3	12,3	87	151	101	-12.3
	12,4	12,4	87	151	101	-12.4
	12,5	12,5	87	151	101	-12.5
	12,6	12,6	87	151	101	-12.6
	12,7	12,7	87	151	101	-12.7
	12,75	12,75	87	151	101	-12.75
	12,8	12,8	87	151	101	-12.8
	12,9	12,9	87	151	101	-12.9
	13	13	87	151	101	-13
	13,1	13,1	87	151	101	-13.1
	13,2	13,2	87	151	101	-13.2
	13,25	13,25	94	160	108	-13.25
	13,3	13,3	94	160	108	-13.3
	13,4	13,4	94	160	108	-13.4
	13,5	13,5	94	160	108	-13.5
	13,6	13,6	94	160	108	-13.6
	13,7	13,7	94	160	108	-13.7
	13,75	13,75	94	160	108	-13.75
	13,8	13,8	94	160	108	-13.8
13,9	13,9	94	160	108	-13.9	
14	14	94	160	108	-14	
14,1	14,1	99	169	114	-14.1	
14,2	14,2	99	169	114	-14.2	
14,25	14,25	99	169	114	-14.25	
14,3	14,3	99	169	114	-14.3	
14,4	14,4	99	169	114	-14.4	
14,5	14,5	99	169	114	-14.5	
14,6	14,6	99	169	114	-14.6	

Continued



Twist drill A1231



~ 8 x D_c

Continued

	P	M	K	N	S	H	O
uncoated	●●		●●	●			●●

DIN 338	D _c h8 mm	d ₁ f11 mm	L _c mm	l ₁ mm	l ₂ mm	Designation A1231
Cylindrical shank 	14,7	14,7	99	169	114	-14.7
	14,75	14,75	99	169	114	-14.75
	14,8	14,8	99	169	114	-14.8
	14,9	14,9	99	169	114	-14.9
	15	15	99	169	114	-15
	15,5	15,5	104	178	120	-15.5
	16	16	104	178	120	-16
	16,5	16,5	108	184	125	-16.5
	17	17	108	184	125	-17
	17,5	17,5	112	191	130	-17.5
	18	18	112	191	130	-18
	18,5	18,5	116	198	135	-18.5
	19	19	116	198	135	-19
	19,5	19,5	120	205	140	-19.5
	20	20	120	205	140	-20

Deep-hole twist drill A1234 UFL®



~ 8 x D_c

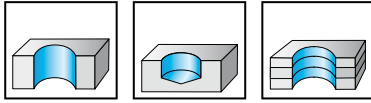

- HSS - Fibre-steamed
- Type UFL®
- left-hand cutting
- 130° point angle
- up to 1.9 mm bright finish

	P	M	K	N	S	H	O
uncoated	●●	●	●●	●●	●		●●

DIN 338	D _c h8 mm	D _c Inches/No	d ₁ f11 mm	L _c mm	l ₁ mm	l ₂ mm	Designation A1234
Cylindrical shank 	1,016	No. 60	1,016	10	34	12	-N060
	1,041	No. 59	1,041	10	34	12	-N059
	1,067	No. 58	1,067	12	36	14	-N058
	1,092	No. 57	1,092	12	36	14	-N057
	1,181	No. 56	1,181	14	38	16	-N056
	1,191	3/64"	1,191	14	38	16	-3/64IN
	1,321	No. 55	1,321	15	40	18	-N055
	1,397	No. 54	1,397	15	40	18	-N054
	1,5		1,5	15	40	18	-1.5
	1,511	No. 53	1,511	17	43	20	-N053
	1,588	1/16"	1,588	17	43	20	-1/16IN
	1,6		1,6	17	43	20	-1.6
	1,613	No. 52	1,613	17	43	20	-N052
	1,7		1,7	17	43	20	-1.7
	1,702	No. 51	1,702	19	46	22	-N051
	1,778	No. 50	1,778	19	46	22	-N050
	1,8		1,8	19	46	22	-1.8
	1,854	No. 49	1,854	19	46	22	-N049
	1,9		1,9	19	46	22	-1.9
	1,93	No. 48	1,93	20	49	24	-N048
	1,984	5/64"	1,984	20	49	24	-5/64IN
	1,994	No. 47	1,994	20	49	24	-N047
	2		2	20	49	24	-2
	2,057	No. 46	2,057	20	49	24	-N046
	2,083	No. 45	2,083	20	49	24	-N045
	2,1		2,1	20	49	24	-2.1
	2,184	No. 44	2,184	23	53	27	-N044
	2,2		2,2	23	53	27	-2.2
	2,261	No. 43	2,261	23	53	27	-N043
	2,3		2,3	23	53	27	-2.3
	2,375	No. 42	2,375	26	57	30	-N042
	2,381	3/32"	2,381	26	57	30	-3/32IN
	2,4		2,4	26	57	30	-2.4
	2,438	No. 41	2,438	26	57	30	-N041
2,489	No. 40	2,489	26	57	30	-N040	
2,5		2,5	26	57	30	-2.5	
2,527	No. 39	2,527	26	57	30	-N039	
2,578	No. 38	2,578	26	57	30	-N038	
2,6		2,6	26	57	30	-2.6	
2,642	No. 37	2,642	26	57	30	-N037	
2,7		2,7	28	61	33	-2.7	
2,705	No. 36	2,705	28	61	33	-N036	
2,778	7/64"	2,778	28	61	33	-7/64IN	
2,794	No. 35	2,794	28	61	33	-N035	
2,8		2,8	28	61	33	-2.8	
2,819	No. 34	2,819	28	61	33	-N034	
2,87	No. 33	2,87	28	61	33	-N033	

Continued

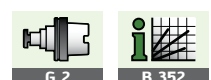

Deep-hole twist drill

A1234

UFL®

~ 8 x D_c



Continued

	P	M	K	N	S	H	O
uncoated	●●	●	●●	●●	●		●●

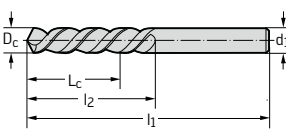
DIN 338	D _c h8 mm	D _c Inches/No	d ₁ f11 mm	L _c mm	l ₁ mm	l ₂ mm	Designation A1234
Cylindrical shank	2,9		2,9	28	61	33	-2.9
	2,946	No. 32	2,946	28	61	33	-N032
	3		3	28	61	33	-3
	3,048	No. 31	3,048	30	65	36	-N031
	3,1		3,1	30	65	36	-3.1
	3,175	1/8"	3,175	30	65	36	-1/8IN
	3,2		3,2	30	65	36	-3.2
	3,264	No. 30	3,264	30	65	36	-N030
	3,3		3,3	30	65	36	-3.3
	3,4		3,4	33	70	39	-3.4
	3,454	No. 29	3,454	33	70	39	-N029
	3,5		3,5	33	70	39	-3.5
	3,569	No. 28	3,569	33	70	39	-N028
	3,572	9/64"	3,572	33	70	39	-9/64IN
	3,6		3,6	33	70	39	-3.6
	3,658	No. 27	3,658	33	70	39	-N027
	3,7		3,7	33	70	39	-3.7
	3,734	No. 26	3,734	33	70	39	-N026
	3,797	No. 25	3,797	36	75	43	-N025
	3,8		3,8	36	75	43	-3.8
	3,861	No. 24	3,861	36	75	43	-N024
	3,9		3,9	36	75	43	-3.9
	3,912	No. 23	3,912	36	75	43	-N023
	3,969	5/32"	3,969	36	75	43	-5/32IN
	3,988	No. 22	3,988	36	75	43	-N022
	4		4	36	75	43	-4
	4,039	No. 21	4,039	36	75	43	-N021
	4,089	No. 20	4,089	36	75	43	-N020
	4,1		4,1	36	75	43	-4.1
	4,2		4,2	36	75	43	-4.2
	4,216	No. 19	4,216	36	75	43	-N019
	4,3		4,3	39	80	47	-4.3
	4,305	No. 18	4,305	39	80	47	-N018
	4,366	11/64"	4,366	39	80	47	-11/64IN
	4,394	No. 17	4,394	39	80	47	-N017
	4,4		4,4	39	80	47	-4.4
	4,496	No. 16	4,496	39	80	47	-N016
	4,5		4,5	39	80	47	-4.5
	4,572	No. 15	4,572	39	80	47	-N015
	4,6		4,6	39	80	47	-4.6
	4,623	No. 14	4,623	39	80	47	-N014
	4,699	No. 13	4,699	39	80	47	-N013
	4,7		4,7	39	80	47	-4.7
	4,763	3/16"	4,763	44	86	52	-3/16IN
	4,8		4,8	44	86	52	-4.8
	4,801	No. 12	4,801	44	86	52	-N012
	4,851	No. 11	4,851	44	86	52	-N011
	4,9		4,9	44	86	52	-4.9
	4,915	No. 10	4,915	44	86	52	-N010
	4,978	No. 9	4,978	44	86	52	-N09
	5		5	44	86	52	-5
	5,055	No. 8	5,055	44	86	52	-N08
	5,1		5,1	44	86	52	-5.1
	5,105	No. 7	5,105	44	86	52	-N07
	5,159	13/64"	5,159	44	86	52	-13/64IN

Continued



Deep-hole twist drill A1234 UFL®



~ 8 x D_c

	P	M	K	N	S	H	O
uncoated	●●	●	●●	●●	●		●●

Continued

DIN 338	D _c h8 mm	D _c Inches/No	d ₁ f11 mm	L _c mm	l ₁ mm	l ₂ mm	Designation A1234
Cylindrical shank	5,182	No. 6	5,182	44	86	52	-N06
	5,2		5,2	44	86	52	-5.2
	5,22	No. 5	5,22	44	86	52	-N05
	5,3		5,3	44	86	52	-5.3
	5,309	No. 4	5,309	48	93	57	-N04
	5,4		5,4	48	93	57	-5.4
	5,41	No. 3	5,41	48	93	57	-N03
	5,5		5,5	48	93	57	-5.5
	5,556	7/32"	5,556	48	93	57	-7/32IN
	5,6		5,6	48	93	57	-5.6
	5,613	No. 2	5,613	48	93	57	-N02
	5,7		5,7	48	93	57	-5.7
	5,791	No. 1	5,791	48	93	57	-N01
	5,8		5,8	48	93	57	-5.8
	5,9		5,9	48	93	57	-5.9
	5,953	15/64"	5,953	48	93	57	-15/64IN
	6		6	48	93	57	-6
	6,1		6,1	52	101	63	-6.1
	6,2		6,2	52	101	63	-6.2
	6,3		6,3	52	101	63	-6.3
	6,35	1/4"	6,35	52	101	63	-1/4IN
	6,4		6,4	52	101	63	-6.4
	6,5		6,5	52	101	63	-6.5
	6,6		6,6	52	101	63	-6.6
	6,7		6,7	52	101	63	-6.7
	6,747	17/64"	6,747	57	109	69	-17/64IN
	6,8		6,8	57	109	69	-6.8
	6,9		6,9	57	109	69	-6.9
	7		7	57	109	69	-7
	7,1		7,1	57	109	69	-7.1
	7,144	9/32"	7,144	57	109	69	-9/32IN
	7,2		7,2	57	109	69	-7.2
	7,3		7,3	57	109	69	-7.3
	7,4		7,4	57	109	69	-7.4
	7,5		7,5	57	109	69	-7.5
	7,541	19/64"	7,541	62	117	75	-19/64IN
	7,6		7,6	62	117	75	-7.6
	7,7		7,7	62	117	75	-7.7
	7,8		7,8	62	117	75	-7.8
	7,9		7,9	62	117	75	-7.9
	7,938	5/16"	7,938	62	117	75	-5/16IN
	8		8	62	117	75	-8
	8,1		8,1	62	117	75	-8.1
	8,2		8,2	62	117	75	-8.2
	8,3		8,3	62	117	75	-8.3
	8,334	21/64"	8,334	62	117	75	-21/64IN
	8,4		8,4	62	117	75	-8.4
	8,5		8,5	62	117	75	-8.5
	8,6		8,6	66	125	81	-8.6
	8,7		8,7	66	125	81	-8.7
	8,731	11/32"	8,731	66	125	81	-11/32IN
	8,8		8,8	66	125	81	-8.8
	8,9		8,9	66	125	81	-8.9
	9		9	66	125	81	-9
	9,1		9,1	66	125	81	-9.1

Continued



Deep-hole twist drill

A1234

UFL®



~ 8 x D_c

Continued

	P	M	K	N	S	H	O
uncoated	●●	●	●●	●●	●		●●

DIN 338	D _c h8 mm	D _c Inches/No	d ₁ f11 mm	L _c mm	l ₁ mm	l ₂ mm	Designation A1234
Cylindrical shank 	9,128	23/64"	9,128	66	125	81	-23/64IN
	9,2		9,2	66	125	81	-9.2
	9,3		9,3	66	125	81	-9.3
	9,4		9,4	66	125	81	-9.4
	9,5		9,5	66	125	81	-9.5
	9,525	3/8"	9,525	71	133	87	-3/8IN
	9,6		9,6	71	133	87	-9.6
	9,7		9,7	71	133	87	-9.7
	9,8		9,8	71	133	87	-9.8
	9,9		9,9	71	133	87	-9.9
	9,922	25/64"	9,922	71	133	87	-25/64IN
	10		10	71	133	87	-10
	10,2		10,2	71	133	87	-10.2
	10,319	13/32"	10,319	71	133	87	-13/32IN
	10,5		10,5	71	133	87	-10.5
	10,716	27/64"	10,716	76	142	94	-27/64IN
	10,8		10,8	76	142	94	-10.8
	11		11	76	142	94	-11
	11,113	7/16"	11,113	76	142	94	-7/16IN
	11,2		11,2	76	142	94	-11.2
	11,5		11,5	76	142	94	-11.5
	11,509	29/64"	11,509	76	142	94	-29/64IN
	11,8		11,8	76	142	94	-11.8
	11,906	15/32"	11,906	87	151	101	-15/32IN
	12		12	87	151	101	-12
	12,303	31/64"	12,303	87	151	101	-31/64IN
	12,7	1/2"	12,7	87	151	101	-1/2IN

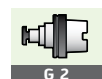

Twist drill A1244 VA



~ 8 x D_c

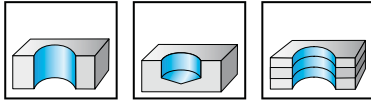

- HSS-E - uncoated
- Type VA
- right-hand cutting
- 130° point angle
- available as set

	P	M	K	N	S	H	O
uncoated	●●	●●	●●	●●	●●		

DIN 338	D _c h8 mm	D _c Inches/No	d ₁ f11 mm	L _c mm	l ₁ mm	l ₂ mm	Designation A1244
Cylindrical shank 	0,3		0,3	2,5	19	3	-0.3
	0,343	No. 80	0,343	3,4	19	4	-NO80
	0,35		0,35	3,4	19	4	-0.35
	0,368	No. 79	0,368	3,4	19	4	-NO79
	0,397	1/64"	0,397	4,2	20	5	-1/64IN
	0,4		0,4	4,2	20	5	-0.4
	0,406	No. 78	0,406	4,2	20	5	-NO78
	0,45		0,45	4,2	20	5	-0.45
	0,457	No. 77	0,457	4,2	20	5	-NO77
	0,5		0,5	5,2	22	6	-0.5
	0,508	No. 76	0,508	5,2	22	6	-NO76
	0,533	No. 75	0,533	6,1	24	7	-NO75
	0,55		0,55	6,1	24	7	-0.55
	0,572	No. 74	0,572	6,1	24	7	-NO74
	0,6		0,6	6,1	24	7	-0.6
	0,61	No. 73	0,61	6,9	26	8	-NO73
	0,635	No. 72	0,635	6,9	26	8	-NO72
	0,65		0,65	6,9	26	8	-0.65
	0,66	No. 71	0,66	6,9	26	8	-NO71
	0,7		0,7	7,8	28	9	-0.7
	0,711	No. 70	0,711	7,8	28	9	-NO70
	0,742	No. 69	0,742	7,8	28	9	-NO69
	0,75		0,75	7,8	28	9	-0.75
	0,787	No. 68	0,787	8,7	30	10	-NO68
	0,794	1/32"	0,794	8,7	30	10	-1/32IN
	0,8		0,8	8,7	30	10	-0.8
	0,813	No. 67	0,813	8,7	30	10	-NO67
	0,838	No. 66	0,838	8,7	30	10	-NO66
	0,85		0,85	8,7	30	10	-0.85
	0,889	No. 65	0,889	9,5	32	11	-NO65
	0,9		0,9	9,5	32	11	-0.9
	0,914	No. 64	0,914	9,5	32	11	-NO64
	0,94	No. 63	0,94	9,5	32	11	-NO63
	0,95		0,95	9,5	32	11	-0.95
0,965	No. 62	0,965	10	34	12	-NO62	
0,991	No. 61	0,991	10	34	12	-NO61	
1		1	10	34	12	-1	
1,016	No. 60	1,016	10	34	12	-NO60	
1,041	No. 59	1,041	10	34	12	-NO59	
1,05		1,05	10	34	12	-1.05	
1,067	No. 58	1,067	12	36	14	-NO58	
1,092	No. 57	1,092	12	36	14	-NO57	
1,1		1,1	12	36	14	-1.1	
1,15		1,15	12	36	14	-1.15	
1,181	No. 56	1,181	14	38	16	-NO56	
1,191	3/64"	1,191	14	38	16	-3/64IN	
1,2		1,2	14	38	16	-1.2	

Continued

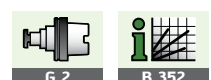

Twist drill A1244 VA

~ 8 x D_c



Continued

	P	M	K	N	S	H	O
uncoated	●●	●●	●●	●●	●●		

DIN 338	D _c h8 mm	D _c Inches/No	d ₁ f11 mm	L _c mm	l ₁ mm	l ₂ mm	Designation A1244
Cylindrical shank 	1,25		1,25	14	38	16	-1.25
	1,3		1,3	14	38	16	-1.3
	1,321	No. 55	1,321	15	40	18	-N055
	1,35		1,35	15	40	18	-1.35
	1,397	No. 54	1,397	15	40	18	-N054
	1,4		1,4	15	40	18	-1.4
	1,45		1,45	15	40	18	-1.45
	1,5		1,5	15	40	18	-1.5
	1,511	No. 53	1,511	17	43	20	-N053
	1,55		1,55	17	43	20	-1.55
	1,588	1/16"	1,588	17	43	20	-1/16IN
	1,6		1,6	17	43	20	-1.6
	1,613	No. 52	1,613	17	43	20	-N052
	1,65		1,65	17	43	20	-1.65
	1,7		1,7	17	43	20	-1.7
	1,702	No. 51	1,702	19	46	22	-N051
	1,75		1,75	19	46	22	-1.75
	1,778	No. 50	1,778	19	46	22	-N050
	1,8		1,8	19	46	22	-1.8
	1,85		1,85	19	46	22	-1.85
	1,854	No. 49	1,854	19	46	22	-N049
	1,9		1,9	19	46	22	-1.9
	1,93	No. 48	1,93	20	49	24	-N048
	1,95		1,95	20	49	24	-1.95
	1,984	5/64"	1,984	20	49	24	-5/64IN
	1,994	No. 47	1,994	20	49	24	-N047
	2		2	20	49	24	-2
	2,05		2,05	20	49	24	-2.05
	2,057	No. 46	2,057	20	49	24	-N046
	2,083	No. 45	2,083	20	49	24	-N045
	2,1		2,1	20	49	24	-2.1
	2,15		2,15	23	53	27	-2.15
	2,184	No. 44	2,184	23	53	27	-N044
	2,2		2,2	23	53	27	-2.2
2,25		2,25	23	53	27	-2.25	
2,261	No. 43	2,261	23	53	27	-N043	
2,3		2,3	23	53	27	-2.3	
2,35		2,35	23	53	27	-2.35	
2,375	No. 42	2,375	26	57	30	-N042	
2,381	3/32"	2,381	26	57	30	-3/32IN	
2,4		2,4	26	57	30	-2.4	
2,438	No. 41	2,438	26	57	30	-N041	
2,45		2,45	26	57	30	-2.45	
2,489	No. 40	2,489	26	57	30	-N040	
2,5		2,5	26	57	30	-2.5	
2,527	No. 39	2,527	26	57	30	-N039	
2,55		2,55	26	57	30	-2.55	
2,578	No. 38	2,578	26	57	30	-N038	
2,6		2,6	26	57	30	-2.6	
2,642	No. 37	2,642	26	57	30	-N037	
2,65		2,65	26	57	30	-2.65	
2,7		2,7	28	61	33	-2.7	
2,705	No. 36	2,705	28	61	33	-N036	
2,75		2,75	28	61	33	-2.75	
2,778	7/64"	2,778	28	61	33	-7/64IN	

Continued



Twist drill A1244 VA



~ 8 x D_c

	P	M	K	N	S	H	O
uncoated	●●	●●	●●	●●	●●		

Continued

DIN 338	D _c h8 mm	D _c Inches/No	d ₁ f11 mm	L _c mm	l ₁ mm	l ₂ mm	Designation A1244
Cylindrical shank	2,794	No. 35	2,794	28	61	33	-N035
	2,8		2,8	28	61	33	-2.8
	2,819	No. 34	2,819	28	61	33	-N034
	2,85		2,85	28	61	33	-2.85
	2,87	No. 33	2,87	28	61	33	-N033
	2,9		2,9	28	61	33	-2.9
	2,946	No. 32	2,946	28	61	33	-N032
	2,95		2,95	28	61	33	-2.95
	3		3	28	61	33	-3
	3,048	No. 31	3,048	30	65	36	-N031
	3,1		3,1	30	65	36	-3.1
	3,175	1/8"	3,175	30	65	36	-1/8IN
	3,2		3,2	30	65	36	-3.2
	3,264	No. 30	3,264	30	65	36	-N030
	3,3		3,3	30	65	36	-3.3
	3,4		3,4	33	70	39	-3.4
	3,454	No. 29	3,454	33	70	39	-N029
	3,5		3,5	33	70	39	-3.5
	3,569	No. 28	3,569	33	70	39	-N028
	3,572	9/64"	3,572	33	70	39	-9/64IN
	3,6		3,6	33	70	39	-3.6
	3,65		3,65	33	70	39	-3.65
	3,658	No. 27	3,658	33	70	39	-N027
	3,7		3,7	33	70	39	-3.7
	3,734	No. 26	3,734	33	70	39	-N026
	3,797	No. 25	3,797	36	75	43	-N025
	3,8		3,8	36	75	43	-3.8
	3,861	No. 24	3,861	36	75	43	-N024
	3,9		3,9	36	75	43	-3.9
	3,912	No. 23	3,912	36	75	43	-N023
	3,969	5/32"	3,969	36	75	43	-5/32IN
	3,988	No. 22	3,988	36	75	43	-N022
	4		4	36	75	43	-4
	4,039	No. 21	4,039	36	75	43	-N021
	4,089	No. 20	4,089	36	75	43	-N020
	4,1		4,1	36	75	43	-4.1
	4,2		4,2	36	75	43	-4.2
	4,216	No. 19	4,216	36	75	43	-N019
	4,3		4,3	39	80	47	-4.3
	4,305	No. 18	4,305	39	80	47	-N018
	4,366	11/64"	4,366	39	80	47	-11/64IN
	4,394	No. 17	4,394	39	80	47	-N017
	4,4		4,4	39	80	47	-4.4
	4,496	No. 16	4,496	39	80	47	-N016
	4,5		4,5	39	80	47	-4.5
	4,572	No. 15	4,572	39	80	47	-N015
	4,6		4,6	39	80	47	-4.6
	4,623	No. 14	4,623	39	80	47	-N014
	4,699	No. 13	4,699	39	80	47	-N013
	4,7		4,7	39	80	47	-4.7
	4,763	3/16"	4,763	44	86	52	-3/16IN
	4,8		4,8	44	86	52	-4.8
	4,801	No. 12	4,801	44	86	52	-N012
	4,851	No. 11	4,851	44	86	52	-N011
	4,9		4,9	44	86	52	-4.9

Continued



Twist drill A1244 VA

~ 8 x D_c



Continued

	P	M	K	N	S	H	O
uncoated	●●	●●	●●	●●	●●		

DIN 338	D _c h8 mm	D _c Inches/No	d ₁ f11 mm	L _c mm	l ₁ mm	l ₂ mm	Designation A1244
Cylindrical shank	4,915	No. 10	4,915	44	86	52	-N010
	4,978	No. 9	4,978	44	86	52	-N09
	5		5	44	86	52	-5
	5,055	No. 8	5,055	44	86	52	-N08
	5,1		5,1	44	86	52	-5.1
	5,105	No. 7	5,105	44	86	52	-N07
	5,159	13/64"	5,159	44	86	52	-13/64IN
	5,182	No. 6	5,182	44	86	52	-N06
	5,2		5,2	44	86	52	-5.2
	5,22	No. 5	5,22	44	86	52	-N05
	5,3		5,3	44	86	52	-5.3
	5,309	No. 4	5,309	48	93	57	-N04
	5,4		5,4	48	93	57	-5.4
	5,41	No. 3	5,41	48	93	57	-N03
	5,5		5,5	48	93	57	-5.5
	5,556	7/32"	5,556	48	93	57	-7/32IN
	5,6		5,6	48	93	57	-5.6
	5,613	No. 2	5,613	48	93	57	-N02
	5,7		5,7	48	93	57	-5.7
	5,791	No. 1	5,791	48	93	57	-N01
	5,8		5,8	48	93	57	-5.8
	5,9		5,9	48	93	57	-5.9
	5,953	15/64"	5,953	48	93	57	-15/64IN
	6		6	48	93	57	-6
	6,1		6,1	52	101	63	-6.1
	6,2		6,2	52	101	63	-6.2
	6,3		6,3	52	101	63	-6.3
	6,35	1/4"	6,35	52	101	63	-1/4IN
	6,4		6,4	52	101	63	-6.4
	6,5		6,5	52	101	63	-6.5
	6,6		6,6	52	101	63	-6.6
	6,7		6,7	52	101	63	-6.7
	6,747	17/64"	6,747	57	109	69	-17/64IN
	6,8		6,8	57	109	69	-6.8
	6,9		6,9	57	109	69	-6.9
	7		7	57	109	69	-7
	7,1		7,1	57	109	69	-7.1
	7,144	9/32"	7,144	57	109	69	-9/32IN
	7,2		7,2	57	109	69	-7.2
	7,3		7,3	57	109	69	-7.3
	7,4		7,4	57	109	69	-7.4
	7,5		7,5	57	109	69	-7.5
	7,541	19/64"	7,541	62	117	75	-19/64IN
	7,6		7,6	62	117	75	-7.6
	7,7		7,7	62	117	75	-7.7
	7,8		7,8	62	117	75	-7.8
	7,9		7,9	62	117	75	-7.9
	7,938	5/16"	7,938	62	117	75	-5/16IN
	8		8	62	117	75	-8
	8,1		8,1	62	117	75	-8.1
	8,2		8,2	62	117	75	-8.2
	8,3		8,3	62	117	75	-8.3
	8,334	21/64"	8,334	62	117	75	-21/64IN
	8,4		8,4	62	117	75	-8.4
	8,5		8,5	62	117	75	-8.5

Continued



Twist drill A1244 VA



~ 8 x D_c

	P	M	K	N	S	H	O
uncoated	●●	●●	●●	●●	●●		

Continued

DIN 338	D _c h8 mm	D _c Inches/No	d ₁ f11 mm	L _c mm	l ₁ mm	l ₂ mm	Designation A1244
Cylindrical shank 	8,6		8,6	66	125	81	-8.6
	8,7		8,7	66	125	81	-8.7
	8,731	11/32"	8,731	66	125	81	-11/32IN
	8,8		8,8	66	125	81	-8.8
	8,9		8,9	66	125	81	-8.9
	9		9	66	125	81	-9
	9,1		9,1	66	125	81	-9.1
	9,128	23/64"	9,128	66	125	81	-23/64IN
	9,2		9,2	66	125	81	-9.2
	9,3		9,3	66	125	81	-9.3
	9,4		9,4	66	125	81	-9.4
	9,5		9,5	66	125	81	-9.5
	9,525	3/8"	9,525	71	133	87	-3/8IN
	9,6		9,6	71	133	87	-9.6
	9,7		9,7	71	133	87	-9.7
	9,8		9,8	71	133	87	-9.8
	9,9		9,9	71	133	87	-9.9
	9,922	25/64"	9,922	71	133	87	-25/64IN
	10		10	71	133	87	-10
	10,2		10,2	71	133	87	-10.2
	10,319	13/32"	10,319	71	133	87	-13/32IN
	10,5		10,5	71	133	87	-10.5
	10,716	27/64"	10,716	76	142	94	-27/64IN
	11		11	76	142	94	-11
	11,113	7/16"	11,113	76	142	94	-7/16IN
	11,2		11,2	76	142	94	-11.2
	11,5		11,5	76	142	94	-11.5
	11,509	29/64"	11,509	76	142	94	-29/64IN
	11,906	15/32"	11,906	87	151	101	-15/32IN
	12		12	87	151	101	-12
12,303	31/64"	12,303	87	151	101	-31/64IN	
12,5		12,5	87	151	101	-12.5	
12,7	1/2"	12,7	87	151	101	-1/2IN	
13		13	87	151	101	-13	
13,097	33/64"	13,097	87	151	101	-33/64IN	
13,494	17/32"	13,494	94	160	108	-17/32IN	
13,5		13,5	94	160	108	-13.5	
13,891	35/64"	13,891	94	160	108	-35/64IN	
14		14	94	160	108	-14	
14,288	9/16"	14,288	99	169	114	-9/16IN	
14,5		14,5	99	169	114	-14.5	
15		15	99	169	114	-15	

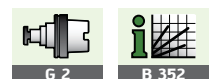

Twist drill A1247 Alpha® XE

~ 8 x D_c

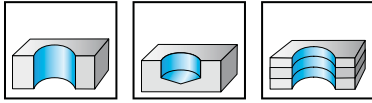

- HSS-E - fibre-steamed
- Type Alpha® XE
- right-hand cutting
- 130° point angle
- up to 1.9 mm bright finish



	P	M	K	N	S	H	O
uncoated	●●	●●	●●	●●	●●		●●

DIN 338	D _c h8 mm	D _c Inches/No	d ₁ f11 mm	L _c mm	l ₁ mm	l ₂ mm	Designation A1247
Cylindrical shank 	1		1	10	34	12	-1
	1,016	No. 60	1,016	10	34	12	-NO60
	1,041	No. 59	1,041	10	34	12	-NO59
	1,067	No. 58	1,067	12	36	14	-NO58
	1,092	No. 57	1,092	12	36	14	-NO57
	1,1		1,1	12	36	14	-1.1
	1,181	No. 56	1,181	14	38	16	-NO56
	1,191	3/64"	1,191	14	38	16	-3/64IN
	1,2		1,2	14	38	16	-1.2
	1,25		1,25	14	38	16	-1.25
	1,3		1,3	14	38	16	-1.3
	1,321	No. 55	1,321	15	40	18	-NO55
	1,397	No. 54	1,397	15	40	18	-NO54
	1,4		1,4	15	40	18	-1.4
	1,5		1,5	15	40	18	-1.5
	1,511	No. 53	1,511	17	43	20	-NO53
	1,588	1/16"	1,588	17	43	20	-1/16IN
	1,6		1,6	17	43	20	-1.6
	1,613	No. 52	1,613	17	43	20	-NO52
	1,7		1,7	17	43	20	-1.7
	1,702	No. 51	1,702	19	46	22	-NO51
	1,778	No. 50	1,778	19	46	22	-NO50
	1,8		1,8	19	46	22	-1.8
	1,854	No. 49	1,854	19	46	22	-NO49
	1,9		1,9	19	46	22	-1.9
	1,93	No. 48	1,93	20	49	24	-NO48
	1,984	5/64"	1,984	20	49	24	-5/64IN
	1,994	No. 47	1,994	20	49	24	-NO47
	2		2	20	49	24	-2
	2,057	No. 46	2,057	20	49	24	-NO46
	2,083	No. 45	2,083	20	49	24	-NO45
	2,1		2,1	20	49	24	-2.1
	2,184	No. 44	2,184	23	53	27	-NO44
2,2		2,2	23	53	27	-2.2	
2,261	No. 43	2,261	23	53	27	-NO43	
2,3		2,3	23	53	27	-2.3	
2,375	No. 42	2,375	26	57	30	-NO42	
2,381	3/32"	2,381	26	57	30	-3/32IN	
2,4		2,4	26	57	30	-2.4	
2,438	No. 41	2,438	26	57	30	-NO41	
2,489	No. 40	2,489	26	57	30	-NO40	
2,5		2,5	26	57	30	-2.5	
2,527	No. 39	2,527	26	57	30	-NO39	
2,578	No. 38	2,578	26	57	30	-NO38	
2,6		2,6	26	57	30	-2.6	
2,642	No. 37	2,642	26	57	30	-NO37	
2,7		2,7	28	61	33	-2.7	

Continued





Twist drill A1247 Alpha® XE

~ 8 x D_c

	P	M	K	N	S	H	O
uncoated	●●	●●	●●	●●	●●		●●

Continued

DIN 338	D _c h8 mm	D _c Inches/No	d ₁ f11 mm	L _c mm	l ₁ mm	l ₂ mm	Designation A1247
Cylindrical shank 	2,705	No. 36	2,705	28	61	33	-N036
	2,778	7/64"	2,778	28	61	33	-7/64IN
	2,794	No. 35	2,794	28	61	33	-N035
	2,8		2,8	28	61	33	-2.8
	2,819	No. 34	2,819	28	61	33	-N034
	2,87	No. 33	2,87	28	61	33	-N033
	2,9		2,9	28	61	33	-2.9
	2,946	No. 32	2,946	28	61	33	-N032
	3		3	28	61	33	-3
	3,048	No. 31	3,048	30	65	36	-N031
	3,1		3,1	30	65	36	-3.1
	3,175	1/8"	3,175	30	65	36	-1/8IN
	3,2		3,2	30	65	36	-3.2
	3,264	No. 30	3,264	30	65	36	-N030
	3,3		3,3	30	65	36	-3.3
	3,4		3,4	33	70	39	-3.4
	3,454	No. 29	3,454	33	70	39	-N029
	3,5		3,5	33	70	39	-3.5
	3,569	No. 28	3,569	33	70	39	-N028
	3,572	9/64"	3,572	33	70	39	-9/64IN
	3,6		3,6	33	70	39	-3.6
	3,658	No. 27	3,658	33	70	39	-N027
	3,7		3,7	33	70	39	-3.7
	3,734	No. 26	3,734	33	70	39	-N026
	3,797	No. 25	3,797	36	75	43	-N025
	3,8		3,8	36	75	43	-3.8
	3,861	No. 24	3,861	36	75	43	-N024
	3,9		3,9	36	75	43	-3.9
3,912	No. 23	3,912	36	75	43	-N023	
3,969	5/32"	3,969	36	75	43	-5/32IN	
3,988	No. 22	3,988	36	75	43	-N022	
4		4	36	75	43	-4	
4,039	No. 21	4,039	36	75	43	-N021	
4,089	No. 20	4,089	36	75	43	-N020	
4,1		4,1	36	75	43	-4.1	
4,2		4,2	36	75	43	-4.2	
4,216	No. 19	4,216	36	75	43	-N019	
4,3		4,3	39	80	47	-4.3	
4,305	No. 18	4,305	39	80	47	-N018	
4,366	11/64"	4,366	39	80	47	-11/64IN	
4,394	No. 17	4,394	39	80	47	-N017	
4,4		4,4	39	80	47	-4.4	
4,496	No. 16	4,496	39	80	47	-N016	
4,5		4,5	39	80	47	-4.5	
4,572	No. 15	4,572	39	80	47	-N015	
4,6		4,6	39	80	47	-4.6	
4,623	No. 14	4,623	39	80	47	-N014	
4,699	No. 13	4,699	39	80	47	-N013	
4,7		4,7	39	80	47	-4.7	
4,763	3/16"	4,763	44	86	52	-3/16IN	
4,8		4,8	44	86	52	-4.8	
4,801	No. 12	4,801	44	86	52	-N012	
4,851	No. 11	4,851	44	86	52	-N011	
4,9		4,9	44	86	52	-4.9	
4,915	No. 10	4,915	44	86	52	-N010	

Continued



Twist drill A1247 Alpha® XE

~ 8 x D_c



Continued

	P	M	K	N	S	H	O
uncoated	●●	●●	●●	●●	●●		●●

DIN 338	D _c h8 mm	D _c Inches/No	d ₁ f11 mm	L _c mm	l ₁ mm	l ₂ mm	Designation A1247
Cylindrical shank	4,978	No. 9	4,978	44	86	52	-N09
	5		5	44	86	52	-5
	5,055	No. 8	5,055	44	86	52	-N08
	5,1		5,1	44	86	52	-5.1
	5,105	No. 7	5,105	44	86	52	-N07
	5,159	13/64"	5,159	44	86	52	-13/64IN
	5,182	No. 6	5,182	44	86	52	-N06
	5,2		5,2	44	86	52	-5.2
	5,22	No. 5	5,22	44	86	52	-N05
	5,3		5,3	44	86	52	-5.3
	5,309	No. 4	5,309	48	93	57	-N04
	5,4		5,4	48	93	57	-5.4
	5,41	No. 3	5,41	48	93	57	-N03
	5,5		5,5	48	93	57	-5.5
	5,556	7/32"	5,556	48	93	57	-7/32IN
	5,6		5,6	48	93	57	-5.6
	5,613	No. 2	5,613	48	93	57	-N02
	5,7		5,7	48	93	57	-5.7
	5,791	No. 1	5,791	48	93	57	-N01
	5,8		5,8	48	93	57	-5.8
	5,9		5,9	48	93	57	-5.9
	5,953	15/64"	5,953	48	93	57	-15/64IN
	6		6	48	93	57	-6
	6,1		6,1	52	101	63	-6.1
	6,2		6,2	52	101	63	-6.2
	6,3		6,3	52	101	63	-6.3
	6,35	1/4"	6,35	52	101	63	-1/4IN
	6,4		6,4	52	101	63	-6.4
	6,5		6,5	52	101	63	-6.5
	6,6		6,6	52	101	63	-6.6
	6,7		6,7	52	101	63	-6.7
	6,747	17/64"	6,747	57	109	69	-17/64IN
	6,8		6,8	57	109	69	-6.8
	6,9		6,9	57	109	69	-6.9
	7		7	57	109	69	-7
	7,1		7,1	57	109	69	-7.1
	7,144	9/32"	7,144	57	109	69	-9/32IN
	7,2		7,2	57	109	69	-7.2
	7,3		7,3	57	109	69	-7.3
	7,4		7,4	57	109	69	-7.4
	7,5		7,5	57	109	69	-7.5
	7,541	19/64"	7,541	62	117	75	-19/64IN
	7,6		7,6	62	117	75	-7.6
	7,7		7,7	62	117	75	-7.7
	7,8		7,8	62	117	75	-7.8
	7,9		7,9	62	117	75	-7.9
	7,938	5/16"	7,938	62	117	75	-5/16IN
	8		8	62	117	75	-8
	8,1		8,1	62	117	75	-8.1
	8,2		8,2	62	117	75	-8.2
	8,3		8,3	62	117	75	-8.3
	8,334	21/64"	8,334	62	117	75	-21/64IN
	8,4		8,4	62	117	75	-8.4
	8,5		8,5	62	117	75	-8.5
	8,6		8,6	66	125	81	-8.6

Continued





Twist drill A1247 Alpha® XE

~ 8 x D_c

Continued

	P	M	K	N	S	H	O
uncoated	●●	●●	●●	●●	●●		●●

DIN 338	D _c h8 mm	D _c Inches/No	d ₁ f11 mm	L _c mm	l ₁ mm	l ₂ mm	Designation A1247
Cylindrical shank 	8,7		8,7	66	125	81	-8.7
	8,731	11/32"	8,731	66	125	81	-11/32IN
	8,8		8,8	66	125	81	-8.8
	8,9		8,9	66	125	81	-8.9
	9		9	66	125	81	-9
	9,1		9,1	66	125	81	-9.1
	9,128	23/64"	9,128	66	125	81	-23/64IN
	9,2		9,2	66	125	81	-9.2
	9,3		9,3	66	125	81	-9.3
	9,4		9,4	66	125	81	-9.4
	9,5		9,5	66	125	81	-9.5
	9,525	3/8"	9,525	71	133	87	-3/8IN
	9,6		9,6	71	133	87	-9.6
	9,7		9,7	71	133	87	-9.7
	9,8		9,8	71	133	87	-9.8
	9,9		9,9	71	133	87	-9.9
	9,922	25/64"	9,922	71	133	87	-25/64IN
	10		10	71	133	87	-10
	10,2		10,2	71	133	87	-10.2
	10,319	13/32"	10,319	71	133	87	-13/32IN
	10,5		10,5	71	133	87	-10.5
	10,716	27/64"	10,716	76	142	94	-27/64IN
	10,8		10,8	76	142	94	-10.8
	11		11	76	142	94	-11
	11,113	7/16"	11,113	76	142	94	-7/16IN
	11,2		11,2	76	142	94	-11.2
	11,5		11,5	76	142	94	-11.5
	11,509	29/64"	11,509	76	142	94	-29/64IN
	11,8		11,8	76	142	94	-11.8
	11,906	15/32"	11,906	87	151	101	-15/32IN
	12		12	87	151	101	-12
	12,303	31/64"	12,303	87	151	101	-31/64IN
12,5		12,5	87	151	101	-12.5	
12,7	1/2"	12,7	87	151	101	-1/2IN	
13		13	87	151	101	-13	
13,1		13,1	87	151	101	-13.1	
13,3		13,3	94	160	108	-13.3	
13,5		13,5	94	160	108	-13.5	
14		14	94	160	108	-14	
14,5		14,5	99	169	114	-14.5	
15		15	99	169	114	-15	
15,1		15,1	104	178	120	-15.1	
15,3		15,3	104	178	120	-15.3	
15,5		15,5	104	178	120	-15.5	
16		16	104	178	120	-16	

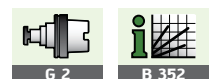

Deep-hole twist drill

A1249TFL

UFL®



~ 8 x D_c

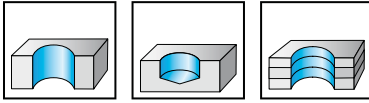

- HSS-E - TFL
- Type UFL®
- right-hand cutting
- 130° point angle

Special features:
suitable for dry machining in steel

	P	M	K	N	S	H	O
TFL	●●	●●	●●	●●	●●		●●

DIN 338	D _c h8 mm	D _c Inches/No	d ₁ f11 mm	L _c mm	l ₁ mm	l ₂ mm	Designation A1249TFL
Cylindrical shank	1		1	10	34	12	-1
	1,016	No. 60	1,016	10	34	12	-NO60
	1,041	No. 59	1,041	10	34	12	-NO59
	1,067	No. 58	1,067	12	36	14	-NO58
	1,092	No. 57	1,092	12	36	14	-NO57
	1,1		1,1	12	36	14	-1.1
	1,181	No. 56	1,181	14	38	16	-NO56
	1,191	3/64"	1,191	14	38	16	-3/64IN
	1,2		1,2	14	38	16	-1.2
	1,3		1,3	14	38	16	-1.3
	1,321	No. 55	1,321	15	40	18	-NO55
	1,397	No. 54	1,397	15	40	18	-NO54
	1,4		1,4	15	40	18	-1.4
	1,5		1,5	15	40	18	-1.5
	1,511	No. 53	1,511	17	43	20	-NO53
	1,588	1/16"	1,588	17	43	20	-1/16IN
	1,6		1,6	17	43	20	-1.6
	1,613	No. 52	1,613	17	43	20	-NO52
	1,7		1,7	17	43	20	-1.7
	1,702	No. 51	1,702	19	46	22	-NO51
	1,778	No. 50	1,778	19	46	22	-NO50
	1,8		1,8	19	46	22	-1.8
	1,854	No. 49	1,854	19	46	22	-NO49
	1,9		1,9	19	46	22	-1.9
	1,93	No. 48	1,93	20	49	24	-NO48
	1,984	5/64"	1,984	20	49	24	-5/64IN
	1,994	No. 47	1,994	20	49	24	-NO47
	2		2	20	49	24	-2
	2,057	No. 46	2,057	20	49	24	-NO46
	2,083	No. 45	2,083	20	49	24	-NO45
	2,1		2,1	20	49	24	-2.1
	2,184	No. 44	2,184	23	53	27	-NO44
	2,2		2,2	23	53	27	-2.2
	2,261	No. 43	2,261	23	53	27	-NO43
	2,3		2,3	23	53	27	-2.3
	2,375	No. 42	2,375	26	57	30	-NO42
	2,381	3/32"	2,381	26	57	30	-3/32IN
	2,4		2,4	26	57	30	-2.4
	2,438	No. 41	2,438	26	57	30	-NO41
	2,489	No. 40	2,489	26	57	30	-NO40
	2,5		2,5	26	57	30	-2.5
	2,527	No. 39	2,527	26	57	30	-NO39
	2,578	No. 38	2,578	26	57	30	-NO38
	2,6		2,6	26	57	30	-2.6
	2,642	No. 37	2,642	26	57	30	-NO37
	2,7		2,7	28	61	33	-2.7
	2,705	No. 36	2,705	28	61	33	-NO36

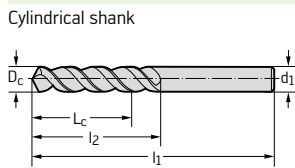

Continued



Deep-hole twist drill A1249TFL UFL®



~ 8 x D_c

	P	M	K	N	S	H	O
TFL	●●	●●	●●	●●	●●		●●

Continued

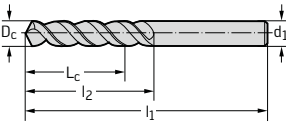
DIN 338	D _c h8 mm	D _c Inches/No	d ₁ f11 mm	L _c mm	l ₁ mm	l ₂ mm	Designation A1249TFL
Cylindrical shank	2,778	7/64"	2,778	28	61	33	-7/64IN
	2,794	No. 35	2,794	28	61	33	-N035
	2,8		2,8	28	61	33	-2.8
	2,819	No. 34	2,819	28	61	33	-N034
	2,87	No. 33	2,87	28	61	33	-N033
	2,9		2,9	28	61	33	-2.9
	2,946	No. 32	2,946	28	61	33	-N032
	3		3	28	61	33	-3
	3,048	No. 31	3,048	30	65	36	-N031
	3,1		3,1	30	65	36	-3.1
	3,175	1/8"	3,175	30	65	36	-1/8IN
	3,2		3,2	30	65	36	-3.2
	3,264	No. 30	3,264	30	65	36	-N030
	3,3		3,3	30	65	36	-3.3
	3,4		3,4	33	70	39	-3.4
	3,454	No. 29	3,454	33	70	39	-N029
	3,5		3,5	33	70	39	-3.5
	3,569	No. 28	3,569	33	70	39	-N028
	3,572	9/64"	3,572	33	70	39	-9/64IN
	3,6		3,6	33	70	39	-3.6
	3,658	No. 27	3,658	33	70	39	-N027
	3,7		3,7	33	70	39	-3.7
	3,734	No. 26	3,734	33	70	39	-N026
	3,797	No. 25	3,797	36	75	43	-N025
	3,8		3,8	36	75	43	-3.8
	3,861	No. 24	3,861	36	75	43	-N024
	3,9		3,9	36	75	43	-3.9
	3,912	No. 23	3,912	36	75	43	-N023
	3,969	5/32"	3,969	36	75	43	-5/32IN
	3,988	No. 22	3,988	36	75	43	-N022
	4		4	36	75	43	-4
	4,039	No. 21	4,039	36	75	43	-N021
	4,089	No. 20	4,089	36	75	43	-N020
	4,1		4,1	36	75	43	-4.1
	4,2		4,2	36	75	43	-4.2
	4,216	No. 19	4,216	36	75	43	-N019
	4,3		4,3	39	80	47	-4.3
	4,305	No. 18	4,305	39	80	47	-N018
	4,366	11/64"	4,366	39	80	47	-11/64IN
	4,394	No. 17	4,394	39	80	47	-N017
	4,4		4,4	39	80	47	-4.4
	4,496	No. 16	4,496	39	80	47	-N016
	4,5		4,5	39	80	47	-4.5
	4,572	No. 15	4,572	39	80	47	-N015
	4,6		4,6	39	80	47	-4.6
	4,623	No. 14	4,623	39	80	47	-N014
	4,65		4,65	39	80	47	-4.65
	4,699	No. 13	4,699	39	80	47	-N013
	4,7		4,7	39	80	47	-4.7
	4,763	3/16"	4,763	44	86	52	-3/16IN
	4,8		4,8	44	86	52	-4.8
	4,801	No. 12	4,801	44	86	52	-N012
	4,851	No. 11	4,851	44	86	52	-N011
	4,9		4,9	44	86	52	-4.9
	4,915	No. 10	4,915	44	86	52	-N010

Continued



Deep-hole twist drill

A1249TFL

UFL®



~ 8 x D_c

Continued

	P	M	K	N	S	H	O
TFL	●●	●●	●●	●●	●●		●●

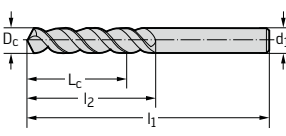
DIN 338	D _c h8 mm	D _c Inches/No	d ₁ f11 mm	L _c mm	l ₁ mm	l ₂ mm	Designation A1249TFL
Cylindrical shank	4,978	No. 9	4,978	44	86	52	-N09
	5		5	44	86	52	-5
	5,055	No. 8	5,055	44	86	52	-N08
	5,1		5,1	44	86	52	-5.1
	5,105	No. 7	5,105	44	86	52	-N07
	5,159	13/64"	5,159	44	86	52	-13/64IN
	5,182	No. 6	5,182	44	86	52	-N06
	5,2		5,2	44	86	52	-5.2
	5,22	No. 5	5,22	44	86	52	-N05
	5,3		5,3	44	86	52	-5.3
	5,309	No. 4	5,309	48	93	57	-N04
	5,4		5,4	48	93	57	-5.4
	5,41	No. 3	5,41	48	93	57	-N03
	5,5		5,5	48	93	57	-5.5
	5,55		5,55	48	93	57	-5.55
	5,556	7/32"	5,556	48	93	57	-7/32IN
	5,6		5,6	48	93	57	-5.6
	5,613	No. 2	5,613	48	93	57	-N02
	5,7		5,7	48	93	57	-5.7
	5,791	No. 1	5,791	48	93	57	-N01
	5,8		5,8	48	93	57	-5.8
	5,9		5,9	48	93	57	-5.9
	5,953	15/64"	5,953	48	93	57	-15/64IN
	6		6	48	93	57	-6
	6,1		6,1	52	101	63	-6.1
	6,2		6,2	52	101	63	-6.2
	6,3		6,3	52	101	63	-6.3
	6,35	1/4"	6,35	52	101	63	-1/4IN
	6,4		6,4	52	101	63	-6.4
	6,5		6,5	52	101	63	-6.5
	6,6		6,6	52	101	63	-6.6
	6,7		6,7	52	101	63	-6.7
	6,747	17/64"	6,747	57	109	69	-17/64IN
	6,8		6,8	57	109	69	-6.8
	6,9		6,9	57	109	69	-6.9
	7		7	57	109	69	-7
	7,1		7,1	57	109	69	-7.1
	7,144	9/32"	7,144	57	109	69	-9/32IN
	7,2		7,2	57	109	69	-7.2
	7,3		7,3	57	109	69	-7.3
	7,4		7,4	57	109	69	-7.4
	7,5		7,5	57	109	69	-7.5
	7,541	19/64"	7,541	62	117	75	-19/64IN
	7,6		7,6	62	117	75	-7.6
	7,7		7,7	62	117	75	-7.7
	7,8		7,8	62	117	75	-7.8
	7,9		7,9	62	117	75	-7.9
	7,938	5/16"	7,938	62	117	75	-5/16IN
	8		8	62	117	75	-8
	8,1		8,1	62	117	75	-8.1
	8,2		8,2	62	117	75	-8.2
	8,3		8,3	62	117	75	-8.3
	8,334	21/64"	8,334	62	117	75	-21/64IN
	8,4		8,4	62	117	75	-8.4
	8,5		8,5	62	117	75	-8.5

Continued



Deep-hole twist drill A1249TFL UFL®



~ 8 x D_c

Continued

	P	M	K	N	S	H	O
TFL	●●	●●	●●	●●	●●		●●

DIN 338	D _c h8 mm	D _c Inches/No	d ₁ f11 mm	L _c mm	l ₁ mm	l ₂ mm	Designation A1249TFL
Cylindrical shank 	8,6		8,6	66	125	81	-8.6
	8,7		8,7	66	125	81	-8.7
	8,731	11/32"	8,731	66	125	81	-11/32IN
	8,8		8,8	66	125	81	-8.8
	8,9		8,9	66	125	81	-8.9
	9		9	66	125	81	-9
	9,1		9,1	66	125	81	-9.1
	9,128	23/64"	9,128	66	125	81	-23/64IN
	9,2		9,2	66	125	81	-9.2
	9,3		9,3	66	125	81	-9.3
	9,4		9,4	66	125	81	-9.4
	9,5		9,5	66	125	81	-9.5
	9,525	3/8"	9,525	71	133	87	-3/8IN
	9,6		9,6	71	133	87	-9.6
	9,7		9,7	71	133	87	-9.7
	9,8		9,8	71	133	87	-9.8
	9,9		9,9	71	133	87	-9.9
	9,922	25/64"	9,922	71	133	87	-25/64IN
	10		10	71	133	87	-10
	10,2		10,2	71	133	87	-10.2
10,319	13/32"	10,319	71	133	87	-13/32IN	
10,5		10,5	71	133	87	-10.5	
10,716	27/64"	10,716	76	142	94	-27/64IN	
11		11	76	142	94	-11	
11,113	7/16"	11,113	76	142	94	-7/16IN	
11,2		11,2	76	142	94	-11.2	
11,3		11,3	76	142	94	-11.3	
11,5		11,5	76	142	94	-11.5	
11,509	29/64"	11,509	76	142	94	-29/64IN	
11,906	15/32"	11,906	87	151	101	-15/32IN	
12		12	87	151	101	-12	
12,303	31/64"	12,303	87	151	101	-31/64IN	
12,5		12,5	87	151	101	-12.5	
12,7	1/2"	12,7	87	151	101	-1/2IN	
13		13	87	151	101	-13	
13,1		13,1	87	151	101	-13.1	
13,3		13,3	94	160	108	-13.3	
13,5		13,5	94	160	108	-13.5	
14		14	94	160	108	-14	
14,5		14,5	99	169	114	-14.5	
15		15	99	169	114	-15	
15,1		15,1	104	178	120	-15.1	
15,3		15,3	104	178	120	-15.3	
15,5		15,5	104	178	120	-15.5	
16		16	104	178	120	-16	
16,5		16,5	108	184	125	-16.5	
17		17	108	184	125	-17	
17,5		17,5	112	191	130	-17.5	
18		18	112	191	130	-18	
18,5		18,5	116	198	135	-18.5	
19		19	116	198	135	-19	
19,5		19,5	120	205	140	-19.5	
20		20	120	205	140	-20	



Deep-hole twist drill

A1249XPL

UFL®



~ 8 x D_c

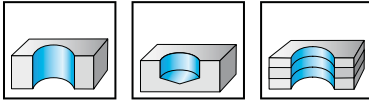

- HSS-E - XPL
- Type UFL®
- right-hand cutting
- 130° point angle

	P	M	K	N	S	H	O
XPL	●●	●●	●●	●●	●●		●●

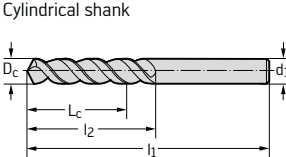
DIN 338	D _c h8 mm	D _c Inches/No	d ₁ f11 mm	L _c mm	l ₁ mm	l ₂ mm	Designation A1249XPL
Cylindrical shank 	1		1	10	34	12	-1
	1,016	No. 60	1,016	10	34	12	-NO60
	1,041	No. 59	1,041	10	34	12	-NO59
	1,067	No. 58	1,067	12	36	14	-NO58
	1,092	No. 57	1,092	12	36	14	-NO57
	1,1		1,1	12	36	14	-1.1
	1,181	No. 56	1,181	14	38	16	-NO56
	1,191	3/64"	1,191	14	38	16	-3/64IN
	1,2		1,2	14	38	16	-1.2
	1,3		1,3	14	38	16	-1.3
	1,321	No. 55	1,321	15	40	18	-NO55
	1,397	No. 54	1,397	15	40	18	-NO54
	1,4		1,4	15	40	18	-1.4
	1,5		1,5	15	40	18	-1.5
	1,511	No. 53	1,511	17	43	20	-NO53
	1,588	1/16"	1,588	17	43	20	-1/16IN
	1,6		1,6	17	43	20	-1.6
	1,613	No. 52	1,613	17	43	20	-NO52
	1,7		1,7	17	43	20	-1.7
	1,702	No. 51	1,702	19	46	22	-NO51
	1,778	No. 50	1,778	19	46	22	-NO50
	1,8		1,8	19	46	22	-1.8
	1,854	No. 49	1,854	19	46	22	-NO49
	1,9		1,9	19	46	22	-1.9
	1,93	No. 48	1,93	20	49	24	-NO48
	1,984	5/64"	1,984	20	49	24	-5/64IN
	1,994	No. 47	1,994	20	49	24	-NO47
	2		2	20	49	24	-2
	2,057	No. 46	2,057	20	49	24	-NO46
	2,083	No. 45	2,083	20	49	24	-NO45
	2,1		2,1	20	49	24	-2.1
	2,184	No. 44	2,184	23	53	27	-NO44
	2,2		2,2	23	53	27	-2.2
	2,261	No. 43	2,261	23	53	27	-NO43
2,3		2,3	23	53	27	-2.3	
2,375	No. 42	2,375	26	57	30	-NO42	
2,381	3/32"	2,381	26	57	30	-3/32IN	
2,4		2,4	26	57	30	-2.4	
2,438	No. 41	2,438	26	57	30	-NO41	
2,489	No. 40	2,489	26	57	30	-NO40	
2,5		2,5	26	57	30	-2.5	
2,527	No. 39	2,527	26	57	30	-NO39	
2,578	No. 38	2,578	26	57	30	-NO38	
2,6		2,6	26	57	30	-2.6	
2,642	No. 37	2,642	26	57	30	-NO37	
2,7		2,7	28	61	33	-2.7	
2,705	No. 36	2,705	28	61	33	-NO36	

Continued



Deep-hole twist drill A1249XPL UFL®



~ 8 x D_c

	P	M	K	N	S	H	O
XPL	●●	●●	●●	●●	●●		●●

Continued

DIN 338	D _c h8 mm	D _c Inches/No	d ₁ f11 mm	L _c mm	l ₁ mm	l ₂ mm	Designation A1249XPL
Cylindrical shank	2,778	7/64"	2,778	28	61	33	-7/64IN
	2,794	No. 35	2,794	28	61	33	-N035
	2,8		2,8	28	61	33	-2.8
	2,819	No. 34	2,819	28	61	33	-N034
	2,87	No. 33	2,87	28	61	33	-N033
	2,9		2,9	28	61	33	-2.9
	2,946	No. 32	2,946	28	61	33	-N032
	3		3	28	61	33	-3
	3,048	No. 31	3,048	30	65	36	-N031
	3,1		3,1	30	65	36	-3.1
	3,175	1/8"	3,175	30	65	36	-1/8IN
	3,2		3,2	30	65	36	-3.2
	3,264	No. 30	3,264	30	65	36	-N030
	3,3		3,3	30	65	36	-3.3
	3,4		3,4	33	70	39	-3.4
	3,454	No. 29	3,454	33	70	39	-N029
	3,5		3,5	33	70	39	-3.5
	3,569	No. 28	3,569	33	70	39	-N028
	3,572	9/64"	3,572	33	70	39	-9/64IN
	3,6		3,6	33	70	39	-3.6
	3,658	No. 27	3,658	33	70	39	-N027
	3,7		3,7	33	70	39	-3.7
	3,734	No. 26	3,734	33	70	39	-N026
	3,797	No. 25	3,797	36	75	43	-N025
	3,8		3,8	36	75	43	-3.8
	3,861	No. 24	3,861	36	75	43	-N024
	3,9		3,9	36	75	43	-3.9
	3,912	No. 23	3,912	36	75	43	-N023
	3,969	5/32"	3,969	36	75	43	-5/32IN
	3,988	No. 22	3,988	36	75	43	-N022
	4		4	36	75	43	-4
	4,039	No. 21	4,039	36	75	43	-N021
	4,089	No. 20	4,089	36	75	43	-N020
	4,1		4,1	36	75	43	-4.1
	4,2		4,2	36	75	43	-4.2
	4,216	No. 19	4,216	36	75	43	-N019
	4,3		4,3	39	80	47	-4.3
	4,305	No. 18	4,305	39	80	47	-N018
	4,366	11/64"	4,366	39	80	47	-11/64IN
	4,394	No. 17	4,394	39	80	47	-N017
	4,4		4,4	39	80	47	-4.4
	4,496	No. 16	4,496	39	80	47	-N016
	4,5		4,5	39	80	47	-4.5
	4,572	No. 15	4,572	39	80	47	-N015
	4,6		4,6	39	80	47	-4.6
	4,623	No. 14	4,623	39	80	47	-N014
	4,65		4,65	39	80	47	-4.65
	4,699	No. 13	4,699	39	80	47	-N013
	4,7		4,7	39	80	47	-4.7
	4,763	3/16"	4,763	44	86	52	-3/16IN
	4,8		4,8	44	86	52	-4.8
	4,801	No. 12	4,801	44	86	52	-N012
	4,851	No. 11	4,851	44	86	52	-N011
	4,9		4,9	44	86	52	-4.9
	4,915	No. 10	4,915	44	86	52	-N010

Continued



Deep-hole twist drill

A1249XPL

UFL®



~ 8 x D_c

Continued

	P	M	K	N	S	H	O
XPL	●●	●●	●●	●●	●●		●●

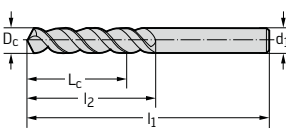
DIN 338	D _c h8 mm	D _c Inches/No	d ₁ f11 mm	L _c mm	l ₁ mm	l ₂ mm	Designation A1249XPL
Cylindrical shank	4,978	No. 9	4,978	44	86	52	-N09
	5		5	44	86	52	-5
	5,055	No. 8	5,055	44	86	52	-N08
	5,1		5,1	44	86	52	-5.1
	5,105	No. 7	5,105	44	86	52	-N07
	5,159	13/64"	5,159	44	86	52	-13/64IN
	5,182	No. 6	5,182	44	86	52	-N06
	5,2		5,2	44	86	52	-5.2
	5,22	No. 5	5,22	44	86	52	-N05
	5,3		5,3	44	86	52	-5.3
	5,309	No. 4	5,309	48	93	57	-N04
	5,4		5,4	48	93	57	-5.4
	5,41	No. 3	5,41	48	93	57	-N03
	5,5		5,5	48	93	57	-5.5
	5,55		5,55	48	93	57	-5.55
	5,556	7/32"	5,556	48	93	57	-7/32IN
	5,6		5,6	48	93	57	-5.6
	5,613	No. 2	5,613	48	93	57	-N02
	5,7		5,7	48	93	57	-5.7
	5,791	No. 1	5,791	48	93	57	-N01
	5,8		5,8	48	93	57	-5.8
	5,9		5,9	48	93	57	-5.9
	5,953	15/64"	5,953	48	93	57	-15/64IN
	6		6	48	93	57	-6
	6,1		6,1	52	101	63	-6.1
	6,2		6,2	52	101	63	-6.2
	6,3		6,3	52	101	63	-6.3
	6,35	1/4"	6,35	52	101	63	-1/4IN
	6,4		6,4	52	101	63	-6.4
	6,5		6,5	52	101	63	-6.5
	6,6		6,6	52	101	63	-6.6
	6,7		6,7	52	101	63	-6.7
	6,747	17/64"	6,747	57	109	69	-17/64IN
	6,8		6,8	57	109	69	-6.8
	6,9		6,9	57	109	69	-6.9
	7		7	57	109	69	-7
	7,1		7,1	57	109	69	-7.1
	7,144	9/32"	7,144	57	109	69	-9/32IN
	7,2		7,2	57	109	69	-7.2
	7,3		7,3	57	109	69	-7.3
	7,4		7,4	57	109	69	-7.4
	7,5		7,5	57	109	69	-7.5
	7,541	19/64"	7,541	62	117	75	-19/64IN
	7,6		7,6	62	117	75	-7.6
	7,7		7,7	62	117	75	-7.7
	7,8		7,8	62	117	75	-7.8
	7,9		7,9	62	117	75	-7.9
	7,938	5/16"	7,938	62	117	75	-5/16IN
	8		8	62	117	75	-8
	8,1		8,1	62	117	75	-8.1
	8,2		8,2	62	117	75	-8.2
	8,3		8,3	62	117	75	-8.3
	8,334	21/64"	8,334	62	117	75	-21/64IN
	8,4		8,4	62	117	75	-8.4
	8,5		8,5	62	117	75	-8.5

Continued



Deep-hole twist drill A1249XPL UFL®



~ 8 x D_c

	P	M	K	N	S	H	O
XPL	●●	●●	●●	●●	●●		●●

Continued

DIN 338	D _c h8 mm	D _c Inches/No	d ₁ f11 mm	L _c mm	l ₁ mm	l ₂ mm	Designation A1249XPL
Cylindrical shank 	8,6		8,6	66	125	81	-8.6
	8,7		8,7	66	125	81	-8.7
	8,731	11/32"	8,731	66	125	81	-11/32IN
	8,8		8,8	66	125	81	-8.8
	8,9		8,9	66	125	81	-8.9
	9		9	66	125	81	-9
	9,1		9,1	66	125	81	-9.1
	9,128	23/64"	9,128	66	125	81	-23/64IN
	9,2		9,2	66	125	81	-9.2
	9,3		9,3	66	125	81	-9.3
	9,4		9,4	66	125	81	-9.4
	9,5		9,5	66	125	81	-9.5
	9,525	3/8"	9,525	71	133	87	-3/8IN
	9,6		9,6	71	133	87	-9.6
	9,7		9,7	71	133	87	-9.7
	9,8		9,8	71	133	87	-9.8
	9,9		9,9	71	133	87	-9.9
	9,922	25/64"	9,922	71	133	87	-25/64IN
	10		10	71	133	87	-10
	10,2		10,2	71	133	87	-10.2
	10,319	13/32"	10,319	71	133	87	-13/32IN
	10,5		10,5	71	133	87	-10.5
	10,716	27/64"	10,716	76	142	94	-27/64IN
	11		11	76	142	94	-11
	11,113	7/16"	11,113	76	142	94	-7/16IN
	11,2		11,2	76	142	94	-11.2
	11,3		11,3	76	142	94	-11.3
	11,5		11,5	76	142	94	-11.5
	11,509	29/64"	11,509	76	142	94	-29/64IN
	11,906	15/32"	11,906	87	151	101	-15/32IN
	12		12	87	151	101	-12
	12,303	31/64"	12,303	87	151	101	-31/64IN
12,5		12,5	87	151	101	-12.5	
12,7	1/2"	12,7	87	151	101	-1/2IN	
13		13	87	151	101	-13	
13,1		13,1	87	151	101	-13.1	
13,3		13,3	94	160	108	-13.3	
13,5		13,5	94	160	108	-13.5	
14		14	94	160	108	-14	
14,5		14,5	99	169	114	-14.5	
15		15	99	169	114	-15	
15,1		15,1	104	178	120	-15.1	
15,3		15,3	104	178	120	-15.3	
15,5		15,5	104	178	120	-15.5	
16		16	104	178	120	-16	



Deep-hole twist drill

A1254TFT

VA Inox



~ 8 x D_c

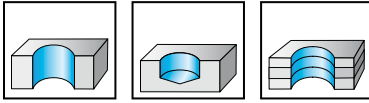

- HSS-E - TFT
- Type VA Inox
- right-hand cutting
- 118° point angle

	P	M	K	N	S	H	O
TFT	●●	●●	●●	●●	●●		

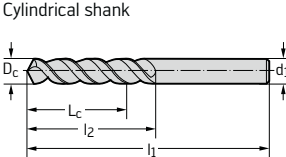
DIN 338	D _c h8 mm	d ₁ f11 mm	L _c mm	l ₁ mm	l ₂ mm	Designation A1254TFT
Cylindrical shank 	3	3	28	61	33	-3
	3,2	3,2	30	65	36	-3.2
	3,3	3,3	30	65	36	-3.3
	3,4	3,4	33	70	39	-3.4
	3,5	3,5	33	70	39	-3.5
	3,7	3,7	33	70	39	-3.7
	3,8	3,8	36	75	43	-3.8
	4	4	36	75	43	-4
	4,2	4,2	36	75	43	-4.2
	4,3	4,3	39	80	47	-4.3
	4,5	4,5	39	80	47	-4.5
	4,65	4,65	39	80	47	-4.65
	4,7	4,7	39	80	47	-4.7
	4,8	4,8	44	86	52	-4.8
	5	5	44	86	52	-5
	5,1	5,1	44	86	52	-5.1
	5,3	5,3	44	86	52	-5.3
	5,5	5,5	48	93	57	-5.5
	5,55	5,55	48	93	57	-5.55
	5,6	5,6	48	93	57	-5.6
	5,8	5,8	48	93	57	-5.8
	6	6	48	93	57	-6
	6,5	6,5	52	101	63	-6.5
	6,6	6,6	52	101	63	-6.6
	6,8	6,8	57	109	69	-6.8
	6,9	6,9	57	109	69	-6.9
	7	7	57	109	69	-7
	7,4	7,4	57	109	69	-7.4
7,5	7,5	57	109	69	-7.5	
7,8	7,8	62	117	75	-7.8	
8	8	62	117	75	-8	
8,5	8,5	62	117	75	-8.5	
8,6	8,6	66	125	81	-8.6	
8,8	8,8	66	125	81	-8.8	
9	9	66	125	81	-9	
9,3	9,3	66	125	81	-9.3	
9,4	9,4	66	125	81	-9.4	
9,5	9,5	66	125	81	-9.5	
9,8	9,8	71	133	87	-9.8	
10	10	71	133	87	-10	
10,2	10,2	71	133	87	-10.2	
10,3	10,3	71	133	87	-10.3	
10,5	10,5	71	133	87	-10.5	
11	11	76	142	94	-11	
11,2	11,2	76	142	94	-11.2	
11,3	11,3	76	142	94	-11.3	
11,5	11,5	76	142	94	-11.5	

Continued



Deep-hole twist drill A1254TFT VA Inox



~ 8 x D_c

	P	M	K	N	S	H	O
TFT	●●	●●	●●	●●	●●		

Continued

DIN 338	D _c h8 mm	d ₁ f11 mm	L _c mm	l ₁ mm	l ₂ mm	Designation A1254TFT
Cylindrical shank	11,8	11,8	76	142	94	-11.8
	12	12	87	151	101	-12
	12,1	12,1	87	151	101	-12.1
	12,5	12,5	87	151	101	-12.5
	13	13	87	151	101	-13
	13,2	13,2	87	151	101	-13.2
	13,5	13,5	94	160	108	-13.5
	14	14	94	160	108	-14
	14,1	14,1	99	169	114	-14.1
	14,2	14,2	99	169	114	-14.2
	14,5	14,5	99	169	114	-14.5
	15	15	99	169	114	-15
	15,1	15,1	104	178	120	-15.1
	15,2	15,2	104	178	120	-15.2
	15,5	15,5	104	178	120	-15.5
	16	16	104	178	120	-16

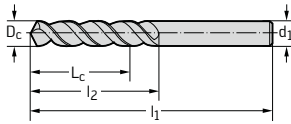

Long twist drill A1511



~ 12 x D_c

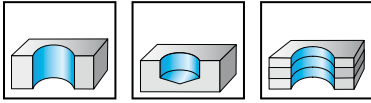

- HSS - steam treated
- Type N
- right-hand cutting
- 118° point angle
- up to 3 mm bright finish

	P	M	K	N	S	H	O
uncoated	●	●	●●	●●●	●		●●

DIN 340	D _c h8 mm	d ₁ f11 mm	L _c mm	l ₁ mm	l ₂ mm	Designation A1511
Cylindrical shank	0,5	0,5	11,2	32	12	-0,5
	0,6	0,6	14,1	35	15	-0,6
	0,7	0,7	19,8	42	21	-0,7
	0,8	0,8	23,7	46	25	-0,8
	0,9	0,9	27,5	51	29	-0,9
	1	1	31	56	33	-1
	1,1	1,1	35	60	37	-1,1
	1,2	1,2	39	65	41	-1,2
	1,3	1,3	39	65	41	-1,3
	1,4	1,4	42	70	45	-1,4
	1,5	1,5	42	70	45	-1,5
	1,55	1,55	47	76	50	-1,55
	1,6	1,6	47	76	50	-1,6
	1,65	1,65	47	76	50	-1,65
	1,7	1,7	47	76	50	-1,7
	1,75	1,75	50	80	53	-1,75
	1,8	1,8	50	80	53	-1,8
	1,9	1,9	50	80	53	-1,9
	2	2	52	85	56	-2
	2,05	2,05	52	85	56	-2,05
	2,1	2,1	52	85	56	-2,1
	2,2	2,2	55	90	59	-2,2
	2,25	2,25	55	90	59	-2,25
	2,3	2,3	55	90	59	-2,3
	2,4	2,4	58	95	62	-2,4
	2,5	2,5	58	95	62	-2,5
	2,55	2,55	58	95	62	-2,55
	2,6	2,6	58	95	62	-2,6
	2,7	2,7	61	100	66	-2,7
	2,8	2,8	61	100	66	-2,8
	2,9	2,9	61	100	66	-2,9
	3	3	61	100	66	-3
	3,05	3,05	63	106	69	-3,05
	3,1	3,1	63	106	69	-3,1
	3,15	3,15	63	106	69	-3,15
	3,2	3,2	63	106	69	-3,2
	3,25	3,25	63	106	69	-3,25
	3,3	3,3	63	106	69	-3,3
	3,4	3,4	67	112	73	-3,4
	3,5	3,5	67	112	73	-3,5
	3,6	3,6	67	112	73	-3,6
	3,7	3,7	67	112	73	-3,7
	3,75	3,75	67	112	73	-3,75
	3,8	3,8	71	119	78	-3,8
	3,9	3,9	71	119	78	-3,9
	4	4	71	119	78	-4
	4,05	4,05	71	119	78	-4,05

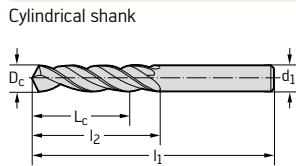

Continued



Long twist drill A1511



~ 12 x D_c

Continued

	P	M	K	N	S	H	O
uncoated	●	●	●●	●●	●		●●

DIN 340	D _c h8 mm	d ₁ f11 mm	L _c mm	l ₁ mm	l ₂ mm	Designation A1511
Cylindrical shank 	4,1	4,1	71	119	78	-4.1
	4,2	4,2	71	119	78	-4.2
	4,25	4,25	71	119	78	-4.25
	4,3	4,3	74	126	82	-4.3
	4,4	4,4	74	126	82	-4.4
	4,5	4,5	74	126	82	-4.5
	4,6	4,6	74	126	82	-4.6
	4,7	4,7	74	126	82	-4.7
	4,75	4,75	74	126	82	-4.75
	4,8	4,8	79	132	87	-4.8
	4,9	4,9	79	132	87	-4.9
	5	5	79	132	87	-5
	5,1	5,1	79	132	87	-5.1
	5,2	5,2	79	132	87	-5.2
	5,25	5,25	79	132	87	-5.25
	5,3	5,3	79	132	87	-5.3
	5,4	5,4	82	139	91	-5.4
	5,5	5,5	82	139	91	-5.5
	5,6	5,6	82	139	91	-5.6
	5,7	5,7	82	139	91	-5.7
	5,75	5,75	82	139	91	-5.75
	5,8	5,8	82	139	91	-5.8
	5,9	5,9	82	139	91	-5.9
	6	6	82	139	91	-6
	6,1	6,1	86	148	97	-6.1
	6,2	6,2	86	148	97	-6.2
	6,25	6,25	86	148	97	-6.25
	6,3	6,3	86	148	97	-6.3
6,4	6,4	86	148	97	-6.4	
6,5	6,5	86	148	97	-6.5	
6,6	6,6	86	148	97	-6.6	
6,7	6,7	86	148	97	-6.7	
6,75	6,75	90	156	102	-6.75	
6,8	6,8	90	156	102	-6.8	
6,9	6,9	90	156	102	-6.9	
7	7	90	156	102	-7	
7,1	7,1	90	156	102	-7.1	
7,2	7,2	90	156	102	-7.2	
7,25	7,25	90	156	102	-7.25	
7,3	7,3	90	156	102	-7.3	
7,4	7,4	90	156	102	-7.4	
7,5	7,5	90	156	102	-7.5	
7,6	7,6	96	165	109	-7.6	
7,7	7,7	96	165	109	-7.7	
7,75	7,75	96	165	109	-7.75	
7,8	7,8	96	165	109	-7.8	
7,9	7,9	96	165	109	-7.9	
8	8	96	165	109	-8	
8,1	8,1	96	165	109	-8.1	
8,2	8,2	96	165	109	-8.2	
8,25	8,25	96	165	109	-8.25	
8,3	8,3	96	165	109	-8.3	
8,4	8,4	96	165	109	-8.4	
8,5	8,5	96	165	109	-8.5	
8,6	8,6	100	175	115	-8.6	

Continued



Long twist drill A1511



~ 12 x D_c

Continued

	P	M	K	N	S	H	O
uncoated	●	●	●●	●●●	●		●●

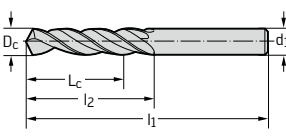
DIN 340	D _c h8 mm	d ₁ f11 mm	L _c mm	l ₁ mm	l ₂ mm	Designation A1511
Cylindrical shank 	8,7	8,7	100	175	115	-8.7
	8,75	8,75	100	175	115	-8.75
	8,8	8,8	100	175	115	-8.8
	8,9	8,9	100	175	115	-8.9
	9	9	100	175	115	-9
	9,1	9,1	100	175	115	-9.1
	9,2	9,2	100	175	115	-9.2
	9,25	9,25	100	175	115	-9.25
	9,3	9,3	100	175	115	-9.3
	9,4	9,4	100	175	115	-9.4
	9,5	9,5	100	175	115	-9.5
	9,6	9,6	105	184	121	-9.6
	9,7	9,7	105	184	121	-9.7
	9,75	9,75	105	184	121	-9.75
	9,8	9,8	105	184	121	-9.8
	9,9	9,9	105	184	121	-9.9
	10	10	105	184	121	-10
	10,1	10,1	105	184	121	-10.1
	10,2	10,2	105	184	121	-10.2
	10,3	10,3	105	184	121	-10.3
	10,4	10,4	105	184	121	-10.4
	10,5	10,5	105	184	121	-10.5
10,7	10,7	110	195	128	-10.7	
10,8	10,8	110	195	128	-10.8	
11	11	110	195	128	-11	
11,5	11,5	110	195	128	-11.5	
11,8	11,8	110	195	128	-11.8	
12	12	120	205	134	-12	
12,5	12,5	120	205	134	-12.5	
13	13	120	205	134	-13	
13,5	13,5	126	214	140	-13.5	
14	14	126	214	140	-14	
14,5	14,5	129	220	144	-14.5	
15	15	129	220	144	-15	
15,5	15,5	133	227	149	-15.5	
16	16	133	227	149	-16	
17	17	137	235	154	-17	
18	18	140	241	158	-18	
19	19	143	247	162	-19	
20	20	146	254	166	-20	
21	21	149	261	171	-21	
22	22	153	268	176	-22	

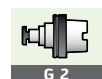

Long deep-hole twist drill A1522 UFL®



~ 12 x D_c

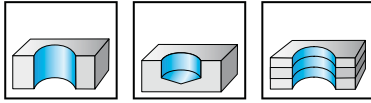

- HSS - fibre-steamed
- Type UFL®
- right-hand cutting
- 130° point angle
- up to 1.9 mm bright finish

	P	M	K	N	S	H	O
uncoated	●●	●	●●	●●	●		●●

DIN 340	D _c h8 mm	D _c Inches/No	d ₁ f11 mm	L _c mm	l ₁ mm	l ₂ mm	Designation A1522
Cylindrical shank 	1		1	31	56	33	-1
	1,016	No. 60	1,016	31	56	33	-NO60
	1,041	No. 59	1,041	31	56	33	-NO59
	1,067	No. 58	1,067	35	60	37	-NO58
	1,092	No. 57	1,092	35	60	37	-NO57
	1,1		1,1	35	60	37	-1.1
	1,181	No. 56	1,181	39	65	41	-NO56
	1,191	3/64"	1,191	39	65	41	-3/64IN
	1,2		1,2	39	65	41	-1.2
	1,3		1,3	39	65	41	-1.3
	1,321	No. 55	1,321	42	70	45	-NO55
	1,397	No. 54	1,397	42	70	45	-NO54
	1,4		1,4	42	70	45	-1.4
	1,5		1,5	42	70	45	-1.5
	1,511	No. 53	1,511	47	76	50	-NO53
	1,588	1/16"	1,588	47	76	50	-1/16IN
	1,6		1,6	47	76	50	-1.6
	1,613	No. 52	1,613	47	76	50	-NO52
	1,7		1,7	47	76	50	-1.7
	1,702	No. 51	1,702	50	80	53	-NO51
	1,778	No. 50	1,778	50	80	53	-NO50
	1,8		1,8	50	80	53	-1.8
	1,854	No. 49	1,854	50	80	53	-NO49
	1,9		1,9	50	80	53	-1.9
	1,93	No. 48	1,93	52	85	56	-NO48
	1,984	5/64"	1,984	52	85	56	-5/64IN
	1,994	No. 47	1,994	52	85	56	-NO47
	2		2	52	85	56	-2
	2,057	No. 46	2,057	52	85	56	-NO46
	2,083	No. 45	2,083	52	85	56	-NO45
	2,1		2,1	52	85	56	-2.1
	2,184	No. 44	2,184	55	90	59	-NO44
	2,2		2,2	55	90	59	-2.2
	2,261	No. 43	2,261	55	90	59	-NO43
	2,3		2,3	55	90	59	-2.3
	2,375	No. 42	2,375	58	95	62	-NO42
2,381	3/32"	2,381	58	95	62	-3/32IN	
2,4		2,4	58	95	62	-2.4	
2,438	No. 41	2,438	58	95	62	-NO41	
2,489	No. 40	2,489	58	95	62	-NO40	
2,5		2,5	58	95	62	-2.5	
2,527	No. 39	2,527	58	95	62	-NO39	
2,578	No. 38	2,578	58	95	62	-NO38	
2,6		2,6	58	95	62	-2.6	
2,642	No. 37	2,642	58	95	62	-NO37	
2,7		2,7	61	100	66	-2.7	
2,705	No. 36	2,705	61	100	66	-NO36	

Continued



Long deep-hole twist drill

A1522

UFL®

~ 12 x D_c



Continued

	P	M	K	N	S	H	O
uncoated	●●	●	●●	●●	●		●●

DIN 340	D _c h8 mm	D _c Inches/No	d ₁ f11 mm	L _c mm	l ₁ mm	l ₂ mm	Designation A1522
Cylindrical shank	2,778	7/64"	2,778	61	100	66	-7/64IN
	2,794	No. 35	2,794	61	100	66	-N035
	2,8		2,8	61	100	66	-2.8
	2,819	No. 34	2,819	61	100	66	-N034
	2,87	No. 33	2,87	61	100	66	-N033
	2,9		2,9	61	100	66	-2.9
	2,946	No. 32	2,946	61	100	66	-N032
	3		3	61	100	66	-3
	3,048	No. 31	3,048	63	106	69	-N031
	3,1		3,1	63	106	69	-3.1
	3,175	1/8"	3,175	63	106	69	-1/8IN
	3,2		3,2	63	106	69	-3.2
	3,264	No. 30	3,264	63	106	69	-N030
	3,3		3,3	63	106	69	-3.3
	3,4		3,4	67	112	73	-3.4
	3,454	No. 29	3,454	67	112	73	-N029
	3,5		3,5	67	112	73	-3.5
	3,569	No. 28	3,569	67	112	73	-N028
	3,572	9/64"	3,572	67	112	73	-9/64IN
	3,6		3,6	67	112	73	-3.6
	3,658	No. 27	3,658	67	112	73	-N027
	3,7		3,7	67	112	73	-3.7
	3,734	No. 26	3,734	67	112	73	-N026
	3,797	No. 25	3,797	71	119	78	-N025
	3,8		3,8	71	119	78	-3.8
	3,861	No. 24	3,861	71	119	78	-N024
	3,9		3,9	71	119	78	-3.9
	3,912	No. 23	3,912	71	119	78	-N023
	3,969	5/32"	3,969	71	119	78	-5/32IN
	3,988	No. 22	3,988	71	119	78	-N022
	4		4	71	119	78	-4
	4,039	No. 21	4,039	71	119	78	-N021
	4,089	No. 20	4,089	71	119	78	-N020
	4,1		4,1	71	119	78	-4.1
	4,2		4,2	71	119	78	-4.2
	4,216	No. 19	4,216	71	119	78	-N019
	4,3		4,3	74	126	82	-4.3
	4,305	No. 18	4,305	74	126	82	-N018
	4,366	11/64"	4,366	74	126	82	-11/64IN
	4,394	No. 17	4,394	74	126	82	-N017
	4,4		4,4	74	126	82	-4.4
	4,496	No. 16	4,496	74	126	82	-N016
	4,5		4,5	74	126	82	-4.5
	4,572	No. 15	4,572	74	126	82	-N015
	4,6		4,6	74	126	82	-4.6
	4,623	No. 14	4,623	74	126	82	-N014
	4,699	No. 13	4,699	74	126	82	-N013
	4,7		4,7	74	126	82	-4.7
	4,763	3/16"	4,763	79	132	87	-3/16IN
	4,8		4,8	79	132	87	-4.8
	4,801	No. 12	4,801	79	132	87	-N012
	4,851	No. 11	4,851	79	132	87	-N011
	4,9		4,9	79	132	87	-4.9
	4,915	No. 10	4,915	79	132	87	-N010
	4,978	No. 9	4,978	79	132	87	-N09

Continued



Long deep-hole twist drill

A1522

UFL®



~ 12 x D_c

Continued

	P	M	K	N	S	H	O
uncoated	●●	●	●●	●●	●		●●

DIN 340	D _c h8 mm	D _c Inches/No	d ₁ f11 mm	L _c mm	l ₁ mm	l ₂ mm	Designation A1522
Cylindrical shank 	5		5	79	132	87	-5
	5,055	No. 8	5,055	79	132	87	-N08
	5,1		5,1	79	132	87	-5.1
	5,105	No. 7	5,105	79	132	87	-N07
	5,159	13/64"	5,159	79	132	87	-13/64IN
	5,182	No. 6	5,182	79	132	87	-N06
	5,2		5,2	79	132	87	-5.2
	5,22	No. 5	5,22	79	132	87	-N05
	5,3		5,3	79	132	87	-5.3
	5,309	No. 4	5,309	82	139	91	-N04
	5,4		5,4	82	139	91	-5.4
	5,41	No. 3	5,41	82	139	91	-N03
	5,5		5,5	82	139	91	-5.5
	5,556	7/32"	5,556	82	139	91	-7/32IN
	5,6		5,6	82	139	91	-5.6
	5,613	No. 2	5,613	82	139	91	-N02
	5,7		5,7	82	139	91	-5.7
	5,791	No. 1	5,791	82	139	91	-N01
	5,8		5,8	82	139	91	-5.8
	5,9		5,9	82	139	91	-5.9
	5,953	15/64"	5,953	82	139	91	-15/64IN
	6		6	82	139	91	-6
	6,1		6,1	86	148	97	-6.1
	6,2		6,2	86	148	97	-6.2
	6,3		6,3	86	148	97	-6.3
	6,35	1/4"	6,35	86	148	97	-1/4IN
	6,4		6,4	86	148	97	-6.4
	6,5		6,5	86	148	97	-6.5
	6,6		6,6	86	148	97	-6.6
	6,7		6,7	86	148	97	-6.7
	6,747	17/64"	6,747	90	156	102	-17/64IN
	6,8		6,8	90	156	102	-6.8
	6,9		6,9	90	156	102	-6.9
	7		7	90	156	102	-7
7,1		7,1	90	156	102	-7.1	
7,144	9/32"	7,144	90	156	102	-9/32IN	
7,2		7,2	90	156	102	-7.2	
7,3		7,3	90	156	102	-7.3	
7,4		7,4	90	156	102	-7.4	
7,5		7,5	90	156	102	-7.5	
7,541	19/64"	7,541	96	165	109	-19/64IN	
7,6		7,6	96	165	109	-7.6	
7,7		7,7	96	165	109	-7.7	
7,8		7,8	96	165	109	-7.8	
7,9		7,9	96	165	109	-7.9	
7,938	5/16"	7,938	96	165	109	-5/16IN	
8		8	96	165	109	-8	
8,1		8,1	96	165	109	-8.1	
8,2		8,2	96	165	109	-8.2	
8,3		8,3	96	165	109	-8.3	
8,334	21/64"	8,334	96	165	109	-21/64IN	
8,4		8,4	96	165	109	-8.4	
8,5		8,5	96	165	109	-8.5	
8,6		8,6	100	175	115	-8.6	
8,7		8,7	100	175	115	-8.7	

Continued



Long deep-hole twist drill

A1522

UFL®



~ 12 x D_c

Continued

	P	M	K	N	S	H	O
uncoated	●●	●	●●	●●	●		●●

DIN 340	D _c h8 mm	D _c Inches/No	d ₁ f11 mm	L _c mm	l ₁ mm	l ₂ mm	Designation A1522
Cylindrical shank 	8,731	11/32"	8,731	100	175	115	-11/32IN
	8,8		8,8	100	175	115	-8.8
	8,9		8,9	100	175	115	-8.9
	9		9	100	175	115	-9
	9,1		9,1	100	175	115	-9.1
	9,128	23/64"	9,128	100	175	115	-23/64IN
	9,2		9,2	100	175	115	-9.2
	9,3		9,3	100	175	115	-9.3
	9,4		9,4	100	175	115	-9.4
	9,5		9,5	100	175	115	-9.5
	9,525	3/8"	9,525	105	184	121	-3/8IN
	9,6		9,6	105	184	121	-9.6
	9,7		9,7	105	184	121	-9.7
	9,8		9,8	105	184	121	-9.8
	9,9		9,9	105	184	121	-9.9
	9,922	25/64"	9,922	105	184	121	-25/64IN
	10		10	105	184	121	-10
	10,2		10,2	105	184	121	-10.2
	10,319	13/32"	10,319	105	184	121	-13/32IN
	10,5		10,5	105	184	121	-10.5
	10,716	27/64"	10,716	110	195	128	-27/64IN
	10,8		10,8	110	195	128	-10.8
	11		11	110	195	128	-11
	11,113	7/16"	11,113	110	195	128	-7/16IN
	11,2		11,2	110	195	128	-11.2
	11,5		11,5	110	195	128	-11.5
	11,509	29/64"	11,509	110	195	128	-29/64IN
	11,8		11,8	110	195	128	-11.8
	11,906	15/32"	11,906	120	205	134	-15/32IN
	12		12	120	205	134	-12
	12,303	31/64"	12,303	120	205	134	-31/64IN
	12,7	1/2"	12,7	120	205	134	-1/2IN
	14,288	9/16"	14,288	129	220	144	-9/16IN
14,684	37/64"	14,684	129	220	144	-37/64IN	
15,478	39/64"	15,478	133	227	149	-39/64IN	
15,875	5/8"	15,875	133	227	149	-5/8IN	
16,669	21/32"	16,669	137	235	154	-21/32IN	
17,463	11/16"	17,463	140	241	158	-11/16IN	
19,05	3/4"	19,05	146	254	166	-3/4IN	
19,844	25/32"	19,844	146	254	166	-25/32IN	
20,638	13/16"	20,638	149	261	171	-13/16IN	
22,225	7/8"	22,225	153	268	176	-7/8IN	

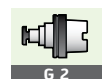

Long twist drill A1544 VA



~ 12 x D_c

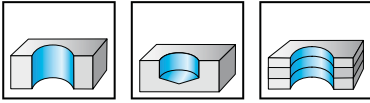

- HSS-E - uncoated
- Type VA
- right-hand cutting
- 130° point angle

	P	M	K	N	S	H	O
uncoated	●●	●●	●●	●●	●●		

DIN 340	D _c h8 mm	d ₁ f11 mm	L _c mm	l ₁ mm	l ₂ mm	Designation A1544
Cylindrical shank	1	1	31	56	33	-1
	1,1	1,1	35	60	37	-1.1
	1,2	1,2	39	65	41	-1.2
	1,3	1,3	39	65	41	-1.3
	1,4	1,4	42	70	45	-1.4
	1,5	1,5	42	70	45	-1.5
	1,6	1,6	47	76	50	-1.6
	1,7	1,7	47	76	50	-1.7
	1,8	1,8	50	80	53	-1.8
	1,9	1,9	50	80	53	-1.9
	2	2	52	85	56	-2
	2,1	2,1	52	85	56	-2.1
	2,2	2,2	55	90	59	-2.2
	2,3	2,3	55	90	59	-2.3
	2,4	2,4	58	95	62	-2.4
	2,5	2,5	58	95	62	-2.5
	2,6	2,6	58	95	62	-2.6
	2,7	2,7	61	100	66	-2.7
	2,8	2,8	61	100	66	-2.8
	2,9	2,9	61	100	66	-2.9
	3	3	61	100	66	-3
	3,1	3,1	63	106	69	-3.1
	3,2	3,2	63	106	69	-3.2
	3,3	3,3	63	106	69	-3.3
	3,4	3,4	67	112	73	-3.4
	3,5	3,5	67	112	73	-3.5
	3,6	3,6	67	112	73	-3.6
	3,7	3,7	67	112	73	-3.7
	3,8	3,8	71	119	78	-3.8
	3,9	3,9	71	119	78	-3.9
	4	4	71	119	78	-4
	4,1	4,1	71	119	78	-4.1
	4,2	4,2	71	119	78	-4.2
	4,3	4,3	74	126	82	-4.3
	4,4	4,4	74	126	82	-4.4
	4,5	4,5	74	126	82	-4.5
	4,6	4,6	74	126	82	-4.6
	4,7	4,7	74	126	82	-4.7
	4,8	4,8	79	132	87	-4.8
	4,9	4,9	79	132	87	-4.9
	5	5	79	132	87	-5
	5,1	5,1	79	132	87	-5.1
	5,2	5,2	79	132	87	-5.2
	5,3	5,3	79	132	87	-5.3
	5,4	5,4	82	139	91	-5.4
	5,5	5,5	82	139	91	-5.5
	5,6	5,6	82	139	91	-5.6

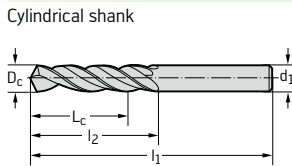

Continued



Long twist drill

A1544

VA



~ 12 x D_c

Continued

	P	M	K	N	S	H	O
uncoated	●●	●●	●●	●●	●●		

DIN 340	D _c h8 mm	d ₁ f11 mm	L _c mm	l ₁ mm	l ₂ mm	Designation A1544
Cylindrical shank	5,7	5,7	82	139	91	-5.7
	5,8	5,8	82	139	91	-5.8
	5,9	5,9	82	139	91	-5.9
	6	6	82	139	91	-6
	6,1	6,1	86	148	97	-6.1
	6,2	6,2	86	148	97	-6.2
	6,3	6,3	86	148	97	-6.3
	6,4	6,4	86	148	97	-6.4
	6,5	6,5	86	148	97	-6.5
	6,6	6,6	86	148	97	-6.6
	6,7	6,7	86	148	97	-6.7
	6,8	6,8	90	156	102	-6.8
	6,9	6,9	90	156	102	-6.9
	7	7	90	156	102	-7
	7,1	7,1	90	156	102	-7.1
	7,2	7,2	90	156	102	-7.2
	7,3	7,3	90	156	102	-7.3
	7,4	7,4	90	156	102	-7.4
	7,5	7,5	90	156	102	-7.5
	7,6	7,6	96	165	109	-7.6
	7,7	7,7	96	165	109	-7.7
	7,8	7,8	96	165	109	-7.8
	7,9	7,9	96	165	109	-7.9
	8	8	96	165	109	-8
	8,1	8,1	96	165	109	-8.1
	8,2	8,2	96	165	109	-8.2
	8,3	8,3	96	165	109	-8.3
	8,4	8,4	96	165	109	-8.4
	8,5	8,5	96	165	109	-8.5
	8,6	8,6	100	175	115	-8.6
	8,7	8,7	100	175	115	-8.7
	8,8	8,8	100	175	115	-8.8
	8,9	8,9	100	175	115	-8.9
	9	9	100	175	115	-9
	9,1	9,1	100	175	115	-9.1
	9,2	9,2	100	175	115	-9.2
	9,3	9,3	100	175	115	-9.3
	9,4	9,4	100	175	115	-9.4
	9,5	9,5	100	175	115	-9.5
	9,6	9,6	105	184	121	-9.6
	9,7	9,7	105	184	121	-9.7
	9,8	9,8	105	184	121	-9.8
	9,9	9,9	105	184	121	-9.9
	10	10	105	184	121	-10
	10,2	10,2	105	184	121	-10.2
	10,5	10,5	105	184	121	-10.5
	10,8	10,8	110	195	128	-10.8
	11	11	110	195	128	-11
	11,2	11,2	110	195	128	-11.2
	11,5	11,5	110	195	128	-11.5
	11,8	11,8	110	195	128	-11.8
	12	12	120	205	134	-12

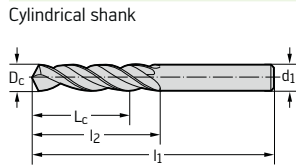

Long twist drill A1547 Alpha® XE



~ 12 x D_c

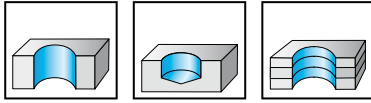

- HSS-E - fibre-steamed
- Type Alpha® XE
- right-hand cutting
- 130° point angle
- up to 1.9 mm bright finish

	P	M	K	N	S	H	O
uncoated	●●	●●	●●	●●	●●		●●

DIN 340	D _c h8 mm	D _c Inches/No	d ₁ f11 mm	L _c mm	l ₁ mm	l ₂ mm	Designation A1547
Cylindrical shank 	1		1	31	56	33	-1
	1,016	No. 60	1,016	31	56	33	-NO60
	1,041	No. 59	1,041	31	56	33	-NO59
	1,067	No. 58	1,067	35	60	37	-NO58
	1,092	No. 57	1,092	35	60	37	-NO57
	1,1		1,1	35	60	37	-1.1
	1,181	No. 56	1,181	39	65	41	-NO56
	1,191	3/64"	1,191	39	65	41	-3/64IN
	1,2		1,2	39	65	41	-1.2
	1,3		1,3	39	65	41	-1.3
	1,321	No. 55	1,321	42	70	45	-NO55
	1,397	No. 54	1,397	42	70	45	-NO54
	1,4		1,4	42	70	45	-1.4
	1,5		1,5	42	70	45	-1.5
	1,511	No. 53	1,511	47	76	50	-NO53
	1,588	1/16"	1,588	47	76	50	-1/16IN
	1,6		1,6	47	76	50	-1.6
	1,613	No. 52	1,613	47	76	50	-NO52
	1,7		1,7	47	76	50	-1.7
	1,702	No. 51	1,702	50	80	53	-NO51
	1,778	No. 50	1,778	50	80	53	-NO50
	1,8		1,8	50	80	53	-1.8
	1,854	No. 49	1,854	50	80	53	-NO49
	1,9		1,9	50	80	53	-1.9
	1,93	No. 48	1,93	52	85	56	-NO48
	1,984	5/64"	1,984	52	85	56	-5/64IN
	1,994	No. 47	1,994	52	85	56	-NO47
	2		2	52	85	56	-2
	2,057	No. 46	2,057	52	85	56	-NO46
	2,083	No. 45	2,083	52	85	56	-NO45
	2,1		2,1	52	85	56	-2.1
	2,184	No. 44	2,184	55	90	59	-NO44
	2,2		2,2	55	90	59	-2.2
	2,261	No. 43	2,261	55	90	59	-NO43
2,3		2,3	55	90	59	-2.3	
2,375	No. 42	2,375	58	95	62	-NO42	
2,381	3/32"	2,381	58	95	62	-3/32IN	
2,4		2,4	58	95	62	-2.4	
2,438	No. 41	2,438	58	95	62	-NO41	
2,489	No. 40	2,489	58	95	62	-NO40	
2,5		2,5	58	95	62	-2.5	
2,527	No. 39	2,527	58	95	62	-NO39	
2,578	No. 38	2,578	58	95	62	-NO38	
2,6		2,6	58	95	62	-2.6	
2,642	No. 37	2,642	58	95	62	-NO37	
2,7		2,7	61	100	66	-2.7	
2,705	No. 36	2,705	61	100	66	-NO36	

Continued



Long twist drill

A1547

Alpha® XE

~ 12 x D_c



Continued

	P	M	K	N	S	H	O
uncoated	●●	●●	●●	●●	●●		●●

DIN 340	D _c h8 mm	D _c Inches/No	d ₁ f11 mm	L _c mm	l ₁ mm	l ₂ mm	Designation A1547
Cylindrical shank	2,778	7/64"	2,778	61	100	66	-7/64IN
	2,794	No. 35	2,794	61	100	66	-NO35
	2,8		2,8	61	100	66	-2.8
	2,819	No. 34	2,819	61	100	66	-NO34
	2,87	No. 33	2,87	61	100	66	-NO33
	2,9		2,9	61	100	66	-2.9
	2,946	No. 32	2,946	61	100	66	-NO32
	3		3	61	100	66	-3
	3,048	No. 31	3,048	63	106	69	-NO31
	3,1		3,1	63	106	69	-3.1
	3,175	1/8"	3,175	63	106	69	-1/8IN
	3,2		3,2	63	106	69	-3.2
	3,264	No. 30	3,264	63	106	69	-NO30
	3,3		3,3	63	106	69	-3.3
	3,4		3,4	67	112	73	-3.4
	3,5		3,5	67	112	73	-3.5
	3,572	9/64"	3,572	67	112	73	-9/64IN
	3,6		3,6	67	112	73	-3.6
	3,7		3,7	67	112	73	-3.7
	3,8		3,8	71	119	78	-3.8
	3,9		3,9	71	119	78	-3.9
	3,969	5/32"	3,969	71	119	78	-5/32IN
	4		4	71	119	78	-4
	4,1		4,1	71	119	78	-4.1
	4,2		4,2	71	119	78	-4.2
	4,3		4,3	74	126	82	-4.3
	4,366	11/64"	4,366	74	126	82	-11/64IN
	4,4		4,4	74	126	82	-4.4
	4,5		4,5	74	126	82	-4.5
	4,6		4,6	74	126	82	-4.6
	4,7		4,7	74	126	82	-4.7
	4,763	3/16"	4,763	79	132	87	-3/16IN
	4,8		4,8	79	132	87	-4.8
	4,9		4,9	79	132	87	-4.9
	5		5	79	132	87	-5
	5,1		5,1	79	132	87	-5.1
	5,159	13/64"	5,159	79	132	87	-13/64IN
	5,2		5,2	79	132	87	-5.2
	5,3		5,3	79	132	87	-5.3
	5,4		5,4	82	139	91	-5.4
	5,5		5,5	82	139	91	-5.5
	5,556	7/32"	5,556	82	139	91	-7/32IN
	5,6		5,6	82	139	91	-5.6
	5,7		5,7	82	139	91	-5.7
	5,8		5,8	82	139	91	-5.8
	5,9		5,9	82	139	91	-5.9
	5,953	15/64"	5,953	82	139	91	-15/64IN
	6		6	82	139	91	-6
	6,1		6,1	86	148	97	-6.1
	6,2		6,2	86	148	97	-6.2
	6,3		6,3	86	148	97	-6.3
	6,35	1/4"	6,35	86	148	97	-1/4IN
	6,4		6,4	86	148	97	-6.4
	6,5		6,5	86	148	97	-6.5
	6,6		6,6	86	148	97	-6.6

Continued



Long twist drill A1547 Alpha® XE

~ 12 x D_c



Continued

	P	M	K	N	S	H	O
uncoated	●●	●●	●●	●●	●●		●●

DIN 340	D _c h8 mm	D _c Inches/No	d ₁ f11 mm	L _c mm	l ₁ mm	l ₂ mm	Designation A1547
Cylindrical shank	6,7		6,7	86	148	97	-6.7
	6,747	17/64"	6,747	90	156	102	-17/64IN
	6,8		6,8	90	156	102	-6.8
	7		7	90	156	102	-7
	7,1		7,1	90	156	102	-7.1
	7,144	9/32"	7,144	90	156	102	-9/32IN
	7,2		7,2	90	156	102	-7.2
	7,3		7,3	90	156	102	-7.3
	7,4		7,4	90	156	102	-7.4
	7,5		7,5	90	156	102	-7.5
	7,541	19/64"	7,541	96	165	109	-19/64IN
	7,6		7,6	96	165	109	-7.6
	7,7		7,7	96	165	109	-7.7
	7,8		7,8	96	165	109	-7.8
	7,9		7,9	96	165	109	-7.9
	7,938	5/16"	7,938	96	165	109	-5/16IN
	8		8	96	165	109	-8
	8,1		8,1	96	165	109	-8.1
	8,2		8,2	96	165	109	-8.2
	8,3		8,3	96	165	109	-8.3
	8,334	21/64"	8,334	96	165	109	-21/64IN
	8,4		8,4	96	165	109	-8.4
	8,5		8,5	96	165	109	-8.5
	8,6		8,6	100	175	115	-8.6
	8,7		8,7	100	175	115	-8.7
	8,731	11/32"	8,731	100	175	115	-11/32IN
	8,8		8,8	100	175	115	-8.8
	8,9		8,9	100	175	115	-8.9
	9		9	100	175	115	-9
	9,128	23/64"	9,128	100	175	115	-23/64IN
	9,525	3/8"	9,525	105	184	121	-3/8IN
	9,922	25/64"	9,922	105	184	121	-25/64IN
	10		10	105	184	121	-10
	10,2		10,2	105	184	121	-10.2
	10,319	13/32"	10,319	105	184	121	-13/32IN
	10,5		10,5	105	184	121	-10.5
	10,716	27/64"	10,716	110	195	128	-27/64IN
	11		11	110	195	128	-11
	11,113	7/16"	11,113	110	195	128	-7/16IN
	11,5		11,5	110	195	128	-11.5
	11,509	29/64"	11,509	110	195	128	-29/64IN
	11,906	15/32"	11,906	120	205	134	-15/32IN
	12		12	120	205	134	-12
	12,303	31/64"	12,303	120	205	134	-31/64IN
	12,7	1/2"	12,7	120	205	134	-1/2IN



Long deep-hole twist drill

A1549TFP

UFL®



~ 12 x D_c

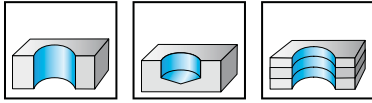

- HSS-E - TFP
- Type UFL®
- right-hand cutting
- 130° point angle

Special features:
suitable for dry machining in steel

	P	M	K	N	S	H	O
TFP	●●	●●	●●	●●	●●		●●

DIN 340	D _c h8 mm	d ₁ f11 mm	L _c mm	l ₁ mm	l ₂ mm	Designation A1549TFP
Cylindrical shank	1	1	31	56	33	-1
	1.1	1.1	35	60	37	-1.1
	1.2	1.2	39	65	41	-1.2
	1.3	1.3	39	65	41	-1.3
	1.4	1.4	42	70	45	-1.4
	1.5	1.5	42	70	45	-1.5
	1.6	1.6	47	76	50	-1.6
	1.7	1.7	47	76	50	-1.7
	1.8	1.8	50	80	53	-1.8
	1.9	1.9	50	80	53	-1.9
	2	2	52	85	56	-2
	2.1	2.1	52	85	56	-2.1
	2.2	2.2	55	90	59	-2.2
	2.3	2.3	55	90	59	-2.3
	2.4	2.4	58	95	62	-2.4
	2.5	2.5	58	95	62	-2.5
	2.6	2.6	58	95	62	-2.6
	2.7	2.7	61	100	66	-2.7
	2.8	2.8	61	100	66	-2.8
	2.9	2.9	61	100	66	-2.9
	3	3	61	100	66	-3
	3.1	3.1	63	106	69	-3.1
	3.2	3.2	63	106	69	-3.2
	3.3	3.3	63	106	69	-3.3
	3.4	3.4	67	112	73	-3.4
	3.5	3.5	67	112	73	-3.5
	3.6	3.6	67	112	73	-3.6
	3.7	3.7	67	112	73	-3.7
	3.8	3.8	71	119	78	-3.8
	3.9	3.9	71	119	78	-3.9
	4	4	71	119	78	-4
	4.1	4.1	71	119	78	-4.1
	4.2	4.2	71	119	78	-4.2
	4.3	4.3	74	126	82	-4.3
	4.4	4.4	74	126	82	-4.4
	4.5	4.5	74	126	82	-4.5
	4.6	4.6	74	126	82	-4.6
	4.7	4.7	74	126	82	-4.7
	4.8	4.8	79	132	87	-4.8
	4.9	4.9	79	132	87	-4.9
	5	5	79	132	87	-5
	5.1	5.1	79	132	87	-5.1
	5.2	5.2	79	132	87	-5.2
	5.3	5.3	79	132	87	-5.3
	5.4	5.4	82	139	91	-5.4
	5.5	5.5	82	139	91	-5.5
	5.6	5.6	82	139	91	-5.6

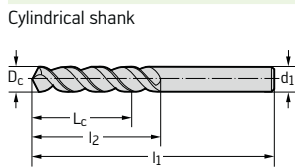

Continued



Long deep-hole twist drill A1549TFP UFL®



~ 12 x D_c

Continued

	P	M	K	N	S	H	O
TFP	●●	●●	●●	●●	●●		●●

DIN 340	D _c h8 mm	d ₁ f11 mm	L _c mm	l ₁ mm	l ₂ mm	Designation A1549TFP
Cylindrical shank 	5,7	5,7	82	139	91	-5.7
	5,8	5,8	82	139	91	-5.8
	5,9	5,9	82	139	91	-5.9
	6	6	82	139	91	-6
	6,1	6,1	86	148	97	-6.1
	6,2	6,2	86	148	97	-6.2
	6,3	6,3	86	148	97	-6.3
	6,4	6,4	86	148	97	-6.4
	6,5	6,5	86	148	97	-6.5
	6,6	6,6	86	148	97	-6.6
	6,7	6,7	86	148	97	-6.7
	6,8	6,8	90	156	102	-6.8
6,9	6,9	90	156	102	-6.9	
7	7	90	156	102	-7	
7,1	7,1	90	156	102	-7.1	
7,2	7,2	90	156	102	-7.2	
7,3	7,3	90	156	102	-7.3	
7,4	7,4	90	156	102	-7.4	
7,5	7,5	90	156	102	-7.5	
7,6	7,6	96	165	109	-7.6	
7,7	7,7	96	165	109	-7.7	
7,8	7,8	96	165	109	-7.8	
7,9	7,9	96	165	109	-7.9	
8	8	96	165	109	-8	
8,1	8,1	96	165	109	-8.1	
8,2	8,2	96	165	109	-8.2	
8,3	8,3	96	165	109	-8.3	
8,4	8,4	96	165	109	-8.4	
8,5	8,5	96	165	109	-8.5	
8,6	8,6	100	175	115	-8.6	
8,7	8,7	100	175	115	-8.7	
8,8	8,8	100	175	115	-8.8	
8,9	8,9	100	175	115	-8.9	
9	9	100	175	115	-9	
9,1	9,1	100	175	115	-9.1	
9,2	9,2	100	175	115	-9.2	
9,3	9,3	100	175	115	-9.3	
9,4	9,4	100	175	115	-9.4	
9,5	9,5	100	175	115	-9.5	
9,6	9,6	105	184	121	-9.6	
9,7	9,7	105	184	121	-9.7	
9,8	9,8	105	184	121	-9.8	
9,9	9,9	105	184	121	-9.9	
10	10	105	184	121	-10	
10,2	10,2	105	184	121	-10.2	
10,5	10,5	105	184	121	-10.5	
11	11	110	195	128	-11	
11,5	11,5	110	195	128	-11.5	
12	12	120	205	134	-12	



Extra long deep-hole drill A1622 UFL®

~ 16 x D_c

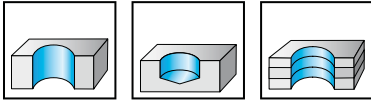

- HSS - fibre-steamed
- Type UFL®
- right-hand cutting
- 130° point angle

	P	M	K	N	S	H	O
uncoated	●●	●	●●	●●	●		●●

DIN 1869-I	D _c h8 mm	D _c Inches/No	d ₁ f11 mm	L _c mm	l ₁ mm	l ₂ mm	Designation A1622	
Cylindrical shank 	2		2	81	125	85	-2	
	2,1		2,1	81	125	85	-2.1	
	2,2		2,2	86	135	90	-2.2	
	2,3		2,3	86	135	90	-2.3	
	2,381		3/32"	2,381	91	140	95	-3/32IN
	2,4		2,4	91	140	95	-2.4	
	2,489		No. 40	2,489	91	140	95	-N040
	2,5		2,5	91	140	95	-2.5	
	2,527		No. 39	2,527	91	140	95	-N039
	2,578		No. 38	2,578	91	140	95	-N038
	2,6		2,6	91	140	95	-2.6	
	2,642		No. 37	2,642	91	140	95	-N037
	2,7		2,7	95	150	100	-2.7	
	2,705		No. 36	2,705	95	150	100	-N036
	2,778		7/64"	2,778	95	150	100	-7/64IN
	2,794		No. 35	2,794	95	150	100	-N035
	2,8		2,8	95	150	100	-2.8	
	2,819		No. 34	2,819	95	150	100	-N034
	2,87		No. 33	2,87	95	150	100	-N033
	2,9		2,9	95	150	100	-2.9	
	2,946		No. 32	2,946	95	150	100	-N032
	3		3	95	150	100	-3	
	3,048		No. 31	3,048	99	155	105	-N031
	3,1		3,1	99	155	105	-3.1	
	3,175		1/8"	3,175	99	155	105	-1/8IN
	3,2		3,2	99	155	105	-3.2	
	3,264		No. 30	3,264	99	155	105	-N030
	3,3		3,3	99	155	105	-3.3	
	3,4		3,4	109	165	115	-3.4	
	3,454		No. 29	3,454	109	165	115	-N029
	3,5		3,5	109	165	115	-3.5	
	3,569		No. 28	3,569	109	165	115	-N028
	3,572		9/64"	3,572	109	165	115	-9/64IN
	3,6		3,6	109	165	115	-3.6	
	3,658		No. 27	3,658	109	165	115	-N027
	3,7		3,7	109	165	115	-3.7	
	3,734		No. 26	3,734	109	165	115	-N026
	3,797		No. 25	3,797	113	175	120	-N025
	3,8		3,8	113	175	120	-3.8	
	3,861		No. 24	3,861	113	175	120	-N024
3,9		3,9	113	175	120	-3.9		
3,912		No. 23	3,912	113	175	120	-N023	
3,969		5/32"	3,969	113	175	120	-5/32IN	
3,988		No. 22	3,988	113	175	120	-N022	
4		4	113	175	120	-4		
4,039		No. 21	4,039	113	175	120	-N021	
4,089		No. 20	4,089	113	175	120	-N020	

Continued



Extra long deep-hole drill

A1622

UFL®



~ 16 x D_c

	P	M	K	N	S	H	O
uncoated	●●	●	●●	●●	●		●●

Continued

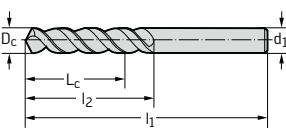
DIN 1869-I	D _c h8 mm	D _c Inches/No	d ₁ f11 mm	L _c mm	l ₁ mm	l ₂ mm	Designation A1622
Cylindrical shank	4,1		4,1	113	175	120	-4.1
	4,2		4,2	113	175	120	-4.2
	4,216	No. 19	4,216	113	175	120	-N019
	4,3		4,3	117	185	125	-4.3
	4,305	No. 18	4,305	117	185	125	-N018
	4,366	11/64"	4,366	117	185	125	-11/64IN
	4,394	No. 17	4,394	117	185	125	-N017
	4,4		4,4	117	185	125	-4.4
	4,496	No. 16	4,496	117	185	125	-N016
	4,5		4,5	117	185	125	-4.5
	4,572	No. 15	4,572	117	185	125	-N015
	4,6		4,6	117	185	125	-4.6
	4,623	No. 14	4,623	117	185	125	-N014
	4,699	No. 13	4,699	117	185	125	-N013
	4,7		4,7	117	185	125	-4.7
	4,763	3/16"	4,763	127	195	135	-3/16IN
	4,8		4,8	127	195	135	-4.8
	4,801	No. 12	4,801	127	195	135	-N012
	4,851	No. 11	4,851	127	195	135	-N011
	4,9		4,9	127	195	135	-4.9
	4,915	No. 10	4,915	127	195	135	-N010
	4,978	No. 9	4,978	127	195	135	-N09
	5		5	127	195	135	-5
	5,055	No. 8	5,055	127	195	135	-N08
	5,1		5,1	127	195	135	-5.1
	5,105	No. 7	5,105	127	195	135	-N07
	5,159	13/64"	5,159	127	195	135	-13/64IN
	5,182	No. 6	5,182	127	195	135	-N06
	5,2		5,2	127	195	135	-5.2
	5,22	No. 5	5,22	127	195	135	-N05
	5,3		5,3	127	195	135	-5.3
	5,309	No. 4	5,309	131	205	140	-N04
	5,4		5,4	131	205	140	-5.4
	5,41	No. 3	5,41	131	205	140	-N03
	5,5		5,5	131	205	140	-5.5
	5,556	7/32"	5,556	131	205	140	-7/32IN
	5,6		5,6	131	205	140	-5.6
	5,613	No. 2	5,613	131	205	140	-N02
	5,7		5,7	131	205	140	-5.7
	5,791	No. 1	5,791	131	205	140	-N01
	5,8		5,8	131	205	140	-5.8
	5,9		5,9	131	205	140	-5.9
	5,953	15/64"	5,953	131	205	140	-15/64IN
	6		6	131	205	140	-6
	6,1		6,1	139	215	150	-6.1
	6,2		6,2	139	215	150	-6.2
	6,3		6,3	139	215	150	-6.3
	6,35	1/4"	6,35	139	215	150	-1/4IN
	6,4		6,4	139	215	150	-6.4
	6,5		6,5	139	215	150	-6.5
	6,6		6,6	139	215	150	-6.6
	6,7		6,7	139	215	150	-6.7
	6,747	17/64"	6,747	143	225	155	-17/64IN
	6,8		6,8	143	225	155	-6.8
	6,9		6,9	143	225	155	-6.9

Continued



Extra long deep-hole drill

A1622

UFL®



~ 16 x D_c

	P	M	K	N	S	H	O
uncoated	●●	●	●●	●●	●		●●

Continued

DIN 1869-I	D _c h8 mm	D _c Inches/No	d ₁ f11 mm	L _c mm	l ₁ mm	l ₂ mm	Designation A1622
Cylindrical shank 	7		7	143	225	155	-7
	7,1		7,1	143	225	155	-7.1
	7,144	9/32"	7,144	143	225	155	-9/32IN
	7,2		7,2	143	225	155	-7.2
	7,3		7,3	143	225	155	-7.3
	7,4		7,4	143	225	155	-7.4
	7,5		7,5	143	225	155	-7.5
	7,541	19/64"	7,541	152	240	165	-19/64IN
	7,6		7,6	152	240	165	-7.6
	7,7		7,7	152	240	165	-7.7
	7,8		7,8	152	240	165	-7.8
	7,9		7,9	152	240	165	-7.9
	7,938	5/16"	7,938	152	240	165	-5/16IN
	8		8	152	240	165	-8
	8,1		8,1	152	240	165	-8.1
	8,2		8,2	152	240	165	-8.2
	8,3		8,3	152	240	165	-8.3
	8,334	21/64"	8,334	152	240	165	-21/64IN
	8,4		8,4	152	240	165	-8.4
	8,5		8,5	152	240	165	-8.5
	8,6		8,6	160	250	175	-8.6
	8,7		8,7	160	250	175	-8.7
	8,731	11/32"	8,731	160	250	175	-11/32IN
	8,8		8,8	160	250	175	-8.8
	8,9		8,9	160	250	175	-8.9
	9		9	160	250	175	-9
	9,1		9,1	160	250	175	-9.1
	9,128	23/64"	9,128	160	250	175	-23/64IN
9,2		9,2	160	250	175	-9.2	
9,3		9,3	160	250	175	-9.3	
9,4		9,4	160	250	175	-9.4	
9,5		9,5	160	250	175	-9.5	
9,525	3/8"	9,525	169	265	185	-3/8IN	
9,6		9,6	169	265	185	-9.6	
9,7		9,7	169	265	185	-9.7	
9,8		9,8	169	265	185	-9.8	
9,9		9,9	169	265	185	-9.9	
9,922	25/64"	9,922	169	265	185	-25/64IN	
10		10	169	265	185	-10	
10,319	13/32"	10,319	169	265	185	-13/32IN	
10,5		10,5	169	265	185	-10.5	
10,716	27/64"	10,716	177	280	195	-27/64IN	
11		11	177	280	195	-11	
11,113	7/16"	11,113	177	280	195	-7/16IN	
11,5		11,5	177	280	195	-11.5	
11,509	29/64"	11,509	177	280	195	-29/64IN	
11,906	15/32"	11,906	191	295	205	-15/32IN	
12		12	191	295	205	-12	
12,303	31/64"	12,303	191	295	205	-31/64IN	
12,7	1/2"	12,7	191	295	205	-1/2IN	



Extra long deep-hole drill A1722 UFL®



~ 22 x D_c

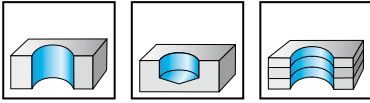

- HSS - fibre-steamed
- Type UFL®
- right-hand cutting
- 130° point angle

	P	M	K	N	S	H	O
uncoated	●●	●	●●	●●	●		●●

DIN 1869-II	D _c h8 mm	d ₁ f11 mm	L _c mm	l ₁ mm	l ₂ mm	Designation A1722
Cylindrical shank 	3	3	125	190	130	-3
	3,5	3,5	139	210	145	-3.5
	4	4	143	220	150	-4
	4,5	4,5	152	235	160	-4.5
	5	5	162	245	170	-5
	5,5	5,5	171	260	180	-5.5
	6	6	171	260	180	-6
	6,5	6,5	179	275	190	-6.5
	7	7	188	290	200	-7
	7,5	7,5	188	290	200	-7.5
	8	8	197	305	210	-8
	8,5	8,5	197	305	210	-8.5
	9	9	205	320	220	-9
	9,5	9,5	205	320	220	-9.5
10	10	219	340	235	-10	
10,5	10,5	219	340	235	-10.5	
11	11	232	360	250	-11	
11,5	11,5	232	360	250	-11.5	
12	12	246	380	260	-12	



Extra long deep-hole drill A1822 UFL®

~ 30 x D_c

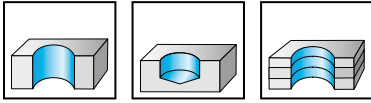

- HSS - fibre-steamed
- Type UFL®
- right-hand cutting
- 130° point angle

	P	M	K	N	S	H	O
uncoated	●●	●	●●	●●	●		●●

DIN 1869-III	D _c h8 mm	d ₁ f11 mm	L _c mm	l ₁ mm	l ₂ mm	Designation A1822
Cylindrical shank	3,5	3,5	174	265	180	-3.5
	4	4	183	280	190	-4
	4,5	4,5	192	295	200	-4.5
	5	5	202	315	210	-5
	5,5	5,5	216	330	225	-5.5
	6	6	216	330	225	-6
	6,5	6,5	224	350	235	-6.5
	7	7	238	370	250	-7
	7,5	7,5	238	370	250	-7.5
	8	8	252	390	265	-8
	8,5	8,5	252	390	265	-8.5
	9	9	265	410	280	-9
	9,5	9,5	265	410	280	-9.5
	10	10	279	430	295	-10
	10,5	10,5	279	430	295	-10.5
	11	11	287	450	305	-11
	11,5	11,5	287	450	305	-11.5
	12	12	291	480	305	-12

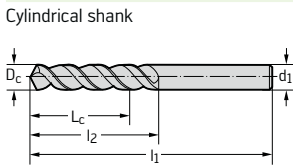

Ultra long deep-hole drill A1922L UFL®



~ 85 x D_c

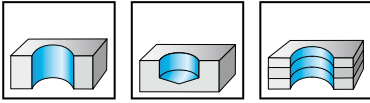

- HSS - fibre-steamed
- Type UFL®
- right-hand cutting
- 130° point angle

	P	M	K	N	S	H	O
uncoated	●●	●	●●	●●	●		●●

	D _c h8 mm	d ₁ f11 mm	L _c mm	l ₁ mm	l ₂ mm	Designation A1922L
Cylindrical shank	8	8	685	800	700	-8
	10	10	769	1000	800	-10
	12	12	769	1000	800	-12

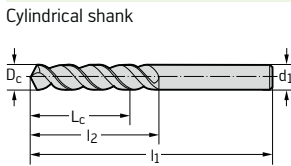

Ultra long deep-hole drill A1922S UFL®

~ 60 x D_c

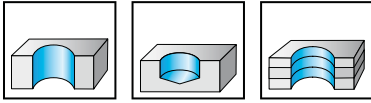

- HSS - fibre-steamed
- Type UFL®
- right-hand cutting
- 130° point angle

	P	M	K	N	S	H	O
uncoated	●●	●	●●	●●	●		●●

	D _c h8 mm	d ₁ f11 mm	L _c mm	l ₁ mm	l ₂ mm	Designation A1922S
Cylindrical shank	6	6	389	500	400	-6
	6,5	6,5	389	500	400	-6.5
	7	7	389	500	400	-7
	8	8	536	650	550	-8
	9	9	536	650	550	-9
	10	10	680	800	700	-10
	11	11	680	800	700	-11
	12	12	680	800	700	-12
	13	13	680	800	700	-13
	14	14	680	800	700	-14

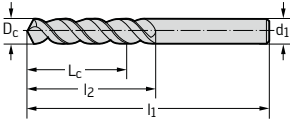



Stub length drill

A2258

UFL®

~ 3 x D_c

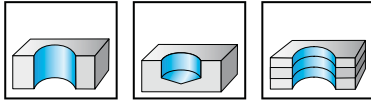

- HSS-E - uncoated
- Type UFL®
- left-hand cutting
- 130° point angle
- overall length DIN 1897, flutes lengthened compared to DIN 1897

	P	M	K	N	S	H	O
uncoated	●●	●●	●●	●●	●●		●●

DIN 1897	D _c h8 mm	D _c Inches/No	d ₁ f11 mm	L _c mm	l ₁ mm	l ₂ mm	Designation A2258
Cylindrical shank 	1		1	6	26	8	-1
	1,016	No. 60	1,016	6	26	8	-NO60
	1,041	No. 59	1,041	6	26	8	-NO59
	1,067	No. 58	1,067	7	28	9	-NO58
	1,092	No. 57	1,092	7	28	9	-NO57
	1,1		1,1	7	28	9	-1.1
	1,181	No. 56	1,181	8	30	10	-NO56
	1,191	3/64"	1,191	8	30	10	-3/64IN
	1,2		1,2	8	30	10	-1.2
	1,3		1,3	8	30	10	-1.3
	1,321	No. 55	1,321	9	32	12	-NO55
	1,397	No. 54	1,397	9	32	12	-NO54
	1,4		1,4	9	32	12	-1.4
	1,5		1,5	9	32	12	-1.5
	1,511	No. 53	1,511	10	34	13	-NO53
	1,588	1/16"	1,588	10	34	13	-1/16IN
	1,6		1,6	10	34	13	-1.6
	1,613	No. 52	1,613	10	34	13	-NO52
	1,7		1,7	10	34	13	-1.7
	1,702	No. 51	1,702	11	36	14	-NO51
	1,778	No. 50	1,778	11	36	14	-NO50
	1,8		1,8	11	36	14	-1.8
	1,854	No. 49	1,854	11	36	14	-NO49
	1,9		1,9	11	36	14	-1.9
	1,93	No. 48	1,93	12	38	16	-NO48
	1,984	5/64"	1,984	12	38	16	-5/64IN
	1,994	No. 47	1,994	12	38	16	-NO47
	2		2	12	38	16	-2
	2,057	No. 46	2,057	12	38	16	-NO46
	2,083	No. 45	2,083	12	38	16	-NO45
	2,1		2,1	12	38	16	-2.1
	2,184	No. 44	2,184	13	40	17	-NO44
	2,2		2,2	13	40	17	-2.2
	2,261	No. 43	2,261	13	40	17	-NO43
2,3		2,3	13	40	17	-2.3	
2,375	No. 42	2,375	14	43	18	-NO42	
2,381	3/32"	2,381	14	43	18	-3/32IN	
2,4		2,4	14	43	18	-2.4	
2,438	No. 41	2,438	14	43	18	-NO41	
2,489	No. 40	2,489	14	43	18	-NO40	
2,5		2,5	14	43	18	-2.5	
2,527	No. 39	2,527	14	43	18	-NO39	
2,578	No. 38	2,578	14	43	18	-NO38	
2,6		2,6	14	43	18	-2.6	
2,642	No. 37	2,642	14	43	18	-NO37	
2,7		2,7	16	46	21	-2.7	
2,705	No. 36	2,705	16	46	21	-NO36	

Continued



Stub length drill

A2258

UFL®

~ 3 x D_c



Continued

	P	M	K	N	S	H	O
uncoated	●●	●●	●●	●●	●●		●●

DIN 1897	D _c h8 mm	D _c Inches/No	d ₁ f11 mm	L _c mm	l ₁ mm	l ₂ mm	Designation A2258
Cylindrical shank	2,778	7/64"	2,778	16	46	21	-7/64IN
	2,794	No. 35	2,794	16	46	21	-N035
	2,8		2,8	16	46	21	-2.8
	2,819	No. 34	2,819	16	46	21	-N034
	2,87	No. 33	2,87	16	46	21	-N033
	2,9		2,9	16	46	21	-2.9
	2,946	No. 32	2,946	16	46	21	-N032
	3		3	16	46	21	-3
	3,048	No. 31	3,048	17	49	23	-N031
	3,1		3,1	17	49	23	-3.1
	3,175	1/8"	3,175	17	49	23	-1/8IN
	3,2		3,2	17	49	23	-3.2
	3,264	No. 30	3,264	17	49	23	-N030
	3,3		3,3	17	49	23	-3.3
	3,4		3,4	20	52	26	-3.4
	3,454	No. 29	3,454	20	52	26	-N029
	3,5		3,5	20	52	26	-3.5
	3,569	No. 28	3,569	20	52	26	-N028
	3,572	9/64"	3,572	20	52	26	-9/64IN
	3,6		3,6	20	52	26	-3.6
	3,658	No. 27	3,658	20	52	26	-N027
	3,7		3,7	20	52	26	-3.7
	3,734	No. 26	3,734	20	52	26	-N026
	3,797	No. 25	3,797	22	55	29	-N025
	3,8		3,8	22	55	29	-3.8
	3,861	No. 24	3,861	22	55	29	-N024
	3,9		3,9	22	55	29	-3.9
	3,912	No. 23	3,912	22	55	29	-N023
	3,969	5/32"	3,969	22	55	29	-5/32IN
	3,988	No. 22	3,988	22	55	29	-N022
	4		4	22	55	29	-4
	4,039	No. 21	4,039	22	55	29	-N021
	4,089	No. 20	4,089	22	55	29	-N020
	4,1		4,1	22	55	29	-4.1
	4,2		4,2	22	55	29	-4.2
	4,216	No. 19	4,216	22	55	29	-N019
	4,3		4,3	23	58	31	-4.3
	4,305	No. 18	4,305	23	58	31	-N018
	4,366	11/64"	4,366	23	58	31	-11/64IN
	4,394	No. 17	4,394	23	58	31	-N017
	4,4		4,4	23	58	31	-4.4
	4,496	No. 16	4,496	23	58	31	-N016
	4,5		4,5	23	58	31	-4.5
	4,572	No. 15	4,572	23	58	31	-N015
	4,6		4,6	23	58	31	-4.6
	4,623	No. 14	4,623	23	58	31	-N014
	4,699	No. 13	4,699	23	58	31	-N013
	4,7		4,7	23	58	31	-4.7
	4,763	3/16"	4,763	26	62	34	-3/16IN
	4,8		4,8	26	62	34	-4.8
	4,801	No. 12	4,801	26	62	34	-N012
	4,851	No. 11	4,851	26	62	34	-N011
	4,9		4,9	26	62	34	-4.9
	4,915	No. 10	4,915	26	62	34	-N010
	4,978	No. 9	4,978	26	62	34	-N09

Continued





Stub length drill

A2258

UFL®

~ 3 x D_c

Continued

	P	M	K	N	S	H	O
uncoated	●●	●●	●●	●●	●●		●●

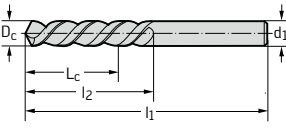
DIN 1897	D _c h8 mm	D _c Inches/No	d ₁ f11 mm	L _c mm	l ₁ mm	l ₂ mm	Designation A2258
Cylindrical shank	5		5	26	62	34	-5
	5,055	No. 8	5,055	26	62	34	-N08
	5,1		5,1	26	62	34	-5.1
	5,105	No. 7	5,105	26	62	34	-N07
	5,159	13/64"	5,159	26	62	34	-13/64IN
	5,182	No. 6	5,182	26	62	34	-N06
	5,2		5,2	26	62	34	-5.2
	5,22	No. 5	5,22	26	62	34	-N05
	5,3		5,3	26	62	34	-5.3
	5,309	No. 4	5,309	27	66	36	-N04
	5,4		5,4	27	66	36	-5.4
	5,41	No. 3	5,41	27	66	36	-N03
	5,5		5,5	27	66	36	-5.5
	5,556	7/32"	5,556	27	66	36	-7/32IN
	5,6		5,6	27	66	36	-5.6
	5,613	No. 2	5,613	27	66	36	-N02
	5,7		5,7	27	66	36	-5.7
	5,791	No. 1	5,791	27	66	36	-N01
	5,8		5,8	27	66	36	-5.8
	5,9		5,9	27	66	36	-5.9
	5,953	15/64"	5,953	27	66	36	-15/64IN
	6		6	27	66	36	-6
	6,1		6,1	29	70	40	-6.1
	6,2		6,2	29	70	40	-6.2
	6,3		6,3	29	70	40	-6.3
	6,35	1/4"	6,35	29	70	40	-1/4IN
	6,4		6,4	29	70	40	-6.4
	6,5		6,5	29	70	40	-6.5
	6,6		6,6	29	70	40	-6.6
	6,7		6,7	29	70	40	-6.7
	6,747	17/64"	6,747	32	74	44	-17/64IN
	6,8		6,8	32	74	44	-6.8
	6,9		6,9	32	74	44	-6.9
	7		7	32	74	44	-7
	7,1		7,1	32	74	44	-7.1
	7,144	9/32"	7,144	32	74	44	-9/32IN
	7,2		7,2	32	74	44	-7.2
	7,3		7,3	32	74	44	-7.3
	7,4		7,4	32	74	44	-7.4
	7,5		7,5	32	74	44	-7.5
	7,541	19/64"	7,541	35	79	48	-19/64IN
	7,6		7,6	35	79	48	-7.6
	7,7		7,7	35	79	48	-7.7
	7,8		7,8	35	79	48	-7.8
	7,9		7,9	35	79	48	-7.9
	7,938	5/16"	7,938	35	79	48	-5/16IN
	8		8	35	79	48	-8
	8,1		8,1	35	79	48	-8.1
	8,2		8,2	35	79	48	-8.2
	8,3		8,3	35	79	48	-8.3
	8,334	21/64"	8,334	35	79	48	-21/64IN
	8,4		8,4	35	79	48	-8.4
	8,5		8,5	35	79	48	-8.5
	8,6		8,6	37	84	52	-8.6
	8,7		8,7	37	84	52	-8.7

Continued



Stub length drill

A2258

UFL®



~ 3 x D_c

Continued

	P	M	K	N	S	H	O
uncoated	●●	●●	●●	●●	●●		●●

DIN 1897	D _c h8 mm	D _c Inches/No	d ₁ f11 mm	L _c mm	l ₁ mm	l ₂ mm	Designation A2258
Cylindrical shank 	8,731	11/32"	8,731	37	84	52	-11/32IN
	8,8		8,8	37	84	52	-8.8
	8,9		8,9	37	84	52	-8.9
	9		9	37	84	52	-9
	9,1		9,1	37	84	52	-9.1
	9,128	23/64"	9,128	37	84	52	-23/64IN
	9,2		9,2	37	84	52	-9.2
	9,3		9,3	37	84	52	-9.3
	9,4		9,4	37	84	52	-9.4
	9,5		9,5	37	84	52	-9.5
	9,525	3/8"	9,525	40	89	56	-3/8IN
	9,6		9,6	40	89	56	-9.6
	9,7		9,7	40	89	56	-9.7
	9,8		9,8	40	89	56	-9.8
	9,9		9,9	40	89	56	-9.9
	9,922	25/64"	9,922	40	89	56	-25/64IN
	10		10	40	89	56	-10
	10,2		10,2	40	89	56	-10.2
	10,319	13/32"	10,319	40	89	56	-13/32IN
	10,5		10,5	40	89	56	-10.5
10,716	27/64"	10,716	43	95	61	-27/64IN	
10,8		10,8	43	95	61	-10.8	
11		11	43	95	61	-11	
11,113	7/16"	11,113	43	95	61	-7/16IN	
11,5		11,5	43	95	61	-11.5	
11,509	29/64"	11,509	43	95	61	-29/64IN	
11,906	15/32"	11,906	52	102	66	-15/32IN	
12		12	52	102	66	-12	
12,303	31/64"	12,303	52	102	66	-31/64IN	
12,5		12,5	52	102	66	-12.5	
12,7	1/2"	12,7	52	102	66	-1/2IN	
13		13	52	102	66	-13	
13,097	33/64"	13,097	52	102	66	-33/64IN	
13,494	17/32"	13,494	56	107	70	-17/32IN	
13,5		13,5	56	107	70	-13.5	
13,891	35/64"	13,891	56	107	70	-35/64IN	
14		14	56	107	70	-14	
14,288	9/16"	14,288	58	111	73	-9/16IN	
14,5		14,5	58	111	73	-14.5	
15		15	58	111	73	-15	
15,5		15,5	59	115	75	-15.5	
16		16	59	115	75	-16	
17		17	61	119	78	-17	
18		18	63	123	81	-18	
19		19	64	127	83	-19	
20		20	66	131	86	-20	



Micro drill A3143



~ 5 x D_c

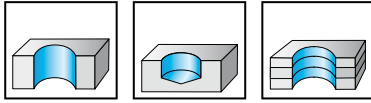

- HSS-E - uncoated
- Type ESU
- right-hand cutting
- 118° point angle

	P	M	K	N	S	H	O
uncoated	●●	●●	●●	●●	●●		●●

DIN 1899	D _c 0-0,004 mm	d ₁ h8 mm	L _c mm	l ₁ mm	l ₂ mm	Designation A3143
Cylindrical shank	0,05	1	0,2	25	0,3	-0,05
	0,06	1	0,2	25	0,3	-0,06
	0,07	1	0,2	25	0,4	-0,07
	0,08	1	0,2	25	0,4	-0,08
	0,09	1	0,2	25	0,4	-0,09
	0,1	1	0,3	25	0,5	-0,1
	0,11	1	0,3	25	0,5	-0,11
	0,12	1	0,3	25	0,5	-0,12
	0,13	1	0,5	25	0,8	-0,13
	0,14	1	0,5	25	0,8	-0,14
	0,15	1	0,5	25	0,8	-0,15
	0,16	1	0,8	25	1,1	-0,16
	0,17	1	0,8	25	1,1	-0,17
	0,18	1	0,8	25	1,1	-0,18
	0,19	1	0,8	25	1,1	-0,19
	0,2	1	1,1	25	1,5	-0,2
	0,21	1	1,1	25	1,5	-0,21
	0,22	1	1,1	25	1,5	-0,22
	0,23	1	1,1	25	1,5	-0,23
	0,24	1	1,1	25	1,5	-0,24
	0,25	1	1,4	25	1,9	-0,25
	0,26	1	1,4	25	1,9	-0,26
	0,27	1	1,4	25	1,9	-0,27
	0,28	1	1,4	25	1,9	-0,28
	0,29	1	1,4	25	1,9	-0,29
	0,3	1	1,4	25	1,9	-0,3
	0,31	1	1,8	25	2,4	-0,31
	0,32	1	1,8	25	2,4	-0,32
	0,33	1	1,8	25	2,4	-0,33
	0,34	1	1,8	25	2,4	-0,34
	0,35	1	1,8	25	2,4	-0,35
	0,36	1	1,8	25	2,4	-0,36
	0,37	1	1,8	25	2,4	-0,37
	0,38	1	1,8	25	2,4	-0,38
	0,39	1	2,2	25	3	-0,39
	0,4	1	2,2	25	3	-0,4
	0,41	1	2,2	25	3	-0,41
	0,42	1	2,2	25	3	-0,42
	0,43	1	2,2	25	3	-0,43
	0,44	1	2,2	25	3	-0,44
	0,45	1	2,2	25	3	-0,45
	0,46	1	2,2	25	3	-0,46
	0,47	1	2,2	25	3	-0,47
	0,48	1	2,2	25	3	-0,48
	0,49	1	2,6	25	3,4	-0,49
	0,5	1	2,6	25	3,4	-0,5
	0,51	1	2,6	25	3,4	-0,51

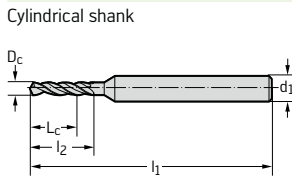

Continued



Micro drill A3143



~ 5 x D_c

Continued

	P	M	K	N	S	H	O
uncoated	●●	●●	●●	●●	●●		●●

DIN 1899	D _c 0-0,004 mm	d ₁ h8 mm	L _c mm	l ₁ mm	l ₂ mm	Designation A3143
Cylindrical shank	0,52	1	2,6	25	3,4	-0,52
	0,53	1	2,6	25	3,4	-0,53
	0,54	1	3	25	3,9	-0,54
	0,55	1	3	25	3,9	-0,55
	0,56	1	3	25	3,9	-0,56
	0,57	1	3	25	3,9	-0,57
	0,58	1	3	25	3,9	-0,58
	0,59	1	3	25	3,9	-0,59
	0,6	1	3	25	3,9	-0,6
	0,61	1	3,1	25	4,2	-0,61
	0,62	1	3,1	25	4,2	-0,62
	0,63	1	3,1	25	4,2	-0,63
	0,64	1	3,1	25	4,2	-0,64
	0,65	1	3,1	25	4,2	-0,65
	0,66	1	3,1	25	4,2	-0,66
	0,67	1	3,1	25	4,2	-0,67
	0,68	1	3,6	25	4,8	-0,68
	0,69	1	3,6	25	4,8	-0,69
	0,7	1	3,6	25	4,8	-0,7
	0,71	1	3,6	25	4,8	-0,71
	0,72	1	3,6	25	4,8	-0,72
	0,73	1	3,6	25	4,8	-0,73
	0,74	1	3,6	25	4,8	-0,74
	0,75	1	3,6	25	4,8	-0,75
	0,76	1	4,1	25	5,3	-0,76
	0,77	1	4,1	25	5,3	-0,77
	0,78	1	4,1	25	5,3	-0,78
	0,79	1	4,1	25	5,3	-0,79
	0,8	1,5	4	25	5,3	-0,8
	0,81	1,5	4	25	5,3	-0,81
	0,82	1,5	4	25	5,3	-0,82
	0,83	1,5	4	25	5,3	-0,83
	0,84	1,5	4	25	5,3	-0,84
	0,85	1,5	4	25	5,3	-0,85
	0,86	1,5	4,5	25	6	-0,86
	0,87	1,5	4,5	25	6	-0,87
	0,88	1,5	4,5	25	6	-0,88
	0,89	1,5	4,5	25	6	-0,89
	0,9	1,5	4,5	25	6	-0,9
	0,91	1,5	4,5	25	6	-0,91
	0,92	1,5	4,5	25	6	-0,92
	0,93	1,5	4,5	25	6	-0,93
	0,94	1,5	4,5	25	6	-0,94
	0,95	1,5	4,5	25	6	-0,95
	0,96	1,5	5	25	6,8	-0,96
	0,97	1,5	5	25	6,8	-0,97
	0,98	1,5	5	25	6,8	-0,98
	0,99	1,5	5	25	6,8	-0,99
	1	1,5	5	25	6,8	-1
	1,05	1,5	5	25	6,8	-1,05
	1,1	1,5	5	25	7,6	-1,1
	1,15	1,5	5	25	7,6	-1,15
	1,2	1,5	6	25	8,5	-1,2
	1,25	1,5	6	25	8,5	-1,25
	1,3	1,5	6	25	8,5	-1,3
	1,35	1,5	7	25	9,5	-1,35
	1,4	1,5	7	25	9,5	-1,4
	1,45	1,5	7	25	9,5	-1,45

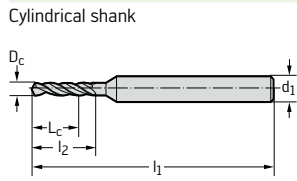

Continued





Micro drill A3153

~ 5 x D_c

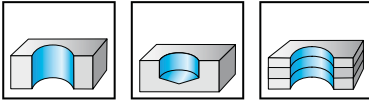

- HSS-E - uncoated
- Type ESU
- left-hand cutting
- 118° point angle

	P	M	K	N	S	H	O
uncoated	●●	●●	●●	●●	●●		●●

DIN 1899	D _c 0-0,004 mm	d ₁ h8 mm	L _c mm	l ₁ mm	l ₂ mm	Designation A3153
Cylindrical shank	0,15	1	0,5	25	0,8	-0,15
	0,16	1	0,8	25	1,1	-0,16
	0,17	1	0,8	25	1,1	-0,17
	0,18	1	0,8	25	1,1	-0,18
	0,19	1	0,8	25	1,1	-0,19
	0,2	1	1,1	25	1,5	-0,2
	0,21	1	1,1	25	1,5	-0,21
	0,22	1	1,1	25	1,5	-0,22
	0,23	1	1,1	25	1,5	-0,23
	0,24	1	1,1	25	1,5	-0,24
	0,25	1	1,4	25	1,9	-0,25
	0,26	1	1,4	25	1,9	-0,26
	0,27	1	1,4	25	1,9	-0,27
	0,28	1	1,4	25	1,9	-0,28
	0,29	1	1,4	25	1,9	-0,29
	0,3	1	1,4	25	1,9	-0,3
	0,31	1	1,8	25	2,4	-0,31
	0,32	1	1,8	25	2,4	-0,32
	0,33	1	1,8	25	2,4	-0,33
	0,34	1	1,8	25	2,4	-0,34
	0,35	1	1,8	25	2,4	-0,35
	0,36	1	1,8	25	2,4	-0,36
	0,37	1	1,8	25	2,4	-0,37
	0,38	1	1,8	25	2,4	-0,38
	0,39	1	2,2	25	3	-0,39
	0,4	1	2,2	25	3	-0,4
	0,41	1	2,2	25	3	-0,41
	0,42	1	2,2	25	3	-0,42
	0,43	1	2,2	25	3	-0,43
	0,44	1	2,2	25	3	-0,44
	0,45	1	2,2	25	3	-0,45
	0,46	1	2,2	25	3	-0,46
	0,47	1	2,2	25	3	-0,47
	0,48	1	2,2	25	3	-0,48
	0,49	1	2,6	25	3,4	-0,49
	0,5	1	2,6	25	3,4	-0,5
	0,51	1	2,6	25	3,4	-0,51
	0,52	1	2,6	25	3,4	-0,52
	0,53	1	2,6	25	3,4	-0,53
	0,54	1	3	25	3,9	-0,54
	0,55	1	3	25	3,9	-0,55
	0,56	1	3	25	3,9	-0,56
	0,57	1	3	25	3,9	-0,57
	0,58	1	3	25	3,9	-0,58
	0,59	1	3	25	3,9	-0,59
	0,6	1	3	25	3,9	-0,6
	0,61	1	3,1	25	4,2	-0,61

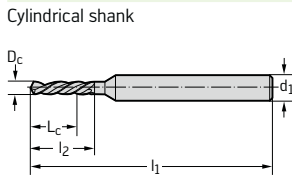

Continued



Micro drill A3153



~ 5 x D_c

Continued

	P	M	K	N	S	H	O
uncoated	●●	●●	●●	●●	●●		●●

DIN 1899	D _c 0-0,004 mm	d ₁ h8 mm	L _c mm	l ₁ mm	l ₂ mm	Designation A3153
Cylindrical shank	0,62	1	3,1	25	4,2	-0,62
	0,63	1	3,1	25	4,2	-0,63
	0,64	1	3,1	25	4,2	-0,64
	0,65	1	3,1	25	4,2	-0,65
	0,66	1	3,1	25	4,2	-0,66
	0,67	1	3,1	25	4,2	-0,67
	0,68	1	3,6	25	4,8	-0,68
	0,69	1	3,6	25	4,8	-0,69
	0,7	1	3,6	25	4,8	-0,7
	0,71	1	3,6	25	4,8	-0,71
	0,72	1	3,6	25	4,8	-0,72
	0,73	1	3,6	25	4,8	-0,73
	0,74	1	3,6	25	4,8	-0,74
	0,75	1	3,6	25	4,8	-0,75
	0,76	1	4,1	25	5,3	-0,76
	0,77	1	4,1	25	5,3	-0,77
	0,78	1	4,1	25	5,3	-0,78
	0,79	1	4,1	25	5,3	-0,79
	0,8	1,5	4	25	5,3	-0,8
	0,81	1,5	4	25	5,3	-0,81
	0,82	1,5	4	25	5,3	-0,82
	0,83	1,5	4	25	5,3	-0,83
	0,84	1,5	4	25	5,3	-0,84
	0,85	1,5	4	25	5,3	-0,85
	0,86	1,5	4,5	25	6	-0,86
	0,87	1,5	4,5	25	6	-0,87
	0,88	1,5	4,5	25	6	-0,88
	0,89	1,5	4,5	25	6	-0,89
	0,9	1,5	4,5	25	6	-0,9
	0,91	1,5	4,5	25	6	-0,91
	0,92	1,5	4,5	25	6	-0,92
	0,93	1,5	4,5	25	6	-0,93
	0,94	1,5	4,5	25	6	-0,94
	0,95	1,5	4,5	25	6	-0,95
	0,96	1,5	5	25	6,8	-0,96
	0,97	1,5	5	25	6,8	-0,97
	0,98	1,5	5	25	6,8	-0,98
	0,99	1,5	5	25	6,8	-0,99
	1	1,5	5	25	6,8	-1
	1,05	1,5	5	25	6,8	-1,05
	1,1	1,5	5	25	7,6	-1,1
	1,15	1,5	5	25	7,6	-1,15
	1,2	1,5	6	25	8,5	-1,2
	1,3	1,5	6	25	8,5	-1,3
	1,4	1,5	7	25	9,5	-1,4

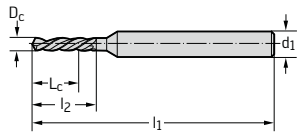

Twist drill with taper shank A4211



~ 8 x D_c

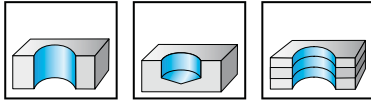

- HSS - steam treated
- Type N
- right-hand cutting
- 118° point angle

	P	M	K	N	S	H	O
uncoated	●●	●	●●	●●	●		●●

DIN 345	D _c h8 mm	D _c Inches/No	L _c mm	l ₁ mm	l ₂ mm	MK	Designation A4211
Morse taper 	3		28	114	33	MK1 B	-3
	3,175	1/8"	30	117	36	MK1 B	-1/8IN
	3,25		30	117	36	MK1 B	-3.25
	3,5		33	120	39	MK1 B	-3.5
	3,572	9/64"	33	120	39	MK1 B	-9/64IN
	3,75		33	120	39	MK1 B	-3.75
	3,969	5/32"	36	124	43	MK1 B	-5/32IN
	4		36	124	43	MK1 B	-4
	4,1		36	124	43	MK1 B	-4.1
	4,2		36	124	43	MK1 B	-4.2
	4,25		36	124	43	MK1 B	-4.25
	4,3		39	128	47	MK1 B	-4.3
	4,366	11/64"	39	128	47	MK1 B	-11/64IN
	4,4		39	128	47	MK1 B	-4.4
	4,5		39	128	47	MK1 B	-4.5
	4,7		39	128	47	MK1 B	-4.7
	4,75		39	128	47	MK1 B	-4.75
	4,763	3/16"	44	133	52	MK1 B	-3/16IN
	4,8		44	133	52	MK1 B	-4.8
	4,9		44	133	52	MK1 B	-4.9
	5		44	133	52	MK1 B	-5
	5,1		44	133	52	MK1 B	-5.1
	5,159	13/64"	44	133	52	MK1 B	-13/64IN
	5,2		44	133	52	MK1 B	-5.2
	5,25		44	133	52	MK1 B	-5.25
	5,4		48	138	57	MK1 B	-5.4
	5,5		48	138	57	MK1 B	-5.5
	5,556	7/32"	48	138	57	MK1 B	-7/32IN
	5,6		48	138	57	MK1 B	-5.6
	5,7		48	138	57	MK1 B	-5.7
	5,75		48	138	57	MK1 B	-5.75
	5,8		48	138	57	MK1 B	-5.8
	5,9		48	138	57	MK1 B	-5.9
	5,953	15/64"	48	138	57	MK1 B	-15/64IN
6		48	138	57	MK1 B	-6	
6,1		52	144	63	MK1 B	-6.1	
6,2		52	144	63	MK1 B	-6.2	
6,25		52	144	63	MK1 B	-6.25	
6,3		52	144	63	MK1 B	-6.3	
6,35	1/4"	52	144	63	MK1 B	-1/4IN	
6,4		52	144	63	MK1 B	-6.4	
6,5		52	144	63	MK1 B	-6.5	
6,6		52	144	63	MK1 B	-6.6	
6,7		52	144	63	MK1 B	-6.7	
6,747	17/64"	57	150	69	MK1 B	-17/64IN	
6,75		57	150	69	MK1 B	-6.75	
6,8		57	150	69	MK1 B	-6.8	

Continued



Twist drill with taper shank A4211



~ 8 x D_c

Continued

	P	M	K	N	S	H	O
uncoated	●●	●	●●	●●	●		●●

DIN 345	D _c h8 mm	D _c Inches/No	L _c mm	l ₁ mm	l ₂ mm	MK	Designation A4211
Morse taper	6,9		57	150	69	MK1 B	-6.9
	7		57	150	69	MK1 B	-7
	7,144	9/32"	57	150	69	MK1 B	-9/32IN
	7,2		57	150	69	MK1 B	-7.2
	7,25		57	150	69	MK1 B	-7.25
	7,3		57	150	69	MK1 B	-7.3
	7,4		57	150	69	MK1 B	-7.4
	7,5		57	150	69	MK1 B	-7.5
	7,541	19/64"	62	156	75	MK1 B	-19/64IN
	7,7		62	156	75	MK1 B	-7.7
	7,75		62	156	75	MK1 B	-7.75
	7,8		62	156	75	MK1 B	-7.8
	7,9		62	156	75	MK1 B	-7.9
	7,938	5/16"	62	156	75	MK1 B	-5/16IN
	8		62	156	75	MK1 B	-8
	8,1		62	156	75	MK1 B	-8.1
	8,2		62	156	75	MK1 B	-8.2
	8,25		62	156	75	MK1 B	-8.25
	8,3		62	156	75	MK1 B	-8.3
	8,334	21/64"	62	156	75	MK1 B	-21/64IN
	8,4		62	156	75	MK1 B	-8.4
	8,5		62	156	75	MK1 B	-8.5
	8,6		66	162	81	MK1 B	-8.6
	8,7		66	162	81	MK1 B	-8.7
	8,731	11/32"	66	162	81	MK1 B	-11/32IN
	8,75		66	162	81	MK1 B	-8.75
	8,8		66	162	81	MK1 B	-8.8
	8,9		66	162	81	MK1 B	-8.9
	9		66	162	81	MK1 B	-9
	9,1		66	162	81	MK1 B	-9.1
	9,128	23/64"	66	162	81	MK1 B	-23/64IN
	9,2		66	162	81	MK1 B	-9.2
	9,25		66	162	81	MK1 B	-9.25
	9,3		66	162	81	MK1 B	-9.3
	9,4		66	162	81	MK1 B	-9.4
	9,5		66	162	81	MK1 B	-9.5
	9,525	3/8"	71	168	87	MK1 B	-3/8IN
	9,6		71	168	87	MK1 B	-9.6
	9,7		71	168	87	MK1 B	-9.7
	9,75		71	168	87	MK1 B	-9.75
	9,8		71	168	87	MK1 B	-9.8
	9,9		71	168	87	MK1 B	-9.9
	9,922	25/64"	71	168	87	MK1 B	-25/64IN
	10		71	168	87	MK1 B	-10
	10,1		71	168	87	MK1 B	-10.1
	10,2		71	168	87	MK1 B	-10.2
	10,25		71	168	87	MK1 B	-10.25
	10,3		71	168	87	MK1 B	-10.3
	10,319	13/32"	71	168	87	MK1 B	-13/32IN
	10,4		71	168	87	MK1 B	-10.4
	10,5		71	168	87	MK1 B	-10.5
	10,6		71	168	87	MK1 B	-10.6
	10,7		76	175	94	MK1 B	-10.7
	10,716	27/64"	76	175	94	MK1 B	-27/64IN
	10,75		76	175	94	MK1 B	-10.75

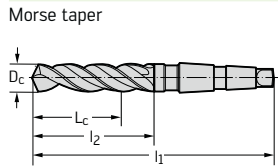

Continued



Twist drill with taper shank A4211



~ 8 x D_c

Continued

	P	M	K	N	S	H	O
uncoated	●●	●	●●	●●	●		●●

DIN 345	D _c h8 mm	D _c Inches/No	L _c mm	l ₁ mm	l ₂ mm	MK	Designation A4211
Morse taper 	10,8		76	175	94	MK1 B	-10.8
	10,9		76	175	94	MK1 B	-10.9
	11		76	175	94	MK1 B	-11
	11,1		76	175	94	MK1 B	-11.1
	11,113	7/16"	76	175	94	MK1 B	-7/16IN
	11,2		76	175	94	MK1 B	-11.2
	11,25		76	175	94	MK1 B	-11.25
	11,3		76	175	94	MK1 B	-11.3
	11,4		76	175	94	MK1 B	-11.4
	11,5		76	175	94	MK1 B	-11.5
	11,509	29/64"	76	175	94	MK1 B	-29/64IN
	11,6		76	175	94	MK1 B	-11.6
	11,7		76	175	94	MK1 B	-11.7
	11,75		76	175	94	MK1 B	-11.75
	11,8		76	175	94	MK1 B	-11.8
	11,9		87	182	101	MK1 B	-11.9
	11,906	15/32"	87	182	101	MK1 B	-15/32IN
	12		87	182	101	MK1 B	-12
	12,1		87	182	101	MK1 B	-12.1
	12,2		87	182	101	MK1 B	-12.2
	12,25		87	182	101	MK1 B	-12.25
	12,3		87	182	101	MK1 B	-12.3
	12,303	31/64"	87	182	101	MK1 B	-31/64IN
	12,4		87	182	101	MK1 B	-12.4
	12,5		87	182	101	MK1 B	-12.5
	12,6		87	182	101	MK1 B	-12.6
	12,7	1/2"	87	182	101	MK1 B	-1/2IN
	12,75		87	182	101	MK1 B	-12.75
	12,8		87	182	101	MK1 B	-12.8
	12,9		87	182	101	MK1 B	-12.9
	13		87	182	101	MK1 B	-13
	13,097	33/64"	87	182	101	MK1 B	-33/64IN
	13,1		87	182	101	MK1 B	-13.1
	13,2		87	182	101	MK1 B	-13.2
13,25		94	189	108	MK1 B	-13.25	
13,3		94	189	108	MK1 B	-13.3	
13,494	17/32"	94	189	108	MK1 B	-17/32IN	
13,5		94	189	108	MK1 B	-13.5	
13,6		94	189	108	MK1 B	-13.6	
13,7		94	189	108	MK1 B	-13.7	
13,75		94	189	108	MK1 B	-13.75	
13,8		94	189	108	MK1 B	-13.8	
13,891	35/64"	94	189	108	MK1 B	-35/64IN	
13,9		94	189	108	MK1 B	-13.9	
14		94	189	108	MK1 B	-14	
14,1		99	212	114	MK2 B	-14.1	
14,2		99	212	114	MK2 B	-14.2	
14,25		99	212	114	MK2 B	-14.25	
14,288	9/16"	99	212	114	MK2 B	-9/16IN	
14,3		99	212	114	MK2 B	-14.3	
14,4		99	212	114	MK2 B	-14.4	
14,5		99	212	114	MK2 B	-14.5	
14,6		99	212	114	MK2 B	-14.6	
14,684	37/64"	99	212	114	MK2 B	-37/64IN	

Continued



Twist drill with taper shank A4211



~ 8 x D_c

Continued

	P	M	K	N	S	H	O
uncoated	●●	●	●●	●●	●		●●

DIN 345	D _c h8 mm	D _c Inches/No	L _c mm	l ₁ mm	l ₂ mm	MK	Designation A4211
Morse taper 	14,7		99	212	114	MK2 B	-14.7
	14,75		99	212	114	MK2 B	-14.75
	14,8		99	212	114	MK2 B	-14.8
	14,9		99	212	114	MK2 B	-14.9
	15		99	212	114	MK2 B	-15
	15,081	19/32"	104	218	120	MK2 B	-19/32IN
	15,1		104	218	120	MK2 B	-15.1
	15,2		104	218	120	MK2 B	-15.2
	15,25		104	218	120	MK2 B	-15.25
	15,3		104	218	120	MK2 B	-15.3
	15,478	39/64"	104	218	120	MK2 B	-39/64IN
	15,5		104	218	120	MK2 B	-15.5
	15,7		104	218	120	MK2 B	-15.7
	15,75		104	218	120	MK2 B	-15.75
	15,8		104	218	120	MK2 B	-15.8
	15,875	5/8"	104	218	120	MK2 B	-5/8IN
	15,9		104	218	120	MK2 B	-15.9
	16		104	218	120	MK2 B	-16
	16,1		108	223	125	MK2 B	-16.1
	16,2		108	223	125	MK2 B	-16.2
	16,25		108	223	125	MK2 B	-16.25
	16,272	41/64"	108	223	125	MK2 B	-41/64IN
	16,3		108	223	125	MK2 B	-16.3
	16,4		108	223	125	MK2 B	-16.4
	16,5		108	223	125	MK2 B	-16.5
	16,6		108	223	125	MK2 B	-16.6
	16,669	21/32"	108	223	125	MK2 B	-21/32IN
	16,7		108	223	125	MK2 B	-16.7
	16,75		108	223	125	MK2 B	-16.75
	16,8		108	223	125	MK2 B	-16.8
	16,9		108	223	125	MK2 B	-16.9
	17		108	223	125	MK2 B	-17
	17,066	43/64"	112	228	130	MK2 B	-43/64IN
	17,1		112	228	130	MK2 B	-17.1
17,2		112	228	130	MK2 B	-17.2	
17,25		112	228	130	MK2 B	-17.25	
17,3		112	228	130	MK2 B	-17.3	
17,4		112	228	130	MK2 B	-17.4	
17,463	11/16"	112	228	130	MK2 B	-11/16IN	
17,5		112	228	130	MK2 B	-17.5	
17,6		112	228	130	MK2 B	-17.6	
17,7		112	228	130	MK2 B	-17.7	
17,75		112	228	130	MK2 B	-17.75	
17,8		112	228	130	MK2 B	-17.8	
17,859	45/64"	112	228	130	MK2 B	-45/64IN	
17,9		112	228	130	MK2 B	-17.9	
18		112	228	130	MK2 B	-18	
18,1		116	233	135	MK2 B	-18.1	
18,2		116	233	135	MK2 B	-18.2	
18,25		116	233	135	MK2 B	-18.25	
18,256	23/32"	116	233	135	MK2 B	-23/32IN	
18,3		116	233	135	MK2 B	-18.3	
18,4		116	233	135	MK2 B	-18.4	
18,5		116	233	135	MK2 B	-18.5	
18,6		116	233	135	MK2 B	-18.6	

Continued



Twist drill with taper shank A4211



~ 8 x D_c

Continued

	P	M	K	N	S	H	O
uncoated	●●	●	●●	●●	●		●●

DIN 345	D _c h8 mm	D _c Inches/No	L _c mm	l ₁ mm	l ₂ mm	MK	Designation A4211
Morse taper	18,653	47/64"	116	233	135	MK2 B	-47/64IN
	18,7		116	233	135	MK2 B	-18.7
	18,75		116	233	135	MK2 B	-18.75
	18,8		116	233	135	MK2 B	-18.8
	18,9		116	233	135	MK2 B	-18.9
	19		116	233	135	MK2 B	-19
	19,05	3/4"	120	238	140	MK2 B	-3/4IN
	19,1		120	238	140	MK2 B	-19.1
	19,2		120	238	140	MK2 B	-19.2
	19,25		120	238	140	MK2 B	-19.25
	19,3		120	238	140	MK2 B	-19.3
	19,4		120	238	140	MK2 B	-19.4
	19,447	49/64"	120	238	140	MK2 B	-49/64IN
	19,5		120	238	140	MK2 B	-19.5
	19,7		120	238	140	MK2 B	-19.7
	19,75		120	238	140	MK2 B	-19.75
	19,8		120	238	140	MK2 B	-19.8
	19,844	25/32"	120	238	140	MK2 B	-25/32IN
	19,9		120	238	140	MK2 B	-19.9
	20		120	238	140	MK2 B	-20
	20,1		123	243	145	MK2 B	-20.1
	20,2		123	243	145	MK2 B	-20.2
	20,241	51/64"	123	243	145	MK2 B	-51/64IN
	20,25		123	243	145	MK2 B	-20.25
	20,3		123	243	145	MK2 B	-20.3
	20,4		123	243	145	MK2 B	-20.4
	20,5		123	243	145	MK2 B	-20.5
	20,6		123	243	145	MK2 B	-20.6
	20,638	13/16"	123	243	145	MK2 B	-13/16IN
	20,7		123	243	145	MK2 B	-20.7
	20,75		123	243	145	MK2 B	-20.75
	20,8		123	243	145	MK2 B	-20.8
	20,9		123	243	145	MK2 B	-20.9
	21		123	243	145	MK2 B	-21
	21,034	53/64"	123	243	145	MK2 B	-53/64IN
	21,1		123	243	145	MK2 B	-21.1
	21,2		123	243	145	MK2 B	-21.2
	21,25		127	248	150	MK2 B	-21.25
	21,431	27/32"	127	248	150	MK2 B	-27/32IN
	21,5		127	248	150	MK2 B	-21.5
	21,6		127	248	150	MK2 B	-21.6
	21,7		127	248	150	MK2 B	-21.7
	21,75		127	248	150	MK2 B	-21.75
	21,8		127	248	150	MK2 B	-21.8
	21,828	55/64"	127	248	150	MK2 B	-55/64IN
	22		127	248	150	MK2 B	-22
	22,1		127	248	150	MK2 B	-22.1
	22,2		127	248	150	MK2 B	-22.2
	22,225	7/8"	127	248	150	MK2 B	-7/8IN
	22,25		127	248	150	MK2 B	-22.25
	22,3		127	248	150	MK2 B	-22.3
	22,5		131	253	155	MK2 B	-22.5
	22,622	57/64"	131	253	155	MK2 B	-57/64IN
	22,7		131	253	155	MK2 B	-22.7
	22,75		131	253	155	MK2 B	-22.75

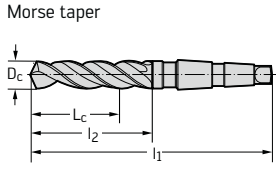

Continued



Twist drill with taper shank A4211



~ 8 x D_c

Continued

	P	M	K	N	S	H	O
uncoated	●●	●	●●	●●	●		●●

DIN 345	D _c h8 mm	D _c Inches/No	L _c mm	l ₁ mm	l ₂ mm	MK	Designation A4211
Morse taper	23		131	253	155	MK2 B	-23
	23,019	29/32"	131	253	155	MK2 B	-29/32IN
	23,25		131	276	155	MK3 B	-23.25
	23,416	59/64"	131	276	155	MK3 B	-59/64IN
	23,5		131	276	155	MK3 B	-23.5
	23,75		135	281	160	MK3 B	-23.75
	23,813	15/16"	135	281	160	MK3 B	-15/16IN
	24		135	281	160	MK3 B	-24
	24,209	61/64"	135	281	160	MK3 B	-61/64IN
	24,25		135	281	160	MK3 B	-24.25
	24,5		135	281	160	MK3 B	-24.5
	24,606	31/32"	135	281	160	MK3 B	-31/32IN
	24,75		135	281	160	MK3 B	-24.75
	25		135	281	160	MK3 B	-25
	25,003	63/64"	134	281	160	MK3 B	-63/64IN
	25,25		138	286	165	MK3 B	-25.25
	25,4	1"	138	286	165	MK3 B	-1IN
	25,5		138	286	165	MK3 B	-25.5
	25,75		138	286	165	MK3 B	-25.75
	25,797	1 1/64"	138	286	165	MK3 B	-1.1/64IN
	26		138	286	165	MK3 B	-26
	26,194	1 1/32"	138	286	165	MK3 B	-1.1/32IN
	26,25		138	286	165	MK3 B	-26.25
	26,5		138	286	165	MK3 B	-26.5
	26,75		142	291	170	MK3 B	-26.75
	26,988	1 1/16"	142	291	170	MK3 B	-1.1/16IN
	27		142	291	170	MK3 B	-27
	27,25		142	291	170	MK3 B	-27.25
	27,5		142	291	170	MK3 B	-27.5
	27,75		142	291	170	MK3 B	-27.75
	28		142	291	170	MK3 B	-28
	28,178	1 7/64"	145	296	175	MK3 B	-1.7/64IN
	28,25		145	296	175	MK3 B	-28.25
	28,5		145	296	175	MK3 B	-28.5
	28,575	1 1/8"	145	296	175	MK3 B	-1.1/8IN
	28,75		145	296	175	MK3 B	-28.75
	28,972	1 9/64"	145	296	175	MK3 B	-1.9/64IN
	29		145	296	175	MK3 B	-29
	29,25		145	296	175	MK3 B	-29.25
	29,369	1 5/32"	145	296	175	MK3 B	-1.5/32IN
	29,5		145	296	175	MK3 B	-29.5
	29,75		145	296	175	MK3 B	-29.75
	30		145	296	175	MK3 B	-30
	30,163	1 3/16"	148	301	180	MK3 B	-1.3/16IN
	30,25		148	301	180	MK3 B	-30.25
	30,5		148	301	180	MK3 B	-30.5
	30,75		148	301	180	MK3 B	-30.75
	30,956	1 7/32"	148	301	180	MK3 B	-1.7/32IN
	31		148	301	180	MK3 B	-31
	31,25		148	301	180	MK3 B	-31.25
	31,5		148	301	180	MK3 B	-31.5
	31,75	1 1/4"	153	306	185	MK3 B	-1.1/4IN
	32		151	334	185	MK4 B	-32
	32,5		151	334	185	MK4 B	-32.5

Continued



Twist drill with taper shank A4211



~ 8 x D_c

Continued

	P	M	K	N	S	H	O
uncoated	●●	●	●●	●●	●		●●

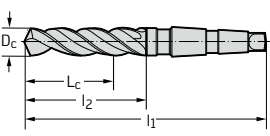
DIN 345	D _c h8 mm	D _c Inches/No	L _c mm	l ₁ mm	l ₂ mm	MK	Designation A4211
Morse taper	32,544	1 9/32"	151	334	185	MK4 B	-1.9/32IN
	33		151	334	185	MK4 B	-33
	33,338	1 5/16"	151	334	185	MK4 B	-1.5/16IN
	33,5		151	334	185	MK4 B	-33.5
	34		154	339	190	MK4 B	-34
	34,131	1 11/32"	154	339	190	MK4 B	-1.11/32IN
	34,5		154	339	190	MK4 B	-34.5
	34,925	1 3/8"	154	339	190	MK4 B	-1.3/8IN
	35		154	339	190	MK4 B	-35
	35,5		154	339	190	MK4 B	-35.5
	35,719	1 13/32"	157	344	195	MK4 B	-1.13/32IN
	36		157	344	195	MK4 B	-36
	36,5		157	344	195	MK4 B	-36.5
	36,513	1 7/16"	157	344	195	MK4 B	-1.7/16IN
	37		157	344	195	MK4 B	-37
	37,5		157	344	195	MK4 B	-37.5
	38		160	349	200	MK4 B	-38
	38,1	1 1/2"	160	349	200	MK4 B	-1.1/2IN
	38,5		160	349	200	MK4 B	-38.5
	39		160	349	200	MK4 B	-39
	39,5		160	349	200	MK4 B	-39.5
	39,688	1 9/16"	160	349	200	MK4 B	-1.9/16IN
	40		160	349	200	MK4 B	-40
	40,5		162	354	205	MK4 B	-40.5
	41		162	354	205	MK4 B	-41
	41,275	1 5/8"	162	354	205	MK4 B	-1.5/8IN
	41,5		162	354	205	MK4 B	-41.5
	42		162	354	205	MK4 B	-42
	42,5		162	354	205	MK4 B	-42.5
	42,863	1 11/16"	165	359	210	MK4 B	-1.11/16IN
	43		165	359	210	MK4 B	-43
	43,5		165	359	210	MK4 B	-43.5
	44		165	359	210	MK4 B	-44
	44,45	1 3/4"	165	359	210	MK4 B	-1.3/4IN
	44,5		165	359	210	MK4 B	-44.5
	45		165	359	210	MK4 B	-45
	45,244	1 25/32"	167	364	215	MK4 B	-1.25/32IN
	45,5		167	364	215	MK4 B	-45.5
	46		167	364	215	MK4 B	-46
	46,5		167	364	215	MK4 B	-46.5
	47		167	364	215	MK4 B	-47
	47,5		167	364	215	MK4 B	-47.5
	48		170	369	220	MK4 B	-48
	48,5		170	369	220	MK4 B	-48.5
	49		170	369	220	MK4 B	-49
	49,5		170	369	220	MK4 B	-49.5
	50		170	369	220	MK4 B	-50
	50,5		174	374	225	MK4 B	-50.5
	50,8	2"	174	374	225	MK4 B	-2IN
	51		172	412	225	MK5 B	-51
	52		172	412	225	MK5 B	-52
	53		172	412	225	MK5 B	-53
	54		174	417	230	MK5 B	-54
	55		174	417	230	MK5 B	-55
	56		174	417	230	MK5 B	-56

Continued



Twist drill with taper shank A4211



~ 8 x D_c

Continued

	P	M	K	N	S	H	O
uncoated	●●	●	●●	●●	●		●●

DIN 345	D _c h8 mm	D _c Inches/No	L _c mm	l ₁ mm	l ₂ mm	MK	Designation A4211
Morse taper 	57		175	422	235	MK5 B	-57
	58		175	422	235	MK5 B	-58
	59		175	422	235	MK5 B	-59
	60		175	422	235	MK5 B	-60
	61		177	427	240	MK5 B	-61
	62		177	427	240	MK5 B	-62
	63		177	427	240	MK5 B	-63
	63,5	2 1/2"	178	432	245	MK5 B	-2.1/2IN
	64		178	432	245	MK5 B	-64
	65		178	432	245	MK5 B	-65
66		178	432	245	MK5 B	-66	
66,675	2 5/8"	178	432	245	MK5 B	-2.5/8IN	
67		178	432	245	MK5 B	-67	
68		179	437	250	MK5 B	-68	
69		179	437	250	MK5 B	-69	
69,85	2 3/4"	179	437	250	MK5 B	-2.3/4IN	
70		179	437	250	MK5 B	-70	
71		179	437	250	MK5 B	-71	
72		180	442	255	MK5 B	-72	
73		180	442	255	MK5 B	-73	
74		180	442	255	MK5 B	-74	
75		180	442	255	MK5 B	-75	
76		183	447	260	MK5 B	-76	
76,2	3"	183	447	260	MK5 B	-3IN	
77		180	514	260	MK6 B	-77	
78		180	514	260	MK6 B	-78	
79		180	514	260	MK6 B	-79	
80		180	514	260	MK6 B	-80	
81		180	519	265	MK6 B	-81	
82		180	519	265	MK6 B	-82	
84		180	519	265	MK6 B	-84	
85		180	519	265	MK6 B	-85	
90		180	524	270	MK6 B	-90	
95		180	529	275	MK6 B	-95	
100		180	534	280	MK6 B	-100	

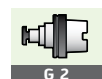

G 2



B 352

Twist drill with taper shank A4211TIN



~ 8 x D_c

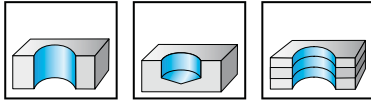

- HSS - TiN
- Type N
- right-hand cutting
- 118° point angle

	P	M	K	N	S	H	O
TiN	●●	●●	●●	●●			●●

DIN 345	D _c h8 mm	L _c mm	l ₁ mm	l ₂ mm	MK	Designation A4211TIN
Morse taper 	5	44	133	52	MK1 B	-5
	6	48	138	57	MK1 B	-6
	6,5	52	144	63	MK1 B	-6.5
	6,8	57	150	69	MK1 B	-6.8
	7	57	150	69	MK1 B	-7
	8	62	156	75	MK1 B	-8
	8,5	62	156	75	MK1 B	-8.5
	9	66	162	81	MK1 B	-9
	9,5	66	162	81	MK1 B	-9.5
	10	71	168	87	MK1 B	-10
	10,2	71	168	87	MK1 B	-10.2
	10,5	71	168	87	MK1 B	-10.5
	11	76	175	94	MK1 B	-11
	11,5	76	175	94	MK1 B	-11.5
	12	87	182	101	MK1 B	-12
	12,5	87	182	101	MK1 B	-12.5
	13	87	182	101	MK1 B	-13
	13,5	94	189	108	MK1 B	-13.5
	14	94	189	108	MK1 B	-14
	14,5	99	212	114	MK2 B	-14.5
	15	99	212	114	MK2 B	-15
	15,5	104	218	120	MK2 B	-15.5
	16	104	218	120	MK2 B	-16
	16,5	108	223	125	MK2 B	-16.5
	17	108	223	125	MK2 B	-17
	17,5	112	228	130	MK2 B	-17.5
	18	112	228	130	MK2 B	-18
	18,5	116	233	135	MK2 B	-18.5
	19	116	233	135	MK2 B	-19
	19,5	120	238	140	MK2 B	-19.5
20	120	238	140	MK2 B	-20	
20,5	123	243	145	MK2 B	-20.5	
21	123	243	145	MK2 B	-21	
21,5	127	248	150	MK2 B	-21.5	
22	127	248	150	MK2 B	-22	
22,5	131	253	155	MK2 B	-22.5	
23	131	253	155	MK2 B	-23	
24	135	281	160	MK3 B	-24	
25	135	281	160	MK3 B	-25	
26	138	286	165	MK3 B	-26	
27	142	291	170	MK3 B	-27	
28	142	291	170	MK3 B	-28	
29	145	296	175	MK3 B	-29	
30	145	296	175	MK3 B	-30	

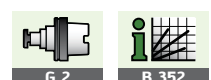

Twist drill with taper shank

A4244

VA



~ 8 x D_c

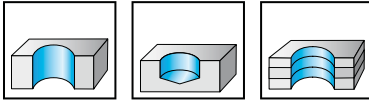

- HSS-E - uncoated
- Type VA
- right-hand cutting
- 130° point angle

	P	M	K	N	S	H	O
uncoated	●●	●●	●	●	●●		

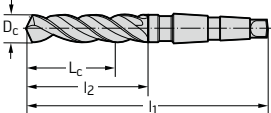
DIN 345	D _c h8 mm	L _c mm	l ₁ mm	l ₂ mm	MK	Designation A4244
Morse taper 	10	71	168	87	MK1 B	-10
	10,2	71	168	87	MK1 B	-10.2
	10,5	71	168	87	MK1 B	-10.5
	10,8	76	175	94	MK1 B	-10.8
	11	76	175	94	MK1 B	-11
	11,2	76	175	94	MK1 B	-11.2
	11,5	76	175	94	MK1 B	-11.5
	11,8	76	175	94	MK1 B	-11.8
	12	87	182	101	MK1 B	-12
	12,2	87	182	101	MK1 B	-12.2
	12,5	87	182	101	MK1 B	-12.5
	12,8	87	182	101	MK1 B	-12.8
	13	87	182	101	MK1 B	-13
	13,2	87	182	101	MK1 B	-13.2
	13,5	94	189	108	MK1 B	-13.5
	13,8	94	189	108	MK1 B	-13.8
	14	94	189	108	MK1 B	-14
	14,25	99	212	114	MK2 B	-14.25
	14,5	99	212	114	MK2 B	-14.5
	14,75	99	212	114	MK2 B	-14.75
	15	99	212	114	MK2 B	-15
15,25	104	218	120	MK2 B	-15.25	
15,5	104	218	120	MK2 B	-15.5	
15,75	104	218	120	MK2 B	-15.75	
16	104	218	120	MK2 B	-16	
16,25	108	223	125	MK2 B	-16.25	
16,5	108	223	125	MK2 B	-16.5	
16,75	108	223	125	MK2 B	-16.75	
17	108	223	125	MK2 B	-17	
17,25	112	228	130	MK2 B	-17.25	
17,5	112	228	130	MK2 B	-17.5	
17,75	112	228	130	MK2 B	-17.75	
18	112	228	130	MK2 B	-18	
18,25	116	233	135	MK2 B	-18.25	
18,5	116	233	135	MK2 B	-18.5	
18,75	116	233	135	MK2 B	-18.75	
19	116	233	135	MK2 B	-19	
19,25	120	238	140	MK2 B	-19.25	
19,5	120	238	140	MK2 B	-19.5	
19,75	120	238	140	MK2 B	-19.75	
20	120	238	140	MK2 B	-20	
20,25	123	243	145	MK2 B	-20.25	
20,5	123	243	145	MK2 B	-20.5	
20,75	123	243	145	MK2 B	-20.75	
21	123	243	145	MK2 B	-21	
21,25	127	248	150	MK2 B	-21.25	
21,5	127	248	150	MK2 B	-21.5	

Continued



Twist drill with taper shank
A4244
VA



~ 8 x D_c

	P	M	K	N	S	H	O
uncoated	●●	●●	●●	●	●●		

Continued

DIN 345	D _c h8 mm	L _c mm	l ₁ mm	l ₂ mm	MK	Designation A4244
Morse taper	21,75	127	248	150	MK2 B	-21.75
	22	127	248	150	MK2 B	-22
	22,25	127	248	150	MK2 B	-22.25
	22,5	131	253	155	MK2 B	-22.5
	22,75	131	253	155	MK2 B	-22.75
	23	131	253	155	MK2 B	-23
	23,5	131	276	155	MK3 B	-23.5
	24	135	281	160	MK3 B	-24
	24,5	135	281	160	MK3 B	-24.5
	25	135	281	160	MK3 B	-25
	25,5	138	286	165	MK3 B	-25.5
	26	138	286	165	MK3 B	-26
	26,5	138	286	165	MK3 B	-26.5
	27	142	291	170	MK3 B	-27
	27,5	142	291	170	MK3 B	-27.5
	28	142	291	170	MK3 B	-28
	28,5	145	296	175	MK3 B	-28.5
	29	145	296	175	MK3 B	-29
	29,5	145	296	175	MK3 B	-29.5
	30	145	296	175	MK3 B	-30
	30,5	148	301	180	MK3 B	-30.5
	31	148	301	180	MK3 B	-31
	31,5	148	301	180	MK3 B	-31.5
	32	151	334	185	MK4 B	-32

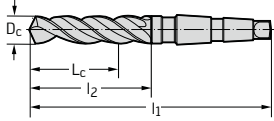

Twist drill with taper shank

A4247

Alpha® XE



~ 8 x D_c

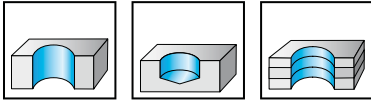

- HSS-E - fibre-steamed
- Type Alpha® XE
- right-hand cutting
- 130° point angle
- from 23.02 mm bright finish

	P	M	K	N	S	H	O
uncoated	●●	●●	●●	●●	●●		●●

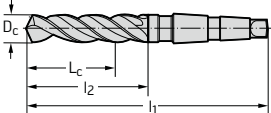
DIN 345	D _c h8 mm	L _c mm	l ₁ mm	l ₂ mm	MK	Designation A4247
Morse taper 	10	71	168	87	MK1 B	-10
	10,2	71	168	87	MK1 B	-10.2
	10,5	71	168	87	MK1 B	-10.5
	10,8	76	175	94	MK1 B	-10.8
	11	76	175	94	MK1 B	-11
	11,2	76	175	94	MK1 B	-11.2
	11,5	76	175	94	MK1 B	-11.5
	11,8	76	175	94	MK1 B	-11.8
	12	87	182	101	MK1 B	-12
	12,2	87	182	101	MK1 B	-12.2
	12,5	87	182	101	MK1 B	-12.5
	12,8	87	182	101	MK1 B	-12.8
	13	87	182	101	MK1 B	-13
	13,2	87	182	101	MK1 B	-13.2
	13,5	94	189	108	MK1 B	-13.5
	13,8	94	189	108	MK1 B	-13.8
	14	94	189	108	MK1 B	-14
	14,25	99	212	114	MK2 B	-14.25
	14,5	99	212	114	MK2 B	-14.5
	14,75	99	212	114	MK2 B	-14.75
	15	99	212	114	MK2 B	-15
15,25	104	218	120	MK2 B	-15.25	
15,5	104	218	120	MK2 B	-15.5	
15,75	104	218	120	MK2 B	-15.75	
16	104	218	120	MK2 B	-16	
16,25	108	223	125	MK2 B	-16.25	
16,5	108	223	125	MK2 B	-16.5	
16,75	108	223	125	MK2 B	-16.75	
17	108	223	125	MK2 B	-17	
17,25	112	228	130	MK2 B	-17.25	
17,5	112	228	130	MK2 B	-17.5	
17,75	112	228	130	MK2 B	-17.75	
18	112	228	130	MK2 B	-18	
18,25	116	233	135	MK2 B	-18.25	
18,5	116	233	135	MK2 B	-18.5	
18,75	116	233	135	MK2 B	-18.75	
19	116	233	135	MK2 B	-19	
19,25	120	238	140	MK2 B	-19.25	
19,5	120	238	140	MK2 B	-19.5	
19,75	120	238	140	MK2 B	-19.75	
20	120	238	140	MK2 B	-20	
20,25	123	243	145	MK2 B	-20.25	
20,5	123	243	145	MK2 B	-20.5	
20,75	123	243	145	MK2 B	-20.75	
21	123	243	145	MK2 B	-21	
21,25	127	248	150	MK2 B	-21.25	
21,5	127	248	150	MK2 B	-21.5	

Continued

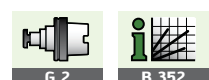

Twist drill with taper shank A4247 Alpha® XE



~ 8 x D_c

	P	M	K	N	S	H	O
uncoated	●●	●●	●●	●●	●●		●●

Continued

DIN 345	D _c h8 mm	L _c mm	l ₁ mm	l ₂ mm	MK	Designation A4247
Morse taper	21,75	127	248	150	MK2 B	-21.75
	22	127	248	150	MK2 B	-22
	22,25	127	248	150	MK2 B	-22.25
	22,5	131	253	155	MK2 B	-22.5
	22,75	131	253	155	MK2 B	-22.75
	23	131	253	155	MK2 B	-23
	23,5	131	276	155	MK3 B	-23.5
	24	135	281	160	MK3 B	-24
	24,5	135	281	160	MK3 B	-24.5
	25	135	281	160	MK3 B	-25
	25,5	138	286	165	MK3 B	-25.5
	26	138	286	165	MK3 B	-26
	26,5	138	286	165	MK3 B	-26.5
	27	142	291	170	MK3 B	-27
	27,5	142	291	170	MK3 B	-27.5
	28	142	291	170	MK3 B	-28
	28,5	145	296	175	MK3 B	-28.5
	29	145	296	175	MK3 B	-29
	29,5	145	296	175	MK3 B	-29.5
	30	145	296	175	MK3 B	-30
	30,5	148	301	180	MK3 B	-30.5
	31	148	301	180	MK3 B	-31
	31,5	148	301	180	MK3 B	-31.5
	32	151	334	185	MK4 B	-32
	32,5	151	334	185	MK4 B	-32.5
	33	151	334	185	MK4 B	-33
	33,5	151	334	185	MK4 B	-33.5
	34	154	339	190	MK4 B	-34
	34,5	154	339	190	MK4 B	-34.5
	35	154	339	190	MK4 B	-35
	36	157	344	195	MK4 B	-36
	37	157	344	195	MK4 B	-37
	38	160	349	200	MK4 B	-38
	39	160	349	200	MK4 B	-39
	40	160	349	200	MK4 B	-40

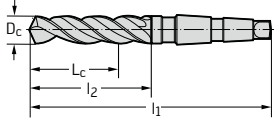

Long twist drill with taper shank A4411



~ 12 x D_c

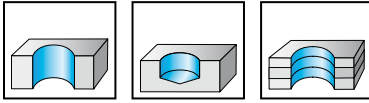

- HSS - steam treated
- Type N
- right-hand cutting
- 118° point angle

	P	M	K	N	S	H	O
uncoated	●●	●	●●	●●	●		●●

DIN 341	D _c h8 mm	L _c mm	l ₁ mm	l ₂ mm	MK	Designation A4411
Morse taper	5	66	155	74	MK1 B	-5
	5,5	71	161	80	MK1 B	-5.5
	6	71	161	80	MK1 B	-6
	6,5	75	167	86	MK1 B	-6.5
	6,8	81	174	93	MK1 B	-6.8
	7	81	174	93	MK1 B	-7
	7,5	81	174	93	MK1 B	-7.5
	8	87	181	100	MK1 B	-8
	8,1	87	181	100	MK1 B	-8.1
	8,2	87	181	100	MK1 B	-8.2
	8,25	87	181	100	MK1 B	-8.25
	8,3	87	181	100	MK1 B	-8.3
	8,4	87	181	100	MK1 B	-8.4
	8,5	87	181	100	MK1 B	-8.5
	8,7	92	188	107	MK1 B	-8.7
	8,75	92	188	107	MK1 B	-8.75
	8,8	92	188	107	MK1 B	-8.8
	9	92	188	107	MK1 B	-9
	9,1	92	188	107	MK1 B	-9.1
	9,5	92	188	107	MK1 B	-9.5
	9,7	100	197	116	MK1 B	-9.7
	9,8	100	197	116	MK1 B	-9.8
	9,9	100	197	116	MK1 B	-9.9
	10	100	197	116	MK1 B	-10
	10,1	100	197	116	MK1 B	-10.1
	10,2	100	197	116	MK1 B	-10.2
	10,25	100	197	116	MK1 B	-10.25
	10,3	100	197	116	MK1 B	-10.3
	10,4	100	197	116	MK1 B	-10.4
	10,5	100	197	116	MK1 B	-10.5
	10,6	100	197	116	MK1 B	-10.6
	10,7	107	206	125	MK1 B	-10.7
	10,8	107	206	125	MK1 B	-10.8
	10,9	107	206	125	MK1 B	-10.9
	11	107	206	125	MK1 B	-11
	11,1	107	206	125	MK1 B	-11.1
	11,2	107	206	125	MK1 B	-11.2
	11,5	107	206	125	MK1 B	-11.5
	11,6	107	206	125	MK1 B	-11.6
	11,7	107	206	125	MK1 B	-11.7
	11,75	107	206	125	MK1 B	-11.75
	11,8	107	206	125	MK1 B	-11.8
	11,9	120	215	134	MK1 B	-11.9
	12	120	215	134	MK1 B	-12
	12,1	120	215	134	MK1 B	-12.1
	12,3	120	215	134	MK1 B	-12.3
	12,5	120	215	134	MK1 B	-12.5

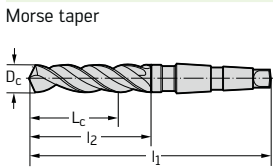

Continued



Long twist drill with taper shank A4411



~ 12 x D_c

Continued

	P	M	K	N	S	H	O
uncoated	●●	●	●●	●●	●		●●

DIN 341	D _c h8 mm	L _c mm	l ₁ mm	l ₂ mm	MK	Designation A4411
Morse taper	12,75	120	215	134	MK1 B	-12.75
	13	120	215	134	MK1 B	-13
	13,5	128	223	142	MK1 B	-13.5
	13,75	128	223	142	MK1 B	-13.75
	14	128	223	142	MK1 B	-14
	14,25	132	245	147	MK2 B	-14.25
	14,5	132	245	147	MK2 B	-14.5
	14,75	132	245	147	MK2 B	-14.75
	15	132	245	147	MK2 B	-15
	15,25	137	251	153	MK2 B	-15.25
	15,5	137	251	153	MK2 B	-15.5
	15,75	137	251	153	MK2 B	-15.75
	16	137	251	153	MK2 B	-16
	16,25	142	257	159	MK2 B	-16.25
	16,5	142	257	159	MK2 B	-16.5
	16,75	142	257	159	MK2 B	-16.75
	17	142	257	159	MK2 B	-17
	17,25	147	263	165	MK2 B	-17.25
	17,5	147	263	165	MK2 B	-17.5
	17,75	147	263	165	MK2 B	-17.75
	18	147	263	165	MK2 B	-18
	18,5	152	269	171	MK2 B	-18.5
	18,75	152	269	171	MK2 B	-18.75
	19	152	269	171	MK2 B	-19
	19,5	157	275	177	MK2 B	-19.5
	19,75	157	275	177	MK2 B	-19.75
	20	157	275	177	MK2 B	-20
	20,25	162	282	184	MK2 B	-20.25
	20,5	162	282	184	MK2 B	-20.5
	20,75	162	282	184	MK2 B	-20.75
	21	162	282	184	MK2 B	-21
	21,25	168	289	191	MK2 B	-21.25
	21,5	168	289	191	MK2 B	-21.5
	21,75	168	289	191	MK2 B	-21.75
	22	168	289	191	MK2 B	-22
	22,25	168	289	191	MK2 B	-22.25
	22,5	174	296	198	MK2 B	-22.5
	22,75	174	296	198	MK2 B	-22.75
	23	174	296	198	MK2 B	-23
	23,5	174	319	198	MK3 B	-23.5
	24	181	327	206	MK3 B	-24
	24,5	181	327	206	MK3 B	-24.5
	25	181	327	206	MK3 B	-25
	25,5	187	335	214	MK3 B	-25.5
	26	187	335	214	MK3 B	-26
	26,5	187	335	214	MK3 B	-26.5
	27	194	343	222	MK3 B	-27
	27,5	194	343	222	MK3 B	-27.5
	28	194	343	222	MK3 B	-28
	28,5	200	351	230	MK3 B	-28.5
	29	200	351	230	MK3 B	-29
	29,5	200	351	230	MK3 B	-29.5
	30	200	351	230	MK3 B	-30
	30,5	207	360	239	MK3 B	-30.5
	31	207	360	239	MK3 B	-31

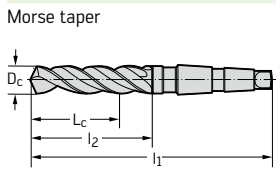

Continued

Long twist drill with taper shank A4411



~ 12 x D_c

Continued

	P	M	K	N	S	H	O
uncoated	●●	●	●●	●●	●		●●

DIN 341	D _c h8 mm	L _c mm	l ₁ mm	l ₂ mm	MK	Designation A4411
Morse taper	31,5	207	360	239	MK3 B	-31.5
	32	214	397	248	MK4 B	-32
	32,5	214	397	248	MK4 B	-32.5
	33	214	397	248	MK4 B	-33
	34	221	406	257	MK4 B	-34
	34,5	221	406	257	MK4 B	-34.5
	35	221	406	257	MK4 B	-35
	36	229	416	267	MK4 B	-36
	37	229	416	267	MK4 B	-37
	37,5	229	416	267	MK4 B	-37.5
	38	237	426	277	MK4 B	-38
	38,5	237	426	277	MK4 B	-38.5
	39	237	426	277	MK4 B	-39
	40	237	426	277	MK4 B	-40
	41	244	436	287	MK4 B	-41
	42	244	436	287	MK4 B	-42
	43	253	447	298	MK4 B	-43
	44	253	447	298	MK4 B	-44
	45	253	447	298	MK4 B	-45
	46	262	459	310	MK4 B	-46
	47	262	459	310	MK4 B	-47
	48	271	470	321	MK4 B	-48
	50	271	470	321	MK4 B	-50

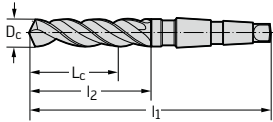

Long twist drill with taper shank A4422 UFL®



~ 12 x D_c

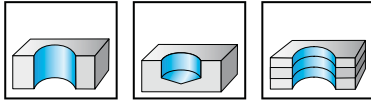

- HSS - fibre-steamed
- Type UFL®
- right-hand cutting
- 130° point angle
- from 23.02 mm bright finish

	P	M	K	N	S	H	O
uncoated	●●	●	●●	●●	●		●●

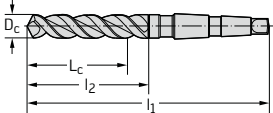
DIN 341	D _c h8 mm	L _c mm	l ₁ mm	l ₂ mm	MK	Designation A4422
Morse taper 	10	100	197	116	MK1 B	-10
	10,2	100	197	116	MK1 B	-10.2
	10,5	100	197	116	MK1 B	-10.5
	10,8	107	206	125	MK1 B	-10.8
	11	107	206	125	MK1 B	-11
	11,2	107	206	125	MK1 B	-11.2
	11,5	107	206	125	MK1 B	-11.5
	11,8	107	206	125	MK1 B	-11.8
	12	120	215	134	MK1 B	-12
	12,2	120	215	134	MK1 B	-12.2
	12,5	120	215	134	MK1 B	-12.5
	12,8	120	215	134	MK1 B	-12.8
	13	120	215	134	MK1 B	-13
	13,2	120	215	134	MK1 B	-13.2
	13,5	128	223	142	MK1 B	-13.5
	13,8	128	223	142	MK1 B	-13.8
	14	128	223	142	MK1 B	-14
	14,25	132	245	147	MK2 B	-14.25
	14,5	132	245	147	MK2 B	-14.5
	14,75	132	245	147	MK2 B	-14.75
	15	132	245	147	MK2 B	-15
	15,25	137	251	153	MK2 B	-15.25
	15,5	137	251	153	MK2 B	-15.5
15,75	137	251	153	MK2 B	-15.75	
16	137	251	153	MK2 B	-16	
16,25	142	257	159	MK2 B	-16.25	
16,5	142	257	159	MK2 B	-16.5	
16,75	142	257	159	MK2 B	-16.75	
17	142	257	159	MK2 B	-17	
17,25	147	263	165	MK2 B	-17.25	
17,5	147	263	165	MK2 B	-17.5	
17,75	147	263	165	MK2 B	-17.75	
18	147	263	165	MK2 B	-18	
18,25	152	269	171	MK2 B	-18.25	
18,5	152	269	171	MK2 B	-18.5	
18,75	152	269	171	MK2 B	-18.75	
19	152	269	171	MK2 B	-19	
19,25	157	275	177	MK2 B	-19.25	
19,5	157	275	177	MK2 B	-19.5	
19,75	157	275	177	MK2 B	-19.75	
20	157	275	177	MK2 B	-20	
20,5	162	282	184	MK2 B	-20.5	
21	162	282	184	MK2 B	-21	
21,5	168	289	191	MK2 B	-21.5	
22	168	289	191	MK2 B	-22	
22,5	174	296	198	MK2 B	-22.5	
23	174	296	198	MK2 B	-23	

Continued



Long twist drill with taper shank
A4422
UFL®



~ 12 x D_c

Continued

	P	M	K	N	S	H	O
uncoated	●●	●	●●	●●	●		●●

DIN 341	D _c h8 mm	L _c mm	l ₁ mm	l ₂ mm	MK	Designation A4422
Morse taper	23,5	174	319	198	MK3 B	-23.5
	24	181	327	206	MK3 B	-24
	24,5	181	327	206	MK3 B	-24.5
	25	181	327	206	MK3 B	-25
	26	187	335	214	MK3 B	-26
	27	194	343	222	MK3 B	-27
	28	194	343	222	MK3 B	-28
	29	200	351	230	MK3 B	-29
	30	200	351	230	MK3 B	-30
	31	207	360	239	MK3 B	-31

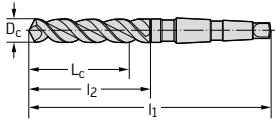

Extra long twist drill with taper shank A4611



~ 16 x D_c

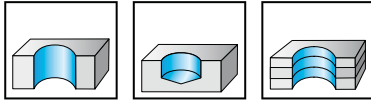

- HSS - steam treated
- Type N
- right-hand cutting
- 118° point angle

	P	M	K	N	S	H	O
uncoated	●	●	●	●●	●●		●●

DIN 1870-I	D _c h8 mm	L _c mm	l ₁ mm	l ₂ mm	MK	Designation A4611
Morse taper	8	152	265	165	MK1 B	-8
	8,5	152	265	165	MK1 B	-8.5
	9	160	275	175	MK1 B	-9
	9,5	160	275	175	MK1 B	-9.5
	10	169	285	185	MK1 B	-10
	10,5	169	285	185	MK1 B	-10.5
	11	177	300	195	MK1 B	-11
	11,5	177	300	195	MK1 B	-11.5
	12	191	310	205	MK1 B	-12
	12,5	191	310	205	MK1 B	-12.5
	13	191	310	205	MK1 B	-13
	13,5	206	325	220	MK1 B	-13.5
	14	206	325	220	MK1 B	-14
	14,5	205	340	220	MK2 B	-14.5
	15	205	340	220	MK2 B	-15
	15,5	214	355	230	MK2 B	-15.5
	16	214	355	230	MK2 B	-16
	16,5	213	355	230	MK2 B	-16.5
	17	213	355	230	MK2 B	-17
	17,5	227	370	245	MK2 B	-17.5
	18	227	370	245	MK2 B	-18
	18,5	226	370	245	MK2 B	-18.5
	19	226	370	245	MK2 B	-19
	19,5	240	385	260	MK2 B	-19.5
	20	240	385	260	MK2 B	-20
	20,5	238	385	260	MK2 B	-20.5
	21	238	385	260	MK2 B	-21
	21,5	247	405	270	MK2 B	-21.5
	22	247	405	270	MK2 B	-22
	22,5	246	405	270	MK2 B	-22.5
	23	246	405	270	MK2 B	-23
	23,5	246	425	270	MK3 B	-23.5
	24	265	440	290	MK3 B	-24
	24,5	265	440	290	MK3 B	-24.5
	25	265	440	290	MK3 B	-25
	25,5	263	440	290	MK3 B	-25.5
	26	263	440	290	MK3 B	-26
	26,5	263	440	290	MK3 B	-26.5
	27	277	460	305	MK3 B	-27
	28	277	460	305	MK3 B	-28
	29	275	460	305	MK3 B	-29
	30	275	460	305	MK3 B	-30
	31	288	480	320	MK3 B	-31
	32	286	505	320	MK4 B	-32
	33	286	505	320	MK4 B	-33
	34	304	530	340	MK4 B	-34
	35	304	530	340	MK4 B	-35

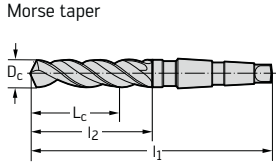

Continued



Extra long twist drill with taper shank A4611



~ 16 x D_c

Continued

	P	M	K	N	S	H	O
uncoated	●	●	●	●●	●●		●●

DIN 1870-I	D _c h8 mm	L _c mm	l ₁ mm	l ₂ mm	MK	Designation A4611
Morse taper	36	302	530	340	MK4 B	-36
	37	302	530	340	MK4 B	-37
	38	320	555	360	MK4 B	-38
	39	320	555	360	MK4 B	-39
	40	320	555	360	MK4 B	-40
	41	317	555	360	MK4 B	-41
	42	317	555	360	MK4 B	-42
	45	340	585	385	MK4 B	-45
	48	355	605	405	MK4 B	-48
	50	355	605	405	MK4 B	-50

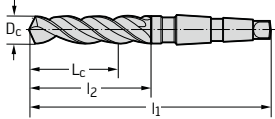

Extra long twist drill with taper shank A4622 UFL®



~ 16 x D_c

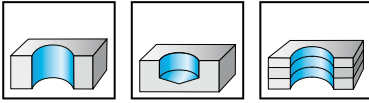

- HSS - fibre-steamed
- Type UFL®
- right-hand cutting
- 130° point angle
- from 23.02 mm bright finish

	P	M	K	N	S	H	O
uncoated	●●	●	●●	●●	●		●●

DIN 1870-I	D _c h8 mm	L _c mm	l ₁ mm	l ₂ mm	MK	Designation A4622
<p>Morse taper</p>	12	191	310	205	MK1 B	-12
	12,5	191	310	205	MK1 B	-12.5
	13	191	310	205	MK1 B	-13
	13,5	206	325	220	MK1 B	-13.5
	14	206	325	220	MK1 B	-14
	14,5	205	340	220	MK2 B	-14.5
	15	205	340	220	MK2 B	-15
	15,5	214	355	230	MK2 B	-15.5
	16	214	355	230	MK2 B	-16
	16,5	213	355	230	MK2 B	-16.5
	17	213	355	230	MK2 B	-17
	17,5	227	370	245	MK2 B	-17.5
	18	227	370	245	MK2 B	-18
	18,5	226	370	245	MK2 B	-18.5
	19	226	370	245	MK2 B	-19
	19,5	240	385	260	MK2 B	-19.5
	20	240	385	260	MK2 B	-20
	21	238	385	260	MK2 B	-21
	22	247	405	270	MK2 B	-22
	23	246	405	270	MK2 B	-23
	24	265	440	290	MK3 B	-24
	25	265	440	290	MK3 B	-25
	26	263	440	290	MK3 B	-26
	27	277	460	305	MK3 B	-27
	28	277	460	305	MK3 B	-28
	29	275	460	305	MK3 B	-29
	30	275	460	305	MK3 B	-30

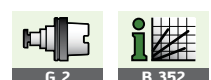

Extra long twist drill with taper shank

A4722

UFL®



~ 22 x D_c

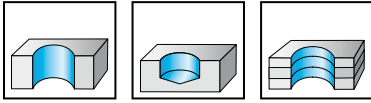

- HSS - fibre-steamed
- Type UFL®
- right-hand cutting
- 130° point angle
- from 23.02 mm bright finish

	P	M	K	N	S	H	O
uncoated	●●	●	●●	●●	●		●●

DIN 1870-II	D _c h8 mm	L _c mm	l ₁ mm	l ₂ mm	MK	Designation A4722
Morse taper	8	197	330	210	MK1 B	-8
	8,5	197	330	210	MK1 B	-8.5
	9	205	345	220	MK1 B	-9
	10	219	360	235	MK1 B	-10
	10,5	219	360	235	MK1 B	-10.5
	11	232	375	250	MK1 B	-11
	11,5	232	375	250	MK1 B	-11.5
	12	246	395	260	MK1 B	-12
	12,5	246	395	260	MK1 B	-12.5
	13	246	395	260	MK1 B	-13
	13,5	261	410	275	MK1 B	-13.5
	14	261	410	275	MK1 B	-14
	14,5	260	425	275	MK2 B	-14.5
	15	260	425	275	MK2 B	-15
	15,5	279	445	295	MK2 B	-15.5
	16	279	445	295	MK2 B	-16
	16,5	278	445	295	MK2 B	-16.5
	17	278	445	295	MK2 B	-17
	17,5	292	465	310	MK2 B	-17.5
	18	292	465	310	MK2 B	-18
	18,5	291	465	310	MK2 B	-18.5
	19	291	465	310	MK2 B	-19
	19,5	305	490	325	MK2 B	-19.5
	20	305	490	325	MK2 B	-20
	21	303	490	325	MK2 B	-21
	22	322	515	345	MK2 B	-22
	23	321	515	345	MK2 B	-23
	24	340	555	365	MK3 B	-24
	25	340	555	365	MK3 B	-25
	26	338	555	365	MK3 B	-26
	27	357	580	385	MK3 B	-27
	28	357	580	385	MK3 B	-28
	29	355	580	385	MK3 B	-29
	30	355	580	385	MK3 B	-30
	31	378	610	410	MK3 B	-31
	32	376	635	410	MK4 B	-32
	33	376	635	410	MK4 B	-33
	34	394	665	430	MK4 B	-34
	35	394	665	430	MK4 B	-35
	38	420	695	460	MK4 B	-38
	40	420	695	460	MK4 B	-40

Morse taper

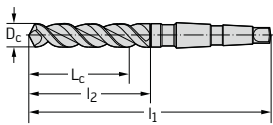

HSS-E coolant through drill A6292TIN MegaJet



5 x D_c

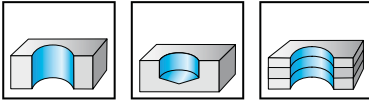

- HSS-E - TiN
- Type MegaJet
- right-hand cutting
- 130° point angle
- from 20.5 mm 118° point angle

	P	M	K	N	S	H	O
TiN	●	●	●	●	●		

	D _c h8 mm	D _c Inches/No	d ₁ h6 mm	L _c mm	l ₁ mm	l ₂ mm	l ₅ mm	Designation A6292TIN
Shank DIN 1835 E 	5		6	35	82	44	36	-5
	5,1		6	35	82	44	36	-5.1
	5,2		6	35	82	44	36	-5.2
	5,3		6	35	82	44	36	-5.3
	5,4		6	35	82	44	36	-5.4
	5,5		6	35	82	44	36	-5.5
	5,556	7/32"	6	35	82	44	36	-7/32IN
	5,6		6	35	82	44	36	-5.6
	5,7		6	35	82	44	36	-5.7
	5,8		6	35	82	44	36	-5.8
	5,9		6	35	82	44	36	-5.9
	6		6	35	82	44	36	-6
	6,1		8	41	91	53	36	-6.1
	6,2		8	41	91	53	36	-6.2
	6,3		8	41	91	53	36	-6.3
	6,35	1/4"	8	41	91	53	36	-1/4IN
	6,4		8	41	91	53	36	-6.4
	6,5		8	41	91	53	36	-6.5
	6,6		8	41	91	53	36	-6.6
	6,7		8	41	91	53	36	-6.7
	6,8		8	41	91	53	36	-6.8
6,9		8	41	91	53	36	-6.9	
7		8	41	91	53	36	-7	
7,1		8	41	91	53	36	-7.1	
7,144	9/32"	8	41	91	53	36	-9/32IN	
7,2		8	41	91	53	36	-7.2	
7,3		8	41	91	53	36	-7.3	
7,4		8	41	91	53	36	-7.4	
7,5		8	41	91	53	36	-7.5	
7,6		8	41	91	53	36	-7.6	
7,7		8	41	91	53	36	-7.7	
7,8		8	41	91	53	36	-7.8	
7,9		8	41	91	53	36	-7.9	
7,938	5/16"	8	41	91	53	36	-5/16IN	
8		8	41	91	53	36	-8	
8,1		10	46	103	61	40	-8.1	
8,2		10	46	103	61	40	-8.2	
8,3		10	46	103	61	40	-8.3	
8,4		10	46	103	61	40	-8.4	
8,5		10	46	103	61	40	-8.5	
8,6		10	46	103	61	40	-8.6	
8,7		10	46	103	61	40	-8.7	
8,731	11/32"	10	46	103	61	40	-11/32IN	
8,8		10	46	103	61	40	-8.8	
8,9		10	46	103	61	40	-8.9	
9		10	46	103	61	40	-9	
9,1		10	46	103	61	40	-9.1	

Continued

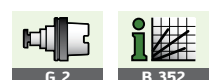

HSS-E coolant through drill

A6292TIN

MegaJet

 5 x D_c

	P	M	K	N	S	H	O
TiN	●●	●●	●●	●●	●●		

Continued

	D _c h8 mm	D _c Inches/No	d ₁ h6 mm	L _c mm	l ₁ mm	l ₂ mm	l ₅ mm	Designation A6292TIN
Shank DIN 1835 E	9,2		10	46	103	61	40	-9.2
	9,3		10	46	103	61	40	-9.3
	9,4		10	46	103	61	40	-9.4
	9,5		10	46	103	61	40	-9.5
	9,525	3/8"	10	46	103	61	40	-3/8IN
	9,6		10	46	103	61	40	-9.6
	9,7		10	46	103	61	40	-9.7
	9,8		10	46	103	61	40	-9.8
	9,9		10	46	103	61	40	-9.9
	10		10	46	103	61	40	-10
	10,2		12	57	122	75	45	-10.2
	10,319	13/32"	12	57	122	75	45	-13/32IN
	10,5		12	57	122	75	45	-10.5
	11		12	57	122	75	45	-11
	11,113	7/16"	12	57	122	75	45	-7/16IN
	11,5		12	57	122	75	45	-11.5
	11,906	15/32"	12	57	122	75	45	-15/32IN
	12		12	57	122	75	45	-12
	12,5		14	73	134	87	45	-12.5
	12,7	1/2"	14	73	134	87	45	-1/2IN
	13		14	73	134	87	45	-13
	13,494	17/32"	14	73	134	87	45	-17/32IN
	13,5		14	73	134	87	45	-13.5
	14		14	73	134	87	45	-14
	14,288	9/16"	16	84	150	100	48	-9/16IN
	14,5		16	84	150	100	48	-14.5
	15		16	84	150	100	48	-15
	15,081	19/32"	16	84	150	100	48	-19/32IN
	15,5		16	84	150	100	48	-15.5
	15,875	5/8"	16	84	150	100	48	-5/8IN
	16		16	84	150	100	48	-16
	16,5		18	94	162	112	48	-16.5
	16,669	21/32"	18	94	162	112	48	-21/32IN
	17		18	94	162	112	48	-17
	17,463	11/16"	18	94	162	112	48	-11/16IN
	17,5		18	94	162	112	48	-17.5
	18		18	94	162	112	48	-18
	18,256	23/32"	20	104	176	124	50	-23/32IN
	18,5		20	104	176	124	50	-18.5
	19		20	104	176	124	50	-19
	19,05	3/4"	20	104	176	124	50	-3/4IN
	19,5		20	104	176	124	50	-19.5
	20		20	104	176	124	50	-20
	20,5		25	120	207	145	56	-20.5
	21		25	120	207	145	56	-21
	21,5		25	120	207	145	56	-21.5
	22		25	120	207	145	56	-22
	22,5		25	120	207	145	56	-22.5
	23		25	120	207	145	56	-23
	23,5		25	120	207	145	56	-23.5
	24		25	120	207	145	56	-24

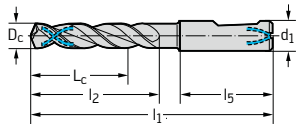

Taper pin drill K2929 1:50

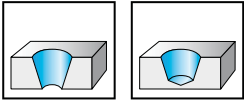

- HSS - steam treated
- right-hand cutting
- for tapered pin drilling in accordance with DIN 1; 258; 7977; 7978
- D_c corresponds to the nominal diameter of the tapered pin

	P	M	K	N	S	H	O
uncoated	●●	●●	●●	●●	●●		●●

DIN 1898 A								
	D_c mm	d_1 mm	d_3 mm	L_c mm	l_1 mm	l_5 mm	l_{15} mm	Designation K2929
Cylindrical shank	1	1,6	0,98	26	50	16	5	-1
	1,5	2	1,48	34	64	20	5	-1.5
	2	3,15	1,98	48	86	29	5	-2
	2,5	3,15	2,48	48	86	29	5	-2.5
	3	4	2,98	58	100	32	5	-3
	4	5	3,98	68	112	34	5	-4
	5	6,3	4,98	73	122	38	5	-5
	6	8	5,97	105	160	42	5	-6
	8	10	7,97	145	207	46	5	-8
	10	12,5	10,96	175	245	50	5	-10
	12	16	11,96	210	290	58	10	-12

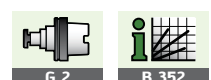
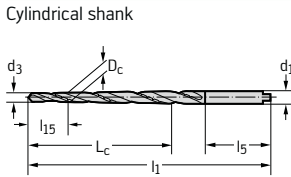

G 2

B 352

Taper pin drill

K4929

1:50

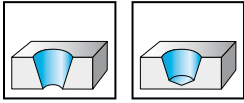

- HSS - steam treated
- right-hand cutting
- for tapered pin drilling in accordance with DIN 1; 258; 7977; 7978
- D_c corresponds to the nominal diameter of the tapered pin

	P	M	K	N	S	H	O
uncoated	●●	●●	●●	●●	●●		●●

DIN 1898 B

Morse taper

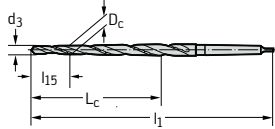

D_c mm	d_3 mm	L_c mm	l_1 mm	l_{15} mm	MK	Designation K4929
5	4,98	73	155	5	MK1 B	-5
6	5,97	105	187	5	MK1 B	-6
8	7,97	145	227	5	MK1 B	-8
10	9,96	175	257	5	MK1 B	-10
12	11,96	210	315	10	MK2 B	-12
14	13,96	220	325	10	MK2 B	-14
16	15,95	230	335	10	MK2 B	-16
20	19,95	250	377	10	MK3 B	-20
25	24,94	300	427	10	MK3 B	-25



Multi-diameter step drill K6221

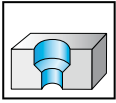

- HSS - steam treated
- Form A
- right-hand cutting
- 118° point angle
- 90° step angle
- Countersink DIN 74, Form A-D_C for through hole machining DIN ISO 273

	P	M	K	N	S	H	O
uncoated	●●	●●	●●	●●	●●		●●

DIN 8374		D _C h9 mm	D _{C1} mm	d ₁ h8 mm	L _C mm	L _{C1} mm	l ₁ mm	l ₂ mm	Designation K6221
Cylindrical shank	M 3	3,2	6	6	9	45	93	57	-6
	M 4	4,3	8	8	11	59	117	75	-8
	M 5	5,3	10	10	13	72	133	87	-10
	M 6	6,4	11,5	11,5	15	77	142	94	-11.5
	M 8	8,4	15	15	19	92	169	114	-15

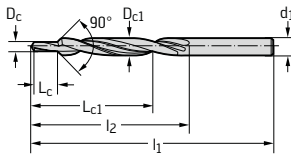

Multi-diameter step drill K6222

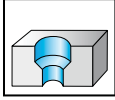

- HSS - steam treated
- right-hand cutting
- 118° point angle
- 90° step angle
- for tap drill holes in acc. with DIN 336, part 1
- D_c for through holes DIN ISO 273

	P	M	K	N	S	H	O
uncoated	●●	●●	●●	●●	●●		●●

DIN 8378

Cylindrical shank

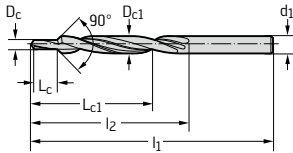

Size	D_c h9 mm	D_{c1} mm	d_1 h8 mm	L_c mm	L_{c1} mm	l_1 mm	l_2 mm	Designation K6222
M 3	2,5	3,4	3,4	8,8	32	70	39	-3.4
M 4	3,3	4,5	4,5	11,4	38	80	47	-4.5
M 5	4,2	5,5	5,5	13,6	46	93	57	-5.5
M 6	5	6,6	6,6	16,5	50	101	63	-6.6
M 8	6,8	9	9	21	68	125	81	-9
M 10	8,5	11	11	25,5	78	142	94	-11
M 12	10,2	13,5	13,5	30	88	160	108	-13.5

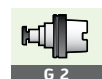

G 2



B 352

Multi-diameter step drill K6223

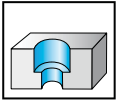

- HSS - steam treated
- Form H
- right-hand cutting
- 118° point angle
- 180° step angle
- Countersink DIN 74, p. 2, form H-D_c for through holes DIN ISO 273

	P	M	K	N	S	H	O
uncoated	●●	●●	●●	●●	●●		●●

DIN 8376		D _c h9 mm	D _{c1} mm	d ₁ h8 mm	L _c mm	L _{c1} mm	l ₁ mm	l ₂ mm	Designation K6223	
Cylindrical shank		M 4	4,5	8	8	11	59	117	75	-8
		M 5	5,5	10	10	13	72	133	87	-10
		M 6	6,6	11	11	15	78	142	94	-11
		M 8	9	15	15	19	92	169	114	-15
		M 10	11	18	18	23	103	191	130	-18

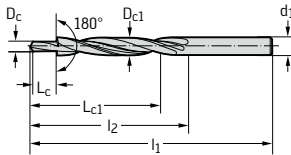

Walter Select for HSS core drilling, countersinking and centre drills

Step by step to the correct tool

STEP 1



Define the **material** to be machined from page H 8.

Make a note of the **machining group** corresponding to your material, e.g.: K5.

Code letter	Machining group	Groups of the materials to be machined	
P	P1–P15	Steel	All types of steel and cast steel, with the exception of steel with an austenitic structure
M	M1–M3	Stainless steel	Stainless austenitic steel and austenitic-ferritic steel and cast steel
K	K1–K7	Cast iron	Grey cast iron, cast iron with spheroidal graphite, malleable cast iron, cast iron with vermicular graphite
N	N1–N10	NF metals	Aluminium and other non-ferrous metals, non-ferrous materials
S	S1–S10	High temperature alloys and titanium alloys	Heat resisting special alloys based on iron, nickel and cobalt, titanium and titanium alloys
H	H1–H4	Hard materials	Hardened steel, hardened cast iron materials, chilled hard cast iron
O	O1–O6	Other	Plastics, glass and carbon fibre Reinforced plastics, graphite

STEP 2

Select the **machining conditions**:

Machine stability, clamping system and workpiece		
very good	good	moderate
		

STEP 3

Select your tool from the table from page B 278:

- in acc. with **DIN** and **form** (e.g. DIN 345, form C)
- in accordance with the **machining conditions** (see step 2: 😊 😐 😞)
- for the relevant **machining group** (see step 1: P1–P15; M1–M3; ... O1–O6)

		Dimensions		DIN 344	DIN 343
		Machining conditions		☞	☞
		Designation		E1111	E3111
		Form		-	-
		Type		N	N
		Dia. range (mm)		4.80 – 16.00	7.80 – 49.60
		Cutting tool material		HSS	HSS
		Coating		uncoated	uncoated
		Page		B 284	B 285

Material group	Grouping of main material groups and identification letters		Brinell hardness HB	Tensile strength R _m N/mm ²	Machining group		
	Workpiece material						
P	Non-alloyed and low alloy steel	annealed (hardened and tempered)	210	700	P1, P2, P3, P4, P7	☞	☞
		machining steels	220	750	P6	☞	☞
		tempered	300	1010	P5, P8	☞	☞
	High-alloyed steel and high-alloyed tool steel	tempered	380	1280	P9	☞	☞
		tempered	430	1480	P10	☞	☞
		annealed	200	670	P11	☞	☞
Stainless steel	hardened and tempered	300	1010	P12	☞	☞	
	hardened and tempered	400	1360	P13	☞	☞	
	ferritic/martensitic, annealed	200	670	P14	☞	☞	
M	Stainless steel	martensitic, tempered	330	1110	P15	☞	☞
		austenitic, duplex	230	780		☞	☞
		austenitic, precipitation hardened (PH)				☞	☞

STEP 4

Choose your **cutting data** from the table from page B 372 onwards:

- **Cutting speed:** v_c
- **Feed:** VRR (feed rating chart)

Go to the row of your machining group (e.g. K5) and the column of your selected tool. You will find the cutting speed v_c and the VRR there.

The feed rating chart (VRR) can be found from page B 384 onwards.

= cutting data for wet machining

= dry machining is possible, cutting data must be selected from TEC

E = emulsion
O = oil
M = MQL
L = dry

v_c = cutting speed
VRR = v_c rating chart from page B 382
VRR = feed rating chart from page B 384

		Dimensions		DIN 344	DIN 343
		Designation		E1111	E3111
		Form			
		Type		N	N
		Dia. range (mm)		4.80 – 16.00	7.80 – 49.60
		Cutting tool material		HSS	HSS
		Coating		uncoated	uncoated
		Page		B 284	B 285

Material group	Grouping of main material groups and identification letters		Brinell hardness HB	Tensile strength R _m N/mm ²	Machining group								
	Workpiece material												
P	Non-alloyed steel	C ≤ 0.25 %	annealed	125	428	P1	28	7	E O	28	7	E O	
		C > 0.25, ≤ 0.55 %	annealed	190	639	P2	26	8	E O	26	8	E O	
		C > 0.25, ≤ 0.55 %	tempered	210	708	P3	26	8	E O	26	8	E O	
		C > 0.55 %	annealed	190	639	P4	28	8	E O	28	8	E O	
		C > 0.55 %	tempered	300	1013	P5	17	7	E O	17	7	E O	
		machining steel (short-chipping)	annealed	220	745	P6	28	7	E O	28	7	E O	
	Low alloy steel	annealed		175	561	P7	28	8	E O	28	8	E O	
				300	1013	P8	17	7	E O	17	7	E O	
			tempered	380	1282	P9	6	5	O E	6	5	O E	
		tempered		430	1477	P10							
				200	675	P11	7	3	E O	7	3	E O	
			hardened and tempered	300	1013	P12	9	5	E O	9	5	E O	
High-alloyed steel and high-alloyed tool steel	hardened and tempered		400	1361	P13	3	4	O E	3	4	O E		
			200	675	P14	7	3	E O	7	3	E O		
			330	1114	P15	6	3	E O	6	3	E O		
Stainless steel	martensitic, tempered		200	675	M1	4	3	O E	4	3	O E		
			300	1013	M2	5	5	O E	5	5	O E		
			230	778	M3	3	3	O E	3	3	O E		
M	Stainless steel	austenitic, quench hardened	200	675	M1	4	3	O E	4	3	O E		
		austenitic, precipitation hardened (PH)	300	1013	M2	5	5	O E	5	5	O E		
		austenitic/ferritic, duplex	230	778	M3	3	3	O E	3	3	O E		
	Malleable cast iron												

Walter Select – Counterboring and countersinking HSS core drilling and countersink drills

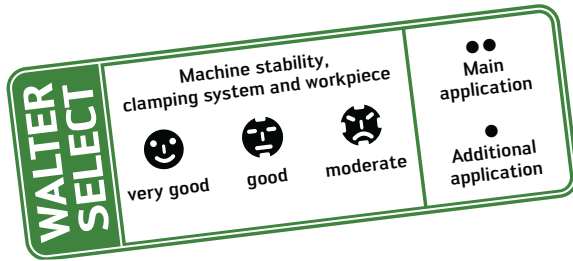

Dimensions	DIN 344	DIN 343	
Machining conditions			
Designation	E1111	E3111	
Form	-	-	
Type	N	N	
Dia. range (mm)	4,80 – 16,00	7,80 – 49,60	
Cutting tool material	HSS	HSS	
Coating	uncoated	uncoated	
Page	B 284	B 285	

Material group	Grouping of main material groups and identification letters		Brinell hardness HB	Tensile strength R_m N/mm ²	Machining group			
	Workpiece material							
P	Non-alloyed and low alloy steel	annealed (hardened and tempered)	210	700	P1, P2, P3, P4, P7	●●	●●	
		machining steels	220	750	P6	●●	●●	
		tempered	300	1010	P5, P8	●	●	
		tempered	380	1280	P9	●	●	
		tempered	430	1480	P10	●	●	
	High-alloyed steel and high-alloyed tool steel	annealed	200	670	P11	●●	●●	
hardened and tempered		300	1010	P12	●	●		
hardened and tempered		400	1360	P13	●	●		
Stainless steel	ferritic/martensitic, annealed	200	670	P14	●●	●●		
	martensitic, tempered	330	1110	P15	●	●		
M	Stainless steel	austenitic, duplex	230	780	M1, M3	●●	●●	
		austenitic, precipitation hardened (PH)	300	1010	M2	●	●	
K	Grey cast iron		245	-	K3, K4	●●	●●	
	Cast iron with spheroidal graphite	ferritic, pearlitic	365	-	K1, K2, K5, K6	●●	●●	
	GGV (CGI)		200	-	K7	●●	●●	
N	Aluminium wrought alloys	cannot be hardened	30	-	N1	●●	●●	
		hardenable, hardened	100	340	N2	●●	●●	
	Cast aluminium alloys	≤ 12 % Si	90	310	N3, N4	●●	●●	
		> 12 % Si	130	450	N5	●	●	
	Magnesium alloys		70	250	N6	●●	●●	
	Copper and copper alloys (bronze/brass)	non-alloyed, electrolytic copper	100	340	N7	●●	●●	
brass, bronze, red brass		90	310	N8	●●	●●		
Cu-alloys, short-chipping		110	380	N9	●●	●●		
high-strength, Ampco		300	1010	N10	●	●		
S	Heat-resistant alloys	Fe-based	280	940	S1, S2	●●	●●	
		Ni or Co base	250	840	S3	●●	●●	
		Ni or Co base	350	1080	S4, S5	●	●	
	Titanium alloys	pure titanium	200	670	S6	●●	●●	
		α and β alloys, hardened	375	1260	S7	●	●	
		β alloys	410	1400	S8	●	●	
	Tungsten alloys		300	1010	S9	●	●	
Molybdenum alloys		300	1010	S10	●	●		
H	Hardened steel		50 HRC	-	H1			
			55 HRC	-	H2, H4			
			60 HRC	-	H3			
O	Thermoplasts	without abrasive fillers			O1	●●	●●	
	Thermosetting plastics	without abrasive fillers			O2	●●	●●	
	Fibre-reinforced plastic	GFRP, AFRP				O3, O5		
		CFRP				O4		
	Graphite (technical)			65		O6		

Walter Select – Centring

Solid carbide and HSS centre drills

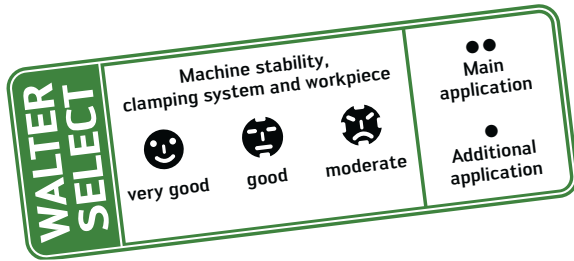

Dimensions	DIN 333	
Machining conditions	☺	
Designation	K1161	
Form	A	
Type	Solid carbide	
Dia. range (mm)	0,50 – 6,30	
Cutting tool material	K10/20	
Coating	uncoated	
Page	B 298	

Material group	Grouping of main material groups and identification letters		Brinell hardness HB	Tensile strength R _m N/mm ²	Machining group		
	Workpiece material						
P	Non-alloyed and low alloy steel	annealed (hardened and tempered)	210	700	P1, P2, P3, P4, P7	●	
		machining steels	220	750	P6	●	
		tempered	300	1010	P5, P8	●●	
		tempered	380	1280	P9	●●	
		tempered	430	1480	P10	●●	
	High-alloyed steel and high-alloyed tool steel	annealed	200	670	P11	●	
		hardened and tempered	300	1010	P12	●●	
hardened and tempered		400	1360	P13	●●		
Stainless steel	ferritic/martensitic, annealed	200	670	P14	●		
	martensitic, tempered	330	1110	P15	●●		
M	Stainless steel	austenitic, duplex	230	780	M1, M3	●●	
		austenitic, precipitation hardened (PH)	300	1010	M2	●●	
K	Grey cast iron		245	–	K3, K4	●●	
	Cast iron with spheroidal graphite	ferritic, pearlitic	365	–	K1, K2, K5, K6	●●	
	GGV (CGI)		200	–	K7	●●	
N	Aluminium wrought alloys	cannot be hardened	30	–	N1	●●	
		hardenable, hardened	100	340	N2	●●	
	Cast aluminium alloys	≤ 12 % Si	90	310	N3, N4	●●	
		> 12 % Si	130	450	N5	●●	
		Magnesium alloys		70	250	N6	●●
Copper and copper alloys (bronze/brass)	non-alloyed, electrolytic copper		100	340	N7	●●	
	brass, bronze, red brass		90	310	N8	●●	
	Cu-alloys, short-chipping		110	380	N9	●●	
	high-strength, Ampco		300	1010	N10	●●	
S	Heat-resistant alloys	Fe-based	280	940	S1, S2	●●	
		Ni or Co base	250	840	S3	●●	
		Ni or Co base	350	1080	S4, S5	●●	
	Titanium alloys	pure titanium	200	670	S6	●●	
		α and β alloys, hardened	375	1260	S7	●●	
		β alloys	410	1400	S8	●●	
	Tungsten alloys		300	1010	S9	●●	
Molybdenum alloys		300	1010	S10	●●		
H	Hardened steel		50 HRC	–	H1	●	
			55 HRC	–	H2, H4		
			60 HRC	–	H3		
O	Thermoplasts	without abrasive fillers			O1	●●	
	Thermosetting plastics	without abrasive fillers			O2	●●	
	Fibre-reinforced plastic	GFRP, AFRP				O3, O5	●●
		CFRP				O4	●●
	Graphite (technical)			65		O6	●●

Walter Select – Centring

Solid carbide and HSS centre drills

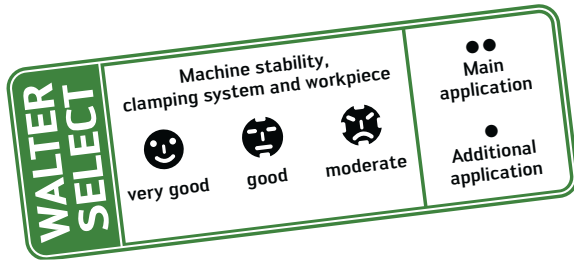

Dimensions	Walter standard
Machining conditions	☼
Designation	K1313
Form	R
Type	-
Dia. range (mm)	1,00 – 4,00
Cutting tool material	HSS
Coating	uncoated
Page	B 301

Material group	Grouping of main material groups and identification letters		Brinell hardness HB	Tensile strength R _m N/mm ²	Machining group		
	Workpiece material						
P	Non-alloyed and low alloy steel	annealed (hardened and tempered)	210	700	P1, P2, P3, P4, P7	●●	
		machining steels	220	750	P6	●●	
		tempered	300	1010	P5, P8	●	
		tempered	380	1280	P9	●	
		tempered	430	1480	P10	●	
	High-alloyed steel and high-alloyed tool steel	annealed	200	670	P11	●●	
		hardened and tempered	300	1010	P12	●	
hardened and tempered		400	1360	P13	●		
Stainless steel	ferritic/martensitic, annealed	200	670	P14	●●		
	martensitic, tempered	330	1110	P15	●		
M	Stainless steel	austenitic, duplex	230	780	M1, M3	●●	
		austenitic, precipitation hardened (PH)	300	1010	M2	●	
K	Grey cast iron		245	-	K3, K4	●●	
	Cast iron with spheroidal graphite	ferritic, pearlitic	365	-	K1, K2, K5, K6	●●	
	GGV (CGI)		200	-	K7	●●	
N	Aluminium wrought alloys	cannot be hardened	30	-	N1	●●	
		hardenable, hardened	100	340	N2	●●	
	Cast aluminium alloys	≤ 12 % Si	90	310	N3, N4	●●	
		> 12 % Si	130	450	N5	●	
	Magnesium alloys		70	250	N6	●●	
	Copper and copper alloys (bronze/brass)	non-alloyed, electrolytic copper	100	340	N7	●●	
brass, bronze, red brass		90	310	N8	●●		
Cu-alloys, short-chipping		110	380	N9	●●		
high-strength, Ampco		300	1010	N10	●		
S	Heat-resistant alloys	Fe-based	280	940	S1, S2	●●	
		Ni or Co base	250	840	S3	●●	
		Ni or Co base	350	1080	S4, S5	●	
	Titanium alloys	pure titanium	200	670	S6	●●	
		α and β alloys, hardened	375	1260	S7	●	
		β alloys	410	1400	S8	●	
	Tungsten alloys		300	1010	S9	●	
Molybdenum alloys		300	1010	S10	●		
H	Hardened steel		50 HRC	-	H1		
			55 HRC	-	H2, H4		
			60 HRC	-	H3		
O	Thermoplasts	without abrasive fillers			O1	●●	
	Thermosetting plastics	without abrasive fillers			O2	●●	
	Fibre-reinforced plastic	GFRP, AFRP				O3, O5	
		CFRP				O4	
	Graphite (technical)			65		O6	

	Walter standard				ANSI B 94.11 M-1979	B.S. 328	Step centre drill	
	K1311	K1411S	K1411M	K1411L	K1811	K1911	K2511	K2513
	A	A	A	A	A	A	60°	Radius
	-	-	-	-	-	-	-	-
	0,63 - 6,00	0,75 - 5,00	0,75 - 4,00	2,00 - 4,00	0,64 - 7,97	1,19 - 7,94	3,30 - 21,00	3,30 - 21,00
	HSS	HSS	HSS	HSS	HSS	HSS	HSS	HSS
	uncoated	uncoated	uncoated	uncoated	uncoated	uncoated	uncoated	uncoated
	B 300	B 304	B 303	B 302	B305	B 306	B 307	B 308
	••	••	••	••	••	••	••	••
	••	••	••	••	••	••	••	••
	•	•	•	•	•	•	•	•
	•	•	•	•	•	•	•	•
	••	••	••	••	••	••	••	••
	•	•	•	•	•	•	•	•
	••	••	••	••	••	••	••	••
	•	•	•	•	•	•	•	•
	••	••	••	••	••	••	••	••
	•	•	•	•	•	•	•	•
	••	••	••	••	••	••	••	••
	•	•	•	•	•	•	•	•
	••	••	••	••	••	••	••	••
	•	•	•	•	•	•	•	•
	••	••	••	••	••	••	••	••
	•	•	•	•	•	•	•	•
	••	••	••	••	••	••	••	••
	•	•	•	•	•	•	•	•
	••	••	••	••	••	••	••	••
	•	•	•	•	•	•	•	•
	••	••	••	••	••	••	••	••
	•	•	•	•	•	•	•	•
	••	••	••	••	••	••	••	••
	•	•	•	•	•	•	•	•
	••	••	••	••	••	••	••	••
	•	•	•	•	•	•	•	•
	••	••	••	••	••	••	••	••
	•	•	•	•	•	•	•	•
	••	••	••	••	••	••	••	••
	•	•	•	•	•	•	•	•
	••	••	••	••	••	••	••	••
	•	•	•	•	•	•	•	•
	••	••	••	••	••	••	••	••
	•	•	•	•	•	•	•	•
	••	••	••	••	••	••	••	••
	•	•	•	•	•	•	•	•
	••	••	••	••	••	••	••	••
	•	•	•	•	•	•	•	•
	••	••	••	••	••	••	••	••
	•	•	•	•	•	•	•	•
	••	••	••	••	••	••	••	••
	•	•	•	•	•	•	•	•
	••	••	••	••	••	••	••	••
	•	•	•	•	•	•	•	•
	••	••	••	••	••	••	••	••
	•	•	•	•	•	•	•	•

Core drills E1111

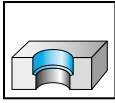

- HSS - uncoated
- Type N
- right-hand cutting

	P	M	K	N	S	H	O
uncoated	●	●	●	●	●		●

DIN 344	D _c h8 mm	d ₁ mm	L _c mm	l ₁ mm	l ₂ mm	D ₃ mm	Designation E1111
Cylindrical shank	4,8	4,8	67	108	74	3,5	-4.8
	5	5	67	108	74	3,5	-5
	5,8	5,8	71	116	80	4,2	-5.8
	6	6	71	116	80	4,2	-6
	6,8	6,8	83	133	93	4,9	-6.8
	7	7	83	133	93	4,9	-7
	7,8	7,8	88	142	100	5,6	-7.8
	8	8	88	142	100	5,6	-8
	8,8	8,8	98	151	107	6,3	-8.8
	9	9	98	151	107	6,3	-9
	9,8	9,8	106	162	116	7	-9.8
	10	10	106	162	116	7	-10
	10,75	10,75	114	173	125	7,7	-10.75
	11	11	114	173	125	7,7	-11
	11,75	11,75	122	184	134	8,4	-11.75
	12	12	122	184	134	8,4	-12
	12,75	12,75	121	184	134	9,1	-12.75
	13	13	121	184	134	9,1	-13
	13,75	13,75	128	194	142	9,8	-13.75
	14	14	128	194	142	9,8	-14
	14,75	14,75	132	202	147	10,5	-14.75
	15	15	132	202	147	10,5	-15
	15,75	15,75	137	211	153	11,2	-15.75
	16	16	137	211	153	11,2	-16

D₃ minimum pre-drilled diameter

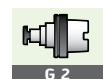

Core drills

E3111

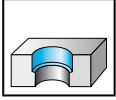

- HSS - uncoated
- Type N
- right-hand cutting

	P	M	K	N	S	H	O
uncoated	●●	●●	●●	●●	●		●●

DIN 343	D _c h8 mm	L _c mm	l ₁ mm	l ₂ mm	MK	D ₃ mm	Designation E3111
Morse taper	7,8	63	156	75	MK1 B	5,6	-7.8
	8	63	156	75	MK1 B	5,6	-8
	8,8	72	162	81	MK1 B	6,3	-8.8
	9	72	162	81	MK1 B	6,3	-9
	9,8	77	168	87	MK1 B	7	-9.8
	10	77	168	87	MK1 B	7	-10
	10,75	83	175	94	MK1 B	7,7	-10.75
	11	83	175	94	MK1 B	7,7	-11
	11,75	89	182	101	MK1 B	8,4	-11.75
	12	89	182	101	MK1 B	8,4	-12
	12,75	88	182	101	MK1 B	9,1	-12.75
	13	88	182	101	MK1 B	9,1	-13
	13,75	94	189	108	MK1 B	9,8	-13.75
	14	94	189	108	MK1 B	9,8	-14
	14,75	99	212	114	MK2 B	10,5	-14.75
	15	99	212	114	MK2 B	10,5	-15
	15,75	104	218	120	MK2 B	11,2	-15.75
	16	104	218	120	MK2 B	11,2	-16
	16,75	108	223	125	MK2 B	11,9	-16.75
	17	108	223	125	MK2 B	11,9	-17
	17,75	112	228	130	MK2 B	12,6	-17.75
	18	112	228	130	MK2 B	12,6	-18
	18,7	116	233	135	MK2 B	13,3	-18.7
	19	116	233	135	MK2 B	13,3	-19
	19,7	120	238	140	MK2 B	14	-19.7
	20	120	238	140	MK2 B	14	-20
	20,7	124	243	145	MK2 B	14,6	-20.7
	21	124	243	145	MK2 B	14,6	-21
	21,7	128	248	150	MK2 B	15,3	-21.7
	22	128	248	150	MK2 B	15,3	-22
	22,7	132	253	155	MK2 B	16	-22.7
	23	132	253	155	MK2 B	16	-23
	23,7	136	281	160	MK3 B	16,6	-23.7
	24	136	281	160	MK3 B	16,6	-24
	24,7	135	281	160	MK3 B	17,3	-24.7
	25	135	281	160	MK3 B	17,3	-25
	25,7	139	286	165	MK3 B	18	-25.7
	26	139	286	165	MK3 B	18	-26
	26,7	143	291	170	MK3 B	18,6	-26.7
	27	143	291	170	MK3 B	18,6	-27
	27,7	142	291	170	MK3 B	19,3	-27.7
	28	142	291	170	MK3 B	19,3	-28
	28,7	146	296	175	MK3 B	20	-28.7
	29	146	296	175	MK3 B	20	-29
	29,7	145	296	175	MK3 B	20,5	-29.7
	30	145	296	175	MK3 B	20,5	-30

D₃ minimum pre-drilled diameter

Continued



G 2

B 352

Core drills E3111



Continued

	P	M	K	N	S	H	O
uncoated	●●	●●	●●	●●	●		●●

DIN 343	D _c h8 mm	L _c mm	l ₁ mm	l ₂ mm	MK	D ₃ mm	Designation E3111
Morse taper	30,6	149	301	180	MK3 B	21	-30.6
	31	149	301	180	MK3 B	21	-31
	31,6	153	306	185	MK4 B	22	-31.6
	32	153	334	185	MK4 B	22	-32
	32,6	152	334	185	MK4 B	23	-32.6
	33	152	334	185	MK4 B	23	-33
	33,6	156	339	190	MK4 B	24	-33.6
	34	156	339	190	MK4 B	24	-34
	34,6	155	339	190	MK4 B	25	-34.6
	35	155	339	190	MK4 B	25	-35
	35,6	159	344	195	MK4 B	25,5	-35.6
	36	159	344	195	MK4 B	25,5	-36
	36,6	158	344	195	MK4 B	26	-36.6
	37	158	344	195	MK4 B	26	-37
	37,6	162	349	200	MK4 B	26,5	-37.6
	38	162	349	200	MK4 B	26,5	-38
	38,6	161	349	200	MK4 B	27	-38.6
	39	161	349	200	MK4 B	27	-39
	39,6	160	349	200	MK4 B	28	-39.6
	40	160	349	200	MK4 B	28	-40
	40,6	164	354	205	MK4 B	28,5	-40.6
	41	164	354	205	MK4 B	28,5	-41
	41,6	163	354	205	MK4 B	29	-41.6
	42	163	354	205	MK4 B	29	-42
	42,6	167	359	210	MK4 B	30	-42.6
	43	167	359	210	MK4 B	30	-43
	43,6	166	359	210	MK4 B	30	-43.6
	44,6	165	359	210	MK4 B	31	-44.6
	49,6	170	369	220	MK4 B	34,5	-49.6

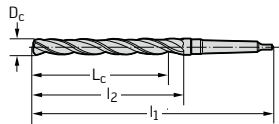
 D₃ minimum pre-drilled diameter

Countersink drill 60° E6818 60°

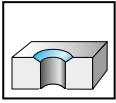

- HSS - uncoated
- Form C
- right-hand cutting
- 60° countersink angle

	P	M	K	N	S	H	O
uncoated	●●	●●	●●	●●	●		●●

DIN 334	D _c mm	d ₁ mm	d ₃ mm	l ₁ mm	Designation E6818
Cylindrical shank	6,3	5	1,6	45	-6.3
	8	6	2	50	-8
	12,5	8	3,2	56	-12.5
	16	10	4	63	-16
	20	10	5	67	-20
	25	10	6,3	71	-25

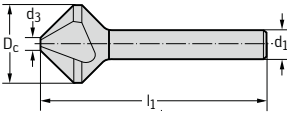

Countersink drill 90°
E6819
90°

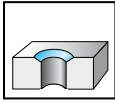

- HSS - uncoated
- Form C
- right-hand cutting
- 90° countersink angle

	P	M	K	N	S	H	O
uncoated	●●	●●	●●	●●	●		●●

DIN 335

Cylindrical shank

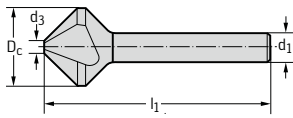

D _c z9 mm	d ₁ mm	d ₃ mm	l ₁ mm	Designation E6819
4,3	4	1,3	40	-4.3
5	4	1,5	40	-5
5,3	4	1,5	40	-5.3
5,8	5	1,5	45	-5.8
6	5	1,5	45	-6
6,3	5	1,5	45	-6.3
7	6	1,8	50	-7
7,3	6	1,8	50	-7.3
8	6	2	50	-8
8,3	6	2	50	-8.3
9,4	6	2,2	50	-9.4
10	6	2,5	50	-10
10,4	6	2,5	50	-10.4
11,5	8	2,8	56	-11.5
12,4	8	2,8	56	-12.4
13,4	8	2,9	56	-13.4
15	10	3,2	60	-15
16,5	10	3,2	60	-16.5
19	10	3,5	63	-19
20,5	10	3,5	63	-20.5
23	10	3,8	67	-23
25	10	3,8	67	-25
30	12	4,2	71	-30
31	12	4,2	71	-31

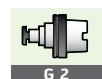

Countersink drill 90° E6819TIN 90°

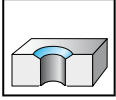

- HSS - TiN
- Form C
- right-hand cutting
- 90° countersink angle
- available as set

	P	M	K	N	S	H	O
TiN	●●	●●	●●	●●	●		●●

DIN 335	D _c z9 mm	d ₁ mm	d ₃ mm	l ₁ mm	Designation E6819TIN
Cylindrical shank	6	5	1,5	45	-6
	6,3	5	1,5	45	-6.3
	7	6	1,8	50	-7
	8	6	2	50	-8
	8,3	6	2	50	-8.3
	10	6	2,5	50	-10
	10,4	6	2,5	50	-10.4
	11,5	8	2,8	56	-11.5
	12,4	8	2,8	56	-12.4
	15	10	3,2	60	-15
	16,5	10	3,2	60	-16.5
	19	10	3,5	63	-19
	20,5	10	3,5	63	-20.5
	23	10	3,8	67	-23
	25	10	3,8	67	-25
	31	12	4,2	71	-31

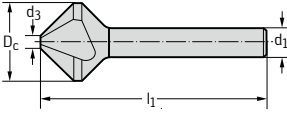

Countersink drill 60°
E7818
60°

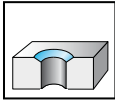

- HSS - uncoated
- Form D
- right-hand cutting
- 60° countersink angle

	P	M	K	N	S	H	O
uncoated	●●	●●	●●	●●	●		●●

DIN 334

Morse taper

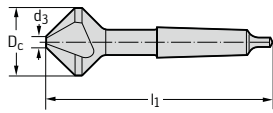

D_c mm	d_3 mm	l_1 mm	MK	Designation E7818
16	4	90	MK1 B	-16
20	5	106	MK2 B	-20
25	6,3	112	MK2 B	-25
31,5	10	118	MK2 B	-31.5
40	12,5	150	MK3 B	-40
50	16	160	MK3 B	-50
63	20	190	MK4 B	-63
80	25	200	MK4 B	-80

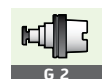

Countersink drill 90° E7819 90°

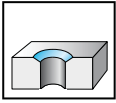

- HSS - uncoated
- Form D
- right-hand cutting
- 90° countersink angle

	P	M	K	N	S	H	O
uncoated	●●	●●	●●	●●	●		●●

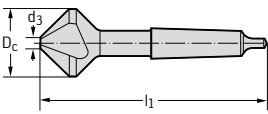
DIN 335	D _c z9 mm	d ₃ mm	l ₁ mm	MK	Designation E7819
Morse taper	15	3,2	85	MK1 B	-15
	16,5	3,2	85	MK1 B	-16.5
	19	3,5	100	MK2 B	-19
	20,5	3,5	100	MK2 B	-20.5
	23	3,8	106	MK2 B	-23
	25	3,8	106	MK2 B	-25
	26	3,8	106	MK2 B	-26
	28	4	112	MK2 B	-28
	30	4,2	112	MK2 B	-30
	31	4,2	112	MK2 B	-31
	34	4,5	118	MK2 B	-34
	37	4,8	118	MK2 B	-37
	40	10	140	MK3 B	-40
	50	14	150	MK3 B	-50
	63	16	180	MK4 B	-63
	80	22	190	MK4 B	-80

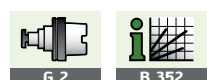

Centre drills K1111 Form A

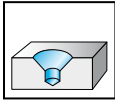

- HSS - uncoated
- Form A
- right-hand cutting
- for centring 60° without protective countersink
- for straight contact surfaces in acc. with DIN 332 A

	P	M	K	N	S	H	O
uncoated	●●	●●	●●	●●	●●		●●

DIN 333	D _c k12 mm	d ₁ h9 mm	l ₁ mm	Designation K1111
Cylindrical shank	0,5	3,15	25	-0.5
	0,8	3,15	25	-0.8
	1	3,15	31,5	-1
	1,25	3,15	31,5	-1.25
	1,6	4	35,5	-1.6
	2	5	40	-2
	2,5	6,3	45	-2.5
	3,15	8	50	-3.15
	4	10	56	-4
	5	12,5	63	-5
	6,3	16	71	-6.3
	8	20	80	-8
	10	25	100	-10
	12,5	31,5	125	-12.5

D_c 0.5 / 0.8 single-sided

Centre drills K1111TIN Form A

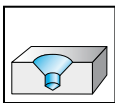

- HSS - TiN
- Form A
- right-hand cutting
- for centring 60° without protective countersink
- for straight contact surfaces in acc. with DIN 332 A

	P	M	K	N	S	H	O
TiN	●●	●●	●●	●●	●●		●●

DIN 333	D _c k12 mm	d ₁ h9 mm	l ₁ mm	Designation K1111TIN
Cylindrical shank	1	3,15	31,5	-1
	1,25	3,15	31,5	-1.25
	1,6	4	35,5	-1.6
	2	5	40	-2
	2,5	6,3	45	-2.5
	3,15	8	50	-3.15
	4	10	56	-4
	5	12,5	63	-5

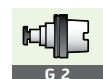

Centre drills K1112 Form A

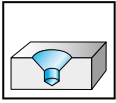

- HSS - uncoated
- Form A
- right-hand cutting
- for centring 60° without protective countersink
- for straight contact surfaces in acc. with DIN 332 A
- with flat on shank

	P	M	K	N	S	H	O
uncoated	●●	●●	●●	●●	●●		●●

DIN 333	D _c k12 mm	d ₁ h9 mm	l ₁ mm	Designation K1112
Cylindrical shank	1,6	4	35,5	-1.6
	2	5	40	-2
	2,5	6,3	45	-2.5
	3,15	8	50	-3.15
	4	10	56	-4
	5	12,5	63	-5

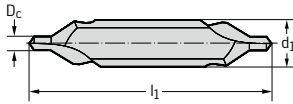

Centre drills K1113 Form R

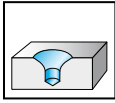

- HSS - uncoated
- Form R
- right-hand cutting
- for centring 60° without protective countersink
- for radial contact surfaces in acc. with DIN 332 R

	P	M	K	N	S	H	O
uncoated	●●	●●	●●	●●	●●		●●

DIN 333	D _c k12 mm	d ₁ h9 mm	l ₁ mm	Designation K1113
Cylindrical shank	0,5	3,15	25	-0.5
	0,8	3,15	25	-0.8
	1	3,15	31,5	-1
	1,25	3,15	31,5	-1.25
	1,6	4	35,5	-1.6
	2	5	40	-2
	2,5	6,3	45	-2.5
	3,15	8	50	-3.15
	4	10	56	-4
	5	12,5	63	-5
	6,3	16	71	-6.3
	8	20	80	-8
	10	25	100	-10
	12,5	31,5	125	-12.5

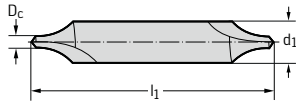

D_c 0.5 / 0.8 single-sided

Centre drills K1113TIN Form R

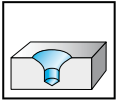

- HSS - TiN
- Form R
- right-hand cutting
- for centring 60° without protective countersink
- for radial contact surfaces in acc. with DIN 332 R

	P	M	K	N	S	H	O
TiN	●●	●●	●●	●●	●●		●●

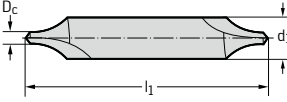
DIN 333	D _c k12 mm	d ₁ h9 mm	l ₁ mm	Designation K1113TIN
Cylindrical shank 	1	3,15	31,5	-1
	1,25	3,15	31,5	-1.25
	1,6	4	35,5	-1.6
	2	5	40	-2
	2,5	6,3	45	-2.5
	3,15	8	50	-3.15
	4	10	56	-4
	5	12,5	63	-5



Centre drills
K1114
Form R

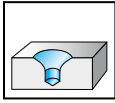

- HSS - uncoated
- Form R
- right-hand cutting
- for centring 60° without protective countersink
- for radial contact surfaces in acc. with DIN 332 R
- with flat on shank

	P	M	K	N	S	H	O
uncoated	●●	●●	●●	●●	●●		●●

DIN 333	D _c k12 mm	d ₁ h9 mm	l ₁ mm	Designation K1114
Cylindrical shank	1,6	4	35,5	-1.6
	2	5	40	-2
	2,5	6,3	45	-2.5
	3,15	8	50	-3.15
	4	10	56	-4
	5	12,5	63	-5

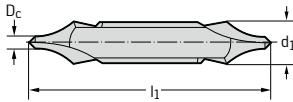

Centre drill, left-hand K1131 Form A

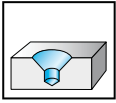

- HSS - uncoated
- Form A
- left-hand cutting
- for centring 60° without protective countersink
- for straight contact surfaces in acc. with DIN 332 A

	P	M	K	N	S	H	O
uncoated	●●	●●	●●	●●	●●		●●

DIN 333	D _c k12 mm	d ₁ h9 mm	l ₁ mm	Designation K1131
Cylindrical shank	0,5	3,15	25	-0,5
	0,8	3,15	25	-0,8
	1	3,15	31,5	-1
	1,25	3,15	31,5	-1,25
	1,6	4	35,5	-1,6
	2	5	40	-2
	2,5	6,3	45	-2,5
	3,15	8	50	-3,15
	4	10	56	-4
	5	12,5	63	-5
	6,3	16	71	-6,3

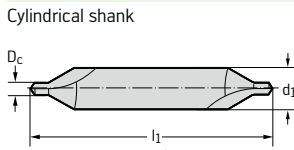

D_c 0.5 / 0.8 single-sided

Solid carbide centre drill

K1161

Form A

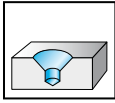

- K10/20 - uncoated
- Form A
- right-hand cutting
- for centring 60° without protective countersink
- for straight contact surfaces in acc. with DIN 332 A

	P	M	K	N	S	H	O
uncoated			●	●●	●●	●	●●

DIN 333	D _c k12 mm	d ₁ h9 mm	l ₁ mm	Designation K1161
Cylindrical shank	0,5	3,15	25	-0.5
	0,8	3,15	25	-0.8
	1	3,15	31,5	-1
	1,25	3,15	31,5	-1.25
	1,6	4	35,5	-1.6
	2	5	40	-2
	2,5	6,3	45	-2.5
	3,15	8	50	-3.15
	4	10	56	-4
	5	12,5	63	-5
	6,3	16	71	-6.3

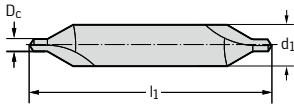

D_c 0.5 / 0.8 single-sided

Centre drills K1215 Form B

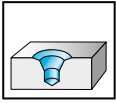

- HSS - uncoated
- Form B
- right-hand cutting
- for centring 60° with protective countersink 120°
- for straight contact surfaces in acc. with DIN 332 B
- with clearance for protective countersink

	P	M	K	N	S	H	O
uncoated	●●	●●	●●	●●	●●		●●

DIN 333	D _c k12 mm	d ₁ h9 mm	l ₁ mm	Designation K1215
Cylindrical shank	1	4	35,5	-1
	1,25	5	40	-1.25
	1,6	6,3	45	-1.6
	2	8	50	-2
	2,5	10	56	-2.5
	3,15	11,2	60	-3.15
	4	14	67	-4
	5	18	75	-5
	6,3	20	80	-6.3
	8	25	100	-8
	10	31,5	125	-10

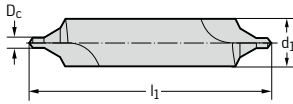

Centre drills K1311 Form A

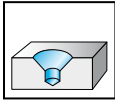

- HSS - uncoated
- Form A
- right-hand cutting
- for centring 60° without protective countersink
- for straight contact surfaces in acc. with DIN 332 A

	P	M	K	N	S	H	O
uncoated	●●	●●	●●	●●	●●		●●

	D _c k12 mm	d ₁ h9 mm	l ₁ mm	Designation K1311
Cylindrical shank	0,63	3,15	20	-0.63
	0,75	3,5	35	-0.75
	1	4	31,5	-1
	1,5	5	40	-1.5
	1,6	5	40	-1.6
	2	6,3	45	-2X6.3
	2	6	45	-2
	2,5	8	50	-2.5
	3	10	56	-3
	3	8	50	-3X8
	3,15	10	56	-3.15
	4	12	66	-4
	5	14	78	-5
	6	18	90	-6

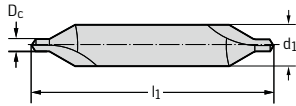

D_c 0.63 single-sided

Centre drills K1313 Form R

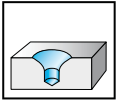

- HSS - uncoated
- Form R
- right-hand cutting
- for centring 60° without protective countersink
- for radial contact surfaces in acc. with DIN 332 R

	P	M	K	N	S	H	O
uncoated	●●	●●	●●	●●	●●		●●

	D _c k12 mm	d ₁ h9 mm	l ₁ mm	Designation K1313
Cylindrical shank	1	4	31,5	-1
	1,5	5	40	-1.5
	2	6	45	-2
	2,5	8	50	-2.5
	3	10	56	-3
	4	12	66	-4

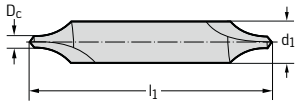

**Extra long centre drill
K1411L
Form A**

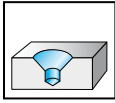

- HSS - uncoated
- Form A
- right-hand cutting
- for centring 60° without protective countersink
- for straight contact surfaces in acc. with DIN 332 A

	P	M	K	N	S	H	O
uncoated	●●	●●	●●	●●	●●		●●

	D_c k12 mm	d_1 h9 mm	l_1 mm	Designation K1411L
Cylindrical shank	2	5	200	-2X5
	2,5	6,3	200	-2.5X6.3
	3,15	8	200	-3.15X8
	4	10	200	-4X10

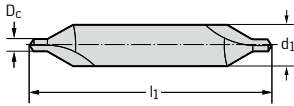

Extra long centre drill K1411M Form A

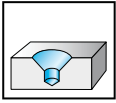

- HSS - uncoated
- Form A
- right-hand cutting
- for centring 60° without protective countersink
- for straight contact surfaces in acc. with DIN 332 A

	P	M	K	N	S	H	O
uncoated	●●	●●	●●	●●	●●		●●

	D _c k12 mm	d ₁ h9 mm	l ₁ mm	Designation K1411M
Cylindrical shank	0,75	3,5	120	-0.75X3.5
	1	4	120	-1X4
	1,5	5	120	-1.5X5
	2	6	120	-2X6
	2,5	8	120	-2.5X8
	3	8	120	-3X8
	3	10	120	-3X10
	4	10	120	-4X10
	4	12	120	-4X12

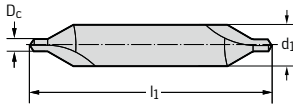

Extra long centre drill K1411S Form A

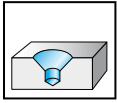

- HSS - uncoated
- Form A
- right-hand cutting
- for centring 60° without protective countersink
- for straight contact surfaces in acc. with DIN 332 A

	P	M	K	N	S	H	O
uncoated	●●	●●	●●	●●	●●		●●

	D _c k12 mm	d ₁ h9 mm	l ₁ mm	Designation K1411S
Cylindrical shank	0,75	3,5	60	-0.75X3.5
	1	4	60	-1X4
	1,5	5	60	-1.5X5
	2	6	80	-2X6
	2,5	8	80	-2.5X8
	3	8	80	-3X8
	3	10	100	-3X10
	4	10	100	-4X10
	4	12	100	-4X12
	5	14	120	-5X14

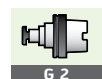

G 2



B 352

Centre drills K1811 Form A

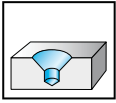

- HSS - uncoated
- Form A
- right-hand cutting
- for centring 60° without protective countersink
- for straight contact surfaces in acc. with DIN 332 A

	P	M	K	N	S	H	O
uncoated	●●	●●	●●	●●	●●		●●

ANSI B 94.11		D _c k12 mm	D _c Inches/No	d ₁ h9 mm	l ₁ mm	Designation K1811
Cylindrical shank	Nr. 00	0,635	No. 72	3,175	31	-NO.00
	Nr. 0	0,794	1/32"	3,175	31	-NO.0
	Nr. 1	1,191	3/64"	3,175	32	-NO1
	Nr. 2	1,984	5/64"	4,763	48	-NO2
	Nr. 3	2,778	7/64"	6,35	48	-NO3
	Nr. 4	3,175	1/8"	7,938	54	-NO4
	Nr. 5	4,763	3/16"	11,113	70	-NO5
	Nr. 6	5,556	7/32"	12,7	76	-NO6
	Nr. 7	6,35	1/4"	15,875	83	-NO7
	Nr. 8	7,938	5/16"	19,05	89	-NO8

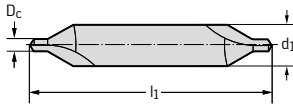

Centre drills K1911 Form A

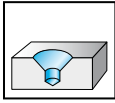

- HSS - uncoated
- Form A
- right-hand cutting
- for centring 60° without protective countersink
- for straight contact surfaces in acc. with DIN 332 A

	P	M	K	N	S	H	O
uncoated	●●	●●	●●	●●	●●		●●

B.S. 328

Cylindrical shank

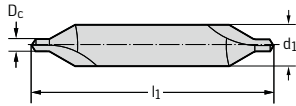

Size	D _c k12 mm	D _c Inches/No	d ₁ h9 mm	l ₁ mm	Designation K1911
B.S. 1	1,191	3/64"	3,175	38	-BS1
B.S. 2	1,588	1/16"	4,763	44,5	-BS2
B.S. 3	2,381	3/32"	6,35	51	-BS3
B.S. 4	3,175	1/8"	7,938	57	-BS4
B.S. 5	4,763	3/16"	11,113	63,5	-BS5
B.S. 6	6,35	1/4"	15,875	76	-BS6
B.S. 7	7,938	5/16"	19,05	89	-BS7

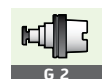

G 2



B 352

Step drill for centring K2511

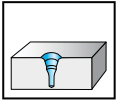

- HSS - uncoated
- Form D
- right-hand cutting
- for centring in acc. with DIN 332 form D
- centring with thread for shaft ends in elec. machines
- with flat on shank

	P	M	K	N	S	H	O
uncoated	●●	●●	●●	●●	●●		●●

	Size	D _c h8 mm	D _{c1} h8 mm	d ₁ h7 mm	L _c mm	L _{c1} mm	l ₁ mm	l ₂ mm	S	Designation K2511
Cylindrical shank 	M 4	3,3	4,3	8	11	12,6	63	23	6,75	-M4
	M 5	4,2	5,3	10	13	15,2	67	27	8,45	-M5
	M 6	5	6,4	12,5	16	18,9	71	33	10,45	-M6
	M 8	6,8	8,4	14	19,5	23	88	41	12,5	-M8
	M 10	8,5	10,5	16	23	27,7	94	47	14,85	-M10
	M 12	10,2	13	20	28	34,5	105	59	18,45	-M12
	M 16	14	17	25	33	41,3	132	67	23,4	-M16
	M 20	17,5	21	31,5	38	48,4	145	77	29,35	-M20
	M 24	21	25	40	45	57	160	90	36,5	-M24

Step drill for centring K2513

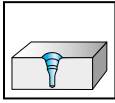

- HSS - uncoated
- Form DR
- right-hand cutting
- for centring in acc. with DIN 332 form radial contact surface
- centring with thread for shaft ends in elec. machines
- with flat on shank and radius

	P	M	K	N	S	H	O
uncoated	●●	●●	●●	●●	●●		●●

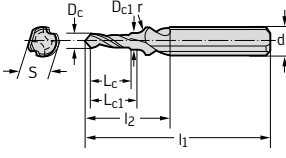
	Size	D _c h8 mm	D _{c1} h8 mm	d ₁ h7 mm	L _c mm	L _{c1} mm	l ₁ mm	l ₂ mm	r	S	Designation K2513
Cylindrical shank 	M 4	3,3	4,3	8	11	12,6	63	23	5	6,75	-M4
	M 5	4,2	5,3	10	13	15,2	67	27	6,3	8,45	-M5
	M 6	5	6,4	12,5	16	18,9	71	33	8	10,45	-M6
	M 8	6,8	8,4	14	19,5	23	88	41	10	12,5	-M8
	M 10	8,5	10,5	16	23	27,7	94	47	16	14,85	-M10
	M 12	10,2	13	20	28	34,5	105	59	20	18,45	-M12
	M 16	14	17	25	33	41,3	132	67	25	23,4	-M16
	M 20	17,5	21	31,5	38	48,4	145	77	31,5	29,35	-M20
M 24	21	25	40	45	57	160	90	40	36,5	-M24	

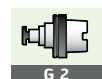

G 2



B 352

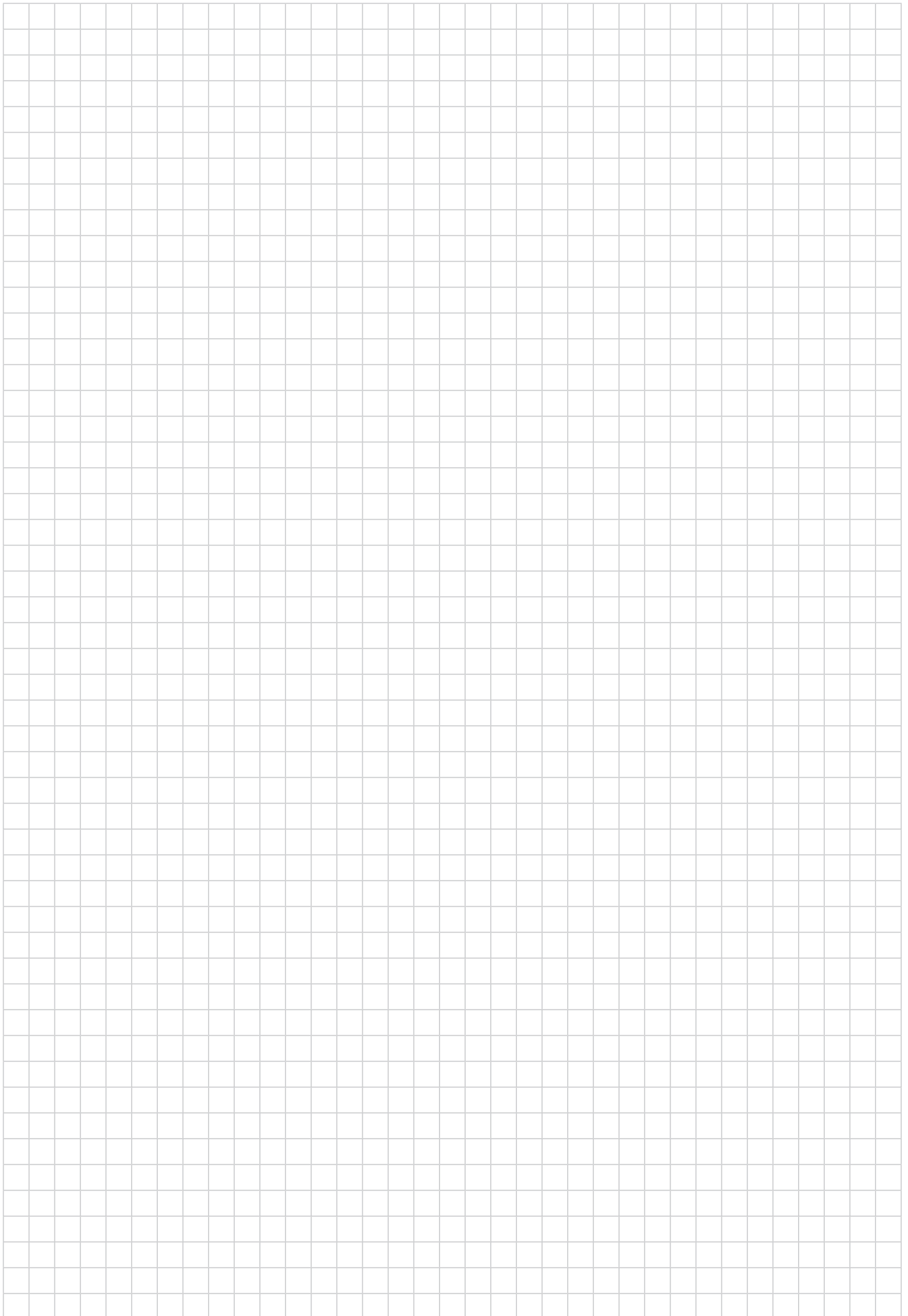

Walter Select for carbide and HSS reamers

Step by step to the correct tool

STEP 1

Define the **material** to be machined from page H 8.

Make a note of the **machining group** corresponding to your material, e.g.: K5.

Code letter	Machining group	Groups of the materials to be machined	
P	P1–P15	Steel	All types of steel and cast steel, with the exception of steel with an austenitic structure
M	M1–M3	Stainless steel	Stainless austenitic steel and austenitic-ferritic steel and cast steel
K	K1–K7	Cast iron	Grey cast iron, cast iron with spheroidal graphite, malleable cast iron, cast iron with vermicular graphite
N	N1–N10	NF metals	Aluminium and other non-ferrous metals, non-ferrous materials
S	S1–S10	High temperature alloys and titanium alloys	Heat resisting special alloys based on iron, nickel and cobalt, titanium and titanium alloys
H	H1–H4	Hard materials	Hardened steel, hardened cast iron materials, chilled hard cast iron
O	O1–O6	Other	Plastics, glass and carbon fibre Reinforced plastics, graphite

STEP 2

Select the **machining conditions**:

Machine stability, clamping system and workpiece		
very good	good	moderate
		

STEP 3

Select your tool from the table from page B 312:

- in acc. with **DIN, form and drill hole type** (e.g. DIN 345, form C, blind hole)
- in accordance with the **machining conditions** (see step 2: 😊 😐 😞)
- for the relevant **machining group** (see step 1: P1–P15; M1–M3; . . . O1–O6)

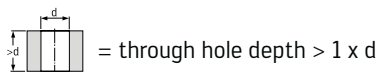
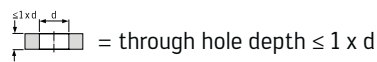
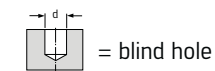

Material group		Grouping of main material groups and identification letters		Dimensions		Walter standard	
				Designation	Form	Machining conditions	
		Workpiece material		Bore/Hardness HB	Tensile strength R _m N/mm ²	Machining group	
P	Non-alloyed and low alloy steel	annealed (hardened and tempered)	210	700	P1, P2, P3, P4, P7	••	••
		machining steels	220	750	P6	••	••
		tempered	300	1010	P5, P8	••	••
		tempered	380	1280	P9	••	••
	High-alloyed steel and high-alloyed tool steel	annealed	430	1480	P10	••	••
		hardened and tempered	200	670	P11	••	••
		hardened and tempered	300	1010	P12	••	••
		hardened and tempered	400	1360	P13	••	••
	Stainless steel	ferritic/martensitic, annealed	200			••	••
		martensitic, tempered				••	••

STEP 4

Choose your **cutting data** from the table from page B 378 onwards:

- **Cutting speed:** v_c
- **Feed:** VRR (feed rating chart)

Go to the row of your machining group (e.g. K5) and the column of your selected reamer. You will find the cutting speed v_c and the VRR there.

The feed rating chart (VRR) can be found from page B 385 onwards.

Material group		Grouping of main material groups and identification letters		Dimensions		DIN 219	DIN 9			
				Designation	Form					
		Workpiece material		Bore/Hardness HB	Tensile strength R _m N/mm ²	Machining group ¹				
P	Non-alloyed steel	C ≤ 0.25 %	annealed	125	428	P1	14	8	E	O
		C > 0.25, ≤ 0.55 %	annealed	190	639	P2	14	8	E	O
		C > 0.25, ≤ 0.55 %	tempered	210	708	P3	13	8	E	O
		C > 0.55 %	annealed	190	639	P4	14	8	E	O
	Low alloy steel	C > 0.55 %	tempered	300	1013	P5				
		machining steel (short-chipping)	annealed	175	591	P7	14	8	E	O
		tempered	300	1013	P8	10	8	E	O	
		tempered	380	1282	P9					
	High-alloyed steel and high-alloyed tool steel	tempered	430	1477	P10					
		annealed	200	675	P11	4	8	E	O	
hardened and tempered		300	1013	P12						
hardened and tempered		400	1361	P13						
Stainless steel	ferritic/martensitic, annealed	200	675	P14	4	8	E	O		
	martensitic, tempered	330	1114	P15						
	austenitic, quench hardened	200	675	M1						
M	Stainless steel	austenitic, precipitation hardened (PH)	300	1013	M2					
			200	675						

Walter Select – Reaming Carbide and HSS reamers

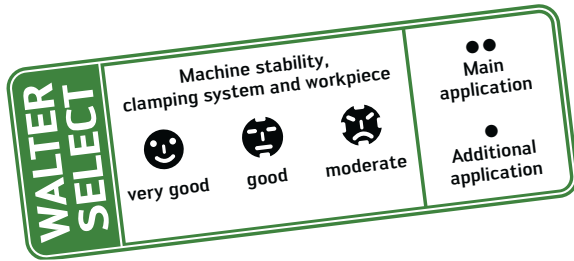

Dimensions	Walter standard	
Machining conditions	☺	☺
Designation	F1362	F1371
Form	A / C	B / D
Type	Straight flute	Left-hand spiral
Dia. range (mm)	2,00 – 20,00	2,00 – 20,00
Cutting tool material	K10	K10
Coating	uncoated	uncoated
Hole type		
Page	B 332	B 333

Material group	Grouping of main material groups and identification letters		Brinell hardness HB	Tensile strength R _m N/mm ²	Machining group		
	Workpiece material						
P	Non-alloyed and low alloy steel	annealed (hardened and tempered)	210	700	P1, P2, P3, P4, P7	●●	●●
		machining steels	220	750	P6	●●	●●
		tempered	300	1010	P5, P8	●●	●●
		tempered	380	1280	P9	●●	●●
	High-alloyed steel and high-alloyed tool steel	tempered	430	1480	P10	●	●
		annealed	200	670	P11	●●	●●
		hardened and tempered	300	1010	P12	●●	●●
Stainless steel	hardened and tempered	400	1360	P13	●●	●●	
	ferritic/martensitic, annealed	200	670	P14	●●	●●	
	martensitic, tempered	330	1110	P15	●●	●●	
M	Stainless steel	austenitic, duplex	230	780	M1, M3	●●	●●
		austenitic, precipitation hardened (PH)	300	1010	M2	●●	●●
K	Grey cast iron		245	–	K3, K4	●●	●●
	Cast iron with spheroidal graphite GGV (CGI)	ferritic, pearlitic	365	–	K1, K2, K5, K6	●●	●●
			200	–	K7	●●	●●
N	Aluminium wrought alloys	cannot be hardened	30	–	N1	●●	●●
		hardenable, hardened	100	340	N2	●●	●●
	Cast aluminium alloys	≤ 12 % Si	90	310	N3, N4	●●	●●
		> 12 % Si	130	450	N5	●●	●●
	Magnesium alloys		70	250	N6	●●	●●
	Copper and copper alloys (bronze/brass)	non-alloyed, electrolytic copper	100	340	N7	●●	●●
		brass, bronze, red brass	90	310	N8	●●	●●
Cu-alloys, short-chipping		110	380	N9	●●	●●	
high-strength, Ampco		300	1010	N10	●●	●●	
S	Heat-resistant alloys	Fe-based	280	940	S1, S2	●●	●●
		Ni or Co base	250	840	S3	●●	●●
		Ni or Co base	350	1080	S4, S5	●	●
	Titanium alloys	pure titanium	200	670	S6	●●	●●
		α and β alloys, hardened	375	1260	S7	●●	●●
		β alloys	410	1400	S8	●	●
	Tungsten alloys		300	1010	S9	●	●
Molybdenum alloys		300	1010	S10	●	●	
H	Hardened steel		50 HRC	–	H1		
			55 HRC	–	H2, H4		
			60 HRC	–	H3		
O	Thermoplasts	without abrasive fillers			O1	●●	●●
	Thermosetting plastics	without abrasive fillers			O2	●●	●●
	Fibre-reinforced plastic	GFRP, AFRP			O3, O5	●	●
		CFRP			O4		
Graphite (technical)			65	O6			

Walter Select – Reaming Carbide and HSS reamers

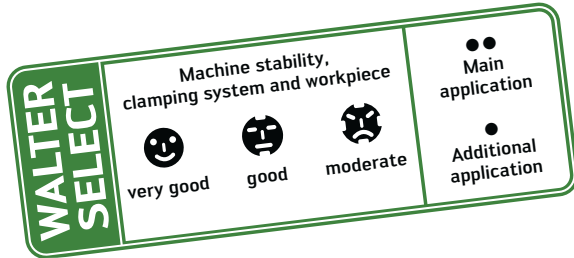

Dimensions	DIN 219	DIN 9	
Machining conditions			
Designation	F7133	F3317	
Form	B	A	
Type	Left-hand spiral	For tapered holes 1:50	
Dia. range (mm)	25,00 – 60,00	1,00 – 30,00	
Cutting tool material	HSS	HSS	
Coating	uncoated	uncoated	
Hole type			
Page	B 345/G 66	B 335	

Material group	Grouping of main material groups and identification letters		Brinell hardness HB	Tensile strength R _m N/mm ²	Machining group			
		Workpiece material						
P	Non-alloyed and low alloy steel	annealed (hardened and tempered)	210	700	P1, P2, P3, P4, P7	●●	●●	
		machining steels	220	750	P6	●●	●●	
		tempered	300	1010	P5, P8	●	●	
		tempered	380	1280	P9			
		tempered	430	1480	P10			
High-alloyed steel and high-alloyed tool steel	annealed	200	670	P11	●	●		
	hardened and tempered	300	1010	P12				
	hardened and tempered	400	1360	P13				
Stainless steel	ferritic/martensitic, annealed	200	670	P14	●	●		
	martensitic, tempered	330	1110	P15				
M	Stainless steel	austenitic, duplex	230	780	M1, M3			
		austenitic, precipitation hardened (PH)	300	1010	M2			
K	Cast iron with spheroidal graphite	GGV (CGI)	245	–	K3, K4	●●	●●	
			365	–	K1, K2, K5, K6	●●	●●	
			200	–	K7	●	●	
N	Aluminium wrought alloys	cannot be hardened	30	–	N1	●●	●●	
		hardenable, hardened	100	340	N2	●●	●●	
	Cast aluminium alloys	≤ 12 % Si	90	310	N3, N4	●●	●●	
		> 12 % Si	130	450	N5			
	Magnesium alloys		70	250	N6	●●	●●	
	Copper and copper alloys (bronze/brass)	non-alloyed, electrolytic copper	100	340	N7	●●	●●	
		brass, bronze, red brass	90	310	N8	●●	●●	
Cu-alloys, short-chipping		110	380	N9	●	●		
	high-strength, Ampco	300	1010	N10				
S	Heat-resistant alloys	Fe-based	280	940	S1, S2			
		Ni or Co base	250	840	S3			
		Ni or Co base	350	1080	S4, S5			
	Titanium alloys	pure titanium	200	670	S6			
		α and β alloys, hardened	375	1260	S7			
		β alloys	410	1400	S8			
Tungsten alloys		300	1010	S9				
Molybdenum alloys		300	1010	S10				
H	Hardened steel		50 HRC	–	H1			
			55 HRC	–	H2, H4			
			60 HRC	–	H3			
O	Thermoplasts	without abrasive fillers			O1	●●	●●	
	Thermosetting plastics	without abrasive fillers			O2	●	●	
	Fibre-reinforced plastic	GFRP, AFRP			O3, O5			
		CFRP			O4			
Graphite (technical)			65	O6				

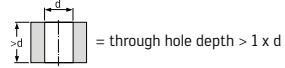
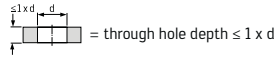
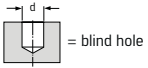

	DIN 2179	DIN 2180	DIN 311	Walter standard	DIN 206		DIN 859	
	F3234	F6134	F4535	F3517	F1111	F1131	F1211	F1231
	-	-	-	-	Hand reamer	Hand reamer	Adjustable hand reamer	Adjustable hand reamer
	For tapered holes 1:50	For tapered holes 1:50	Bridge reamers	For tapered holes 1:10	Straight flute	Left-hand spiral	Straight flute	Left-hand spiral
	1,00 – 12,00	5,00 – 20,00	6,40 – 32,00	5,00 – 23,00	1,00 – 30,00	1,00 – 50,00	4,00 – 30,00	8,00 – 30,00
	HSS-E	HSS-E	HSS	HSS	HSS	HSS	HSS	HSS
	uncoated	uncoated	uncoated	uncoated	uncoated	uncoated	uncoated	uncoated
	B 334	B 344	B 343	B 336	B 316	B 317	B 320	B 321
	••	••	••	••	••	••	••	••
	••	••	••	••	••	••	••	••
	•	•	•	•	•	•	•	•
	•	•	•	•	•	•	•	•
	•	•	•	•	•	•	•	•
	••	••	••	••	••	••	••	••
	••	••	••	••	••	••	••	••
	•	•	•	•	•	•	•	•
	••	••	••	••	••	••	••	••
	••	••	••	••	••	••	••	••
	••	••	••	••	••	••	••	••
	••	••	••	••	••	••	••	••
	•	•	•	•	•	•	•	•
	••	••	••	••	••	••	••	••
	•	•	•	•	•	•	•	•

Hand reamers

F1111

H7

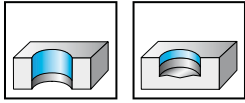

- HSS - uncoated
- Form A
- right handed - straight flute
- long chamfer

	P	M	K	N	S	H	O
uncoated	●●		●●	●●			●●

DIN 206

Cylindrical shank

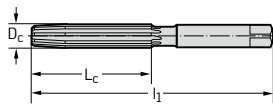

D _c mm	L _c mm	l ₁ mm	Designation F1111
1	13	34	-1
1,5	20	41	-1.5
2	25	50	-2
2,5	29	58	-2.5
3	31	62	-3
3,5	35	71	-3.5
4	38	76	-4
4,5	41	81	-4.5
5	44	87	-5
5,5	47	93	-5.5
6	47	93	-6
6,5	50	100	-6.5
7	54	107	-7
7,5	54	107	-7.5
8	58	115	-8
8,5	58	115	-8.5
9	62	124	-9
9,5	62	124	-9.5
10	66	133	-10
10,5	66	133	-10.5
11	71	142	-11
11,5	71	142	-11.5
12	76	152	-12
12,5	76	152	-12.5
13	76	152	-13
13,5	81	163	-13.5
14	81	163	-14
14,5	81	163	-14.5
15	81	163	-15
16	87	175	-16
17	87	175	-17
18	93	188	-18
19	93	188	-19
20	100	201	-20
21	100	201	-21
22	107	215	-22
23	107	215	-23
24	115	231	-24
25	115	231	-25
26	115	231	-26
27	124	247	-27
28	124	247	-28
29	124	247	-29
30	124	247	-30



Hand reamers F1131 H7

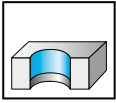

- HSS - uncoated
- Form B
- right handed - spiral flute
- long chamfer

	P	M	K	N	S	H	O
uncoated	●●	●	●●	●●	●	●	●●

DIN 206	D _c mm	L _c mm	l ₁ mm	Designation F1131
Cylindrical shank	1	13	34	-1
	1,1	15	36	-1.1
	1,2	17	38	-1.2
	1,3	17	38	-1.3
	1,4	20	41	-1.4
	1,5	20	41	-1.5
	1,6	21	44	-1.6
	1,7	21	44	-1.7
	1,8	23	47	-1.8
	1,9	23	47	-1.9
	2	25	50	-2
	2,1	25	50	-2.1
	2,2	27	54	-2.2
	2,3	27	54	-2.3
	2,4	29	58	-2.4
	2,5	29	58	-2.5
	2,6	29	58	-2.6
	2,7	31	62	-2.7
	2,8	31	62	-2.8
	2,9	31	62	-2.9
	3	31	62	-3
	3,1	33	66	-3.1
	3,2	33	66	-3.2
	3,3	33	66	-3.3
	3,4	35	71	-3.4
	3,5	35	71	-3.5
	3,6	35	71	-3.6
	3,7	35	71	-3.7
	3,8	38	76	-3.8
	3,9	38	76	-3.9
	4	38	76	-4
	4,1	38	76	-4.1
	4,2	38	76	-4.2
	4,3	41	81	-4.3
	4,4	41	81	-4.4
	4,5	41	81	-4.5
	4,6	41	81	-4.6
	4,7	41	81	-4.7
	4,8	44	87	-4.8
	4,9	44	87	-4.9
	5	44	87	-5
	5,1	44	87	-5.1
	5,2	44	87	-5.2
	5,3	44	87	-5.3
	5,4	47	93	-5.4
	5,5	47	93	-5.5
	5,6	47	93	-5.6

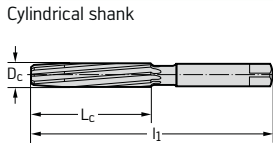

Continued



Hand reamers

F1131

H7



Continued

	P	M	K	N	S	H	O
uncoated	●●		●●	●●			●●

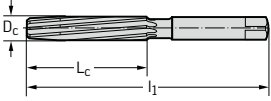
DIN 206	D _c mm	L _c mm	l ₁ mm	Designation F1131
Cylindrical shank 	5,7	47	93	-5,7
	5,8	47	93	-5,8
	5,9	47	93	-5,9
	6	47	93	-6
	6,1	50	100	-6,1
	6,2	50	100	-6,2
	6,3	50	100	-6,3
	6,4	50	100	-6,4
	6,5	50	100	-6,5
	6,6	50	100	-6,6
	6,7	50	100	-6,7
	6,8	54	107	-6,8
	6,9	54	107	-6,9
	7	54	107	-7
	7,1	54	107	-7,1
	7,2	54	107	-7,2
	7,3	54	107	-7,3
	7,4	54	107	-7,4
	7,5	54	107	-7,5
	7,6	58	115	-7,6
	7,7	58	115	-7,7
	7,8	58	115	-7,8
	7,9	58	115	-7,9
	8	58	115	-8
	8,1	58	115	-8,1
	8,2	58	115	-8,2
	8,3	58	115	-8,3
	8,4	58	115	-8,4
	8,5	58	115	-8,5
	8,6	62	124	-8,6
	8,7	62	124	-8,7
	8,8	62	124	-8,8
	8,9	62	124	-8,9
	9	62	124	-9
9,1	62	124	-9,1	
9,2	62	124	-9,2	
9,3	62	124	-9,3	
9,4	62	124	-9,4	
9,5	62	124	-9,5	
9,6	66	133	-9,6	
9,7	66	133	-9,7	
9,8	66	133	-9,8	
9,9	66	133	-9,9	
10	66	133	-10	
10,5	66	133	-10,5	
11	71	142	-11	
11,5	71	142	-11,5	
12	76	152	-12	
12,5	76	152	-12,5	
13	76	152	-13	
13,5	81	163	-13,5	
14	81	163	-14	
14,5	81	163	-14,5	
15	81	163	-15	
15,5	87	175	-15,5	

Continued

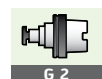

G 2



B 352

Hand reamers F1131 H7



	P	M	K	N	S	H	O
uncoated	●●	●	●●	●●	●	●	●●

Continued

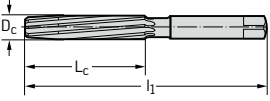
DIN 206	D _c mm	L _c mm	l ₁ mm	Designation F1131
Cylindrical shank 	16	87	175	-16
	16,5	87	175	-16.5
	17	87	175	-17
	17,5	93	188	-17.5
	18	93	188	-18
	18,5	93	188	-18.5
	19	93	188	-19
	19,5	100	201	-19.5
	20	100	201	-20
	20,5	100	201	-20.5
	21	100	201	-21
	21,5	100	201	-21.5
	22	107	215	-22
	22,5	107	215	-22.5
	23	107	215	-23
	23,5	107	215	-23.5
	24	115	231	-24
	24,5	115	231	-24.5
	25	115	231	-25
	25,5	115	231	-25.5
	26	115	231	-26
	26,5	115	231	-26.5
	27	124	247	-27
	27,5	124	247	-27.5
	28	124	247	-28
	28,5	124	247	-28.5
	29	124	247	-29
	29,5	124	247	-29.5
	30	124	247	-30
	31	133	265	-31
32	133	265	-32	
33	133	265	-33	
34	142	284	-34	
35	142	284	-35	
36	142	284	-36	
37	142	284	-37	
38	152	305	-38	
39	152	305	-39	
40	152	305	-40	
41	152	305	-41	
42	152	305	-42	
43	163	326	-43	
44	163	326	-44	
45	163	326	-45	
46	163	326	-46	
47	163	326	-47	
48	174	347	-48	
49	174	347	-49	
50	174	347	-50	

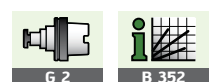

Adjustable hand reamers

F1211

H7

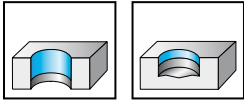

- HSS - uncoated
- Form A
- right handed - straight flute
- adjustment range: $0.01 \times D_c$

	P	M	K	N	S	H	O
uncoated	●●		●●	●●			●●

DIN 859

Cylindrical shank

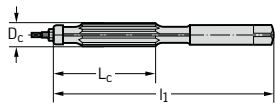

D_c mm	L_c mm	l_1 mm	Designation F1211
4	24	76	-4
5	30	87	-5
6	33	93	-6
7	38	107	-7
8	42	115	-8
9	46	124	-9
10	50	133	-10
11	51	142	-11
12	56	152	-12
13	56	152	-13
14	61	163	-14
15	61	163	-15
16	67	175	-16
17	67	175	-17
18	68	188	-18
19	68	188	-19
20	75	201	-20
22	82	215	-22
24	85	231	-24
25	85	231	-25
26	85	231	-26
28	94	247	-28
30	94	247	-30

Adjustable hand reamers F1231 H7

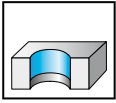

- HSS - uncoated
- Form B
- right handed - spiral flute
- adjustment range: 0.01 x D_c

	P	M	K	N	S	H	O
uncoated	●●		●●	●●			●●

DIN 859		D _c mm	L _c mm	l ₁ mm	Designation F1231
Cylindrical shank		8	42	115	-8
		9	46	124	-9
		10	50	133	-10
		11	51	142	-11
		12	56	152	-12
		13	56	152	-13
		14	61	163	-14
		15	61	163	-15
		16	67	175	-16
		17	67	175	-17
		18	68	188	-18
		19	68	188	-19
		20	75	201	-20
		22	82	215	-22
		24	85	231	-24
		25	85	231	-25
26	85	231	-26		
28	94	247	-28		
30	94	247	-30		



Machine reamers

F1342

H7

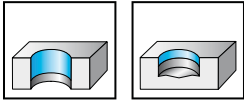

- HSS-E - uncoated
- form A/C
- right handed - straight flute
- Walter Titex standard up to Ø 2.1
- with centring tip on both ends up to Ø 3.7

	P	M	K	N	S	H	O
uncoated	●●	●	●●	●●	●	●	●●

DIN 212

Cylindrical shank

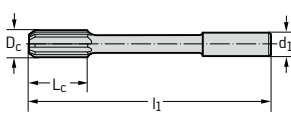

D _c mm	d ₁ h9 mm	L _c mm	l ₁ mm	Z	Designation F1342
1	1	5,5	34	3	-1
1,1	1,1	6,5	36	3	-1.1
1,2	1,1	6,5	36	3	-1.2
1,3	1,2	7,5	38	3	-1.3
1,4	1,3	8	40	3	-1.4
1,5	1,4	8	40	3	-1.5
1,6	1,5	9	43	3	-1.6
1,7	1,5	9	43	3	-1.7
1,8	1,7	10	46	4	-1.8
1,9	1,7	10	46	4	-1.9
2	1,9	11	49	4	-2
2,1	1,9	11	49	4	-2.1
2,2	2,2	12	53	4	-2.2
2,3	2,3	12	53	4	-2.3
2,4	2,4	14	57	4	-2.4
2,5	2,5	14	57	4	-2.5
2,6	2,6	14	57	4	-2.6
2,7	2,7	15	61	6	-2.7
2,8	2,8	15	61	6	-2.8
2,9	2,9	15	61	6	-2.9
3	3	15	61	6	-3
3,1	3,1	16	65	6	-3.1
3,2	3,2	16	65	6	-3.2
3,3	3,3	16	65	6	-3.3
3,4	3,4	18	70	6	-3.4
3,5	3,5	18	70	6	-3.5
3,6	3,6	18	70	6	-3.6
3,7	3,7	18	70	6	-3.7
3,8	4	19	75	6	-3.8
3,9	4	19	75	6	-3.9
4	4	19	75	6	-4
4,1	4	19	75	6	-4.1
4,2	4	19	75	6	-4.2
4,3	4,5	21	80	6	-4.3
4,4	4,5	21	80	6	-4.4
4,5	4,5	21	80	6	-4.5
4,6	4,5	21	80	6	-4.6
4,7	4,5	21	80	6	-4.7
4,8	5	23	86	6	-4.8
4,9	5	23	86	6	-4.9
5	5	23	86	6	-5
5,1	5	23	86	6	-5.1
5,2	5	23	86	6	-5.2
5,3	5	23	86	6	-5.3
5,4	5,6	26	93	6	-5.4
5,5	5,6	26	93	6	-5.5
5,6	5,6	26	93	6	-5.6

Continued



Machine reamers

F1342

H7



Continued

	P	M	K	N	S	H	O
uncoated	●●		●●	●●			●●

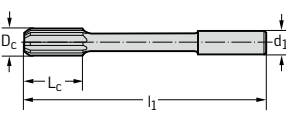
DIN 212	D _c mm	d ₁ h9 mm	L _c mm	l ₁ mm	Z	Designation F1342
Cylindrical shank 	5,7	5,6	26	93	6	-5.7
	5,8	5,6	26	93	6	-5.8
	5,9	5,6	26	93	6	-5.9
	6	5,6	26	93	6	-6
	6,1	6,3	28	101	6	-6.1
	6,2	6,3	28	101	6	-6.2
	6,3	6,3	28	101	6	-6.3
	6,4	6,3	28	101	6	-6.4
	6,5	6,3	28	101	6	-6.5
	6,6	6,3	28	101	6	-6.6
	6,7	6,3	28	101	6	-6.7
	6,8	7,1	31	109	6	-6.8
	6,9	7,1	31	109	6	-6.9
	7	7,1	31	109	6	-7
	7,1	7,1	31	109	6	-7.1
	7,2	7,1	31	109	6	-7.2
	7,3	7,1	31	109	6	-7.3
	7,4	7,1	31	109	6	-7.4
	7,5	7,1	31	109	6	-7.5
	7,6	8	33	117	6	-7.6
	7,7	8	33	117	6	-7.7
	7,8	8	33	117	6	-7.8
	7,9	8	33	117	6	-7.9
	8	8	33	117	6	-8
	8,1	8	33	117	6	-8.1
	8,2	8	33	117	6	-8.2
	8,3	8	33	117	6	-8.3
	8,4	8	33	117	6	-8.4
	8,5	8	33	117	6	-8.5
	8,6	9	36	125	6	-8.6
	8,7	9	36	125	6	-8.7
	8,8	9	36	125	6	-8.8
	8,9	9	36	125	6	-8.9
	9	9	36	125	6	-9
9,1	9	36	125	6	-9.1	
9,2	9	36	125	6	-9.2	
9,3	9	36	125	6	-9.3	
9,4	9	36	125	6	-9.4	
9,5	9	36	125	6	-9.5	
9,6	10	38	133	6	-9.6	
9,7	10	38	133	6	-9.7	
9,8	10	38	133	6	-9.8	
9,9	10	38	133	6	-9.9	
10	10	38	133	6	-10	
10,1	10	38	133	6	-10.1	
10,2	10	38	133	6	-10.2	
10,3	10	38	133	6	-10.3	
10,4	10	38	133	6	-10.4	
10,5	10	38	133	6	-10.5	
10,6	10	38	133	6	-10.6	
10,7	10	41	142	6	-10.7	
10,8	10	41	142	6	-10.8	
10,9	10	41	142	6	-10.9	
11	10	41	142	6	-11	
11,5	10	41	142	6	-11.5	

Continued



Machine reamers

F1342

H7



Continued

	P	M	K	N	S	H	O
uncoated	●●		●●	●●			●●

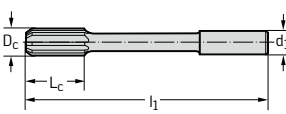
DIN 212	D _c mm	d ₁ h9 mm	L _c mm	l ₁ mm	Z	Designation F1342
Cylindrical shank 	12	10	44	151	6	-12
	12,5	10	44	151	6	-12.5
	13	10	44	151	6	-13
	13,5	12,5	47	160	6	-13.5
	14	12,5	47	160	8	-14
	14,5	12,5	50	162	8	-14.5
	15	12,5	50	162	8	-15
	15,5	12,5	52	170	8	-15.5
	16	12,5	52	170	8	-16
	16,5	14	54	175	8	-16.5
	17	14	54	175	8	-17
	17,5	14	56	182	8	-17.5
	18	14	56	182	8	-18
	18,5	16	58	189	8	-18.5
	19	16	58	189	8	-19
	19,5	16	60	195	8	-19.5
	20	16	60	195	8	-20

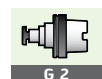

Machine reamers

F1352

H7

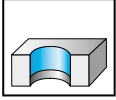

- HSS-E - uncoated
- Form B/D
- right handed - spiral flute
- Walter Titex standard up to Ø 1.3
- with centring tip on both ends up to Ø 3.7

	P	M	K	N	S	H	O
uncoated	●●	●	●●	●●	●	●	●●

DIN 212	D _c mm	d ₁ h9 mm	L _c mm	l ₁ mm	Z	Designation F1352
Cylindrical shank	0,9	0,9	5,5	34	3	-0,9
	1	1	5,5	34	3	-1
	1,1	1,1	6,5	36	3	-1,1
	1,2	1,2	7,5	38	3	-1,2
	1,3	1,3	7,5	38	3	-1,3
	1,4	1,4	8	40	3	-1,4
	1,5	1,5	8	40	3	-1,5
	1,6	1,6	9	43	3	-1,6
	1,7	1,7	9	43	3	-1,7
	1,8	1,8	10	46	4	-1,8
	1,9	1,9	10	46	4	-1,9
	2	2	11	49	4	-2
	2,1	2,1	11	49	4	-2,1
	2,2	2,2	12	53	4	-2,2
	2,3	2,3	12	53	4	-2,3
	2,4	2,4	14	57	4	-2,4
	2,5	2,5	14	57	4	-2,5
	2,6	2,6	14	57	4	-2,6
	2,7	2,7	15	61	6	-2,7
	2,8	2,8	15	61	6	-2,8
2,9	2,9	15	61	6	-2,9	
3	3	15	61	6	-3	
3,1	3,1	16	65	6	-3,1	
3,2	3,2	16	65	6	-3,2	
3,3	3,3	16	65	6	-3,3	
3,4	3,4	18	70	6	-3,4	
3,5	3,5	18	70	6	-3,5	
3,6	3,6	18	70	6	-3,6	
3,7	3,7	18	70	6	-3,7	
3,8	4	19	75	6	-3,8	
3,9	4	19	75	6	-3,9	
4	4	19	75	6	-4	
4,1	4	19	75	6	-4,1	
4,2	4	19	75	6	-4,2	
4,3	4,5	21	80	6	-4,3	
4,4	4,5	21	80	6	-4,4	
4,5	4,5	21	80	6	-4,5	
4,6	4,5	21	80	6	-4,6	
4,7	4,5	21	80	6	-4,7	
4,8	5	23	86	6	-4,8	
4,9	5	23	86	6	-4,9	
5	5	23	86	6	-5	
5,1	5	23	86	6	-5,1	
5,2	5	23	86	6	-5,2	
5,3	5	23	86	6	-5,3	
5,4	5,6	26	93	6	-5,4	
5,5	5,6	26	93	6	-5,5	

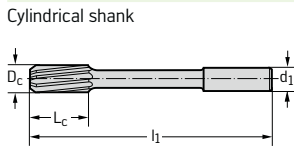

Continued



Machine reamers

F1352

H7



Continued

	P	M	K	N	S	H	O
uncoated	●●		●●	●●			●●

DIN 212	D _c mm	d ₁ h9 mm	L _c mm	l ₁ mm	Z	Designation F1352
Cylindrical shank 	5,6	5,6	26	93	6	-5.6
	5,7	5,6	26	93	6	-5.7
	5,8	5,6	26	93	6	-5.8
	5,9	5,6	26	93	6	-5.9
	6	5,6	26	93	6	-6
	6,1	6,3	28	101	6	-6.1
	6,2	6,3	28	101	6	-6.2
	6,3	6,3	28	101	6	-6.3
	6,4	6,3	28	101	6	-6.4
	6,5	6,3	28	101	6	-6.5
	6,6	6,3	28	101	6	-6.6
	6,7	6,3	28	101	6	-6.7
	6,8	7,1	31	109	6	-6.8
	6,9	7,1	31	109	6	-6.9
	7	7,1	31	109	6	-7
	7,1	7,1	31	109	6	-7.1
	7,2	7,1	31	109	6	-7.2
	7,3	7,1	31	109	6	-7.3
	7,4	7,1	31	109	6	-7.4
	7,5	7,1	31	109	6	-7.5
	7,6	8	33	117	6	-7.6
7,7	8	33	117	6	-7.7	
7,8	8	33	117	6	-7.8	
7,9	8	33	117	6	-7.9	
8	8	33	117	6	-8	
8,1	8	33	117	6	-8.1	
8,2	8	33	117	6	-8.2	
8,3	8	33	117	6	-8.3	
8,4	8	33	117	6	-8.4	
8,5	8	33	117	6	-8.5	
8,6	9	36	125	6	-8.6	
8,7	9	36	125	6	-8.7	
8,8	9	36	125	6	-8.8	
8,9	9	36	125	6	-8.9	
9	9	36	125	6	-9	
9,1	9	36	125	6	-9.1	
9,2	9	36	125	6	-9.2	
9,3	9	36	125	6	-9.3	
9,4	9	36	125	6	-9.4	
9,5	9	36	125	6	-9.5	
9,6	10	38	133	6	-9.6	
9,7	10	38	133	6	-9.7	
9,8	10	38	133	6	-9.8	
9,9	10	38	133	6	-9.9	
10	10	38	133	6	-10	
10,1	10	38	133	6	-10.1	
10,2	10	38	133	6	-10.2	
10,3	10	38	133	6	-10.3	
10,4	10	38	133	6	-10.4	
10,5	10	38	133	6	-10.5	
10,6	10	38	133	6	-10.6	
10,7	10	41	142	6	-10.7	
10,8	10	41	142	6	-10.8	
10,9	10	41	142	6	-10.9	
11	10	41	142	6	-11	

Continued



Machine reamers F1352 H7



Continued

	P	M	K	N	S	H	O
uncoated	●●		●●	●●			●●

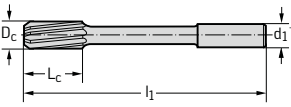
DIN 212	D _c mm	d ₁ h9 mm	L _c mm	l ₁ mm	Z	Designation F1352
Cylindrical shank 	11,5	10	41	142	6	-11.5
	12	10	44	151	6	-12
	12,5	10	44	151	6	-12.5
	13	10	44	151	6	-13
	13,5	12,5	47	160	8	-13.5
	14	12,5	47	160	8	-14
	14,5	12,5	50	162	8	-14.5
	15	12,5	50	162	8	-15
	15,5	12,5	52	170	8	-15.5
	16	12,5	52	170	8	-16
	16,5	14	54	175	8	-16.5
	17	14	54	175	8	-17
	17,5	14	56	182	8	-17.5
	18	14	56	182	8	-18
	18,5	16	58	189	8	-18.5
	19	16	58	189	8	-19
	19,5	16	60	195	8	-19.5
20	16	60	195	8	-20	



Determination of reamer diameter for F 1352 HUN in relation to nominal diameter and tolerance field

Nominal diameter D _c mm above – to	Additional values in mm, relative to the fits														
	A 9	A 11	B 8	B 9	B 10	B 11	C 8	C 9	C 10	C 11	D 7	D 8	D 9	D 10	D 11
1–3	+0,28	+0,31	–	+0,15	+0,17	+0,18	–	+0,07	+0,09	+0,10	–	–	+0,03	+0,05	+0,06
3–6	+0,29	+0,32	+0,15	+0,16	+0,17	+0,19	+0,08	+0,09	+0,10	+0,12	–	+0,04	+0,05	+0,06	+0,08
6–10	+0,30	+0,35	+0,16	+0,17	+0,19	+0,22	+0,09	+0,10	+0,12	+0,15	–	+0,05	+0,06	+0,08	+0,11
10–18	+0,32	+0,37	+0,16	+0,18	+0,20	+0,23	+0,11	+0,12	+0,14	+0,18	+0,06	+0,06	+0,08	+0,10	+0,13
	E 7	E 8	E 9	F 7	F 8	F 9	F 10	G 6	G 7	H 6	H 7	H 8	H 9	H 10	H 11
1–3	–	+0,02	+0,03	+0,01	+0,01	+0,02	–	–	–	–	–	–	+0,01	+0,03	+0,04
3–6	–	+0,03	+0,04	–	+0,02	+0,03	+0,04	–	+0,01	–	–	+0,01	+0,02	+0,03	+0,05
6–10	+0,03	+0,03	+0,05	+0,02	+0,02	+0,03	+0,05	–	+0,01	–	–	+0,01	+0,02	+0,04	+0,07
10–18	+0,04	+0,04	+0,06	+0,02	+0,03	+0,04	+0,07	+0,01	–	–	+0,01	+0,01	+0,03	+0,05	+0,08
	H 12	H 13	J 6	J 7	J 8	JS 6	JS 7	JS 8	JS 9	K 7	K 8	M 6	M 7	M 8	N 6
1–3	+0,08	+0,11	–	–	–	–	–	+0,00	+0,00	–	–0,01	–	–	–	–
3–6	+0,09	+0,14	–	+0,00	+0,00	–	+0,00	+0,00	+0,00	–	–	–	–	–0,01	–
6–10	+0,12	+0,18	–	+0,00	+0,00	–	+0,00	+0,00	+0,00	–	–0,01	–0,01	–0,01	–0,01	–
10–18	+0,14	+0,22	–	+0,00	+0,00	–	+0,00	+0,00	+0,01	–	–0,01	–0,01	–0,01	–0,01	–
	N 7	N 8	N 9	N 10	N 11	P 6	P 7	R 6	R 7	S 6	S 7	U 6	U 7	U 10	Z 10
1–3	–0,01	–0,01	–0,02	–0,02	–0,02	–	–	–	–	–	–0,02	–	–	–	–0,04
3–6	–0,01	–0,01	–0,01	–0,02	–0,02	–	–	–	–0,02	–	–	–	–0,03	–0,04	–0,05
6–10	–	–0,02	–0,01	–0,02	–0,02	–	–0,02	–	–0,02	–	–0,03	–	–0,03	–0,05	–0,06
10–18	–0,01	–0,02	–0,02	–0,02	–0,03	–	–0,02	–	–0,03	–	–0,03	–	–	–0,05	–0,07

Application example:

Query: D_c = 4.25 mm F8

Solution: nominal diameter + allowance = 1/100 reamers
4.25 mm + 0.02 mm = 4.27 mm

Tool: Walter Titex reamer F 1352 HUN D_c = 4.27 mm

Application notes:

The table is structured so that each reamer diameter can be determined with a step difference of 1/100 mm.

The manufacturing tolerances are taken into consideration in the additional values:

Diameter up to D_c = 6 mm 0.004 mm
+
0

more than D_c = 6 mm 0.005 mm
+
0

The specified fits can be manufactured with 1/100 reamers, since they correspond to the manufacturing tolerances for reamers in accordance with DIN 1420.

The lower tolerance field dimension for reamers in accordance with DIN 1420 has been reduced by 25 % for the fields with the green background. The result of this is that the usage period of the reamers is reduced in relation to the hole tolerance. The additional values in the green fields can be used in special cases.

Machine reamers

F1352HUN

H7

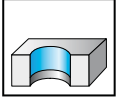

- HSS-E - uncoated
- Form B/D
- right handed - spiral flute
- Walter Titex standard up to Ø 1.3
- with centring tip on both ends up to Ø 3.7

	P	M	K	N	S	H	O
uncoated	●●	●	●●	●●	●	●	●●

DIN 212	D_c from – to mm	d_1 mm	L_c mm	l_1 mm	Z	Designation F1352HUN
Cylindrical shank	0,95	= D_c	5,5	34	3	...-0,95
	0,97 – 1,06	= D_c	5,5	34	3	...-0,97 – ...-1,06
	1,07 – 1,18	= D_c	6,5	34	3	...-1,07 – ...-1,18
	1,19 – 1,32	= D_c	7,5	34	3	...-1,19 – ...-1,32
	1,33 – 1,50	= D_c	8,0	40	3	...-1,33 – ...-1,50
	1,51 – 1,70	= D_c	9,0	43	3	...-1,51 – ...-1,70
	1,71 – 1,90	= D_c	10,0	46	4	...-1,71 – ...-1,90
	1,91 – 2,12	= D_c	11,0	49	4	...-1,91 – ...-2,12
	2,13 – 2,36	= D_c	12,0	53	4	...-2,13 – ...-2,36
	2,37 – 2,65	= D_c	14,0	57	4	...-2,37 – ...-2,65
	2,66 – 3,00	= D_c	15,0	61	6	...-2,66 – ...-3,00
	3,01 – 3,35	= D_c	16,0	65	6	...-3,01 – ...-3,35
	3,36 – 3,75	= D_c	18,0	70	6	...-3,36 – ...-3,75
	3,76 – 4,25	4,0	19,0	75	6	...-3,76 – ...-4,25
	4,26 – 4,75	4,5	21,0	80	6	...-4,26 – ...-4,75
	4,76 – 5,30	5,0	23,0	86	6	...-4,76 – ...-5,30
	5,31 – 6,00	5,6	26,0	93	6	...-5,31 – ...-6,00
	6,01 – 6,70	6,3	28,0	101	6	...-6,01 – ...-6,70
	6,71 – 7,50	7,1	31,0	109	6	...-6,71 – ...-7,50
	7,51 – 8,50	8,0	33,0	117	6	...-7,51 – ...-8,50
	8,51 – 9,50	9,0	36,0	125	6	...-8,51 – ...-9,50
	9,51 – 10,60	10,0	38,0	133	6	...-9,51 – ...-10,60
	10,61 – 11,80	10,0	41,0	142	6	...-10,61 – ...-11,80
	11,81 – 12,00	10,0	44,0	151	6	...-11,81 – ...-12,00

Cylindrical shank

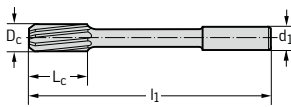

Machine reamers – quick spiral

F1353

H7

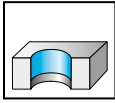

- HSS-E - uncoated
- Form E
- right handed - spiral flute

	P	M	K	N	S	H	O
uncoated	●●	●	●●	●●	●	●	●●

DIN 212

Cylindrical shank

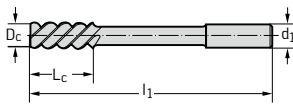

D _c mm	d ₁ h9 mm	L _c mm	l ₁ mm	Z	Designation F1353
1	1	5,5	34	2	-1
1,1	1,1	6,5	36	2	-1.1
1,2	1,1	7,5	36	2	-1.2
1,3	1,1	7,5	38	2	-1.3
1,4	1,4	8	40	2	-1.4
1,5	1,5	8	40	2	-1.5
1,6	1,6	9	43	2	-1.6
1,7	1,6	9	43	2	-1.7
1,8	1,8	10	46	2	-1.8
1,9	1,8	10	46	3	-1.9
2	1,9	11	49	3	-2
2,1	2,1	11	49	3	-2.1
2,2	2,2	12	53	3	-2.2
2,3	2,3	12	53	3	-2.3
2,4	2,4	14	57	3	-2.4
2,5	2,5	14	57	3	-2.5
2,6	2,6	14	57	3	-2.6
2,7	2,7	15	61	3	-2.7
2,8	2,8	15	61	3	-2.8
2,9	2,9	15	61	3	-2.9
3	3	15	61	3	-3
3,5	3,5	18	70	3	-3.5
4	4	19	75	3	-4
4,5	4,5	21	80	3	-4.5
5	5	23	86	3	-5
5,5	5,6	26	93	3	-5.5
6	5,6	26	93	3	-6
6,5	6,3	28	101	3	-6.5
7	7,1	31	109	3	-7
7,5	7,1	31	109	3	-7.5
8	8	33	117	3	-8
8,5	8	33	117	3	-8.5
9	9	36	125	3	-9
9,5	9	36	125	3	-9.5
10	10	38	133	3	-10
10,5	10	38	133	3	-10.5
11	10	41	142	3	-11
11,5	10	41	142	3	-11.5
12	10	44	151	3	-12
12,5	10	44	151	3	-12.5
13	10	44	151	3	-13
13,5	12,5	47	160	3	-13.5
14	12,5	47	160	3	-14
14,5	12,5	50	162	3	-14.5
15	12,5	50	162	3	-15
15,5	12,5	52	170	3	-15.5
16	12,5	52	170	3	-16

Continued

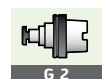

Machine reamers – quick spiral

F1353

H7



Continued

	P	M	K	N	S	H	O
uncoated	●●		●●	●●			●●

DIN 212	D _c mm	d ₁ h9 mm	L _c mm	l ₁ mm	Z	Designation F1353
	16,5	14	54	175	3	-16.5
	17	14	54	175	3	-17
	17,5	14	56	182	3	-17.5
	18	14	56	182	3	-18
	18,5	16	58	189	3	-18.5
	19	16	58	189	3	-19
	19,5	16	60	195	3	-19.5
	20	16	60	195	3	-20

Carbide machine reamers

F1362

H7

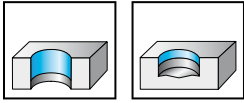

- K10 - uncoated
- Form A/C
- right handed - straight flute
- differential pitch
- offset shank from $\varnothing 2$
- solid carbide up to $\varnothing 6$, solid carbide head up to $\varnothing 16$, greater than $\varnothing 16$ carbide-tipped

	P	M	K	N	S	H	O
uncoated	●●	●●	●●	●●	●●	●	●●

	D_c mm	d_1 h9 mm	L_c mm	l_1 mm	Z	Designation F1362
Cylindrical shank	2	2	11	49	4	-2
	2,2	2,2	15	57	4	-2.2
	2,5	2,5	15	57	4	-2.5
	2,8	2,8	15	61	4	-2.8
	3	3	15	61	6	-3
	3,2	3,2	18	70	6	-3.2
	3,5	3,5	18	70	6	-3.5
	4	4	19	75	6	-4
	4,5	4,5	21	80	6	-4.5
	5	5	23	86	6	-5
	5,5	5,6	26	93	6	-5.5
	6	5,6	26	93	6	-6
	6,5	6,3	28	101	6	-6.5
	7	7,1	31	109	6	-7
	7,5	7,1	31	109	6	-7.5
	8	8	33	117	6	-8
	8,5	8	33	117	6	-8.5
	9	9	36	125	6	-9
	9,5	9	36	125	6	-9.5
	10	10	38	133	6	-10
	10,5	10	38	133	6	-10.5
	11	10	41	142	6	-11
	11,5	10	41	142	6	-11.5
	12	10	44	151	6	-12
	12,5	10	44	151	6	-12.5
	13	10	44	151	6	-13
	13,5	12,5	47	160	8	-13.5
	14	12,5	47	160	8	-14
	14,5	12,5	50	162	8	-14.5
	15	12,5	50	162	8	-15
	15,5	12,5	52	170	8	-15.5
	16	12,5	52	170	8	-16
	17	14	54	175	8	-17
	18	14	56	182	8	-18
	19	16	58	189	8	-19
	20	16	60	195	8	-20

Dia. 2 to dia. 3.5: dimensions similar to DIN 212

Dia. 4 to $\varnothing 8$: dimensions similar to DIN 8093



Carbide machine reamers

F1371

H7

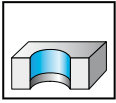

- K10 - uncoated
- Form B/D
- right handed - spiral flute
- differential pitch
- offset shank from $\varnothing 2$
- solid carbide up to $\varnothing 6$, solid carbide head up to $\varnothing 16$, greater than $\varnothing 16$ carbide-tipped

	P	M	K	N	S	H	O
uncoated	●	●	●	●	●	●	●

	D_c mm	d_1 h9 mm	L_c mm	l_1 mm	Z	Designation F1371
Cylindrical shank	2	2	11	49	4	-2
	2,2	2,2	15	57	4	-2.2
	2,5	2,5	15	57	4	-2.5
	2,8	2,8	15	61	4	-2.8
	3	3	15	61	4	-3
	3,2	3,2	18	70	6	-3.2
	3,5	3,5	18	70	6	-3.5
	4	4	19	75	6	-4
	4,5	4,5	21	80	6	-4.5
	5	5	23	86	6	-5
	5,5	5,6	26	93	6	-5.5
	6	5,6	26	93	6	-6
	6,5	6,3	28	101	6	-6.5
	7	7,1	31	109	6	-7
	7,5	7,1	31	109	6	-7.5
	8	8	33	117	6	-8
	8,5	8	33	117	6	-8.5
	9	9	36	125	6	-9
	9,5	9	36	125	6	-9.5
	10	10	38	133	6	-10
	10,5	10	38	133	6	-10.5
	11	10	41	142	6	-11
	11,5	10	41	142	6	-11.5
	12	10	44	151	6	-12
	12,5	10	44	151	6	-12.5
	13	10	44	151	6	-13
	13,5	12,5	47	160	8	-13.5
	14	12,5	47	160	8	-14
	14,5	12,5	50	162	8	-14.5
	15	12,5	50	162	8	-15
	15,5	12,5	52	170	8	-15.5
	16	12,5	52	170	8	-16
	17	14	54	175	8	-17
	18	14	56	182	8	-18
	19	16	58	189	8	-19
	20	16	60	195	8	-20

Dia. 2 to $\varnothing 3.5$: dimensions in acc. with DIN 212

Dia. 4 to $\varnothing 8$: dimensions in acc. with DIN 8093



Taper pin reamers, quick spiral

F3234

1:50

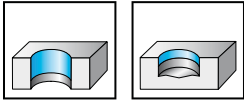

- HSS-E - uncoated
- right handed - spiral flute
- for tapered pins in accordance with DIN 258; 1447; 7977; 7978
- for tapered pins in accordance with DIN EN 28736; 28737; 28744
- Walter Titex standard up to Ø 1.5

	P	M	K	N	S	H	O
uncoated	●●		●●	●●			●●

DIN 2179

Cylindrical shank

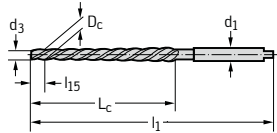

	D _c mm	d ₁ h9 mm	d ₃ mm	L _c mm	l ₁ mm	l ₁₅ mm	Z	Designation F3234
1	1,4	1,4	0,8	33	60	5	2	-1
1,5	2,1	2,1	1,3	42	70	5	2	-1.5
2	3,15	3,15	1,9	48	86	5	3	-2
2,5	3,15	3,15	1,9	48	86	5	3	-2.5
3	4	4	2,9	58	100	5	3	-3
4	5	5	3,9	68	112	5	3	-4
5	6,3	6,3	4,9	73	122	5	3	-5
6	8	8	5,9	105	160	5	3	-6
8	10	10	7,9	145	207	5	3	-8
10	12,5	12,5	9,9	175	245	5	3	-10
12	16	16	11,8	210	290	10	3	-12

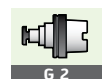

G 2



B 352

Hand taper reamers

F3317

1:50

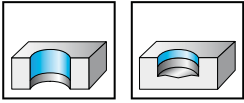

- HSS - uncoated
- Form A
- right handed - straight flute
- for tapered pins in accordance with DIN 258; 1447; 7977; 7978
- for tapered pins in accordance with DIN EN 28736; 28737; 28744

	P	M	K	N	S	H	O
uncoated	●●		●●	●●			●●

DIN 9 A

Cylindrical shank

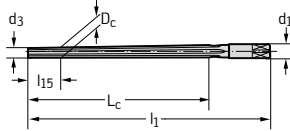

D _c mm	d ₁ mm	d ₃ mm	L _c mm	l ₁ mm	l ₁₅ mm	Z	Designation F3317
1	3,15	0,9	28	46	5	3	-1
1,2	3,15	1,1	32	50	5	3	-1.2
1,5	3,15	1,4	37	57	5	3	-1.5
2	3,15	1,9	48	68	5	3	-2
2,5	3,15	2,4	48	68	5	4	-2.5
3	4	2,9	58	80	5	5	-3
4	5	3,9	68	93	5	5	-4
5	6,3	4,9	73	100	5	5	-5
6	8	5,9	105	135	5	6	-6
8	10	7,9	145	180	5	6	-8
10	12,5	9,9	175	215	5	6	-10
12	14	11,8	210	255	10	8	-12
16	18	15,8	230	280	10	8	-16
20	22,4	19,8	250	310	10	8	-20
25	28	24,7	300	370	15	10	-25
30	31,5	29,7	320	400	15	10	-30



G 2

B 352

Taper reamers
F3517
1:10

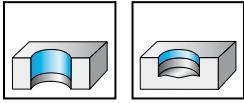

- HSS - uncoated
- right handed - straight flute

	P	M	K	N	S	H	O
uncoated	●●	●	●●	●●	●	●	●●

	D _c mm	d ₁ mm	d ₁₀ mm	L _c mm	l ₁ mm	Z	Designation F3517
Cylindrical shank	5	13	15	100	140	7	-5
	10	21	25	150	195	9	-10
	15	30	35	200	250	11	-15
	23	40	45	220	275	11	-23

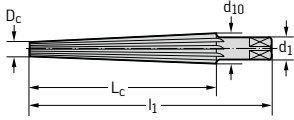

Machine reamers, taper shank

F4142

H7

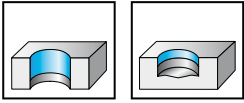

- HSS-E - uncoated
- Form A
- right handed - straight flute

	P	M	K	N	S	H	O
uncoated	●●	●	●●	●●	●	●	●●

DIN 208

Morse taper

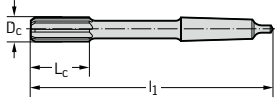

	D _c mm	L _c mm	l ₁ mm	MK	Z	Designation F4142
5	23	23	133	MK1 B	6	-5
6	26	26	138	MK1 B	6	-6
7	31	31	150	MK1 B	6	-7
8	33	33	156	MK1 B	6	-8
9	36	36	162	MK1 B	6	-9
10	38	38	168	MK1 B	6	-10
11	41	41	175	MK1 B	6	-11
12	44	44	182	MK1 B	6	-12
13	44	44	182	MK1 B	6	-13
14	47	47	189	MK1 B	8	-14
15	50	50	204	MK2 B	8	-15
16	52	52	210	MK2 B	8	-16
17	54	54	214	MK2 B	8	-17
18	56	56	219	MK2 B	8	-18
19	58	58	223	MK2 B	8	-19
20	60	60	228	MK2 B	8	-20
21	62	62	232	MK2 B	8	-21
22	64	64	237	MK2 B	8	-22
23	66	66	241	MK2 B	8	-23
24	68	68	268	MK3 B	8	-24
25	68	68	268	MK3 B	8	-25
26	70	70	273	MK3 B	8	-26
27	71	71	277	MK3 B	10	-27
28	71	71	277	MK3 B	10	-28
29	73	73	281	MK3 B	10	-29
30	73	73	281	MK3 B	10	-30
31	75	75	285	MK3 B	10	-31
32	77	77	317	MK4 B	10	-32



Machine reamers, taper shank

F4152

H7

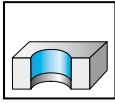

- HSS-E - uncoated
- Form B
- right handed - spiral flute

	P	M	K	N	S	H	O
uncoated	●●		●●	●●			●●

DIN 208

Morse taper

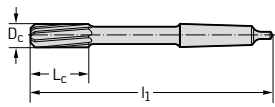

D_c mm	L_c mm	l_1 mm	MK	Z	Designation F4152
5	23	133	MK1 B	6	-5
5,5	26	138	MK1 B	6	-5.5
6	26	138	MK1 B	6	-6
6,5	28	144	MK1 B	6	-6.5
7	31	150	MK1 B	6	-7
7,5	31	150	MK1 B	6	-7.5
8	33	156	MK1 B	6	-8
8,5	33	156	MK1 B	6	-8.5
9	36	162	MK1 B	6	-9
9,5	36	162	MK1 B	6	-9.5
10	38	168	MK1 B	6	-10
10,5	38	168	MK1 B	6	-10.5
11	41	175	MK1 B	6	-11
11,5	41	175	MK1 B	6	-11.5
12	44	182	MK1 B	6	-12
12,5	44	182	MK1 B	6	-12.5
13	44	182	MK1 B	6	-13
13,5	47	189	MK1 B	8	-13.5
14	47	189	MK1 B	8	-14
14,5	50	204	MK2 B	8	-14.5
15	50	204	MK2 B	8	-15
15,5	52	210	MK2 B	8	-15.5
16	52	210	MK2 B	8	-16
16,5	54	214	MK2 B	8	-16.5
17	54	214	MK2 B	8	-17
17,5	56	219	MK2 B	8	-17.5
18	56	219	MK2 B	8	-18
18,5	58	223	MK2 B	8	-18.5
19	58	223	MK2 B	8	-19
19,5	60	228	MK2 B	8	-19.5
20	60	228	MK2 B	8	-20
20,5	62	232	MK2 B	8	-20.5
21	62	232	MK2 B	8	-21
21,5	64	237	MK2 B	8	-21.5
22	64	237	MK2 B	8	-22
22,5	66	241	MK2 B	8	-22.5
23	66	241	MK2 B	8	-23
23,5	66	241	MK2 B	8	-23.5
24	68	268	MK3 B	8	-24
24,5	68	268	MK3 B	8	-24.5
25	68	268	MK3 B	8	-25
25,5	70	273	MK3 B	8	-25.5
26	70	273	MK3 B	8	-26
26,5	71	277	MK3 B	10	-26.5
27	71	277	MK3 B	10	-27
27,5	71	277	MK3 B	10	-27.5
28	71	277	MK3 B	10	-28

Continued

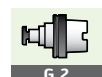

Machine reamers, taper shank

F4152

H7



Continued

	P	M	K	N	S	H	O
uncoated	●●		●●	●●			●●

DIN 208	D _c mm	L _c mm	l ₁ mm	MK	Z	Designation F4152
Morse taper	28,5	73	281	MK3 B	10	-28.5
	29	73	281	MK3 B	10	-29
	29,5	73	281	MK3 B	10	-29.5
	30	73	281	MK3 B	10	-30
	30,5	75	285	MK3 B	10	-30.5
	31	75	285	MK3 B	10	-31
	31,5	75	285	MK3 B	10	-31.5
	32	77	317	MK4 B	10	-32
	33	77	317	MK4 B	10	-33
	34	78	321	MK4 B	10	-34
	35	78	321	MK4 B	10	-35
	36	79	325	MK4 B	10	-36
	37	79	325	MK4 B	10	-37
	38	81	329	MK4 B	10	-38
	39	81	329	MK4 B	10	-39
	40	81	329	MK4 B	10	-40

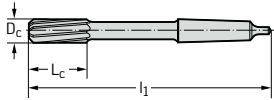

Machine reamers, taper shank, quick spiral

F4153

H7

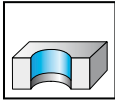

- HSS-E - uncoated
- Form C
- right handed - spiral flute

	P	M	K	N	S	H	O
uncoated	●●			●●			●●

DIN 208

Morse taper

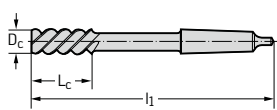

D_c mm	L_c mm	l_1 mm	MK	Z	Designation F4153
5	23	133	MK1 B	3	-5
6	26	138	MK1 B	3	-6
7	31	150	MK1 B	3	-7
8	33	156	MK1 B	3	-8
9	36	162	MK1 B	3	-9
10	38	168	MK1 B	3	-10
11	41	175	MK1 B	3	-11
12	44	182	MK1 B	3	-12
13	44	182	MK1 B	3	-13
14	47	189	MK1 B	3	-14
15	50	204	MK2 B	3	-15
16	52	210	MK2 B	3	-16
17	54	214	MK2 B	3	-17
18	56	219	MK2 B	3	-18
19	58	223	MK2 B	3	-19
20	60	228	MK2 B	3	-20
21	62	232	MK2 B	3	-21
22	64	237	MK2 B	3	-22
23	66	241	MK2 B	3	-23
24	68	268	MK3 B	3	-24
25	68	268	MK3 B	3	-25
26	70	273	MK3 B	3	-26
27	71	277	MK3 B	3	-27
28	71	277	MK3 B	3	-28
29	73	281	MK3 B	3	-29
30	73	281	MK3 B	3	-30
31	75	285	MK3 B	3	-31
32	77	317	MK4 B	3	-32

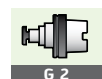

Carbide machine reamers, taper shank

F4162

H7

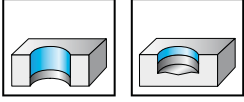

- K10 - uncoated
- Form A
- right handed - straight flute
- differential pitch
- solid carbide up to Ø 16, carbide tipped above Ø 16

	P	M	K	N	S	H	O
uncoated	●●	●●	●●	●●	●●	●	●●

	D _c mm	L _c mm	l ₁ mm	MK	Z	Designation F4162
Morse taper	5	23	133	MK1 B	6	-5
	6	26	138	MK1 B	6	-6
	7	31	150	MK1 B	6	-7
	8	33	156	MK1 B	6	-8
	9	36	162	MK1 B	6	-9
	10	38	168	MK1 B	6	-10
	11	41	175	MK1 B	6	-11
	12	44	182	MK1 B	6	-12
	13	44	182	MK1 B	6	-13
	14	47	189	MK1 B	8	-14
	15	50	204	MK2 B	8	-15
	16	52	210	MK2 B	8	-16
	21	62	232	MK2 B	6	-21
	22	64	237	MK2 B	6	-22
	23	66	241	MK2 B	6	-23
	24	68	268	MK3 B	8	-24
	25	68	268	MK3 B	8	-25
	26	70	273	MK3 B	8	-26
	27	71	277	MK3 B	8	-27
	28	71	277	MK3 B	8	-28
	30	73	281	MK3 B	8	-30
	32	77	317	MK4 B	8	-32

Dia. 5 to Ø 7: dimensions in acc. with DIN 208 form A

Dia. 8 to Ø 32: dimensions in acc. with DIN 8094 form A

Carbide machine reamers, taper shank

F4171

H7

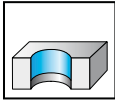

- K10 - uncoated
- Form B
- right handed - spiral flute
- differential pitch
- solid carbide up to Ø 16, carbide tipped above Ø 16

	P	M	K	N	S	H	O
uncoated	●	●	●	●	●	●	●

	D _c mm	L _c mm	l ₁ mm	MK	Z	Designation F4171
Morse taper	5	23	133	MK1 B	6	-5
	6	26	138	MK1 B	6	-6
	7	31	150	MK1 B	6	-7
	8	33	156	MK1 B	6	-8
	9	36	162	MK1 B	6	-9
	10	38	168	MK1 B	6	-10
	11	41	175	MK1 B	6	-11
	12	44	182	MK1 B	6	-12
	13	44	182	MK1 B	6	-13
	14	47	189	MK1 B	6	-14
	15	50	204	MK2 B	6	-15
	16	52	210	MK2 B	6	-16
	17	54	214	MK2 B	6	-17
	18	56	219	MK2 B	6	-18
	19	58	223	MK2 B	6	-19
	20	60	228	MK2 B	6	-20

Dia. 5 to Ø 7: dimensions in acc. with DIN 208 form B

Dia. 8 to Ø 20: dimensions in acc. with DIN 8094 form B

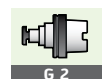

Bridge reamers, taper shank F4535 1:10

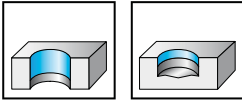

- HSS - uncoated
- right handed - spiral flute
- long chamfer

	P	M	K	N	S	H	O
uncoated	●●	●	●●	●●	●	●	●●

DIN 311	D _c k11 mm	d ₃ mm	L _c mm	l ₁ mm	l ₁₅ mm	MK	Z	Designation F4535
Morse taper	6,4	4,6	75	151	19	MK1 B	3	-6.4
	7,4	5,3	80	156	22	MK1 B	3	-7.4
	8,4	6	85	161	25	MK1 B	3	-8.4
	9,5	6,9	90	166	27	MK1 B	4	-9.5
	10	7,1	95	171	30	MK1 B	4	-10
	11	7,8	100	176	33	MK1 B	4	-11
	12	8,2	105	199	39	MK2 B	4	-12
	13	9,2	105	199	39	MK2 B	4	-13
	14	9,9	115	209	42	MK2 B	4	-14
	15	10,6	125	219	45	MK2 B	4	-15
	16	11,4	135	229	48	MK2 B	5	-16
	17	12,1	135	251	51	MK3 B	5	-17
	18	12,4	145	261	58	MK3 B	5	-18
	19	13,4	145	261	58	MK3 B	5	-19
	20	14	155	271	62	MK3 B	5	-20
	21	15	155	271	62	MK3 B	5	-21
	22	15,6	165	281	66	MK3 B	5	-22
	23	16,6	165	281	66	MK3 B	5	-23
	24	17	180	296	72	MK3 B	5	-24
	25	18	180	296	72	MK3 B	5	-25
	26	19	180	296	72	MK3 B	5	-26
	27	19,4	195	311	78	MK3 B	5	-27
	28	20,4	195	311	78	MK3 B	5	-28
	29	21,4	195	311	78	MK3 B	5	-29
	30	22,4	195	311	78	MK3 B	5	-30
	31	22,4	210	326	84	MK3 B	5	-31
	32	23,8	210	354	84	MK4 B	5	-32

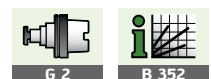
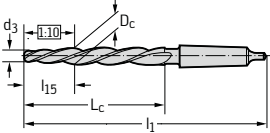

Taper pin reamers, taper shank, quick spiral

F6134

1:50

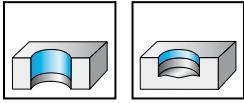

- HSS-E - uncoated
- right handed - spiral flute
- for tapered pins in accordance with DIN 258; 1447; 7977; 7978
- for tapered pins in accordance with DIN EN 28736; 28737; 28744

	P	M	K	N	S	H	O
uncoated	●●		●●	●●			●●

DIN 2180

Morse taper

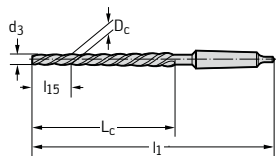

D_c mm	d_3 mm	L_c mm	l_1 mm	l_{15} mm	MK	Z	Designation F6134
5	4,9	73	155	5	MK1 B	3	-5
6	5,9	105	187	5	MK1 B	3	-6
8	7,9	145	227	5	MK1 B	3	-8
10	9,9	175	257	5	MK1 B	3	-10
12	11,8	210	315	10	MK2 B	3	-12
16	15,8	230	335	10	MK2 B	3	-16
20	19,8	250	377	10	MK3 B	3	-20

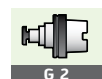

G 2



B 352

Shell reamers F7133 H7

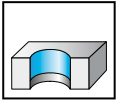

- HSS-E - uncoated
- Form B
- right handed - spiral flute

	P	M	K	N	S	H	O
uncoated	●●		●●	●●			●●

DIN 219	D _c mm	d ₁ mm	l ₁ mm	Z	Designation F7133
Locating bore 1:30	25	13	45	8	-25
	26	13	45	8	-26
	27	13	45	8	-27
	28	13	45	8	-28
	29	13	45	8	-29
	30	13	45	8	-30
	31	16	50	10	-31
	32	16	50	10	-32
	33	16	50	10	-33
	34	16	50	10	-34
	35	16	50	10	-35
	36	19	56	10	-36
	37	19	56	10	-37
	38	19	56	10	-38
	39	19	56	10	-39
	40	19	56	10	-40
	42	19	56	10	-42
	44	22	63	12	-44
	45	22	63	12	-45
	46	22	63	12	-46
	47	22	63	12	-47
	48	22	63	12	-48
	50	22	63	12	-50
	52	27	71	12	-52
	55	27	71	12	-55
	58	27	71	12	-58
	60	27	71	12	-60

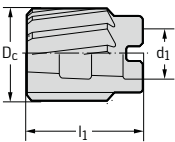

Twist drill A1211 – set Z3213

8 x D_c

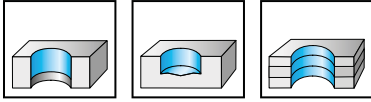

- HSS - steam treated
- Type N
- right-hand cutting
- 118° point angle
- up to 3 mm bright finish
- Ø 1.0 - 6.0 mm
- 0.1 mm increments



DIN 338

	Sets Ø mm	Lead	Quantity	Designation
Cylindrical shank	1,0 - 6,0	0,1	51	Z3213-1-6

(The dimensions for twist drill A1211 can be found on page B 171)

Twist drill A1211 – set Z3216

8 x D_c

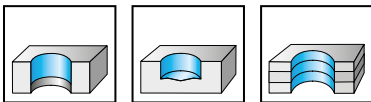

- HSS - steam treated
- Type N
- right-hand cutting
- 118° point angle
- Ø 6.0 - 10.0 mm
- 0.1 mm increments



DIN 338

	Sets Ø mm	Lead	Quantity	Designation
Cylindrical shank	6,0 - 10,0	0,1	41	Z3216-6-10

(The dimensions for twist drill A1211 can be found on page B 171)



Twist drill A1211 – set Z3218

8 x D_C

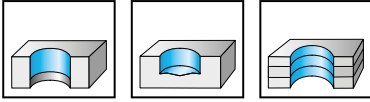

- HSS - steam treated
- Type N
- right-hand cutting
- 118° point angle
- up to 3 mm bright finish
- Ø 1.0 - 10.5 plus Ø 3.3 / 4.2 / 6.8 / 10.2 mm
- 0.5 mm increments



DIN 338	Sets Ø mm	including core-hole drill	Lead	Quantity	Designation
Cylindrical shank	1,0 - 10,5	3,3	0,5	24	Z3218-1-10.5
		4,2			
		6,8			
		10,2			

(The dimensions for twist drill A1211 can be found on page B 171)

Twist drill A1211TIN – set Z3218TIN

8 x D_C

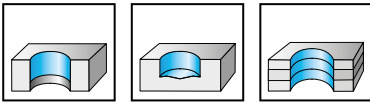

- HSS - TiN
- Type N
- right-hand cutting
- 118° point angle
- Ø 1.0 - 10.5 plus Ø 3.3 / 4.2 / 6.8 / 10.2 mm
- 0.5 mm increments



DIN 338	Sets Ø mm	including core-hole drill	Lead	Quantity	Designation
Cylindrical shank	1,0 - 10,5	3,3	0,5	24	Z3218TIN-1-10.5
		4,2			
		6,8			
		10,2			

(The dimensions for twist drill A1211TIN can be found on page B 180)

Twist drill A1211 – set Z3219

8 x D_c

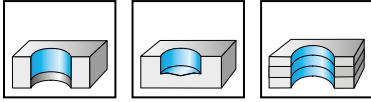

- HSS - steam treated
- Type N
- right-hand cutting
- 118° point angle
- up to 3 mm bright finish
- Ø 1.0 - 13.0 mm
- 0.5 mm increments



DIN 338

	Sets Ø mm	Lead	Quantity	Designation
Cylindrical shank	1,0 - 13,0	0,5	25	Z3219-1-13

(The dimensions for twist drill A1211 can be found on page B 171)

Twist drill A1211TiN – set Z3219TiN

8 x D_c

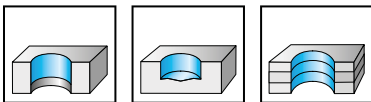

- HSS - TiN
- Type N
- right-hand cutting
- 118° point angle
- Ø 1.0 - 13.0 mm
- 0.5 mm increments



DIN 338

	Sets Ø mm	Lead	Quantity	Designation
Cylindrical shank	1,0 - 13,0	0,5	25	Z3219TiN-1-13

(The dimensions for twist drill A1211TiN can be found on page B 180)



Twist drill A1244 – set Z3515

8 x D_C

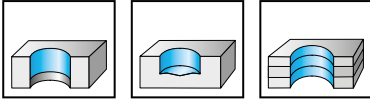

- HSS-E - uncoated
- Type VA
- right-hand cutting
- 130° point angle
- Ø 1.0 - 10.5 plus Ø 3.3 / 4.2 / 6.8 / 10.2 mm
- 0.5 mm increments



DIN 338	Sets Ø mm	including core-hole drill	Lead	Quantity	Designation
Cylindrical shank	1,0 - 10,5	3,3	0,5	24	Z3515-1-10.5
		4,2			
		6,8			
		10,2			

(The dimensions for twist drill A1244 can be found on page B 199)

Twist drill A1244 – set Z3516

8 x D_C

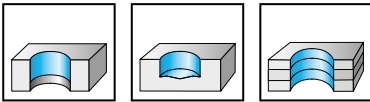

- HSS-E - uncoated
- Type VA
- right-hand cutting
- 130° point angle
- Ø 1.0 - 13.0
- 0.5 mm increments



DIN 338	Sets Ø mm	Lead	Quantity	Designation
Cylindrical shank	1,0 - 13,0	0,5	25	Z3516-1-13

(The dimensions for twist drill A1244 can be found on page B 199)

Twist drill A1222 – set Z3518

8 x D_C

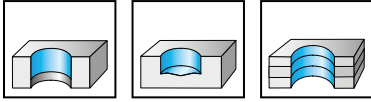

- HSS - fibre-steamed
- Type UFL®
- right-hand cutting
- 130° point angle
- up to 1.9 mm bright finish
- Ø 1.0 - 10.5 plus Ø 3.3 / 4.2 / 6.8 / 10.2 mm
- 0.5 mm increments



DIN 338	Sets Ø mm	including core-hole drill	Lead	Quantity	Designation
Cylindrical shank	1,0 - 10,5	3,3	0,5	24	Z3518-1-10.5
		4,2			
		6,8			
		10,2			

(The dimensions for twist drill A1222 can be found on page B 185)

Countersinks 90°-E6819TIN – set Z3711TIN

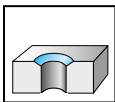

- HSS - TiN
- Form C
- right-hand cutting
- 90° countersink angle
- Ø 6.3 - 20.5 mm



DIN 335 Form C	Biggest countersink Ø mm	Smallest countersink Ø mm	Designation
Cylindrical shank	6,3	1,5	Z3711TIN-6.3-20.5
	8,3	2,0	
	10,4	2,5	
	12,4	2,8	
	16,5	3,2	
	20,5	3,5	

(The dimensions for countersink drill E6819TIN can be found on page B 289)



Cutting data for solid carbide drills with internal cooling

Material group	= cutting data for wet machining = dry machining is possible, cutting data must be selected from TEC E = Emulsion O = Oil M = MQL L = dry v _c = cutting speed V _{CRR} = v _c rating chart from page B 382 V _{RR} = feed rating chart from page B 384			Drilling depth				3 x D _c						
				Designation				A3289DPL		A3285TFL A3885TFL				
				Type				X-treme Plus		Alpha® 4				
				Dimensions				DIN 6537 K		DIN 6537 K				
Workpiece material			Brinell hardness HB	Tensile strength R _m N/mm ²	Machining group ¹	v _c		VRR		v _c		VRR		
						E O M L		E O M L		E O M L		E O M L		
P	Non-alloyed steel	C ≤ 0.25 %	annealed	125	428	P1	200	16	E O M L	120	12	E O M L		
		C > 0.25... ≤ 0.55 %	annealed	190	639	P2	180	12	E O M L	105	12	E O M L		
		C > 0.25... ≤ 0.55 %	tempered	210	708	P3	170	12	E O M L	100	12	E O M L		
		C > 0.55 %	annealed	190	639	P4	180	12	E O M L	105	12	E O M L		
		C > 0.55 %	tempered	300	1013	P5	140	12	E O M L	75	9	E O M L		
	Low alloy steel	High-alloyed steel and high-alloyed tool steel	machining steel (short-chipping)	annealed	220	745	P6	200	16	E O M L	120	12	E O M L	
			annealed	175	591	P7	180	12	E O M L	105	12	E O M L		
			tempered	300	1013	P8	140	12	E O M L	75	9	E O M L		
			tempered	380	1282	P9	100	8	O E	50	6	O E		
			tempered	430	1477	P10	80	6	O E	42	4	O E		
		Stainless steel	annealed	200	675	P11	85	9	E O	67	9	E O		
			hardened and tempered	300	1013	P12	120	10	E O	60	7	E O		
			hardened and tempered	400	1361	P13	80	6	O E	42	4	O E		
			ferritic/martensitic, annealed	200	675	P14	85	9	E O	67	9	E O		
			martensitic, tempered	330	1114	P15	50	9	E O	42	7	E O		
M	Stainless steel	austenitic, quench hardened		200	675	M1	50	6	E O	42	5	E O		
		austenitic, precipitation hardened (PH)		300	1013	M2	63	6	E O	56	6	E O		
		austenitic/ferritic, duplex		230	778	M3	40	6	E O	34	5	E O		
K	Malleable cast iron	ferritic		200	675	K1	130	20	E O M L	100	16	E O M L		
		pearlitic		260	867	K2	120	16	E O M L	75	16	E O M L		
	grey cast iron	low tensile strength		180	602	K3	160	20	E O M L	120	16	E O M L		
		high tensile strength/austenitic		245	825	K4	130	20	E O M L	100	16	E O M L		
	Cast iron with spheroidal graphite	ferritic		155	518	K5	150	16	E M L	100	16	E O M L		
		pearlitic		265	885	K6	120	16	E O M L	75	16	E O M L		
	GGV (CGI)		200	675	K7	140	16	O E M L	90	16	E O M L			
N	Aluminium wrought alloys	cannot be hardened		30	-	N1	450	16	E O M					
		hardenable, hardened		100	343	N2	450	16	E O M					
	Cast aluminium alloys	≤ 12 % Si, not precipitation hardenable		75	260	N3	320	16	E O M	250	16	E O M		
		≤ 12 % Si, precipitation hardenable, precipitation hardened		90	314	N4	300	16	E O M	240	16	E O M		
		> 12 % Si, not precipitation hardenable		130	447	N5	250	16	E O M	190	16	E O M		
	Magnesium alloys		70	250	N6	300	16	M L	240	16	M L			
	Copper and copper alloys (bronze/brass)	non-alloyed, electrolytic copper		100	343	N7	280	12	E O M	210	9	E O M		
brass, bronze, red brass			90	314	N8	240	16	E O	180	12	E O			
Cu-alloys, short-chipping			110	382	N9	260	20	E O M	190	16	E O M			
high-strength, Ampco			300	1013	N10	120	10	E O	60	7	E O			
S	Heat-resistant alloys	Fe-based	annealed	200	675	S1	50	6	E O	42	5	E O		
			hardened	280	943	S2	38	5	O E	26	4	O E		
		Ni or Co base	annealed	250	839	S3	42	5	E O	32	4	E O		
			hardened	350	1177	S4	26	4	O E	16	3	O E		
			cast	320	1076	S5	32	4	O E	20	3	O E		
	Titanium alloys	pure titanium		200	675	S6	71	6	O E	56	6	O E		
		α and β alloys, hardened		375	1262	S7	63	5	O E	48	5	O E		
β alloys			410	1396	S8	20	4	O E	12	3	O E			
Tungsten alloys		300	1013	S9	120	10	E O	60	7	E O				
Molybdenum alloys		300	1013	S10	120	10	E O	60	7	E O				
H	Hardened steel	hardened and tempered		50 HRC	-	H1	53	4	O E	36	3	O E		
		hardened and tempered		55 HRC	-	H2	45	4	O E	31	3	O E		
		hardened and tempered		60 HRC	-	H3								
Hardened cast iron		55 HRC	-	H4	45	4	O E	31	3	O E				
O	Thermoplasts	without abrasive fillers				O1	130	16	E O					
	Thermosetting plastics	without abrasive fillers				O2								
	Plastic, glass-fibre reinforced	GFRP				O3								
	Plastic, carbon fibre reinforced	CFRP				O4								
	Plastic, aramide fibre reinforced	AFRP				O5								
	Graphite (technical)				80 Shore		O6							

¹ The machining groups are assigned from page H 8 onwards.

The specified cutting data are recommended values. For specific applications, adjustment is recommended.

		5 x D _c												8 x D _c											
		A3389DPL			A3382XPL			A3399XPL A3999XPL			A3387			A3384			A6488TML			A6489DPP					
		X-treme Plus			X-treme CI			X-treme			Alpha® Jet			Alpha® Ni			Alpha® 4 Plus Micro			X-treme D8					
		DIN 6537 L			DIN 6537 L			DIN 6537 L			DIN 6537 L			DIN 6537 L			Walter standard			Walter standard					
		3,00 – 20,00			3,00 – 20,00			3,00 – 25,00			4,00 – 20,00			3,00 – 12,00			0,75 – 2,95			3,00 – 20,00					
		K30F			K30F			K30F			K20F			K20F			K30F			K30F					
		DPL			XPL			XPL			uncoated			uncoated			TML			DPP					
		B 86			B 81			B 89/B 112			B 85			B 84			B 121			B 123					
		v _c VRR		v _c VRR		v _c VRR		v _c VRR		v _c VRR		v _c VRR		v _c VRR		VCRR VRR		v _c VRR		v _c VRR		v _c VRR			
190	12	EO	ML					120	10	EO	ML						C80	10	E		180	12	EO	ML	
170	12	EO	ML					100	10	EO	ML						C80	10	E		160	12	EO	ML	
160	12	EO	ML					95	10	EO	ML						C71	10	E		150	12	EO	ML	
170	12	EO	ML					100	10	EO	ML						C80	10	E		160	12	EO	ML	
130	12	EO	ML					71	8	EO	ML						C56	8	E		125	10	EO	ML	
190	16	EO	ML					120	12	EO	ML						C80	10	E		180	12	EO	ML	
170	12	EO	ML					100	10	EO	ML						C80	10	E		160	12	EO	ML	
130	12	EO	ML					71	8	EO	ML						C56	8	E		125	10	EO	ML	
95	8	OE						48	6	OE							C42	6	E		85	7	OE		
71	6	OE						38	4	OE				50	5	OE	C32	5	E		63	5	OE		
85	9	EO						63	8	EO							C50	8	E		80	8	EO		
120	10	EO						56	7	EO							C50	6	E		110	9	EO		
71	6	OE						38	4	OE				50	5	OE	C32	5	E		63	5	OE		
85	9	EO						63	8	EO							C50	8	E		80	8	EO		
48	9	EO						42	7	EO							C32	7	E		45	8	EO		
48	6	EO						42	5	EO							C32	6	E		45	6	EO		
60	6	EO						53	6	EO							C40	5	E		56	6	EO		
38	6	EO						34	5	EO							C20	4	E		36	6	EO		
125	16	EO	ML	130	20	EO	ML	95	16	EO	ML	100	10	EO			C80	12	E		120	12	EO	ML	
120	16	EO	ML	120	16	EO	ML	71	12	EO	ML	75	10	EO			C80	12	E		110	12	EO	ML	
150	16	EO	ML	160	20	EO	ML	120	16	EO	ML	125	10	EO	ML			C80	13	E		140	12	EO	ML
125	16	EO	ML	130	20	EO	ML	95	16	EO	ML	100	10	EO	ML			C80	10	E		120	12	EO	ML
140	16	E	ML	160	20	EO	ML	95	16	EO	ML	100	6	EO				C80	13	E		140	12	EO	ML
120	16	EO	ML	120	16	EO	ML	71	12	EO	ML							C63	10	E		110	12	EO	ML
130	16	OE	ML	140	20	EO	ML	85	16	EO	ML	75	10	EO				C71	12	E		125	12	EO	ML
450	16	EO	M					400	16	EO	M	400	9	EO				C125	17	E		450	16	EO	M
450	16	EO	M					400	16	EO	M	400	9	EO				C125	17	E		450	16	EO	M
320	16	EO	M					250	16	EO	M	260	9	EO				C125	17	E		320	16	EO	M
300	16	EO	M					240	16	EO	M	240	9	EO				C100	15	E		300	16	EO	M
250	16	EO	M					190	16	EO	M	200	9	EO				C100	13	E		250	16	EO	M
300	16		ML					240	16		ML	240	9		ML						300	16		ML	
240	10	EO	M					180	8	EO	M							C63	5	E		200	9	EO	M
200	12	EO						150	10	EO								C63	7	E		170	12	EO	
260	20	EO	M					190	16	EO	M	210	16	EO				C80	11	E		260	20	EO	M
120	10	EO						56	7	EO								C40	4	E		110	9	EO	
48	6	EO						42	5	EO								C32	6	E		45	6	EO	
36	5	OE						24	4	OE				28	5	OE	C16	5	E		32	5	OE		
40	5	EO						30	4	EO								C20	5	E		38	5	EO	
24	4	OE						15	3	OE				20	5	OE	C12	4	E		21	4	OE		
30	4	OE						18	3	OE				24	4	OE	C12	4	E		26	4	OE		
60	6	OE						48	6	OE								C40	5	E		50	5	OE	
53	5	OE						40	5	OE				53	5	OE	C25	4	E		45	5	OE		
18	4	OE						11	3	OE				16	5	OE	C12	4	E		16	4	OE		
120	10	EO						56	7	EO								C40	4	E		110	9	EO	
120	10	EO						56	7	EO								C40	4	E		110	9	EO	
53	4	OE						30	3	OE				32	4	OE	C25	2	E		45	3	OE		
45	4	OE						26	3	OE				32	4	OE	C25	2	E		38	3	OE		
45	4	OE						26	3	OE				32	4	OE	C25	2	E		38	3	OE		
130	16	EO		130	16	EO						80	8	EO				C100	20	E		130	16	EO	
				130	16	L						130	16	L							50	5	L		
																					50	5	L		
																					50	5	L		
												30	5	L							30	5	L		

Cutting data for solid carbide drills with internal cooling

= cutting data for wet machining = dry machining is possible, cutting data must be selected from TEC E = Emulsion O = Oil M = MQL L = dry v _c = cutting speed V _{CR} = v _c rating chart from page B 382 V _{RR} = feed rating chart from page B 384			Drilling depth			8 x D _c						
			Designation	A3487			A3486TIP A3586TIP					
Material group Grouping of main material groups and identification letters Workpiece material			Type	Alpha® Jet			Alpha® 44					
			Dimensions	Walter standard			Walter standard					
			Dia. range (mm)	5,00 – 20,00			5,00 – 12,00					
			Cutting tool material	K20F			K30F					
			Coating	uncoated			TIP					
			Page	B 95			B 94/B 96					
			Brinell hardness HB	Tensile strength R _m N/mm ²	Machining group ¹							
			v _c	V _{RR}		v _c	V _{RR}		v _c	V _{RR}		
P	Non-alloyed steel	C ≤ 0.25 %	annealed	125	428	P1				95	9	EO
		C > 0.25... ≤ 0.55 %	annealed	190	639	P2				90	9	EO
		C > 0.25... ≤ 0.55 %	tempered	210	708	P3				80	9	EO
		C > 0.55 %	annealed	190	639	P4				90	9	EO
		C > 0.55 %	tempered	300	1013	P5				60	7	EO
	Low alloy steel	machining steel (short-chipping)	annealed	220	745	P6				95	10	EO
			annealed	175	591	P7				90	9	EO
			tempered	300	1013	P8				60	7	EO
			tempered	380	1282	P9						
		High-alloyed steel and high-alloyed tool steel	annealed	200	675	P11				50	6	EO
			hardened and tempered	300	1013	P12				45	5	EO
		Stainless steel	hardened and tempered	400	1361	P13						
			ferritic/martensitic, annealed	200	675	P14				50	6	EO
			martensitic, tempered	330	1114	P15				32	5	EO
		M	Stainless steel	austenitic, quench hardened	200	675	M1				32	4
austenitic, precipitation hardened (PH)	300			1013	M2				42	4	EO	
austenitic/ferritic, duplex	230			778	M3				26	4	EO	
K	Malleable cast iron	ferritic	200	675	K1	85	9	EO	80	12	EO	
		pearlitic	260	867	K2	63	9	EO	60	12	EO	
	grey cast iron	low tensile strength	180	602	K3	105	9	EO	M L	90	12	EO
		high tensile strength/austenitic	245	825	K4	85	9	EO	M L	80	12	EO
	Cast iron with spheroidal graphite	ferritic	155	518	K5				80	12	EO	
		pearlitic	265	885	K6				56	10	EO	
	GGV (CGI)		200	675	K7				67	12	EO	
N	Aluminium wrought alloys	cannot be hardened	30	–	N1	400	9	EO	320	10	EO	
		hardenable, hardened	100	343	N2	400	9	EO	320	10	EO	
	Cast aluminium alloys	≤ 12 % Si, not precipitation hardenable	75	260	N3	260	9	EO	220	10	EO	
		≤ 12 % Si, precipitation hardenable, precipitation hardened	90	314	N4	240	9	EO	200	10	EO	
		> 12 % Si, not precipitation hardenable	130	447	N5	200	9	EO	160	10	EO	
	Magnesium alloys		70	250	N6	240	9		M L	200	10	M L
	Copper and copper alloys (bronze/brass)	non-alloyed, electrolytic copper	100	343	N7				160	5	EO	
brass, bronze, red brass		90	314	N8				105	8	EO		
Cu-alloys, short-chipping		110	382	N9	210	16	EO	140	12	EO		
high-strength, Ampco		300	1013	N10				45	5	EO		
S	Heat-resistant alloys	Fe-based	annealed	200	675	S1				32	4	EO
			hardened	280	943	S2						
		Ni or Co base	annealed	250	839	S3				20	3	EO
			hardened	350	1177	S4						
			cast	320	1076	S5						
	Titanium alloys	pure titanium	200	675	S6				38	4	OE	
		α and β alloys, hardened	375	1262	S7				32	3	OE	
		β alloys	410	1396	S8							
Tungsten alloys		300	1013	S9				45	5	EO		
Molybdenum alloys		300	1013	S10				45	5	EO		
H	Hardened steel	hardened and tempered	50 HRC	–	H1							
		hardened and tempered	55 HRC	–	H2							
		hardened and tempered	60 HRC	–	H3							
	Hardened cast iron	hardened and tempered	55 HRC	–	H4							
O	Thermoplasts	without abrasive fillers			O1	80	8	EO	100	16	EO	
	Thermosetting plastics	without abrasive fillers			O2	130	16		L			
	Plastic, glass-fibre reinforced	GFRP			O3							
	Plastic, carbon fibre reinforced	CFRP			O4							
	Plastic, aramide fibre reinforced	AFRP			O5							
	Graphite (technical)		80 Shore		O6	30	5		L			

¹ The machining groups are assigned from page H 8 onwards.

The specified cutting data are recommended values.
For specific applications, adjustment is recommended.

		12 x D _c						16 x D _c						20 x D _c													
		A6588TML		A6589DPP		A3687		A6685TFP		A6789AMP		A6794TFP		A6785TFP													
		Alpha® 4 Plus Micro		X-treme D12		Alpha® Jet		Alpha® 4 XD16		X-treme DM20		X-treme DH20		Alpha® 4 XD20													
		Walter standard		Walter standard		Walter standard		Walter standard		Walter standard		Walter standard		Walter standard													
		1,00 – 2,90		3,00 – 20,00		5,00 – 20,00		3,00 – 16,00		2,00 – 2,90		3,00 – 10,00		3,00 – 16,00													
		K30F		K30F		K20F		K30F		K30F		K30F		K30F													
		TML		DPP		uncoated		TFP		AMP		TFP		TFP													
		B 126		B 127		B 97		B 130		B 132		B 133		B 131													
		VCRR VRR		v _c VRR		v _c VRR		v _c VRR		VCRR VRR		v _c VRR		v _c VRR													
C63	10	E		170	12	EO	ML			110	10	EO	ML	C80	10	E				105	10	EO	ML				
C63	10	E		150	12	EO	ML			95	10	EO	ML	C63	10	E							90	10	EO	ML	
C63	10	E		140	12	EO	ML			90	10	EO	ML	C71	10	E								85	10	EO	ML
C63	10	E		150	12	EO	ML			95	10	EO	ML	C63	10	E								90	10	EO	ML
C53	8	E		120	10	EO	ML			67	9	EO	ML	C50	8	E			63	8	EO	ML		63	8	EO	ML
C70	10	E		170	12	EO	ML			110	12	EO	ML	C80	10	E								105	10	EO	ML
C63	10	E		150	12	EO	ML			95	10	EO	ML	C63	10	E								90	10	EO	ML
C53	8	E		120	10	EO	ML			67	9	EO	ML	C50	8	E			63	8	EO	ML		63	8	EO	ML
C36	6	E		80	7	OE				42	7	OE		C36	5	E			40	7	OE	ML		40	7	OE	
C32	5	E		56	5	OE				28	6	OE		C32	5	E			25	6	OE			25	6	OE	
C50	8	E		75	8	EO				60	8	EO		C50	9	E			56	7	EO			56	8	EO	
C40	6	E		105	9	EO				56	8	EO		C40	5	E			53	7	EO	ML		53	7	EO	
C32	5	E		56	5	OE				28	6	OE		C32	5	E			25	6	OE			25	6	OE	
C50	8	E		75	8	EO				60	8	EO		C50	9	E			56	7	EO			56	8	EO	
C32	7	E		42	8	EO				40	7	EO		C40	8	E			36	6	EO			36	6	EO	
C32	6	E		42	6	EO				40	5	OE		C32	6	E								36	5	OE	
C32	4	E		56	6	EO				50	5	EO		C32	4	E			48	5	EO			48	5	EO	
C16	4	E		34	6	EO				32	5	OE		C25	4	E								29	5	OE	
C80	12	E		110	12	EO	ML	80	8	EO			90	16	EO	ML	C63	8	E					85	12	EO	ML
C80	11	E		83	12	EO	ML	60	8	EO			67	12	EO	ML	C63	8	E					63	12	EO	ML
C80	11	E		130	12	EO	ML	100	8	EO	ML		110	16	EO	ML	C80	8	E					105	12	EO	ML
C63	8	E		110	12	EO	ML	80	8	EO	ML		90	16	EO	ML	C63	8	E					85	12	EO	ML
C63	11	E		130	12	EO	ML			90	16	EO	ML	C63	8	E								85	12	EO	ML
C50	9	E		105	12	EO	ML			67	12	EO	ML	C50	8	E			63	12	EO	ML		63	12	EO	ML
C67	12	E		120	12	EO	ML			80	16	EO	ML	C63	9	E			71	12	OE	ML		75	12	EO	ML
C100	16	E		420	16	EO	M	380	9	EO			130	16	EO	M	C125	22	E					105	16	EO	M
C100	16	E		420	16	EO	M	380	9	EO			130	16	EO	M	C125	22	E					105	16	EO	M
C100	16	E		320	16	EO	M	250	9	EO			130	16	EO	M	C125	20	E					105	16	EO	M
C100	13	E		280	16	EO	M	240	9	EO			130	16	EO	M	C125	20	E					105	16	EO	M
C100	12	E		240	16	EO	M	190	9	EO			130	16	EO	M	C100	17	E					105	16	EO	M
				280	16	ML		240	9				130	16	ML									105	16	ML	
C63	5	E		190	8	EO	M			110	7	EO	M	C63	5	E								105	7	EO	M
C63	7	E		160	10	EO				90	9	EO		C63	10	E								85	9	EO	
C80	10	E		250	20	EO	M	200	16	EO			110	10	EO	M	C80	17	E					105	10	EO	M
C40	3	E		105	9	EO				56	8	EO		C45	6	E			53	7	EO	M		53	7	EO	
C32	5	E		42	6	EO				40	5	OE		C32	6	E								36	5	OE	
C16	4	E		30	4	OE				24	4	OE		C21	5	E			16	3	OE			21	3	OE	
C20	4	E		36	5	EO				30	4	EO		C25	4	E								28	3	EO	
C12	3	E		18	3	OE				13	3	OE		C14	5	E			12	3	OE			12	3	OE	
C12	4	E		22	3	OE				16	3	OE		C14	5	E			15	3	OE			15	3	OE	
C32	5	E		45	5	OE				36	5	OE		C40	5	E								34	5	OE	
C25	4	E		40	4	OE				24	5	OE		C25	4	E								21	4	OE	
C12	3	E		14	3	OE				9,5	3	OE		C14	4	E			9	3	OE			9	3	OE	
C40	3	E		105	9	EO				56	8	EO		C45	7	E			53	7	EO	M		53	7	EO	
C40	3	E		105	9	EO				56	8	EO		C45	7	E			53	7	EO	M		53	7	EO	
C20	2	E		38	3	OE				22	2	OE		C25	3	E			21	2	OE			21	2	OE	
C20	2	E		32	3	OE								C25	3	E											
C20	2	E		32	3	OE								C25	3	E											
C80	18	E		125	16	EO		75	8	EO			90	16	EO									85	12	EO	
								130	16	L																	
								30	5	L																	

Cutting data for solid carbide drills with internal cooling

Material group	= = cutting data for wet machining = = dry machining is possible, cutting data must be selected from TEC E = emulsion O = oil M = MQL L = dry v _c = cutting speed VCRR = v _c rating chart from page B 382 VRR = feed rating chart from page B 384			Drilling depth			25 x D _c						
				Designation			A6889AMP			A6885TFP			
				Type			X-treme DM25			Alpha® 4 XD25			
				Dimensions			Walter standard			Walter standard			
Dia. range (mm)			2,50 – 2,90			3,00 – 12,00							
Cutting tool material			K30F			K30F							
Coating			AMP			TFP							
Page			B 135			B 134							
Grouping of main material groups and identification letters			Brinell hardness HB	Tensile strength R _m N/mm ²	Machining group ¹								
Workpiece material						VCRR	VRR	v _c	VRR				
P	Non-alloyed steel	C ≤ 0.25 %	annealed	125	428	P1	C80	10	E	95	9	EO	ML
		C > 0.25... ≤ 0.55 %	annealed	190	639	P2	C63	10	E	85	9	EO	ML
		C > 0.25... ≤ 0.55 %	tempered	210	708	P3	C63	10	E	80	9	EO	ML
		C > 0.55 %	annealed	190	639	P4	C63	10	E	85	9	EO	ML
		C > 0.55 %	tempered	300	1013	P5	C50	8	E	60	8	EO	ML
	machining steel (short-chipping)	annealed	220	745	P6	C80	10	E	95	10	EO	ML	
	Low alloy steel	annealed	175	591	P7	C63	10	E	85	9	EO	ML	
		tempered	300	1013	P8	C50	8	E	60	8	EO	ML	
		tempered	380	1282	P9	C36	5	E	36	6	OE		
		tempered	430	1477	P10	C32	5	E	24	5	OE		
	High-alloyed steel and high-alloyed tool steel	annealed	200	675	P11	C50	9	E	53	7	EO		
		hardened and tempered	300	1013	P12	C40	5	E	48	7	EO		
		hardened and tempered	400	1361	P13	C32	5	E	24	5	OE		
	Stainless steel	ferritic/martensitic, annealed	200	675	P14	C50	9	E	53	7	EO		
		martensitic, tempered	330	1114	P15	C40	8	E	34	6	EO		
M	Stainless steel	austenitic, quench hardened		200	675	M1	C32	6	E	34	4	OE	
		austenitic, precipitation hardened (PH)		300	1013	M2	C32	4	E	45	5	EO	
		austenitic/ferritic, duplex		230	778	M3	C25	4	E	27	4	OE	
K	Malleable cast iron	ferritic		200	675	K1	C63	8	E	80	12	EO	ML
		pearlitic		260	867	K2	C63	8	E	60	12	EO	ML
	grey cast iron	low tensile strength		180	602	K3	C80	8	E	95	12	EO	ML
		high tensile strength/austenitic		245	825	K4	C63	8	E	80	12	EO	ML
	Cast iron with spheroidal graphite	ferritic		155	518	K5	C63	8	E	80	12	EO	ML
		pearlitic		265	885	K6	C50	8	E	60	12	EO	ML
GGV (CGI)			200	675	K7	C63	9	E	71	12	EO	ML	
N	Aluminium wrought alloys	cannot be hardened		30	–	N1	C125	22	E	80	16	EO	M
		hardenable, hardened		100	343	N2	C125	22	E	80	16	EO	M
	Cast aluminium alloys	≤ 12 % Si, not precipitation hardenable		75	260	N3	C125	20	E	80	16	EO	M
		≤ 12 % Si, precipitation hardenable, precipitation hardened		90	314	N4	C125	20	E	80	16	EO	M
		> 12 % Si, not precipitation hardenable		130	447	N5	C100	17	E	80	12	EO	M
	Magnesium alloys			70	250	N6				80	16	ML	
	Copper and copper alloys (bronze/brass)	non-alloyed, electrolytic copper		100	343	N7	C63	5	E	95	6	EO	M
brass, bronze, red brass			90	314	N8	C63	10	E	80	8	EO		
Cu-alloys, short-chipping			110	382	N9	C80	17	E	95	10	EO	M	
high-strength, Ampco			300	1013	N10	C45	6	E	48	7	EO		
S	Heat-resistant alloys	Fe-based	annealed	200	675	S1	C32	6	E	34	4	OE	
			hardened	280	943	S2	C19	5	E	20	3	OE	
		Ni or Co base	annealed	250	839	S3	C25	4	E	26	3	EO	
			hardened	350	1177	S4	C14	5	E	11	2	OE	
			cast	320	1076	S5	C14	5	E	14	2	OE	
	Titanium alloys	pure titanium		200	675	S6	C40	5	E	32	5	OE	
		α and β alloys, hardened		375	1262	S7	C25	4	E	19	4	OE	
β alloys			410	1396	S8	C14	4	E	8,5	2	OE		
Tungsten alloys			300	1013	S9	C45	7	E	48	7	EO		
Molybdenum alloys			300	1013	S10	C45	7	E	48	7	EO		
H	Hardened steel	hardened and tempered		50 HRC	–	H1	C25	3	E	20	2	OE	
		hardened and tempered		55 HRC	–	H2	C25	3	E				
		hardened and tempered		60 HRC	–	H3							
	Hardened cast iron	hardened and tempered		55 HRC	–	H4	C25	3	E				
O	Thermoplasts	without abrasive fillers				O1	C100	20	E	80	12	EO	
	Thermosetting plastics	without abrasive fillers				O2							
	Plastic, glass-fibre reinforced	GFRP				O3							
	Plastic, carbon fibre reinforced	CFRP				O4							
	Plastic, aramide fibre reinforced	AFRP				O5							
	Graphite (technical)			80 Shore		O6							

¹ The machining groups are assigned from page H 8 onwards.

The specified cutting data are recommended values.
For specific applications, adjustment is recommended.





















				30 x D _c								Pilot drill															
				A6994TFP				A6985TFP				A6181AML				A6181TFT				A7191TFT				K5191TFT			
				X-treme DH30				Alpha® 4 XD30				X-treme Pilot 150				XD-Pilot				X-treme Pilot 180				X-treme Pilot 180C			
				Walter standard				Walter standard				Walter standard				Walter standard				Walter standard				Walter standard			
				3,00 – 10,00				3,00 – 12,00				2,00 – 2,90				3,00 – 16,00				3,00 – 10,00				4,00 – 7,00			
				K30F				K30F				K30F				K30F				K30F				K30F			
				TFP				TFP				AML				TFT				TFT				TFT			
				B 137				B 136				B 117				B 118				B 138				B 140			
				v _c		VRR		v _c		VRR		VCRR		VRR		v _c		VRR		v _c		VRR		v _c		VRR	
								95	9	EO	ML	C100	12	E		120	12	EO	ML	120	9	EO	ML	120	9	EO	ML
								85	9	EO	ML	C80	12	E		105	12	EO	ML	105	8	EO	ML	105	8	EO	ML
								80	9	EO	ML	C80	12	E		100	12	EO	ML	100	8	EO	ML	100	8	EO	ML
								85	9	EO	ML	C80	12	E		105	12	EO	ML	105	8	EO	ML	105	8	EO	ML
				60	8	EO	ML	60	8	EO	ML	C67	9	E		75	9	EO	ML	75	6	EO	ML	75	6	EO	ML
								95	10	EO	ML	C100	12	E		120	12	EO	ML	120	9	EO	ML	120	9	EO	ML
								85	9	EO	ML	C80	12	E		105	12	EO	ML	105	8	EO	ML	105	8	EO	ML
				60	8	EO	ML	60	8	EO	ML	C67	9	E		75	9	EO	ML	75	6	EO	ML	75	6	EO	ML
				36	6	OE	ML	36	6	OE		C45	6	E		50	6	OE	ML	50	4	OE	ML	50	4	OE	ML
				24	5	OE		24	5	OE		C40	6	E		42	4	OE		42	2	OE		42	2	OE	
				53	7	EO		53	7	EO		C63	10	E		67	9	EO		67	6	EO		67	6	EO	
				48	7	EO	ML	48	7	EO		C50	6	E		60	7	EO	ML	60	5	EO	ML	60	5	EO	ML
				24	5	OE		24	5	OE		C40	6	E		42	4	OE		42	2	OE		42	2	OE	
				53	7	EO		53	7	EO		C63	10	E		67	9	EO		67	6	EO		67	6	EO	
				34	6	EO		34	6	EO		C50	8	E		42	7	EO		42	5	EO		42	5	EO	
								34	4	OE		C40	8	E		42	5	EO		42	4	EO		42	4	EO	
				45	5	EO		45	5	EO		C50	6	E		56	6	EO		56	4	EO		56	4	EO	
								27	4	OE		C25	5	E		34	5	EO		34	4	EO		34	4	EO	
								80	12	EO	ML	C80	10	E		100	16	EO	ML	100	12	EO	ML	100	12	EO	ML
								60	12	EO	ML	C80	10	E		75	16	EO	ML	75	12	EO	ML	75	12	EO	ML
								95	12	EO	ML	C100	10	E		120	16	EO	ML	120	12	EO	ML	120	12	EO	ML
								80	12	EO	ML	C80	10	E		100	16	EO	ML	100	12	EO	ML	100	12	EO	ML
								80	12	EO	ML	C80	10	E		95	20	E	ML	100	12	EO	ML	100	12	EO	ML
				60	12	EO	ML	60	12	EO	ML	C63	10	E		75	16	EO	ML	75	12	EO	ML	75	12	EO	ML
				71	12	OE	ML	71	12	EO	ML	C71	10	E		85	20	OE	ML	90	12	EO	ML	90	12	EO	ML
								80	16	EO	M	C160	20	E		400	16	EO	M	400	12	EO	M	400	12	EO	M
								80	16	EO	M	C160	20	E		400	16	EO	M	400	12	EO	M	400	12	EO	M
								80	16	EO	M	C160	20	E		250	16	EO	M	250	12	EO	M	250	12	EO	M
								80	16	EO	M	C160	20	E		240	16	EO	M	240	12	EO	M	240	12	EO	M
								80	12	EO	M	C125	20	E		190	16	EO	M	190	10	EO	M	190	10	EO	M
								80	16		ML				240	16		ML	240	12		ML	240	12		ML	
								95	6	EO	M	C80	6	E		210	9	EO	M	210	6	EO	M	210	6	EO	M
								80	8	EO		C80	12	E		180	12	EO		180	8	EO		180	8	EO	
								95	10	EO	M	C100	20	E		190	16	EO	M	190	12	EO	M	190	12	EO	M
				48	7	EO	M	48	7	EO		C56	8	E		60	7	EO	M	60	5	EO	M	60	5	EO	M
								34	4	OE		C40	8	E		42	5	EO		42	4	EO		42	4	EO	
				15	2	OE		20	3	OE		C22	6	E		26	4	OE		26	3	OE		26	3	OE	
								26	3	EO		C25	5	E		32	4	EO		32	3	EO		32	3	EO	
				11	2	OE		11	2	OE		C20	6	E		16	3	OE		16	2	OE		16	2	OE	
				14	2	OE		14	2	OE		C20	6	E		20	3	OE		20	2	OE		20	2	OE	
								32	5	OE		C50	6	E		56	6	OE		56	5	OE		56	5	OE	
								19	4	OE		C32	5	E		48	5	OE		48	4	OE		48	4	OE	
				9	2	OE		8,5	2	OE		C20	5	E		12	3	OE		12	2	OE		12	2	OE	
				48	7	EO	M	48	7	EO		C56	8	E		60	7	EO	M	60	5	EO	M	60	5	EO	M
				48	7	EO	M	48	7	EO		C56	8	E		60	7	EO	M	60	5	EO	M	60	5	EO	M
				20	2	OE		20	2	OE		C40	3	E		36	3	OE		36	2	OE		36	2	OE	
												C40	3	E		31	3	OE		31	2	OE		31	2	OE	
												C40	3	E		31	3	OE		31	2	OE		31	2	OE	
								80	12	EO		C100	20	E		100	16	EO		100	12	EO		100	12	EO	

Cutting data for solid carbide drills without internal cooling

= cutting data for wet machining = dry machining is possible, cutting data must be selected from TEC E = emulsion O = oil M = MQL L = dry v _c = cutting speed V _{CR} = v _c rating chart from page B 382 V _{RR} = feed rating chart from page B 384				Drilling depth			3 x D _c											
				Designation			K3164TIN				A3265TFL A3865TFL							
Material group Grouping of main material groups and identification letters Workpiece material				Type			Alpha® 2				Alpha® 2							
				Dimensions			Walter standard				DIN 6537 K							
				Dia. range (mm)			3,30 – 14,50				3,00 – 20,00							
				Cutting tool material			K30F				K30F							
				Coating			TiN				TFL							
Page				B 139				B 61/B 98										
Brinell hardness HB Tensile strength R _m N/mm ² Machining group ¹																		
P	Non-alloyed steel	C ≤ 0.25 %	annealed	125	428	P1	95	12	E	O	M	L	100	12	E	O	M	L
		C > 0.25... ≤ 0.55 %	annealed	190	639	P2	90	12	E	O	M	L	95	12	E	O	M	L
		C > 0.25... ≤ 0.55 %	tempered	210	708	P3	85	12	E	O	M	L	90	12	E	O	M	L
		C > 0.55 %	annealed	190	639	P4	90	12	E	O	M	L	95	12	E	O	M	L
		C > 0.55 %	tempered	300	1013	P5	63	9	E	O	M	L	67	9	E	O	M	L
	Low alloy steel	machining steel (short-chipping)	annealed	220	745	P6	95	12	E	O	M	L	100	12	E	O	M	L
		annealed	175	591	P7	90	12	E	O	M	L	95	12	E	O	M	L	
		tempered	300	1013	P8	63	9	E	O	M	L	67	9	E	O	M	L	
		tempered	380	1282	P9	40	6	O	E			45	6	O	E			
	High-alloyed steel and high-alloyed tool steel	tempered	430	1477	P10	32	4	O	E			34	4	O	E			
		annealed	200	675	P11	56	9	E	O			60	9	E	O			
		hardened and tempered	300	1013	P12	48	7	E	O			53	7	E	O			
	Stainless steel	hardened and tempered	400	1361	P13	32	4	O	E			34	4	O	E			
		ferritic/martensitic, annealed	200	675	P14	56	9	E	O			60	9	E	O			
		martensitic, tempered	330	1114	P15	40	6	E	O			42	6	E	O			
M	Stainless steel	austenitic, quench hardened		200	675	M1												
		austenitic, precipitation hardened (PH)		300	1013	M2	42	5	E	O		45	5	E	O			
		austenitic/ferritic, duplex		230	778	M3												
K	Malleable cast iron	ferritic		200	675	K1	80	16	E	O	M	L	85	16	E	O	M	L
		pearlitic		260	867	K2	63	16	E	O	M	L	67	16	E	O	M	L
	grey cast iron	low tensile strength		180	602	K3	95	16	E	O	M	L	100	16	E	O	M	L
		high tensile strength/austenitic		245	825	K4	80	16	E	O	M	L	85	16	E	O	M	L
	Cast iron with spheroidal graphite	ferritic		155	518	K5	80	16	E	O	M	L	85	16	E	O	M	L
		pearlitic		265	885	K6	63	16	E	O	M	L	67	16	E	O	M	L
GGV (CGI)		200	675	K7	71	16	E	O	M	L	75	16	E	O	M	L		
N	Aluminium wrought alloys	cannot be hardened		30	-	N1	250	10	E	O								
		hardenable, hardened		100	343	N2	250	10	E	O								
	Cast aluminium alloys	≤ 12 % Si, not precipitation hardenable		75	260	N3	200	16	E	O		220	16	E	O			
		≤ 12 % Si, precipitation hardenable, precipitation hardened		90	314	N4	180	16	E	O		200	16	E	O			
		> 12 % Si, not precipitation hardenable		130	447	N5	140	12	E	O		160	12	E	O			
	Magnesium alloys		70	250	N6													
Copper and copper alloys (bronze/brass)	non-alloyed, electrolytic copper		100	343	N7	180	7	E	O	M		190	7	E	O	M		
	brass, bronze, red brass		90	314	N8	150	12	E	O		160	12	E	O				
	Cu-alloys, short-chipping		110	382	N9	160	16	E	O	M	L	180	16	E	O	M	L	
	high-strength, Ampco		300	1013	N10	63	9	E	O	M	L	67	9	E	O	M	L	
S	Heat-resistant alloys	Fe-based	annealed	200	675	S1												
			hardened	280	943	S2												
		Ni or Co base	annealed	250	839	S3												
			hardened	350	1177	S4												
			cast	320	1076	S5												
	Titanium alloys	pure titanium		200	675	S6	36	5	O	E		40	5	O	E			
α and β alloys, hardened		375	1262	S7	30	4	O	E		34	4	O	E					
β alloys		410	1396	S8														
Tungsten alloys		300	1013	S9	63	9	E	O		67	9	E	O					
Molybdenum alloys		300	1013	S10	63	9	E	O		67	9	E	O					
H	Hardened steel	hardened and tempered		50 HRC	-	H1	24	3	O	E		26	3	O	E			
		hardened and tempered		55 HRC	-	H2	20	3	O	E		22	3	O	E			
		hardened and tempered		60 HRC	-	H3												
	Hardened cast iron	hardened and tempered		55 HRC	-	H4	20	3	O	E		22	3	O	E			
O	Thermoplasts	without abrasive fillers				O1	90	16	E	O								
	Thermosetting plastics	without abrasive fillers				O2												
	Plastic, glass-fibre reinforced	GFRP				O3												
	Plastic, carbon fibre reinforced	CFRP				O4												
	Plastic, aramide fibre reinforced	AFRP				O5												
	Graphite (technical)			80 Shore		O6												

¹ The machining groups are assigned from page H 8 onwards.

The specified cutting data are recommended values.
For specific applications, adjustment is recommended.

		3 x D _c																												
		A3269TFL			A1164TIN			A1163			A1166TIN			A1166			A1167A			A1167B										
		Alpha® Rc			Alpha® 2			N			Maximiza			Maximiza			Maximiza			Maximiza										
		DIN 6537 K			DIN 6539			DIN 6539			Walter standard			Walter standard			Walter standard			Walter standard										
		3,40 – 10,40			1,50 – 20,00			1,00 – 12,00			3,00 – 20,00			3,00 – 20,00			3,00 – 20,00			3,00 – 20,00										
		K30F			K30F			K30F			K30F			K30F			K30F			K30F										
		TFL			TiN			uncoated			TiN			uncoated			uncoated			uncoated										
		B 65			B 38			B 36			B 46			B 42			B 47			B 50										
																														
																														
		v _c VRR		v _c VRR		v _c VRR		v _c VRR		v _c VRR		v _c VRR		v _c VRR		v _c VRR		v _c VRR		v _c VRR		v _c VRR		v _c VRR		v _c VRR				
				95	12	EO	ML																							
				90	12	EO	ML																							
				85	12	EO	ML																							
				90	12	EO	ML																							
				63	9	EO	ML					63	7	EO		40	4	OE												
				95	12	EO	ML																							
				90	12	EO	ML																							
				63	9	EO	ML					63	7	EO		40	4	OE												
				40	6	OE						45	4	OE		38	4	OE												
				32	4	OE						40	4	OE		36	4	OE												
				56	9	EO						56	8	EO																
				48	7	EO						50	4	EO		40	4	EO												
				32	4	OE						40	4	OE		36	4	OE												
				56	9	EO						56	8	EO																
				40	6	EO						38	6	EO																
				42	5	EO																								
				80	16	EO	ML	45	8	EO								75	12	EO										
				63	16	EO	ML	34	6	EO								60	10	EO										
				95	16	EO	ML	56	8	EO								90	12	EO										
				80	16	EO	ML	45	8	EO								75	12	EO										
				80	16	EO	ML	45	8	EO								75	12	EO										
				63	16	EO	ML	34	6	EO								60	10	EO										
				71	16	EO	ML	40	7	EO								67	12	EO										
				250	10	EO		220	10	EO	M												200	10	EO					
				250	10	EO		220	10	EO	M												200	10	EO					
				200	16	EO		170	10	EO	M												150	10	EO					
				180	16	EO		150	10	EO	M							130	10	EO										
				140	12	EO		100	9	EO								90	9	EO										
								210	10		ML															170	10		ML	
				180	7	EO	M	140	7	EO															160	8	EO			
				150	12	EO		100	9	EO															130	10	EO			
				160	16	EO	ML	110	12	EO	ML							140	12	EO	ML									
				63	9	EO	ML					63	7	EO		40	4	OE												
				18	3	OE												15	4	OE										
																		18	4	OE										
				13	3	OE												10	3	OE										
				16	3	OE												12	3	OE										
								36	5	OE								28	3	OE										
								30	4	OE								21	2	OE										
				10	3	OE												8	3	OE										
								63	9	EO								63	7	EO										
								63	9	EO								63	7	EO										
				34	3	OE		24	3	OE								30	3	OE										
				29	3	OE		20	3	OE								26	3	OE										
				24	2	OE												22	3	OE										
				29	3	OE		20	3	OE								26	3	OE										
								90	16	EO																				
								40	12	EO																50	8		L	
								67	5		L																			
								30	5		L																			
								20	5		L																			
								67	5		L																			
								20	5		L															50	5		L	

Cutting data for solid carbide drills without internal cooling

Material group	= cutting data for wet machining = dry machining is possible, cutting data must be selected from TEC E = emulsion O = oil M = MQL L = dry v _c = cutting speed VCRR = v _c rating chart from page B 382 VRR = feed rating chart from page B 384			Drilling depth			5 x D _c								
				Designation			A3378TML			A3162					
				Type			Alpha [®] 2 Plus Micro			ESU					
				Dimensions			Walter standard			DIN 1899					
Dia. range (mm)			0,50 – 2,95			0,10 – 1,45									
Cutting tool material			K30F			K30F									
Coating			TML			uncoated									
Page			B 79			B 59									
Grouping of main material groups and identification letters			Brinell hardness HB	Tensile strength R _m N/mm ²	Machining group ¹										
Workpiece material						VCRR	VRR			VCRR	VRR				
P	Non-alloyed steel	C ≤ 0.25 %	annealed	125	428	P1	C100	16	EO	ML	C80	5	EO		
		C > 0.25... ≤ 0.55 %	annealed	190	639	P2	C100	16	EO	ML	C80	6	EO		
		C > 0.25... ≤ 0.55 %	tempered	210	708	P3	C90	16	EO	ML	C71	6	EO		
		C > 0.55 %	annealed	190	639	P4	C100	16	EO	ML	C80	6	EO		
		C > 0.55 %	tempered	300	1013	P5	C67	12	EO	ML	C53	5	EO		
	Low alloy steel	machining steel (short-chipping)		annealed	220	745	P6	C100	20	EO	ML	C80	6	EO	
				annealed	175	591	P7	C100	16	EO	ML	C80	6	EO	
				tempered	300	1013	P8	C67	12	EO	ML	C53	5	EO	
				tempered	380	1282	P9	C45	7	OE		C32	4	OE	
	High-alloyed steel and high-alloyed tool steel			tempered	430	1477	P10	C40	6	OE		C25	3	OE	
				annealed	200	675	P11	C50	10	EO		C32	4	EO	
				hardened and tempered	300	1013	P12	C50	8	EO		C40	4	EO	
	Stainless steel			hardened and tempered	400	1361	P13	C40	6	OE		C25	3	OE	
				ferritic/martensitic, annealed	200	675	P14	C50	10	EO		C32	4	EO	
				martensitic, tempered	330	1114	P15					C16	3	EO	
M	Stainless steel	austenitic, quench hardened		200	675	M1					C16	3	EO		
		austenitic, precipitation hardened (PH)		300	1013	M2	C42	5	EO			C25	3	EO	
		austenitic/ferritic, duplex		230	778	M3									
K	Malleable cast iron	ferritic		200	675	K1	C80	20	EO	ML	C63	6	EO		
		pearlitic		260	867	K2	C63	20	EO	ML	C50	4	EO		
	grey cast iron	low tensile strength		180	602	K3	C100	20	EO	ML	C80	7	EO		
		high tensile strength/austenitic		245	825	K4	C80	20	EO	ML	C63	6	EO		
	Cast iron with spheroidal graphite	ferritic		155	518	K5	C80	20	EO		C63	6	EO		
		pearlitic		265	885	K6	C63	20	EO	ML	C50	4	EO		
GGV (CGI)				200	675	K7	C71	20	EO	ML	C56	5	EO		
N	Aluminium wrought alloys	cannot be hardened		30	–	N1	C125	16	OE		C200	9	EO	M	
		hardenable, hardened		100	343	N2	C125	16	OE		C200	9	EO	M	
	Cast aluminium alloys	≤ 12 % Si, not precipitation hardenable		75	260	N3	C125	20	OE		C160	9	EO	M	
		≤ 12 % Si, precipitation hardenable, precipitation hardened		90	314	N4	C125	20	OE		C125	9	EO	M	
		> 12 % Si, not precipitation hardenable		130	447	N5	C125	20	OE		C80	8	EO		
	Magnesium alloys				70	250	N6				C160	9		ML	
Copper and copper alloys (bronze/brass)	non-alloyed, electrolytic copper			100	343	N7	C125	10	OE	M	C125	6	EO		
	brass, bronze, red brass			90	314	N8	C100	12	OE		C100	8	EO		
	Cu-alloys, short-chipping			110	382	N9	C100	20	OE	ML	C100	8	EO	ML	
	high-strength, Ampco			300	1013	N10	C67	12	EO	ML	C53	5	EO		
S	Heat-resistant alloys	Fe-based		annealed	200	675	S1				C16	3	EO		
				hardened	280	943	S2				C12	2	OE		
		Ni or Co base		annealed	250	839	S3				C12	2	OE		
				hardened	350	1177	S4								
				cast	320	1076	S5								
	Titanium alloys	pure titanium			200	675	S6	C50	9	OE		C25	3	OE	
		α and β alloys, hardened			375	1262	S7	C40	8	OE		C20	2	OE	
β alloys			410	1396	S8										
Tungsten alloys				300	1013	S9	C67	12	EO		C53	5	EO		
Molybdenum alloys				300	1013	S10	C67	12	EO		C53	5	EO		
H	Hardened steel	hardened and tempered		50 HRC	–	H1	C25	3	OE						
		hardened and tempered		55 HRC	–	H2									
		hardened and tempered		60 HRC	–	H3									
	Hardened cast iron		hardened and tempered		55 HRC	–	H4								
O	Thermoplasts		without abrasive fillers				01	C100	20	OE		C32	12	EO	
	Thermosetting plastics		without abrasive fillers				02				C50	5	L		
	Plastic, glass-fibre reinforced		GFRP				03				C50	5	L		
	Plastic, carbon fibre reinforced		CFRP				04				C50	5	L		
	Plastic, aramide fibre reinforced		AFRP				05				C50	5	L		
	Graphite (technical)				80 Shore		06				C50	5	L		

¹ The machining groups are assigned from page H 8 onwards.

The specified cutting data are recommended values. For specific applications, adjustment is recommended.

5 x D _c										8 x D _c										3 x D _c – Carbide-tipped						NC spot drill					
A3365TFT A3965TFT				A3367 A3967				A6478TML				A1276TFL				A1263		A2971		A5971		A1174 A1174C									
Alpha® 2				BSX				Alpha® 2 Plus Micro				Alpha® 22				N		HM		HM		NC spot drill									
DIN 6537 L				DIN 6537 L				Walter standard				DIN 338				DIN 338		DIN 8037		DIN 8041		Walter standard									
3,00 – 25,00				3,00 – 16,00				0,50 – 2,95				3,00 – 12,00				0,60 – 12,00		3,00 – 16,00		8,00 – 32,00		3,00 – 20,00									
K30F				K30F				K30F				K30F				K30F		K10/20		K10/20		K30F									
TFT				uncoated				TML				TFL				uncoated		uncoated		uncoated		uncoated									
B 73/B 106				B 77/B 110				B 119				B 57				B 55		B 58		B 116		B 53/B 54									
v _c	VRR			v _c	VRR			VRR	VRR			v _c	VRR			v _c	VRR			v _c	VRR			v _c	VRR						
90	10	EO	ML					C100	16	EO	ML	75	8	EO	ML																
85	10	EO	ML					C100	16	EO	ML	71	8	EO	ML																
80	10	EO	ML					C90	16	EO	ML	71	8	EO	ML																
85	10	EO	ML					C100	16	EO	ML	71	8	EO	ML																
60	8	EO	ML					C67	12	EO	ML			EO	ML																
90	10	EO	ML					C100	20	EO	ML	75	9	EO	ML																
85	10	EO	ML					C100	16	EO	ML	71	8	EO	ML																
60	8	EO	ML					C67	12	EO	ML			EO	ML																
36	5	OE						C45	7	OE											23	2	OE		23	2	OE				
26	3	OE						C40	6	OE																					
50	7	EO						C50	10	EO		53	7	EO																	
45	6	EO						C50	8	EO																					
26	3	OE						C40	6	OE											25	2	OE		25	2	OE				
50	7	EO						C50	10	EO		53	7	EO																	
40	5	EO										38	5	EO																	
42	5	EO						C42	5	EO																					
75	16	EO	M	75	16	EO		C80	20	EO	ML	67	12	EO	ML	36	6	EO		26	6	EO		26	6	EO	45	8	EO		
60	12	EO	M	60	16	EO		C63	20	EO	ML	56	10	EO	ML	28	5	EO		21	4	OE		21	4	OE	34	6	EO		
90	16	EO	ML	90	16	EO		C100	20	EO	ML	80	12	EO	ML	45	6	EO		32	6	EO		32	6	EO	56	8	EO		
75	16	EO	ML	75	16	EO		C80	20	EO	ML	67	12	EO	ML	36	6	EO		26	6	EO		26	6	EO	45	8	EO		
75	16	EO	M	75	16	EO		C80	20	EO		67	12	EO	ML	36	6	EO		26	6	EO		26	6	EO	45	8	EO		
60	12	EO	M	60	16	EO		C63	20	EO	ML	56	10	EO	ML	28	5	EO		16	4	EO		16	4	EO	34	6	EO		
67	16	EO	M	67	16	EO		C71	20	EO	ML	63	12	EO	ML	32	6	EO		21	5	EO		21	5	EO	40	7	EO		
250	10	EO		300	10	EO	M	C125	16	OE						200	9	EO	M							220	10	EO	M		
250	10	EO		300	10	EO	M	C125	16	OE						200	9	EO	M							220	10	EO	M		
240	16	EO		200	16	EO	M	C125	20	OE		220	12	EO		150	9	EO	M							170	10	EO	M		
210	16	EO		180	16	EO	M	C125	20	OE		200	12	EO		130	9	EO	M							150	10	EO	M		
170	12	EO		140	16	EO		C125	20	OE		160	12	EO		90	8	EO								100	9	EO			
				180	16	EO	ML									170	8	ML								210	10	ML			
170	6	EO	M	190	8	EO	M	C125	10	OE	M	140	5	EO	M	110	5	EO								140	7	EO			
140	10	EO		140	12	EO		C100	12	OE		120	9	EO		80	7	EO								100	9	EO			
190	16	EO	ML	150	16	EO	ML	C100	20	OE	ML	150	16	EO	ML	90	9	EO	ML	67	8	EO	ML	67	8	EO	ML	110	12	EO	ML
60	8	EO	ML					C67	12	EO	ML									25	2	OE		25	2	OE	50	6	EO	ML	
																											7	3	OE		
																											7	3	OE		
																											7	3	OE		
																											25	3	OE		
																											17	2	OE		
60	8	EO						C67	12	EO		67	8	EO						25	2	OE		25	2	OE					
60	8	EO						C67	12	EO		67	8	EO						25	2	OE		25	2	OE					
21	3	OE						C25	3	OE										21	2	OE		21	2	OE					
18	3	OE																		12	2	OE		12	2	OE					
90	16	EO		40	16	EO		C100	20	OE						36	12	EO								40	12	EO			
				50	8	L										67	5	L		45	5	EO	L	45	5	EO	L	67	5	L	
				30	8	L										30	5	L		35	4	L		35	4	L	30	5	L		
				20	8	L										20	5	L								20	5	L			
				67	8	L										67	5	L								67	5	L			
				20	8	L										20	5	L		25	3	L		25	3	L	20	5	L		

Cutting data for HSS drills

= cutting data for wet machining = dry machining is possible, cutting data must be selected from TEC E = emulsion O = oil M = MQL L = dry v _c = cutting speed V _{CRR} = v _c rating chart from page B 382 V _{RR} = feed rating chart from page B 384				Drilling depth				3 x D _c							
				Designation				A1149XPL				A1149TFL			
Type				UFL®				UFL®							
Dimensions				DIN 1897				DIN 1897							
Dia. range (mm)				1,00 – 20,00				1,00 – 20,00							
Cutting tool material				HSS-E				HSS-E							
Coating				XPL				TFL							
Page				B 163				B 158							
Material group	Grouping of main material groups and identification letters			Brinell hardness HB	Tensile strength R _m N/mm ²	Machining group ¹									
	Workpiece material						v _c	V _{RR}			v _c	V _{RR}			
P	Non-alloyed steel	C ≤ 0.25 %	annealed	125	428	P1	60	12	EO	ML	53	12	EO	ML	
		C > 0.25... ≤ 0.55 %	annealed	190	639	P2	60	12	EO	ML	53	12	EO	ML	
		C > 0.25... ≤ 0.55 %	tempered	210	708	P3	60	12	EO	ML	53	12	EO	ML	
		C > 0.55 %	annealed	190	639	P4	60	12	EO	ML	53	12	EO	ML	
		C > 0.55 %	tempered	300	1013	P5	50	10	EO	ML	45	10	EO	ML	
	Low alloy steel	machining steel (short-chipping)	annealed	220	745	P6	60	12	EO	ML	53	12	EO	ML	
			annealed	175	591	P7	60	12	EO	ML	53	12	EO	ML	
			tempered	300	1013	P8	50	10	EO	ML	45	10	EO	ML	
			tempered	380	1282	P9	30	7	OE		28	7	OE		
		High-alloyed steel and high-alloyed tool steel	annealed	200	675	P11	50	10	EO	ML	45	10	EO	ML	
			hardened and tempered	300	1013	P12	42	8	EO		38	8	EO		
			hardened and tempered	400	1361	P13	18	5	OE		16	5	OE		
			Stainless steel	ferritic/martensitic, annealed	200	675	P14	24	5	EO		21	5	EO	
				martensitic, tempered	330	1114	P15	18	7	EO		16	7	EO	
	M	Stainless steel	austenitic, quench hardened	200	675	M1	15	5	OE		14	5	OE		
austenitic, precipitation hardened (PH)			300	1013	M2	24	6	OE		21	6	OE			
austenitic/ferritic, duplex			230	778	M3	12	5	OE		11	5	OE			
K	Malleable cast iron	ferritic	200	675	K1	48	16	EO	ML	42	16	EO	ML		
		pearlitic	260	867	K2	38	12	EO	ML	36	12	EO	ML		
	grey cast iron	low tensile strength	180	602	K3	60	16	EO	ML	53	16	EO	ML		
		high tensile strength/austenitic	245	825	K4	48	16	EO	ML	42	16	EO	ML		
	Cast iron with spheroidal graphite	ferritic	155	518	K5	48	16	EO	ML	42	16	EO	ML		
		pearlitic	265	885	K6	38	12	EO	ML	36	12	EO	ML		
	GGV (CGI)		200	675	K7	42	16	EO	ML	40	16	EO	ML		
N	Aluminium wrought alloys	cannot be hardened	30	-	N1	110	16	EO							
		hardenable, hardened	100	343	N2	110	16	EO							
	Cast aluminium alloys	≤ 12 % Si, not precipitation hardenable	75	260	N3	67	12	EO		60	12	EO			
		≤ 12 % Si, precipitation hardenable, precipitation hardened	90	314	N4	67	12	EO		48	12	EO			
		> 12 % Si, not precipitation hardenable	130	447	N5										
	Magnesium alloys		70	250	N6	67	12		ML	48	12		ML		
	Copper and copper alloys (bronze/brass)	non-alloyed, electrolytic copper	100	343	N7	80	5	EO		75	5	EO			
brass, bronze, red brass		90	314	N8	80	12	EO		71	12	EO				
Cu-alloys, short-chipping		110	382	N9	120	12	EO	ML	105	12	EO	ML			
high-strength, Ampco		300	1013	N10	42	8	EO		38	8	EO				
S	Heat-resistant alloys	Fe-based	annealed	200	675	S1	15	5	OE		14	5	OE		
			hardened	280	943	S2									
		Ni or Co base	annealed	250	839	S3	16	4	OE		15	4	OE		
			hardened	350	1177	S4									
			cast	320	1076	S5									
	Titanium alloys	pure titanium	200	675	S6										
		α and β alloys, hardened	375	1262	S7										
		β alloys	410	1396	S8										
Tungsten alloys		300	1013	S9	42	8	EO		38	8	EO				
Molybdenum alloys		300	1013	S10	42	8	EO		38	8	EO				
H	Hardened steel	hardened and tempered	50 HRC	-	H1										
		hardened and tempered	55 HRC	-	H2										
		hardened and tempered	60 HRC	-	H3										
	Hardened cast iron	hardened and tempered	55 HRC	-	H4										
O	Thermoplasts	without abrasive fillers			O1	45	12	EO		40	12	EO			
	Thermosetting plastics	without abrasive fillers			O2	45	8		L	42	8		L		
	Plastic, glass-fibre reinforced	GFRP			O3										
	Plastic, carbon fibre reinforced	CFRP			O4										
	Plastic, aramide fibre reinforced	AFRP			O5	45	8		L	42	8		L		
	Graphite (technical)		80 Shore			O6									

¹ The machining groups are assigned from page H 8 onwards.

The specified cutting data are recommended values.
For specific applications, adjustment is recommended.

	3 x D _c												5 x D _c						8 x D _c					
	A1154TFT			A1148			A1111			A2258			A3143			A6292TIN			A1249XPL			A1249TFL		
	VA Inox			UFL®			N			UFL® left			ESU			MegaJet			UFL®			UFL®		
	DIN 1897			DIN 1897			DIN 1897			DIN 1897			DIN 1899			Walter standard			DIN 338			DIN 338		
	2,00 – 16,00			1,00 – 20,00			0,50 – 32,00			1,00 – 20,00			0,05 – 1,45			5,00 – 24,00			1,00 – 16,00			1,00 – 16,00		
	HSS-E			HSS-E			HSS			HSS-E			HSS-E			HSS-E			HSS-E			HSS-E		
	TFT			Fibre-steamed			Steam treated			uncoated			uncoated			TiN			XPL			TFL		
	B 168			B 153			B 141			B 239			B 243			B 269			B 212			B 208		
	v _c		VRR		EO		ML		EO		ML		EO		ML		EO		ML		EO		ML	
	60 12		EO ML		38 9 EO		32 8 EO		34 8 EO		H28 8 EO		53 9 EO		50 9 EO ML		45 9 EO ML		45 9 EO ML		45 9 EO ML		45 9 EO ML	
	60 12		EO ML		38 10 EO		32 9 EO		34 9 EO		H28 9 EO		53 9 EO		50 10 EO ML		45 10 EO ML		45 10 EO ML		45 10 EO ML		45 10 EO ML	
	60 12		EO ML		38 10 EO		32 9 EO		34 9 EO		H28 9 EO		53 9 EO		50 10 EO ML		45 10 EO ML		45 10 EO ML		45 10 EO ML		45 10 EO ML	
	60 12		EO ML		38 10 EO		32 9 EO		34 9 EO		H23 9 EO		45 9 EO		40 8 EO ML		36 8 EO ML		36 8 EO ML		36 8 EO ML		36 8 EO ML	
	60 12		EO ML		38 10 EO		32 9 EO		34 9 EO		H28 9 EO		53 12 EO		50 10 EO ML		45 10 EO ML		45 10 EO ML		45 10 EO ML		45 10 EO ML	
	60 12		EO ML		38 10 EO		32 9 EO		34 9 EO		H28 9 EO		53 9 EO		50 10 EO ML		45 10 EO ML		45 10 EO ML		45 10 EO ML		45 10 EO ML	
					26 9 EO		21 8 EO		21 7 EO		H23 9 EO		45 9 EO		40 8 EO ML		36 8 EO ML		36 8 EO ML		36 8 EO ML		36 8 EO ML	
					16 7 OE		11 7 OE		11 6 EO						21 6 OE		18 6 OE		18 6 OE		18 6 OE		18 6 OE	
					13 6 OE		8 6 OE								10 4 OE		9 4 OE		9 4 OE		9 4 OE		9 4 OE	
					26 9 EO		21 8 EO		21 7 EO		H23 9 EO		45 9 EO		40 8 EO ML		36 8 EO ML		36 8 EO ML		36 8 EO ML		36 8 EO ML	
					19 7 EO		15 7 EO		14 5 EO						32 7 EO		28 7 EO		28 7 EO		28 7 EO		28 7 EO	
					13 6 OE		8 6 OE								10 4 OE		9 4 OE		9 4 OE		9 4 OE		9 4 OE	
					13 6 EO		9 4 EO		11 5 EO		H10 4 EO		25 5 EO		19 4 EO		17 4 EO		17 4 EO		17 4 EO		17 4 EO	
					13 7 EO		8 4 EO		11 5 EO		H10 6 EO		22 7 EO		13 6 EO		13 6 EO		13 6 EO		13 6 EO		13 6 EO	
	17 9		OE M		11 4 OE		6 3 OE		9 4 OE		H8 4 OE		21 5 OE		11 5 OE		10 5 OE		10 5 OE		10 5 OE		10 5 OE	
	14 7		OE		11 5 OE		8 5 OE		9 5 OE		H8 5 OE		22 5 OE		17 6 OE		15 6 OE		15 6 OE		15 6 OE		15 6 OE	
					9 4 OE		5 12 OE		7 4 OE		H6,3 4 OE		17 5 OE		8,5 5 OE		8 5 OE		8 5 OE		8 5 OE		8 5 OE	
					26 16 EO		24 12 EO		22 12 EO		H18 12 EO		40 12 EO		38 12 EO ML		34 12 EO ML		34 12 EO ML		34 12 EO ML		34 12 EO ML	
					19 12 EO		18 12 EO		16 10 EO		H14 10 EO		30 12 EO		32 10 EO ML		28 10 EO ML		28 10 EO ML		28 10 EO ML		28 10 EO ML	
					34 16 EO		30 12 EO		28 12 EO		H25 12 EO		50 12 EO		48 12 EO ML		42 12 EO ML		42 12 EO ML		42 12 EO ML		42 12 EO ML	
					26 16 EO		24 12 EO		22 12 EO		H18 12 EO		40 12 EO		38 12 EO ML		34 12 EO ML		34 12 EO ML		34 12 EO ML		34 12 EO ML	
					26 16 EO		24 12 EO		22 12 EO		H18 12 EO		40 12 EO		38 12 EO ML		34 12 EO ML		34 12 EO ML		34 12 EO ML		34 12 EO ML	
					19 12 EO		18 12 EO		16 10 EO		H14 10 EO		30 12 EO		32 10 EO ML		28 10 EO ML		28 10 EO ML		28 10 EO ML		28 10 EO ML	
					22 16 EO		21 12 EO		19 12 EO		H16 12 EO		36 12 EO		36 12 EO ML		32 12 EO ML		32 12 EO ML		32 12 EO ML		32 12 EO ML	
	105 16		EO		75 16 EO		63 16 EO		67 12 EO		H63 12 EO		105 12 EO		100 10 EO									
	105 16		EO		75 16 EO		63 16 EO		67 12 EO		H63 12 EO		105 12 EO		100 10 EO									
	60 12		EO		50 12 EO		42 12 EO		45 12 EO		H40 12 EO		85 12 EO		60 10 EO		56 10 EO		56 10 EO		56 10 EO		56 10 EO	
					36 12 EO		30 12 EO		32 10 EO		H28 10 EO		60 12 EO		60 10 EO		42 10 EO		42 10 EO		42 10 EO		42 10 EO	
					36 12 ML		30 12 ML		32 10 ML		H28 10 ML		60 12 ML		60 10 ML		42 10 ML		42 10 ML		42 10 ML		42 10 ML	
	75 5		EO M		53 6 EO		48 6 EO		48 5 EO		H40 5 EO		75 8 EO		67 4 EO		60 4 EO		60 4 EO		60 4 EO		60 4 EO	
					40 12 EO		38 12 EO		34 10 EO		H32 10 EO		60 12 EO		63 10 EO		56 10 EO		56 10 EO		56 10 EO		56 10 EO	
					75 12 EO ML		67 12 EO ML		56 10 EO ML		H56 12 EO ML		90 12 EO M		95 10 EO ML		85 10 EO ML		85 10 EO ML		85 10 EO ML		85 10 EO ML	
					19 7 EO		15 7 EO		14 5 EO				32 7 EO		32 7 EO		28 7 EO		28 7 EO		28 7 EO		28 7 EO	
	17 9		OE M		11 4 OE		6 3 OE		9 4 OE		H8 4 OE		21 5 OE		11 5 OE		10 5 OE		10 5 OE		10 5 OE		10 5 OE	
					10 4 OE		6 3 OE		8 4 OE				13 4 OE		11 4 OE		10 4 OE		10 4 OE		10 4 OE		10 4 OE	
					5 3 OE				3 3 OE		H3,2 3 OE													
	15 4		OE		13 4 OE		10 4 EO		10 4 OE		H8 4 EO													
					10 4 OE		6 4 EO		8 4 OE															
					19 7 EO		15 7 EO		14 5 EO						32 7 EO		28 7 EO		28 7 EO		28 7 EO		28 7 EO	
					19 7 EO		15 7 EO		14 5 EO						32 7 EO		28 7 EO		28 7 EO		28 7 EO		28 7 EO	
					40 12 EO		40 12 EO		34 12 EO		H32 12 EO				36 12 EO		34 12 EO		34 12 EO		34 12 EO		34 12 EO	
					24 8 L		24 8 L		21 8 L		H20 8 L				42 8 L		36 8 L		36 8 L		36 8 L		36 8 L	
					24 8 L		24 8 L		21 8 L		H20 8 L				42 8 L		36 8 L		36 8 L		36 8 L		36 8 L	

Cutting data for HSS drills

= cutting data for wet machining = dry machining is possible, cutting data must be selected from TEC E = emulsion O = oil M = MQL L = dry v _c = cutting speed V _{CR} = v _c rating chart from page B 382 V _{RR} = feed rating chart from page B 384				Drilling depth			8 x D _c									
				Designation			A1254TFT			A1247						
Grouping of main material groups and identification letters				Type			VA Inox			Alpha® XE						
				Dimensions			DIN 338			DIN 338						
				Dia. range (mm)			3,00 – 16,00			1,00 – 16,00						
				Cutting tool material			HSS-E			HSS-E						
				Coating			TFT			Fibre-steamed						
Page				B 216			B 204									
Material group	Workpiece material			Brinell hardness HB	Tensile strength R _m N/mm ²	Machining group ¹										
							v _c	V _{RR}	E	O	M	L	v _c	V _{RR}	E	O
P	Non-alloyed steel	C ≤ 0.25 %	annealed	125	428	P1	48	9	E	O	M	L	34	8	E	O
		C > 0.25... ≤ 0.55 %	annealed	190	639	P2	48	10	E	O	M	L	34	9	E	O
		C > 0.25... ≤ 0.55 %	tempered	210	708	P3					M	L	32	9	E	O
		C > 0.55 %	annealed	190	639	P4	48	10	E	O	M	L	34	9	E	O
		C > 0.55 %	tempered	300	1013	P5							21	7	E	O
	Low alloy steel	machining steel (short-chipping)	annealed	220	745	P6	48	10	E	O	M	L	34	9	E	O
			annealed	175	591	P7	48	10	E	O	M	L	34	9	E	O
			tempered	300	1013	P8							21	7	E	O
			tempered	380	1282	P9							11	5	O	E
			tempered	430	1477	P10							7	4	O	E
		High-alloyed steel and high-alloyed tool steel	annealed	200	675	P11							21	7	E	O
			hardened and tempered	300	1013	P12							14	5	E	O
			hardened and tempered	400	1361	P13							7	4	O	E
		Stainless steel	ferritic/martensitic, annealed	200	675	P14							11	5	E	O
			martensitic, tempered	330	1114	P15							11	5	E	O
M	Stainless steel	austenitic, quench hardened	200	675	M1	12	9	O	E	M		8	4	O	E	
		austenitic, precipitation hardened (PH)	300	1013	M2							8	5	O	E	
		austenitic/ferritic, duplex	230	778	M3	10	7	O	E			6	4	O	E	
K	Malleable cast iron	ferritic	200	675	K1						21	12	E	O		
		pearlitic	260	867	K2						15	10	E	O		
	grey cast iron	low tensile strength	180	602	K3						26	12	E	O		
		high tensile strength/austenitic	245	825	K4						21	12	E	O		
	Cast iron with spheroidal graphite	ferritic	155	518	K5						21	12	E	O		
		pearlitic	265	885	K6						15	10	E	O		
	GGV (CGI)		200	675	K7						18	12	E	O		
N	Aluminium wrought alloys	cannot be hardened	30	–	N1	95	10	E	O							
		hardenable, hardened	100	343	N2	95	10	E	O							
	Cast aluminium alloys	≤ 12 % Si, not precipitation hardenable	75	260	N3	56	10	E	O		45	12	E	O		
		≤ 12 % Si, precipitation hardenable, precipitation hardened	90	314	N4						32	10	E	O		
		> 12 % Si, not precipitation hardenable	130	447	N5											
	Magnesium alloys		70	250	N6						32	10		M	L	
	Copper and copper alloys (bronze/brass)	non-alloyed, electrolytic copper	100	343	N7	60	4	E	O	M		48	5	E	O	
brass, bronze, red brass		90	314	N8						32	9	E	O			
Cu-alloys, short-chipping		110	382	N9						60	10	E	O	M	L	
high-strength, Ampco		300	1013	N10						14	5	E	O			
S	Heat-resistant alloys	Fe-based	annealed	200	675	S1	12	9	O	E	M		8	4	O	E
			hardened	280	943	S2										
		Ni or Co base	annealed	250	839	S3						7	4	O	E	
			hardened	350	1177	S4						2	3	O	E	
			cast	320	1076	S5						3	3	O	E	
	Titanium alloys	pure titanium	200	675	S6	10	4	O	E		9	4	O	E		
		α and β alloys, hardened	375	1262	S7						7	4	O	E		
		β alloys	410	1396	S8						2	3	O	E		
	Tungsten alloys		300	1013	S9						14	5	E	O		
	Molybdenum alloys		300	1013	S10						14	5	E	O		
H	Hardened steel	hardened and tempered	50 HRC	–	H1											
		hardened and tempered	55 HRC	–	H2											
		hardened and tempered	60 HRC	–	H3											
	Hardened cast iron	hardened and tempered	55 HRC	–	H4											
O	Thermoplasts	without abrasive fillers									34	10	E	O		
	Thermosetting plastics	without abrasive fillers														
	Plastic, glass-fibre reinforced	GFRP														
	Plastic, carbon fibre reinforced	CFRP														
	Plastic, aramide fibre reinforced	AFRP														
	Graphite (technical)		80 Shore													

¹ The machining groups are assigned from page H 8 onwards.

The specified cutting data are recommended values.
For specific applications, adjustment is recommended.

														8 x D _c																	
A1244				A1222				A1211TIN				A1211				A1212				A1234				A1231							
VA				UFL®				N				N				H				UFL® left				N left							
DIN 338				DIN 338				DIN 338				DIN 338				DIN 338				DIN 338											
0,30 – 15,00				1,00 – 16,00				0,50 – 16,00				0,20 – 22,00				0,35 – 16,00				1,5 – 12,70				0,20 – 20,00							
HSS-E				HSS				HSS				HSS				HSS				HSS											
uncoated				Fibre-steamed				TiN				Steam treated				uncoated				Fibre-steamed				Steam treated							
B 199				B 185				B 180				B 171				B 182				B 195				B 190							
v _c		VRR		v _c		VRR		v _c		VRR		v _c		VRR		v _c		VRR		v _c		VRR		v _c		VRR					
				30	8			EO				36	8			EO				28	7			EO			28	7			EO
				30	9			EO				36	9			EO				28	8			EO			28	8			EO
				28	9			EO				34	9			EO				26	8			EO			28	9			EO
				30	9			EO				36	9			EO				28	8			EO			28	8			EO
	18	5		OE					19	7			EO						17	7			EO			19	7			EO	
									30	9			EO						28	8			EO			30	9			EO	
									30	9			EO						28	8			EO			30	9			EO	
	18	5		OE					19	7			EO						17	7			EO			19	7			EO	
	10	5		OE															7	5			OE								
	7	4		OE															4	4			OE								
	18	5		OE					19	7			EO						17	7			EO			19	7			EO	
	13	5		EO					11	5			EO						10	5			EO								
	7	4		EO															4	4			EO								
	11	4		EO					10	4			EO						8	4			EO			10	4			EO	
									9	5			EO						6	4			EO			9	5			EO	
	8	4		OE					6	3			OE						5	3			OE			6	3			OE	
	8	5		OE					7	5			OE						12	5			OE			6	5			OE	
									5	3			OE						4	3			OE			5	3			OE	
									19	12			EO						32	10			EO			19	12			EO	
									14	10			EO						25	9			EO			14	10			EO	
									24	12			EO						40	10			EO			24	12			EO	
									19	12			EO						32	10			EO			19	12			EO	
									19	12			EO						32	10			EO			19	12			EO	
									14	10			EO						25	9			EO			14	10			EO	
									17	12			EO						28	10			EO			17	12			EO	
									60	12			EO						60	12			EO			60	12			EO	
									60	12			EO						60	12			EO			60	12			EO	
									40	12			EO						36	12			EO			36	12			EO	
									28	10			EO						26	10			EO			28	10			EO	
									28	10			ML						26	10			ML			28	10			ML	
									42	4			EO						53	5			EO			42	5			EO	
	32	9		EO					30	9			EO						30	9			EO			30	9			EO	
									53	10			EO						67	10			EO			53	10			EO	
	13	5		EO					11	5			EO						19	5			EO			10	5			EO	
									7	3			EO						5	3			EO			6	3			EO	
	7	4		OE					4	3			OE						4	3			OE			4	3			OE	
	2	3		OE																											
	3	3		OE																											
	9	4		OE															7	4			EO			7	4			EO	
	7	4		OE															4	4			OE			4	4			OE	
	2	3		OE																											
	13	5		EO					11	5			EO						19	5			EO			10	5			EO	
	13	5		EO					11	5			EO						19	5			EO			10	5			EO	
									34	12			EO						34	12			EO			34	12			EO	
									21	8			L						32	8			L			21	8			L	
									21	8			L						32	8			L			21	8			L	

Cutting data for HSS drills

= cutting data for wet machining = dry machining is possible, cutting data must be selected from TEC E = emulsion O = oil M = MQL L = dry v _c = cutting speed V _{CRR} = v _c rating chart from page B 382 V _{RR} = feed rating chart from page B 384				Drilling depth			12 x D _c							
				Designation			A1549TFP			A1547				
Material group				Type			UFL®			Alpha® XE				
Grouping of main material groups and identification letters				Dimensions			DIN 340			DIN 340				
Workpiece material				Dia. range (mm)			1,00 – 12,00			1,00 – 12,70				
				Cutting tool material			HSS-E			HSS-E				
				Coating			TFP			Fibre-steamed				
				Page			B 230			B 227				
				Brinell hardness HB										
				Tensile strength R _m N/mm ²										
				Machining group ¹			v _c			V _{RR}				
P	Non-alloyed steel	C ≤ 0.25 %	annealed	125	428	P1	40	8	EO	ML	28	8	EO	
		C > 0.25... ≤ 0.55 %	annealed	190	639	P2	40	9	EO	ML	28	9	EO	
		C > 0.25... ≤ 0.55 %	tempered	210	708	P3	38	9	EO	ML	26	9	EO	
		C > 0.55 %	annealed	190	639	P4	40	9	EO	ML	28	9	EO	
		C > 0.55 %	tempered	300	1013	P5	30	7	EO	ML	17	7	EO	
	Low alloy steel	machining steel (short-chipping)		annealed	220	745	P6	40	9	EO	ML	28	9	EO
				annealed	175	591	P7	40	9	EO	ML	28	9	EO
				tempered	300	1013	P8	30	7	EO	ML	17	7	EO
				tempered	380	1282	P9	14	5	OE		7	4	OE
	High-alloyed steel and high-alloyed tool steel			tempered	430	1477	P10	6	3	OE		4	3	OE
				annealed	200	675	P11	30	7	EO	ML	17	7	EO
				hardened and tempered	300	1013	P12	22	6	EO		10	5	EO
	Stainless steel			hardened and tempered	400	1361	P13	6	3	OE		4	3	OE
				ferritic/martensitic, annealed	200	675	P14	14	4	EO		10	4	EO
				martensitic, tempered	330	1114	P15	10	5	EO		8	5	EO
M	Stainless steel	austenitic, quench hardened		200	675	M1	8	4	OE		6	4	OE	
		austenitic, precipitation hardened (PH)		300	1013	M2	12	5	OE		6	5	OE	
		austenitic/ferritic, duplex		230	778	M3	6	4	OE		5	4	OE	
K	Malleable cast iron	ferritic		200	675	K1	30	10	EO	ML	18	10	EO	
		pearlitic		260	867	K2	24	9	EO	ML	13	9	EO	
	grey cast iron	low tensile strength		180	602	K3	36	10	EO	ML	22	10	EO	
		high tensile strength/austenitic		245	825	K4	30	10	EO	ML	18	10	EO	
	Cast iron with spheroidal graphite	ferritic		155	518	K5	30	10	EO	ML	18	10	EO	
		pearlitic		265	885	K6	24	9	EO	ML	13	9	EO	
	GGV (CGI)				200	675	K7	28	10	EO	ML	16	10	EO
N	Aluminium wrought alloys	cannot be hardened		30	-	N1								
		hardenable, hardened		100	343	N2								
	Cast aluminium alloys	≤ 12 % Si, not precipitation hardenable		75	260	N3	48	9	EO		38	10	EO	
		≤ 12 % Si, precipitation hardenable, precipitation hardened		90	314	N4	36	9	EO		28	9	EO	
		> 12 % Si, not precipitation hardenable		130	447	N5								
	Magnesium alloys				70	250	N6	36	9		ML	28	9	ML
	Copper and copper alloys (bronze/brass)	non-alloyed, electrolytic copper			100	343	N7	50	4	EO		40	4	EO
brass, bronze, red brass			90	314	N8	48	9	EO		28	8	EO		
Cu-alloys, short-chipping			110	382	N9	71	9	EO	ML	50	9	EO ML		
high-strength, Ampco			300	1013	N10	22	6	EO		10	5	EO		
S	Heat-resistant alloys	Fe-based		annealed	200	675	S1	8	4	OE		6	4	OE
				hardened	280	943	S2							
				annealed	250	839	S3	7	4	OE		5	4	OE
				hardened	350	1177	S4					2	2	OE
				cast	320	1076	S5					2	2	OE
	Titanium alloys	pure titanium			200	675	S6					6	3	OE
		α and β alloys, hardened			375	1262	S7					5	3	OE
β alloys			410	1396	S8					1	2	OE		
Tungsten alloys				300	1013	S9	22	6	EO		10	5	EO	
Molybdenum alloys				300	1013	S10	22	6	EO		10	5	EO	
H	Hardened steel	hardened and tempered		50 HRC	-	H1								
		hardened and tempered		55 HRC	-	H2								
		hardened and tempered		60 HRC	-	H3								
	Hardened cast iron		hardened and tempered		55 HRC	-	H4							
O	Thermoplasts		without abrasive fillers				01	26	10	EO		26	9	EO
	Thermosetting plastics		without abrasive fillers				02	32	8		L			
	Plastic, glass-fibre reinforced		GFRP				03							
	Plastic, carbon fibre reinforced		CFRP				04							
	Plastic, aramide fibre reinforced		AFRP				05	32	8		L			
	Graphite (technical)				80 Shore		06							

¹ The machining groups are assigned from page H 8 onwards.

Cutting data for HSS drills

= cutting data for wet machining = dry machining is possible, cutting data must be selected from TEC E = emulsion O = oil M = MQL L = dry v _c = cutting speed VCRR = v _c rating chart from page B 382 VRR = feed rating chart from page B 384			Drilling depth			85 x D _c			8 x D _c			
			Designation			A1922L			A4211TIN			
Grouping of main material groups and identification letters Workpiece material			Type			UFL®			N			
			Dimensions			Walter standard			DIN 345			
			Dia. range (mm)			8,00 – 12,00			5,00 – 30,00			
			Cutting tool material			HSS			HSS			
			Coating			Fibre-steamed			TiN			
Page			B 237			B 255						
Material group	Workpiece material		Brinell hardness HB	Tensile strength R _m N/mm ²	Machining group ¹							
						v _c	VRR	E/O/M/L	v _c	VRR	E/O/M/L	
P	Non-alloyed steel	C ≤ 0.25 %	annealed	125	428	P1	15	4	E O	30	8	E O
		C > 0.25... ≤ 0.55 %	annealed	190	639	P2	15	4	E O	30	9	E O
		C > 0.25... ≤ 0.55 %	tempered	210	708	P3	14	4	E O	30	9	E O
		C > 0.55 %	annealed	190	639	P4	15	4	E O	30	9	E O
		C > 0.55 %	tempered	300	1013	P5	9	4	E O	22	7	E O
	Low alloy steel	machining steel (short-chipping)	annealed	220	745	P6	15	4	E O	30	9	E O
		annealed	175	591	P7	15	4	E O	30	9	E O	
		tempered	300	1013	P8	9	4	E O	22	7	E O	
		tempered	380	1282	P9							
	High-alloyed steel and high-alloyed tool steel	tempered	430	1477	P10							
		annealed	200	675	P11	9	4	E O	22	7	E O	
		hardened and tempered	300	1013	P12	5	3	E O	16	5	E O	
	Stainless steel	hardened and tempered	400	1361	P13							
		ferritic/martensitic, annealed	200	675	P14	4	2	E O	8	4	E O	
	M	Stainless steel	martensitic, tempered	330	1114	P15	3	3	E O			
austenitic, quench hardened			200	675	M1	2	2	O E	6	3	O E	
austenitic, precipitation hardened (PH)			300	1013	M2	2	2	O E	11	5	O E	
K	Malleable cast iron	austenitic/ferritic, duplex	230	778	M3	12	6	O E	34	10	O E	
		ferritic	200	675	K1	10	6	E O	28	10	E O	
	grey cast iron	pearlitic	260	867	K2	7	5	E O	22	9	E O	
		low tensile strength	180	602	K3	12	6	E O	34	10	E O	
		high tensile strength/austenitic	245	825	K4	10	6	E O	28	10	E O	
	Cast iron with spheroidal graphite	ferritic	155	518	K5	10	6	E O	28	10	E O	
		pearlitic	265	885	K6	7	5	E O	22	9	E O	
GGV (CGI)		200	675	K7	9	6	E O	25	10	E O		
N	Aluminium wrought alloys		30	–	N1	30	5	E O				
		cannot be hardened	100	343	N2	30	5	E O				
	Cast aluminium alloys	hardenable, hardened	75	260	N3	20	6	E O				
		≤ 12 % Si, not precipitation hardenable	90	314	N4	14	5	E O				
		≤ 12 % Si, precipitation hardenable, precipitation hardened	130	447	N5							
	Magnesium alloys	> 12 % Si, not precipitation hardenable	70	250	N6	14	5	M L				
		non-alloyed, electrolytic copper	100	343	N7	21	2	E O	45	5	E O	
		brass, bronze, red brass	90	314	N8	15	4	E O				
Copper and copper alloys (bronze/brass)	Cu-alloys, short-chipping	110	382	N9	26	5	E O M L	60	10	E O M L		
	high-strength, Ampco	300	1013	N10	5	3	E O	16	5	E O		
S	Heat-resistant alloys		annealed	200	675	S1	2	2	O E	6	3	O E
			hardened	280	943	S2						
			annealed	250	839	S3						
		Ni or Co base	hardened	350	1177	S4						
			cast	320	1076	S5						
	Titanium alloys	pure titanium	200	675	S6							
		α and β alloys, hardened	375	1262	S7							
		β alloys	410	1396	S8							
Tungsten alloys		300	1013	S9	5	3	E O	16	5	E O		
Molybdenum alloys		300	1013	S10	5	3	E O	16	5	E O		
H	Hardened steel		50 HRC	–	H1							
			55 HRC	–	H2							
			60 HRC	–	H3							
	Hardened cast iron		55 HRC	–	H4							
O	Thermoplasts	without abrasive fillers			O1	13	6	E O				
	Thermosetting plastics	without abrasive fillers			O2	11	5	L	28	8	L	
	Plastic, glass-fibre reinforced	GFRP			O3							
	Plastic, carbon fibre reinforced	CFRP			O4							
	Plastic, aramide fibre reinforced	AFRP			O5	11	5	L	28	8	L	
	Graphite (technical)		80 Shore		O6							

¹ The machining groups are assigned from page H 8 onwards.

The specified cutting data are recommended values. For specific applications, adjustment is recommended.

		8 x D _c						12 x D _c						16 x D _c						22 x D _c								
		A4211		A4244		A4247		A4422		A4411		A4622		A4611		A4722												
		N		VA		Alpha® XE		UFL®		N		UFL®		N		UFL®												
		DIN 345		DIN 345		DIN 345		DIN 341		DIN 341		DIN 1870 I		DIN 1870 I		DIN 1870 II												
		3,00 – 100,00		10,00 – 32,00		10,00 – 40,00		10,00 – 31,00		5,00 – 50,00		12,00 – 30,00		8,00 – 50,00		8,00 – 40,00												
		HSS		HSS-E		HSS-E		HSS		HSS		HSS		HSS		HSS												
		Steam treated		uncoated		Fibre-steamed		Fibre-steamed		Steam treated		Fibre-steamed		Steam treated		Fibre-steamed												
		B 247		B 256		B 258		B 263		B 260		B 267		B 265		B 268												
		v _c VRR		v _c VRR		v _c VRR		v _c VRR		v _c VRR		v _c VRR		v _c VRR		v _c VRR												
25	7	EO				30	8	EO		22	7	EO		19	6	EO		18	5	EO								
25	8	EO				30	9	EO		22	8	EO		19	6	EO		18	6	EO								
24	8	EO				28	9	EO		21	8	EO		18	6	EO		17	6	EO								
25	8	EO				30	9	EO		22	8	EO		19	6	EO		18	7	EO								
15	7	EO			19	7	EO		14	7	EO		12	7	EO		11	5	EO		10	6	EO					
						30	9	EO		22	8	EO		19	6	EO						18	6	EO				
25	8	EO				30	9	EO		22	8	EO		21	8	EO		19	6	EO		18	7	EO				
15	7	EO			19	7	EO		14	7	EO		12	7	EO		11	5	EO		10	6	EO					
6	5	OE			10	5	OE		8	5	EO		4	4	OE		4	4	EO		3	4	OE					
3	4	OE			6	4	OE		6	4	OE		2	3	OE		2	3	OE		1	3	OE					
15	7	EO			19	7	EO		14	7	EO		12	7	EO		11	5	EO		10	6	EO					
9	5	EO			11	5	EO		8	5	EO		6	5	EO		6	4	EO		5	4	EO					
3	4	OE			6	4	OE		6	4	OE		2	3	OE		2	3	OE		1	3	OE					
7	4	EO			10	4	EO		10	5	EO		7	4	EO		6	3	EO		5	3	EO					
6	4	EO			10	5	EO		6	5	EO		4	3	EO		4	4	EO		3	3	EO					
4	3	OE			7	4	OE		7	4	OE		4	3	OE		3	3	OE		2	3	OE					
5	5	OE			7	5	OE		5	4	OE		4	5	OE		3	4	OE		3	5	OE					
3	3	OE			5	4	OE		3	3	OE		3	3	OE		2	3	OE		2	3	OE					
17	10	EO			18	12	EO		14	10	EO		14	9	EO		12	9	EO		12	8	EO					
13	9	EO			13	10	EO		11	9	EO		11	8	EO		9	8	EO		9	6	EO					
21	10	EO			24	12	EO		18	10	EO		18	9	EO		15	9	EO		15	8	EO					
17	10	EO			18	12	EO		14	10	EO		14	9	EO		12	9	EO		12	8	EO					
17	10	EO			18	12	EO		14	10	EO		14	9	EO		12	9	EO		12	8	EO					
13	9	EO			13	10	EO		11	9	EO		11	8	EO		9	8	EO		9	6	EO					
15	10	EO			16	12	EO		13	10	EO		13	9	EO		11	9	EO		11	7	EO					
50	12	EO							45	9	EO		45	9	EO		38	7	EO		36	7	EO					
50	12	EO							45	9	EO		45	9	EO		38	7	EO		36	7	EO					
32	12	EO			38	12	EO		30	10	EO		28	10	EO		25	9	EO		24	9	EO					
24	10	EO			28	10	EO		21	9	EO		20	9	EO		18	7	EO		17	7	EO					
24	10		ML			28	10		ML	21	9		ML	20	9		ML	18	7		ML	17	7		ML			
38	5	EO			42	5	EO		32	4	EO		32	4	EO		26	3	EO		26	3	EO					
26	9	EO		28	9	EO		28	9	EO		22	8	EO		19	6	EO		19	6	EO						
48	10	EO	ML		53	10	EO	ML	40	9	EO	ML	40	9	EO	ML	34	8	EO	ML	34	8	EO	ML				
9	5	EO		11	5	EO		13	5	EO		8	5	EO		6	5	EO		6	4	EO		5	4	EO		
4	3	OE		7	4	OE		7	4	OE		4	3	OE		3	3	OE		3	3	OE		2	3	OE		
4	3	OE		6	4	OE		6	4	OE		3	3	OE		3	3	OE		2	3	OE		2	3	OE		
				2	3	OE		2	3	OE																		
				2	3	OE		2	3	OE																		
6	4	EO		8	4	EO		8	4	EO		4	3	EO		4	3	EO		3	3	EO		3	3	EO		
4	4	OE		6	4	OE		6	4	OE		3	3	OE		3	3	OE		2	3	OE		2	3	OE		
				2	3	OE		2	3	OE																		
9	5	EO		11	5	EO		13	5	EO		8	5	EO		6	5	EO		6	4	EO		5	4	EO		
9	5	EO		11	5	EO		13	5	EO		8	5	EO		6	5	EO		6	4	EO		5	4	EO		
30	12	EO			30	10	EO		22	10	EO		22	10	EO		17	9	EO		17	9	EO		16	8	EO	
19	8		L						16	8		L	16	8		L	13	7		L	13	7		L	13	7		L
19	8		L						16	8		L	16	8		L	13	7		L	13	7		L	13	7		L

Cutting data for HSS drills

Material group	= cutting data for wet machining = dry machining is possible, cutting data must be selected from TEC		E = emulsion O = oil M = MQL L = dry		v _c = cutting speed V _{CRR} = v _c rating chart from page B 382 V _{RR} = feed rating chart from page B 384		Type		NC spot drill					
							Designation		Form		Dimensions		Cutting tool material	
Grouping of main material groups and identification letters							90°		120°					
Workpiece material							Walter standard		Walter standard					
							2,00 – 25,40		2,00 – 25,40					
							HSS		HSS					
							uncoated		uncoated					
							B 149		B 146					
							v _c VRR		v _c VRR		v _c VRR			
P	Non-alloyed steel	C ≤ 0.25 %	annealed	125	428	P1	32	8	E O		32	8	E O	
		C > 0.25... ≤ 0.55 %	annealed	190	639	P2	32	9	E O		32	9	E O	
		C > 0.25... ≤ 0.55 %	tempered	210	708	P3	30	9	E O		30	9	E O	
		C > 0.55 %	annealed	190	639	P4	32	9	E O		32	9	E O	
		C > 0.55 %	tempered	300	1013	P5	21	8	E O		21	8	E O	
	Low alloy steel	machining steel (short-chipping)	annealed	220	745	P6	32	9	E O		32	9	E O	
			annealed	175	591	P7	32	9	E O		32	9	E O	
			tempered	300	1013	P8	21	8	E O		21	8	E O	
			tempered	380	1282	P9	11	7	O E		11	7	O E	
		High-alloyed steel and high-alloyed tool steel	annealed	200	675	P11	21	8	E O		21	8	E O	
			hardened and tempered	300	1013	P12	15	7	E O		15	7	E O	
			hardened and tempered	400	1361	P13	8	6	O E		8	6	O E	
			ferritic/martensitic, annealed	200	675	P14	9	4	E O		9	4	E O	
			martensitic, tempered	330	1114	P15	8	4	E O		8	4	E O	
	Stainless steel	austenitic, quench hardened	200	675	M1	6	3	O E		6	3	O E		
austenitic, precipitation hardened (PH)		300	1013	M2	8	5	O E		8	5	O E			
austenitic/ferritic, duplex		230	778	M3	5	3	O E		5	3	O E			
K	Malleable cast iron	ferritic	200	675	K1	24	12	E O		24	12	E O		
		pearlitic	260	867	K2	18	12	E O		18	12	E O		
	grey cast iron	low tensile strength	180	602	K3	30	12	E O		30	12	E O		
		high tensile strength/austenitic	245	825	K4	24	12	E O		24	12	E O		
	Cast iron with spheroidal graphite	ferritic	155	518	K5	24	12	E O		24	12	E O		
		pearlitic	265	885	K6	18	12	E O		18	12	E O		
	GGV (CGI)		200	675	K7	21	12	E O		21	12	E O		
N	Aluminium wrought alloys	cannot be hardened	30	-	N1	63	16	E O		63	16	E O		
		hardenable, hardened	100	343	N2	63	16	E O		63	16	E O		
	Cast aluminium alloys	≤ 12 % Si, not precipitation hardenable	75	260	N3	42	12	E O		42	12	E O		
		≤ 12 % Si, precipitation hardenable, precipitation hardened	90	314	N4	30	12	E O		30	12	E O		
		> 12 % Si, not precipitation hardenable	130	447	N5									
	Magnesium alloys		70	250	N6	30	12		M L	30	12		M L	
	Copper and copper alloys (bronze/brass)	non-alloyed, electrolytic copper	100	343	N7	48	6	E O		48	6	E O		
brass, bronze, red brass		90	314	N8	38	12	E O		38	12	E O			
Cu-alloys, short-chipping		110	382	N9	67	12	E O	M L	67	12	E O	M L		
high-strength, Ampco		300	1013	N10	15	7	E O		15	7	E O			
S	Heat-resistant alloys	Fe-based	annealed	200	675	S1	6	3	O E		6	3	O E	
			hardened	280	943	S2								
		Ni or Co base	annealed	250	839	S3	6	3	O E		6	3	O E	
			hardened	350	1177	S4								
			cast	320	1076	S5								
	Titanium alloys	pure titanium	200	675	S6	10	4	E O		10	4	E O		
		α and β alloys, hardened	375	1262	S7	6	4	O E		6	4	O E		
β alloys		410	1396	S8										
Tungsten alloys		300	1013	S9	15	7	E O		15	7	E O			
Molybdenum alloys		300	1013	S10	15	7	E O		15	7	E O			
H	Hardened steel	hardened and tempered	50 HRC	-	H1									
		hardened and tempered	55 HRC	-	H2									
		hardened and tempered	60 HRC	-	H3									
	Hardened cast iron	hardened and tempered	55 HRC	-	H4									
O	Thermoplasts	without abrasive fillers			O1	40	12	E O		40	12	E O		
	Thermosetting plastics	without abrasive fillers			O2	24	8		L	24	8		L	
	Plastic, glass-fibre reinforced	GFRP			O3									
	Plastic, carbon fibre reinforced	CFRP			O4									
	Plastic, aramide fibre reinforced	AFRP			O5	24	8		L	24	8		L	
	Graphite (technical)		80 Shore			O6								

1 The machining groups are assigned from page H 8 onwards.

The specified cutting data are recommended values.
For specific applications, adjustment is recommended.

	Bodywork drill				Multi-diameter step drill												Taper pin drill							
	A1121				K6221				K6222				K6223				K2929				K4929			
	130° Walter standard 3,30 – 4,90 HSS uncoated B 152				90° DIN 8374 3,20 – 8,40 HSS Steam treated B 273				90° DIN 8378 2,50 – 10,20 HSS Steam treated B 274				180° DIN 8376 4,50 – 11,00 HSS Steam treated B 275				1:50 DIN 1898 A 1,00 – 12,00 HSS Steam treated B 271				1:50 DIN 1898 B 5,00 – 25,00 HSS Steam treated B 272			
v _c VRR				v _c VRR				v _c VRR				v _c VRR				v _c VRR				v _c VRR				
32	8	EO		32	7	EO		32	7	EO		32	7	EO		26	7	EO		26	7	EO		
32	9	EO		32	8	EO		32	8	EO		32	8	EO		26	8	EO		26	8	EO		
30	9	EO		30	8	EO		30	8	EO		30	8	EO		24	8	EO		24	8	EO		
32	9	EO		32	8	EO		32	8	EO		32	8	EO		26	8	EO		26	8	EO		
21	8	EO		20	7	EO		20	7	EO		20	7	EO		16	7	EO		16	7	EO		
32	9	EO		32	8	EO		32	8	EO		32	8	EO		26	8	EO		26	8	EO		
32	9	EO		32	8	EO		32	8	EO		32	8	EO		26	8	EO		26	8	EO		
21	8	EO		20	7	EO		20	7	EO		20	7	EO		16	7	EO		16	7	EO		
11	7	OE		9	5	OE		9	5	OE		9	5	OE										
8	6	OE																						
21	8	EO		9	4	EO		9	4	EO		9	4	EO		7	4	EO		7	4	EO		
15	7	EO		12	6	EO		12	6	EO		12	6	EO		9	5	EO		9	5	EO		
8	6	OE																						
9	4	EO		9	4	EO		9	4	EO		9	4	EO		7	4	EO		7	4	EO		
8	4	EO		8	4	EO		8	4	EO		8	4	EO										
6	3	OE		5	3	OE		5	3	OE		5	3	OE		4	3	OE		4	3	OE		
8	5	OE		7	5	OE		7	5	OE		7	5	OE		5	5	OE		5	5	OE		
5	3	OE		3	3	OE		3	3	OE		3	3	OE										
24	12	EO		21	12	EO		21	12	EO		21	12	EO		17	10	EO		17	10	EO		
18	12	EO		16	10	EO		16	10	EO		16	10	EO		13	9	EO		13	9	EO		
30	12	EO		26	12	EO		26	12	EO		26	12	EO		21	10	EO		21	10	EO		
24	12	EO		21	12	EO		21	12	EO		21	12	EO		17	10	EO		17	10	EO		
24	12	EO		21	12	EO		21	12	EO		21	12	EO		17	10	EO		17	10	EO		
18	12	EO		16	10	EO		16	10	EO		16	10	EO		13	9	EO		13	9	EO		
21	12	EO		19	12	EO		19	12	EO		19	12	EO		15	10	EO		15	10	EO		
63	16	EO		63	16	EO		63	16	EO		63	16	EO		53	12	EO		53	12	EO		
63	16	EO		63	16	EO		63	16	EO		63	16	EO		53	12	EO		53	12	EO		
42	12	EO		42	12	EO		42	12	EO		42	12	EO		34	12	EO		34	12	EO		
30	12	EO		30	12	EO		30	12	EO		30	12	EO		24	10	EO		24	10	EO		
				20	12	EO		20	12	EO		20	12	EO		10	10	EO		10	10	EO		
30	12		ML	30	12		ML	30	12		ML	30	12		ML	24	10		ML	24	10		ML	
48	6	EO		48	5	EO		48	5	EO		48	5	EO		38	5	EO		38	5	EO		
38	12	EO		34	10	EO		34	10	EO		34	10	EO		28	9	EO		28	9	EO		
67	12	EO	ML	60	12	EO	ML	60	12	EO	ML	60	12	EO	ML	48	10	EO	ML	48	10	EO	ML	
15	7	EO		10	4	EO		10	4	EO		10	4	EO		7	4	EO		7	4	EO		
6	3	OE		5	3	OE		5	3	OE		5	3	OE		4	3	OE		4	3	OE		
6	3	OE		5	3	OE		5	3	OE		5	3	OE		4	3	OE		4	3	OE		
10	4	EO		8	4	EO		8	4	EO		8	4	EO		6	4	EO		6	4	EO		
6	4	OE		5	4	OE		5	4	OE		5	4	OE										
15	7	EO		10	4	EO		10	4	EO		10	4	EO		7	4	EO		7	4	EO		
15	7	EO		10	4	EO		10	4	EO		10	4	EO		7	4	EO		7	4	EO		
40	12	EO		40	12	EO		40	12	EO		40	12	EO		30	12	EO		30	12	EO		
24	8		L	24	8		L	24	8		L	24	8		L	19	8		L	19	8		L	
24	8		L																					

Cutting data for core drilling and countersinks

Material group	= cutting data for wet machining = dry machining is possible, cutting data must be selected from TEC			Dimensions			DIN 344			DIN 343		
	E = emulsion O = oil M = MQL L = dry			Designation			E1111			E3111		
	v _c = cutting speed V _{CCR} = v _c rating chart from page B 382 V _{RR} = feed rating chart from page B 384			Form			N			N		
	Grouping of main material groups and identification letters			Brinell hardness HB Tensile strength R _m N/mm ² Machining group ¹								
Workpiece material												
						v _c VRR			v _c VRR			
P	Non-alloyed steel	C ≤ 0.25 %	annealed	125	428	P1	28	7	EO	28	7	EO
		C > 0.25... ≤ 0.55 %	annealed	190	639	P2	28	8	EO	28	8	EO
		C > 0.25... ≤ 0.55 %	tempered	210	708	P3	26	8	EO	26	8	EO
		C > 0.55 %	annealed	190	639	P4	28	8	EO	28	8	EO
		C > 0.55 %	tempered	300	1013	P5	17	7	EO	17	7	EO
	Low alloy steel	machining steel (short-chipping)	annealed	220	745	P6	28	7	EO	28	7	EO
			annealed	175	591	P7	28	8	EO	28	8	EO
			tempered	300	1013	P8	17	7	EO	17	7	EO
			tempered	380	1282	P9	6	5	OE	6	5	OE
			tempered	430	1477	P10						
	High-alloyed steel and high-alloyed tool steel	annealed	200	675	P11	7	3	EO	7	3	EO	
		hardened and tempered	300	1013	P12	9	5	EO	9	5	EO	
		hardened and tempered	400	1361	P13	3	4	OE	3	4	OE	
	Stainless steel	ferritic/martensitic, annealed	200	675	P14	7	3	EO	7	3	EO	
		martensitic, tempered	330	1114	P15	6	3	EO	6	3	EO	
M	Stainless steel	austenitic, quench hardened	200	675	M1	4	3	OE	4	3	OE	
		austenitic, precipitation hardened (PH)	300	1013	M2	5	5	OE	5	5	OE	
		austenitic/ferritic, duplex	230	778	M3	3	3	OE	3	3	OE	
K	Malleable cast iron	ferritic	200	675	K1	18	10	EO	18	10	EO	
		pearlitic	260	867	K2	13	9	EO	13	9	EO	
	grey cast iron	low tensile strength	180	602	K3	22	10	EO	22	10	EO	
		high tensile strength/austenitic	245	825	K4	18	10	EO	18	10	EO	
	Cast iron with spheroidal graphite	ferritic	155	518	K5	18	10	EO	18	10	EO	
		pearlitic	265	885	K6	13	9	EO	13	9	EO	
GGV (CGI)		200	675	K7	16	10	EO	16	10	EO		
N	Aluminium wrought alloys	cannot be hardened	30	-	N1	56	12	EO	56	12	EO	
		hardenable, hardened	100	343	N2	56	12	EO	56	12	EO	
	Cast aluminium alloys	≤ 12 % Si, not precipitation hardenable	75	260	N3	36	12	EO	36	12	EO	
		≤ 12 % Si, precipitation hardenable, precipitation hardened	90	314	N4	25	10	EO	25	10	EO	
		> 12 % Si, not precipitation hardenable	130	447	N5							
	Magnesium alloys		70	250	N6	25	10	ML	25	10	EO ML	
	Copper and copper alloys (bronze/brass)	non-alloyed, electrolytic copper	100	343	N7	40	4	EO	40	4	EO	
brass, bronze, red brass		90	314	N8	28	9	EO	28	9	EO		
Cu-alloys, short-chipping		110	382	N9	50	10	EO ML	50	10	EO ML		
high-strength, Ampco		300	1013	N10	7	3	EO	7	3	EO		
S	Heat-resistant alloys	Fe-based	annealed	200	675	S1	4	3	OE	4	3	OE
			hardened	280	943	S2	2	3	OE	2	3	OE
		Ni or Co base	annealed	250	839	S3	4	3	OE	4	3	OE
			hardened	350	1177	S4						
			cast	320	1076	S5						
	Titanium alloys	pure titanium	200	675	S6	6	4	EO	6	4	EO	
		α and β alloys, hardened	375	1262	S7	4	4	OE	4	4	OE	
		β alloys	410	1396	S8							
Tungsten alloys		300	1013	S9	7	3	EO	7	3	EO		
Molybdenum alloys		300	1013	S10	7	3	EO	7	3	EO		
H	Hardened steel	hardened and tempered	50 HRC	-	H1							
		hardened and tempered	55 HRC	-	H2							
		hardened and tempered	60 HRC	-	H3							
	Hardened cast iron	hardened and tempered	55 HRC	-	H4							
O	Thermoplasts	without abrasive fillers			O1	32	12	EO	32	12	EO	
	Thermosetting plastics	without abrasive fillers			O2	20	8	L	20	8	L	
	Plastic, glass-fibre reinforced	GFRP			O3							
	Plastic, carbon fibre reinforced	CFRP			O4							
	Plastic, aramide fibre reinforced	AFRP			O5							
	Graphite (technical)		80 Shore		O6							

¹ The machining groups are assigned from page H 8 onwards.

The specified cutting data are recommended values.
For specific applications, adjustment is recommended.

DIN 335				DIN 334				DIN 335				DIN 334							
E6819TIN				E6819				E6818				E7819				E7818			
C 90° 6,00 – 31,00 HSS TIN B 289				C 90° 4,30 – 31,00 HSS uncoated B 288				C 60° 6,30 – 25,00 HSS uncoated B 287				D 90° 15,00 – 80,00 HSS uncoated B 291				D 60° 16,00 – 80,00 HSS uncoated B 290			
v _c		VRR		v _c		VRR		v _c		VRR		v _c		VRR		v _c		VRR	
26	8	EO		21	7	EO		21	7	EO		21	7	EO		21	7	EO	
26	9	EO		21	8	EO		21	8	EO		21	8	EO		21	8	EO	
24	9	EO		20	8	EO		20	8	EO		20	8	EO		20	8	EO	
26	9	EO		21	8	EO		21	8	EO		21	8	EO		21	8	EO	
18	8	EO		14	7	EO		14	7	EO		14	7	EO		14	7	EO	
26	9	EO		21	8	EO		21	8	EO		21	8	EO		21	8	EO	
26	9	EO		21	8	EO		21	8	EO		21	8	EO		21	8	EO	
18	8	EO		14	7	EO		14	7	EO		14	7	EO		14	7	EO	
12	5	EO		8	6	OE		8	6	OE		8	6	OE		8	6	OE	
5,6	4	EO																	
6	4	EO		6	4	EO		6	4	EO		6	4	EO		6	4	EO	
14	6	EO		10	6	EO		10	6	EO		10	6	EO		10	6	EO	
6	4	EO		5	5	OE		5	5	OE		5	5	OE		5	5	OE	
6	4	EO		6	4	EO		6	4	EO		6	4	EO		6	4	EO	
6	4	EO		5	4	EO		5	4	EO		5	4	EO		5	4	EO	
5	4	OE		4	3	OE		4	3	OE		4	3	OE		4	3	OE	
9	5	OE		5	5	OE		5	5	OE		5	5	OE		5	5	OE	
4	4	OE		4	3	OE		4	3	OE		4	3	OE		4	3	OE	
24	12	EO		15	12	EO		15	12	EO		15	12	EO		15	12	EO	
18	10	EO		12	10	EO		12	10	EO		12	10	EO		12	10	EO	
30	12	EO		19	12	EO		19	12	EO		19	12	EO		19	12	EO	
24	12	EO		15	12	EO		15	12	EO		15	12	EO		15	12	EO	
24	12	EO		15	12	EO		15	12	EO		15	12	EO		15	12	EO	
18	10	EO		12	10	EO		12	10	EO		12	10	EO		12	10	EO	
21	12	EO		14	12	EO		14	12	EO		14	12	EO		14	12	EO	
60	12	EO		42	12	EO		42	12	EO		42	12	EO		42	12	EO	
60	12	EO		42	12	EO		42	12	EO		42	12	EO		42	12	EO	
35	12	EO		26	12	EO		26	12	EO		26	12	EO		26	12	EO	
25	12	EO		19	10	EO		19	10	EO		19	10	EO		19	10	EO	
10	12	EO		8	12	EO		8	12	EO		8	12	EO		8	12	EO	
25	12		ML	25	12		ML	25	12		ML	25	12		ML	25	12		ML
38	5	EO		30	5	EO		30	5	EO		30	5	EO		30	5	EO	
30	10	EO		25	10	EO		25	10	EO		25	10	EO		25	10	EO	
48	12	EO	ML	42	12	EO	ML	42	12	EO	ML	42	12	EO	ML	42	12	EO	ML
14	6	EO		9	4	EO		9	4	EO		9	4	EO		9	4	EO	
5	4	OE		4	3	OE		4	3	OE		4	3	OE		4	3	OE	
3	3	OE		3	3	OE		3	3	OE		3	3	OE		3	3	OE	
5	4	OE		4	3	OE		4	3	OE		4	3	OE		4	3	OE	
2	3	OE		2	3	OE		2	3	OE		2	3	OE		2	3	OE	
8	4	OE		7	4	EO		7	4	EO		7	4	EO		7	4	EO	
5	4	OE		4	4	OE		4	4	OE		4	4	OE		4	4	OE	
10	4	OE		9	4	EO		9	4	EO		9	4	EO		9	4	EO	
10	4	OE		9	4	EO		9	4	EO		9	4	EO		9	4	EO	
26	12	EO		26	12	EO		26	12	EO		26	12	EO		26	12	EO	
24	8		L	15	7		L	15	7		L	15	7		L	15	7		L
24	8		L	15	7		L	15	7		L	15	7		L	15	7		L

Cutting data for centre drills

= cutting data for wet machining = dry machining is possible, cutting data must be selected from TEC E = emulsion O = oil M = MQL L = dry v _c = cutting speed V _{CR} = v _c rating chart from page B 382 V _{RR} = feed rating chart from page B 384			Dimensions			DIN 333						
			Designation			K1161						
			Form			A						
			Type			Solid carbide						
			Dia. range (mm)			0,50 – 6,30						
			Cutting tool material			K10/20						
			Coating			uncoated						
			Page			B 298						
Material group	Grouping of main material groups and identification letters		Brinell hardness HB	Tensile strength R _m N/mm ²	Machining group ¹							
	Workpiece material					v _c	V _{RR}					
P	Non-alloyed steel	C ≤ 0.25 %	annealed	125	428	P1	48	6	E O	M L		
		C > 0.25... ≤ 0.55 %	annealed	190	639	P2	45	6	E O	M L		
		C > 0.25... ≤ 0.55 %	tempered	210	708	P3	42	6	E O	M L		
		C > 0.55 %	annealed	190	639	P4	45	6	E O	M L		
		C > 0.55 %	tempered	300	1013	P5	32	5	E O	M L		
	Low alloy steel	machining steel (short-chipping)	annealed	220	745	P6	48	6	E O	M L		
		annealed		175	591	P7	45	6	E O	M L		
		tempered		300	1013	P8	32	5	E O	M L		
		tempered		380	1282	P9	21	3	O E			
		tempered		430	1477	P10	16	2	O E			
		High-alloyed steel and high-alloyed tool steel	annealed		200	675	P11	28	4	E O		
			hardened and tempered		300	1013	P12	25	4	E O		
			hardened and tempered		400	1361	P13	16	2	O E		
	Stainless steel	ferritic/martensitic, annealed		200	675	P14	28	4	E O			
		martensitic, tempered		330	1114	P15	21	3	E O			
M	Stainless steel	austenitic, quench hardened		200	675	M1						
		austenitic, precipitation hardened (PH)		300	1013	M2	21	3	E O			
		austenitic/ferritic, duplex		230	778	M3						
K	Malleable cast iron	ferritic		200	675	K1	40	8	E O	M L		
		pearlitic		260	867	K2	32	7	E O	M L		
	grey cast iron	low tensile strength		180	602	K3	48	8	E O	M L		
		high tensile strength/austenitic		245	825	K4	40	8	E O	M L		
	Cast iron with spheroidal graphite	ferritic		155	518	K5	40	8	E O	M L		
		pearlitic		265	885	K6	32	7	E O	M L		
GGV (CGI)			200	675	K7	36	8	E O	M L			
N	Aluminium wrought alloys	cannot be hardened		30	–	N1	130	5	E O			
		hardenable, hardened		100	343	N2	130	5	E O			
	Cast aluminium alloys	≤ 12 % Si, not precipitation hardenable		75	260	N3	105	7	E O			
		≤ 12 % Si, precipitation hardenable, precipitation hardened		90	314	N4	90	7	E O			
	Magnesium alloys	> 12 % Si, not precipitation hardenable		130	447	N5	71	7	E O			
				70	250	N6	90	7		M L		
Copper and copper alloys (bronze/brass)	non-alloyed, electrolytic copper		100	343	N7	90	3	E O	M			
	brass, bronze, red brass		90	314	N8	75	6	E O				
	Cu-alloys, short-chipping		110	382	N9	80	8	E O	M L			
	high-strength, Ampco		300	1013	N10	32	5	E O				
S	Heat-resistant alloys	Fe-based	annealed	200	675	S1	22	2	O E			
			hardened	280	943	S2	15	2	O E			
		Ni or Co base	annealed	250	839	S3	18	2	O E			
			hardened	350	1177	S4	10	1	O E			
			cast	320	1076	S5	12	1	O E			
	Titanium alloys	pure titanium		200	675	S6						
		α and β alloys, hardened		375	1262	S7						
		β alloys		410	1396	S8						
Tungsten alloys			300	1013	S9	32	5	E O				
Molybdenum alloys			300	1013	S10	32	5	E O				
H	Hardened steel	hardened and tempered		50 HRC	–	H1	12,5	2	O E			
		hardened and tempered		55 HRC	–	H2						
		hardened and tempered		60 HRC	–	H3						
Hardened cast iron			55 HRC	–	H4							
O	Thermoplasts	without abrasive fillers				O1	45	7	E O			
	Thermosetting plastics	without abrasive fillers				O2	45	7	E O			
	Plastic, glass-fibre reinforced	GFRP				O3	35	6		L		
	Plastic, carbon fibre reinforced	CFRP				O4	25	5		L		
	Plastic, aramide fibre reinforced	AFRP				O5	45	7		L		
	Graphite (technical)			80 Shore			O6	25	5		L	

¹ The machining groups are assigned from page H 8 onwards.

The specified cutting data are recommended values. For specific applications, adjustment is recommended.

DIN 333																															
K1111TIN				K1111				K1112				K1131				K1113TIN				K1113				K1114				K1215			
A				A				A				A				R				R				R				B			
–				–				with flat				left-hand				–				–				with flat				–			
1,00 – 5,00				0,50 – 12,50				1,60 – 5,00				0,50 – 6,30				1,00 – 5,00				0,50 – 12,50				1,60 – 5,00				1,00 – 10,00			
HSS				HSS				HSS				HSS				HSS				HSS				HSS							
TiN				uncoated				uncoated				uncoated				TiN				uncoated				uncoated							
B 292				B 292				B 293				B 297				B 295				B 294				B 296				B 299			
v _c	VRR			v _c	VRR			v _c	VRR			v _c	VRR			v _c	VRR			v _c	VRR			v _c	VRR						
38	8	EO		30	7	EO		30	7	EO		30	7	EO		38	8	EO		30	7	EO		30	7	EO					
38	9	EO		30	8	EO		30	8	EO		30	8	EO		38	9	EO		30	8	EO		30	8	EO					
36	9	EO		28	8	EO		28	8	EO		28	8	EO		36	9	EO		28	8	EO		28	8	EO					
38	9	EO		30	8	EO		30	8	EO		30	8	EO		38	9	EO		30	8	EO		30	8	EO					
28	8	EO		20	7	EO		20	7	EO		20	7	EO		28	8	EO		20	7	EO		20	7	EO					
38	9	EO		30	8	EO		30	8	EO		30	8	EO		38	9	EO		30	8	EO		30	8	EO					
38	9	EO		30	8	EO		30	8	EO		30	8	EO		38	9	EO		30	8	EO		30	8	EO					
28	8	EO		20	7	EO		20	7	EO		20	7	EO		28	8	EO		20	7	EO		20	7	EO					
13	6	EO		11	6	OE		11	6	OE		11	6	OE		13	6	EO		11	6	OE		11	6	OE					
				7	5	OE		7	5	OE		7	5	OE						7	5	OE		7	5	OE					
9	4	EO		8	4	EO		8	4	EO		8	4	EO		9	4	EO		8	4	EO		8	4	EO					
21	6	EO		14	6	EO		14	6	EO		14	6	EO		21	6	EO		14	6	EO		14	6	EO					
				7	5	OE		7	5	OE		7	5	OE						7	5	OE		7	5	OE					
9	4	EO		8	4	EO		8	4	EO		8	4	EO		9	4	EO		8	4	EO		8	4	EO					
				7	4	EO		7	4	EO		7	4	EO						7	4	EO		7	4	EO					
7	4	OE		6	3	OE		6	3	OE		6	3	OE		7	4	OE		6	3	OE		6	3	OE					
13	5	OE		8	5	OE		8	5	OE		8	5	OE		13	5	OE		8	5	OE		8	5	OE					
6	4	OE		5	3	OE		5	3	OE		5	3	OE		6	4	OE		5	3	OE		5	3	OE					
34	12	EO		22	12	EO		22	12	EO		22	12	EO		34	12	EO		22	12	EO		22	12	EO					
26	10	EO		17	10	EO		17	10	EO		17	10	EO		26	10	EO		17	10	EO		17	10	EO					
42	12	EO		28	12	EO		28	12	EO		28	12	EO		42	12	EO		28	12	EO		28	12	EO					
34	12	EO		22	12	EO		22	12	EO		22	12	EO		34	12	EO		22	12	EO		22	12	EO					
34	12	EO		22	12	EO		22	12	EO		22	12	EO		34	12	EO		22	12	EO		22	12	EO					
26	10	EO		17	10	EO		17	10	EO		17	10	EO		26	10	EO		17	10	EO		17	10	EO					
30	12	EO		20	12	EO		20	12	EO		20	12	EO		30	12	EO		20	12	EO		20	12	EO					
79	12	EO		63	12	EO		63	12	EO		63	12	EO		79	12	EO		63	12	EO		63	12	EO					
79	12	EO		63	12	EO		63	12	EO		63	12	EO		79	12	EO		63	12	EO		63	12	EO					
50	12	EO		40	12	EO		40	12	EO		40	12	EO		50	12	EO		40	12	EO		40	12	EO					
35	10	EO		28	10	EO		28	10	EO		28	10	EO		35	10	EO		28	10	EO		28	10	EO					
35	10		ML	28	10		ML	28	10		ML	28	10		ML	35	10		ML	28	10		ML	28	10		ML				
56	5	EO		45	5	EO		45	5	EO		45	5	EO		56	5	EO		45	5	EO		45	5	EO					
				36	10	EO		36	10	EO		36	10	EO						36	10	EO		36	10	EO					
71	12	EO	ML	63	12	EO	ML	63	12	EO	ML	63	12	EO	ML	71	12	EO	ML	63	12	EO	ML	63	12	EO	ML				
21	6	EO		14	6	EO		14	6	EO		14	6	EO		21	6	EO		14	6	EO		14	6	EO					
7	4	OE		6	3	OE		6	3	OE		6	3	OE		7	4	OE		6	3	OE		6	3	OE					
4	3	OE		4	3	OE		6	3	OE		4	3	OE		4	3	OE		4	3	OE		4	3	OE					
				6	3	OE		6	3	OE		6	3	OE						6	3	OE		6	3	OE					
8	4	EO		8	4	EO		8	4	EO		8	4	EO		8	4	EO		8	4	EO		8	4	EO					
6	4	OE		6	4	OE		6	4	OE		6	4	OE		6	4	OE		6	4	OE		6	4	OE					
21	6	EO		14	6	EO		14	6	EO		14	6	EO		21	6	EO		14	6	EO		14	6	EO					
21	6	EO		14	6	EO		14	6	EO		14	6	EO		21	6	EO		14	6	EO		14	6	EO					
				38	12	EO		38	12	EO		38	12	EO						38	12	EO		38	12	EO					
34	8		L	22	7		L	22	7		L	22	7		L	34	8		L	22	7		L	22	7		L				
34	8		L	22	7		L	22	7		L	22	7		L	34	8		L	22	7		L	22	7		L				

Cutting data for centre drills

= cutting data for wet machining = dry machining is possible, cutting data must be selected from TEC E = emulsion O = oil M = MQL L = dry v _c = cutting speed VCRR = v _c rating chart from page B 382 VRR = feed rating chart from page B 384			Dimensions			Walter standard					
			Designation			K1313					
Form			R								
Dia. range (mm)			1,00 – 4,00								
Cutting tool material			HSS								
Coating			uncoated								
Page			B 301								
Material group	Grouping of main material groups and identification letters		Brinell hardness HB	Tensile strength R _m N/mm ²	Machining group ¹						
	Workpiece material					v _c	VRR				
P	Non-alloyed steel	C ≤ 0.25 %	annealed	125	428	P1	30	7	E O		
		C > 0.25... ≤ 0.55 %	annealed	190	639	P2	30	8	E O		
		C > 0.25... ≤ 0.55 %	tempered	210	708	P3	28	8	E O		
		C > 0.55 %	annealed	190	639	P4	30	8	E O		
		C > 0.55 %	tempered	300	1013	P5	20	7	E O		
	Low alloy steel	machining steel (short-chipping)		annealed	220	745	P6	30	8	E O	
				annealed	175	591	P7	30	8	E O	
				tempered	300	1013	P8	20	7	E O	
				tempered	380	1282	P9	11	6	O E	
				tempered	430	1477	P10	7	5	O E	
		High-alloyed steel and high-alloyed tool steel		annealed	200	675	P11	8	4	E O	
				hardened and tempered	300	1013	P12	14	6	E O	
				hardened and tempered	400	1361	P13	7	5	O E	
		Stainless steel		ferritic/martensitic, annealed	200	675	P14	8	4	E O	
				martensitic, tempered	330	1114	P15	7	4	E O	
M	Stainless steel		austenitic, quench hardened	200	675	M1	6	3	O E		
			austenitic, precipitation hardened (PH)	300	1013	M2	8	5	O E		
			austenitic/ferritic, duplex	230	778	M3	4,8	3	O E		
K	Malleable cast iron		ferritic	200	675	K1	22	12	E O		
			pearlitic	260	867	K2	17	10	E O		
	grey cast iron		low tensile strength	180	602	K3	28	12	E O		
			high tensile strength/austenitic	245	825	K4	22	12	E O		
	Cast iron with spheroidal graphite		ferritic	155	518	K5	22	12	E O		
			pearlitic	265	885	K6	17	10	E O		
		GGV (CGI)			200	675	K7	20	12	E O	
N	Aluminium wrought alloys		cannot be hardened	30	–	N1	63	12	E O		
			hardenable, hardened	100	343	N2	63	12	E O		
	Cast aluminium alloys		≤ 12 % Si, not precipitation hardenable	75	260	N3	40	12	E O		
			≤ 12 % Si, precipitation hardenable, precipitation hardened	90	314	N4	28	10	E O		
			> 12 % Si, not precipitation hardenable	130	447	N5					
		Magnesium alloys			70	250	N6	28	10		M L
	Copper and copper alloys (bronze/brass)		non-alloyed, electrolytic copper		100	343	N7	45	5	E O	
		brass, bronze, red brass		90	314	N8	36	10	E O		
		Cu-alloys, short-chipping		110	382	N9	63	12	E O	M L	
	high-strength, Ampco			300	1013	N10	14	6	E O		
S	Heat-resistant alloys	Fe-based	annealed	200	675	S1	6	3	O E		
			hardened	280	943	S2	4	3	O E		
		Ni or Co base	annealed	250	839	S3	6	3	O E		
			hardened	350	1177	S4					
			cast	320	1076	S5					
	Titanium alloys		pure titanium		200	675	S6	8	4	E O	
			α and β alloys, hardened		375	1262	S7	6	4	O E	
			β alloys		410	1396	S8				
		Tungsten alloys			300	1013	S9	14	6	E O	
		Molybdenum alloys			300	1013	S10	14	6	E O	
H	Hardened steel		hardened and tempered	50 HRC	–	H1					
			hardened and tempered	55 HRC	–	H2					
			hardened and tempered	60 HRC	–	H3					
		Hardened cast iron		hardened and tempered	55 HRC	–	H4				
O	Thermoplasts		without abrasive fillers			O1	38	12	E O		
	Thermosetting plastics		without abrasive fillers			O2	22	7		L	
	Plastic, glass-fibre reinforced		GFRP			O3					
	Plastic, carbon fibre reinforced		CFRP			O4					
	Plastic, aramide fibre reinforced		AFRP			O5	22	7		L	
	Graphite (technical)				80 Shore		O6				

¹ The machining groups are assigned from page H 8 onwards.

The specified cutting data are recommended values.
For specific applications, adjustment is recommended.

	Walter standard												ANSI B 94.11-1979			B.S. 328			Step centre drill								
	K1311			K1411S			K1411M			K1411L			K1811			K1911			K2511			K2513					
	A			A			A			A			A			A			60°			Radius					
	0,63 – 6,00			0,75 – 5,00			0,75 – 4,00			2,00 – 4,00			0,64 – 7,97			1,19 – 7,94			3,30 – 21,00			3,30 – 21,00					
	HSS			HSS			HSS			HSS			HSS			HSS			HSS			HSS					
	uncoated			uncoated			uncoated			uncoated			uncoated			uncoated			uncoated			uncoated					
	B 300			B 304			B 303			B 302			B 305			B 306			B 307			B 308					
	v _c	VRR		v _c	VRR		v _c	VRR		v _c	VRR		v _c	VRR		v _c	VRR		v _c	VRR		v _c	VRR				
30	7	EO		30	7	EO		30	7	EO		30	7	EO		30	7	EO		30	7	EO		30	7	EO	
30	8	EO		30	8	EO		30	8	EO		30	8	EO		30	8	EO		30	8	EO		30	8	EO	
28	8	EO		28	8	EO		28	8	EO		28	8	EO		28	8	EO		28	8	EO		28	8	EO	
30	8	EO		30	8	EO		30	8	EO		30	8	EO		30	8	EO		30	8	EO		30	8	EO	
20	7	EO		20	7	EO		20	7	EO		20	7	EO		20	7	EO		20	7	EO		20	7	EO	
30	8	EO		30	8	EO		30	8	EO		30	8	EO		30	8	EO		30	8	EO		30	8	EO	
30	8	EO		30	8	EO		30	8	EO		30	8	EO		30	8	EO		30	8	EO		30	8	EO	
20	7	EO		20	7	EO		20	7	EO		20	7	EO		20	7	EO		20	7	EO		20	7	EO	
11	6	OE		11	6	OE		11	6	OE		11	6	OE		11	6	OE		11	6	OE		11	6	OE	
7	5	OE		7	5	OE		7	5	OE		7	5	OE		7	5	OE		7	5	OE		7	5	OE	
8	4	EO		8	4	EO		8	4	EO		8	4	EO		8	4	EO		8	4	EO		8	4	EO	
14	6	EO		14	6	EO		14	6	EO		14	6	EO		14	6	EO		14	6	EO		14	6	EO	
7	5	OE		7	5	OE		7	5	OE		7	5	OE		7	5	OE		7	5	OE		7	5	OE	
8	4	EO		8	4	EO		8	4	EO		8	4	EO		8	4	EO		8	4	EO		8	4	EO	
7	4	EO		7	4	EO		7	4	EO		7	4	EO		7	4	EO		7	4	EO		7	4	EO	
6	3	OE		6	3	OE		6	3	OE		6	3	OE		6	3	OE		6	3	OE		6	3	OE	
8	5	OE		8	5	OE		8	5	OE		8	5	OE		8	5	OE		8	5	OE		8	5	OE	
4,8	3	OE		4,8	3	OE		4,8	3	OE		4,8	3	OE		5	3	OE		4,8	3	OE		4,8	3	OE	
22	12	EO		22	12	EO		22	12	EO		22	12	EO		22	12	EO		22	12	EO		22	12	EO	
17	10	EO		17	10	EO		17	10	EO		17	10	EO		17	10	EO		17	10	EO		17	10	EO	
28	12	EO		28	12	EO		28	12	EO		28	12	EO		28	12	EO		28	12	EO		28	12	EO	
22	12	EO		22	12	EO		22	12	EO		22	12	EO		22	12	EO		22	12	EO		22	12	EO	
22	12	EO		22	12	EO		22	12	EO		22	12	EO		22	12	EO		22	12	EO		22	12	EO	
17	10	EO		17	10	EO		17	10	EO		17	10	EO		17	10	EO		17	10	EO		17	10	EO	
20	12	EO		20	12	EO		20	12	EO		20	12	EO		20	12	EO		20	12	EO		20	12	EO	
63	12	EO		63	12	EO		63	12	EO		63	12	EO		63	12	EO		63	12	EO		63	12	EO	
63	12	EO		63	12	EO		63	12	EO		63	12	EO		63	12	EO		63	12	EO		63	12	EO	
40	12	EO		40	12	EO		40	12	EO		40	12	EO		40	12	EO		40	12	EO		40	12	EO	
28	10	EO		28	10	EO		28	10	EO		28	10	EO		28	10	EO		28	10	EO		28	10	EO	
28	10		ML	28	10		ML	28	10		ML	28	10		ML	28	10		ML	28	10		ML	28	10		ML
45	5	EO		45	5	EO		45	5	EO		45	5	EO		45	5	EO		45	5	EO		45	5	EO	
36	10	EO		36	10	EO		36	10	EO		36	10	EO		36	10	EO		36	10	EO		36	10	EO	
63	12	EO	ML	63	12	EO	ML	63	12	EO	ML	63	12	EO	ML	63	12	EO	ML	63	12	EO	ML	63	12	EO	ML
14	6	EO		14	6	EO		14	6	EO		14	6	EO		14	6	EO		14	6	EO		14	6	EO	
6	3	OE		6	3	OE		6	3	OE		6	3	OE		6	3	OE		6	3	OE		6	3	OE	
4	3	OE		4	3	OE		4	3	OE		4	3	OE		4	3	OE		4	3	OE		4	3	OE	
6	3	OE		6	3	OE		6	3	OE		6	3	OE		6	3	OE		6	3	OE		6	3	OE	
8	4	EO		8	4	EO		8	4	EO		8	4	EO		8	4	EO		8	4	EO		8	4	EO	
6	4	OE		6	4	OE		6	4	OE		6	4	OE		6	4	OE		6	4	OE		6	4	OE	
14	6	EO		14	6	EO		14	6	EO		14	6	EO		14	6	EO		14	6	EO		14	6	EO	
14	6	EO		14	6	EO		14	6	EO		14	6	EO		14	6	EO		14	6	EO		14	6	EO	
38	12	EO		38	12	EO		38	12	EO		38	12	EO		38	12	EO		38	12	EO		38	12	EO	
22	7		L	22	7		L	22	7		L	22	7		L	22	7		L	22	7		L	22	7		L
22	7		L	22	7		L	22	7		L	22	7		L	22	7		L	22	7		L	22	7		L

Cutting data for reamers

Material group	= cutting data for wet machining = dry machining is possible, cutting data must be selected from TEC E = emulsion O = oil M = MQL L = dry v _c = cutting speed VCRR = v _c rating chart from page B 382 VRR = feed rating chart from page B 384			Dimensions			Walter standard							
				Designation			F1362			F1371				
				Form			A / C			B / D				
				Type			Straight flute			Left-hand spiral				
Dia. range (mm)			2,00 – 20,00			2,00 – 20,00								
Cutting tool material			K10			K10								
Coating			uncoated			uncoated								
Page			B 332			B 333								
Grouping of main material groups and identification letters			Brinell hardness HB	Tensile strength R _m N/mm ²	Machining group ¹									
Workpiece material						v _c	VRR			v _c	VRR			
P	Non-alloyed steel	C ≤ 0.25 %	annealed	125	428	P1	24	8	EO		24	8	EO	
		C > 0.25... ≤ 0.55 %	annealed	190	639	P2	22	8	EO		22	8	EO	
		C > 0.25... ≤ 0.55 %	tempered	210	708	P3	21	8	EO		21	8	EO	
		C > 0.55 %	annealed	190	639	P4	22	8	EO		22	8	EO	
		C > 0.55 %	tempered	300	1013	P5	16	8	EO		16	8	EO	
	Low alloy steel	machining steel (short-chipping)	annealed	220	745	P6	24	8	EO		24	8	EO	
		annealed		175	591	P7	22	8	EO		22	8	EO	
		tempered		300	1013	P8	16	8	EO		16	8	EO	
		tempered		380	1282	P9	10	8	OE		10	8	OE	
	High-alloyed steel and high-alloyed tool steel	tempered		430	1477	P10	6	8	OE		6	8	OE	
		annealed		200	675	P11	14	8	EO		14	8	EO	
		hardened and tempered		300	1013	P12	12	8	EO		12	8	EO	
	Stainless steel	hardened and tempered		400	1361	P13	8	8	OE		8	8	OE	
		ferritic/martensitic, annealed		200	675	P14	14	8	EO		14	8	EO	
		martensitic, tempered		330	1114	P15	10	8	EO		10	8	EO	
M	Stainless steel	austenitic, quench hardened		200	675	M1	8	8			8	8		
		austenitic, precipitation hardened (PH)		300	1013	M2	12	8			12	8		
		austenitic/ferritic, duplex		230	778	M3	6	8			6	8		
K	Malleable cast iron	ferritic		200	675	K1	20	8	EO		20	8	EO	
		pearlitic		260	867	K2	16	8	EO		16	8	EO	
	grey cast iron	low tensile strength		180	602	K3	24	8	EO		24	8	EO	
		high tensile strength/austenitic		245	825	K4	20	8	EO		20	8	EO	
	Cast iron with spheroidal graphite	ferritic		155	518	K5	20	8	EO		20	8	EO	
		pearlitic		265	885	K6	16	8	EO		16	8	EO	
GGV (CGI)			200	675	K7	18	8	EO		18	8	EO		
N	Aluminium wrought alloys	cannot be hardened		30	–	N1	63	10	EO		63	10	EO	
		hardenable, hardened		100	343	N2	63	10	EO		63	10	EO	
	Cast aluminium alloys	≤ 12 % Si, not precipitation hardenable		75	260	N3	50	10	EO		50	10	EO	
		≤ 12 % Si, precipitation hardenable, precipitation hardened		90	314	N4	45	10	EO		45	10	EO	
		> 12 % Si, not precipitation hardenable		130	447	N5	36	10	EO		36	10	EO	
	Magnesium alloys		70	250	N6	45	10	O		45	10	O		
Copper and copper alloys (bronze/brass)	non-alloyed, electrolytic copper		100	343	N7	45	10	EO		45	10	EO		
	brass, bronze, red brass		90	314	N8	36	10	EO		36	10	EO		
	Cu-alloys, short-chipping		110	382	N9	40	10	EO		40	10	EO		
	high-strength, Ampco		300	1013	N10	12	10	EO		12	10	EO		
S	Heat-resistant alloys	Fe-based	annealed	200	675	S1	12	8	EO		12	8	EO	
			hardened	280	943	S2	10	8	EO		10	8	EO	
		Ni or Co base	annealed	250	839	S3	10	8	EO		10	8	EO	
			hardened	350	1177	S4	6	8	EO		6	8	EO	
			cast	320	1076	S5	6	8	EO		6	8	EO	
	Titanium alloys	pure titanium		200	675	S6	10	8	EO		10	8	EO	
		α and β alloys, hardened		375	1262	S7	8	8	EO		8	8	EO	
β alloys			410	1396	S8	6	8	EO		6	8	EO		
Tungsten alloys		300	1013	S9	12	8	EO		12	8	EO			
Molybdenum alloys		300	1013	S10	12	8	EO		12	8	EO			
H	Hardened steel	hardened and tempered		50 HRC	–	H1								
		hardened and tempered		55 HRC	–	H2								
		hardened and tempered		60 HRC	–	H3								
Hardened cast iron		55 HRC	–	H4										
O	Thermoplasts	without abrasive fillers				O1	22	8	E		22	8	E	
	Thermosetting plastics	without abrasive fillers				O2	22	8		L	22	8	L	
	Plastic, glass-fibre reinforced	GFRP				O3	16	8		L	16	8	L	
	Plastic, carbon fibre reinforced	CFRP				O4								
	Plastic, aramide fibre reinforced	AFRP				O5								
	Graphite (technical)			80 Shore			O6							

¹ The machining groups are assigned from page H 8 onwards.

The specified cutting data are recommended values.
For specific applications, adjustment is recommended.

Walter standard			DIN 212						DIN 208														
F4162			F4171			F1342			F1352 F1352HUN			F1353			F4142			F4152			F4153		
A			B			A / C			B / D			E			A			B			C		
Straight flute			Left-hand spiral			Straight flute			Left-hand spiral			Quick helix			Straight flute			Left-hand spiral			Quick helix		
5,00 – 32,00			5,00 – 20,00			1,00 – 20,00			0,90 – 20,00			1,00 – 20,00			5,00 – 32,00			5,00 – 40,00			5,00 – 32,00		
K10			K10			HSS-E			HSS-E			HSS-E			HSS-E			HSS-E			HSS-E		
uncoated			uncoated			uncoated			uncoated			uncoated			uncoated			uncoated			uncoated		
B 341			B 342			B 322			B 325/B 329			B 330			B 337			B 338			B 340		
v _c	VRR		v _c	VRR		v _c	VRR		v _c	VRR		v _c	VRR		v _c	VRR		v _c	VRR		v _c	VRR	
24	8	EO	24	8	EO	14	8	EO	14	8	EO	14	8	EO	14	8	EO	14	8	EO	14	8	EO
22	8	EO	22	8	EO	14	8	EO	14	8	EO	14	8	EO	14	8	EO	14	8	EO	14	8	EO
21	8	EO	21	8	EO	13	8	EO	13	8	EO	13	8	EO	13	8	EO	13	8	EO	13	8	EO
22	8	EO	22	8	EO	14	8	EO	14	8	EO	14	8	EO	14	8	EO	14	8	EO	14	8	EO
16	8	EO	16	8	EO																		
24	8	EO	24	8	EO	14	8	EO	14	8	EO	14	8	EO	14	8	EO	14	8	EO	14	8	EO
22	8	EO	22	8	EO	14	8	EO	14	8	EO	14	8	EO	14	8	EO	14	8	EO	14	8	EO
16	8	EO	16	8	EO	10	8	EO	10	8	EO				10	8	EO	10	8	EO			
10	8	OE	10	8	OE																		
6	8	OE	6	8	OE																		
14	8	EO	14	8	EO	4	8	EO	4	8	EO				4	8	EO	4	8	EO			
12	8	EO	12	8	EO																		
8	8	OE	8	8	OE																		
14	8	EO	14	8	EO	4	8	EO	4	8	EO				4	8	EO	4	8	EO			
10	8	EO	10	8	EO																		
8	8		8	8																			
12	8		12	8																			
6	8		6	8																			
20	8	EO	20	8	EO	11	8	EO	11	8	EO				11	8	EO	11	8	EO			
16	8	EO	16	8	EO	8	8	EO	8	8	EO				8	8	EO	8	8	EO			
24	8	EO	24	8	EO	13	8	EO	13	8	EO				13	8	EO	13	8	EO			
20	8	EO	20	8	EO	11	8	EO	11	8	EO				11	8	EO	11	8	EO			
20	8	EO	20	8	EO	11	8	EO	11	8	EO				11	8	EO	11	8	EO			
16	8	EO	16	8	EO	8	8	EO	8	8	EO				8	8	EO	8	8	EO			
18	8	EO	18	8	EO	10	8	EO	10	8	EO				10	8	EO	10	8	EO			
63	10	EO	63	10	EO	28	10	EO	28	10	EO	28	10	EO	28	10	EO	28	10	EO	28	10	EO
63	10	EO	63	10	EO	28	10	EO	28	10	EO	28	10	EO	28	10	EO	28	10	EO	28	10	EO
50	10	EO	50	10	EO	18	10	EO	18	10	EO	18	10	EO	18	10	EO	18	10	EO	18	10	EO
45	10	EO	45	10	EO	13	10	EO	13	10	EO	13	10	EO	13	10	EO	13	10	EO	13	10	EO
36	10	EO	36	10	EO																		
45	10	O	45	10	O	13	10	O	13	10	O	13	10	O	13	10	O	13	10	O	13	10	O
45	10	EO	45	10	EO	21	10	EO	21	10	EO	21	10	EO	21	10	EO	21	10	EO	21	10	EO
36	10	EO	36	10	EO	17	10	EO	17	10	EO	17	10	EO	17	10	EO	17	10	EO	17	10	EO
40	10	EO	40	10	EO	30	10	EO	30	10	EO	30	10	EO	30	10	EO	30	10	EO	30	10	EO
12	10	EO	12	10	EO																		
12	8	EO	12	8	EO																		
10	8	EO	10	8	EO																		
10	8	EO	10	8	EO																		
6	8	EO	6	8	EO																		
6	8	EO	6	8	EO																		
10	8	EO	10	8	EO																		
8	8	EO	8	8	EO																		
6	8	EO	6	8	EO																		
12	8	EO	12	8	EO																		
12	8	EO	12	8	EO																		
22	8	E	22	8	E	18	8	E	18	8	E	18	8	E	18	8	E	18	8	E	18	8	E
22	8	L	22	8	L	11	8	L	11	8	L	11	8	L	11	8	L	11	8	L	11	8	L
16	8	L	16	8	L																		

Cutting data for reamers

= cutting data for wet machining = dry machining is possible, cutting data must be selected from TEC E = emulsion O = oil M = MQL L = dry v _c = cutting speed VCRR = v _c rating chart from page B 382 VRR = feed rating chart from page B 384			Dimensions			DIN 219			DIN 9					
			Designation			F7133			F3317					
Form			B			A								
Type			Left-hand spiral			Taper 1:50								
Dia. range (mm)			25.00 – 60.00			1.00 – 30.00								
Cutting tool material			HSS			HSS								
Coating			uncoated			uncoated								
Page			B 345/G 66			B 335								
Material group	Grouping of main material groups and identification letters		Brinell hardness HB	Tensile strength R _m N/mm ²	Machining group ¹									
	Workpiece material					v _c	VRR	E	O	M	L	v _c	VRR	E
P	Non-alloyed steel	C ≤ 0.25 %	annealed	125	428	P1	14	8	EO		8	8	EO	
		C > 0.25... ≤ 0.55 %	annealed	190	639	P2	14	8	EO		8	8	EO	
		C > 0.25... ≤ 0.55 %	tempered	210	708	P3	13	8	EO		8	8	EO	
		C > 0.55 %	annealed	190	639	P4	14	8	EO		8	8	EO	
		C > 0.55 %	tempered	300	1013	P5								
		machining steel (short-chipping)	annealed	220	745	P6	14	8	EO		8	8	EO	
	Low alloy steel	annealed	175	591	P7	14	8	EO		8	8	EO		
		tempered	300	1013	P8	10	8	EO		5	8	EO		
		tempered	380	1282	P9									
		tempered	430	1477	P10									
High-alloyed steel and high-alloyed tool steel	annealed	200	675	P11	4	8	EO		2	8	EO			
	hardened and tempered	300	1013	P12										
	hardened and tempered	400	1361	P13										
Stainless steel	ferritic/martensitic, annealed	200	675	P14	4	8	EO		2	8	EO			
	martensitic, tempered	330	1114	P15										
M	Stainless steel	austenitic, quench hardened	200	675	M1									
		austenitic, precipitation hardened (PH)	300	1013	M2									
		austenitic/ferritic, duplex	230	778	M3									
K	Malleable cast iron	ferritic	200	675	K1	11	8	EO		6	8	EO		
		pearlitic	260	867	K2	8	8	EO		5	8	EO		
	grey cast iron	low tensile strength	180	602	K3	13	8	EO		8	8	EO		
		high tensile strength/austenitic	245	825	K4	11	8	EO		6	8	EO		
	Cast iron with spheroidal graphite	ferritic	155	518	K5	11	8	EO		6	8	EO		
		pearlitic	265	885	K6	8	8	EO		5	8	EO		
	GGV (CGI)		200	675	K7	10	8	EO		5	8	EO		
N	Aluminium wrought alloys	cannot be hardened	30	–	N1	28	10	EO		16	10	EO		
		hardenable, hardened	100	343	N2	28	10	EO		16	10	EO		
	Cast aluminium alloys	≤ 12 % Si, not precipitation hardenable	75	260	N3	18	10	EO		11	10	EO		
		≤ 12 % Si, precipitation hardenable, precipitation hardened	90	314	N4	13	10	EO		8	10	EO		
		> 12 % Si, not precipitation hardenable	130	447	N5									
	Magnesium alloys		70	250	N6	13	10	O		8	10	O		
	Copper and copper alloys (bronze/brass)	non-alloyed, electrolytic copper	100	343	N7	21	10	EO		12	10	EO		
brass, bronze, red brass		90	314	N8	17	10	EO		10	10	EO			
Cu-alloys, short-chipping		110	382	N9	30	10	EO		17	10	EO			
high-strength, Ampco		300	1013	N10										
S	Heat-resistant alloys	Fe-based	annealed	200	675	S1								
			hardened	280	943	S2								
		Ni or Co base	annealed	250	839	S3								
			hardened	350	1177	S4								
			cast	320	1076	S5								
	Titanium alloys	pure titanium	200	675	S6									
		α and β alloys, hardened	375	1262	S7									
		β alloys	410	1396	S8									
	Tungsten alloys		300	1013	S9									
	Molybdenum alloys		300	1013	S10									
H	Hardened steel	hardened and tempered	50 HRC	–	H1									
		hardened and tempered	55 HRC	–	H2									
		hardened and tempered	60 HRC	–	H3									
	Hardened cast iron	hardened and tempered	55 HRC	–	H4									
O	Thermoplasts	without abrasive fillers			O1	18	8	E		10	8	E		
	Thermosetting plastics	without abrasive fillers			O2	11	8	L		6	8	L		
	Plastic, glass-fibre reinforced	GFRP			O3									
	Plastic, carbon fibre reinforced	CFRP			O4									
	Plastic, aramid fibre reinforced	AFRP			O5									
	Graphite (technical)		80 Shore			O6								

¹ The machining groups are assigned from page H 8 onwards.

The specified cutting data are recommended values.
For specific applications, adjustment is recommended.

DIN 2179				DIN 2180				DIN 311				Walter standard			
F3234				F6134				F4535				F3517			
-				-				-				-			
Taper 1:50 1,00 – 12,00 HSS-E uncoated B 334				Taper 1:50 5,00 – 20,00 HSS-E uncoated B 344				Bridge reamers 6,40 – 32,00 HSS uncoated B 343				Taper 1:10 5,00 – 23,00 HSS uncoated B 336			
v _c	VRR	EO		v _c	VRR	EO		v _c	VRR	EO		v _c	VRR	EO	
8	8	EO		8	8	EO		8	8	EO		8	8	EO	
8	8	EO		8	8	EO		8	8	EO		8	8	EO	
8	8	EO		8	8	EO		8	8	EO		8	8	EO	
8	8	EO		8	8	EO		8	8	EO		8	8	EO	
8	8	EO		8	8	EO		8	8	EO		8	8	EO	
8	8	EO		8	8	EO		8	8	EO		8	8	EO	
8	8	EO		8	8	EO		8	8	EO		8	8	EO	
5	8	EO		5	8	EO		5	8	EO		5	8	EO	
2	8	EO		2	8	EO		2	8	EO		2	8	EO	
2	8	EO		2	8	EO		2	8	EO		2	8	EO	
6	8	EO		6	8	EO		6	8	EO		6	8	EO	
5	8	EO		5	8	EO		5	8	EO		5	8	EO	
8	8	EO		8	8	EO		8	8	EO		8	8	EO	
6	8	EO		6	8	EO		6	8	EO		6	8	EO	
6	8	EO		6	8	EO		6	8	EO		6	8	EO	
5	8	EO		5	8	EO		5	8	EO		5	8	EO	
5	8	EO		5	8	EO		5	8	EO		5	8	EO	
16	10	EO		16	10	EO		16	10	EO		16	10	EO	
16	10	EO		16	10	EO		16	10	EO		16	10	EO	
11	10	EO		11	10	EO		11	10	EO		11	10	EO	
8	10	EO		8	10	EO		8	10	EO		8	10	EO	
8	10	O		8	10	O		8	10	O		8	10	O	
12	10	EO		12	10	EO		12	10	EO		12	10	EO	
10	10	EO		10	10	EO		10	10	EO		10	10	EO	
17	10	EO		17	10	EO		17	10	EO		17	10	EO	
10	8	E		10	8	E		10	8	E		10	8	E	
6	8		L	6	8		L	6	8		L	6	8		L

VCCR: speed diagram Solid carbide micro-drill

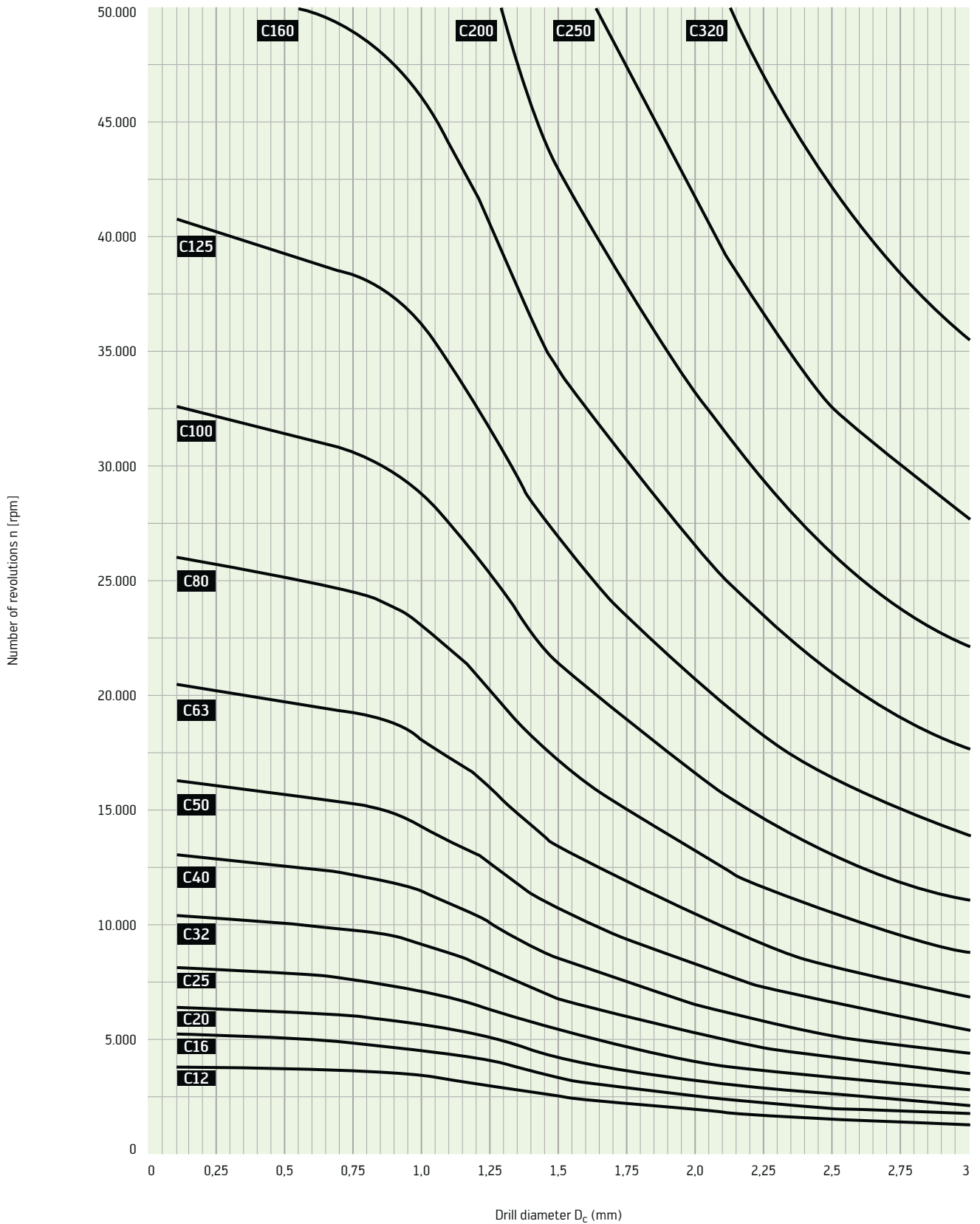

VCRR: speed diagram HSS micro-drill

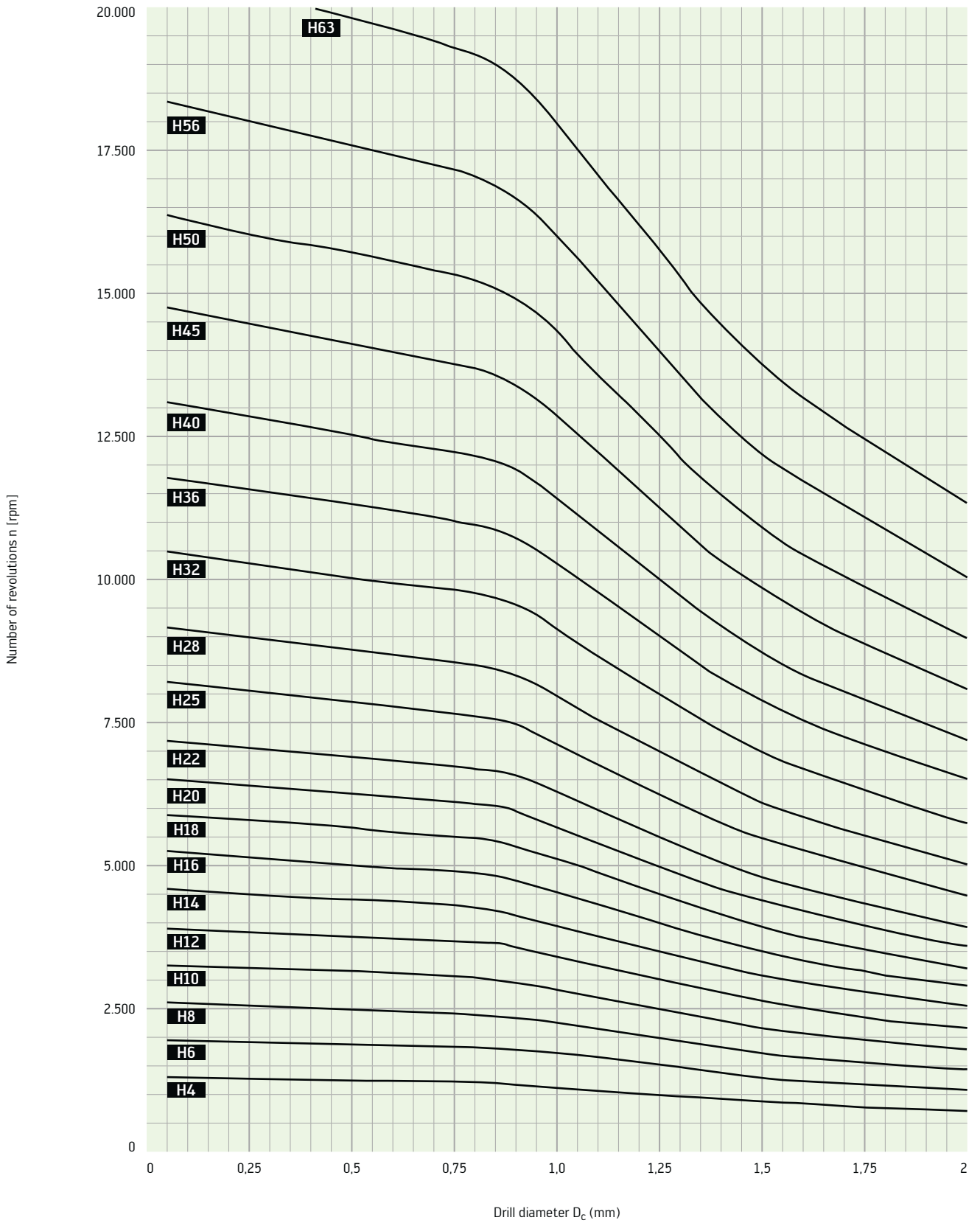

VRR: feed rating charts for HSS and carbide drills, core drills, countersinks and centre drills

VRR	Feed f (mm) for dia. (mm)														
	0,05	0,06	0,08	0,1	0,12	0,15	0,2	0,25	0,4	0,5	0,6	0,8	1	1,2	1,5
1	0,001	0,001	0,001	0,001	0,001	0,001	0,001	0,001	0,001	0,002	0,002	0,003	0,003	0,004	0,005
2	0,001	0,001	0,001	0,001	0,001	0,001	0,001	0,002	0,003	0,003	0,004	0,005	0,007	0,008	0,010
3	0,001	0,001	0,001	0,001	0,001	0,002	0,002	0,003	0,004	0,005	0,006	0,008	0,010	0,012	0,015
4	0,001	0,001	0,001	0,001	0,002	0,002	0,003	0,003	0,005	0,007	0,008	0,011	0,013	0,016	0,020
5	0,001	0,001	0,001	0,002	0,002	0,003	0,003	0,004	0,007	0,008	0,010	0,013	0,017	0,020	0,025
6	0,001	0,001	0,002	0,002	0,002	0,003	0,004	0,005	0,008	0,010	0,012	0,016	0,020	0,024	0,030
7	0,001	0,001	0,002	0,002	0,003	0,004	0,005	0,006	0,009	0,012	0,014	0,019	0,023	0,028	0,035
8	0,001	0,002	0,002	0,003	0,003	0,004	0,005	0,007	0,011	0,013	0,016	0,021	0,027	0,032	0,040
9	0,002	0,002	0,002	0,003	0,004	0,005	0,006	0,008	0,012	0,015	0,018	0,024	0,030	0,036	0,045
10	0,002	0,002	0,003	0,003	0,004	0,005	0,007	0,008	0,013	0,017	0,020	0,027	0,033	0,040	0,050
12	0,002	0,002	0,003	0,004	0,005	0,006	0,008	0,010	0,016	0,020	0,024	0,032	0,040	0,048	0,060
16	0,003	0,003	0,004	0,005	0,006	0,008	0,011	0,013	0,021	0,027	0,032	0,043	0,053	0,064	0,080
20	0,003	0,004	0,005	0,007	0,008	0,010	0,013	0,017	0,027	0,033	0,040	0,053	0,067	0,080	0,10

VRR	Feed f (mm) for dia. (mm)															
	2	2,5	4	5	6	8	10	12	15	20	25	40	50	60	80	100
1	0,007	0,008	0,013	0,017	0,018	0,021	0,024	0,026	0,029	0,033	0,037	0,047	0,053	0,058	0,067	0,075
2	0,013	0,017	0,027	0,033	0,037	0,042	0,047	0,052	0,058	0,067	0,075	0,094	0,11	0,12	0,13	0,15
3	0,020	0,025	0,040	0,050	0,055	0,063	0,071	0,077	0,087	0,10	0,11	0,14	0,16	0,17	0,20	0,22
4	0,027	0,033	0,053	0,067	0,073	0,084	0,094	0,10	0,12	0,13	0,15	0,19	0,21	0,23	0,27	0,30
5	0,033	0,042	0,067	0,083	0,091	0,11	0,12	0,13	0,14	0,17	0,19	0,24	0,26	0,29	0,33	0,37
6	0,040	0,050	0,080	0,10	0,11	0,13	0,14	0,15	0,17	0,20	0,22	0,28	0,32	0,35	0,40	0,45
7	0,047	0,058	0,093	0,12	0,13	0,15	0,16	0,18	0,20	0,23	0,26	0,33	0,37	0,40	0,47	0,52
8	0,053	0,067	0,11	0,13	0,15	0,17	0,19	0,21	0,23	0,27	0,30	0,38	0,42	0,46	0,53	0,60
9	0,060	0,075	0,12	0,15	0,16	0,19	0,21	0,23	0,26	0,30	0,34	0,42	0,47	0,52	0,60	0,67
10	0,067	0,083	0,13	0,17	0,18	0,21	0,24	0,26	0,29	0,33	0,37	0,47	0,53	0,58	0,67	0,75
12	0,080	0,10	0,16	0,20	0,22	0,25	0,28	0,31	0,35	0,40	0,45	0,57	0,63	0,69	0,80	0,89
16	0,11	0,13	0,21	0,27	0,29	0,34	0,38	0,41	0,46	0,53	0,60	0,75	0,84	0,92	1,07	1,19
20	0,13	0,17	0,27	0,33	0,37	0,42	0,47	0,52	0,58	0,67	0,75	0,94	1,05	1,15	1,33	1,49

VRR: feed rating charts for reamers

VRR	Feed f (mm) for dia. (mm)															
	1	1,2	1,5	2	2,5	4	5	6	8	10	12	15	20	25	40	50
6	0,04	0,04	0,04	0,05	0,06	0,08	0,09	0,10	0,12	0,14	0,15	0,17	0,21	0,23	0,31	0,35
8	0,05	0,05	0,06	0,07	0,08	0,11	0,12	0,14	0,16	0,18	0,20	0,23	0,27	0,31	0,41	0,47
10	0,06	0,07	0,07	0,09	0,10	0,13	0,15	0,17	0,20	0,23	0,25	0,29	0,34	0,39	0,51	0,59
12	0,07	0,08	0,09	0,11	0,12	0,16	0,18	0,20	0,24	0,27	0,30	0,35	0,41	0,47	0,62	0,70

Cutting tool materials

HSS cutting tool materials

4 groups of high-speed steel are used for Walter Titex tools:

HSS	High-speed steel for general applications (twist drills, core drilling, countersinks, reamers in some cases, centre drills, multi-diameter step drills)
HSS-E	High-speed steel with 5 % Co for increased loading, particularly extreme thermal loading (high-performance twist drill, reamers in some cases)
HSS-E Co8	High-speed steel with 8 % Co for maximum thermal loading capability, in accordance with American standard designation M 42 (Special tools)
HSS-PM	High-speed steel manufactured using powder metallurgy with extremely high alloy content Advantages: high degree of purity and uniformity of joint, outstanding wear resistance and thermal loading capability (Special tools)

	Material no.	Short name	Old standard designation	AISI ASTM	AFNOR	B.S.	UNI	Alloy table					
								C	Cr	W	Mo	V	Co
HSS	1.3343	S 6-5-2	DMo5	M2	–	BM2	HS 6-5-2	0,82	4,0	6,5	5,0	2,0	–
HSS-E	1.3243	S 6-5-2-5	EMo5 Co5	M35	6.5.2.5	–	HS 6-5-2-5	0,82	4,5	6,0	5,0	2,0	5,0
HSS-E Co8	1.3247	S 2-10-1-8	–	M42	–	BM42	HS 2-9-1-8	1,08	4,0	1,5	9,5	1,2	8,25
HSS-PM	Trade designation ASP												

Carbide cutting tool materials

Carbides mainly consist of tungsten carbide (WC) as the hard material and cobalt (Co) as the binding material.

In the majority of cases, the cobalt content is between 6 and 12 %. The following rule generally applies:

The higher the cobalt content, the tougher the material, but the less resistance to wear and vice-versa.

Another determining factor in carbides is the grain size. The hardness increases as the grain size becomes finer.

		Co in %	Grain size	Hardness HV
K10	– extremely wear-resistant substrate – use in brazed drilling and boring tools	6	normal	1650
K20F	– extremely wear-resistant substrate with fine grain size – use in short-chipping materials such as cast iron workpieces	6–7	fine	1650–1800
K30F	– extremely fine substrate, extremely tough and wear-resistant – universal application for a variety of materials	10	finest	1550

Surface treatments and hard material coating for increasing performance

Surface treatments

Steam treatment of tools made from HSS

Implementation	Dry steam atmosphere, 520 to 580 °C
Effect	Adherent oxide layer consisting of Fe ₃ O ₄ approx. 0.003 to 0.010 mm deep
Property	<ul style="list-style-type: none"> – low tendency towards cold welding – increased surface hardness and therefore improved wear resistance – increased corrosion resistance – improved sliding properties due to better lubricant adhesion as a result of FeO crystals – Reduction in grinding stress

Nitriding of tools made from HSS

Implementation	Treatment in media giving off nitrogen, 520 °C to 570 °C
Effect	Enrichment of surface with nitrogen and partially with carbon
Property	<ul style="list-style-type: none"> – low tendency towards cold welding and built up edges – increased hardness and therefore more wear resistance

Hard material coatings















Surface coating has developed into a proven technology for improving the performance of metal cutting tools. Unlike surface treatment, the surface of the tool is not chemically altered, but a thin coating is applied.

With Walter Titex tools made from high-speed steel and carbide, PVD processes are used for coating which operate at process temperatures of less than 600 °C and therefore do not change the basic tool material. Carbide coatings are harder and more wear-resistant than the cutting tool material itself.

Also:











- they separate the cutting tool material and the material that is going to be cut from each other
- they act as a thermal insulating layer

This improves the service life of the coated tools, and increases the cutting speed and the feed rate at the same time.

Surface treatment/coating	Process/coating	Property	Example tool
uncoated	No treatment	–	
Steam treated	Steam treatment	Universal treatment for HSS	
Fibre-steamed	Steam treatment	Universal treatment of lands for HSS	
TiN	TiN coating	Universal coating	
TIP	TiN Point coating	Special coating for optimum chip evacuation	
TFL	Tinal coating	High-performance coating with wide application area	
TFT	Tinal TOP coating	High performance coating with particularly low friction	
TFP	Tinal Point coating	High-performance coating for optimum chip evacuation	
TML	Tinal micro-coating	Special coating for small drills with extremely low friction	
XPL	AlCrN coating	High-performance coating for maximum wear resistance	
DPL	Double coating	High-performance coating for maximum wear resistance	
DPP	Double point coating	High-performance coating for maximum wear resistance	
AML	AlTiN micro-coating	Special coating for small drills with extremely low friction	
AMP	AlTiN micro-Point coating	Special coating for small drills with extremely low friction	

Tool types

Alpha® family









Tool type	Remarks on field of applications	Workpiece material group						
		P	M	K	N	S	H	O
		Steel	Stainless steel	Cast iron	NF metals	Difficult-to-cut materials	Hard materials	Other
Alpha® 2 	– Solid carbide drill in acc. with DIN 6537 short/long without internal cooling – For universal use	••	••	••	••	••	••	••
Alpha® 22 	– Solid carbide drill 8 x D _c without internal cooling – UFL® profile – For universal use	••		••	••	••		
Alpha® 2 Plus Micro 	– Solid carbide micro-drill Ø 0.5–3 mm, 5 and 8 x D _c without internal cooling – For universal use	••		••	••	••	•	••
Alpha® Rc 	– Solid carbide drill in acc. with DIN 6537 short without internal cooling – Specially for hardened materials				••	••	••	
Alpha® 4 	– Solid carbide drill in acc. with DIN 6537 short with internal cooling – For universal use	••	••	••	••	••	••	
Alpha® 44 	– Solid carbide drill 8 x D _c with internal cooling – UFL® profile – For universal use	••	••	••	••	••		••
Alpha® 4 Plus Micro 	– Solid carbide micro-drill Ø 0.75–3 mm, 8 and 12 x D _c with internal cooling – For universal use	••	•	••	••	••	•	••
Alpha® 4 XD 	– Solid carbide deep-hole drill 16 to 30 x D _c with internal cooling – For universal use	••	••	••	••	••	•	••
XD Pilot 	– Pilot drill with 150° point angle and internal cooling – Specially designed for the Alpha® 4 XD and the X-treme DH deep-hole drills	••	••	••	••	••	••	••
Alpha® Ni 	– Solid carbide drill in acc. with DIN 6537 long with internal cooling – Specially for Ni alloys	•	•			••	•	
Alpha® Jet 	– Straight flute solid carbide drill in acc. with DIN 6537 long, 8 and 12 x D _c with internal cooling – For short-chipping cast iron and aluminium materials			••	••	•		••

Drilling depth

	3 x D _c	5 x D _c	8 x D _c	12 x D _c	16 x D _c	20 x D _c	25 x D _c	30 x D _c
	A3265TFL A3865TFL	A3365TFT A3965TFT						
			A1276TFL					
		A3378TML	A6478TML					
	A3269TFL							
	A3285TFL A3885TFL							
			A3486TIP					
			A6488TML	A6588TML				
					A6685TFP	A6785TFP	A6885TFP	A6985TFP
	A6181TFT							
		A3384						
		A3387	A3487	A3687				

Tool types

X-treme family

Tool type	Remarks on field of applications	Workpiece material group						
		P	M	K	N	S	H	O
		Steel	Stainless steel	Cast iron	NF metals	Difficult-to-cut materials	Hard materials	Other
X-treme Plus 	<ul style="list-style-type: none"> – Solid high-performance carbide drill in acc. with DIN 6537 long with internal cooling – Can be used universally with maximum cutting data 	●●	●●	●●	●●	●●	●●	●
X-treme DH 	<ul style="list-style-type: none"> – Solid carbide deep-hole drill, 20 x D_C and 30 x D_C – D stands for "Deep" – H stands for "heavy duty materials" (steel that is difficult to cut), e.g. crankshafts 	●●	●●	●●	●	●●	●	
X-treme Pilot 180 	<ul style="list-style-type: none"> – Pilot drill, specially designed for Alpha® 4 XD and X-treme DH with 180° point angle – Specially for angled and convex surfaces 	●●	●●	●●	●●	●●	●●	●●
X-treme Pilot 180 C 	<ul style="list-style-type: none"> – Pilot drill, specially designed for Alpha® 4 XD and X-treme DH with 180° point angle – Specially for angled and convex surfaces – The tapered design means that there is no witness between the pilot hole and the deep-hole drill (important with crankshafts) 	●●	●●	●●	●●	●●	●●	●●
X-treme M & DM 	<ul style="list-style-type: none"> – Solid carbide micro-deep-hole drill, 5 to 25 x D_C – D stands for "Deep" – M stands for "Micro" – For universal use 	●●	●●	●●	●●	●●	●	●●
X-treme Pilot 150 	<ul style="list-style-type: none"> – Pilot drill, specially designed for X-treme DM – 150 = point angle 150° 	●●	●●	●●	●●	●●	●●	●●
X-treme CI 	<ul style="list-style-type: none"> – Solid carbide high-performance drill in acc. with DIN 6537 long with internal cooling – Specially for cast iron materials – CI stands for "cast iron" 			●●		●●		
X-treme D 	<ul style="list-style-type: none"> – Solid carbide deep-hole drill, 8 x D_C and 12 x D_C – D stands for "Deep" – Can be used universally with high cutting data 	●●	●●	●●	●●	●●	●●	●
X-treme 	<ul style="list-style-type: none"> – Solid carbide drill in acc. with DIN 6537 short/long with and without internal cooling – Can be used universally with high cutting data 	●●	●●	●●	●●	●●	●●	

Drilling depth

	3 x D _C	5 x D _C	8 x D _C	12 x D _C	16 x D _C	20 x D _C	25 x D _C	30 x D _C
	A3289DPL	A3389DPL						
						A6794TFP		A6994TFP
	A7191TFT							
	K5191TFT							
		A3389AML	A6489AMP	A6589AMP		A6789AMP	A6889AMP	
	A6181AML							
		A3382XPL						
			A6489DPP	A6589DPP				
	A3299XPL A3899XPL A3279XPL A3879XPL	A3399XPL A3999XPL A3379XPL A3979XPL						

XD Technology

Drilling strategy XD35-70 – with chamfer

Pilot drilling no. 1: **With internal cooling** 2 x D_C
 10–20 bar A6181TFT
on A7191TFT

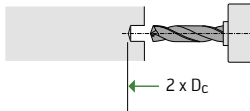

Pilot drilling no. 2: **With internal cooling** 12 x D_C
 10–20 bar A6589DPP
on

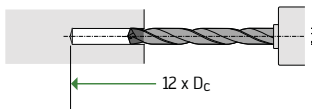

$n = 0 \text{ rpm} - v_f = 1000 \text{ mm/min} \rightarrow 1.5 \times D_C \text{ then } 100 \% \text{ TEC}$

Chamfering: **With external cooling** E6819TIN or
on E6818

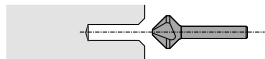

Chamfer 90° or 60°;
 chamfer $\varnothing > 10\text{-}15 \% \text{ as nominal diameter}$

Feeding in: **With internal cooling** XD Technology
off XD35-70

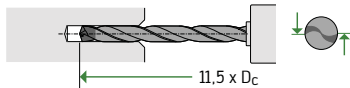

$n = 0 \text{ rpm} - v_f = 1000 \text{ mm/min}$
 $\rightarrow 11.5 \times D_C \text{ horizontal cutting edges}$

Deep-hole drilling: **With internal cooling** XD Technology
 min. 20 bar XD35-70
recommended 40 bar
on



without pecking
 $v_C = 100 \% ; v_f = 100 \%$

Retract: **With internal cooling** XD Technology
off XD35-70

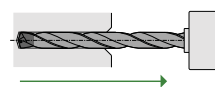

$n \text{ max} = 100 \text{ rpm} ; v_f = 1000 \text{ mm/min}$

Drilling strategy XD35-70 – without chamfer

Pilot drilling no. 1: **With internal cooling** 2 x D_C
 10–20 bar A6181TFT
on A7191TFT

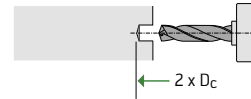

Pilot drilling no. 2: **With internal cooling** 12 x D_C
 10–20 bar A6589DPP
on

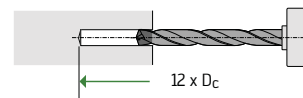

$n = 0 \text{ rpm} - v_f = 1000 \text{ mm/min}$
 $\rightarrow 1.5 \times D_C \text{ then } 100 \% \text{ TEC}$

Feeding in: **With internal cooling** XD Technology
off XD35-70

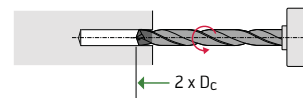

With anti-clockwise rotation:
 $n \text{ max} = 100 \text{ rpm} \rightarrow 2 \times D_C \quad v_f = 1000 \text{ mm/min}$

Feeding in: **With internal cooling** XD Technology
off XD35-70

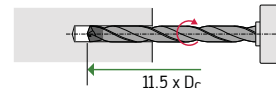

Continue operation with clockwise rotation:
 $n \text{ max} = 100 \text{ rpm}$
 $\rightarrow 11.5 \times D_C \quad v_f = 1000 \text{ mm/min}$

Deep-hole drilling: **With internal cooling** XD Technology
 min. 20 bar XD35-70
recommended 40 bar
on

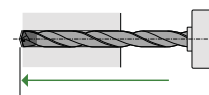

without pecking
 $v_C = 100 \% ; v_f = 100 \%$

Retract: **With internal cooling** XD Technology
off XD35-70

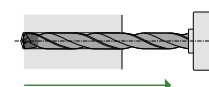

$n \text{ max} = 100 \text{ rpm} ; v_f = 1000 \text{ mm/min}$

Recommended cutting data can be found in TEC-CCS.

XD Technology

Drilling strategy for Alpha® 4 XD16-XD30

Pilot drilling: **With internal cooling** 2 x D_C
 10–20 bar **on** A6181TFT
 A7191TFT
 K5191TFT

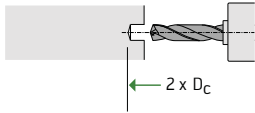

Feeding in: **With internal cooling**
off

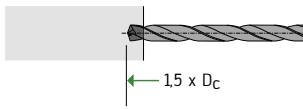

n max = 500 rpm

Deep-hole drilling – Start:

With internal cooling
 10–30 bar **on**

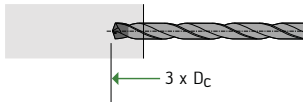

v_C = 25 % – 50 %, v_F = 25 % – 50 %
 → then 100 % TEC

Deep-hole drilling – Process:

With internal cooling
 10–30 bar **on**

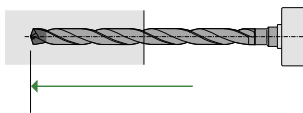

without pecking
 v_C = 100 %, v_F = 100 %

Retract:

With internal cooling
off

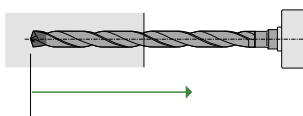

n max = 500 rpm

Drilling strategy for X-treme DM20-DM25

Pilot drilling: **With internal cooling** 2 x D_C
 10–30 bar **on** A6181AML

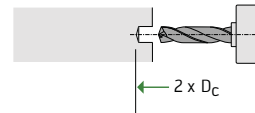

Feeding in: **With internal cooling**
off

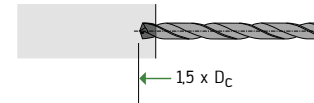

n max = 500 rpm

Deep-hole drilling – Process:

With internal cooling
 10–30 bar **on**

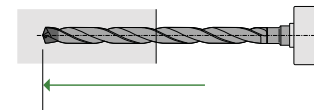

without pecking
 v_C = 100 %, v_F = 100 %

Retract:

With internal cooling
off

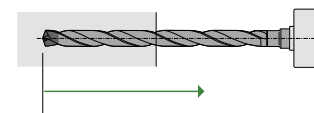

n max = 500 rpm

Recommended cutting data can be found in TEC-CCS.

Dimensions

Twist drill with Morse taper

Walter Designation	A 41 ...			A 42 ...			A 43 ...			A 44 ...			A 46 ...		A 47 ...			
	Walter standard		MK**	DIN 345		MK**	DIN 346		MK**	DIN 341		MK**	DIN 1870 row 1		DIN 1870 row 2		MK**	
	I ₁	L _c		I ₁	L _c		I ₁	L _c		I ₁	L _c		I ₁	L _c	I ₁	L _c		I ₁
2,65 – 3,00				114	33	1												
3,00 – 3,35				117	36	1												
3,35 – 3,75				120	39	1												
3,75 – 4,25				124	43	1												
4,25 – 4,75				128	47	1												
4,75 – 5,30				133	52	1				155	74	1						
5,30 – 6,00				138	57	1				161	80	1						
6,00 – 6,70				144	63	1				167	86	1						
6,70 – 7,50				150	69	1				174	93	1						
7,50 – 8,50				156	75	1				181	100	1	265	165	330	210	1	
8,50 – 9,50				162	81	1				188	107	1	275	175	345	220	1	
9,50 – 10,60	138	57	1	168	87	1	185*	87*	2	197	116	1	285	185	360	235	1	
10,60 – 11,80	142	61	1	175	94	1	192*	94*	2	206	125	1	300	195	375	250	1	
11,80 – 13,20	147	66	1	182	101	1	199	101	2	215	134	1	310	205	395	260	1	
13,20 – 14,00	168	70	2	189	108	1	206	108	2	223	142	1	325	220	410	275	1	
14,00 – 15,00	172	74	2	212	114	2				245	147	2	340	220	425	275	2	
15,00 – 16,00	176	78	2	218	120	2				251	153	2	355	230	445	295	2	
16,00 – 17,00	179	81	2	223	125	2	246*	125*	3	257	159	2	355	230	445	295	2	
17,00 – 18,00	183	85	2	228	130	2	251*	130*	3	263	165	2	370	245	465	310	2	
18,00 – 19,00	186	88	2	233	135	2	256	135	3	269	171	2	370	245	465	310	2	
19,00 – 20,00	212	91	3	238	140	2	261	140	3	275	177	2	385	260	490	325	2	
20,00 – 21,20	216	95	3	243	145	2	266	145	3	282	184	2	385	260	490	325	2	
21,20 – 22,40	219	98	3	248	150	2	271	150	3	289	191	2	405	270	515	345	2	
22,40 – 23,02	222	101	3	253	155	2	276	155	3	296	198	2	405	270	515	345	2	
23,02 – 23,60	222	101	3	276	155	3				319	198	3	425	270	535	345	3	
23,60 – 25,00	225	104	3	281	160	3				327	206	3	440	290	555	365	3	
25,00 – 26,50	256	107	4	286	165	3	314*	165*	4	335	214	3	440	290	555	365	3	
26,50 – 28,00	259	110	4	291	170	3	319	170	4	343	222	3	460	305	580	385	3	
28,00 – 30,00	263	114	4	296	175	3	324	175	4	351	230	3	460	305	580	385	3	
30,00 – 31,50				301	180	3	329	180	4	360	239	3	480	320	610	410	3	
31,50 – 31,75				306	185	3	334	185	4	369	248	3	480	320	610	410	3	
31,75 – 33,50				334	185	4				397	248	4	505	320	635	410	4	
33,50 – 35,50				339	190	4				406	257	4	530	340	665	430	4	
35,50 – 37,50				344	195	4				416	267	4	530	340	665	430	4	
37,50 – 40,00				349	200	4				426	277	4	555	360	695	460	4	
40,00 – 42,50				354	205	4	392	205	5	436	287	4	555	360	695	460	4	
42,50 – 45,00				359	210	4	397	210	5	447	298	4	585	385	735	490	4	
45,00 – 47,50				364	215	4	402	215	5	459	310	4	585	385	735	490	4	
47,50 – 50,00				369	220	4	407	220	5	470	321	4	605	405	765	510	4	
50,00 – 50,80				374	225	4	412	225	5	485*	336*	4						
50,80 – 53,00				412	225	5				523*	336*	5						
53,00 – 56,00				417	230	5				534*	347*	5						
56,00 – 60,00				422	235	5				550*	363*	5						
60,00 – 63,00				427	240	5				566*	379*	5						
63,00 – 67,00				432	245	5	499	245	6	581*	394*	5						
67,00 – 71,00				437	250	5	504	250	6	599*	412*	5						
71,00 – 75,00				442	255	5	509	255	6	617*	430*	5						
75,00 – 76,20				447	260	5	514	260	6	637*	450*	5						
76,20 – 80,00				514	260	6				704*	450*	6						
80,00 – 85,00				519	265	6				727*	473*	6						
85,00 – 90,00				524	270	6				750*	496*	6						
90,00 – 95,00				529	275	6												
95,00 – 100,00				534	280	6												

* Walter standard

** MK = Morse taper

Dimensions Twist drill

Solid carbide twist drill with standard shank

Walter Designation		A 32... A 38... DIN 6537 K			A 33... A 39... DIN 6537 L			
D _c mm (m7) above – to	d ₁ h6	Short twist drill (K)			Long twist drill (L)			
		l ₁	l ₂ max	L _c min	l ₁	l ₂ max	L _c min	l ₄
2,90 – 3,75	6	62	20	14	66	28	23	36
3,75 – 4,75	6	66	24	17	74	36	29	36
4,75 – 6,00	6	66	28	20	82	44	35	36
6,00 – 7,00	8	79	34	24	91	53	43	36
7,00 – 8,00	8	79	41	29	91	53	43	36
8,00 – 10,00	10	89	47	35	103	61	49	40
10,00 – 12,00	12	102	55	40	118	71	56	45
12,00 – 14,00	14	107	60	43	124	77	60	45
14,00 – 16,00	16	115	65	45	133	83	63	48
16,00 – 18,00	18	123	73	51	143	93	71	48
18,00 – 20,00	20	131	79	55	153	101	77	50

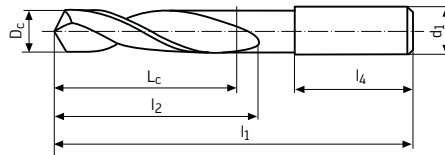

HSS-E twist drill with standard shank

Walter Designation	A 62. Walter standard			
D _c mm (h8) above – to	l ₁ mm	l ₂ mm	d ₁ (h6) mm	l ₄ mm
4,9 – 6,0	82	44	6	36
6,0 – 8,0	91	53	8	36
8,0 – 10,0	103	61	10	40
10,0 – 12,0	122	75	12	45
12,0 – 14,0	134	87	14	45
14,0 – 16,0	150	100	16	48
16,0 – 18,0	162	112	18	48
18,0 – 20,0	176	124	20	50
20,0 – 24,0	207	145	25	56

Dimensions

Reamers with cylindrical shank

Walter Designation	F 11 . .			F 13 . .			F 12 . .		
D_c mm	DIN 206			DIN 212			DIN 859		
above – to	l_1	L_c	$d_1 e_9$	l_1	L_c	$d_1 h_9$	l_1	L_c	$d_1 e_9$
0,75 – 1,06	34	13	$D_c = d_1$	34	5,5				$D_c = d_1$
1,06 – 1,18	36	15	$D_c = d_1$	36	6,5				$D_c = d_1$
1,18 – 1,32	38	17	$D_c = d_1$	38	7,5				$D_c = d_1$
1,32 – 1,5	41	20	$D_c = d_1$	40	8				$D_c = d_1$
1,5 – 1,7	44	21	$D_c = d_1$	43	9				$D_c = d_1$
1,7 – 1,9	47	23	$D_c = d_1$	46	10				$D_c = d_1$
1,9 – 2,12	50	25	$D_c = d_1$	49	11				$D_c = d_1$
2,12 – 2,36	54	27	$D_c = d_1$	53	12				$D_c = d_1$
2,36 – 2,65	58	29	$D_c = d_1$	57	14				$D_c = d_1$
2,65 – 3,0	62	31	$D_c = d_1$	61	15				$D_c = d_1$
3,0 – 3,35	66	33	$D_c = d_1$	65	16				$D_c = d_1$
3,35 – 3,75	71	35	$D_c = d_1$	70	18				$D_c = d_1$
3,75 – 4,25	76	38	$D_c = d_1$	75	19	4	76	38	$D_c = d_1$
4,25 – 4,75	81	41	$D_c = d_1$	80	21	4,5	81	41	$D_c = d_1$
4,75 – 5,3	87	44	$D_c = d_1$	86	23	5	87	44	$D_c = d_1$
5,3 – 6,0	93	47	$D_c = d_1$	93	26	5,6	93	47	$D_c = d_1$
6,0 – 6,7	100	50	$D_c = d_1$	101	28	6,3	100	50	$D_c = d_1$
6,7 – 7,5	107	54	$D_c = d_1$	109	31	7,1	107	54	$D_c = d_1$
7,5 – 8,5	115	58	$D_c = d_1$	117	33	8	115	58	$D_c = d_1$
8,5 – 9,5	124	62	$D_c = d_1$	125	36	9	124	62	$D_c = d_1$
9,5 – 10,6	133	66	$D_c = d_1$	133	38	10	133	66	$D_c = d_1$
10,6 – 11,8	142	71	$D_c = d_1$	142	41	10	142	71	$D_c = d_1$
11,8 – 13,2	152	76	$D_c = d_1$	151	44	10	152	76	$D_c = d_1$
13,2 – 14,0	163	81	$D_c = d_1$	160	47	12,5	163	81	$D_c = d_1$
14,0 – 15,0	163	81	$D_c = d_1$	162	50	12,5	163	81	$D_c = d_1$
15,0 – 16,0	175	87	$D_c = d_1$	170	52	12,5	175	87	$D_c = d_1$
16,0 – 17,0	175	87	$D_c = d_1$	175	54	14	175	87	$D_c = d_1$
17,0 – 18,0	188	93	$D_c = d_1$	182	56	14	188	93	$D_c = d_1$
18,0 – 19,0	188	93	$D_c = d_1$	189	58	16	188	93	$D_c = d_1$
19,0 – 21,2	201	100	$D_c = d_1$	195	60	16	201	100	$D_c = d_1$
21,2 – 23,6	215	107	$D_c = d_1$				215	107	$D_c = d_1$
23,6 – 26,5	231	115	$D_c = d_1$				231	115	$D_c = d_1$
26,5 – 30,0	247	124	$D_c = d_1$				247	124	$D_c = d_1$
30,0 – 33,5	265	133	$D_c = d_1$				265	133	$D_c = d_1$
33,5 – 37,5	284	142	$D_c = d_1$				284	142	$D_c = d_1$
37,5 – 42,5	305	152	$D_c = d_1$				305	152	$D_c = d_1$
42,5 – 47,5	326	163	$D_c = d_1$				326	163	$D_c = d_1$
47,5 – 53,0	347	174	$D_c = d_1$				347	174	$D_c = d_1$
53,0 – 60,0	367	184	$D_c = d_1$				367	181	$D_c = d_1$
60,0 – 67,0	387	194	$D_c = d_1$				387	194	$D_c = d_1$
67,0 – 75,0	406	203	$D_c = d_1$				406	203	$D_c = d_1$

Dimensions Reamers with Morse taper

Walter Designation	F 41 .. F 42 ..			F 43 ..			F 45 ..		
	DIN 208			DIN 209			DIN 311		
D _c mm above – to	l ₁	L _c	Morse taper	l ₁	L _c	Morse taper	l ₁	L _c	Morse taper
4,75 – 5,3	133	23	1						
5,3 – 6,0	138	26	1						
6,0 – 6,7	144	28	1				151	75	1
6,7 – 7,5	150	31	1				156	80	1
7,5 – 8,5	156	33	1				161	85	1
8,5 – 9,5	162	36	1				166	90	1
9,5 – 10,6	168	38	1				171	95	1
10,6 – 11,8	175	41	1				176	100	1
11,8 – 13,2	182	44	1				199	105	2
13,2 – 14,0	189	47	1				209	115	2
14,0 – 15,0	204	50	2				219	125	2
15,0 – 16,0	210	52	2				229	135	2
16,0 – 17,0	214	54	2				251	135	3
17,0 – 18,0	219	56	2				261	145	3
18,0 – 19,0	223	58	2				261	145	3
19,0 – 20,0	228	60	2	228	36	2	271	155	3
20,0 – 21,2	232	62	2	232	36	2	271	155	3
21,2 – 22,4	237	64	2	237	36	2	281	165	3
22,4 – 23,6	241	66	2	241	36	2	281	165	3
23,6 – 25,0	268	68	3	268	36	3	296	180	3
25,0 – 26,5	273	70	3	273	36	3	296	180	3
26,5 – 28,0	277	71	3	277	38	3	311	195	3
28,0 – 30,0	281	73	3	281	38	3	311	195	3
30,0 – 31,5	285	75	3	285	38	3	326	210	3
31,5 – 33,5	317	77	4	317	38	4	354	210	4
33,5 – 35,5	321	78	4	321	38	4	364	220	4
35,5 – 37,5	325	79	4	325	42	4	364	220	4
37,5 – 40,0	329	81	4	329	42	4	374	230	4
40,0 – 42,5	333	82	4	333	42	4	374	230	4
42,5 – 45,0	336	83	4	336	42	4	384	240	4
45,0 – 47,5	340	84	4	340	45	4	384	240	4
47,5 – 50,0	344	86	4	344	45	4	394	250	4



Drilling and boring tools with indexable inserts

	Information	C 2
Drilling and boring indexable inserts	Product range overview	C 5
	Designation key	C 6
	Walter Select – drilling	C 10
	Walter indexable inserts for drilling	C 12
	Walter Select – counterboring	C 20
	Walter indexable inserts for counterboring	C 23
	Walter Select – precision boring	C 26
	Walter indexable inserts for precision boring	C 29
	Walter Select – reaming	C 33
	Walter indexable inserts for reaming	C 35
Walter drilling and boring tools with indexable inserts	Product range overview	C 36
	Modularity of the Walter Precision System	C 40
	System overview of ScrewFit	C 42
	Designation key	C 44
	Walter Select – drilling	C 46
	Walter drills	C 50
	Walter Select – Counterboring, precision boring and reaming	C 90
	Walter two flute boring tools	C 92
	Walter precision drills	C 100
	Walter reaming tools	C 122
	Product range overview of standard assembly parts for	
	Walter special boring tools	C 128
	ISO boring cartridges	C 130
Walter mini boring cartridges	C 138	
Walter precision boring cartridges	C 143	
Technical Information	Cutting data	C 146
	Cutting material application tables	C 168
	Geometry overview of indexing inserts	C 171
	Tool diameter tolerance ranges	C 174
	Drilling with X offset	C 176
	Drilling strategy for the Xtra-tec® Point Drill	C 178
	Recommended values for drilling	C 179
	Setting and assembly instructions	C 188
	Usage information	C 192
	Information on high-speed cutting	C 193
Technical information about reaming	C 194	

Tools for drilling and boring

The Walter and Walter Titex competence brands provide a full range of products for efficient drilling and boring operations. The standard range of drills starts with a diameter of 0.05 mm and ends at 100 mm. Various systems with inserts or exchangeable blades, and systems made from solid carbide or HSS are available.

Both analogue and digital solutions with balance compensation are available for precision boring operations. Maximum precision and easy handling increase process reliability and productivity.

For reaming, Walter provides solid carbide or HSS tools with multiple cutting edges and pad-guided reaming tools with exchangeable cutting edges in different versions.

1 XD Technology

- Drilling without pecking up to $30 \times D_c$ as a standard tool and up to $70 \times D_c$ as a special tool
- For versatile use in many different materials

2 Xtra-tec® point drill

- Solid drill with exchangeable blade for all bores up to $10 \times D_c$
- Patented clamping provides maximum process reliability

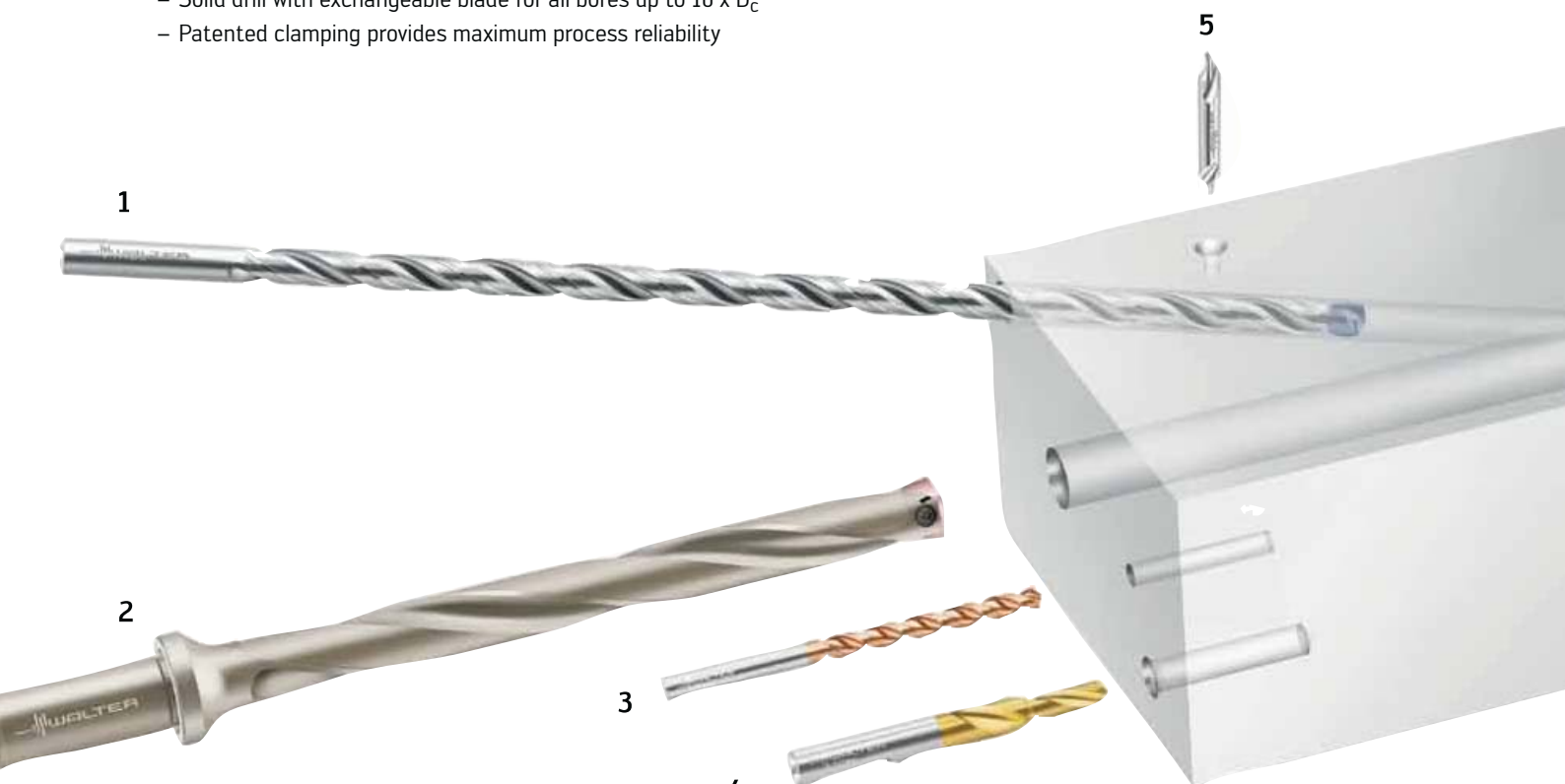

3 UFL® XPL high-performance drill made from HSS-E

- UFL® XPL tools provide a long tool life in universal use
- HSS-E provides good temperature resistance and XPL coating maximum wear resistance

4 Alpha® 2 solid carbide chamfering drill

- Drilling and countersinking can be performed in a single operation
- Other dimensions and stages can be supplied via the Walter Xpress Service within 2 weeks



5 Solid carbide and HSS centre drill

- The product range includes dimensions in acc. with DIN 333 and forms A, R and B

6 X-treme Plus

- The patented DPL coating ensures suitability for use in the HSC area for different materials
- Maximum cutting speeds increase productivity and improve component quality

7 Walter Precision

- Self-balancing precision boring tool for finish bore machining
- Accuracy of 2 µm with v_c to 2000 m/min

8 Xtra-tec® Insert Drill

- Universally usable indexable insert drill for high productivity with excellent hole quality

9 Walter Boring

- Boring tool with a wide adjustment range
- Using Walter NCT, fits almost any machine spindle

10 X-treme D8–D12

- High-performance drill up to 12 x D_c with DPP double point coating for maximum process reliability and maximum productivity
- No centring or pilot holes required

11 Walter reaming

- Pad-guided HSC reaming tool for maximum precision
- Extremely universal because of indexable insert

12 Walter Titex reaming

- The comprehensive reaming product range made from solid carbide and HSS includes cylindrical and tapered versions
- 1/100 increments available from stock

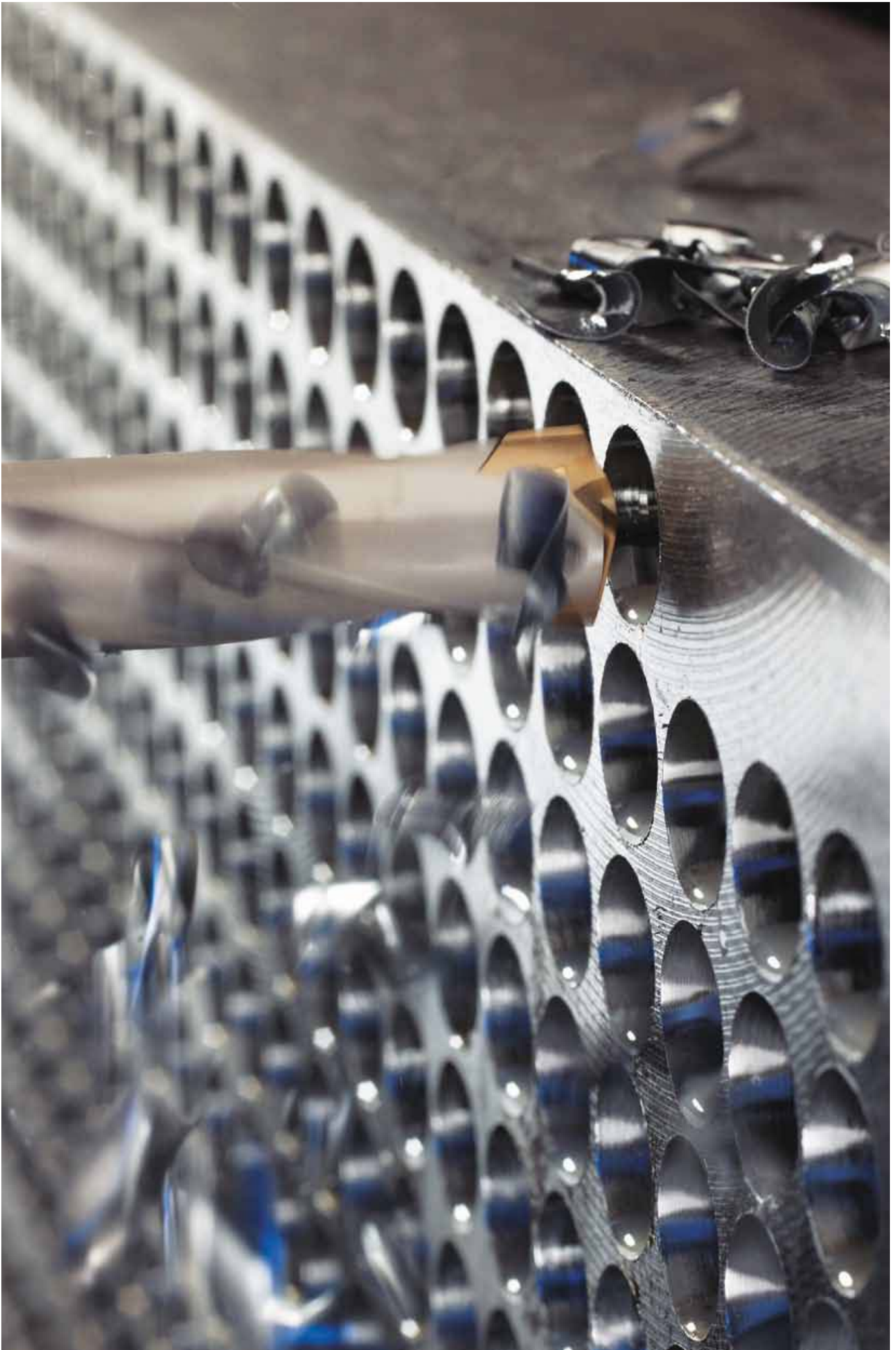

Product range overview of indexable inserts for drilling



Application	Insert shape	Description	Page	
Drilling		P 6001 . . P 6002 . . P 6003 . . P 6004 . .	For drilling	C 12
		L	For drilling	C 19
		P 284 . .	For drilling	C 18
		P 484 . .	For drilling	C 16
		T	For chamfering	C 15
		W	For drilling	C 19
Boring Precision boring		C	For boring For precision boring	C 23 C 29
		W	For boring For precision boring	C 25 C 31
Reaming		P 6500	For reaming	C 35

ISO 1832 designation key for indexable inserts for drilling

Examples of indexable inserts for drilling

L	C	M	X	06	T2	04	-	D57
1	2	3	4	5	6	7		8

1	
Insert shape	
A	M
B	O
C	P
D	R
E	S
H	T
K	V
L	W

2	
Clearance angle	
A	F
B	G
C	N
D	P
E	

3			
Tolerances			
Permissible deviation in mm for			
	d	m	s
	A ± 0,025	± 0,005	± 0,025
	C ± 0,025	± 0,013	± 0,025
	E ± 0,025	± 0,025	± 0,025
	F ± 0,013	± 0,005	± 0,025
	G ± 0,025	± 0,025	± 0,130
	H ± 0,013	± 0,013	± 0,025
	J ¹ ± 0,05-0,15 ²	± 0,005	± 0,025
	K ¹ ± 0,05-0,15 ²	± 0,013	± 0,025
	L ¹ ± 0,05-0,15 ²	± 0,025	± 0,025
	M ± 0,05-0,15 ²	± 0,08-0,20 ²	± 0,130
	N ± 0,05-0,15 ²	± 0,08-0,20 ²	± 0,025
	U ± 0,08-0,25 ²	± 0,13-0,38 ²	± 0,130

¹ Inserts with ground secondary cutting edges
² Depending on insert size (see ISO standard 1832)

7	
Corner radius	
	01 r = 0,1
	02 r = 0,2
	04 r = 0,4
	08 r = 0,8
	12 r = 1,2
	16 r = 1,6
	24 r = 2,4
	00 for diameters with imperial sizes converted to mm
	M0 for diameters in metric sizes

8		
Manufacturer's specifications		
The ISO code includes 9 symbols. The symbols 8 and / or 9 should be only used when required.		
The manufacturer can add other symbols which can be combined with the ISO code by means of a hyphen (e.g. for the chip breaker shape).		
Drilling: A 57 B 57 D 57 E 57 E 67	Precision boring: X 5 X 15 X 25 PM 2 PF PF 4 PF 5	
Counterboring: E 47 PF 2 PF 4 PF 5 PS 5 PM 2 PM 5		

Example of indexable inserts for boring and precision boring

W	C	G	T	04	02	04	-	X15
1	2	3	4	5	6	7		8

4		
Machining and fastening features		
A	J	T
B	M	U
C	N	W
F	Q	X
G	R	Drawing or precise description of insert is required
H		

5	
Cutting edge length	

6	
Insert thickness	
	01 s = 1,59
	T1 s = 1,98
	02 s = 2,38
	T2 s = 2,78
	03 s = 3,18
	T3 s = 3,97
	04 s = 4,76
	05 s = 5,56
	06 s = 6,35
	07 s = 7,94
	09 s = 9,52

Designation key for cutting material grades – boring

Example

W	K	P	25
Walter	1	2	3

1	
1. Primary application or coating type	
P	Steel
M	Stainless steel
K	Cast iron
N	NF metals
S	Difficult-to-cut materials
H	Hard materials
A	CVD aluminium coating
X	PVD coating

2	
2. Primary application	
P	Steel
M	Stainless steel
K	Cast iron
N	NF metals
S	Difficult-to-cut materials
H	Hard materials

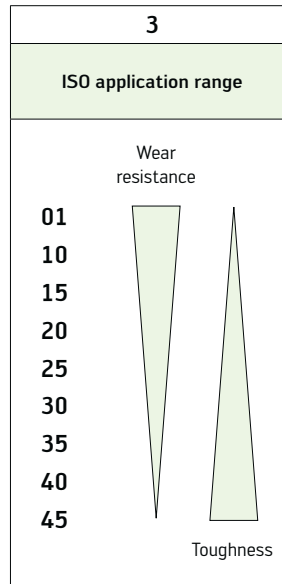

Geometry designation keys for indexable inserts for drilling

Example

B	5	7
1	2	3

1		
Chip breaker groove		
smaller		A = 0°
		B = 6°
		D = 10°
		E = 15°
		F = 16°
		G = 20°
larger		K = 25°

2		
Cutting edge		
heavily chamfered		2
		5
sharp		8

3	
Flank face formation	
	5
	6
	7
	8

Walter Select for drilling inserts

Step by step to the right indexable insert

STEP 1





Determine the **material** to be machined, see page H 8 onwards.

Note the machining group that corresponds to your material e.g.: P10.

Identification letters	Machining group	Groups of the materials to be machined	
P	P1–P15	Steel	All types of steel and cast steel, with the exception of steel with an austenitic structure
M	M1–M3	Stainless steel	Stainless austenitic steel and austenitic-ferritic steel and cast steel
K	K1–K7	Cast iron	Grey cast iron, cast iron with spheroidal graphite, malleable cast iron, cast iron with vermicular graphite
N	N1–N10	NF metals	Aluminium and other non-ferrous metals, non-ferrous materials
S	S1–S10	High temperature alloys and titanium alloys	Heat resisting special alloys based on iron, nickel and cobalt, titanium and titanium alloys
H	H1–H4	Hard materials	Hardened steel, hardened cast iron materials, chilled cast iron
O	O1–O6	Other	Plastics, fibre glass and carbon fibre reinforced plastics, graphite

STEP 2

Select the **machining conditions**:

Tool projection	Machine stability, clamping system and workpiece		
	very good	good	moderate
Short projection length			
Extended tool projection			

STEP 3

Select your **tool** in acc. with your application and individual requirements.
Then select your drill from the corresponding tool page.

Drilling depth	Page
1 x D _C	C 50
2 x D _C	C 52
3 x D _C	C 64
4 x D _C	C 74
5 x D _C	C 80
7 x D _C	C 86
10 x D _C	C 88

STEP 4

Determine your optimum **indexable insert grade and geometry** on the appropriate tool page.
In so doing, please take into consideration the machining conditions (step 2) and the material to be machined.

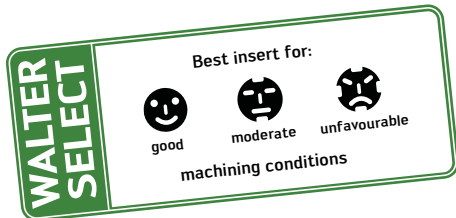

Inserts
P6001, P6002, P6003, P6004
for Xtra-tec® Point Drill

Inserts

Designation	Cutting edges	D _C mm	d ₁ mm	s mm	P6001		P6003		P6002		P6004	
					P HC WXP 45	P HC WMP 35	M HC WMP 35	K HC WXP 25	N HC WNN 25	S HC WMP 35		
P60...-D12.00R*	2	12.00	3	3.6	●	●	●	●	●	●	●	●
P60...-D12.10R	2	12.10	3	3.6	●	●	●	●	●	●	●	●
P60...-D12.20R	2	12.20	3	3.6	●	●	●	●	●	●	●	●
P60...-D12.30R	2	12.30	3	3.6	●	●	●	●	●	●	●	●
P60...-D12.40R	2	12.40	3	3.6	●	●	●	●	●	●	●	●
P60...-D12.50R	2	12.50	3	3.6	●	●	●	●	●	●	●	●
P60...-D12.60R	2	12.60	3	3.6	●	●	●	●	●	●	●	●
P60...-D12.70R	2	12.70	3	3.6	●	●	●	●	●	●	●	●
P60...-D12.80R	2	12.80	3	3.6	●	●	●	●	●	●	●	●
P60...-D12.90R	2	12.90	3	3.6	●	●	●	●	●	●	●	●
P60...-D13.00R	2	13.00	3	3.6	●	●	●	●	●	●	●	●
P60...-D13.11R	2	13.11	3	3.6	●	●	●	●	●	●	●	●

STEP 5

Select the **cutting data** see page C 146.

Cutting data for drilling with Xtra-tec® Point Drill D_C 12–38 mm

Material group	Structure of main material groups and identification letters	Anneal hardness HB	Tensile strength R _m N/mm ²	Machining group	Insert geometry			
					Starting values for feed F [mm/rev]			
					D _C (mm)			
P	Unalloyed steel	C ≤ 0.25%	annealed	125-428 P1	●	12.0-15.9	16.0-21.9	22.0-31.99
		C > 0.25 ... ≤ 0.55 %	annealed	190-638 P2	●	0.2	0.25	0.3
		C > 0.25 ... ≤ 0.55 %	tempered	210-708 P3	●	0.2	0.25	0.3
		C > 0.55 %	annealed	190-638 P4	●	0.2	0.25	0.3
		C > 0.55 %	tempered	300-1013 P5	●	0.15	0.2	0.22
	Low-alloyed steel	Free cutting steel (short-chipping)	annealed	220-745 P6	● ●	0.18	0.22	0.25
		annealed	175-591 P7	● ●	0.2	0.25	0.3	
		tempered	300-1013 P8	● ●	0.2	0.25	0.3	
		tempered	380-1282 P9	● ●	0.18	0.22	0.25	
		tempered	430-1477 P10	● ●	0.15	0.2	0.22	
High-alloyed steel and high-alloyed tool steel	annealed	200-675 P11	● ●	0.15	0.2	0.22		
	hardened and tempered	300-1013 P12	● ●	0.12	0.15	0.2		
	hardened and tempered	400-1361 P13	● ●	0.1	0.12	0.8		
Stainless steel	ferritic / martensitic, annealed	200-675 P14	● ●	0.15	0.2	0.22		
	martensitic, tempered	330-1114 P15	● ●	0.12	0.15	0.2		
	austenitic, quench hardened	200-675 M1	● ●					
M	Stainless steel	austenitic, precipitation hardened (PH)	300-1013 M2	● ●				
		austenitic / ferritic, duplex	230-778 M3	● ●				
		ferritic	200-675 K1	● ● ●	0.2	0.25	0.3	
K	Malleable cast iron	ferritic	260-867 K2	● ● ● ●	0.25	0.3		

Inserts

P6001, P6002, P6003, P6004

for Xtra-tec® Point Drill

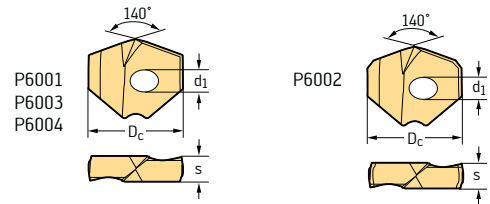

Inserts

Designation	Cutting edges	D _c mm	d ₁ mm	s mm	P6001	P6003	P6003	P6002	P6004	P6003
					P HC WXP 45	P HC WMP 35	M HC WMP 35	K HC WXK 25	N HC WNN 25	S HC WMP 35
 P6001	P60...-D12,00R*	2	12,00	3	3,6	☒	☒	☒	☒	☒
	P60...-D12,10R	2	12,10	3	3,6	☒				
	P60...-D12,20R	2	12,20	3	3,6	☒				
	P60...-D12,30R	2	12,30	3	3,6	☒				
	P60...-D12,40R	2	12,40	3	3,6	☒				
	P60...-D12,50R	2	12,50	3	3,6	☒	☒	☒	☒	☒
	P60...-D12,60R	2	12,60	3	3,6	☒				
	P60...-D12,70R	2	12,70	3	3,6	☒	☒	☒	☒	☒
 P6002	P60...-D12,80R	2	12,80	3	3,6	☒				
	P60...-D12,90R	2	12,90	3	3,6	☒				
	P60...-D13,00R	2	13,00	3	3,6	☒	☒	☒	☒	☒
	P60...-D13,11R	2	13,11	3	3,6	☒		☒		
	P60...-D13,20R	2	13,20	3	3,6	☒	☒	☒		☒
	P60...-D13,30R	2	13,30	3	3,6	☒				
	P60...-D13,40R	2	13,40	3	3,6	☒				
	P60...-D13,50R	2	13,50	3	3,6	☒	☒	☒	☒	☒
 P6003	P60...-D13,60R	2	13,60	3	3,6	☒				☒
	P60...-D13,70R	2	13,70	3	3,6	☒	☒	☒	☒	☒
	P60...-D13,80R	2	13,80	3	3,6	☒				
	P60...-D13,89R	2	13,89	3	3,6	☒		☒		
	P60...-D14,00R	2	14,00	3	4,0	☒	☒	☒	☒	☒
	P60...-D14,10R	2	14,10	3	4,0	☒				
	P60...-D14,20R	2	14,20	3	4,0	☒				
	P60...-D14,30R	2	14,30	3	4,0	☒	☒	☒	☒	☒
 P6004	P60...-D14,40R	2	14,40	3	4,0	☒				
	P60...-D14,50R	2	14,50	3	4,0	☒	☒	☒	☒	☒
	P60...-D14,60R	2	14,60	3	4,0	☒				
	P60...-D14,68R	2	14,68	3	4,0	☒	☒	☒	☒	☒
	P60...-D14,80R	2	14,80	3	4,0	☒				
	P60...-D14,90R	2	14,90	3	4,0	☒				
	P60...-D15,00R	2	15,00	3	4,0	☒	☒	☒	☒	☒
	P60...-D15,09R	2	15,09	3	4,0	☒		☒		
	P60...-D15,20R	2	15,20	3	4,0	☒				
	P60...-D15,30R	2	15,30	3	4,0	☒				
P60...-D15,40R	2	15,40	3	4,0	☒					
P60...-D15,47R	2	15,47	3	4,0	☒			☒		
P60...-D15,50R	2	15,50	3	4,0	☒	☒	☒	☒	☒	
P60...-D15,60R	2	15,60	3	4,0	☒					
P60...-D15,70R	2	15,70	3	4,0	☒	☒	☒		☒	
P60...-D15,80R	2	15,80	3	4,0	☒					
P60...-D15,87R	2	15,87	3	4,0	☒	☒	☒	☒	☒	

*** Ordering example:**

P60...-D13,00R is available as P6003 in the grade WMP 35 (ISO P, ISO M and ISO S) → P6003-D13,00R WMP 35
or as P6001 in the grade WXP 45 (ISO P) → P6001-D13,00R WXP 45

Inserts

P6001, P6002, P6003, P6004

for Xtra-tec® Point Drill

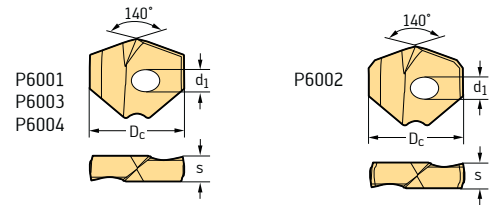

Inserts					P6001	P6003	P6003	P6002	P6004	P6003
					P	P	M	K	N	S
					HC	HC	HC	HC	HC	HC
					WXP 45	WMP 35	WMP 35	WXX 25	WNN 25	WMP 35
Designation	Cutting edges	Dc mm	d1 mm	s mm						
P6001	P60...-D16,00R	2	16,00	4	4,5	☺	☹	☺	☹	☹
	P60...-D16,26R	2	16,26	4	4,5	☺	☹	☺	☹	☹
	P60...-D16,50R	2	16,50	4	4,5	☺	☹	☺	☹	☹
	P60...-D16,66R	2	16,66	4	4,5	☺	☹	☺	☹	☹
	P60...-D17,00R	2	17,00	4	4,5	☺	☹	☺	☹	☹
	P60...-D17,07R	2	17,07	4	4,5	☺	☹	☺	☹	☹
	P60...-D17,45R	2	17,45	4	4,5	☺	☹	☺	☹	☹
P6002	P60...-D17,50R	2	17,50	4	4,5	☺	☹	☺	☹	☹
	P60...-D17,70R	2	17,70	4	4,5	☺	☹	☺	☹	☹
	P60...-D17,86R	2	17,86	4	4,5	☺	☹	☺	☹	☹
	P60...-D18,00R	2	18,00	4	5,0	☺	☹	☺	☹	☹
	P60...-D18,24R	2	18,24	4	5,0	☺	☹	☺	☹	☹
	P60...-D18,50R	2	18,50	4	5,0	☺	☹	☺	☹	☹
	P60...-D18,65R	2	18,65	4	5,0	☺	☹	☺	☹	☹
P6003	P60...-D19,00R	2	19,00	4	5,0	☺	☹	☺	☹	☹
	P60...-D19,05R	2	19,05	4	5,0	☺	☹	☺	☹	☹
	P60...-D19,25R	2	19,25	4	5,0	☺	☹	☺	☹	☹
	P60...-D19,43R	2	19,43	4	5,0	☺	☹	☺	☹	☹
	P60...-D19,50R	2	19,50	4	5,0	☺	☹	☺	☹	☹
	P60...-D19,70R	2	19,70	4	5,0	☺	☹	☺	☹	☹
	P60...-D19,84R	2	19,84	4	5,0	☺	☹	☺	☹	☹
P6004	P60...-D20,00R	2	20,00	5	5,5	☺	☹	☺	☹	☹
	P60...-D20,20R	2	20,20	5	5,5	☺	☹	☺	☹	☹
	P60...-D20,24R	2	20,24	5	5,5	☺	☹	☺	☹	☹
	P60...-D20,50R	2	20,50	5	5,5	☺	☹	☺	☹	☹
	P60...-D20,62R	2	20,62	5	5,5	☺	☹	☺	☹	☹
	P60...-D20,70R	2	20,70	5	5,5	☺	☹	☺	☹	☹
	P60...-D21,00R	2	21,00	5	5,5	☺	☹	☺	☹	☹
	P60...-D21,41R	2	21,41	5	5,5	☺	☹	☺	☹	☹
	P60...-D21,50R	2	21,50	5	5,5	☺	☹	☺	☹	☹
	P60...-D21,70R	2	21,70	5	5,5	☺	☹	☺	☹	☹
P60...-D21,83R	2	21,83	5	5,5	☺	☹	☺	☹	☹	
P60...-D22,00R	2	22,00	5	6,0	☺	☹	☺	☹	☹	
P60...-D22,22R	2	22,22	5	6,0	☺	☹	☺	☹	☹	
P60...-D22,50R	2	22,50	5	6,0	☺	☹	☺	☹	☹	
P60...-D22,62R	2	22,62	5	6,0	☺	☹	☺	☹	☹	
P60...-D22,70R	2	22,70	5	6,0	☺	☹	☺	☹	☹	
P60...-D23,00R	2	23,00	5	6,0	☺	☹	☺	☹	☹	
P60...-D23,39R	2	23,39	5	6,0	☺	☹	☺	☹	☹	
P60...-D23,50R	2	23,50	5	6,0	☺	☹	☺	☹	☹	
P60...-D23,70R	2	23,70	5	6,0	☺	☹	☺	☹	☹	
P60...-D23,80R	2	23,80	5	6,0	☺	☹	☺	☹	☹	

*** Ordering example:**

P60...-D20,00R is available as P6003 in the grade WMP 35 (ISO P, ISO M and ISO S) → P6003-D20,00R WMP 35
or as P6001 in the grade WXP 45 (ISO P) → P6001-D20,00R WXP 45

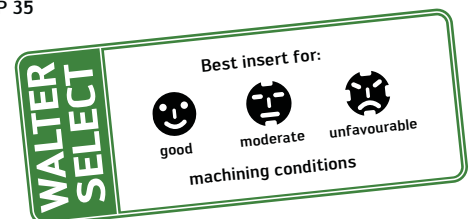

Inserts

P6001, P6002, P6003, P6004

for Xtra-tec® Point Drill

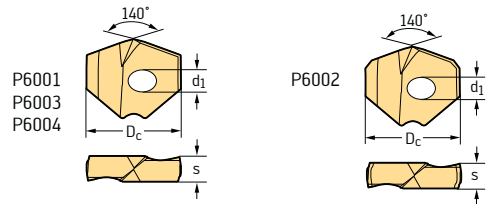

Inserts

Designation	Cutting edges	D _c mm	d ₁ mm	s mm	P6001	P6003	P6003	P6002	P6004	P6003
					P HC WXP 45	P HC WMP 35	M HC WMP 35	K HC WXK 25	N HC WNN 25	S HC WMP 35
P60...-D24,00R	2	24,00	5	6,5	☺	☺	☺	☺	☺	☺
P60...-D24,21R	2	24,21	5	6,5	☺			☺		
P60...-D24,50R	2	24,50	5	6,5	☺	☺	☺	☺	☺	☺
P60...-D24,59R	2	24,59	5	6,5	☺			☺		
P60...-D24,70R	2	24,70	5	6,5	☺			☺		
P60...-D25,00R*	2	25,00	5	6,5	☺	☺	☺	☺	☺	☺
P60...-D25,25R	2	25,25	5	6,5	☺	☺	☺			☺
P60...-D25,40R	2	25,40	5	6,5	☺	☺	☺	☺		☺
P60...-D25,50R	2	25,50	5	6,5	☺	☺	☺	☺	☺	☺
P60...-D25,65R	2	25,65	5	6,5	☺	☺	☺			☺
P60...-D25,80R	2	25,80	5	6,5	☺			☺		
P60...-D26,00R	2	26,00	6	7,1	☺	☺	☺	☺	☺	☺
P60...-D26,25R	2	26,25	6	7,1	☺			☺		
P60...-D26,50R	2	26,50	6	7,1	☺	☺	☺	☺	☺	☺
P60...-D26,59R	2	26,59	6	7,1	☺			☺		
P60...-D27,00R	2	27,00	6	7,1	☺	☺	☺			☺
P60...-D27,38R	2	27,38	6	7,1	☺			☺		
P60...-D27,50R	2	27,50	6	7,1	☺	☺	☺	☺	☺	☺
P60...-D27,78R	2	27,78	6	7,1	☺			☺		
P60...-D28,00R	2	28,00	6	7,7	☺	☺	☺	☺	☺	☺
P60...-D28,17R	2	28,17	6	7,7	☺			☺		
P60...-D28,50R	2	28,50	6	7,7	☺	☺	☺	☺	☺	☺
P60...-D28,57R	2	28,57	6	7,7	☺	☺	☺	☺		☺
P60...-D29,00R	2	29,00	6	7,7	☺	☺	☺	☺	☺	☺
P60...-D29,37R	2	29,37	6	7,7	☺			☺		
P60...-D29,50R	2	29,50	6	7,7	☺	☺	☺	☺	☺	☺
P60...-D29,77R	2	29,77	6	7,7	☺			☺		
P60...-D30,00R	2	30,00	6	8,0	☺	☺	☺	☺	☺	☺
P60...-D30,15R	2	30,15	6	8,0	☺			☺		
P60...-D30,50R	2	30,50	6	8,0	☺	☺	☺	☺	☺	☺
P60...-D31,00R	2	31,00	6	8,0	☺	☺	☺	☺	☺	☺
P60...-D31,50R	2	31,50	6	8,0	☺	☺	☺	☺	☺	☺
P60...-D31,75R	2	31,75	6	8,0	☺	☺	☺	☺		☺
P60...-D31,99R	2	31,99			☺			☺		
P60...-D32,00R	2	32,00				☺	☺			☺
P60...-D33,00R	2	33,00				☺	☺			☺
P60...-D34,00R	2	34,00				☺	☺			☺
P60...-D35,00R	2	35,00				☺	☺			☺
P60...-D36,00R	2	36,00				☺	☺			☺
P60...-D37,00R	2	37,00				☺	☺			☺
P60...-D37,99R	2	37,99				☺	☺			☺

* Ordering example:

P60...-D26,00R is available as P6003 in the grade WMP 35 (ISO P, ISO M and ISO S) → P6003-D26,00R WMP 35
or as P6001 in the grade WXP 45 (ISO P) → P6001-D26,00R WXP 45

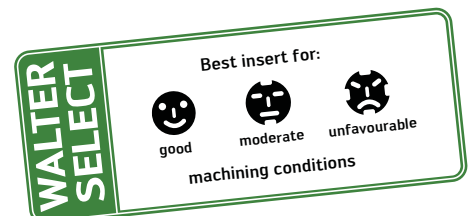

Positive basic shape TCGT / TCMT / TCMW

Tiger-tec®

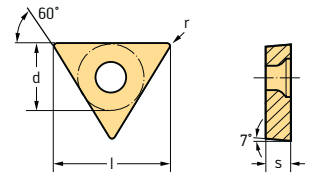

Indexable inserts

Designation	d mm	l mm	s mm	r mm	P				M				K			N		S			
					HC				HC				HC			HC	HW	HC			
					WPP01	WPP10	WPP20	WPP30	WSM10	WSM20	WSM21	WSM30	WAK10	WAK20	WAK30	WXN10	WK1	WSM10	WSM20	WSM30	
TCMT06T102-PF4	3,97	6,9	1,98	0,2																	
TCMT06T104-PF4	3,97	6,9	1,98	0,4																	
TCMT090202-PF4	5,56	9	2,38	0,2	☺	☺	☺	☺	☺	☺									☺	☺	☺
TCMT090204-PF4	5,56	9	2,38	0,4	☺	☺	☺	☺	☺	☺									☺	☺	☺
TCMT090208-PF4	5,56	9	2,38	0,8	☺	☺	☺	☺	☺	☺									☺	☺	☺
TCMT110202-PF4	6,35	11	2,38	0,2	☺	☺	☺	☺	☺	☺									☺	☺	☺
TCMT110204-PF4	6,35	11	2,38	0,4	☺	☺	☺	☺	☺	☺									☺	☺	☺
TCMT110208-PF4	6,35	11	2,38	0,8	☺	☺	☺	☺	☺	☺									☺	☺	☺
TCMT16T302-PF4	9,525	16,5	3,97	0,2	☺	☺	☺	☺	☺	☺									☺	☺	☺
TCMT16T304-PF4	9,525	16,5	3,97	0,4	☺	☺	☺	☺	☺	☺									☺	☺	☺
TCMT16T308-PF4	9,525	16,5	3,97	0,8	☺	☺	☺	☺	☺	☺									☺	☺	☺
TCMT110204-PS5	6,35	11	2,38	0,4			☺		☺	☺	☺	☺	☺						☺	☺	☺
TCMT110208-PS5	6,35	11	2,38	0,8			☺		☺	☺	☺	☺	☺						☺	☺	☺
TCMT16T304-PS5	9,525	16,5	3,97	0,4			☺		☺	☺	☺	☺	☺						☺	☺	☺
TCMT16T308-PS5	9,525	16,5	3,97	0,8			☺		☺	☺	☺	☺	☺						☺	☺	☺
TCGT110201-PM2	6,35	11	2,38	0,1												☺	☺				
TCGT110202-PM2	6,35	11	2,38	0,2												☺	☺				
TCGT110204-PM2	6,35	11	2,38	0,4												☺	☺				
TCGT16T302-PM2	9,525	16,5	3,97	0,2												☺	☺				
TCGT16T304-PM2	9,525	16,5	3,97	0,4												☺	☺				
TCGT16T308-PM2	9,525	16,5	3,97	0,8												☺	☺				
TCMT090204-PM5	5,56	9	2,38	0,4		☺	☺	☺		☺	☺	☺	☺						☺	☺	☺
TCMT090208-PM5	5,56	9	2,38	0,8		☺	☺	☺		☺	☺	☺	☺						☺	☺	☺
TCMT110204-PM5	6,35	11	2,38	0,4		☺	☺	☺	☺	☺	☺	☺	☺						☺	☺	☺
TCMT110208-PM5	6,35	11	2,38	0,8		☺	☺	☺	☺	☺	☺	☺	☺						☺	☺	☺
TCMT16T304-PM5	9,525	16	3,97	0,4		☺	☺	☺	☺	☺	☺	☺	☺						☺	☺	☺
TCMT16T308-PM5	9,525	16,5	3,97	0,8		☺	☺	☺	☺	☺	☺	☺	☺						☺	☺	☺
TCMT16T312-PM5	9,525	16,5	3,97	1,2		☺	☺	☺	☺	☺	☺	☺	☺						☺	☺	☺
TCMW110202	6,35	11	2,38	0,2									☺	☺							
TCMW110204	6,35	11	2,38	0,4									☺	☺							
TCMW110208	6,35	11	2,38	0,8									☺	☺							
TCMW16T304	9,525	16,5	3,97	0,4									☺	☺							
TCMW16T308	9,525	16,5	3,97	0,8									☺	☺							
TCMW16T312	9,525	16,5	3,97	1,2									☺	☺							

For achievable surface finish qualities and technical information, see page A 298.

HC = Coated carbide
HW = Uncoated carbide

Square
P 484 .

Tiger-tec®

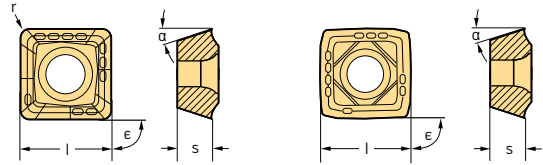

Indexable inserts

Outer insert	Designation	Number of cutting edges	l mm	s mm	r mm	α	ε	P		M	K		S		HC
								HC		HC	HC		HC	HC	
								WKP25	WKP35	WSP45	WAK15	WKP25	WKP35	WSP45	WXP45
	P4840P-1R-A57	4	4,55	1,96	0,29	11°	90°	☒	☒	☒	☒	☒	☒	☒	
	P4840P-2R-A57	4	5,52	2,38	0,34	11°	90°	☒	☒	☒	☒	☒	☒	☒	
	P4840P-3R-A57	4	6,5	2,8	0,4	11°	90°	☒	☒	☒	☒	☒	☒	☒	
	P4840P-4R-A57	4	7,8	3,36	0,48	11°	90°	☒	☒	☒	☒	☒	☒	☒	
	P4840P-5R-A57	4	9,56	4,12	0,59	11°	90°	☒	☒	☒	☒	☒	☒	☒	
	P4840P-6R-A57	4	11,75	4,87	0,7	11°	90°	☒	☒	☒	☒	☒	☒	☒	
	P4840P-7R-A57	4	14,03	5,53	0,8	11°	90°	☒	☒	☒	☒	☒	☒	☒	
	P4840P-8R-A57	4	16,5	5,53	1,0	11°	90°	☒	☒	☒	☒	☒	☒	☒	
	P4840P-1R-E57	4	4,55	1,96	0,29	11°	90°	☒	☒	☒	☒	☒	☒	☒	
	P4840P-2R-E57	4	5,52	2,38	0,34	11°	90°	☒	☒	☒	☒	☒	☒	☒	
	P4840P-3R-E57	4	6,5	2,8	0,4	11°	90°	☒	☒	☒	☒	☒	☒	☒	
	P4840P-4R-E57	4	7,8	3,36	0,48	11°	90°	☒	☒	☒	☒	☒	☒	☒	
	P4840P-5R-E57	4	9,56	4,12	0,59	11°	90°	☒	☒	☒	☒	☒	☒	☒	
	P4840P-6R-E57	4	11,75	4,87	0,7	11°	90°	☒	☒	☒	☒	☒	☒	☒	
	P4840P-7R-E57	4	14,03	5,53	0,8	11°	90°	☒	☒	☒	☒	☒	☒	☒	
	P4840P-8R-E57	4	16,5	5,53	1,0	11°	90°	☒	☒	☒	☒	☒	☒	☒	
	P4840P-1R-E67	4	4,55	1,96	0,29	11°	90°		☒	☒		☒	☒	☒	
	P4840P-2R-E67	4	5,52	2,38	0,34	11°	90°		☒	☒		☒	☒	☒	
	P4840P-3R-E67	4	6,5	2,8	0,4	11°	90°		☒	☒		☒	☒	☒	
	P4840P-4R-E67	4	7,8	3,36	0,48	11°	90°		☒	☒		☒	☒	☒	
	P4840P-5R-E67	4	9,56	4,12	0,59	11°	90°		☒	☒		☒	☒	☒	
	P4840P-6R-E67	4	11,75	4,87	0,7	11°	90°		☒	☒		☒	☒	☒	
	P4840P-7R-E67	4	14,03	5,53	0,8	11°	90°		☒	☒		☒	☒	☒	
	P4840P-8R-E67	4	16,5	5,53	1,0	11°	90°		☒	☒		☒	☒	☒	
	P4841P-1R-A57	4	4,55	1,96	0,29	11°	90°	☒	☒	☒		☒	☒	☒	
	P4841P-2R-A57	4	5,52	2,38	0,34	11°	90°	☒	☒	☒		☒	☒	☒	
	P4841P-3R-A57	4	6,5	2,8	0,4	11°	90°	☒	☒	☒		☒	☒	☒	
	P4841P-4R-A57	4	7,8	3,36	0,48	11°	90°	☒	☒	☒		☒	☒	☒	
	P4841P-5R-A57	4	9,56	4,12	0,59	11°	90°	☒	☒	☒		☒	☒	☒	
	P4841P-6R-A57	4	11,75	4,87	0,7	11°	90°	☒	☒	☒		☒	☒	☒	
	P4841P-7R-A57	4	14,03	5,53	0,8	11°	90°	☒	☒	☒		☒	☒	☒	
	P4841P-8R-A57	4	16,5	5,53	1,0	11°	90°	☒	☒	☒		☒	☒	☒	
	P4841P-1R-E57	4	4,55	1,96	0,29	11°	90°	☒	☒	☒		☒	☒	☒	
	P4841P-2R-E57	4	5,52	2,38	0,34	11°	90°	☒	☒	☒		☒	☒	☒	
	P4841P-3R-E57	4	6,5	2,8	0,4	11°	90°	☒	☒	☒		☒	☒	☒	
	P4841P-4R-E57	4	7,8	3,36	0,48	11°	90°	☒	☒	☒		☒	☒	☒	
	P4841P-5R-E57	4	9,56	4,12	0,59	11°	90°	☒	☒	☒		☒	☒	☒	
	P4841P-6R-E57	4	11,75	4,87	0,7	11°	90°	☒	☒	☒		☒	☒	☒	
	P4841P-7R-E57	4	14,03	5,53	0,8	11°	90°	☒	☒	☒		☒	☒	☒	
	P4841P-8R-E57	4	16,5	5,53	1,0	11°	90°	☒	☒	☒		☒	☒	☒	

HC = Coated carbide

Square
P 484 .
Tiger-tec®

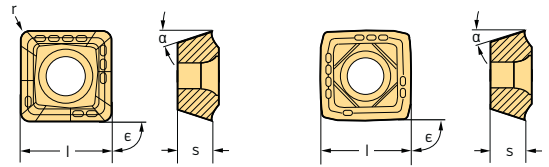

Indexable inserts

Designation	Number of cutting edges	l mm	s mm	r mm	α	ε	P		M		K		S		HC	
							HC	HC	HC	HC	HC	HC				
							WKP25	WKP35	WSP45	WSP45	WAK15	WKP25	WKP35	WSP45	WXP45	
Centre insert																
	P4841C-1R-A57	4	4,9	1,96	0,29	11°	90°									
	P4841C-2R-A57	4	5,95	2,38	0,34	11°	90°									
	P4841C-3R-A57	4	7,0	2,8	0,4	11°	90°									
	P4841C-4R-A57	4	8,4	3,36	0,48	11°	90°									
	P4841C-5R-A57	4	10,29	4,12	0,59	11°	90°									
	P4841C-6R-A57	4	12,24	4,87	0,7	11°	90°									
	P4841C-7R-A57	4	14,69	5,53	0,8	11°	90°									
	P4841C-8R-A57	4	17,49	5,53	1,0	11°	90°									
Centre insert																
	P4841C-1R-E57	4	4,9	1,96	0,29	11°	90°									
	P4841C-2R-E57	4	5,95	2,38	0,34	11°	90°									
	P4841C-3R-E57	4	7,0	2,8	0,4	11°	90°									
	P4841C-4R-E57	4	8,4	3,36	0,48	11°	90°									
	P4841C-5R-E57	4	10,29	4,12	0,59	11°	90°									
	P4841C-6R-E57	4	12,24	4,87	0,7	11°	90°									
	P4841C-7R-E57	4	14,69	5,53	0,8	11°	90°									
	P4841C-8R-E57	4	17,49	5,53	1,0	11°	90°									
Centre insert																
	P4840C-1R-E67	4	4,9	1,96	0,29	11°	90°									
	P4840C-2R-E67	4	5,95	2,38	0,34	11°	90°									
	P4840C-3R-E67	4	7,0	2,8	0,4	11°	90°									
	P4840C-4R-E67	4	8,4	3,36	0,48	11°	90°									
	P4840C-5R-E67	4	10,29	4,12	0,59	11°	90°									
	P4840C-6R-E67	4	12,24	4,87	0,7	11°	90°									
	P4840C-7R-E67	4	14,69	5,53	0,8	11°	90°									
	P4840C-8R-E67	4	17,49	5,53	1,0	11°	90°									

HC = Coated carbide

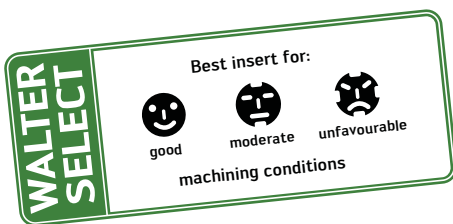

Square
P284..

Tiger-tec®

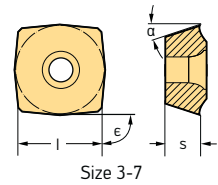
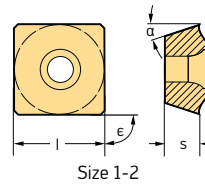

Indexable inserts

	Designation	Number of cutting edges	l mm	s mm	α	ε	P				M	K			S	HC	
							HC				HC	HC		HC	HC		
							WAP20	WKP25	WKP35	WTP35	WSP45	WAK15	WKP25	WKP35	WSP45	WXP40	WXP45
	P28467-1	4	6,35	2,38	14°	90°	⊗	⊗	⊗	⊗		⊗	⊗	⊗	⊗		
	P28467-2	4	7,8	3,18	14°	90°	⊗	⊗	⊗	⊗		⊗	⊗	⊗	⊗		
	P28467-3	4	9,52	3,97	11°	96°	⊗	⊗	⊗	⊗		⊗	⊗	⊗	⊗		
	P28467-4	4	11	3,97	11°	96°	⊗	⊗	⊗	⊗		⊗	⊗	⊗	⊗		
	P28467-5	4	12,7	4,76	11°	96°	⊗	⊗	⊗	⊗		⊗	⊗	⊗	⊗		
	P28467-6	4	15	4,76	11°	96°	⊗	⊗	⊗	⊗		⊗	⊗	⊗	⊗		
	P28467-7	4	17,6	5,56	11°	96°	⊗	⊗	⊗	⊗		⊗	⊗	⊗	⊗		
	P28469-1	4	6,35	2,38	14°	90°		⊗	⊗	⊗	⊗		⊗	⊗	⊗		
	P28469-2	4	7,8	3,18	14°	90°		⊗	⊗	⊗	⊗		⊗	⊗	⊗		
	P28469-3	4	9,52	3,97	11°	96°		⊗	⊗	⊗	⊗		⊗	⊗	⊗		
	P28469-4	4	11	3,97	11°	96°		⊗	⊗	⊗	⊗		⊗	⊗	⊗		
	P28469-5	4	12,7	4,76	11°	96°		⊗	⊗	⊗	⊗		⊗	⊗	⊗		
	P28469-6	4	15	4,76	11°	96°		⊗	⊗	⊗	⊗		⊗	⊗	⊗		
	P28469-7	4	17,6	5,56	11°	96°		⊗	⊗	⊗	⊗		⊗	⊗	⊗		
	P28475-1	4	6,35	2,38	14°	90°		⊗	⊗	⊗			⊗	⊗	⊗		⊗
	P28475-2	4	7,8	3,18	14°	90°		⊗	⊗	⊗			⊗	⊗	⊗		⊗
	P28475-3	4	9,52	3,97	11°	96°		⊗	⊗	⊗			⊗	⊗	⊗		⊗
	P28475-4	4	11	3,97	11°	96°		⊗	⊗	⊗			⊗	⊗	⊗		⊗
	P28475-5	4	12,7	4,76	11°	96°		⊗	⊗	⊗			⊗	⊗	⊗		⊗
	P28475-6	4	15	4,76	11°	96°		⊗	⊗	⊗			⊗	⊗	⊗		⊗
	P28477-1	4	6,35	2,38	14°	90°		⊗	⊗	⊗		⊗	⊗	⊗	⊗		⊗
	P28477-2	4	7,8	3,18	14°	90°		⊗	⊗	⊗		⊗	⊗	⊗	⊗		⊗
	P28477-3	4	9,52	3,97	11°	96°		⊗	⊗	⊗		⊗	⊗	⊗	⊗		⊗
	P28477-4	4	11	3,97	11°	96°		⊗	⊗	⊗		⊗	⊗	⊗	⊗		⊗
	P28477-5	4	12,7	4,76	11°	96°		⊗	⊗	⊗		⊗	⊗	⊗	⊗		⊗
	P28477-6	4	15	4,76	11°	96°		⊗	⊗	⊗		⊗	⊗	⊗	⊗		⊗
	P28477-7	4	17,6	5,56	11°	96°		⊗	⊗	⊗		⊗	⊗	⊗	⊗		⊗
	P28479-1	4	6,35	2,38	14°	90°		⊗	⊗	⊗			⊗	⊗	⊗		⊗
	P28479-2	4	7,8	3,18	14°	90°		⊗	⊗	⊗			⊗	⊗	⊗		⊗
	P28479-3	4	9,52	3,97	11°	96°		⊗	⊗	⊗			⊗	⊗	⊗		⊗
	P28479-4	4	11	3,97	11°	96°		⊗	⊗	⊗			⊗	⊗	⊗		⊗
	P28479-5	4	12,7	4,76	11°	96°		⊗	⊗	⊗			⊗	⊗	⊗		⊗
	P28479-6	4	15	4,76	11°	96°		⊗	⊗	⊗			⊗	⊗	⊗		⊗
	P28479-7	4	17,6	5,56	11°	96°		⊗	⊗	⊗			⊗	⊗	⊗		⊗

HC = Coated carbide

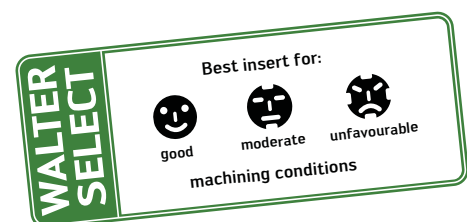

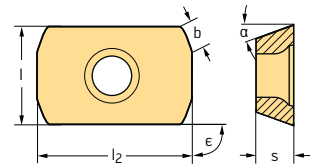

Rectangular LCMX

Tiger-tec®



Indexable inserts

Designation	Number of cutting edges	l mm	l ₂ mm	s mm	α	b mm	ε	P		M	K		S	HC		
								HC		HC	HC		HC	HC		
								WAP20	WKP25	WKP35	WTP35	WSP45	WSP45	WAK15	WKP25	WKP35
 LCMX050203-B57 LCMX06T204-B57	2	4	5,2	2,38	7°	0,6	90°									
	2	5,2	6,6	2,78	7°	0,8	90°									
 LCMX050203-D57 LCMX06T204-D57	2	4	5,2	2,38	7°	0,6	90°									
	2	5,2	6,6	2,78	7°	0,8	90°									
 LCMX050203-E57 LCMX06T204-E57	2	4	5,2	2,38	7°	0,6	90°									
	2	5,2	6,6	2,78	7°	0,8	90°									



HC = Coated carbide

Trigon indexable inserts WOMX / WOEX

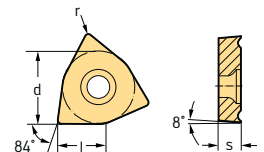
Tiger-tec®



Indexable inserts

Designation	Number of cutting edges	l mm	s mm	r mm	d mm	P		M	K		S	HC	
						HC		HC	HC		HC	HC	
						WAP20	WKP25	WKP35	WSP45	WSP45	WAK15	WKP25	WKP35
 WOMX030204-B57 WOMX040304-B57 WOMX05T304-B57 WOMX06T304-B57 WOMX080408-B57 WOMX100508-B57 WOMX120608-B57	3	3,31	2,3	0,4	5								
	3	4,2	3,18	0,4	6,35								
	3	5,29	3,8	0,4	8								
	3	6,62	3,8	0,4	10								
	3	7,94	4,8	0,8	12								
	3	9,92	5,3	0,8	15								
	3	11,64	6	0,8	17,6								
 WOMX030204-D57 WOMX040304-D57 WOMX05T304-D57 WOMX06T304-D57 WOMX080408-D57 WOMX100508-D57 WOMX120608-D57	3	3,31	2,3	0,4	5								
	3	4,2	3,18	0,4	6,35								
	3	5,29	3,8	0,4	8								
	3	6,62	3,8	0,4	10								
	3	7,94	4,8	0,8	12								
	3	9,92	5,3	0,8	15								
	3	11,64	6	0,8	17,6								
 WOEX030204-E57 WOEX040304-E57 WOEX05T304-E57 WOEX06T304-E57 WOEX080408-E57 WOEX100508-E57 WOEX120608-E57	3	3,31	2,3	0,4	5								
	3	4,2	3,18	0,4	6,35								
	3	5,29	3,8	0,4	8								
	3	6,62	3,8	0,4	10								
	3	7,94	4,8	0,8	12								
	3	9,92	5,3	0,8	15								
	3	11,64	6	0,8	17,6								

HC = Coated carbide

Walter Select for indexable inserts for boring and counterboring

Step by step to the right indexable insert

STEP 1













Determine the **material** to be machined, see page H 8 onwards.

Note the machining group that corresponds to your material e.g.: P10.

Identification letters	Machining group	Groups of the materials to be machined	
P	P1–P15	Steel	All types of steel and cast steel, with the exception of steel with an austenitic structure
M	M1–M3	Stainless steel	Stainless austenitic steel and austenitic-ferritic steel and cast steel
K	K1–K7	Cast iron	Grey cast iron, cast iron with spheroidal graphite, malleable cast iron, cast iron with vermicular graphite
N	N1–N10	NF metals	Aluminium and other non-ferrous metals, non-ferrous materials
S	S1–S10	High temperature alloys and titanium alloys	Heat resisting special alloys based on iron, nickel and cobalt, titanium and titanium alloys
H	H1–H4	Hard materials	Hardened steel, hardened cast iron materials, chilled cast iron
O	O1–O6	Other	Plastics, fibre glass and carbon fibre reinforced plastics, graphite

STEP 2

Select the **machining conditions**:

Type of cutting action	Machine stability, clamping system and workpiece		
	very good	good	moderate
Smooth cut, premachined surface			
Cast or forged skin Varying cutting depths Slight interrupted cuts			
Medium interrupted cuts			
Heavily interrupted cuts			

STEP 3

Determine the insert geometry via the cutting depth (a_p) and the feed (f_z).

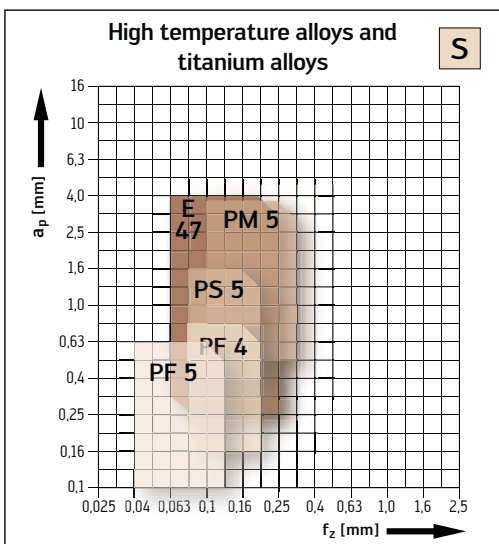
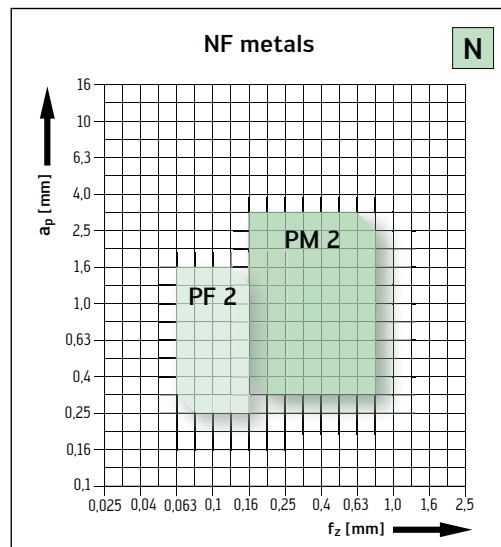
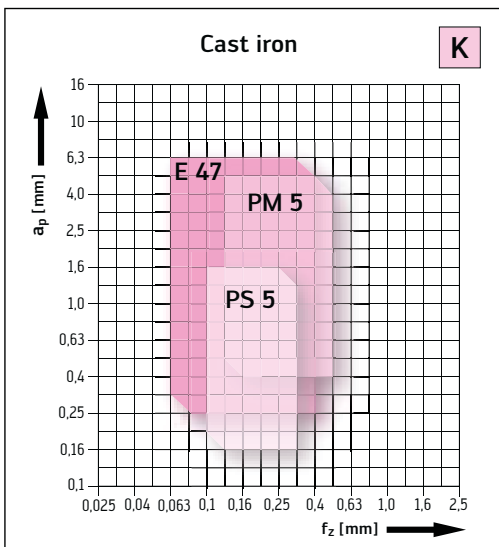
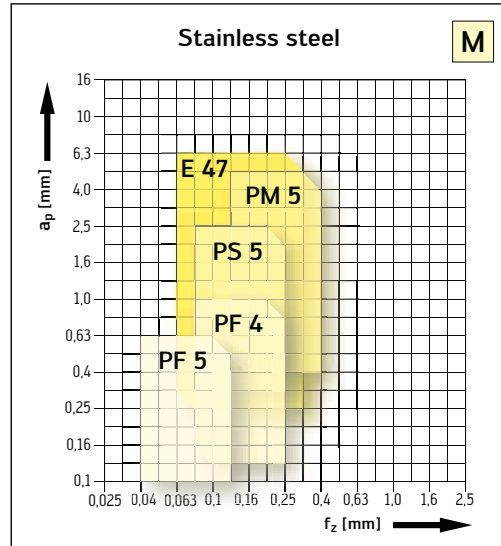
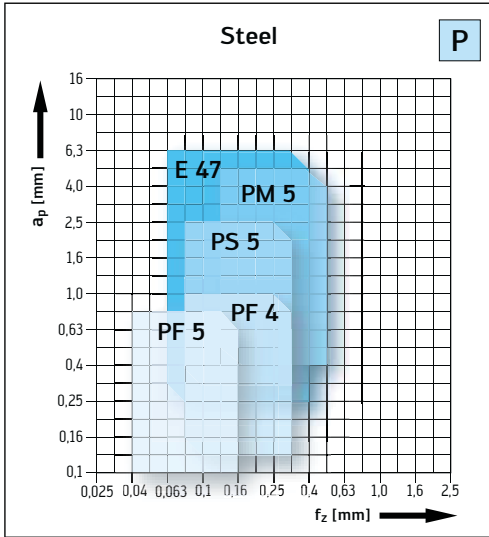

Walter Select for indexable inserts for boring and counterboring

Step by step to the right indexable insert

STEP 4

Determine the **cutting material** by means of the indexable insert geometry and the machining conditions:

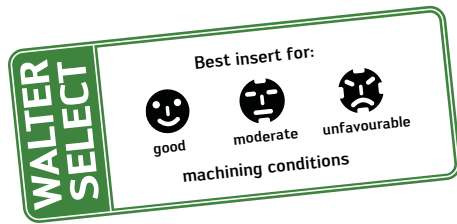

Symbol	Machining group	Ø accuracy	Walter Insert geometry	Machining conditions		
P	P1-P15	medium	E 47	WPP 20	WPP 20	WSM 20
			PM 5	WPP 10	WPP 20	WPP30 / WSM 20
			PS 5	WPP 10	WPP 20	WPP 20 / WSM 20
			PF 4	WPP 01	WPP 10 / WPP 20	WPP 20 / WSM 20
		high	PF 5	WPP 20	WPP 20	WPP 30 / WSM 20
			PF 2	WSM 20	WSM 20	WSM 20
M	M1-M3	medium	E 47	WSM 20	WSM 20	WSM 20
			PM 5	WSM 10 / WSM 20	WSM 20	WSM 30
			PS 5	WSM 20	WSM 20	WSM 30
			PF 4	WSM 10 / WSM 20	WSM 20	WSM 30
		high	PF 5	WSM 30	WSM 30	WSM 30
			PF 2	WSM 20	WSM 20	WSM 20
K	K1-K7	medium	PM 5	WAK 10	WAK 20	WAK 30
			E 47	WPP 20	WPP 20	WPP 20
		high	PS 5	WAK 10	WAK 20	WAK 20
			PF 5	WPP 20	WPP 20	WPP 20
N	N1-N10	high	PM 2	WK 1 / WXN 10	WK 1 / WXN 10	WK 1 / WXN 10
			PF 2	WK 1 / WXN 10	WK 1 / WXN 10	WK 1 / WXN 10
S	S1-S10	medium	E 47	WSM 20	WSM 20	—
			PM 5	WSM 20	WSM 20	WSM 30
			PS 5	WSM 20	WSM 20	WSM 30
			PF 4	WSM 20	WSM 20	WSM 30
		high	PF 5	WSM 30	WSM 30	WSM 30
			PF 2	WSM 20	WSM 20	—
O	O1-O6	high	PM 2	WK 1 / WXN 10	WK 1 / WXN 10	WK 1 / WXN 10
			PF 2	WK 1 / WXN 10	WK 1 / WXN 10	WK 1 / WXN 10

STEP 5

Select the **cutting data**, see page C 158 onwards.

Cutting data for boring														
Material group	Structure of main material groups and identification letters				Brinell hardness HB	Tensile strength R _m (N/mm²)	Machining group 1	Insert geometry						
								Starting values for feed f (mm/rev)						
								D _c (mm)	-E47	-PMS	D _c (mm)	-E47	-PMS	
P	Unalloyed steel	C ≤ 0.25%	annealed	175	428	P1	●●	0.20	0.30	0.40	2.20	0.30	0.40	
		C > 0.25 - ≤ 0.55 %	annealed	190	639	P2	●●	0.16	0.24	0.40	0.16	0.24	0.40	
		C > 0.25 - ≤ 0.55 %	tempered	210	708	P3	●●	0.15	0.22	0.35	0.15	0.22	0.35	
		C > 0.55 %	annealed	190	639	P4	●●	0.14	0.20	0.30	0.14	0.20	0.30	
		C > 0.55 %	tempered	300	1013	P5	●●	0.12	0.18	0.25	0.12	0.18	0.25	
	Low-alloyed steel	free cutting steel (short-chipping)	annealed	220	745	P6	●●	●	0.15	0.22	0.35	0.15	0.22	0.35
			annealed	175	591	P7	●●	0.20	0.30	0.40	0.20	0.30	0.40	
			tempered	300	1013	P8	●●	0.14	0.20	0.30	0.14	0.20	0.30	
			tempered	380	1282	P9	●●	0.12	0.18	0.25	0.12	0.18	0.25	
			tempered	430	1477	P10	●●	0.10	0.15	0.20	0.10	0.15	0.20	
High-alloyed steel and high-alloyed tool steel		annealed	200	675	P11	●●	0.14	0.20	0.30	0.14	0.20	0.30		
		hardened and tempered	300	1013	P12	●●	0.13	0.18	0.27	0.13	0.18	0.27		
Stainless steel		hardened and tempered	400	1361	P13	●●	0.10	0.15	0.20	0.10	0.15	0.20		
		ferritic / martensitic, annealed	200	675	P14	●●	0.12	0.16	0.24	0.12	0.16	0.24		
M		austenitic, tempered	330	1116	P15	●●	0.12	0.16	0.24	0.12	0.16	0.24		

Positive basic shape CCGT / CCMT

Tiger-tec®

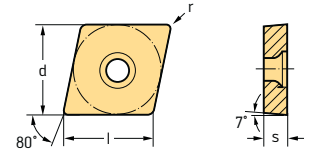

Indexable inserts

Designation	d mm	l mm	s mm	r mm	P			M			K			N		S		
					HC			HC			HC			HC	HW	HC		
					WPP01	WPP10	WPP20	WPP30	WSM10	WSM20	WSM30	WAK10	WAK20	WAK30	WXN10	WK1	WSM10	WSM20
	CCMT060202-E47	6,35	6,45	2,38	0,2		⊗			⊗	⊗						⊗	⊗
	CCMT060204-E47	6,35	6,45	2,38	0,4		⊗			⊗	⊗						⊗	⊗
	CCMT09T302-E47	9,525	9,67	3,97	0,2		⊗			⊗	⊗						⊗	⊗
	CCMT09T304-E47	9,525	9,67	3,97	0,4		⊗			⊗	⊗						⊗	⊗
	CCMT09T308-E47	9,525	9,67	3,97	0,8		⊗			⊗	⊗						⊗	⊗
	CCMT120404-E47	12,7	12,7	4,76	0,4		⊗			⊗	⊗						⊗	⊗
	CCMT120408-E47	12,7	12,7	4,76	0,8		⊗			⊗	⊗						⊗	⊗
	CCMT120412-E47	12,7	12,7	4,76	1,2		⊗			⊗	⊗						⊗	⊗
	CCGT060201-PF2	6,35	6,45	2,38	0,1					⊗			⊗	⊗			⊗	
	CCGT060202-PF2	6,35	6,45	2,38	0,2					⊗			⊗	⊗			⊗	
	CCGT060204-PF2	6,35	6,45	2,38	0,4					⊗			⊗	⊗			⊗	
	CCGT09T301-PF2	9,525	9,67	3,97	0,1					⊗			⊗	⊗			⊗	
	CCGT09T302-PF2	9,525	9,67	3,97	0,2					⊗			⊗	⊗			⊗	
	CCGT09T304-PF2	9,525	9,67	3,97	0,4					⊗			⊗	⊗			⊗	
	CCGT09T308-PF2	9,525	9,67	3,97	0,8					⊗			⊗	⊗			⊗	
	CCMT060202-PF4	6,35	6,45	2,38	0,2	⊗	⊗	⊗		⊗	⊗						⊗	⊗
CCMT060204-PF4	6,35	6,45	2,38	0,4	⊗	⊗	⊗		⊗	⊗						⊗	⊗	
CCMT060208-PF4	6,35	6,45	2,38	0,8	⊗	⊗	⊗		⊗	⊗						⊗	⊗	
CCMT09T302-PF4	9,525	9,67	3,97	0,2	⊗	⊗	⊗		⊗	⊗						⊗	⊗	
CCMT09T304-PF4	9,525	9,67	3,97	0,4	⊗	⊗	⊗		⊗	⊗						⊗	⊗	
CCMT09T308-PF4	9,525	9,67	3,97	0,8	⊗	⊗	⊗		⊗	⊗						⊗	⊗	
CCMT120404-PF4	12,7	12,9	4,76	0,4	⊗	⊗	⊗		⊗	⊗						⊗	⊗	
CCMT120408-PF4	12,7	12,9	4,76	0,8	⊗	⊗	⊗		⊗	⊗						⊗	⊗	
	CCGT060202-PF5	6,35	6,45	2,38	0,2			⊗		⊗								⊗
	CCGT060204-PF5	6,35	6,45	2,38	0,4			⊗		⊗								⊗
	CCGT09T302-PF5	9,525	9,67	3,97	0,2			⊗		⊗								⊗
	CCGT09T304-PF5	9,525	9,67	3,97	0,4			⊗		⊗								⊗
	CCMT060204-PS5	6,35	6,45	2,38	0,4		⊗			⊗	⊗						⊗	⊗
	CCMT060208-PS5	6,35	6,45	2,38	0,8		⊗			⊗	⊗						⊗	⊗
	CCMT09T304-PS5	9,525	9,67	3,97	0,4		⊗			⊗	⊗						⊗	⊗
	CCMT09T308-PS5	9,525	9,67	3,97	0,8		⊗			⊗	⊗						⊗	⊗
	CCMT120404-PS5	12,7	12,9	4,76	0,4		⊗			⊗	⊗						⊗	⊗
	CCMT120408-PS5	12,7	12,9	4,76	0,8		⊗			⊗	⊗						⊗	⊗

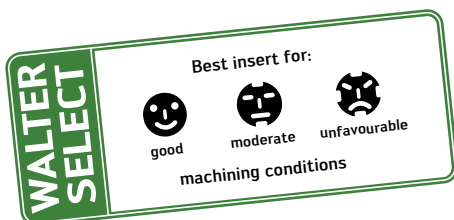

HC = Coated carbide
HW = Uncoated carbide

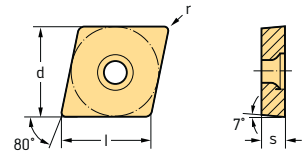

Positive basic shape CCGT / CCMT

Tiger-tec®

Indexable inserts

Designation	d mm	l mm	s mm	r mm	P				M			K			N		S		
					HC				HC			HC			HC	HW	HC		
					WPP01	WPP10	WPP20	WPP30	WSM10	WSM20	WSM30	WAK10	WAK20	WAK30	WXN10	WK1	WSM10	WSM20	WSM30
 CCGT060201-PM2	6,35	6,45	2,38	0,1											☺	☺			
CCGT060202-PM2	6,35	6,45	2,38	0,2											☺	☺			
CCGT060204-PM2	6,35	6,45	2,38	0,4											☺	☺			
CCGT09T301-PM2	9,525	9,67	3,97	0,1											☺	☺			
CCGT09T302-PM2	9,525	9,67	3,97	0,2											☺	☺			
CCGT09T304-PM2	9,525	9,67	3,97	0,4											☺	☺			
CCGT09T308-PM2	9,525	9,67	3,97	0,8											☺	☺			
CCGT120402-PM2	12,7	12,9	4,76	0,2											☺	☺			
CCGT120404-PM2	12,7	12,9	4,76	0,4											☺	☺			
CCGT120408-PM2	12,7	12,9	4,76	0,8											☺	☺			
 CCMT060204-PM5	6,35	6,45	2,38	0,4		☺	☺	☺	☺	☺	☺	☺	☺	☺			☺	☺	☺
CCMT060208-PM5	6,35	6,45	2,38	0,8		☺	☺	☺	☺	☺	☺	☺	☺	☺			☺	☺	☺
CCMT09T304-PM5	9,525	9,67	3,97	0,4		☺	☺	☺	☺	☺	☺	☺	☺	☺			☺	☺	☺
CCMT09T308-PM5	9,525	9,67	3,97	0,8		☺	☺	☺	☺	☺	☺	☺	☺	☺			☺	☺	☺
CCMT120404-PM5	12,7	12,9	4,76	0,4		☺	☺	☺	☺	☺	☺	☺	☺	☺			☺	☺	☺
CCMT120408-PM5	12,7	12,9	4,76	0,8		☺	☺	☺	☺	☺	☺	☺	☺	☺			☺	☺	☺
CCMT120412-PM5	12,7	12,9	4,76	1,2		☺	☺	☺	☺	☺	☺	☺	☺	☺			☺	☺	☺

HC = Coated carbide
HW = Uncoated carbide

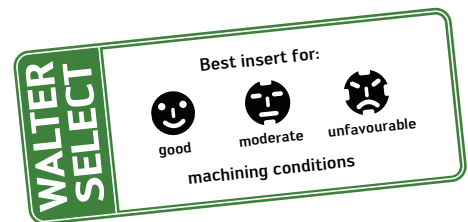

Positive basic shape WCGT / WCMT

Tiger-tec®

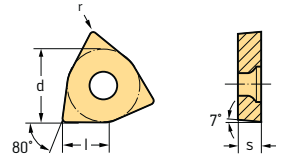

Indexable inserts

Designation	d mm	l mm	s mm	r mm	P				M			K		N		S				
					HC				HC			HC	HC	HW	HC					
					WPP01	WPP10	WPP20	WPP30	WSM10	WSM20	WSM21	WSM30	WAK10	WAK20	WXN10	WK1	WSM10	WSM20	WSM30	
	WCGT030201-PF2	5,56	3,8	2,38	0,1															
	WCGT030202-PF2	5,56	3,8	2,38	0,2															
	WCGT030204-PF2	5,56	3,8	2,38	0,4															
	WCGT040201-PF2	6,35	4,3	2,38	0,1															
	WCGT040202-PF2	6,35	4,3	2,38	0,2															
	WCGT040204-PF2	6,35	4,3	2,38	0,4															
	WCGT06T301-PF2	9,525	6,5	3,97	0,1															
	WCGT06T302-PF2	9,525	6,5	3,97	0,2															
	WCGT06T304-PF2	9,525	6,5	3,97	0,4															
WCGT06T308-PF2	9,525	6,5	3,97	0,8																
	WCMT040202-PF4	6,35	4,3	2,38	0,2															
	WCMT040204-PF4	6,35	4,3	2,38	0,4															
	WCMT040208-PF4	6,35	4,3	2,38	0,8															
	WCMT06T302-PF4	9,525	6,5	3,97	0,2															
	WCMT06T304-PF4	9,525	6,5	3,97	0,4															
	WCMT06T308-PF4	9,525	6,5	3,97	0,8															
	WCMT080404-PF4	12,7	8,7	4,76	0,4															
	WCMT080408-PF4	12,7	8,7	4,76	0,8															
	WCMT040204-PS5	6,35	4,3	2,38	0,4															
	WCMT040208-PS5	6,35	4,3	2,38	0,8															
	WCMT06T304-PS5	9,525	6,5	3,97	0,4															
	WCMT06T308-PS5	9,525	6,5	3,97	0,8															
	WCMT080404-PS5	12,7	8,7	4,76	0,4															
	WCMT080408-PS5	12,7	8,7	4,76	0,8															
	WCGT030202-PM2	5,56	3,8	2,38	0,2															
	WCGT030204-PM2	5,56	3,8	2,38	0,4															
	WCGT040202-PM2	6,35	4,3	2,38	0,2															
	WCGT040204-PM2	6,35	4,3	2,38	0,4															
	WCGT06T302-PM2	9,525	6,5	3,97	0,2															
	WCGT06T304-PM2	9,525	6,5	3,97	0,4															
	WCGT080404-PM2	12,7	8,7	4,76	0,4															
	WCGT080408-PM2	12,7	8,7	4,76	0,8															
	WCMT030202-PM5	5,56	3,8	2,38	0,2															
	WCMT040202-PM5	6,35	4,3	2,38	0,2															
	WCMT040204-PM5	6,35	4,3	2,38	0,4															
	WCMT06T304-PM5	9,525	6,5	3,97	0,4															
	WCMT06T308-PM5	9,525	6,5	3,97	0,8															
	WCMT080404-PM5	12,7	8,7	4,76	0,4															
	WCMT080408-PM5	12,7	8,7	4,76	0,8															
	WCMT080412-PM5	12,7	8,7	4,76	1,2															

HC = Coated carbide
HW = Uncoated carbide

Walter Select for indexable inserts for precision boring

Step by step to the right indexable insert

STEP 1



Determine the **material** to be machined, see page H 8 onwards.

Note the machining group that corresponds to your material e.g.: P10.

Identification letters	Machining group	Groups of the materials to be machined	
P	P1–P15	Steel	All types of steel and cast steel, with the exception of steel with an austenitic structure
M	M1–M3	Stainless steel	Stainless austenitic steel and austenitic-ferritic steel and cast steel
K	K1–K7	Cast iron	Grey cast iron, cast iron with spheroidal graphite, malleable cast iron, cast iron with vermicular graphite
N	N1–N10	NF metals	Aluminium and other non-ferrous metals, non-ferrous materials
S	S1–S10	High temperature alloys and titanium alloys	Heat resisting special alloys based on iron, nickel and cobalt, titanium and titanium alloys
H	H1–H4	Hard materials	Hardened steel, hardened cast iron materials, chilled cast iron
O	O1–O6	Other	Plastics, fibre glass and carbon fibre reinforced plastics, graphite

STEP 2

Select the **machining conditions**:

Type of cutting action	Machining conditions
Smooth cut, level entry or exit surfaces	
Laminate bores Cast and forged inclines < 5°	
Bores with interrupted cuts Cast and forged inclines > 5°	

STEP 3

Determine the **indexable insert geometry** via the material and the projection length.

Identification letters	Machining group	Projection length		
		< 3 x D _c	< 5 x D _c	< 6 x D _c
P	P1–P15	PF 2 / PF 5 / PF 4	X 5 / X 15	—
M	M1–M3	PF 4 / PF 5	X 5 / X 15	—
K	K1–K7	PF 4 / CCMW / WCMW	X 5 / CCMW / WCMW	X 15
N	N1–N6	PM 2 / PF 2 / WCMW	X 25 / PF 2 / WCMW	X 25 / PF 2
	N7–N10	PM 2 / PF 2	X 15 / X 25	X 25
S	S1–S10	PM 2 / PF 2 / PF 5	X 5 / X 15	—
H	H1–H4	CCMW / WCMW	CCMW / WCMW	—
O	O1–O6	PM 2 / PF 2 / WCMW	X 25 / WCMW	—

STEP 4

Determine the **cutting material** by means of the indexable insert geometry and the machining conditions:

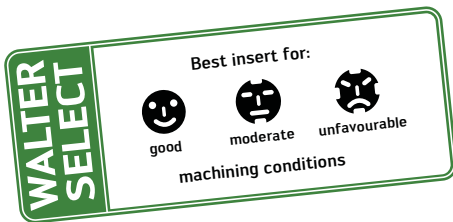

Identi- fication letters	Machining group	Walter Insert geometry	Machining conditions		
P	P1–P15	X 5 / X15	WAK 15	WXM 15	WTP 35
		PF 2	WSM 20	WSM 20	WSM 20
		PF 5	WPP 20	WPP 20	WPP 20
		PF 4*	WPP 10	WPP 20	WPP 20
M	M1–M3	X 5 / X15	WTP 35 / WXM 15	WTP 35 / WXM 15	WTP 35 / WXM 15
		PF 2	WSM 20	WSM 20	—
		PF 5	—	WSM 30	WSM 30
K	K1–K7	X 5 / X15	WAK 15	WXM 15	WTP 35
		CCMW / WCMW	WCB 80	WCB 50	—
		PF 4*	WPP 10	WPP 20	WPP 20
N	N1–N6	X 25	WK 1	WK 1	WK 1
		PM 2	WK 1 / WXN 10	WK 1 / WXN 10	WK 1 / WXN 10
		PF 2	WK 1 / WXN 10	WK 1 / WXN 10	WK 1 / WXN 10
		WCMW	WCD 10	WCD 10	—
	N7–N10	X 17 / X 25	WK 1	WK 1	WK 1
		PF 2	WK 1 / WXN 10	WK 1 / WXN 10	WK 1 / WXN 10
S	S1–S10	X5 / X 15	WK 1	WK 1	WK 1
		PM 2	WXN 10	—	—
		PF 2	WSM 20	WSM 20	—
		PF 5	WSM 30	WSM 30	WSM 30
H	H1–H4	CCMW	WCB 30	WCB 50	WCB 50
		WCMW	WCB 50	WCB 50	WCB 50
O	O1–O6	X 25	WK 1	WK 1	WK 1
		PM 2	WK 1	WK 1	WK 1
		PF 2	WK 1	WK 1	WK 1
		WCMW	WCD 10	WCD 10	—

* Insert fully sintered

Walter Select for indexable inserts for precision boring

Step by step to the right indexable insert

STEP 5

Now select the **corner radius r** and the **cutting depth a_p** by means of the adjacent graphs.

Preference should be given to the maximum possible corner radius depending on the relevant length-to-diameter ratio (L/D). The optimal cutting depths a_p are around 2/3 of the specified maximum a_p values.

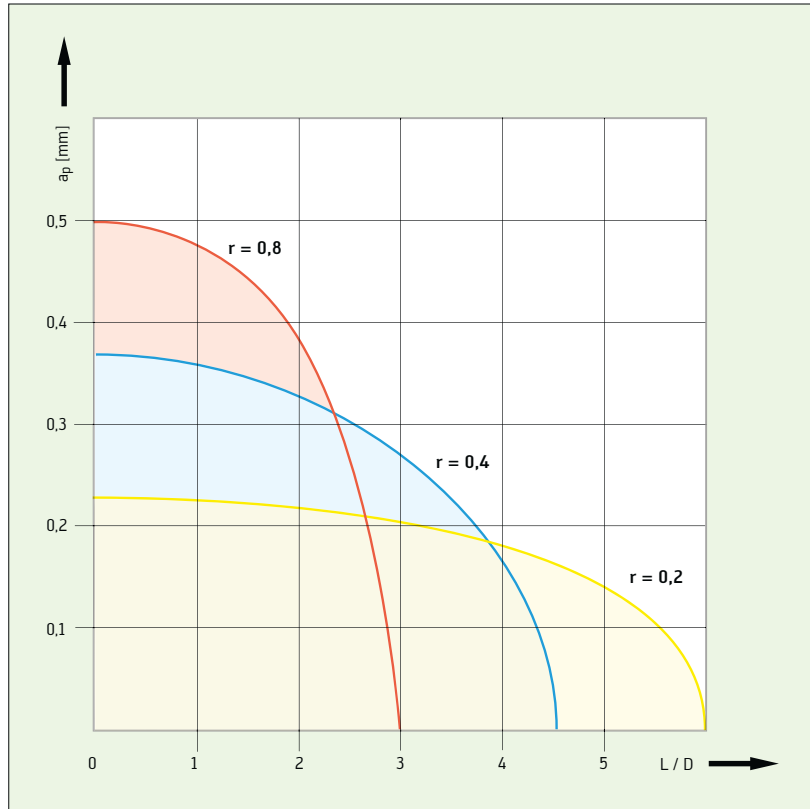

STEP 6

Now select the maximum feed rate depending on the specified surface quality of the workpiece and the corner radius of the insert selected in step 5.

Corner radius indexable insert r [mm]	Roughness [μm]									
	max. feed rate f [mm/rev]									
	0,03		0,06		0,09		0,12		0,15	
	R_{max}	R_a	R_{max}	R_a	R_{max}	R_a	R_{max}	R_a	R_{max}	R_a
0,2	0,56	0,14	2,26	0,58	5,13	1,32	9,21	3,38	14,60	3,79
0,4	0,28	0,07	1,13	0,29	2,54	0,65	4,53	1,16	7,09	1,83

STEP 7

Select the **cutting data**, see page C 162 onwards.

Cutting data for precision boring										
Material group	Structure of main material groups and identification letters	Brinell hardness HB	Tensile strength R_m N/mm ²	Machining group	Starting values for cutting speed v_c [m/min]					
					HC			WPP01 / WPP10		
					3 x D _c	4 x D _c	6 x D _c	L/D	L/D	L/D
P Unalloyed steel	C ≤ 0.25%	annealed	125 428	P1	●●	●●	●●	●●	●●	●●
	C > 0.25 % ≤ 0.55 %	annealed	190 639	P2	●●	●●	●●	●●	●●	●●
	C > 0.25 % ≤ 0.55 %	tempered	210 708	P3	●●	●●	●●	●●	●●	●●
	C > 0.55 %	annealed	190 639	P4	●●	●●	●●	●●	●●	●●
	C > 0.55 %	tempered	300 1013	P5	●●	●●	●●	●●	●●	●●
	free cutting steel (short-chipping)	annealed	220 745	P6	●●	●●	●●	●●	●●	●●
P Low-alloyed steel	annealed	175 591	P7	●●	●●	●●	●●	●●	●●	●●
	tempered	300 1013	P8	●●	●●	●●	●●	●●	●●	●●
	tempered	380 1282	P9	●●	●●	●●	●●	●●	●●	●●
	tempered	430 1477	P10	●●	●●	●●	●●	●●	●●	●●
High-alloyed steel and high-alloyed tool steel	annealed	200 675	P11	●●	●●	●●	●●	●●	●●	●●
	hardened and tempered	300 1013	P12	●●	●●	●●	●●	●●	●●	●●
	hardened and tempered	400 1361	P13	●●	●●	●●	●●	●●	●●	●●
Stainless steel	ferritic / martensitic, annealed	200 675	P14	●●	●●	●●	●●	●●	●●	●●
	martensitic, tempered	330 1114	P15	●●	●●	●●	●●	●●	●●	●●
	austenitic, quench hardened	200 675	M1	●●	●●	●●	●●	●●	●●	●●
M Stainless steel	austenitic, precipitation hardened (PH)	300 1013	M2	●●	●●	●●	●●	●●	●●	●●
	austenitic / ferritic, duplex	230 778	M3	●●	●●	●●	●●	●●	●●	●●
	ferritic	200 675	K1	●●	●●	●●	●●	●●	●●	●●
K Malleable cast iron	pearlitic	280 867	K2	●●	●●	●●	●●	●●	●●	●●
	low tensile strength	180 602	K3	●●	●●	●●	●●	●●	●●	●●
	high tensile strength / austenitic	245 825	K4	●●	●●	●●	●●	●●	●●	●●
	ferritic	195 518	K5	●●	●●	●●	●●	●●	●●	●●
Cast iron with spheroidal graphite (GGV)	ferritic	195 518	K5	●●	●●	●●	●●	●●	●●	●●
	pearlitic	275 892	K6	●●	●●	●●	●●	●●	●●	●●

Positive basic shape CCGT / CCMT

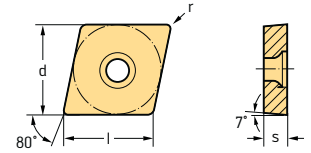

Indexable inserts

Designation	d mm	l mm	s mm	r mm	P					M			K			N		S			H			
					HC					HC			HC			HC	HW	HC			BL	BH	HC	
					WPP01	WPP10	WPP20	WPP30	WTP35	WSM10	WSM20	WSM30	WAK10	WAK15	WAK20	WXN10	WK1	WSM10	WSM20	WSM30	WCB30	WCB50	WXM15	
CCGT060202-X5	6,35	6,45	2,38	0,2																				
	CCGT060204-X5	6,35	6,45	2,38	0,4																			
CCGT060202-X15	6,35	6,45	2,38	0,2																				
	CCGT060204-X15	6,35	6,45	2,38	0,4																			
CCGT060201-PF2	6,35	6,45	2,38	0,1																				
	CCGT060202-PF2	6,35	6,45	2,38	0,2																			
	CCGT060204-PF2	6,35	6,45	2,38	0,4																			
	CCGT09T301-PF2	9,525	9,67	3,97	0,1																			
	CCGT09T302-PF2	9,525	9,67	3,97	0,2																			
	CCGT09T304-PF2	9,525	9,67	3,97	0,4																			
	CCGT09T308-PF2	9,525	9,67	3,97	0,8																			
	CCGT060202-PF5	6,35	6,45	2,38	0,2																			
CCGT060204-PF5		6,35	6,45	2,38	0,4																			
CCGT09T302-PF5		9,525	9,67	3,97	0,2																			
CCGT09T304-PF5		9,525	9,67	3,97	0,4																			
CCMT060202-PF4	6,35	6,45	2,38	0,2																				
	CCMT060204-PF4	6,35	6,45	2,38	0,4																			
	CCMT060208-PF4	6,35	6,45	2,38	0,8																			
	CCMT09T302-PF4	9,525	9,67	3,97	0,2																			
	CCMT09T304-PF4	9,525	9,67	3,97	0,4																			
	CCMT09T308-PF4	9,525	9,67	3,97	0,8																			
	CCMT120404-PF4	12,7	12,9	4,76	0,4																			
	CCMT120408-PF4	12,7	12,9	4,76	0,8																			
CCGT060201-PM2	6,35	6,45	2,38	0,1																				
	CCGT060202-PM2	6,35	6,45	2,38	0,2																			
	CCGT060204-PM2	6,35	6,45	2,38	0,4																			
	CCGT09T301-PM2	9,525	9,67	3,97	0,1																			
	CCGT09T302-PM2	9,525	9,67	3,97	0,2																			
	CCGT09T304-PM2	9,525	9,67	3,97	0,4																			
	CCGT09T308-PM2	9,525	9,67	3,97	0,8																			
	CCGT120402-PM2	12,7	12,9	4,76	0,2																			
	CCGT120404-PM2	12,7	12,9	4,76	0,4																			
	CCGT120408-PM2	12,7	12,9	4,76	0,8																			
CCMT060204-PF	6,35	6,45	2,38	0,4																				
	CCMT060208-PF	6,35	6,45	2,38	0,8																			
	CCMT09T304-PF	9,525	9,67	3,97	0,4																			
	CCMT09T308-PF	9,525	9,67	3,97	0,8																			

HC = Coated carbide
 HW = Uncoated carbide
 BL = CBN with low CBN content
 BH = CBN with high CBN content

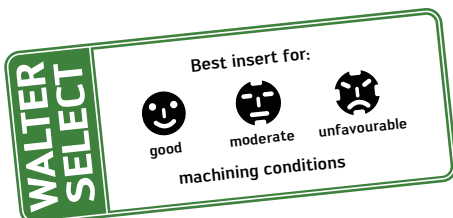

Positive basic shape CCMW

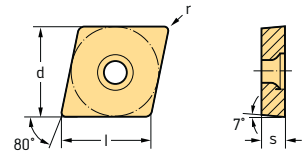

Indexable inserts

Designation	d mm	l mm	s mm	r mm	P					M			K			N		S			BL	BH	HC		
					WPP01	WPP10	WPP20	WPP30	WTP35	WSM10	WSM20	WSM30	WAK10	WAK15	WAK20	WXN10	WK1	WSM10	WSM20	WSM30	WCB30	WCB50	WXM15		
	CCMW060204	6,35	6,45	2,38	0,4																				
	CCMW060208	6,35	6,45	2,38	0,8																				
	CCMW09T304	9,525	9,67	3,97	0,4																				
	CCMW09T308	9,525	9,67	3,97	0,8																				
	CCMW060204-2	6,35	6,45	2,38	0,4																				
	CCMW060208-2	6,35	6,45	2,38	0,8																				
	CCMW09T304-2	9,525	9,67	3,97	0,4																				
	CCMW09T308-2	9,525	9,67	3,97	0,8																				

HC = Coated carbide
 HW = Uncoated carbide
 BL = CBN with low CBN content
 BH = CBN with high CBN content

Positive basic shape CPGT

Tiger-tec®

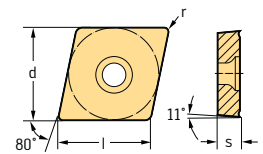

Indexable inserts

Designation	d mm	l mm	s mm	r mm	P					M			K			N		S			HC		
					WPP01	WPP10	WPP20	WPP30	WTP35	WSM10	WSM20	WSM30	WAK10	WAK15	WAK20	WXN10	WK1	WSM10	WSM20	WSM30	WXM15		
	CPGT050202-PF5	5,56	5,65	2,38	0,2																		
	CPGT050202-X5	5,56	5,65	2,38	0,2																		
	CPGT050204-X5	5,56	5,65	2,38	0,4																		
	CPGT050202-X15	5,56	5,65	2,38	0,2																		
	CPGT050204-X15	5,56	5,65	2,38	0,4																		

HC = Coated carbide
 HW = Uncoated carbide

Positive basic shape WCMT / WCGT

Tiger-tec®

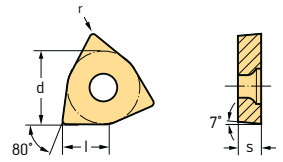

Indexable inserts

Designation	d mm	l mm	s mm	r mm	P					M			K		N		S			H			
					HC					HC			HC	HC	HC	HC	HC	BH	HC				
					WPP01	WPP10	WPP20	WPP30	WTP35	WSM10	WSM20	WSM21	WSM30	WAK10	WAK15	WAK20	WXN10	WK1	WSM10	WSM20	WSM30	WCB50	WXM15
	WCGT020102-X5	3,97	2,7	1,59	0,2																		
	WCGT020104-X5	3,97	2,7	1,59	0,4																		
	WCGT030202-X5	5,56	3,8	2,38	0,2																		
	WCGT030204-X5	5,56	3,8	2,38	0,4																		
	WCGT040202-X5	6,35	4,3	2,38	0,2																		
	WCGT040204-X5	6,35	4,3	2,38	0,4																		
	WCGT050304-X5	7,94	5,43	3,18	0,4																		
	WCGT020102-X15	3,97	2,7	1,59	0,2																		
	WCGT020104-X15	3,97	2,7	1,59	0,4																		
	WCGT030202-X15	5,56	3,8	2,38	0,2																		
	WCGT030204-X15	5,56	3,8	2,38	0,4																		
	WCGT040202-X15	6,35	4,3	2,38	0,2																		
	WCGT040204-X15	6,35	4,3	2,38	0,4																		
	WCGT050304-X15	7,94	5,43	3,18	0,4																		
	WCGT020102-X25	3,97	2,7	1,59	0,2																		
	WCGT030202-X25	5,56	3,8	2,38	0,2																		
	WCGT030204-X25	5,56	3,8	2,38	0,4																		
	WCGT040204-X25	6,35	4,3	2,38	0,4																		
	WCGT050304-X25	7,94	5,43	3,18	0,4																		
	WCGT030201-PF2	5,56	3,8	2,38	0,1																		
	WCGT030202-PF2	5,56	3,8	2,38	0,2																		
	WCGT030204-PF2	5,56	3,8	2,38	0,4																		
	WCGT040201-PF2	6,35	4,3	2,38	0,1																		
	WCGT040202-PF2	6,35	4,3	2,38	0,2																		
	WCGT040204-PF2	6,35	4,3	2,38	0,4																		
	WCGT06T301-PF2	9,525	6,5	3,97	0,1																		
	WCGT06T302-PF2	9,525	6,5	3,97	0,2																		
	WCGT06T304-PF2	9,525	6,5	3,97	0,4																		
WCGT06T308-PF2	9,525	6,5	3,97	0,8																			
	WCMT040202-PF4	6,35	4,3	2,38	0,2																		
	WCMT040204-PF4	6,35	4,3	2,38	0,4																		
	WCMT040208-PF4	6,35	4,3	2,38	0,8																		
	WCMT06T302-PF4	9,525	6,5	3,97	0,2																		
	WCMT06T304-PF4	9,525	6,5	3,97	0,4																		
	WCMT06T308-PF4	9,525	6,5	3,97	0,8																		
	WCMT080404-PF4	12,7	8,7	4,76	0,4																		
	WCMT080408-PF4	12,7	8,7	4,76	0,8																		

HC = Coated carbide
 HW = Uncoated carbide
 BH = CBN with high CBN content

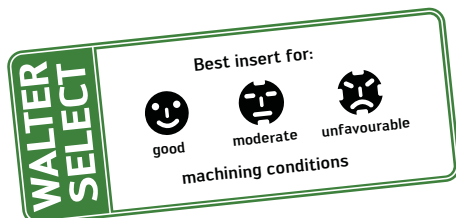

Positive basic shape
 WCGT / WCMW

Tiger-tec®

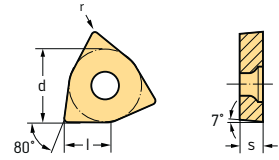

Indexable inserts

Designation	d mm	l mm	s mm	r mm	P					M			K			N		S			H			
					HC					HC			HC			HC	HW	HC			BH	HC		
					WPP01	WPP10	WPP20	WPP30	WTP35	WSM10	WSM20	WSM21	WSM30	WAK10	WAK15	WAK20	WXN10	WK1	WSM10	WSM20	WSM30	WCB50	WXM15	
	WCGT030202-PM2	5,56	3,8	2,38	0,2													☺	☺					
	WCGT030204-PM2	5,56	3,8	2,38	0,4													☺	☺					
	WCGT040202-PM2	6,35	4,3	2,38	0,2													☺	☺					
	WCGT040204-PM2	6,35	4,3	2,38	0,4													☺	☺					
	WCGT06T302-PM2	9,525	6,5	3,97	0,2													☺	☺					
	WCGT06T304-PM2	9,525	6,5	3,97	0,4													☺	☺					
	WCGT080404-PM2	12,7	8,7	4,76	0,4													☺	☺					
	WCGT080408-PM2	12,7	8,7	4,76	0,8													☺	☺					
	WCMW020102	3,97	2,7	1,59	0,2																		☺	
	WCMW020104	3,97	2,7	1,59	0,4																		☺	
	WCMW030202	5,56	3,8	2,38	0,2																		☺	
	WCMW030204	5,56	3,8	2,38	0,4																		☺	
	WCMW040202	6,35	4,3	2,38	0,2																		☺	
	WCMW040204	6,35	4,3	2,38	0,4																		☺	
	WCMW050304	7,94	5,43	3,18	0,4																		☺	

HC = Coated carbide

HW = Uncoated carbide

BH = CBN with high CBN content

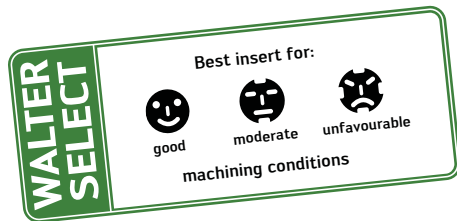

Walter Select for indexable inserts for reaming

Step by step to the right indexable insert

STEP 1





Determine the **material** to be machined, see page H 8 onwards.

Note the machining group that corresponds to your material e.g.: P10.

Identification letters	Machining group	Groups of the materials to be machined	
P	P1–P15	Steel	All types of steel and cast steel, with the exception of steel with an austenitic structure
M	M1–M3	Stainless steel	Stainless austenitic steel and austenitic-ferritic steel and cast steel
K	K1–K7	Cast iron	Grey cast iron, cast iron with spheroidal graphite, malleable cast iron, cast iron with vermicular graphite
N	N1–N10	NF metals	Aluminium and other non-ferrous metals, non-ferrous materials
S	S1–S10	High temperature alloys and titanium alloys	Heat resisting special alloys based on iron, nickel and cobalt, titanium and titanium alloys
H	H1–H4	Hard materials	Hardened steel, hardened cast iron materials, chilled cast iron
O	O1–O6	Other	Plastics, fibre glass and carbon fibre reinforced plastics, graphite

STEP 2

Select the **hole type / chamfer**:

Type of hole	Recommended cutting geometry (lead angles)		
		Blind hole	Through hole
Smooth cut		E1 / E5	E1
Slightly interrupted > 30 %		E5	E1
Extended tool projection		E5	E5

STEP 3

Determine the **cutting material** by means of the indexable insert geometry and the machining conditions:

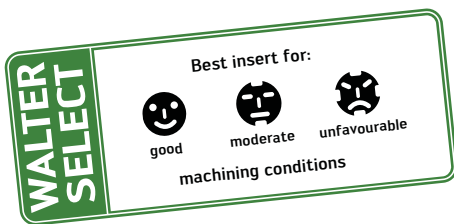

Identification letters	Machining group	Walter Insert geometry	Machining conditions		
			☺	☹	☹☹
P	P1–P15	B 88	WCE 10	WCE 10	—
		B 88	WXK 05	WXK 05	WXK 05
M	M1–M3	B 88	WK 10	WK 10	WK 10
		B 88	WXK 05	WXK 05	WXK 05
K	K1–K4 K7	A 88	WXP 15	WXP 15	WXP 15
		B 88	WXK 05	WXK 05	WXK 05
	K6	B 88	WCE 10	WCE 10	—
		B 88	WXK 05	WXK 05	WXK 05
N	N1–N10	B 88	WK 10	WK 10	WK 10
S	S1–S10	B 88	WXK 05	WXK 05	WXK 05
H	01–06	B 88	WXK 05	WXK 05	WXK 05

STEP 4

Select the **cutting data**, see page C 166 onwards.

Material group	Structure of main material groups and identification letters	Bore hardness HB	Tensile strength F_{m1} [N/mm ²]	Machining group ¹	Reaming oversize in θ [mm]	
					< 9	> 9
P	Unalloyed steel	C ≤ 0.25% annealed	125 428	P1 ●●	0.1-0.2	0.2-0.3
		C > 0.25 ≤ 0.55% annealed	190 639	P2 ●●	0.1-0.2	0.2-0.3
		C > 0.25 ≤ 0.55% tempered	210 708	P3 ●●	0.1-0.2	0.2-0.3
		C > 0.55% annealed	190 639	P4 ●●	0.1-0.2	0.2-0.3
		C > 0.55% tempered	300 1013	P5 ●●	0.1-0.2	0.2-0.3
	Low-alloyed steel	free cutting steel (short-chipping) annealed	220 745	P6 ●●	0.1-0.2	0.2-0.3
		annealed	175 591	P7 ●●	0.1-0.2	0.2-0.3
		tempered	300 1013	P8 ●●	0.1-0.2	0.2-0.3
		tempered	380 1282	P9 ●●	0.1-0.2	0.2-0.3
		tempered	430 1477	P10 ●●	0.1-0.2	0.2-0.3
High-alloyed steel and high-alloyed tool steel	annealed	200 675	P11 ●●	0.1-0.2	0.2-0.3	
	hardened and tempered	300 1013	P12 ●●	0.1-0.2	0.2-0.3	
	hardened and tempered	400 1361	P13 ●●	0.1-0.2	0.2-0.3	
Stainless steel	ferritic / martensitic, annealed	200 675	P14 ●●	0.1-0.2	0.2-0.3	
	martensitic, tempered	330 1114	P15 ●●	0.1-0.2	0.2-0.3	
	austenitic, quench hardened	200 675	M1 ●●	0.10	0.1-0.2	
M	Stainless steel	austenitic, precipitation hardened (PH)	300 1013	M2 ●●	0.10	0.1-0.2
		austenitic / ferritic, duplex	230 778	M3 ●●	0.10	0.1-0.2
		ferritic	200 675	K1 ●●	0.2-0.3	0.3-0.5
K	Malleable cast iron	pearlitic	280 867	K2 ●●	0.2-0.3	0.3-0.5
		Grey cast iron	180			

Positive basic shape P 6500

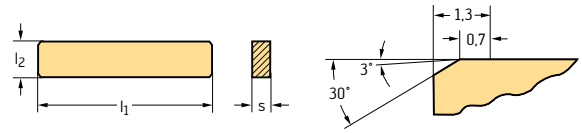

Indexable inserts

Designation	Number of cutting edges	l ₁ x l ₂ mm	s mm	Rake angle	Chamfer	P		M		K		N	S	H	
						HC	HT	HC	HW	HC	HT	HC	HW	HC	HC
						WXX05	WCE10	WXP15	WK10	WXX05	WCE10	WXP15	WK10	WXX05	WXX05
 P6500-00R-A88-E1 P6500-0R-A88-E1 P6500-1R-A88-E1 P6500-2R-A88-E1 P6500-4R-A88-E1	1	11 X 1,5	1	0°	E1										
	2	20 X 2,5	1,2	0°	E1										
	2	20 X 3,0	1,5	0°	E1										
	2	20 X 4,5	2	0°	E1										
	2	25 X 7,0	2,3	0°	E1										
 P6500-00R-B88-E1 P6500-0R-B88-E1 P6500-1R-B88-E1 P6500-2R-B88-E1 P6500-4R-B88-E1	1	11 X 1,5	1	6°	E1										
	2	20 X 2,5	1,2	6°	E1										
	2	20 X 3,0	1,5	6°	E1										
	2	20 X 4,5	2	6°	E1										
	2	25 X 7,0	2,3	6°	E1										
 P6500-00R-B88-E5 P6500-0R-B88-E5 P6500-1R-B88-E5 P6500-2R-B88-E5 P6500-4R-B88-E5	1	11 X 1,5	1	6°	E5										
	2	20 X 2,5	1,2	6°	E5										
	2	20 X 3,0	1,5	6°	E5										
	2	20 X 4,5	2	6°	E5										
	2	25 X 7,0	2,3	6°	E5										

HC = Coated carbide
HT = Cermet
HW = Uncoated carbide

WALTER SELECT

Best insert for:

good

moderate

unfavourable

machining conditions

Product range overview of drilling and boring tools with indexable inserts

Drilling

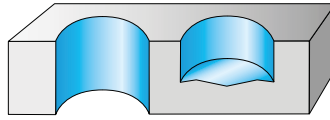

For Walter Select, see page C 46

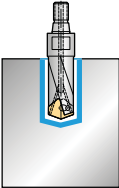
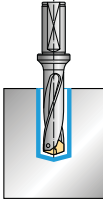
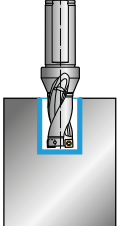
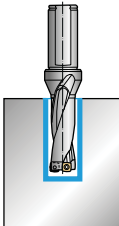
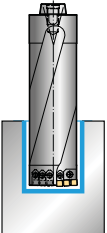
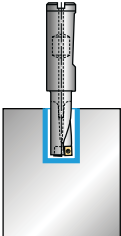
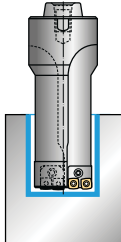
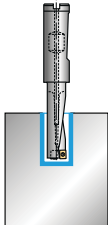
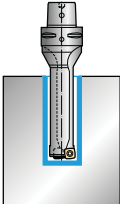
$L_c = 1,3 \times D_c$		$L_c = 2 \times D_c$		$L_c = 3 \times D_c$	
$D_c = 12-25 \text{ mm}$ Xtra-tec® B 4011 Page C 50 				$D_c = 12-38 \text{ mm}$ Xtra-tec® B 4013 Page C 62 	
		$D_c = 13,5-59 \text{ mm}$ Xtra-tec® B 4212 Page C 52 		$D_c = 13,5-59 \text{ mm}$ Xtra-tec® B 4213 Page C 64 	
				$D_c = 59-120 \text{ mm}$ Xtra-tec® B 4213.N Page C 68 	
$D_c = 10-18 \text{ mm}$ B 3212 Page C 56 		$D_c = 59,8-120 \text{ mm}$ B 3011M Page C 58 		$D_c = 10-18 \text{ mm}$ B 3213 Page C 70 	
				$D_c = 16-58 \text{ mm}$ B 3213 Page C 72 	

Drilling

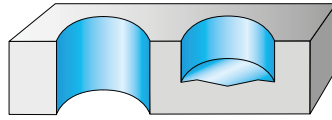

For Walter Select, see page C 46

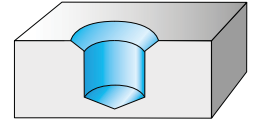

For Walter Select, see page C 46

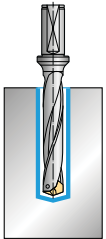
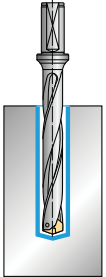
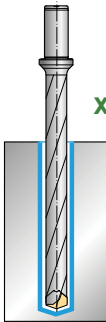
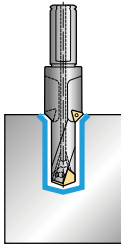
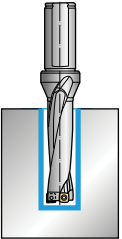
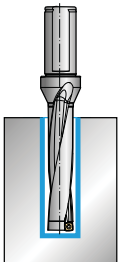
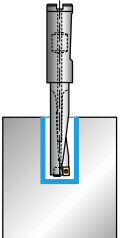
	$L_c = 4 \times D_c$	$L_c = 5 \times D_c$	$L_c = 7 \times D_c$	$L_c = 10 \times D_c$	$L_c = 2 \times D_c$
		$D_c = 12-38 \text{ mm}$	$D_c = 12-32 \text{ mm}$	$D_c = 18-25 \text{ mm}$	$D_c = 12-29 \text{ mm}$
		Xtra-tec® B 4015 Page C 80 	Xtra-tec® B 4017 Page C 86 	B 4010 Page C 88 Xtra-tec® 	Xtra-tec® B 4012C Page C 60 
	$D_c = 17-59 \text{ mm}$	$D_c = 17-59 \text{ mm}$			
	Xtra-tec® B 4214 Page C 74 	Xtra-tec® B 4215 Page C 82 			
	$D_c = 16-58 \text{ mm}$				
	B 3214 Page C 78 				

Overview of boring and precision boring tools

Boring & counterboring	Precision boring, analogue	Precision boring, digital
	<p>Walter Precision^{MINI} Ø 2–45 mm</p>  <ul style="list-style-type: none"> – 2 versions: unbalanced and self-balancing – v_c possible up to 2,000 m/min – Successful NCT modular system and ScrewFit screw head system – Modular design, see page C 40 – Insert holder for W . . . indexable inserts 	<p>Walter Precision^{DIGITAL} Ø 3–32 mm</p>  <ul style="list-style-type: none"> – Precision boring head with electronic encoder – Adjustment by digital display with a diameter accuracy of 2 µm – Automatic balance compensation – Modularity by means of proven ScrewFit screw head system – Toolholder and boring bars made from steel or solid carbide
<p>Walter Boring^{MEDIUM} Ø 20–153 mm</p>  <ul style="list-style-type: none"> – Proven NCT modular system and new ScrewFit screw head system – Cartridges for W . . . and C . . . indexable inserts – Steel tool body – Tool lengths correspond to Walter Precision^{MEDIUM} 	<p>Walter Precision^{MEDIUM} Ø 20–153 mm</p>  <ul style="list-style-type: none"> – 2 versions: unbalanced and self-balancing – v_c possible up to 2,000 m/min – Proven NCT modular system and new ScrewFit screw head system – Cartridges for W . . . and C . . . indexable inserts – Body in steel and aluminium 	<p>Walter Precision^{DIGITAL} Ø 32–68 mm</p>  <ul style="list-style-type: none"> – Precision boring head with electronic encoder – Adjustment by digital display with accuracy of 2 µm – Automatic balance compensation – Modularity by means of proven ScrewFit screw head system – Maximum flexibility due to boring bars in a variety of different lengths
<p>Walter Boring^{MAXI} Ø 150–640 mm</p>  <ul style="list-style-type: none"> – Modular design with bridges – Interface: NCT 80 – Cartridges for C . . . indexable inserts – Tool lengths correspond to Walter Precision^{MAXI} 	<p>Walter Precision^{MAXI} Ø 150–640 mm</p>  <ul style="list-style-type: none"> – Modular design with bridges – Interface: NCT 80 – Cartridges for C . . . and W . . . indexable inserts 	<p>Walter Precision^{DIGITAL} Ø 68–124 mm</p>  <ul style="list-style-type: none"> – Precision boring head with electronic encoder – Adjustment by digital display with accuracy of 2 µm – Automatic balance compensation – Modular design with bridges

Product range overview of boring and precision boring tools and reaming tools

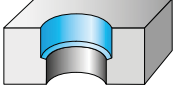
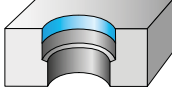
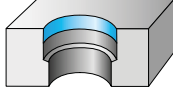
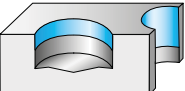
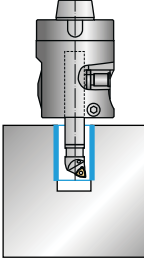
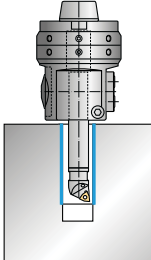
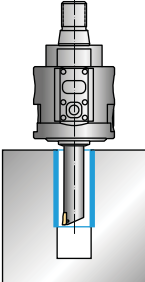
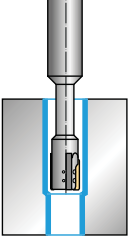
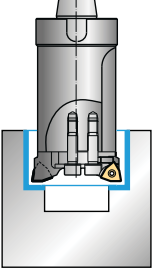
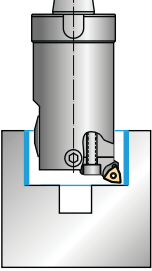
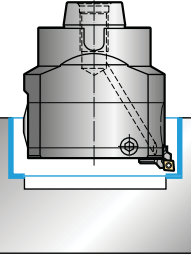
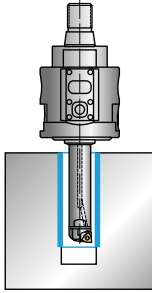
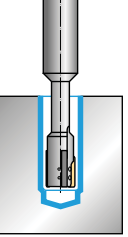
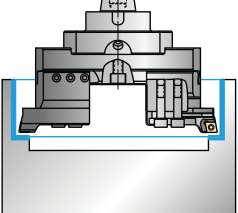
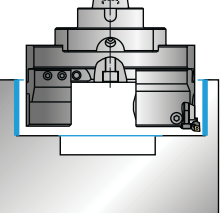
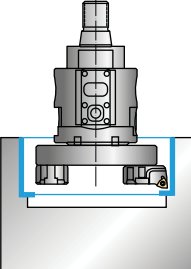
Boring & counterboring	Precision boring, analogue		Precision boring, digital	Reaming
 <p>Walter Boring twin lip boring tools</p> <p>For Walter Select, see page C 90</p>	 <p>Walter Precision boring tools</p> <p>For Walter Select, see page C 90</p>		 <p>Walter Precision^{DIGITAL} precision boring tools</p> <p>For Walter Select, see page C 90</p>	 <p>Walter reaming tools</p> <p>For Walter Select, see page C 90</p>
<p>$D_c = 2-45 \text{ mm}$</p> <p>Walter Precision^{MINI} B 3230 Page C 100</p> 	<p>$D_c = 5,8-45,5 \text{ mm}$</p> <p>Walter Precision^{MINI} B 4030 Page C 100</p> 	<p>$D_c = 3-20 \text{ mm}$</p> <p>Walter Precision^{DIGITAL} B 4035 Page C 118</p> 	<p>$D_c = 6-25 \text{ mm}$</p> <p>R 4060 Page C 122</p> 	
<p>$D_c = 20-153 \text{ mm}$</p> <p>Walter Boring^{MEDIUM} B 3220 B 3221 Page C 92</p> 	<p>$D_c = 20-153 \text{ mm}$</p> <p>Walter Precision^{MEDIUM} B 3230 Page C 108</p> 	<p>$D_c = 33-153 \text{ mm}$</p> <p>Walter Precision^{MEDIUM} B 4030 Page C 110</p> 	<p>$D_c = 20-68 \text{ mm}$</p> <p>Walter Precision^{DIGITAL} B 4035 Page C 120</p> 	<p>$D_c = 8-25 \text{ mm}$</p> <p>R 4061 Page C 124</p> 
<p>$D_c = 150-640 \text{ mm}$</p> <p>Walter Boring^{MAXI} B 3220 Page C 96</p> <p>B 3224 Page C 98</p> 	<p>$D_c = 150-640 \text{ mm}$</p> <p>Walter Precision^{MAXI} B 3230 Page C 112</p> <p>B 3234 Page C 114</p> 		<p>$D_c = 68-124 \text{ mm}$</p> <p>Walter Precision^{DIGITAL} B 4035 Page C 120</p> 	

Modularity of the Walter Precision^{MINI} system B 3230 and B 4030

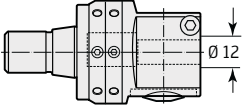
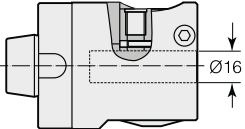
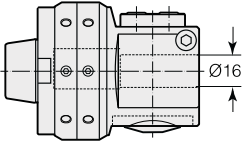
	Reductions	Extensions	Insert holders	Dia. range [mm]	Page	
ScrewFit   B 4030G.T45.02-20.Z1 Balanceable	EB 501		EB 301 ... EB 302 ...	2,0-3,5 3,0-6,0	C 100	
	EB 502	EB 303 ...		5,8-7,5		
	EB 503	EB 304 ...		7,3-9,5		
	EB 504	EB 106 EB 107.CS		EB 305 ...	8,8-12,5	C 102
	EB 505	EB 108 EB 109.CS		EB 306 ...	11,8-14,5	
		EB 508		EB 307 ...	13,8-16,5	
		EB 509.CS		EB 512 ...	15,8-20,0	
	NCT  B 3230G.N6.002-045.Z1 Standard  B 4030G.N6.02-45.Z1 Balanceable	EB 101		EB 301 ... EB 302 ...	2,0-3,5 3,0-6,0	C 100
		EB 102	EB 303 ...		5,8-7,5*	
EB 103		EB 304 ...		7,3-9,5*		
EB 104		EB 106 EB 107.CS		EB 305 ...	8,8-12,5*	C 102
EB 105		EB 108 EB 109.CS		EB 306 ...	11,8-14,5*	
EB 506		EB 508 EB 509.CS		EB 307 ...	13,8-16,5*	
EB 507		EB 510 EB 511.CS		EB 512 ...	15,8-20,0	
		EB 110 EB 111.CS EB 112.CS		EB 308 EB 309 EB 310 EB 311 EB 312 EB 313 EB 314	17,8-22,5 21,8-25,5 24,8-28,5 27,8-32,5 31,8-36,5 35,8-40,5 39,8-45,5	C 104

EB . . CS = solid carbide shank

* For alternative, one-piece boring bars, see page C 106.

Modularity of the Walter Precision^{DIGITAL} system B 4035

		Dia. range [mm]	Page	
 B 4035 Basic Set	 Intermediate piece EB 601	 One-piece HM cutting edges EB 603-EB 610	3-9 (D _c opt. = 3-15 mm)	C 118
		 Boring bars EB 611-EB 620	10-20 (D _c opt. = 10-26 mm)	C 118
		 Carbide boring bars EB 637-EB 641	10-20	C 118
	 Extension EB 642	 Cartridges EB 624-EB 644	20-32 (D _c opt. = 20-32 mm)	C 120
	 Extension EB 643.CS			
	 Extension EB 625-EB628	 Cartridges EB 629-EB 630	32-68	C 120
	 Bridge EB 631	 Counterweight EB 635	68-96	C 120
 Coolant transfer piece EB 636	 Bridge EB 632			
	 Bridge EB 632	 Counterweight EB 635	96-124	C 120

System overview of ScrewFit for boring, drilling and circular interpolation milling

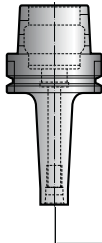
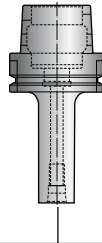
AK 530
Page G 71

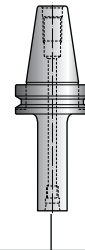
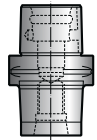
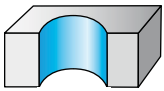
AK 531
Page G 73

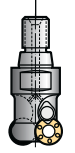
AK 540
Page G 74

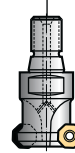
AK 541
Page G 76

AK 580
Page G 80

Drilling / Circular interpolation milling

B 4011
Page C 50
Xtra-tec®

F 4030
Page F 116
Xtra-tec®

F 2231
Page F 216

F 2234
Page F 218

F 4080
Page F 130
Xtra-tec®

F 4081
Page F 244
Xtra-tec®

F 2330
Page F 114

F 2334
Page F 222

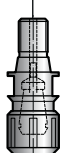
F 3040
Page F 140

F 4042
Page F 144
Xtra-tec®

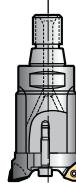
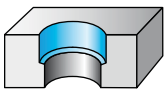
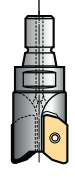
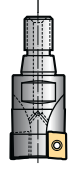
AK 300 T
Page G 60

Boring & counterboring

B 322 .
Page C 92 / C 94
Walter Boring^{MEDIUM}

F 3040
Page F 140

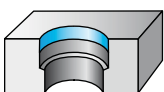
F 4042
Page F 144
Xtra-tec®

F 4031
Page F 232
Xtra-tec®

F 4081
Page F 244
Xtra-tec®

 Solid carbide
and HSS drills
see page
B 4

Precision boring

B 4030*
Page C 100–C 102
Walter Precision^{MINI}

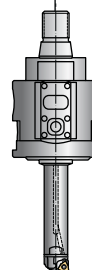
B 3230*
Page C 108
Walter Precision^{MEDIUM}

B 4030*
Page C 110

B 4035*
Page C 116
Walter Precision^{DIGITAL}

* Only in combination with AK 53 . CO and AK 54 . CO .
For cutting edge orientation for ScrewFit
precision boring tools, see page C 192.

ScrewFit system overview for milling



AK 500
Page G 67



AK 510
Page G 68



AK 520
Page G 69

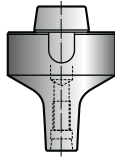

AK 521
Page G 70



AK 522
Page G 70

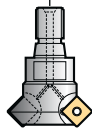

F 22321¹
Page F 238



F 4080
Page F 130
Xtra-tec®



F 2330
Page F 114
(face and plunge mill)

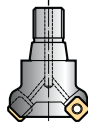

F 4033
Page F 118
Xtra-tec®



F 4047
Page F 126
Xtra-tec®



F 4048
Page F 128
Xtra-tec®



F 4030
Page F 116
Xtra-tec®

Face milling

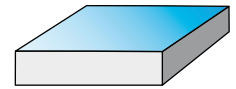

AK 300 T
Page G 60



F 2241
Page F 138



F 3040
Page F 140



F 4.38
Page F 162
Xtra-tec®

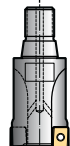

F 4041
Page F 142
Xtra-tec®



F 4042
Page F 144
Xtra-tec®



F 4042R
Page F 148
Xtra-tec®

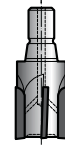

F 4722
Page E 52

Shoulder / slot milling

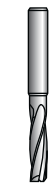
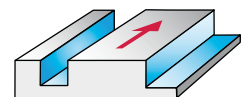

Solid carbide
and HSS mills
see page
E 4



F 2139
Page F 214



F 2231
Page F 216



F 2234
Page F 218



F 2239
Page F 226



F 2339
Page F 228

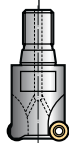

F 2334
Page F 222



F 4031
Page F 232
Xtra-tec®

Copy milling

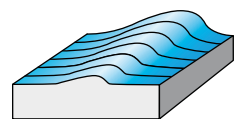

¹ For chamfering 45°

Designation key for drills

B	421	2	F	25	24	Z1	048	R-3
1	2	3	4	5	6	7	8	9

1	
Tool range	
B	Drilling and boring tools

2	
Tool type	
321	Stardrill
401	Xtra-tec® Point Drill
421	Xtra-tec® Insert Drill

3	
Drilling depth (L/D ratio)	
1	1 x D
2	2 x D
3	3 x D
4	4 x D
5	5 x D
7	7 x D
0	10 x D

4	
Interface	
F	Cylindrical shank with clamping surface
N	Walter NCT
DF	Combination shank DIN 1835 B and DIN 6535 HE
C	Capto
T	ScrewFit

5
Interface size

6
Tool diameter

7
Number of teeth

8
Maximum drilling depth

9	
Cutting direction and insert size	
R	Right-hand
-3	Insert size 3

Designation key for boring and precision boring tools

B	4030	T	45	55-70	Z1	CC06
1	2	3	4	5	6	7

1	
Tool range	
B	Drilling and boring tools

2	
Tool type	
3220	Walter Boring
3221	Walter Boring
3224	Walter Boring
3230	Walter Precision
3234	Walter Precision
4030	Walter Precision, can be balanced, self-balancing
4035	Walter Precision digital

3	
Interface	
N	Walter NCT
T	Walter ScrewFit





4	
Interface size	

5	
Diameter range	

6	
Number of teeth	

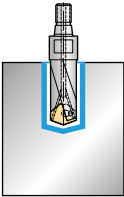
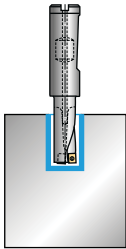
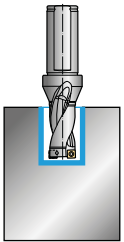
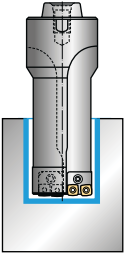
7	
Insert type and size	

Walter Select – Drilling



Tool type					
L_c approx.	$1,3 \times D_c$		$2 \times D_c$		
	B 4011 (R)	B 3212 (R)	B 4212 (R)	B 3011.M (R)	
Drills (R) = r.h. cutting					
	Xtra-tec®		Xtra-tec®		
Dia. range [mm]	12–25	10–18	13,5–59	59,5–120	
Page	C 50	C 56	C 52	C 58	
P Steel	●●	●●	●●	●●	
M Stainless steel	●●	●●	●●	●	
K Cast iron	●●	●●	●●	●●	
N NF metals	●●	●	●	●	
S Difficult-to-machine materials	●●	●●	●●	●	
H Hard materials					
O Other					
Basic insert shape					
Insert types	P 600 ..	LCMX ..	P 484 ..	P 284 ..	
Drilling depth [mm]	$\leq 1,3 \times D_c$	$\leq 2 \times D_c$	$\leq 2 \times D_c$	$\leq 2 \times D_c$	

	2,5 x D _c	3 x D _c			
	B 4012C (R)	B 4013 (R)	B 3213 (R)	B 4213 (R)	B 4213.N
	Xtra-tec®	Xtra-tec®		Xtra-tec®	Xtra-tec®
	12-29	12-37	10-18	13,5-59	59,5-120
	C 60	C 62	C 70	C 64	C 68
	••	••	••	••	••
	••	••	••	••	•
	••	••	••	••	••
	••	••	•	•	•
	••	••	••	••	•
	P 600 .. TC ..	P 600 ..	LCMX ..	P 484 ..	P 484 ..
	≤ 2,5 x D _c	≤ 3 x D _c	≤ 3 x D _c	≤ 3 x D _c	≤ 3 x D _c

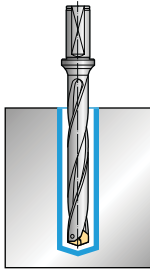
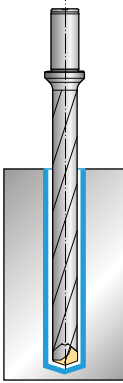
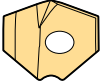

Walter Select – Drilling

Tool type					
L_c approx.	$4 \times D_c$		$5 \times D_c$		
Drills (R) = r.h. cutting	B 3214 (R)	B 4214 (R)	B 4015 (R)	B 4215 (R)	
Dia. range [mm]	10–18	17–59	12–37	17–59	
Page	C 78	C 74	C 80	C 82	
P Steel		••	••	••	
M Stainless steel		•	••		
K Cast iron	••	••	••	••	
N NF metals	•	•	••	•	
S Difficult-to-machine materials		•	•		
H Hard materials					
O Other					
Basic insert shape					
Insert types	LCMX ..	P 484 ..	P 600 ..	P 484 ..	
Drilling depth [mm]	$\leq 4 \times D_c$	$\leq 4 \times D_c$	$\leq 5 \times D_c$	$\leq 5 \times D_c$	

	7 x D _C	10 x D _C
	B 4017 (R)	B 4010 (R)
		
	Xtra-tec®	Xtra-tec®
	12-31	18-24
	C 86	C 88
	••	••
	•	••
	••	••
	•	•
	•	
		
	P 600 ..	P 600 ..
	≤ 7 x D _C	≤ 10 x D _C



Drills B 4011

Xtra-tec® Point Drill

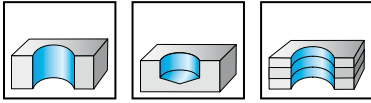

- diameter range 12-25.8 mm
- right-hand cutting
- drilling depth 1.3 x D_c

Tool	Designation	D _c mm	d ₁ mm	d ₄ mm	l ₄ mm	L _c mm	Z	kg	No. of indexable inserts	Type
NCT ScrewFit	B4011.T14.12,0.Z02.15R*	12	T 14	14,5	47,6	18	2	0,36	1	P 600 . - D12 . . R
	B4011.T14.13,0.Z02.17R	13	T 14	14,5	49,9	19	2	0,05	1	P 600 . - D13 . . R
	B4011.T14.14,0.Z02.18R	14	T 14	14,5	52,2	21	2	0,05	1	P 600 . - D14 . . R
	B4011.T18.15,0.Z02.19R	15	T 18	18,5	54,5	22	2	0,08	1	P 600 . - D15 . . R
	B4011.T18.16,0.Z02.21R	16	T 18	18,5	56,8	24	2	0,09	1	P 600 . - D16 . . R
	B4011.T18.17,0.Z02.22R	17	T 18	18,5	59,1	25	2	0,09	1	P 600 . - D17 . . R
	B4011.T18.18,0.Z02.23R	18	T 18	18,5	61,4	27	2	0,09	1	P 600 . - D18 . . R
	B4011.T22.19,0.Z02.24R	19	T 22	22	63,7	28	2	0,12	1	P 600 . - D19 . . R
	B4011.T22.20,0.Z02.26R	20	T 22	22	66	30	2	0,13	1	P 600 . - D20 . . R
	B4011.T22.21,0.Z02.27R	21	T 22	22	68,3	31	2	0,14	1	P 600 . - D21 . . R
	B4011.T22.22,0.Z02.28R	22	T 22	22	71,6	33	2	0,16	1	P 600 . - D22 . . R
	B4011.T28.23,0.Z02.30R	23	T 28	28	73,9	34	2	0,22	1	P 600 . - D23 . . R
	B4011.T28.24,0.Z02.31R	24	T 28	28	76,2	36	2	0,23	1	P 600 . - D24 . . R
	B4011.T28.25,0.Z02.32R	25	T 28	28	78,5	37	2	0,25	1	P 600 . - D25 . . R

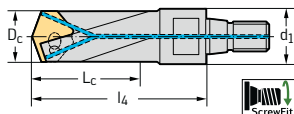

Bodies and assembly parts are included in the scope of delivery.

* Example: inserts with D_c=12.00 mm up to and incl. 12.99 mm can fitted into this tool.

Assembly parts

D _c mm	12-13	14-15	16-17	18-19	20-21	22-23	24-25			
	FS1396 (Torx 7 IP)	FS1397 (Torx 8 IP)	FS1398 (Torx 8 IP)	FS1399 (Torx 15 IP)	FS1400 (Torx 20 IP)	FS1401 (Torx 20 IP)	FS1402 (Torx 20 IP)			
	Clamping screw for insert		Tightening torque		1,2 Nm	2,0 Nm	2,0 Nm	4,0 Nm	5,0 Nm	5,0 Nm

Accessories

D _c mm	12-13	14-17	18-19	20-25
	FS2001	FS2003	FS2003	FS2003
	FS2011 (Torx 7IP)	FS2012 (Torx 8IP)	FS2014 (Torx 15IP)	FS2015 (Torx 20IP)
	FS1490 (Torx 7IP)	FS1483 (Torx 8IP)	FS1485 (Torx 15IP)	FS1486 (Torx 20IP)

Exchangeable inserts

Designation	Diameter range	P		M		K			N		S		H	
		HC		HC		HC			HC		HC			
		WMP35	WXP45	WKP25	WKP35	WSP45	WMP35	WSP45	WKK25	WKP25	WKP35	WNN25	WMP35	WSP45
P6001-D ..	12-25,8		☒											
P6002-D ..	12-25,8							☒						
P6003-D ..	12-25,8	☒				☒						☒		
P6004-D ..	12-25,8										☒			

HC = Coated carbide

WALTER SELECT

Best insert for:

good

moderate

unfavourable

machining conditions

Drills B 4212

Xtra-tec® Insert Drill

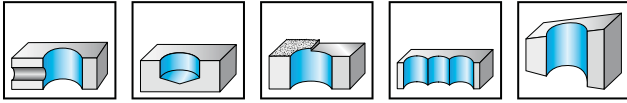

- diameter range 13.5-59 mm
- right-hand cutting
- drilling depth $2 \times D_c$

Tool	Designation	D_c mm	d_1 mm	d_4 mm	l_4 mm	l_5 mm	L_c mm	kg	No. of indexable inserts	Type
Cylindrical shank with flat in acc. with ISO 9766 	B4212.F20.13,5.Z1.027R-1	13,5	20	30	47	50	27	0,17	$\frac{1}{1}$	P484 . P-1R P484 . C-1R
	B4212.F20.14.Z1.028R-1	14	20	30	48	50	28	0,17	$\frac{1}{1}$	
	B4212.F20.14,5.Z1.029R-1	14,5	20	30	49	50	29	0,17	$\frac{1}{1}$	
	B4212.F20.15.Z1.030R-1	15	20	30	50	50	30	0,17	$\frac{1}{1}$	
	B4212.F20.15,5.Z1.031R-1	15,5	20	30	51	50	31	0,18	$\frac{1}{1}$	
	B4212.F25.16.Z1.032R-1	16	25	32	57	56	32	0,32	$\frac{1}{1}$	
	B4212.F25.16,5.Z1.033R-2	16,5	25	32	58	56	33	0,3	$\frac{1}{1}$	
	B4212.F25.17.Z1.034R-2	17	25	32	59	56	34	0,42	$\frac{1}{1}$	
	B4212.F25.17,5.Z1.035R-2	17,5	25	32	60	56	35	0,4	$\frac{1}{1}$	
	B4212.F25.18.Z1.036R-2	18	25	32	61	56	36	0,33	$\frac{1}{1}$	
	B4212.F25.18,5.Z1.037R-2	18,5	25	32	62	56	37	0,45	$\frac{1}{1}$	
	B4212.F25.19.Z1.038R-2	19	25	32	63	56	38	0,34	$\frac{1}{1}$	
	B4212.F25.19,5.Z1.039R-2	19,5	25	32	64	56	39	0,35	$\frac{1}{1}$	
	B4212.F25.20.Z1.040R-2	20	25	32	65	56	40	0,45	$\frac{1}{1}$	
	B4212.F25.20,5.Z1.041R-3	20,5	25	32	66	56	41	0,44	$\frac{1}{1}$	
	B4212.F25.21.Z1.042R-3	21	25	32	67	56	42	0,45	$\frac{1}{1}$	
	B4212.F25.21,5.Z1.043R-3	21,5	25	32	68	56	43	0,37	$\frac{1}{1}$	
	B4212.F25.22.Z1.044R-3	22	25	32	69	56	44	0,37	$\frac{1}{1}$	
	B4212.F25.22,5.Z1.045R-3	22,5	25	32	70	56	45	0,46	$\frac{1}{1}$	P484 . P-3R P484 . C-3R
	B4212.F25.23.Z1.046R-3	23	25	32	71	56	46	0,48	$\frac{1}{1}$	
B4212.F25.23,5.Z1.047R-3	23,5	25	32	72	56	47	0,44	$\frac{1}{1}$		
B4212.F25.24.Z1.048R-3	24	25	32	73	56	48	0,48	$\frac{1}{1}$		
B4212.F25.24,5.Z1.049R-4	24,5	25	32	74	56	49	0,5	$\frac{1}{1}$		
B4212.F25.25.Z1.050R-4	25	25	32	75	56	50	0,4	$\frac{1}{1}$		
B4212.F32.25,5.Z1.051R-4	25,5	32	40	83	60	51	0,8	$\frac{1}{1}$		
B4212.F32.26.Z1.052R-4	26	32	40	84	60	52	0,8	$\frac{1}{1}$		
B4212.F32.26,5.Z1.053R-4	26,5	32	40	85	60	53	0,8	$\frac{1}{1}$		
B4212.F32.27.Z1.054R-4	27	32	40	86	60	54	0,7	$\frac{1}{1}$	P484 . P-4R P484 . C-4R	
B4212.F32.27,5.Z1.055R-4	27,5	32	40	87	60	55	0,8	$\frac{1}{1}$		
B4212.F32.28.Z1.056R-4	28	32	40	88	60	56	0,8	$\frac{1}{1}$		
B4212.F32.28,5.Z1.057R-4	28,5	32	40	89	60	57	0,8	$\frac{1}{1}$		
B4212.F32.29.Z1.058R-4	29	32	40	90	60	58	0,9	$\frac{1}{1}$		

Bodies, assembly parts and screwdrivers are included in the standard pack.

N.B.: where through bores are created by a rotating tool, a disc forms which is ejected. Please implement safety measures.

Assembly parts

D _c mm	13,5-16	16,5-20	20,5-24	24,5-29
Clamping screw for insert Tightening torque	FS2120 (Torx 6IP) 0,4 Nm	FS2111 (Torx 7 IP) 0,9 Nm	FS1454 (Torx 8 IP) 1,2 Nm	FS1457 (Torx 9 IP) 2,0 Nm

Accessories

D _c mm	13,5-20	20,5-24	24,5-29
Torque screwdriver	FS2001	FS2001	FS2003
Interchangeable blade	FS2011 (Torx 7IP)	FS2012 (Torx 8IP)	FS2013 (Torx 9IP)

Exchangeable inserts

	Designation	Sizes	P					M		K			N	S	H	HC	
			HC					HC		HC			HC	HC		HC	
			WKP25	WKP35	WSP45	WMP35	WXP45	WSP45	WMP35	WKP25	WKP35	WXK25	WNN25	WSP45	WMP35	WXP45	
Outer insert	P4840P- . R-A57	1-4	☺	☺	☺			☺		☺	☺			☺			
	P4840P- . R-E57	1-4	☺	☺	☺			☺		☺	☺			☺			
	P4840P- . R-E67	1-4		☺	☺			☺						☺			
	P4841P- . R-A57	1-4	☺	☺	☺			☺		☺	☺			☺			
	P4841P- . R-E57	1-4	☺	☺	☺			☺		☺	☺			☺			
Centre insert	P4841C- . R-A57	1-4															△
	P4841C- . R-E57	1-4															△
	P4840C- . R-E67	1-4															△

HC = Coated carbide

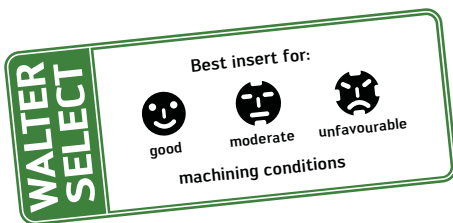

Drills B 4212

Xtra-tec® Insert Drill

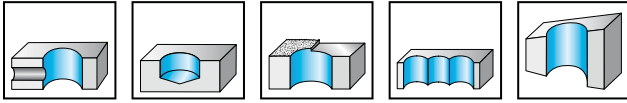
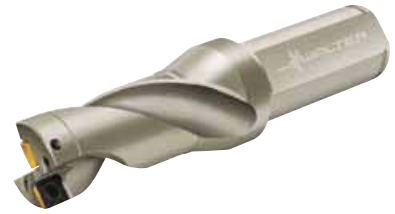

- diameter range 13.5-59 mm
- right-hand cutting
- drilling depth $2 \times D_c$

Tool	Designation	D_c mm	d_1 mm	d_4 mm	l_4 mm	l_5 mm	L_c mm	kg	No. of indexable inserts	Type	
Cylindrical shank with flat in acc. with ISO 9766 	B4212.F32.29.5.Z1.059R-5	29,5	32	40	91	60	59	0,7	$\frac{1}{1}$	P484 . P-5R P484 . C-5R	
	B4212.F32.30.Z1.060R-5	30	32	40	92	60	60	0,7	$\frac{1}{1}$		
	B4212.F32.31.Z1.062R-5	31	32	40	94	60	62	0,8	$\frac{1}{1}$		
	B4212.F32.32.Z1.064R-5	32	32	40	96	60	64	0,8	$\frac{1}{1}$		
	B4212.F32.33.Z1.066R-5	33	32	40	98	60	66	0,8	$\frac{1}{1}$		
	B4212.F32.34.Z1.068R-5	34	32	40	100	60	68	0,8	$\frac{1}{1}$		
	B4212.F32.35.Z1.070R-5	35	32	40	102	60	70	0,9	$\frac{1}{1}$		
	B4212.F32.36.Z1.072R-6	36	32	40	104	60	72	0,8	$\frac{1}{1}$		P484 . P-6R P484 . C-6R
	B4212.F40.37.Z1.074R-6	37	40	50	114	70	74	1,4	$\frac{1}{1}$		
	B4212.F40.38.Z1.076R-6	38	40	50	116	70	76	1,4	$\frac{1}{1}$		
	B4212.F40.39.Z1.078R-6	39	40	50	118	70	78	1,4	$\frac{1}{1}$		
	B4212.F40.40.Z1.080R-6	40	40	50	120	70	80	1,5	$\frac{1}{1}$		
	B4212.F40.41.Z1.082R-6	41	40	50	122	70	82	1,5	$\frac{1}{1}$		
	B4212.F40.42.Z1.084R-6	42	40	50	124	70	84	1,6	$\frac{1}{1}$		
	B4212.F40.43.Z1.086R-7	43	40	50	126	70	86	1,5	$\frac{1}{1}$	P484 . P-7R P484 . C-7R	
	B4212.F40.44.Z1.088R-7	44	40	50	128	70	88	1,6	$\frac{1}{1}$		
	B4212.F40.45.Z1.090R-7	45	40	50	130	70	90	1,6	$\frac{1}{1}$		
	B4212.F40.46.Z1.092R-7	46	40	50	132	70	92	1,7	$\frac{1}{1}$		
	B4212.F40.47.Z1.094R-7	47	40	50	134	70	94	1,7	$\frac{1}{1}$		
	B4212.F40.48.Z1.096R-7	48	40	50	136	70	96	1,8	$\frac{1}{1}$		
	B4212.F40.49.Z1.098R-7	49	40	50	138	70	98	1,8	$\frac{1}{1}$		
	B4212.F40.50.Z1.100R-7	50	40	50	140	70	100	1,9	$\frac{1}{1}$		P484 . P-8R P484 . C-8R
	B4212.F40.51.Z1.102R-8	51	40	50	142	70	102	1,9	$\frac{1}{1}$		
	B4212.F40.52.Z1.104R-8	52	40	50	144	70	104	2	$\frac{1}{1}$		
	B4212.F40.53.Z1.106R-8	53	40	50	146	70	106	2	$\frac{1}{1}$		
	B4212.F40.54.Z1.108R-8	54	40	50	148	70	108	2,1	$\frac{1}{1}$		
	B4212.F40.55.Z1.110R-8	55	40	50	150	70	110	2,2	$\frac{1}{1}$		
	B4212.F40.56.Z1.112R-8	56	40	50	152	70	112	2,2	$\frac{1}{1}$		
	B4212.F40.57.Z1.114R-8	57	40	50	154	70	114	2,3	$\frac{1}{1}$		
	B4212.F40.58.Z1.116R-8	58	40	50	156	70	116	2,4	$\frac{1}{1}$		
	B4212.F40.59.Z1.118R-8	59	40	50	158	70	118	2,5	$\frac{1}{1}$		

Bodies, assembly parts and screwdrivers are included in the standard pack.

N.B.: where through bores are created by a rotating tool, a disc forms which is ejected. Please implement safety measures.

Assembly parts

D _c mm	29,5-35	36-42	43-59
Clamping screw for insert Tightening torque	FS2080 (Torx 15 IP) 2,5 Nm	FS1453 (Torx 15 IP) 3,5 Nm	FS1495 (Torx 20 IP) 5,0 Nm

Accessories

D _c mm	29,5-42	43-59
Torque screwdriver	FS2003	FS2003
Interchangeable blade	FS2014 (Torx 15IP)	FS2015 (Torx 20IP)

Exchangeable inserts

	Designation	Sizes	P HC					M HC		K HC			N HC	S HC		H HC
			WKP25	WKP35	WSP45	WMP35	WXP45	WSP45	WMP35	WKP25	WKP35	WXX25	WNN25	WSP45	WMP35	WXP45
Outer insert	P4840P-. R-A57	5-8	☺	☺	☺			☺								
	P4840P-. R-E57	5-8	☺	☺	☺			☺								
	P4840P-. R-E67	5-8		☺	☺			☺								
	P4841P-. R-A57	5-8	☺	☺	☺			☺	☺							
	P4841P-. R-E57	5-8	☺	☺	☺			☺	☺							
Centre insert	P4841C-. R-A57	5-8														△
	P4841C-. R-E57	5-8														△
	P4840C-. R-E67	5-8														△

HC = Coated carbide
HW = Uncoated carbide

WALTER SELECT

Best insert for:

☺
good

☹
moderate

☹
unfavourable

machining conditions

Drills B 3212

Walter Stardrill

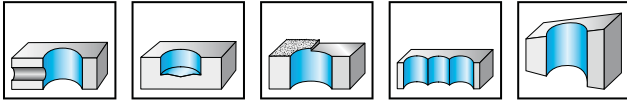

- diameter range 10-18 mm
- right-hand cutting
- drilling depth $2 \times D_c$

Tool	Designation	D_c mm	d_1 mm	l_4 mm	l_5 mm	L_c mm	kg	No. of indexable inserts	Type
Shank ISO 3338/2 or DIN 1835 Form B, when turned thro' 90° DIN 6535 Form HE 	B3212.DF.10.0.Z01.20R	10	16	31	49	20	0,08	2	LCMX 0502 . .
	B3212.DF.10.2.Z01.20R	10,2	16	31	49	20,4	0,08	2	
	B3212.DF.10.5.Z01.21R	10,5	16	32	49	21	0,009	2	
	B3212.DF.11.0.Z01.22R	11	16	34	49	22	0,09	2	
	B3212.DF.11.5.Z01.23R	11,5	16	35	49	23	0,03	2	
	B3212.DF.11.7.Z01.23R	11,7	16	35	49	23,4	0,009	2	
	B3212.DF.12.0.Z01.24R	12	16	36	49	24	0,09	2	
	B3212.DF.12.5.Z01.25R	12,5	16	38	49	25	0,09	2	
	B3212.DF.13.0.Z01.26R	13	16	39	49	26	0,09	2	
	B3212.DF.13.5.Z01.27R	13,5	16	40	49	27	0,1	2	
	B3212.DF.13.7.Z01.27R	13,7	16	41	49	27,4	0,1	2	LCMX 06T2 . .
	B3212.DF.14.0.Z01.28R	14	16	42	49	28	0,1	2	
	B3212.DF.14.5.Z01.29R	14,5	16	43	49	29	0,1	2	
	B3212.DF.15.0.Z01.30R	15	16	44	49	30	0,11	2	
	B3212.DF.15.5.Z01.31R	15,5	16	45	49	31	0,11	2	
	B3212.DF.15.7.Z01.31R	15,7	16	46	49	31,4	0,11	2	
	B3212.DF.16.0.Z01.32R	16	16	47	49	32	0,11	2	
	B3212.DF.16.5.Z01.33R	16,5	16	48	49	33	0,12	2	
	B3212.DF.17.0.Z01.34R	17	16	49	49	34	0,12	2	
	B3212.DF.17.5.Z01.35R	17,5	16	51	49	35	0,12	2	
B3212.DF.18.0.Z01.36R	18	16	52	49	36	0,13	2		

Bodies and assembly parts are included in the scope of delivery.

Possible X adjustment for boring into solid material greater than the nominal diameter:



$$X = +0.2 \text{ mm} / -0.1 \text{ mm} \rightarrow \Delta D = +0.4 \text{ mm} / -0.2 \text{ mm}$$

N.B.: where through bores are created by a rotating tool, a disc forms which is ejected. Please implement safety measures.

Assembly parts

D _c mm	10-13,7	14-15,7	16-18
 Clamping screw for insert Tightening torque	FS1012 (Torx 6) 0,4 Nm	FS1004 (Torx 7) 0,6 Nm	FS1020 (Torx 7) 0,6 Nm

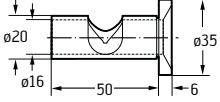
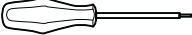
Accessories

D _c mm	10-13,7	14-18
 Eccentric sleeve	FS1207	FS1207
 Screwdriver	FS1063 (Torx 6)	FS309 (Torx 7)
 Clamping screw for collet chuck	FS1209	FS1209

Exchangeable inserts

Designation	Length mm	Width mm	P		M	K		S	HC	
			HC		HC	HC		HC	HC	
			WAP20	WKP25	WKP35	WTP35	WSP45	WAK15	WKP25	WKP35
 LCMX 050203-B57	5,2	4,0	☹	☹	☹	☹	☹	☹	☹	☹
LCMX 050203-D57	5,2	4,0	☹	☹	☹	☹	☹	☹	☹	☹
LCMX 050203-E57	5,2	4,0	☹	☹	☹	☹	☹	☹	☹	☹
LCMX 06T204-B57	6,6	5,2	☹	☹	☹	☹	☹	☹	☹	☹
LCMX 06T204-D57	6,6	5,2	☹	☹	☹	☹	☹	☹	☹	☹
LCMX 06T204-E57	6,6	5,2	☹	☹	☹	☹	☹	☹	☹	☹

HC = Coated carbide

WALTER SELECT

Best insert for:



good



moderate



unfavourable

machining conditions

Drills B 3011 M

Walter Stardrill

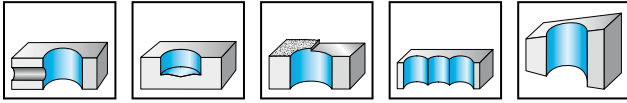

- in cartridge version
- drilling depth $2 \times D_c$

Tool	Designation	D_c mm	d_1 mm	l_4 mm	L_c mm	Number of external cartridges	Number of internal cartridges	kg	No. of indexable inserts	Type
Modular adaptor	B3011M.0.80.205.68	68	NCT 80	205	135	1 X FR 666	1 X FR 668	4,2	4	P 284 ... - 5
	B3011M.0.80.225.78	78	NCT 80	225	155	1 X FR 665	3 X FR 667	5,3	4	

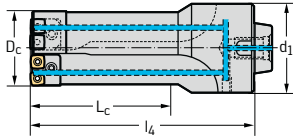

Bodies and assembly parts are included in the scope of delivery.

Because the external cartridge can be adjusted radially,
the tool diameter can be corrected by +0.6 mm.

N.B.: where through bores are created by a rotating tool, a disc forms which is ejected. Please implement safety measures.

For other diameters between 59.5 mm and 120 mm, appropriate tool designs and additional cartridges are available.
If necessary, please contact your Walter consultant.

Walter Xpress	D_c mm	No. of cartridges							No. of inserts		
		FR 661	FR 662	FR 663	FR 664	FR 665	FR 666	FR 667	FR 668	Size 4	Size 5
	59,5 – 63,4	1			1					4	
	63,5 – 64,4	1	2							4	
	64,5 – 65,4	1	1	1						4	
	65,5 – 73,4						1		1		4
	73,5 – 75,4						1	2			4
	75,5 – 81,4					1		3			4
	81,5 – 86,4	1		2	1					6	
	86,5 – 89,4	1	1	1	1					6	
	89,5 – 92,4	1	1	1	1					6	
	92,5 – 93,4	1	3	1						6	
	93,5 – 95,4	1	2	2						6	
	95,5 – 97,4	1	3	1						6	
	97,5 – 99,4	1	2	2						6	
	99,5 – 105,4						1	2	1		6
	105,5 – 114,4						1	4			6
	114,5 – 120,0					1		5			6

Assembly parts

D _c mm	68	78	
	External cartridge	FR666	FR665
	Internal cartridge	FR668	FR667
	Clamping screw	M04X006 ISO 4026	M10X010 ISO 4026
	Clamping screw for indexable insert Tightening torque	FS1029 (Torx 20) 5,0 Nm	FS1029 (Torx 20) 5,0 Nm
	Clamping screw for FR665 Tightening torque		FS969 8,0 Nm
	Clamping screw for FR666, FR667, FR668 Tightening torque	FS966 (SW 5) 8,0 Nm	FS966 (SW 5) 8,0 Nm
	Threaded plug	FS960	FS963

Accessories

D _c mm	68-78	
	Screwdriver	FS228 (Torx 20)
	Key ISO 2936	ISO2936-5 (SW 5)

Exchangeable inserts

Designation	Sizes	P		M	K		S	HC			
		WAP20	WKP25	WTP35	WSP45	WSP45	WAK15	WKP25	WKP35	WSP45	WXP40
P28467	1-7	☺	☺	☺	☺	☺	☺	☺	☺		
P28469	1-7		☺	☺	☺		☺	☺			
P28475	1-7		☺	☺	☺		☺	☺		☺	
P28477	1-7		☺	☺	☺	☺	☺	☺		☺	
P28479	1-7		☺	☺	☺		☺	☺		☺	

HC = Coated carbide

WALTER SELECT

Best insert for:

☺
good

☹
moderate

☹
unfavourable

machining conditions

Chamfer drill B 4012C

Xtra-tec® Point Drill

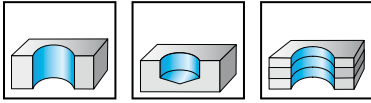



- diameter range 12-29 mm
- right-hand cutting
- drilling depth 2.5 x D_C

Tool	Designation	For thread	D _C mm	D ₁ mm	d ₁	d ₄ mm	d ₂ mm	l ₄ mm	l ₅ mm	L _C mm	Z	kg	No. of indexable inserts	Type
Cylindrical shank with flat in acc. with ISO 9766 	B4012C.F20.12,0.Z02.35R*	M14	12	23,7	20	30		68	50	35,2	2	0,23	1 2	P600.-D12.R TC...110208
	B4012C.F20.14,0.Z02.40R	M16	14	25,7	20	30		76	50	40,5	2	0,28	1 2	P600.-D14.R TC...110208
	B4012C.F20.15,0.Z02.44R	M18	15	26,7	20	30		80	50	44,2	2	0,28	1 2	P600.-D15.R TC...110208
	B4012C.F20.17,0.Z02.48R	M20	17	28,7	20	30		88	50	48,6	2	0,32	1 2	P600.-D17.R TC...110208
	B4012C.F20.19,0.Z02.52R	M22	19	30,7	20	30		96	50	52,5	2	0,34	1 2	P600.-D19.R TC...110208
Cylindrical shank with flat in acc. with ISO 9766 	B4012C.F20.21,0.Z02.55R	M24	21	32,7	20	30	32	104	50	55,3	2	0,39	1 2	P600.-D21.R TC...110208
	B4012C.F25.24,0.Z02.61R	M27	24	43,4	25	35	42,6	117	56	61,4	2	0,7	1 2	P600.-D24.R TC...16T308
	B4012C.F25.26,0.Z02.66R	M30	26	45,4	25	35	44,4	125	56	66,7	2	0,7	1 2	P600.-D26.R TC...16T308
	B4012C.F32.29,0.Z02.71R	M33	29	48,4	32	42	47	138	60	72,3	2	1,1	1 2	P600.-D29.R TC...16T308





Bodies and assembly parts are included in the scope of delivery.

* Example: inserts with D_C=12.00 mm up to and incl. 12.99 mm can fitted into this tool.

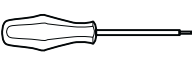

Assembly parts

D _c mm	12	14-15	17	19	21	24	26	29
 Clamping screw for indexable insert P600. Tightening torque	FS1396 (Torx 7 IP) 1,2 Nm	FS1397 (Torx 8 IP) 2,0 Nm	FS1398 (Torx 8 IP) 2,0 Nm	FS1399 (Torx 15 IP) 4,0 Nm	FS1400 (Torx 20 IP) 5,0 Nm	FS1402 (Torx 20 IP) 5,0 Nm	FS1403 (Torx 25 IP) 5,5 Nm	FS1404 (Torx 25 IP) 5,5 Nm
 Clamping screw for chamfering insert TC..110208 Tightening torque	FS2061 (Torx 7IP) 0,9 Nm	FS2061 (Torx 7IP) 0,9 Nm	FS2061 (Torx 7IP) 0,9 Nm	FS2061 (Torx 7IP) 0,9 Nm	FS2061 (Torx 7IP) 0,9 Nm	FS2063 (Torx 15IP) 3,0 Nm	FS2063 (Torx 15IP) 3,0 Nm	FS2063 (Torx 15IP) 3,0 Nm

Accessories

D _c mm	12	14-17	19	21-24	26-29
 Torque screwdriver	FS2001	FS2003	FS2003	FS2003	
 Interchangeable blade	FS2011 (Torx 7IP)	FS2012 (Torx 8IP)	FS2014 (Torx 15IP)	FS2015 (Torx 20IP)	FS2049 (Torx 25IP)
 Screwdriver	FS1490 (Torx 7IP)	FS1483 (Torx 8IP)	FS1485 (Torx 15IP)	FS1486 (Torx 20IP)	FS1487 (Torx 25IP)
 T-handle torque wrench					FS2041

Exchangeable and indexable inserts

Designation	Diameter range	P		M		K			N	S	H				
		HC	HC	HC	HC	HC	HC	HC	HC						
		WMP35	WXP45	WKP25	WKP35	WSP45	WMP35	WSP45	WXK25	WKP25	WKP35	WNN25	WMP35	WSP45	
 P6001-D ..	12-31,99		☒												
P6002-D ..	12-31,99								☒						
P6003-D ..	12-37,99	☒					☒							☒	
P6004-D ..	12-31,50											☒			
 For chamfer inserts TC .. see page C 15															

HC = Coated carbide

WALTER SELECT

Best insert for:



good



moderate



unfavourable

machining conditions

Drills B 4013

Xtra-tec® Point Drill

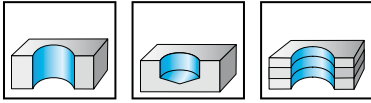

- diameter range 12-37.99 mm
- right-hand cutting
- drilling depth 3 x D_C

Tool	Designation	D _C mm	d ₁ mm	d ₄ mm	l ₄ mm	l ₅ mm	L _C mm	Z	kg	No. of indexable inserts	Type
Cylindrical shank with flat in acc. with ISO 9766 	B4013.F20.12,0.Z02.36R'	12	20	30	68	50	38	2	0,22	1	P 600 . - D12 . . R
	B4013.F20.13,0.Z02.39R	13	20	30	72	50	41	2	0,22	1	P 600 . - D13 . . R
	B4013.F20.14,0.Z02.42R	14	20	30	76	50	45	2	0,22	1	P 600 . - D14 . . R
	B4013.F20.15,0.Z02.45R	15	20	30	80	50	48	2	0,25	1	P 600 . - D15 . . R
	B4013.F20.16,0.Z02.48R	16	20	30	84	50	51	2	0,25	1	P 600 . - D16 . . R
	B4013.F20.17,0.Z02.51R	17	20	30	88	50	54	2	0,26	1	P 600 . - D17 . . R
	B4013.F20.18,0.Z02.54R	18	20	30	92	50	57	2	0,28	1	P 600 . - D18 . . R
	B4013.F20.19,0.Z02.57R	19	20	30	96	50	61	2	0,29	1	P 600 . - D19 . . R
	B4013.F20.20,0.Z02.60R	20	20	30	100	50	64	2	0,31	1	P 600 . - D20 . . R
	B4013.F20.21,0.Z02.63R	21	20	30	104	50	67	2	0,33	1	P 600 . - D21 . . R
	B4013.F25.22,0.Z02.66R	22	25	35	109	56	70	2	0,48	1	P 600 . - D22 . . R
	B4013.F25.23,0.Z02.69R	23	25	35	113	56	73	2	0,5	1	P 600 . - D23 . . R
	B4013.F25.24,0.Z02.72R	24	25	35	117	56	76	2	0,5	1	P 600 . - D24 . . R
	B4013.F25.25,0.Z02.75R	25	25	35	121	56	80	2	0,6	1	P 600 . - D25 . . R
	B4013.F25.26,0.Z02.78R	26	25	35	125	56	83	2	0,6	1	P 600 . - D26 . . R
	B4013.F25.27,0.Z02.81R	27	25	35	129	56	86	2	0,6	1	P 600 . - D27 . . R
	B4013.F32.28,0.Z02.84R	28	32	42	134	60	89	2	0,9	1	P 600 . - D28 . . R
	B4013.F32.29,0.Z02.87R	29	32	42	138	60	92	2	0,9	1	P 600 . - D29 . . R
	B4013.F32.30,0.Z02.90R	30	32	42	142	60	95	2	1	1	P 600 . - D30 . . R
	B4013.F32.31,0.Z02.93R	31	32	42	146	60	99	2	1	1	P 600 . - D31 . . R
	B4013.F40.32,0.Z02.96R	32	40	50	150	70	102	2	1,3	1	P 600 . - D32 . . R
	B4013.F40.33,0.Z02.99R	33	40	50	154	70	105	2	1,3	1	P 600 . - D33 . . R
	B4013.F40.34,0.Z02.102R	34	40	50	158	70	108	2	1,4	1	P 600 . - D34 . . R
	B4013.F40.35,0.Z02.105R	35	40	50	162	70	111	2	1,5	1	P 600 . - D35 . . R
	B4013.F40.36,0.Z02.108R	36	40	50	166	70	115	2	1,5	1	P 600 . - D36 . . R
	B4013.F40.37,0.Z02.111R	37	40	50	170	70	118	2	1,5	1	P 600 . - D37 . . R





Bodies and assembly parts are included in the scope of delivery.

* Example: inserts with D_C=12.00 mm up to and incl. 12.99 mm can fitted into this tool.





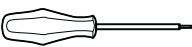

Assembly parts

D _c mm	12-13	14-15	16-17	18-19	20-21	22-23	24-25	26-27	28-33	34-37
 Clamping screw for insert Tightening torque	FS1396 (Torx 7 IP) 1,2 Nm	FS1397 (Torx 8 IP) 2,0 Nm	FS1398 (Torx 8 IP) 2,0 Nm	FS1399 (Torx 15 IP) 4,0 Nm	FS1400 (Torx 20 IP) 5,0 Nm	FS1401 (Torx 20 IP) 5,0 Nm	FS1402 (Torx 20 IP) 5,0 Nm	FS1403 (Torx 25 IP) 5,5 Nm	FS1404 (Torx 25 IP) 5,5 Nm	FS2159 (Torx 25 IP) 5,5 Nm

Accessories

D _c mm	12-13	14-17	18-19	20-25	26-37
 Torque screwdriver	FS2001	FS2003	FS2003	FS2003	
 Interchangeable blade	FS2011 (Torx 7IP)	FS2012 (Torx 8IP)	FS2014 (Torx 15IP)	FS2015 (Torx 20IP)	FS2049 (Torx 25IP)
 Screwdriver	FS1490 (Torx 7IP)	FS1483 (Torx 8IP)	FS1485 (Torx 15IP)	FS1486 (Torx 20IP)	FS1487 (Torx 25IP)
 T-handle torque wrench					FS2041

Exchangeable inserts

Designation	Diameter range	P		M		K			N		S		H	
		HC		HC		HC			HC		HC			
		WMP35	WXP45	WKP25	WKP35	WSP45	WMP35	WSP45	WXX25	WKP25	WKP35	WNN25	WMP35	WSP45
P6001-D ..	12-31,99													
P6002-D ..	12-31,99													
P6003-D ..	12-37,99													
P6004-D ..	12-31,50													

HC = Coated carbide

WALTER SELECT

Best insert for:

 good



 moderate

 unfavourable

machining conditions

Drills B 4213

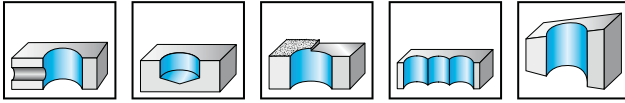
Xtra-tec® Insert Drill



- diameter range 13.5-59 mm
- right-hand cutting
- drilling depth 3 x D_c

Tool	Designation	D _c mm	d ₁ mm	d ₄ mm	l ₄ mm	l ₅ mm	L _c mm	kg	No. of indexable inserts	Type
Cylindrical shank with flat in acc. with ISO 9767 	B4213.F20.13,5.Z1.040R-1	13,5	20	30	61	50	40,5	0,17	$\frac{1}{1}$	P484 . P-1R P484 . C-1R
	B4213.F20.14.Z1.042R-1	14	20	30	62	50	42	0,18	$\frac{1}{1}$	
	B4213.F20.14,5.Z1.043R-1	14,5	20	30	64	50	43,5	0,18	$\frac{1}{1}$	
	B4213.F20.15.Z1.045R-1	15	20	30	65	50	45	0,18	$\frac{1}{1}$	
	B4213.F20.15,5.Z1.046R-1	15,5	20	30	67	50	46,5	0,19	$\frac{1}{1}$	
	B4213.F25.16.Z1.048R-1	16	25	32	73	56	48	0,33	$\frac{1}{1}$	
	B4213.F25.16,5.Z1.049R-2	16,5	25	32	75	56	49,5	0,44	$\frac{1}{1}$	P484 . P-2R P484 . C-2R
	B4213.F25.17.Z1.051R-2	17	25	32	76	56	51	0,43	$\frac{1}{1}$	
	B4213.F25.17,5.Z1.052R-2	17,5	25	32	77,5	56	52,5	0,44	$\frac{1}{1}$	
	B4213.F25.18.Z1.054R-2	18	25	32	79	56	54	0,43	$\frac{1}{1}$	
	B4213.F25.18,5.Z1.055R-2	18,5	25	32	80,5	56	55,5	0,46	$\frac{1}{1}$	
	B4213.F25.19.Z1.057R-2	19	25	32	82	56	57	0,46	$\frac{1}{1}$	
	B4213.F25.19,5.Z1.058R-2	19,5	25	32	84	56	58,5	0,47	$\frac{1}{1}$	P484 . P-3R P484 . C-3R
	B4213.F25.20.Z1.060R-2	20	25	32	85	56	60	0,48	$\frac{1}{1}$	
	B4213.F25.20,5.Z1.061R-3	20,5	25	32	87	56	61,5	0,5	$\frac{1}{1}$	
	B4213.F25.21.Z1.063R-3	21	25	32	88	56	63	0,4	$\frac{1}{1}$	
	B4213.F25.21,5.Z1.064R-3	21,5	25	32	90	56	64,5	0,5	$\frac{1}{1}$	
	B4213.F25.22.Z1.066R-3	22	25	32	91	56	66	0,42	$\frac{1}{1}$	
	B4213.F25.22,5.Z1.067R-3	22,5	25	32	93	56	67,5	0,5	$\frac{1}{1}$	P484 . P-4R P484 . C-4R
	B4213.F25.23.Z1.069R-3	23	25	32	94	56	69	0,43	$\frac{1}{1}$	
	B4213.F25.23,5.Z1.070R-3	23,5	25	32	96	56	70,5	0,5	$\frac{1}{1}$	
	B4213.F25.24.Z1.072R-3	24	25	32	97	56	72	0,44	$\frac{1}{1}$	
	B4213.F25.24,5.Z1.073R-4	24,5	25	32	99	56	73,5	0,5	$\frac{1}{1}$	
	B4213.F25.25.Z1.075R-4	25	25	32	100	56	75	0,6	$\frac{1}{1}$	
	B4213.F32.25,5.Z1.076R-4	25,5	32	40	109	60	76,5	0,8	$\frac{1}{1}$	P484 . P-4R P484 . C-4R
	B4213.F32.26.Z1.078R-4	26	32	40	110	60	78	0,8	$\frac{1}{1}$	
	B4213.F32.26,5.Z1.079R-4	26,5	32	40	112	60	79,5	0,9	$\frac{1}{1}$	
	B4213.F32.27.Z1.081R-4	27	32	40	113	60	81	0,9	$\frac{1}{1}$	
	B4213.F32.27,5.Z1.082R-4	27,5	32	40	115	60	82,5	0,9	$\frac{1}{1}$	
	B4213.F32.28.Z1.084R-4	28	32	40	116	60	84	0,8	$\frac{1}{1}$	
B4213.F32.28,5.Z1.085R-4	28,5	32	40	118	60	85,5	0,9	$\frac{1}{1}$	P484 . P-4R P484 . C-4R	
B4213.F32.29.Z1.087R-4	29	32	40	119	60	87	0,9	$\frac{1}{1}$		

Bodies, assembly parts and screwdrivers are included in the standard pack.

N.B.: where through bores are created by a rotating tool, a disc forms which is ejected. Please implement safety measures.

Assembly parts

D _c mm	13,5-16	16,5-20	20,5-24	24,5-29
Clamping screw for insert Tightening torque	FS2120 (Torx 6IP) 0,4 Nm	FS2111 (Torx 7 IP) 0,9 Nm	FS1454 (Torx 8 IP) 1,2 Nm	FS1457 (Torx 9 IP) 2,0 Nm

Accessories

D _c mm	13,5-20	20,5-24	24,5-29
Torque screwdriver	FS2001	FS2001	FS2003
Interchangeable blade	FS2011 (Torx 7IP)	FS2012 (Torx 8IP)	FS2013 (Torx 9IP)

Exchangeable inserts

	Designation	Sizes	P					M		K			N	S	H	HC	
			HC					HC		HC			HC	HC		HC	
			WKP25	WKP35	WSP45	WMP35	WXP45	WSP45	WMP35	WKP25	WKP35	WXK25	WNN25	WSP45	WMP35	WXP45	HC
Outer insert	P4840P- . R-A57	1-4	☺	☺	☺			☺		☺	☺			☺			
	P4840P- . R-E57	1-4	☺	☺	☺			☺		☺	☺			☺			
	P4840P- . R-E67	1-4		☺	☺			☺						☺			
	P4841P- . R-A57	1-4	☺	☺	☺			☺		☺	☺			☺			
	P4841P- . R-E57	1-4	☺	☺	☺			☺		☺	☺			☺			
Centre insert	P4841C- . R-A57	1-4															△
	P4841C- . R-E57	1-4															△
	P4840C- . R-E67	1-4															△

HC = Coated carbide

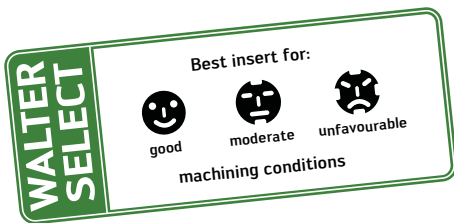

Drills B 4213

Xtra-tec® Insert Drill

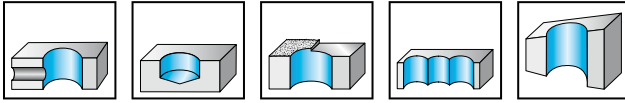

- diameter range 13.5-59 mm
- right-hand cutting
- drilling depth 3 x D_c

Tool	Designation	D _c mm	d ₁ mm	d ₄ mm	l ₄ mm	l ₅ mm	L _c mm	kg	No. of indexable inserts	Type	
Cylindrical shank with flat in acc. with ISO 9767 	B4213.F32.29.5.Z1.088R-5	29,5	32	40	121	60	88,5	0,8	1/1	P484 . P-5R P484 . C-5R	
	B4213.F32.30.Z1.090R-5	30	32	40	122	60	90	1	1/1		
	B4213.F32.31.Z1.093R-5	31	32	40	125	60	93	0,9	1/1		
	B4213.F32.32.Z1.096R-5	32	32	40	128	60	96	0,9	1/1		
	B4213.F32.33.Z1.099R-5	33	32	40	131	60	99	0,9	1/1		
	B4213.F32.34.Z1.102R-5	34	32	40	134	60	102	1	1/1		
	B4213.F32.35.Z1.105R-5	35	32	40	137	60	105	1	1/1		
	B4213.F32.36.Z1.108R-6	36	32	40	140	60	108	1	1/1		P484 . P-6R P484 . C-6R
	B4213.F40.37.Z1.111R-6	37	40	50	151	70	111	1,5	1/1		
	B4213.F40.38.Z1.114R-6	38	40	50	154	70	114	1,6	1/1		
	B4213.F40.39.Z1.117R-6	39	40	50	157	70	117	1,6	1/1		
	B4213.F40.40.Z1.120R-6	40	40	50	160	70	120	1,7	1/1		
	B4213.F40.41.Z1.123R-6	41	40	50	163	70	123	1,8	1/1		
	B4213.F40.42.Z1.126R-6	42	40	50	166	70	126	1,8	1/1		
	B4213.F40.43.Z1.129R-7	43	40	50	169	70	129	1,8	1/1	P484 . P-7R P484 . C-7R	
	B4213.F40.44.Z1.132R-7	44	40	50	172	70	132	1,9	1/1		
	B4213.F40.45.Z1.135R-7	45	40	50	175	70	135	1,9	1/1		
	B4213.F40.46.Z1.138R-7	46	40	50	178	70	138	2	1/1		
	B4213.F40.47.Z1.141R-7	47	40	50	181	70	141	2,1	1/1		
	B4213.F40.48.Z1.144R-7	48	40	50	184	70	144	2,2	1/1		
	B4213.F40.49.Z1.147R-7	49	40	50	187	70	147	2,3	1/1		
	B4213.F40.50.Z1.150R-7	50	40	50	190	70	150	2,3	1/1		
	B4213.F40.51.Z1.153R-8	51	40	50	193	70	153	2,3	1/1		P484 . P-8R P484 . C-8R
	B4213.F40.52.Z1.156R-8	52	40	50	196	70	156	2,4	1/1		
	B4213.F40.53.Z1.159R-8	53	40	50	199	70	159	2,5	1/1		
	B4213.F40.54.Z1.162R-8	54	40	50	202	70	162	2,6	1/1		
	B4213.F40.55.Z1.165R-8	55	40	50	205	70	165	2,7	1/1		
	B4213.F40.56.Z1.168R-8	56	40	50	208	70	168	2,8	1/1		
	B4213.F40.57.Z1.171R-8	57	40	50	211	70	171	2,9	1/1		
	B4213.F40.58.Z1.174R-8	58	40	50	214	70	174	3,1	1/1		
	B4213.F40.59.Z1.177R-8	59	40	50	217	70	177	3,2	1/1		

Bodies, assembly parts and screwdrivers are included in the standard pack.

N.B.: where through bores are created by a rotating tool, a disc forms which is ejected. Please implement safety measures.

Assembly parts

D _c mm	29,5-35	36-42	43-59
Clamping screw for insert Tightening torque	FS2080 (Torx 15 IP) 2,5 Nm	FS1453 (Torx 15 IP) 3,5 Nm	FS1495 (Torx 20 IP) 5,0 Nm

Accessories

D _c mm	29,5-42	43-59
Torque screwdriver	FS2003	FS2003
Interchangeable blade	FS2014 (Torx 15IP)	FS2015 (Torx 20IP)

Exchangeable inserts

	Designation	Sizes	P					M		K			N	S	H	HC
			HC					HC		HC			HC	HC		
			WKP25	WKP35	WSP45	WMP35	WXP45	WSP45	WMP35	WKP25	WKP35	WXX25	WNN25	WSP45	WMP35	WXP45
Outer insert	P4840P-. R-A57	5-8	☺	☺	☺			☺		☺	☺					
	P4840P-. R-E57	5-8	☺	☺	☺			☺		☺	☺					
	P4840P-. R-E67	5-8						☺								
	P4841P-. R-A57	5-8	☺	☺	☺			☺		☺	☺					
	P4841P-. R-E57	5-8	☺	☺	☺			☺		☺	☺					
Centre insert	P4841C-. R-A57	5-8														△
	P4841C-. R-E57	5-8														△
	P4840C-. R-E67	5-8														△

HC = Coated carbide
HW = Uncoated carbide

WALTER SELECT

Best insert for:

☺
good

☹
moderate

☹
unfavourable

machining conditions

Drills B 4213

Xtra-tec® Insert Drill

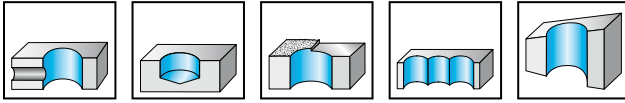

- diameter range 65-80 mm
- right-hand cutting
- drilling depth 3 x D_C

Tool	Designation	D _C mm	d ₁ mm	l ₄ mm	L _C mm	Number of external cartridges	Number of internal cartridges	kg	No. of indexable inserts	Type
	B4213.N8.065.Z1.195R-5	65	NCT 80	245	195	1xFR738+FR741	1xFR737C-5	4,1	3 1	P484 . P-5R P484 . C-5R
	B4213.N8.068.Z1.204R-6	68	NCT 80	254	204	1xFR744+FR745	1xFR743C-6	4,5	3 1	P484 . P-6R P484 . C-6R
	B4213.N8.070.Z1.210R-6	70	NCT 80	260	210	1xFR744+FR746	1xFR743C-P	4,7	3 1	
	B4213.N8.078.Z1.234R-6	78	NCT 80	284	234	1xFR744+FR748	1xFR743C-6	6	3 1	
	B4213.N8.080.Z1.240R-5	80	NCT 80	290	240	1xFR738+FR739	1xFR737C-5	6,2	5 1	P484 . P-5R P484 . C-5R



Bodies, assembly parts and screwdrivers are included in the standard pack.

N.B.: where through bores are created by a rotating tool, a disc forms which is ejected. Please implement safety measures.



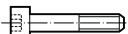

For other diameters between 59.5 mm and 120 mm, appropriate tool designs and additional cartridges are available. If necessary, please contact your Walter consultant.

D _C mm	No. of cartridges											No. of inserts			
	FR737C-5	FR738P-5	FR739P-5	FR740P-5	FR741P-5	FR743C-6	FR744P-6	FR745P-6	FR746P-6	FR747P-6	FR748P-6	P484 . P-Gr.5	P484 . C-Gr.5	P484 . P-Gr.6	P484 . C-Gr.6
59,0-62,0	1	1		1								3	1		
62,1-65,0	1	1			1							3	1		
65,1-68,4						1	1	1						3	1
68,5-72,8						1	1		1					3	1
72,9-76,6						1	1			1				3	1
76,7-79,1						1	1				1			3	1
79,2-82,5	1	3	1									5	1		
82,6-85,1	1	3		1								5	1		
85,2-87,0	1	3			1							5	1		
87,1-90,2	1	3	1									5	1		
90,3-92,3	1	3		1								5	1		
92,4-95,8	1	3			1							5	1		
95,9-99,2						1	3	1						5	1
99,3-102,7						1	3		1					5	1
102,8-105,4						1	3			1				5	1
105,5-108,8						1	3		1					5	1
108,9-114,2						1	3			1				5	1
114,3-120,0						1	3				1			5	1

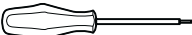

Assembly parts

D _c mm	65	68	70	78	80
Internal cartridge	FR737C-5	FR743C-6	FR743C-6	FR743C-6	FR737C-5
External cartridge	FR738P-5	FR745P-6	FR746P-6	FR744P-6	FR738P-5
 Clamping screw for insert Tightening torque	FS1453 (Torx 15 IP) 3,5 Nm	FS1453 (Torx 15 IP) 3,5 Nm	FS1453 (Torx 15 IP) 3,5 Nm	FS1453 (Torx 15 IP) 3,5 Nm	FS1453 (Torx 15 IP) 3,5 Nm
 Adjusting screw, radial	FS334	FS334	FS334	FS334	FS334
 Clamping screw for cartridge Tightening torque	FS966 (SW 5) 8,0 Nm	FS966 (SW 5) 8,0 Nm	FS966 (SW 5) 8,0 Nm	FS966 (SW 5) 8,0 Nm	FS966 (SW 5) 8,0 Nm

Accessories

D _c mm	65-68	70	78-80
 Screwdriver	FS1485 (Torx 15IP)	FS1485 (Torx 15IP)	FS1485 (Torx 15IP)
 Torque screwdriver	FS2003	FS2003	FS2003
 Interchangeable blade	FS2014 (Torx 15IP)	FS2014 (Torx 15IP)	FS2014 (Torx 15IP)
 Key ISO 2936	ISO2936-4 (SW 4)	ISO2936-5 (SW 5)	ISO2936-4 (SW 4)

Exchangeable inserts

Designation	Sizes	P		M		K		N		S		H	HC
		HC	HW	HC	HW	HC	HW	HC	HW	HC	HW	HC	HW
 Outer insert	P4840P-. R-A57	☺	☺	☺	☺	☺	☺	☺	☺	☺	☺		
	P4840P-. R-E57	☺	☺	☺	☺	☺	☺	☺	☺	☺	☺		
	P4840P-. R-E67	☺	☺	☺	☺	☺	☺	☺	☺	☺	☺		
	P4841P-. R-A57	☺	☺	☺	☺	☺	☺	☺	☺	☺	☺		
	P4841P-. R-E57	☺	☺	☺	☺	☺	☺	☺	☺	☺	☺		
 Centre insert	P4841C-. R-A57												△
	P4841C-. R-E57												△
	P4840C-. R-E67												△

HC = Coated carbide
HW = Uncoated carbide

WALTER SELECT

Best insert for:



good



moderate



unfavourable

machining conditions

Drills B 3213

Walter Stardrill

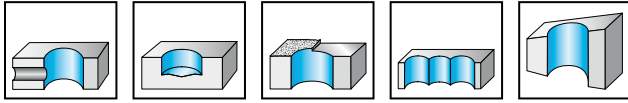

- diameter range 10-18 mm
- right-hand cutting
- drilling depth 3 x D_c

Tool	Designation	D _c mm	d ₁ mm	l ₄ mm	l ₅ mm	L _c mm	kg	No. of indexable inserts	Type
Shank ISO 3338/2 or DIN 1835 Form B, turned 90° DIN 6535 Form HE 	B3213.DF.10.0.Z01.30R	10	16	41	49	30	0,09	2	LCMX 0502...
	B3213.DF.10,2.Z01.30R	10,2	16	41	49	30,6	0,09	2	
	B3213.DF.10,5.Z01.31R	10,5	16	43	49	31,5	0,009	2	
	B3213.DF.11,0.Z01.33R	11	16	45	49	33	3,9	2	
	B3213.DF.11,5.Z01.34R	11,5	16	47	49	34,5	0,1	2	
	B3213.DF.11,7.Z01.35R	11,7	16	48	49	35,1	0,1	2	
	B3213.DF.12,0.Z01.36R	12	16	48	49	36	0,098	2	
	B3213.DF.12,5.Z01.37R	12,5	16	50	49	37,5	0,1	2	
	B3213.DF.13,0.Z01.39R	13	16	52	49	39	0,1	2	
	B3213.DF.13,5.Z01.40R	13,5	16	54	49	40,5	0,11	2	
	B3213.DF.13,7.Z01.41R	13,7	16	55	49	41,1	0,11	2	LCMX 06T2...
	B3213.DF.14,0.Z01.42R	14	16	56	49	42	0,11	2	
	B3213.DF.14,5.Z01.43R	14,5	16	57	49	43,5	0,11	2	
	B3213.DF.15,0.Z01.45R	15	16	59	49	45	0,12	2	
	B3213.DF.15,5.Z01.46R	15,5	16	61	49	46,5	0,12	2	
	B3213.DF.15,7.Z01.47R	15,7	16	62	49	47,1	0,13	2	
	B3213.DF.16,0.Z01.48R	16	16	63	49	48	0,13	2	
	B3213.DF.16,5.Z01.49R	16,5	16	65	49	49,5	0,12	2	
	B3213.DF.17,0.Z01.51R	17	16	66	49	51	0,12	2	
	B3213.DF.17,5.Z01.52R	17,5	16	68	49	52,5	0,14	2	
B3213.DF.18,0.Z01.54R	18	16	70	49	54	0,16	2		

Bodies and assembly parts are included in the scope of delivery.

Possible X adjustment for boring into solid material greater than the nominal diameter:



X = +0.2 mm / -0.1 mm → ΔD = +0.4 mm / -0.2 mm

N.B.: where through bores are created by a rotating tool, a disc forms which is ejected. Please implement safety measures.

Assembly parts

D _c mm	10-13,7	14-15,7	16-18
 Clamping screw for insert Tightening torque	FS1012 (Torx 6) 0,4 Nm	FS1004 (Torx 7) 0,6 Nm	FS1020 (Torx 7) 0,6 Nm

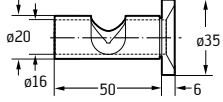
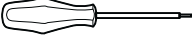
Accessories

D _c mm	10-13,7	14-18
 Eccentric sleeve	FS1207	FS1207
 Screwdriver	FS1063 (Torx 6)	FS309 (Torx 7)
 Clamping screw for collet chuck	FS1209	FS1209

Exchangeable inserts

Designation	Length mm	Width mm	P		M	K		S	HC	
			HC		HC	HC		HC	HC	
			WAP20	WKP25	WKP35	WTP35	WSP45	WAK15	WKP25	WKP35
 LCMX 050203-B57	5,2	4,0								
LCMX 050203-D57	5,2	4,0								
LCMX 050203-E57	5,2	4,0								
LCMX 06T204-B57	6,6	5,2								
LCMX 06T204-D57	6,6	5,2								
LCMX 06T204-E57	6,6	5,2								

HC = Coated carbide

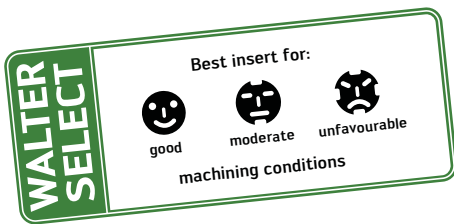

Drills B 3213.C

Capto™ Stardrill

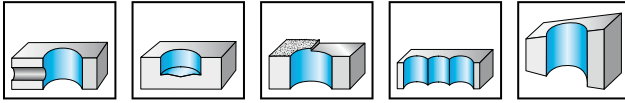

- diameter range 16-37 mm
- right-hand cutting
- drilling depth $3 \times D_c$

Tool	Designation	D_c mm	d_1 mm	l_4 mm	L_c mm	kg	No. of indexable inserts	Type
	B3213.C3.016.Z01.048R	16	C3	83	48	0,2	2	P 284 .. - 1
	B3213.C3.021.Z01.063R	21	C3	98	63	0,25	2	P 284 .. - 2
	B3213.C3.026.Z01.078R	26	C3	114	78	0,33	2	P 284 .. - 3
	B3213.C4.021.Z01.063R	21	C4	108	63	0,43	2	P 284 .. - 2
	B3213.C4.026.Z01.078R	26	C4	118	78	0,49	2	P 284 .. - 3
	B3213.C4.031.Z01.093R	31	C4	137	93	0,6	2	P 284 .. - 4
	B3213.C5.021.Z01.063R	21	C5	110	63	0,7	2	P 284 .. - 2
	B3213.C5.026.Z01.078R	26	C5	123	78	0,7	2	P 284 .. - 3
	B3213.C5.031.Z01.093R	31	C5	138	93	0,8	2	P 284 .. - 4
	B3213.C5.037.Z01.111R	37	C5	161	111	1,1	2	P 284 .. - 5

For possible X adjustment for boring into solid material, see page C 177.

Bodies and assembly parts are included in the scope of delivery.

N.B.: where through bores are created by a rotating tool, a disc forms which is ejected. Please implement safety measures.

Assembly parts

D _c mm	16	21	26	31	37
Clamping screw for insert Tightening torque	FS923 (Torx 8) 1,0 Nm	FS1005 (Torx 8) 1,0 Nm	FS920 (Torx 15) 2,5 Nm	FS359 (Torx 15) 2,5 Nm	FS1029 (Torx 20) 5,0 Nm

Accessories

D _c mm	16-21	26-31	37
Screwdriver	FS230 (Torx 8)	FS229 (Torx 15)	FS228 (Torx 20)

Exchangeable inserts

Designation	Sizes	P		M	K		S	
		HC		HC	HC		HC	
		WAP20	WKP25	WKP35	WTP35	WSP45	WSP45	WXP40
P28467	1-7	☺	☹	☹	☹	☹	☹	☹
P28469	1-7		☹	☹	☹	☹	☹	
P28475	1-7		☹	☹	☹	☹	☹	☹
P28477	1-7		☹	☹	☹	☹	☹	☹
P28479	1-7		☹	☹	☹	☹	☹	☹

HC = Coated carbide

WALTER SELECT

Best insert for:

☺
good

☹
moderate

☹
unfavourable

machining conditions

Drills B 4214

Xtra-tec® Insert Drill

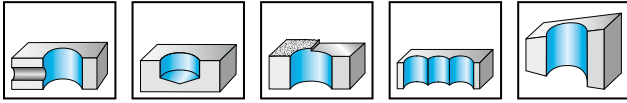

- diameter range 17-59 mm
- right-hand cutting
- drilling depth $4 \times D_c$

Tool	Designation	D_c mm	d_1 mm	d_4 mm	l_4 mm	l_5 mm	L_c mm	kg	No. of indexable inserts	Type
Cylindrical shank with flat in acc. with ISO 9768 	B4214.F25.17.Z1.068R-2	17	25	32	93	56	68	0,36	1 1	P484 . P-2R P484 . C-2R
	B4214.F25.18.Z1.072R-2	18	25	32	97	56	72	0,38	1 1	
	B4214.F25.19.Z1.076R-2	19	25	32	101	56	76	0,39	1 1	
	B4214.F25.20.Z1.080R-2	20	25	32	105	56	80	0,4	1 1	
	B4214.F25.21.Z1.084R-3	21	25	32	109	56	84	0,5	1 1	P484 . P-3R P484 . C-3R
	B4214.F25.22.Z1.088R-3	22	25	32	113	56	88	0,5	1 1	
	B4214.F25.23.Z1.092R-3	23	25	32	117	56	92	0,6	1 1	
	B4214.F25.24.Z1.096R-3	24	25	32	121	56	96	0,5	1 1	
	B4214.F25.25.Z1.100R-4	25	25	32	125	56	100	0,5	1 1	P484 . P-4R P484 . C-4R
	B4214.F32.26.Z1.104R-4	26	32	40	136	60	104	0,8	1 1	
	B4214.F32.27.Z1.108R-4	27	32	40	140	60	108	0,8	1 1	
	B4214.F32.28.Z1.112R-4	28	32	40	144	60	112	0,9	1 1	
	B4214.F32.29.Z1.116R-4	29	32	40	148	60	116	0,9	1 1	

Bodies, assembly parts and screwdrivers are included in the standard pack.

N.B.: where through bores are created by a rotating tool, a disc forms which is ejected. Please implement safety measures.

Assembly parts

D _c mm	17-20	21-24	25-29
Clamping screw for insert Tightening torque	FS2111 (Torx 7 IP) 0,9 Nm	FS1454 (Torx 8 IP) 1,2 Nm	FS1457 (Torx 9 IP) 2,0 Nm

Accessories

D _c mm	17-20	21-24	25-29
Torque screwdriver	FS2001	FS2001	FS2003
Interchangeable blade	FS2011 (Torx 7IP)	FS2012 (Torx 8IP)	FS2013 (Torx 9IP)

Exchangeable inserts

	Designation	Sizes	P					M		K			N	S	H	
			HC					HC		HC			HC	HC	HC	
			WKP25	WKP35	WSP45	WMP35	WXP45	WSP45	WMP35	WKP25	WKP35	WXK25	WNN25	WSP45	WMP35	WXP45
Outer insert	P4840P- . R-A57	1-4	☺	☹	☹			☹		☹	☹			☹		
	P4840P- . R-E57	1-4	☺	☹	☹			☹		☹	☹			☹		
	P4840P- . R-E67	1-4	☺	☹	☹			☹		☹	☹			☹		
	P4841P- . R-A57	1-4	☺	☹	☹			☹		☹	☹			☹		
	P4841P- . R-E57	1-4	☺	☹	☹			☹		☹	☹			☹		
Centre insert	P4841C- . R-A57	1-4														△
	P4841C- . R-E57	1-4														△
	P4840C- . R-E67	1-4														△

HC = Coated carbide

WALTER SELECT

Best insert for:

☺
good

☹
moderate

☹
unfavourable

machining conditions

Drills B 4214

Xtra-tec® Insert Drill

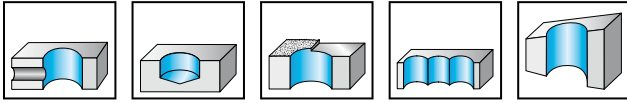

- diameter range 17-59 mm
- right-hand cutting
- drilling depth 4 x D_c

Tool	Designation	D _c mm	d ₁ mm	d ₄ mm	l ₄ mm	l ₅ mm	L _c mm	kg	No. of indexable inserts	Type
Cylindrical shank with flat in acc. with ISO 9768 	B4214.F32.30.Z1.120R-5	30	32	40	152	60	120	0,9	1 1	P484 . P-5R P484 . C-5R
	B4214.F32.31.Z1.124R-5	31	32	40	156	60	124	1	1 1	
	B4214.F32.32.Z1.128R-5	32	32	40	160	60	128	1	1 1	
	B4214.F32.33.Z1.132R-5	33	32	40	164	60	132	1,1	1 1	
	B4214.F32.34.Z1.136R-5	34	32	40	168	60	136	1,1	1 1	
	B4214.F32.35.Z1.140R-5	35	32	40	172	60	140	1,2	1 1	
	B4214.F32.36.Z1.144R-6	36	32	40	176	60	144	1,1	1 1	P484 . P-6R P484 . C-6R
	B4214.F40.37.Z1.148R-6	37	40	50	188	70	148	1,7	1 1	
	B4214.F40.38.Z1.152R-6	38	40	50	192	70	152	1,8	1 1	
	B4214.F40.39.Z1.156R-6	39	40	50	196	70	156	1,8	1 1	
	B4214.F40.40.Z1.160R-6	40	40	50	200	70	160	1,9	1 1	
	B4214.F40.41.Z1.164R-6	41	40	50	204	70	164	2	1 1	
	B4214.F40.42.Z1.168R-6	42	40	50	208	70	168	2,1	1 1	P484 . P-7R P484 . C-7R
	B4214.F40.43.Z1.172R-7	43	40	50	212	70	172	2	1 1	
	B4214.F40.44.Z1.176R-7	44	40	50	216	70	176	2,1	1 1	
	B4214.F40.45.Z1.180R-7	45	40	50	220	70	180	2,2	1 1	
	B4214.F40.46.Z1.184R-7	46	40	50	224	70	184	2,3	1 1	
	B4214.F40.47.Z1.188R-7	47	40	50	228	70	188	2,4	1 1	
	B4214.F40.48.Z1.192R-7	48	40	50	232	70	192	2,5	1 1	P484 . P-8R P484 . C-8R
	B4214.F40.49.Z1.196R-7	49	40	50	236	70	196	2,7	1 1	
	B4214.F40.50.Z1.200R-7	50	40	50	240	70	200	2,8	1 1	
	B4214.F40.51.Z1.204R-8	51	40	50	244	70	204	2,8	1 1	
	B4214.F40.52.Z1.208R-8	52	40	50	248	70	208	2,9	1 1	
	B4214.F40.53.Z1.212R-8	53	40	50	252	70	212	3	1 1	
	B4214.F40.54.Z1.216R-8	54	40	50	256	70	216	3,2	1 1	P484 . P-8R P484 . C-8R
	B4214.F40.55.Z1.220R-8	55	40	50	260	70	220	3,3	1 1	
	B4214.F40.56.Z1.224R-8	56	40	50	264	70	224	3,4	1 1	
	B4214.F40.57.Z1.228R-8	57	40	50	268	70	228	3,6	1 1	
	B4214.F40.58.Z1.232R-8	58	40	50	272	70	232	3,8	1 1	
	B4214.F40.59.Z1.236R-8	59	40	50	276	70	236	3,9	1 1	

Bodies, assembly parts and screwdrivers are included in the standard pack.

N.B.: where through bores are created by a rotating tool, a disc forms which is ejected. Please implement safety measures.

Assembly parts

D _c mm	30-35	36-42	43-59
Clamping screw for insert Tightening torque	FS2080 (Torx 15 IP) 2,5 Nm	FS1453 (Torx 15 IP) 3,5 Nm	FS1495 (Torx 20 IP) 5,0 Nm

Accessories

D _c mm	30-42	43-59
Torque screwdriver	FS2003	FS2003
Interchangeable blade	FS2014 (Torx 15IP)	FS2015 (Torx 20IP)

Exchangeable inserts

	Designation	Sizes	P					M		K			N	S	H	HC
			HC					HC		HC			HC	HC		
			WKP25	WKP35	WSP45	WMP35	WXP45	WSP45	WMP35	WKP25	WKP35	WXX25	WNN25	WSP45	WMP35	WXP45
Outer insert	P4840P-. R-A57	1-4	☺	☺	☺			☺		☺	☺					
	P4840P-. R-E57	1-4	☺	☺	☺			☺		☺	☺					
	P4840P-. R-E67	1-4		☺	☺			☺								
	P4841P-. R-A57	1-4	☺	☺	☺			☺		☺	☺					
	P4841P-. R-E57	1-4	☺	☺	☺			☺		☺	☺					
Centre insert	P4841C-. R-A57	1-4														△
	P4841C-. R-E57	1-4														△
	P4840C-. R-E67	1-4														△

HC = Coated carbide

WALTER SELECT

Best insert for:

☺
good

☹
moderate

☹
unfavourable

machining conditions

Drills B 3214

Walter Stardrill

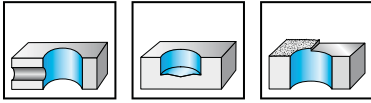

- diameter range 10-18 mm
- right-hand cutting
- drilling depth $4 \times D_c$

Tool	Designation	D_c mm	d_1 mm	l_4 mm	l_5 mm	L_c mm	Z	kg	No. of indexable inserts	Type
Shank ISO 3338/2 or DIN 1835 Form B, turned 90° DIN 6535 Form HE 	B3214.DF.10.0.Z01.40R	10	16	51	49	40	1	0,09	2	LCMX 0502...
	B3214.DF.10,5.Z01.42R	10,5	16	53	49	42	1	0,1	2	
	B3214.DF.11,0.Z01.44R	11	16	56	49	44	1	0,1	2	
	B3214.DF.11,5.Z01.46R	11,5	16	58	49	46	1	0,1	2	
	B3214.DF.12,0.Z01.48R	12	16	60	49	48	1	0,11	2	
	B3214.DF.12,5.Z01.50R	12,5	16	62	49	50	1	0,11	2	
	B3214.DF.13,0.Z01.52R	13	16	65	49	52	1	0,12	2	LCMX 06T2...
	B3214.DF.13,5.Z01.54R	13,5	16	67	49	54	1	0,12	2	
	B3214.DF.14,0.Z01.56R	14	16	70	49	56	1	0,12	2	
	B3214.DF.14,5.Z01.58R	14,5	16	72	49	58	1	0,13	2	
	B3214.DF.15,0.Z01.60R	15	16	74	49	60	1	0,13	2	
	B3214.DF.15,5.Z01.62R	15,5	16	77	49	62	1	0,14	2	
	B3214.DF.16,0.Z01.64R	16	16	78	49	64	1	0,14	2	
	B3214.DF.16,5.Z01.66R	16,5	16	82	49	66	1	0,15	2	
	B3214.DF.17,5.Z01.70R	17,5	16	85	49	70	1	0,16	2	
	B3214.DF.18,0.Z01.72R	18	16	88	49	72	1	0,17	2	

Bodies and assembly parts are included in the scope of delivery.

Possible X adjustment for boring into solid material greater than the nominal diameter:



$X = +0.2 \text{ mm} / -0.1 \text{ mm} \rightarrow \Delta D = +0.4 \text{ mm} / -0.2 \text{ mm}$

N.B.: where through bores are created by a rotating tool, a disc forms which is ejected. Please implement safety measures.

Assembly parts

D _c mm	10-13,5	14-15,5	16-18
 Clamping screw for insert Tightening torque	FS1012 (Torx 6) 0,4 Nm	FS1004 (Torx 7) 0,6 Nm	FS1020 (Torx 7) 0,6 Nm

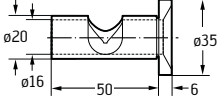
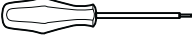
Accessories

D _c mm	10-13,5	14-18
 Eccentric sleeve	FS1207	FS1207
 Screwdriver	FS1063 (Torx 6)	FS309 (Torx 7)
 Clamping screw for collet chuck	FS1209	FS1209

Exchangeable inserts

Designation	Length mm	Width mm	P		M	K		S	HC	
			HC		HC	HC		HC	HC	
			WAP20	WKP25	WKP35	WTP35	WSP45	WAK15	WKP25	WKP35
 LCMX 050203-B57	5,2	4,0	☹	☹	☹	☹	☹	☹	☹	☹
LCMX 050203-D57	5,2	4,0	☹	☹	☹	☹	☹	☹	☹	☹
LCMX 050203-E57	5,2	4,0	☹	☹	☹	☹	☹	☹	☹	☹
LCMX 06T204-B57	6,6	5,2	☹	☹	☹	☹	☹	☹	☹	☹
LCMX 06T204-D57	6,6	5,2	☹	☹	☹	☹	☹	☹	☹	☹
LCMX 06T204-E57	6,6	5,2	☹	☹	☹	☹	☹	☹	☹	☹

HC = Coated carbide

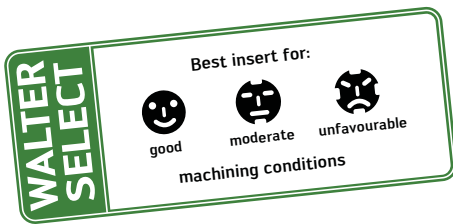

Drills B 4015

Xtra-tec®

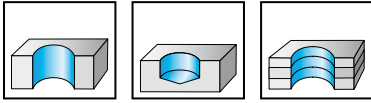

- diameter range 12-37.99 mm
- right-hand cutting
- drilling depth 5 x D_C

Tool	Designation	D _C mm	d ₁ mm	d ₄ mm	l ₄ mm	l ₅ mm	L _C mm	Z	kg	No. of indexable inserts	Type	
Cylindrical shank with flat in acc. with ISO 9767 	B4015.F20.12,0.Z02.60R*	12	20	30	92	50	62	2	0,22	1	P 600 .- D12 . . R	
	B4015.F20.13,0.Z02.65R	13	20	30	98	50	67	2	0,25	1	P 600 .- D13 . . R	
	B4015.F20.14,0.Z02.70R	14	20	30	104	50	73	2	0,25	1	P 600 .- D14 . . R	
	B4015.F20.15,0.Z02.75R	15	20	30	110	50	78	2	0,26	1	P 600 .- D15 . . R	
	B4015.F20.16,0.Z02.80R	16	20	30	116	50	83	2	0,28	1	P 600 .- D16 . . R	
	B4015.F20.17,0.Z02.85R	17	20	30	122	50	88	2	0,26	1	P 600 .- D17 . . R	
	B4015.F20.18,0.Z02.90R	18	20	30	128	50	93	2	0,3	1	P 600 .- D18 . . R	
	B4015.F20.19,0.Z02.95R	19	20	30	134	50	98	2	0,32	1	P 600 .- D19 . . R	
	B4015.F20.20,0.Z02.100R	20	20	30	140	50	104	2	0,35	1	P 600 .- D20 . . R	
	B4015.F20.21,0.Z02.105R	21	20	30	146	50	109	2	0,38	1	P 600 .- D21 . . R	
	B4015.F25.22,0.Z02.110R	22	25	35	153	56	114	2	0,5	1	P 600 .- D22 . . R	
	B4015.F25.23,0.Z02.115R	23	25	35	159	56	119	2	0,6	1	P 600 .- D23 . . R	
	B4015.F25.24,0.Z02.120R	24	25	35	165	56	124	2	0,6	1	P 600 .- D24 . . R	
	B4015.F25.25,0.Z02.125R	25	25	35	171	56	130	2	0,7	1	P 600 .- D25 . . R	
	B4015.F25.26,0.Z02.130R	26	25	35	177	56	135	2	0,7	1	P 600 .- D26 . . R	
	B4015.F25.27,0.Z02.135R	27	25	35	183	56	140	2	0,7	1	P 600 .- D27 . . R	
	B4015.F32.28,0.Z02.140R	28	32	42	190	60	145	2	1	1	P 600 .- D28 . . R	
	B4015.F32.29,0.Z02.145R	29	32	42	196	60	150	2	1,1	1	P 600 .- D29 . . R	
	B4015.F32.30,0.Z02.150R	30	32	42	202	60	155	2	1,1	1	P 600 .- D30 . . R	
	B4015.F32.31,0.Z02.155R	31	32	42	208	60	161	2	1,2	1	P 600 .- D31 . . R	
	B4015.F40.32,0.Z02.160R	32	40	50	214	70	166	2	1,5	1	P 600 .- D32 . . R	
	B4015.F40.33,0.Z02.165R	33	40	50	220	70	171	2	1,6	1	P 600 .- D33 . . R	
	B4015.F40.34,0.Z02.170R	34	40	50	226	70	176	2	1,7	1	P 600 .- D34 . . R	
	B4015.F40.35,0.Z02.175R	35	40	50	232	70	181	2	1,8	1	P 600 .- D35 . . R	
	B4015.F40.36,0.Z02.180R	36	40	50	238	70	187	2	1,8	1	P 600 .- D36 . . R	
	B4015.F40.37,0.Z02.185R	37	40	50	244	70	192	2	1,9	1	P 600 .- D37 . . R	
	Cylindrical shank with collar 	B4015.ZB20.12,0.Z02.60R*	12	20	30	92	50	62	2	0,22	1	P 600 .- D12 . . R
		B4015.ZB20.13,0.Z02.65R	13	20	30	98	50	67	2	0,24	1	P 600 .- D13 . . R
B4015.ZB20.14,0.Z02.70R		14	20	30	104	50	73	2	0,25	1	P 600 .- D14 . . R	
B4015.ZB20.15,0.Z02.75R		15	20	30	110	50	78	2	0,27	1	P 600 .- D15 . . R	
B4015.ZB20.16,0.Z02.80R		16	20	30	116	50	83	2	0,28	1	P 600 .- D16 . . R	
B4015.ZB20.17,0.Z02.85R		17	20	30	122	50	88	2	0,3	1	P 600 .- D17 . . R	
B4015.ZB20.18,0.Z02.90R		18	20	30	128	50	93	2	0,3	1	P 600 .- D18 . . R	
B4015.ZB20.19,0.Z02.95R		19	20	30	134	50	98	2	0,33	1	P 600 .- D19 . . R	
B4015.ZB20.20,0.Z02.100R		20	20	30	140	50	104	2	0,36	1	P 600 .- D20 . . R	
B4015.ZB20.21,0.Z02.105R		21	20	30	146	50	109	2	0,39	1	P 600 .- D21 . . R	
B4015.ZB25.22,0.Z02.110R		22	25	35	153	56	114	2	0,5	1	P 600 .- D22 . . R	
B4015.ZB25.23,0.Z02.115R		23	25	35	159	56	119	2	0,6	1	P 600 .- D23 . . R	
B4015.ZB25.24,0.Z02.120R		24	25	35	165	56	124	2	0,6	1	P 600 .- D24 . . R	
B4015.ZB25.25,0.Z02.125R		25	25	35	171	56	130	2	0,7	1	P 600 .- D25 . . R	
B4015.ZB25.26,0.Z02.130R		26	25	35	177	56	135	2	0,7	1	P 600 .- D26 . . R	
B4015.ZB25.27,0.Z02.135R		27	25	35	183	56	140	2	0,8	1	P 600 .- D27 . . R	
B4015.ZB32.28,0.Z02.140R		28	32	42	190	60	145	2	1	1	P 600 .- D28 . . R	
B4015.ZB32.29,0.Z02.145R	29	32	42	196	60	150	2	1,1	1	P 600 .- D29 . . R		
B4015.ZB32.30,0.Z02.150R	30	32	42	202	60	155	2	1,1	1	P 600 .- D30 . . R		
B4015.ZB32.31,0.Z02.155R	31	32	42	208	60	161	2	1,2	1	P 600 .- D31 . . R		





Bodies and assembly parts are included in the scope of delivery.

* Example: inserts with D_C=12.00 mm up to and incl. 12.99 mm can fitted into this tool.





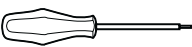

Assembly parts

D _c mm	12-13	14-15	16-17	18-19	20-21	22-24	25	26-27	28-33	34-37
 Clamping screw for insert Tightening torque	FS1396 (Torx 7 IP) 1,2 Nm	FS1397 (Torx 8 IP) 2,0 Nm	FS1398 (Torx 8 IP) 2,0 Nm	FS1399 (Torx 15 IP) 4,0 Nm	FS1400 (Torx 20 IP) 5,0 Nm	FS1401 (Torx 20 IP) 5,0 Nm	FS1402 (Torx 20 IP) 5,0 Nm	FS1403 (Torx 25 IP) 5,5 Nm	FS1404 (Torx 25 IP) 5,5 Nm	FS2159 (Torx 25 IP) 5,5 Nm

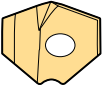
Accessories

D _c mm	12-13	14-17	18-19	20-25	26-37
 Torque screwdriver	FS2001	FS2003	FS2003	FS2003	
 Interchangeable blade	FS2011 (Torx 7IP)	FS2012 (Torx 8IP)	FS2014 (Torx 15IP)	FS2015 (Torx 20IP)	FS2049 (Torx 25IP)
 Screwdriver	FS1490 (Torx 7IP)	FS1483 (Torx 8IP)	FS1485 (Torx 15IP)	FS1486 (Torx 20IP)	FS1487 (Torx 25IP)
 T-handle torque wrench					FS2041

Exchangeable inserts

Designation	Diameter range	P		M		K			N		S		H	
		HC		HC		HC			HC		HC			
		WMP35	WXP45	WKP25	WKP35	WSP45	WMP35	WSP45	WKK25	WKP25	WKP35	WNN25	WMP35	WSP45
 P6001-D ..	12–31,99													
P6002-D ..	12–31,99													
P6003-D ..	12–37,99													
P6004-D ..	12–31,50													

HC = Coated carbide

WALTER SELECT

Best insert for:



good



moderate



unfavourable

machining conditions

Drills B 4215

Xtra-tec® Insert Drill

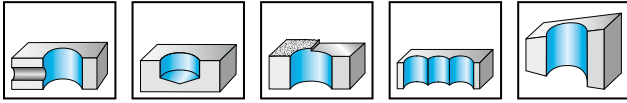

- diameter range 17-59 mm
- right-hand cutting
- drilling depth $5 \times D_c$

Tool	Designation	D_c mm	d_1 mm	d_4 mm	l_4 mm	l_5 mm	L_c mm	kg	No. of indexable inserts	Type
Cylindrical shank with flat in acc. with ISO 9768	B4215.F25.17.Z1.085R-2	17	25	32	110	56	85	0,38	1 1	P484 . P-2R P484 . C-2R
	B4215.F25.18.Z1.090R-2	18	25	32	115	56	90	0,4	1 1	
	B4215.F25.19.Z1.095R-2	19	25	32	120	56	95	0,42	1 1	
	B4215.F25.20.Z1.100R-2	20	25	32	125	56	100	0,44	1 1	P484 . P-3R P484 . C-3R
	B4215.F25.21.Z1.105R-3	21	25	32	130	56	105	0,5	1 1	
	B4215.F25.22.Z1.110R-3	22	25	32	135	56	110	0,49	1 1	
	B4215.F25.23.Z1.115R-3	23	25	32	140	56	115	0,5	1 1	
	B4215.F25.24.Z1.120R-3	24	25	32	145	56	120	0,6	1 1	
	B4215.F25.25.Z1.125R-4	25	25	32	150	56	125	0,6	1 1	
	B4215.F32.26.Z1.130R-4	26	32	40	162	60	130	0,9	1 1	
P484 . P-4R P484 . C-4R	B4215.F32.27.Z1.135R-4	27	32	40	167	60	135	0,9	1 1	
	B4215.F32.28.Z1.140R-4	28	32	40	172	60	140	0,9	1 1	
	B4215.F32.29.Z1.145R-4	29	32	40	177	60	145	1	1 1	

Bodies, assembly parts and screwdrivers are included in the standard pack.

N.B.: where through bores are created by a rotating tool, a disc forms which is ejected. Please implement safety measures.

Assembly parts

D _c mm	17-20	21-24	25-29
Clamping screw for insert Tightening torque	FS2111 (Torx 7 IP) 0,9 Nm	FS1454 (Torx 8 IP) 1,2 Nm	FS1457 (Torx 9 IP) 2,0 Nm

Accessories

D _c mm	17-20	21-24	25-29
Torque screwdriver	FS2001	FS2001	FS2003
Interchangeable blade	FS2011 (Torx 7IP)	FS2012 (Torx 8IP)	FS2013 (Torx 9IP)

Exchangeable inserts

	Designation	Sizes	P					M		K			N	S	H	HC	
			HC					HC		HC			HC	HC		HC	
			WKP25	WKP35	WSP45	WMP35	WXP45	WSP45	WMP35	WKP25	WKP35	WXK25	WNN25	WSP45	WMP35	WXP45	
Outer insert	P4840P- . R-A57	1-4	☺	☺	☺			☺		☺	☺			☺			
	P4840P- . R-E57	1-4	☺	☺	☺			☺		☺	☺			☺			
	P4840P- . R-E67	1-4		☺	☺			☺						☺			
	P4841P- . R-A57	1-4	☺	☺	☺			☺		☺	☺			☺			
	P4841P- . R-E57	1-4	☺	☺	☺			☺		☺	☺			☺			
Centre insert	P4841C- . R-A57	1-4															△
	P4841C- . R-E57	1-4															△
	P4840C- . R-E67	1-4															△

HC = Coated carbide

WALTER SELECT

Best insert for:

☺
good

☹
moderate

☹
unfavourable

machining conditions

Drills B 4215

Xtra-tec® Insert Drill

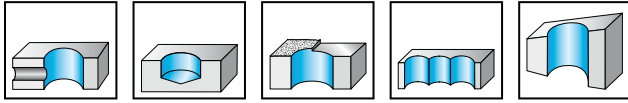

- diameter range 17-59 mm
- right-hand cutting
- drilling depth 5 x D_C

Tool	Designation	D _C mm	d ₁ mm	d ₄ mm	l ₄ mm	l ₅ mm	L _C mm	kg	No. of indexable inserts	Type
Cylindrical shank with flat in acc. with ISO 9768 	B4215.F32.30.Z1.150R-5	30	32	40	182	60	150	1	1 1	P484 . P-5R P484 . C-5R
	B4215.F32.31.Z1.155R-5	31	32	40	187	60	155	1,1	1 1	
	B4215.F32.32.Z1.160R-5	32	32	40	192	60	160	1,1	1 1	
	B4215.F32.33.Z1.165R-5	33	32	40	197	60	165	1,2	1 1	
	B4215.F32.34.Z1.170R-5	34	32	40	202	60	170	1,3	1 1	
	B4215.F32.35.Z1.175R-5	35	32	40	207	60	175	1,3	1 1	
	B4215.F32.36.Z1.180R-6	36	32	40	212	60	180	1,3	1 1	P484 . P-6R P484 . C-6R
	B4215.F40.37.Z1.185R-6	37	40	50	225	70	185	1,9	1 1	
	B4215.F40.38.Z1.190R-6	38	40	50	230	70	190	1,9	1 1	
	B4215.F40.39.Z1.195R-6	39	40	50	235	70	195	2	1 1	
	B4215.F40.40.Z1.200R-6	40	40	50	240	70	200	2,1	1 1	
	B4215.F40.41.Z1.205R-6	41	40	50	245	70	205	2,2	1 1	
	B4215.F40.42.Z1.210R-6	42	40	50	250	70	210	2,3	1 1	P484 . P-7R P484 . C-7R
	B4215.F40.43.Z1.215R-7	43	40	50	255	70	215	2,3	1 1	
	B4215.F40.44.Z1.220R-7	44	40	50	260	70	220	2,4	1 1	
	B4215.F40.45.Z1.225R-7	45	40	50	265	70	225	2,6	1 1	
	B4215.F40.46.Z1.230R-7	46	40	50	270	70	230	2,7	1 1	
	B4215.F40.47.Z1.235R-7	47	40	50	275	70	235	2,8	1 1	
	B4215.F40.48.Z1.240R-7	48	40	50	280	70	240	2,9	1 1	P484 . P-8R P484 . C-8R
	B4215.F40.49.Z1.245R-7	49	40	50	285	70	245	3	1 1	
	B4215.F40.50.Z1.250R-7	50	40	50	290	70	250	3,2	1 1	
	B4215.F40.51.Z1.255R-8	51	40	50	295	70	255	3,2	1 1	
	B4215.F40.52.Z1.260R-8	52	40	50	300	70	260	3,4	1 1	
	B4215.F40.53.Z1.265R-8	53	40	50	305	70	265	3,5	1 1	
	B4215.F40.54.Z1.270R-8	54	40	50	310	70	270	3,7	1 1	P484 . P-8R P484 . C-8R
	B4215.F40.55.Z1.275R-8	55	40	50	315	70	275	3,8	1 1	
	B4215.F40.56.Z1.280R-8	56	40	50	320	70	280	4	1 1	
	B4215.F40.57.Z1.285R-8	57	40	50	325	70	285	4,2	1 1	
	B4215.F40.58.Z1.290R-8	58	40	50	330	70	290	4,4	1 1	
	B4215.F40.59.Z1.295R-8	59	40	50	335	70	295	4,6	1 1	

Bodies, assembly parts and screwdrivers are included in the standard pack.

N.B.: where through bores are created by a rotating tool, a disc forms which is ejected. Please implement safety measures.

Assembly parts

D _c mm	30-35	36-42	43-59
Clamping screw for insert Tightening torque	FS2080 (Torx 15 IP) 2,5 Nm	FS1453 (Torx 15 IP) 3,5 Nm	FS1495 (Torx 20 IP) 5,0 Nm

Accessories

D _c mm	30-42	43-59
Torque screwdriver	FS2003	FS2003
Interchangeable blade	FS2014 (Torx 15IP)	FS2015 (Torx 20IP)

Exchangeable inserts

Designation	Sizes	P					M		K			N	S	H	HC	
		HC					HC		HC			HC	HC		HC	
		WKP25	WKP35	WSP45	WMP35	WXP45	WSP45	WMP35	WKP25	WKP35	WKK25	WNN25	WSP45	WMP35	WXP45	
Outer insert	P4840P- . R-A57	☺	☺	☺			☺	☺	☺			☺				
	P4840P- . R-E57	☺	☺	☺			☺	☺	☺			☺				
	P4840P- . R-E67		☺	☺			☺					☺				
	P4841P- . R-A57	☺	☺	☺			☺	☺	☺			☺				
	P4841P- . R-E57	☺	☺	☺			☺	☺	☺			☺				
Centre insert	P4841C- . R-A57															△
	P4841C- . R-E57															△
	P4840C- . R-E67															△

HC = Coated carbide
HW = Uncoated carbide

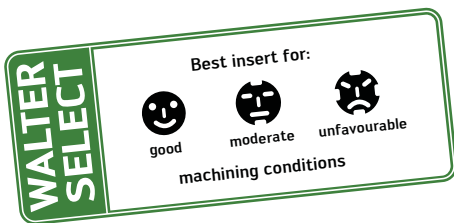

Drills B 4017

Xtra-tec®

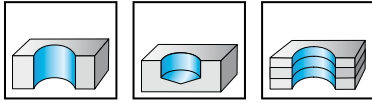

- diameter range 12-31 mm
- right-hand cutting
- drilling depth 7 x D_C

Tool	Designation	D _C mm	d ₁ mm	d ₄ mm	l ₄ mm	l ₅ mm	L _C mm	Z	kg	No. of indexable inserts	Type
Cylindrical shank with flat in acc. with ISO 9767 	B4017.F20.12,0.Z02.84R	12	20	30	116	50	86	2	0,23	1	P 600 .- D12 . . R
	B4017.F20.13,0.Z02.91R	13	20	30	124	50	93	2	0,25	1	P 600 .- D13 . . R
	B4017.F20.14,0.Z02.98R	14	20	30	132	50	101	2	0,27	1	P 600 .- D14 . . R
	B4017.F20.15,0.Z02.105R	15	20	30	140	50	108	2	0,5	1	P 600 .- D15 . . R
	B4017.F20.16,0.Z02.112R	16	20	30	148	50	115	2	0,31	1	P 600 .- D16 . . R
	B4017.F20.17,0.Z02.119R	17	20	30	156	50	122	2	0,35	1	P 600 .- D17 . . R
	B4017.F20.18,0.Z02.126R	18	20	30	164	50	129	2	0,34	1	P 600 .- D18 . . R
	B4017.F20.19,0.Z02.133R	19	20	30	172	50	136	2	0,37	1	P 600 .- D19 . . R
	B4017.F20.20,0.Z02.140R	20	20	30	180	50	144	2	0,41	1	P 600 .- D20 . . R
	B4017.F20.21,0.Z02.147R	21	20	30	188	50	151	2	0,45	1	P 600 .- D21 . . R
	B4017.F25.22,0.Z02.154R	22	25	35	197	56	158	2	0,6	1	P 600 .- D22 . . R
	B4017.F25.23,0.Z02.161R	23	25	35	205	56	165	2	0,7	1	P 600 .- D23 . . R
	B4017.F25.24,0.Z02.168R	24	25	35	213	56	172	2	0,7	1	P 600 .- D24 . . R
	B4017.F25.25,0.Z02.175R	25	25	35	221	56	180	2	0,8	1	P 600 .- D25 . . R
	B4017.F25.26,0.Z02.182R	26	25	35	229	56	187	2	0,8	1	P 600 .- D26 . . R
	B4017.F25.27,0.Z02.189R	27	25	35	237	56	194	2	0,9	1	P 600 .- D27 . . R
	B4017.F32.28,0.Z02.196R	28	32	42	246	60	201	2	1,2	1	P 600 .- D28 . . R
	B4017.F32.29,0.Z02.203R	29	32	42	254	60	208	2	1,2	1	P 600 .- D29 . . R
	B4017.F32.30,0.Z02.210R	30	32	42	262	60	215	2	1,3	1	P 600 .- D30 . . R
	B4017.F32.31,0.Z02.217R	31	32	42	270	60	223	2	1,4	1	P 600 .- D31 . . R
	Cylindrical shank with collar 	B4017.ZB20.12,0.Z02.84R*	12	20	30	116	50	86	2	0,24	1
B4017.ZB20.13,0.Z02.91R		13	20	30	124	50	93	2	0,26	1	P 600 .- D13 . . R
B4017.ZB20.14,0.Z02.98R		14	20	30	132	50	101	2	0,27	1	P 600 .- D14 . . R
B4017.ZB20.15,0.Z02.105R		15	20	30	140	50	108	2	0,31	1	P 600 .- D15 . . R
B4017.ZB20.16,0.Z02.112R		16	20	30	148	50	115	2	0,31	1	P 600 .- D16 . . R
B4017.ZB20.17,0.Z02.119R		17	20	30	156	50	122	2	0,34	1	P 600 .- D17 . . R
B4017.ZB20.18,0.Z02.126R		18	20	30	164	50	129	2	0,34	1	P 600 .- D18 . . R
B4017.ZB20.19,0.Z02.133R		19	20	30	172	50	136	2	0,37	1	P 600 .- D19 . . R
B4017.ZB20.20,0.Z02.140R		20	20	30	180	50	144	2	0,41	1	P 600 .- D20 . . R
B4017.ZB20.21,0.Z02.147R		21	20	30	188	50	151	2	0,45	1	P 600 .- D21 . . R
B4017.ZB25.22,0.Z02.154R		22	25	35	197	56	158	2	0,6	1	P 600 .- D22 . . R
B4017.ZB25.23,0.Z02.161R		23	25	35	205	56	165	2	0,7	1	P 600 .- D23 . . R
B4017.ZB25.24,0.Z02.168R		24	25	35	213	56	172	2	0,7	1	P 600 .- D24 . . R
B4017.ZB25.25,0.Z02.175R		25	25	35	221	56	180	2	0,8	1	P 600 .- D25 . . R
B4017.ZB25.26,0.Z02.182R		26	25	35	229	56	187	2	0,8	1	P 600 .- D26 . . R
B4017.ZB25.27,0.Z02.189R		27	25	35	237	56	194	2	0,9	1	P 600 .- D27 . . R
B4017.ZB32.28,0.Z02.196R		28	32	42	246	60	201	2	1,2	1	P 600 .- D28 . . R
B4017.ZB32.29,0.Z02.203R		29	32	42	254	60	208	2	1,3	1	P 600 .- D29 . . R
B4017.ZB32.30,0.Z02.210R		30	32	42	262	60	215	2	1,3	1	P 600 .- D30 . . R
B4017.ZB32.31,0.Z02.217R		31	32	42	270	60	223	2	1,4	1	P 600 .- D31 . . R

When using this drill, a centre hole produced by a B 4013 or NC centring drill is recommended.





Bodies and assembly parts are included in the scope of delivery.

* Example: inserts with D_C=12.00 mm up to and incl. 12.99 mm can fitted into this tool.

Assembly parts

D _c mm	12-13	14-15	16-17	18-19	20-21	22-23	24-25	26-27	28-31
 Clamping screw for insert Tightening torque	FS1396 (Torx 7IP) 1,2 Nm	FS1397 (Torx 8IP) 2,0 Nm	FS1398 (Torx 8IP) 2,0 Nm	FS1399 (Torx 15IP) 4,0 Nm	FS1400 (Torx 20IP) 5,0 Nm	FS1401 (Torx 20IP) 5,0 Nm	FS1402 (Torx 20IP) 5,0 Nm	FS1403 (Torx 25IP) 5,5 Nm	FS1404 (Torx 25IP) 5,5 Nm

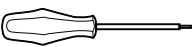
Accessories

D _c mm	12-13	14-17	18-19	20-25	26-31
 Torque screwdriver	FS2001	FS2003	FS2003	FS2003	
 Interchangeable blade	FS2011 (Torx 7IP)	FS2012 (Torx 8IP)	FS2014 (Torx 15IP)	FS2015 (Torx 20IP)	FS2049 (Torx 25IP)
 Screwdriver	FS1490 (Torx 7IP)	FS1483 (Torx 8IP)	FS1485 (Torx 15IP)	FS1486 (Torx 20IP)	FS1487 (Torx 25IP)
 T-handle torque wrench					FS2041

Exchangeable inserts

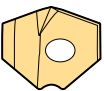
Designation	Diameter range	P			M		K			N		S		H
		HC			HC		HC			HC		HC		
		WMP35	WXP45	WKP25	WKP35	WSP45	WMP35	WSP45	WXK25	WKP25	WKP35	WNN25	WMP35	WSP45
 P6001-D ..	12-31,99		☹											
P6002-D ..	12-31,99							☹						
P6003-D ..	12-31,99	☹				☹								
P6004-D ..	12-31,50										☹			

HC = Coated carbide

WALTER SELECT

Best insert for:

good



moderate

unfavourable

machining conditions

Drills B 4010

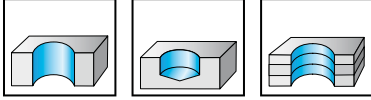
Xtra-tec® Point Drill



- diameter range 18-24 mm
- right-hand cutting
- drilling depth 10 x D_c

Tool	Designation	D _c mm	d ₁ mm	d ₄ mm	l ₄ mm	l ₅ mm	L _c mm	Z	kg	No. of indexable inserts	Type
Cylindrical shank with collar	B4010.F20.18,0.Z02.180R	18	20	30	218	50	183	2	0,45	1	P 600 . - D18 . . R
	B4010.F20.20,0.Z02.200R	20	20	30	240	50	204	2	0,5	1	P 600 . - D20 . . R
	B4010.F25.22,0.Z02.220R	22	25	35	263	56	224	2	0,8	1	P 600 . - D22 . . R
	B4010.F25.24,0.Z02.240R	24	25	35	285	56	244	2	0,9	1	P 600 . - D24 . . R

When using this drill, a centre hole produced by a B 4013 or NC centring drill is recommended.
Bodies and assembly parts are included in the scope of delivery.

Assembly parts

D _c mm	18	20	22	24	
	Clamping screw for insert Tightening torque	FS1399 (Torx 15 IP) 4,0 Nm	FS1400 (Torx 20 IP) 5,0 Nm	FS1401 (Torx 20 IP) 5,0 Nm	FS1402 (Torx 20 IP) 5,0 Nm

Accessories

D _c mm	18	20-24
	Torque screwdriver FS2003	FS2003
	Interchangeable blade FS2014 (Torx 15IP)	FS2015 (Torx 20IP)
	Screwdriver FS1485 (Torx 15IP)	FS1486 (Torx 20IP)

Exchangeable inserts

Designation	Diameter range	P		M		K			N	S	H			
		HC		HC		HC			HC	HC				
		WMP35	WXP45	WKP25	WKP35	WSP45	WMP35	WSP45	WXK25	WKP25	WKP35	WNN25	WMP35	WSP45
P6001-D ..	12-31,99		☒											
P6002-D ..	12-31,99							☒						
P6003-D ..	12-37,99	☒											☒	
P6004-D ..	12-31,50										☒			

HC = Coated carbide

WALTER SELECT

Best insert for:

good

moderate

unfavourable

machining conditions

Walter Select – boring / precision boring and reaming

Tool type	Boring tools			Precision boring tools	
	Walter Boring ^{MEDIUM}		Walter Boring ^{MAXI}	Walter Precision ^{MINI}	
Boring & reaming tools (R) = r.h. cutting	B 3220 B 3221	B 3220 B 3221	B 3220 B 3224	B 3230	B 3230 B 4030
Dia. range [mm]	20–153	20–153	150–640	2–6	5,8–45,5
Page	C 92	C 92	C 96	C 100	C 100
P Steel	••	••	••	••	••
M Stainless steel	••	••	••	••	••
K Cast iron	••	••	••	••	••
N NF metals	•	•	•	•	••
S Difficult-to-machine materials	••	••	••	•	••
H Hard materials					•
O Other					•
Basic insert shape				—	
Insert types	CC .. 0602 .. CC .. 09T3 .. CC .. 1204 ..	WC .. 0302 .. WC .. 0402 .. WC .. 06T3 .. WC .. 0804 ..	CC .. 1204 ..	—	WC .. 0201 .. WC .. 0302 .. WC .. 0402 ..
Cutting depth [mm]	max. 12	max. 8	max. 12	max. 0.5	max. 0.5

Precision boring tools						Reaming tools	
Walter Precision ^{MEDIUM}			Walter Precision ^{MAXI}				
B 3230	B 3230	B 4030	B 3230 B 3234	B 4035	R 4060	R 4061	
		Xtra-tec[®]		Xtra-tec[®]			
20-153	20-153	33-153	150-640	3-124	6-25	8-25	
C 108	C 108	C 110	C 112	C 116	C 122	C 124	
••	••	••	••	••	••	••	
••	••	••	••	••	••	••	
••	••	••	••	••	••	••	
••	••	••	••	••			
•	•		•	•			
•	•	•	•	•			
CP...0502... CC...0602...	WC...0302... WC...0402... WC...0503...	WC...0302... WC...0402... CP...0502... CC...0602...	CC...0602.../ WC...0503...	WC...0302 WC...0402	P 6500...	P 6500...	
max. 1	max. 1	max. 1	max. 1	max. 1			



Two flute boring tool

B 3220 / B 3221

Walter Boring^{MEDIUM}

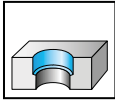

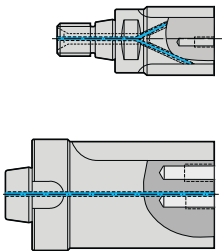

- Ø 20–41 mm
- κ = 90°
- Z = 2

Basic body





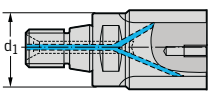

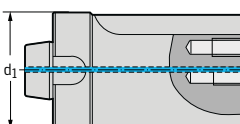

Cartridge with C insert

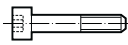

Tool	Designation	d ₁ mm	D _c mm	Designation	Type
NCT ScrewFit  	B 3221G.T18.20–27.Z2	T 18	20–24	EB 401.CC06	CC . . 0602 . .
	B 3221G.T22.26–33.Z2		23–27	EB 402.CC06	
	B 3220G.T28.33–41.Z2	T 22	26–33	EB 403.CC06	
	B 3220G.T28.33–41.Z2	T 28	33–41	EB 205–206.CC06	
Modular adaptor 	B 3221G.N2.020-027.Z2	NCT 25	20–24	EB 401.CC06	CC . . 0602 . .
	B 3221G.N2.026-035.Z2		23–27	EB 402.CC06	
	B 3220G.N3.033-044.Z2	NCT 25	26–33	EB 403.CC06	
	B 3220G.N3.033-044.Z2	NCT 32	33–41	EB 205–206.CC06	

For assembly aids, see page G 105.
Bodies and assembly parts are included in the scope of delivery.

Assembly parts	D _c min–max [mm]			
	20–27	26–33	33–41	
	Adjusting screw	FS 1103 (SW 1,3)	FS 1104 (SW 1,3)	FS 1105 (SW 1,5)
	Spring washer	FS 1098		FS 1099
	Clamping screw for cartridge	FS 1093 (SW 3)		FS 1094 (SW 4)
	Tightening torque	4 Nm		7 Nm
	Drive pin	FK 311		FK 312
	Screw for drive pin	FS 502		FS 503
	Clamping screw for insert CC . . 0602 + WC . . 0402	FS 923 (Torx 8)		
	Tightening torque	0.8 Nm		
	Clamping screw for insert WC . . 0302	FS 1020 (Torx 7)		
	Tightening torque	0.6 Nm		



Cartridge with W insert

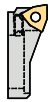

Complete tool

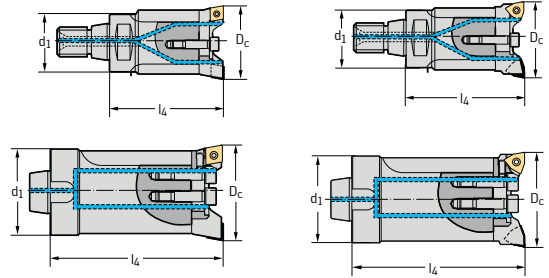



Designation	Type	d ₁ mm	l ₄ mm	kg	Designation with C insert	Designation with W insert
EB 421.WC03	WC . . 0302 . .	19	35	0,1	B 3221.T18.20-24.Z2.CC06	B 3221.T18.20-24.Z2.WC03*
EB 422.WC03		19	35	0,1	B 3221.T18.23-27.Z2.CC06	B 3221.T18.23-27.Z2.WC03*
EB 423.WC03		22	40	0,1	B 3221.T22.26-33.Z2.CC06	B 3221.T22.26-33.Z2.WC03*
EB 225-226.WC04	WC . . 0402 . .	28	55	0,3	B 3220.T28.33-41.Z2.CC06	B 3220.T28.33-41.Z2.WC04*
EB 421.WC03	WC . . 0302 . .	25	80	0,2	B 3221.N2.020-024.Z2.CC06	B 3221.N2.020-024.Z2.WC03
EB 422.WC03		25	80	0,2	B 3221.N2.023-027.Z2.CC06	B 3221.N2.023-027.Z2.WC03
EB 423.WC03		25	80	0,3	B 3221.N2.026-033.Z2.CC06	B 3221.N2.026-033.Z2.WC03
EB 225-226.WC04	WC . . 0402 . .	32	80	0,5	B 3220.N3.033-041.Z2.CC06	B 3220.N3.033-041.Z2.WC04

* N.B.: the projection of the cartridges must be sufficient for chip removal where used with extension in blind bores.

Accessories

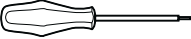
D_c min-max [mm]

	20-33	33-41	
 Screwdriver for clamping screw FS 923	FS 230 (Torx 8)	FS 230 (Torx 8)	
 Screwdriver for clamping screw FS 1020	FS 309 (Torx 7)	FS 309 (Torx 7)	
 Allen key DIN 911	SW 1,3 / SW 3	SW 1,5 / SW 4	



Two flute boring tool

B 3220 / B 3221

Walter Boring^{MEDIUM}

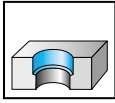

- Ø 41–153 mm
- κ = 90°
- Z = 2

Basic body

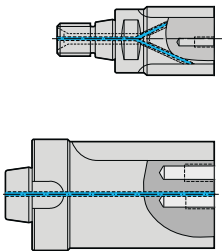

Cartridge with C insert



Tool

NCT ScrewFit

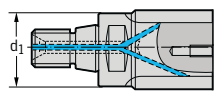

Designation	d ₁ mm	D _c mm	Designation	Type
B 3220G.T36.41–55.Z2	T 36	41–55	EB 207–208.CC09	CC...09T3...
B 3220G.T45.55–70.Z2	T 45	55–70	EB 209–210.CC09	
B 3220G.N4.041–056.Z2	NCT 40	41–55	EB 207–208.CC09	CC...09T3...
B 3220G.N5.055–073.Z2	NCT 50	55–70	EB 209–210.CC09	
B 3220G.N6.070–93.Z2	NCT 63	70–90	EB 211–212.CC12	CC...1204...
B 3220G.N8.090–113.Z2	NCT 80	90–110	EB 213–214.CC12	
B 3220G.N8.110–153.Z2	NCT 80	110–133	EB 215.CC12	
		130–153	EB 216.CC12	

Modular adaptor

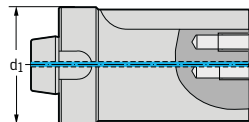

For assembly aids, see page G 105.
Bodies and assembly parts are included in the scope of delivery.

Assembly parts

		D _c min–max [mm]			
		41–70	70–90	90–110	110–153
	Adjusting screw	FS 1106 (SW 2)	FS 1107 (SW 2,5)		FS 1108 (SW 2,5)
	Spring washer	FS 1100	FS 1101	FS 1102	
	Clamping screw for cartridge	FS 1095 (SW 5)	FS 1096 (SW 6)	FS 1097 (SW 8)	
	Tightening torque	12 Nm	30 Nm	50 Nm	
	Drive pin (only with NCT 40)	FK 313			
	Screw for drive pin (only with NCT 40)	FS 504			
	Clamping screw for insert	FS 359 (Torx 15)	FS 1030 (Torx 20)		
	Tightening torque	2.5 Nm	5.0 Nm		



Cartridge with W insert

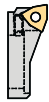

Complete tool

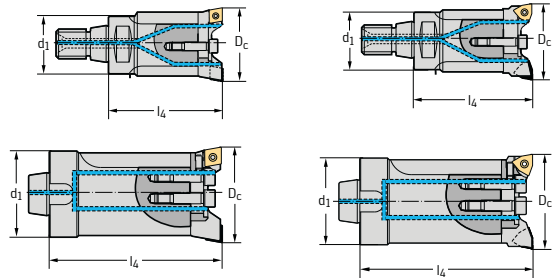

Designation	Type	d ₁ mm	l ₄ mm	kg	Designation with C insert	Designation with W insert
EB 227-228.WC06	WC...06T3...	36	65	0,5	B 3220.T36.41-55.Z2.CC09	B 3220.T36.41-55.Z2.WC06*
EB 229-230.WC06		45	80	0,9	B 3220.T45.55-70.Z2.CC09	B 3220.T45.55-70.Z2.WC06*
EB 227-228.WC06	WC...06T3...	40	80	0,8	B 3220.N4.041-055.Z2.CC09	B 3220.N4.041-055.Z2.WC06
EB 229-230.WC06		50	100	1,6	B 3220.N5.055-070.Z2.CC09	B 3220.N5.055-070.Z2.WC06
EB 231-232.WC08	WC...0804...	63	100	2,5	B 3220.N6.070-090.Z2.CC12	B 3220.N6.070-090.Z2.WC08
EB 233-234.WC08		80	100	4,0	B 3220.N8.090-110.Z2.CC12	B 3220.N8.090-110.Z2.WC08
EB 235.WC08		80	100	5,0	B 3220.N8.110-133.Z2.CC12	B 3220.N8.110-133.Z2.WC08
EB 236.WC08		80	100	5,0	B 3220.N8.130-153.Z2.CC12	B 3220.N8.130-153.Z2.WC08

* N.B.: the projection of the cartridges must be sufficient for chip removal where used with extension in blind bores.

Accessories

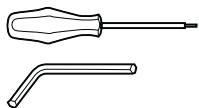

		D _c min-max [mm]	
		41-70	70-153
Screwdriver for clamping screw		FS 229 (Torx 15)	FS 228 (Torx 20)
Allen key DIN 911		SW 2 / SW 5	SW 2,5 / SW 6 / SW 8



Two flute boring tool with bridge B 3220

Walter Boring^{MAXI}

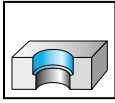

- Ø 150–640 mm
- κ = 90°
- Z = 2

Basic body

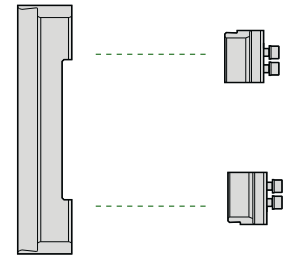
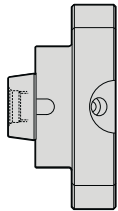

Tool

Modular adaptor

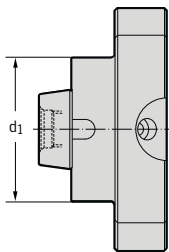

Designation	d ₁ mm	D _c mm	Bridge	Cartridge holder
B 3223G.N8.150–640	NCT 80	150–220	EB 124	EB 122
		220–290	EB 125	
		290–360	EB 126	
		360–430	EB 127	
		430–500	EB 128	
		500–570	EB 129	
		570–640	EB 130	

For assembly aids, see page G 105.
Bodies and assembly parts are included in the scope of delivery.

Assembly parts

	Designation	Tightening torque
	Clamping screw for bridge FS 1114 (SW 10)	120 Nm
	Clamping screw for cartridge holder FS 1113 (SW 6)	25 Nm
	Fitting screw FS 1097 (SW 8)	50 Nm
	Spring washer FS 1102	
	Adjusting screw FS 1109 (SW 2,5)	
	Clamping screw for insert FS 1030 (Torx 20)	5 Nm



Cartridge with C insert

Complete tool

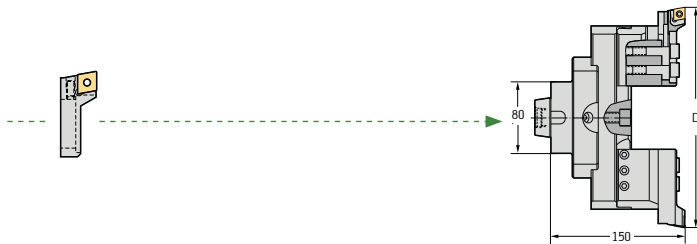

Designation	Type	kg	Designation with C insert
EB 217.CC12	CCMT 12 . .	7,9	B 3220.N8.150-220.Z2.CC12
		9,2	B 3220.N8.220-290.Z2.CC12
		10,5	B 3220.N8.290-360.Z2.CC12
		11,7	B 3220.N8.360-430.Z2.CC12
		13,0	B 3220.N8.430-500.Z2.CC12
		14,3	B 3220.N8.500-570.Z2.CC12
		15,5	B 3220.N8.570-640.Z2.CC12

Accessories

	Screwdriver for clamping screw	FS 228 (Torx 20)
	Allen key DIN 911	SW 2,5 / SW 6 / SW 8 / SW 10

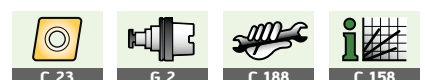

Two flute boring tool with bridge B 3224

Walter Boring^{MAXI}

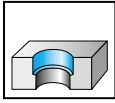

- Ø 150–640 mm
- $\kappa = 90^\circ$
- $Z = 2$
- NCT flute twisted by 90° in relation to B 3220

Basic body

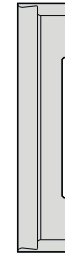
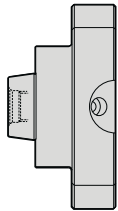

Tool	Designation	d_1 mm	D_c mm	Bridge	Cartridge holder
Modular adaptor 	B 3224G.N8.150–640	NCT 80	150–220	EB 124	EB 122
			220–290	EB 125	
			290–360	EB 126	
			360–430	EB 127	
			430–500	EB 128	
			500–570	EB 129	
			570–640	EB 130	

For assembly aids, see page G 105.
Bodies and assembly parts are included in the scope of delivery.

Assembly parts

	Designation	Tightening torque
	Clamping screw for bridge FS 1114 (SW 10)	120 Nm
	Clamping screw for cartridge holder FS 1113 (SW 6)	25 Nm
	Fitting screw FS 1097 (SW 8)	50 Nm
	Spring washer FS 1102	
	Adjusting screw FS 1109 (SW 2,5)	
	Clamping screw for insert FS 1030 (Torx 20)	5 Nm



Cartridge with C insert

Complete tool

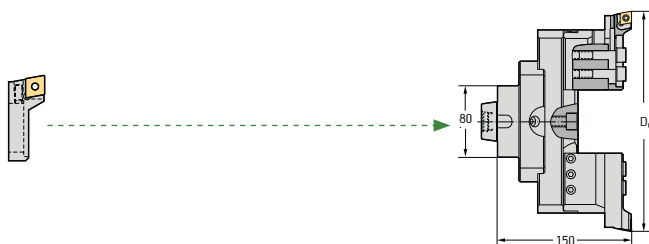

Designation	Type	kg	Designation with C insert
EB 217.CC12	CCMT 12 . .	7,9	B 3224.N8.150-220.Z2.CC12
		9,2	B 3224.N8.220-290.Z2.CC12
		10,5	B 3224.N8.290-360.Z2.CC12
		11,7	B 3224.N8.360-430.Z2.CC12
		13,0	B 3224.N8.430-500.Z2.CC12
		14,3	B 3224.N8.500-570.Z2.CC12
		15,5	B 3224.N8.570-640.Z2.CC12

Accessories

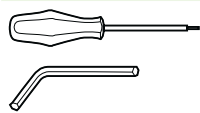

Screwdriver
for clamping screw

FS 228 (Torx 20)

Allen key DIN 911

SW 2,5 / SW 6 / SW 8 / SW 10

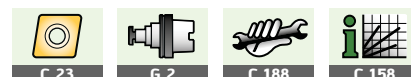

Precision boring tool

B 3230 / B 4030

Walter Precision^{MINI}

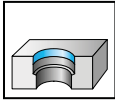

- Ø 2.0–9.5 mm
- κ = 93°
- Z = 1

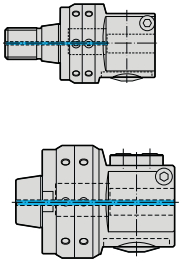
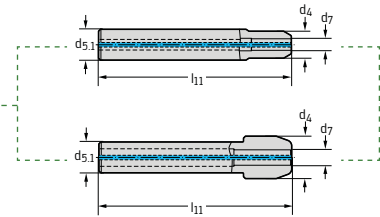
Basic body

Reduction

Tool	Designation	d ₁ mm	D mm	Designation	d ₇ mm	d ₄ mm	d _{5.1} mm	l ₁₁ mm
<p>NCT ScrewFit 50</p> <p>60</p> <p>Ø12</p> <p>ScrewFit</p>	B 4030G.T45.02-20.Z1 Balanceable	T 45	2.0–3.5	EB 501	4	12	12	85
			3.0–6.0					
		T 45	5.8–7.5	EB 502	5	12	12	85
			7.3–9.5					
<p>80</p> <p>Ø16</p> <p>d₁</p>	B 3230G.N6.002-045.Z1 Standard	NCT 63	2.0–3.5	EB 101	4	12	16	100
			3.0–6.0					
		NCT 63	5.8–7.5	EB 102	5	13	16	100
			7.3–9.5					
<p>Ø68</p> <p>80</p> <p>Ø16</p> <p>d₁</p>	B 4030G. N6.02-45.Z1 Balanceable	NCT 63	5.8–7.5	EB 102	5	13	16	100
			7.3–9.5					

For assembly aids, see page G 105.

Bodies and assembly parts are included in the scope of delivery.

Assembly parts	Designation	d ₁ = T 45		d ₁ = NCT 63	
		Designation	Tightening torque	Designation	Tightening torque
	Clamping screw	FS 1084 (SW 4)	4.0 Nm	FS 1085 (SW 5)	10 Nm
	Clamping screw for reduction	FS 2039 (SW 4)	7.0 Nm	FS 1112 (SW 5)	14 Nm
	Clamping screw for insert holder	FS 1110 (SW 2)	1.9 Nm	FS 1110 (SW 2)	1.9 Nm
	Clamping screw for insert with D _c = 5.8–9.5 mm	FS 1151 (Torx 6)	0.4 Nm	FS 1151 (Torx 6)	0.4 Nm
	Clamping screw for balancing rings	FS 2037 (SW 2)		FS 2038 (SW 2)	



Insert holder

Complete tool

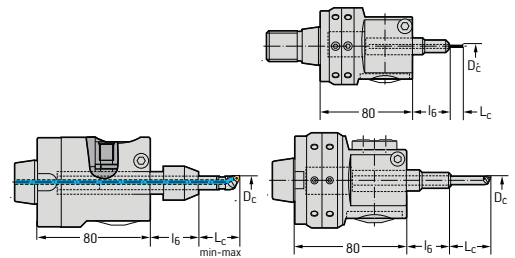
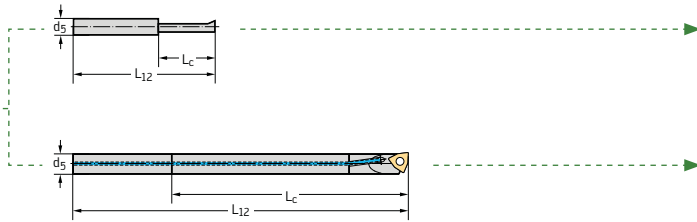

Designation	d ₅ mm	L ₁₂ mm	Type	L _c min mm	L _c max mm	l ₆ mm	kg	Standard Designation	Balanceable Designation
EB 301.WK10*	4	30	—	9	—	30–53	0,8		B 4030.T45.02-03.Z1.WK10
EB 302.WK10*	4	35	—	14	—	30–53	0,8		B 4030.T45.03-06.Z1.WK10
EB 303.WC02.CS	5	85	WC . . 0201 . .	20	60	30–53	0,8		B 4030.T45.06-07.Z1.WC02
EB 304.WC02.CS	6	95	WC . . 0201 . .	20	65	30–53	0,8		B 4030.T45.07-09.Z1.WC02
EB 301.WK10*	4	30	—	9	—	28–60	1,8	B 3230.N6.02-03.Z1.WK10	B 4030.N6.02-03.Z1.WK10
EB 302.WK10*	4	35	—	14	—	28–60	1,8	B 3230.N6.03-06.Z1.WK10	B 4030.N6.03-06.Z1.WK10
EB 303.WC02.CS	5	85	WC . . 0201 . .	20	60	28–60	1,8	B 3230.N6.06-07.Z1.WC02	B 4030.N6.06-07.Z1.WC02
EB 304.WC02.CS	6	95	WC . . 0201 . .	20	65	28–60	1,8	B 3230.N6.07-09.Z1.WC02	B 4030.N6.07-09.Z1.WC02

* Boring bar made from solid carbide EB . . . CS = solid carbide shank
 Advantages: increased rigidity, reduced deflection, vibration neutralisation

Accessories

	Screwdriver for clamping screw	FS 1063 (Torx 6)
	Allen key DIN 911	SW 2 / SW 4 / SW 5
	One-piece boring bar	For D _c 5.8–9.5, see page C 106



Precision boring tool

B 3230 / B 4030

Walter Precision^{MINI}

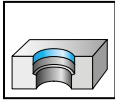

- Ø 8,8–20 mm
- κ = 93°
- Z = 1

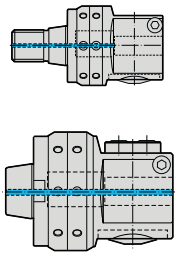
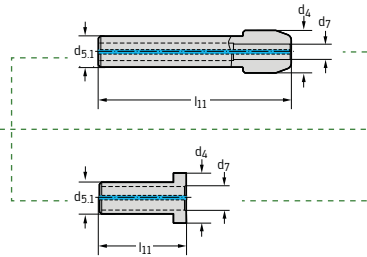
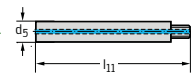
Basic body

Reduction

Extension

Tool		d ₁ mm	D _c mm	Designation	d ₇ mm	d ₄ mm	d _{5,1} mm	l ₁₁ mm	Designation	d ₅ mm	l ₁₁ mm
NCT ScrewFit B 4030G.T45.02-20.Z1 Balanceable	T 45	8,8–12,5	8,8–12,5	EB 504	8	14	12	30	EB 106	8	47
				EB 107.CS	8	87					
				EB 505	10	14	12	30	EB 108	10	52
				EB 109.CS	10	77					
				EB 508	12	77					
				EB 509.CS	12	97					
Modular adaptor B 3230G.N6.002-045.Z1 Standard B 4030G.N6.02-45.Z1 Balanceable	NCT 63	8,8–12,5	8,8–12,5	EB 104	8	22	16	100	EB 106	8	47
				EB 107.CS	8	87					
		11,8–14,5	11,8–14,5	EB 105	10	24	16	100	EB 108	10	52
				EB 109.CS	10	77					
		13,8–16,5	13,8–16,5	EB 506	12	17	16	36	EB 508	12	77
				EB 509.CS	12	97					
		15,8–20,0	15,8–20,0	EB 507	14	17	16	36	EB 510	14	87
				EB 511.CS	14	117					

EB ... CS = Solid carbide shank

Advantages: increased rigidity, reduced deflection, vibration neutralisation

Assembly parts	d ₁ = T 45				d ₁ = NCT 63	
	Designation	Tightening torque	Designation	Tightening torque		
	Clamping screw	FS 1084 (SW 4)	4.0 Nm	FS 1085 (SW 5)	10 Nm	
	Clamping screw for reduction	FS 2039 (SW 4)	7.0 Nm	FS 1112 (SW 5)	14 Nm	
	Clamping screw for extension	FS 1110 (SW 2)	1.9 Nm	FS 1111 (SW 3)	5.5 Nm	
	Clamping screw for insert	FS 1004 (Torx 7)	0.6 Nm	FS 1004 (Torx 7)	0.6 Nm	
	Clamping screw for balancing rings	FS 2037 (SW 2)		FS 2038 (SW 2)		



Insert holder

Complete tool

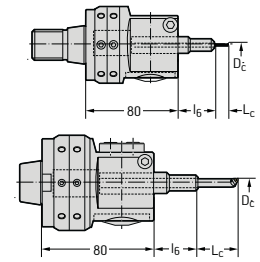
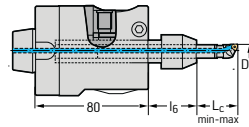

Designation	l ₁₂ mm	Type	L _c min mm	L _c max mm	l ₆ mm	kg	Standard Designation	Balanceable Designation
EB 305.WC03	18	WC...0302..	18	33	2	0,8		B 4030.T45.09-12.Z1.WC03.S
			35	73	2	0,8		B 4030.T45.09-12.Z1.WC03.L
EB 306.WC03	23	WC...0302..	23	43	2	0,8		B 4030.T45.12-14.Z1.WC03.S
			45	68	2	0,8		B 4030.T45.12-14.Z1.WC03.L
EB 307.WC03	23	WC...0302..	45	68	—	0,8		B 4030.T45.14-16.Z1.WC03.S
			65	88	—	0,9		B 4030.T45.14-16.Z1.WC03.L
EB 512.WC03	23	WC...0302..	45	68	—	0,8		B 4030.T45.16-20.Z1.WC03.S
			65	88	—	0,9		B 4030.T45.16-20.Z1.WC03.L
EB 305.WC03	18	WC...0302..	20	35	34-60	1,9	B 3230.N6.09-12.Z1.WC03.S	B 4030.N6.09-12.Z1.WC03.S
			20	73	34-60	1,9	B 3230.N6.09-12.Z1.WC03.L	B 4030.N6.09-12.Z1.WC03.L
EB 306.WC03	23	WC...0302..	25	45	34-60	1,9	B 3230.N6.12-14.Z1.WC03.S	B 4030.N6.12-14.Z1.WC03.S
			25	70	34-60	1,9	B 3230.N6.12-14.Z1.WC03.L	B 4030.N6.12-14.Z1.WC03.L
EB 307.WC03	23	WC...0302..	34	60	2	1,9	B 3230.N6.14-16.Z1.WC03.S	B 4030.N6.14-16.Z1.WC03.S
			54	80	2	1,9	B 3230.N6.14-16.Z1.WC03.L	B 4030.N6.14-16.Z1.WC03.L
EB 512.WC03	23	WC...0302..	44	70	2	1,9	B 3230.N6.16-20.Z1.WC03.S	B 4030.N6.16-20.Z1.WC03.S
			74	100	2	1,9	B 3230.N6.16-20.Z1.WC03.L	B 4030.N6.16-20.Z1.WC03.L

Accessories

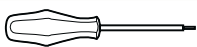

Screwdriver for clamping screw

FS 309 (Torx 7)



Allen key DIN 911

SW 2 / SW 4 / SW 5



One-piece boring bar

For D_c 8.8-15.8, see page C 106



Precision boring tool

B 3230 / B 4030

Walter Precision^{MINI}

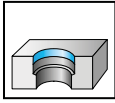

- Ø 17.8–45.5 mm
- κ = 93°
- Z = 1

Basic body

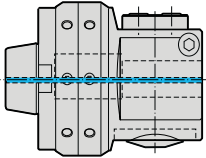

Extension

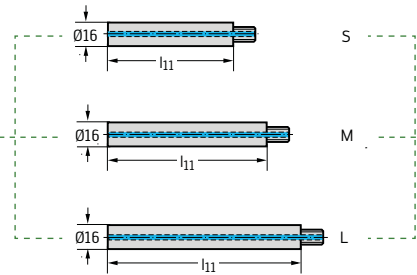

Tool	Designation	d ₁ mm	D _c mm	Designation	l ₁₁ mm	
Modular adaptor	 B 3230G.N6.002-045.Z1 Standard	NCT 63	17,8–22,5	EB 110	88	(S)
				EB 111.CS	108	(M)
	 B 4030G.N6.02-45.Z1 Balanceable	NCT 63	21,8–25,5	EB 110	88	(S)
				EB 111.CS	108	(M)
		NCT 63	24,8–28,5	EB 112.CS	168	(L)
				EB 110	88	(S)
		NCT 63	27,8–32,5	EB 111.CS	108	(M)
				EB 112.CS	168	(L)
		NCT 63	31,8–36,5	EB 110	88	(S)
				EB 111.CS	108	(M)
		NCT 63	35,8–40,5	EB 112.CS	168	(L)
				EB 110	88	(S)
		NCT 63	39,8–45,5	EB 111.CS	108	(M)
				EB 112.CS	168	(L)

EB...CS = Solid carbide shank

Advantages: increased rigidity, reduced deflection, vibration neutralisation

Assembly parts

		Designation	Tightening torque
	Clamping screw	FS 1085 (SW 5)	10 Nm
	Clamping screw for extension	FS 1112 (SW 5)	14 Nm
	Clamping screw for insert	FS 923 (Torx 8)	0.8 Nm
	Clamping screw for balancing rings	FS 2038 (SW 2)	



Insert holder

Complete tool

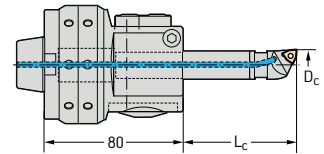
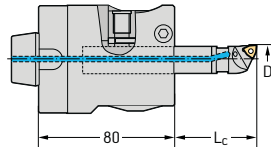

Designation	l ₁₂ mm	Type	L _c min mm	L _c max mm	kg	Standard Designation	Balanceable Designation
EB 308.WC04	27	WC...0402...	55	80	1,8	B 3230.N6.18-22.Z1.WC04.S	B 4030.N6.18-22.Z1.WC04.S
			75	100	2,0	B 3230.N6.18-22.Z1.WC04.M	B 4030.N6.18-22.Z1.WC04.M
			135	160	2,2	B 3230.N6.18-22.Z1.WC04.L	B 4030.N6.18-22.Z1.WC04.L
EB 309.WC04	27	WC...0402...	55	80	2,3	B 3230.N6.22-25.Z1.WC04.S	B 4030.N6.22-25.Z1.WC04.S
			75	100	2,5	B 3230.N6.22-25.Z1.WC04.M	B 4030.N6.22-25.Z1.WC04.M
			135	160	2,7	B 3230.N6.22-25.Z1.WC04.L	B 4030.N6.22-25.Z1.WC04.L
EB 310.WC04	27	WC...0402...	55	80	2,3	B 3230.N6.25-28.Z1.WC04.S	B 4030.N6.25-28.Z1.WC04.S
			75	100	2,5	B 3230.N6.25-28.Z1.WC04.M	B 4030.N6.25-28.Z1.WC04.M
			135	160	2,7	B 3230.N6.25-28.Z1.WC04.L	B 4030.N6.25-28.Z1.WC04.L
EB 311.WC04	27	WC...0402...	55	80	2,3	B 3230.N6.28-32.Z1.WC04.S	B 4030.N6.28-32.Z1.WC04.S
			75	100	2,5	B 3230.N6.28-32.Z1.WC04.M	B 4030.N6.28-32.Z1.WC04.M
			135	160	2,7	B 3230.N6.28-32.Z1.WC04.L	B 4030.N6.28-32.Z1.WC04.L
EB 312.WC04	27	WC...0402...	55	80	2,3	B 3230.N6.32-36.Z1.WC04.S	B 4030.N6.32-36.Z1.WC04.S
			75	100	2,5	B 3230.N6.32-36.Z1.WC04.M	B 4030.N6.32-36.Z1.WC04.M
			135	160	2,7	B 3230.N6.32-36.Z1.WC04.L	B 4030.N6.32-36.Z1.WC04.L
EB 313.WC04	27	WC...0402...	55	80	2,3	B 3230.N6.36-40.Z1.WC04.S	B 4030.N6.36-40.Z1.WC04.S
			75	100	2,5	B 3230.N6.36-40.Z1.WC04.M	B 4030.N6.36-40.Z1.WC04.M
			135	160	2,7	B 3230.N6.36-40.Z1.WC04.L	B 4030.N6.36-40.Z1.WC04.L
EB 314.WC04	27	WC...0402...	55	80	2,3	B 3230.N6.40-45.Z1.WC04.S	B 4030.N6.40-45.Z1.WC04.S
			75	100	2,5	B 3230.N6.40-45.Z1.WC04.M	B 4030.N6.40-45.Z1.WC04.M
			135	160	2,7	B 3230.N6.40-45.Z1.WC04.L	B 4030.N6.40-45.Z1.WC04.L

For assembly aids, see page G 105.
Bodies and assembly parts are included in the scope of delivery.

Accessories

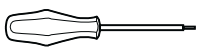

Screwdriver

FS 230 (Torx 8)





Allen key DIN 911

SW 5



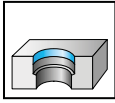

Boring bar EB . . .

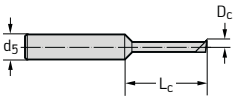
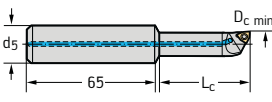
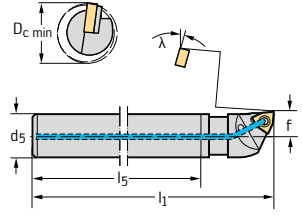
 $-\kappa = 93^\circ$

Tool		Designation	D_c min mm	d_5 mm	f mm	l_1 mm	l_5 mm	L_c mm	λ	 Type
One-piece 	EB 301 WK10		2,0	4	1,0	30	21			VHM WK 10
	EB 302 WK10		3,0	4	1,5	35	21			
One-piece 	EB 513		5,8	16				17		WC . . 0201 . .
	EB 514.CS		5,8	16				30		
	EB 515		7,3	16				21		
	EB 516.CS		7,3	16				36		WC . . 0302 . .
	EB 517		8,8	16				28		
	EB 518.CS		8,8	16				47		
	EB 519		11,8	16				35		
	EB 520.CS		11,8	16				60		
	EB 521		13,8	16				42		
	EB 522.CS		13,8	16				72		
With insert holder 	EB 303.WC02.CS		5,8	5	2,9	85	70			WC . . 0201 . .
	EB 304.WC02.CS		7,3	6	3,65	95	75			WC . . 0302 . .
	EB 353.WC03		8,8	8	4,5	65	47		-10°	
	EB 354.WC03.CS		8,8	8	4,5	105	87		-10°	
	EB 355.WC03		11,8	10	6,0	75	52		-7°	
	EB 356.WC03.CS		11,8	10	6,0	120	97		-7°	
	EB 357.WC03		13,8	10	6,9	75	52		-5°	
	EB 358.WC03.CS		13,8	10	6,9	120	97		-5°	WC . . 0402 . .
	EB 359.WC04		17,8	16	8,9	115	88		-3°	
	EB 360.WC04.CS		17,8	16	8,9	135	108		-3°	
	EB 361.WC04.CS		17,8	16	8,9	195	168		-3°	
	EB 362.WC04		21,8	16	10,9	115	88		$-2,5^\circ$	
	EB 363.WC04.CS		21,8	16	10,9	135	108		$-2,5^\circ$	
	EB 364.WC04.CS		21,8	16	10,9	195	168		$-2,5^\circ$	
	EB 365.WC04		24,8	16	12,4	115	88		0°	
	EB 366.WC04.CS		24,8	16	12,4	135	108		0°	
	EB 367.WC04.CS		24,8	16	12,4	195	168		0°	
	EB 368.WC04		27,8	16	13,9	115	88		0°	
	EB 369.WC04.CS		27,8	16	13,9	135	108		0°	
	EB 370.WC04.CS		27,8	16	13,9	195	168		0°	
	EB 371.WC04		31,8	16	15,9	115	88		0°	
	EB 372.WC04.CS		31,8	16	15,9	135	108		0°	
	EB 373.WC04.CS		31,8	16	15,9	195	168		0°	
	EB 374.WC04		35,8	16	17,9	115	88		0°	
	EB 375.WC04.CS		35,8	16	17,9	135	108		0°	
	EB 376.WC04.CS		35,8	16	17,9	195	168		0°	
	EB 377.WC04		39,8	16	19,9	115	88		0°	
	EB 378.WC04.CS		39,8	16	19,9	135	108		0°	
	EB 379.WC04.CS		39,8	16	19,9	195	168		0°	

Bodies and assembly parts are included in the scope of delivery.

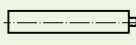

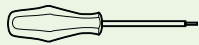
Assembly parts			Accessories			
 Toolholder	 Insert holder	 Clamping screw for insert	Tightening torque	 Screwdriver		

			FS 1151 (Torx 6)	0.4 Nm	FS 1063 (Torx 6)	
			FS 1004 (Torx 7)	0.6 Nm	FS 309 (Torx 7)	
	—	EB 303.WC02.CS	FS 1151 (Torx 6)	0.4 Nm	FS 1063 (Torx 6)	
	—	EB 304.WC02.CS				
EB 106	EB 305.WC03	FS 1004 (Torx 7)	0.6 Nm	FS 309 (Torx 7)		
EB 107.CS	EB 305.WC03					
EB 108	EB 306.WC03					
EB 109.CS	EB 306.WC03					
EB 108	EB 307.WC03					
EB 109.CS	EB 307.WC03					
EB 110	EB 308.WC04	FS 923 (Torx 8)	0.8 Nm	FS 230 (Torx 8)		
EB 111.CS	EB 308.WC04					
EB 112.CS	EB 308.WC04					
EB 110	EB 309.WC04					
EB 111.CS	EB 309.WC04					
EB 112.CS	EB 309.WC04					
EB 110	EB 310.WC04					
EB 111.CS	EB 310.WC04					
EB 112.CS	EB 310.WC04					
EB 110	EB 311.WC04					
EB 111.CS	EB 311.WC04					
EB 112.CS	EB 311.WC04					
EB 110	EB 312.WC04					
EB 111.CS	EB 312.WC04					
EB 112.CS	EB 312.WC04					
EB 110	EB 313.WC04					
EB 111.CS	EB 313.WC04					
EB 112.CS	EB 313.WC04					
EB 110	EB 314.WC04					
EB 111.CS	EB 314.WC04					
EB 112.CS	EB 314.WC04					

EB . . . CS = Solid carbide shank
 Advantages: increased rigidity, reduced deflection, vibration neutralisation

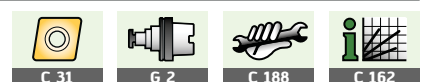

Precision boring tool B 3230

Walter Precision^{MEDIUM}

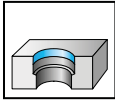

- Ø 20–153 mm
- $\kappa = 95^\circ / \kappa = 93^\circ$
- Z = 1

Basic body

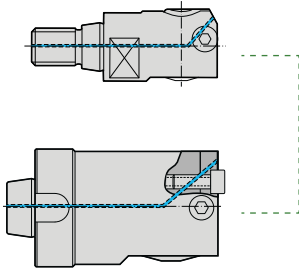

Cartridge with C insert

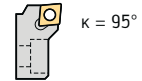

Tool

NCT ScrewFit

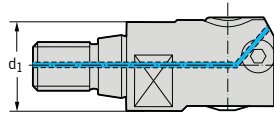

Designation	d ₁ mm	D _c mm	Designation	Type
B 3230G.T18.20–026.Z1	T 18	20–26	EB 321.CP05	CP . . 0502 . .
B 3230G.T22.26–033.Z1	T 22	26–33	EB 323.CP05	CP . . 0502 . .
B 3230G.N2.020–026.Z1	NCT 25	20–26	EB 321.CP05	CP . . 0502 . .
B 3230G.N2.026–033.Z1	NCT 25	26–33	EB 323.CP05	CP . . 0502 . .
B 3230G.N3.033–041.Z1	NCT 32	33–41	EB 325.CP05	CP . . 0502 . .
B 3230G.N4.041–055.Z1	NCT 40	41–55	EB 327.CC06	CC . . 0602 . .
B 3230G.N5.055–070.Z1	NCT 50	55–70	EB 329.CC06	CC . . 0602 . .
B 3230G.N6.070–090.Z1	NCT 63	70–90		
B 3230G.N8.090–110.Z1	NCT 80	90–110		
B 3230G.N8.110–153.Z1	NCT 80	110–153		

Modular adaptor

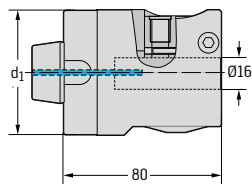

For assembly aids, see page G 105.
Bodies and assembly parts are included in the scope of delivery.

Assembly parts

		D _c min–max [mm]						
		20–26	26–33	33–41	41–55	55–70	70–90	90–153
	Clamping screw	FS 1383 (Torx 10)	FS 1082 (SW 2,5)	FS 1083 (SW 3)	FS 1084 (SW 4)	FS 1085 (SW 5)	FS 1086 (SW 6)	FS 1087 (SW 6)
	Tightening torque	1.2 Nm	2.0 Nm	2.5 Nm	4.0 Nm	10.0 Nm	25.0 Nm	25.0 Nm
	Clamping screw for cartridge	FS 1088 (Torx 9)	FS 378 (Torx 15)	FS 1030 (Torx 20)	FS 1091 (SW 3)	FS 1092 (SW 5)		
	Tightening torque	1.2 Nm	2.0 Nm	2.5 Nm	2.5 Nm	12.0 Nm		
	Drive pin (only with NCT 25)	FK 311		FK 312	FK 313			
	Screw for drive pin (only with NCT 25)	FS 502		FS 503	FS 504			
	Clamping screw for insert	FS 1004 (Torx 7)			FS 923 (Torx 8)	for CC . . 06: FS 923 (Torx 8) for WC . . 05: FS 379 (Torx 8)		
	Tightening torque	0.6 Nm			0.8 Nm	FS 923: 0.8 Nm / FS 379: 1.0 Nm		



Cartridge with W insert

Complete tool

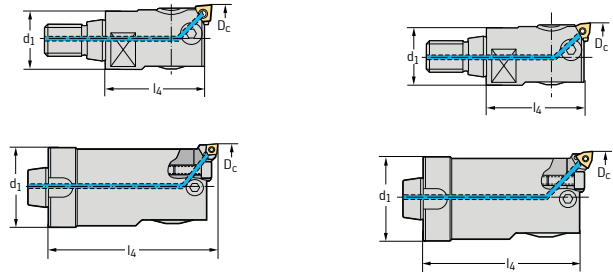
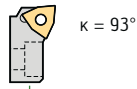

Designation	Type	d ₁ mm	l ₄ mm	kg	Standard Designation with C insert	Standard Designation with W insert
EB 341.WC03	WC . . 0302 . .	18	35	0,1	B 3230.T18.20-26.Z1.CP05	B 3230.T18.20-26.Z1.WC03
EB 343.WC03	WC . . 0302 . .	22	40	0,15	B 3230.T22.26-33.Z1.CP05	B 3230.T22.26-33.Z1.WC03
EB 341.WC03	WC . . 0302 . .	25*	80	0,2	B 3230.N2.020-026.Z1.CP05	B 3230.N2.020-026.Z1.WC03
EB 343.WC03	WC . . 0302 . .	25	80	0,3	B 3230.N2.026-033.Z1.CP05	B 3230.N2.026-033.Z1.WC03
EB 345.WC03	WC . . 0302 . .	32	80	0,5	B 3230.N3.033-041.Z1.CP05	B 3230.N3.033-041.Z1.WC03
EB 347.WC04	WC . . 0402 . .	40	80	0,8	B 3230.N4.041-055.Z1.CC06	B 3230.N4.041-055.Z1.WC04
EB 349.WC05	WC . . 0503 . .	50	100	1,6	B 3230.N5.055-070.Z1.CC06	B 3230.N5.055-070.Z1.WC05
		63	100	2,5	B 3230.N6.070-090.Z1.CC06	B 3230.N6.070-090.Z1.WC05
		80	100	4,0	B 3230.N8.090-110.Z1.CC06	B 3230.N8.090-110.Z1.WC05
		80	100	5,0	B 3230.N8.110-153.Z1.CC06	B 3230.N8.110-153.Z1.WC05

* Maximum drilling depth = 65 mm

Accessories

for D_c min-max [mm]

		20-26	26-33	33-41	41-55	55-70	70-153
	Screwdriver for clamping screw	FS 309 (Torx 7)			FS 230 (Torx 8)		
	Torx key for clamping screw	FS 1050 (Torx 10)					
	Wrench DIN 911 for clamping screw		SW 2,5	SW 3	SW 4	SW 5	SW 6
	Wrench for cartridge clamping	FS 1128 (Torx 9)	FS 1047 (Torx 15)	FS 1048 (Torx 20)			
	Allen key DIN 911 for cartridge clamping				SW 3	SW 5	SW 5



Self-balancing precision boring tool B 4030

Walter Precision^{MEDIUM}

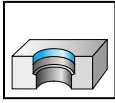

- Ø 33–153 mm
- $\kappa = 95^\circ / \kappa = 93^\circ$
- Z = 1

Basic body

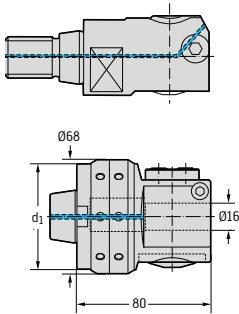

Cartridge with C insert

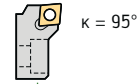

Tool

	Designation	d ₁ mm	D _c mm	Designation	Type
NCT ScrewFit 	B 4030G.T28.33–41.Z1	T 28	33–41	EB 323.CP 05	CP .. 0502 ..
	B 4030G.T36.41–55.Z1	T 36	41–55	EB 325.CP05	CP .. 0502 ..
	B 4030G.T45.55–70.Z1	T 45	55–70	EB 327.CC06	CC .. 0602 ..
Modular adaptor 	B 4030G.N6.070–090.Z1	NCT 63	70–90	EB 327.CC06	CC .. 0602 ..
	B 4030G.N8.090–110.Z1*	NCT 80	90–110		
	B 4030G.N8.110–153.Z1*	NCT 80	110–153		

* Aluminium design

For assembly aids, see page G 105.

Bodies and assembly parts are included in the scope of delivery.

Assembly parts

		D _c min–max [mm]					
		33–41	41–55	55–70	70–90	90–110	110–153
	Clamping screw	FS 2031 (SW 2,5)	FS 2032 (SW 3)	FS 2033 (SW 4)	FS 2034 (SW 5)	FS 2035 (SW 6)	FS 2036 (SW 6)
	Tightening torque	2.5 Nm	3.0 Nm	6.0 Nm	12 Nm	15 Nm	15 Nm
	Clamping screw for cartridge	FS 378 (Torx 15)	FS 1030 (Torx 20)	FS 1091 (SW 3)			
	Tightening torque	2.0 Nm	2.5 Nm	2.5 Nm			
	Clamping screw for insert	FS 1004 (Torx 7)		FS 923 (Torx 8)			
	Tightening torque	0.6 Nm		0.8 Nm			



Cartridge with W insert

Complete tool

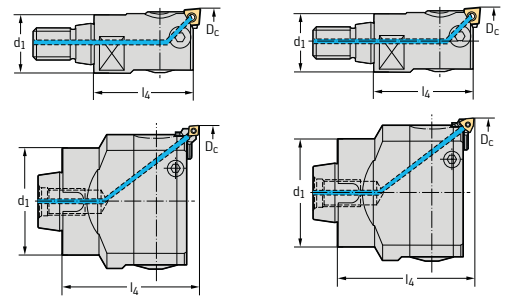
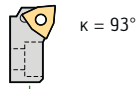

Designation	Type	d ₁ mm	l ₄ mm	kg	Designation with C insert	Designation with W insert
EB 343.WC03	WC . . 0302 . .	28	55	0,3	B 4030.T28.33-41.Z1.CP05	B 4030.T28.33-41.Z1.WC03
EB 345.WC03	WC . . 0302 . .	36	65	0,6	B 4030.T36.41-55.Z1.CP05	B 4030.T36.41-55.Z1.WC03
EB 347.WC04	WC . . 0402 . .	45	80	1,0	B 4030.T45.55-70.Z1.CC06	B 4030.T45.55-70.Z1.WC04
EB 347.WC04	WC . . 0402 . .	63	100	2,5	B 4030.N6.070-090.Z1.CC06	B 4030.N6.070-090.Z1.WC04
		80	100	1,6	B 4030.N8.090-110.Z1.CC06	B 4030.N8.090-110.Z1.WC04
		80	100	2,0	B 4030.N8.110-153.Z1.CC06	B 4030.N8.110-153.Z1.WC04

Accessories

for D_c min-max [mm]

		33-41	41-55	55-70	70-90	90-153
	Screwdriver for clamping screw	FS 309 (Torx 7)		FS 230 (Torx 8)		
	Wrench DIN 911 for clamping screw	SW 2,5	SW 3	SW 4	SW 5	SW 6
	Wrench for cartridge clamping	FS 1047 (Torx 15)	FS 1048 (Torx 20)			
	Allen key DIN 911 for cartridge clamping				SW 3	

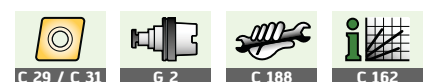

Precision boring tool with bridge B 3230

Walter Precision^{MAXI}

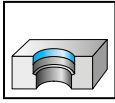

- Ø 150–640 mm
- $\kappa = 95^\circ / \kappa = 93^\circ$
- Z = 1

Basic body

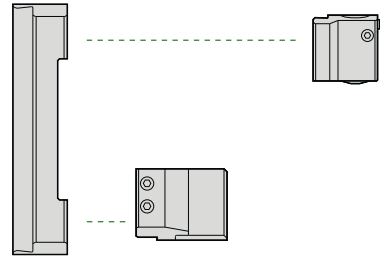
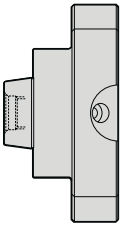

Tool

Modular adaptor

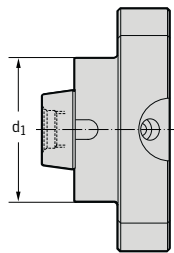

Designation	d ₁ mm	D _c mm	Bridge	Balance compensation	Cartridge holder
B 3223G.N8.150–640	NCT 80	150–220	EB 124	—	—
		220–290	EB 125	EB 121	EB 123
		290–360	EB 126		
		360–430	EB 127		
		430–500	EB 128		
		500–570	EB 129		
		570–640	EB 130		

For assembly aids, see page G 105.

Bodies and assembly parts are included in the scope of delivery.

Assembly parts

	Designation	Tightening torque
	Clamping screw for bridge FS 1114 (SW 10)	120 Nm
	Clamping screw for balance compensation weight FS 1086 (SW 6)	25 Nm
	Clamping screw for cartridge holder and balance compensation FS 1113 (SW 6)	25 Nm
	Clamping screw for cartridge FS 1092 (SW 5)	12 Nm
	Clamping screw for insert FS 379 (Torx 8)	2.5 Nm



Cartridge with C insert

Cartridge with W insert

Complete tool

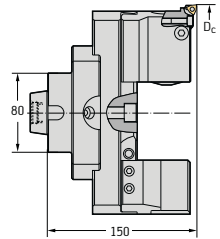
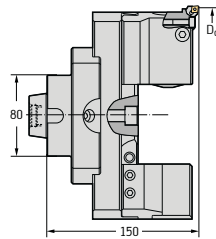

Designation	Type	Designation	Type	Standard Designation with C insert	Standard Designation with W insert	
EB 329.CC06	CCGT 06 . .	EB 349.WC05	WCGT 05 . .	7,9	B 3230.N8.150-220.Z1.CC06	B 3230.N8.150-220.Z1.WC05
				9,2	B 3230.N8.220-290.Z1.CC06	B 3230.N8.220-290.Z1.WC05
				10,5	B 3230.N8.290-360.Z1.CC06	B 3230.N8.290-360.Z1.WC05
				11,7	B 3230.N8.360-430.Z1.CC06	B 3230.N8.360-430.Z1.WC05
				13,0	B 3230.N8.430-500.Z1.CC06	B 3230.N8.430-500.Z1.WC05
				14,3	B 3230.N8.500-570.Z1.CC06	B 3230.N8.500-570.Z1.WC05
				15,5	B 3230.N8.570-640.Z1.CC06	B 3230.N8.570-640.Z1.WC05

Accessories

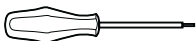

Screwdriver for clamping screw

FS 230 (Torx 8)



Allen key DIN 911

SW 5 / SW 6 / SW 10



Precision boring tool with bridge B 3234

Walter Precision^{MAXI}

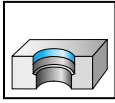

- Ø 150–640 mm
- $\kappa = 95^\circ / \kappa = 93^\circ$
- $Z = 1$
- NCT flute orientation rotated by 90° in relation to B 3230

Basic body

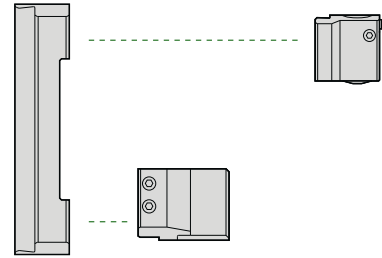
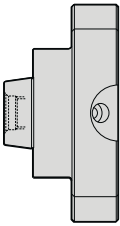

Tool	Designation	d_1 mm	D_c mm	Bridge	Balance compensation	Cartridge holder
Modular adaptor 	B 3224G.N8.150–640	NCT 80	150–220	EB 124	—	EB 123
			220–290	EB 125	EB 121	
			290–360	EB 126		
			360–430	EB 127		
			430–500	EB 128		
			500–570	EB 129		
			570–640	EB 130		

For assembly aids, see page G 105.
Bodies and assembly parts are included in the scope of delivery.

Assembly parts

	Designation	Tightening torque
	Clamping screw for bridge FS 1114 (SW 10)	120 Nm
	Clamping screw for balance compensation weight FS 1086 (SW 6)	25 Nm
	Clamping screw for cartridge holder and balance compensation FS 1113 (SW 6)	25 Nm
	Clamping screw for cartridge FS 1092 (SW 5)	12 Nm
	Clamping screw for insert FS 379 (Torx 8)	2.5 Nm



Cartridge with C insert

Cartridge with W insert

Complete tool

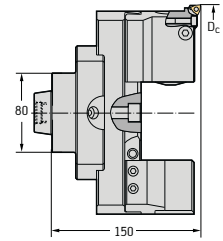
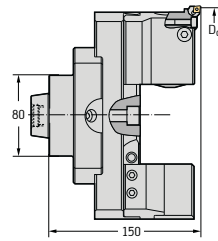

Designation	Type	Designation	Type	kg	Standard Designation with C insert	Standard Designation with W insert
EB 329.CC06	CCGT 06 ..	EB 349.WC05	WCGT 05 ..	7,9	B 3234.N8.150-220.Z1.CC06	B 3234.N8.150-220.Z1.WC05
				9,2	B 3234.N8.220-290.Z1.CC06	B 3234.N8.220-290.Z1.WC05
				10,5	B 3234.N8.290-360.Z1.CC06	B 3234.N8.290-360.Z1.WC05
				11,7	B 3234.N8.360-430.Z1.CC06	B 3234.N8.360-430.Z1.WC05
				13,0	B 3234.N8.430-500.Z1.CC06	B 3234.N8.430-500.Z1.WC05
				14,3	B 3234.N8.500-570.Z1.CC06	B 3234.N8.500-570.Z1.WC05
				15,5	B 3234.N8.570-640.Z1.CC06	B 3234.N8.570-640.Z1.WC05

Accessories

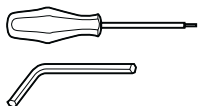

Screwdriver for clamping screw

FS 230 (Torx 8)

Allen key DIN 911

SW 5 / SW 6 / SW 10

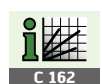

Precision boring tool sets

B 4035

Walter Precision^{DIGITAL}

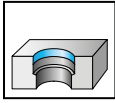

- Ø 10–124 mm
- κ = 93°
- Z = 1

Tool	D _c mm	Set Designation	Set contents Toolholder	Designation
	10–32	B 4035 Set 1	Boring bar	EB 611.WC03 EB 615.WC03 EB 619.WC03
			Extension	EB 642
			Basic body	B 4035 basic body
	32–68	B 4035 Set 2	Extension	EB 625 EB 627
			Basic body	B 4035 basic body
	68–124	B 4035 Set 3	Bridge	EB 631 EB 632
			Counterweight	EB 635
			Basic body	B 4035 basic body

Bodies and assembly parts are included in the scope of delivery.

Assembly parts		Designation	Tightening torque
	Clamping screw for insert	FS 2084 (IP 7) for WC . . 0302 . . FS 1454 (IP 8) for WC . . 0402 . .	0.9 Nm 0.9 Nm
		Clamping screw for basic body	FS 2101 (SW 4)
	Clamping grub screw for boring bar	FS 2102 (SW 4)	8.0 Nm
	Screwdriver	FS 2088 (IP 7) for FS 2084 FS 1483 (IP 8) for FS 1454	
	Coolant supply adaptor	EB 636	
	Battery	FS 2104	
	Battery compartment gasket	FS 2103	
	Battery compartment cover	FS 2105	

IP = Torx Plus



Insert holder	Designation	D _c opt.* mm	D _c mm	L _c mm	 Type
		10–11	10–17	27	WC...0302..
		14–15	14–21	47	
		18–19	18–25	65	
Cartridge	EB 644.WC04	20–22	20–24	81	WC...0402..
	EB 621.WC04	24–26	24–28	81	
	EB 623.WC04	28–30	28–32	81	
Cartridge	EB 629.WC04		32–41	63	WC...0402..
	EB 630.WC04		41–50	63	
Cartridge	EB 629.WC04		50–59	72	
	EB 630.WC04		59–68	72	
Cartridge	EB 634.WC04		68–96	32,5	WC...0402..
	EB 634.WC04		96–124	32,5	

* D_c opt. = diameter range with optimum balancing, for maximum speeds.

Accessories



Allen key DIN 911

SW 1,5 / SW 3



T-handle

FS 1174 (T 25)

Expansion components and individual parts

B 4035

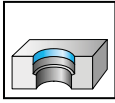
Walter Precision^{DIGITAL}

– Ø 3–20 mm

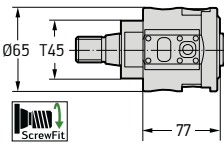
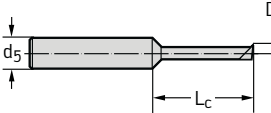
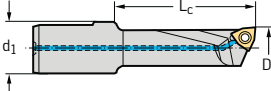
Tool	Designation	D _c opt.* mm	D _c mm	d ₅ mm	d ₂ mm	L _c mm	 Type
Basic body	B 4035 basic body, metric						
							
One-piece insert holder	EB 603.WXP15	3–4	3–10	6		10	—
	EB 604.WXP15	4–5	4–11	6		10	
	EB 605.WXP15	5–6	5–12	6		10	
	EB 606.WXP15	5–6	5–12	6		20	
	EB 607.WXP15	6–7	6–13	6		20	
	EB 608.WXP15	6–7	6–13	6		30	
	EB 609.WXP15	8–9	8–15	8		23	
	EB 610.WXP15	8–9	8–15	8		48	
	Boring bar	EB 611.WC03	10–11	10–17	17		30
	EB 612.WC03	11–12	11–18	17		30	
	EB 613.WC03	12–13	12–19	17		45	
	EB 614.WC03	13–14	13–20	17		45	
	EB 615.WC03	14–15	14–21	17		50	
	EB 616.WC03	15–16	15–22	17		50	
	EB 617.WC03	16–17	16–23	17		60	
	EB 618.WC03	17–18	17–24	17		60	
	EB 619.WC03	18–19	18–25	17		68	
	EB 620.WC03	19–20	19–26	17		68	
	EB 637.WC03.CS		10–12	17		55	
	EB 638.WC03.CS		12–14	17		65	
	EB 639.WC03.CS		14–16	17		75	
	EB 640.WC03.CS		16–18	17		85	
	EB 641.WC03.CS		18–20	17		95	



 * D_c opt. = Tool has optimum balance → suitable for fastest speeds.

Bodies and assembly parts are included in the scope of delivery.

EB...CS = Solid carbide shank:

Advantages: increased rigidity, reduced deflection, vibration neutralisation



Assembly parts		d ₁ = 6 mm	d ₁ = 8 mm	d ₁ = 17 mm
	Threaded plug	FS 2093 (SW 3)	FS 2093 (SW3)	
	Tightening torque	4 Nm	4 Nm	
	Clamping screw for insert			FS 2084 (IP 7)
	Tightening torque			0.9 Nm

For basic bodies for assembly parts, see page C 116.

IP = Torx Plus

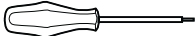
Accessories		d ₁ = 6 mm	d ₁ = 8 mm	d ₁ = 17 mm
	Adaptors	EB 601	EB 602	—
	Screwdriver	DIN 911 (SW 3)	DIN 911 (SW 3)	FS 2088 (IP 7)

IP = Torx Plus

Expansion components and individual parts

B 4035

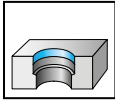
Walter Precision^{DIGITAL}

– Ø 20–124 mm

Tool	Designation	D _c opt.* mm	for D _c mm	d ₁₁ mm	L ₄ mm	Type	
Basic body							
	B 4035 basic set, metric						
Cartridges	EB 644.WC04	20–22	20–24		12	WC...0402...	
	EB 645.WC04	22–24	22–26		12		
	EB 621.WC04	24–26	24–28		12		
	EB 622.WC04	26–28	26–30		12		
	EB 623.WC04	28–30	28–32		12		
	EB 624.WC04	30–32	30–34		12		
	EB 629.WC04		32–41 ¹ 50–59 ²		14		
	EB 630.WC04		41–50 ¹ 59–68 ²		14		
	EB 634.WC04		68–124		16,5		
Extension	EB 642		20–32	25	72	—	
	EB 643.CS		20–32	—	108		
	EB 625		32–50	28,5	52		
	EB 626		32–50	28,5	88		
	EB 627		50–68	46	61		
	EB 628		50–68	46	106		
	Bridge	EB 631		68–96			16
		EB 632		96–124		16	
EB 635 (counterweight)							

 * D_c opt. = Tool has optimum balance → suitable for fastest speeds.

¹ = in combination with EB 625 / EB 626

² = in combination with EB 627 / EB 628

Bodies and assembly parts are included in the scope of delivery.

EB...CS = Solid carbide shank:

Advantages: increased rigidity, reduced deflection, vibration neutralisation.



Assembly parts

		D _c = 20–32 mm	D _c = 32–68 mm	D _c = 68–124 mm
	Clamping screw for insert	FS 1454 (IP 8)		
	Tightening torque	0.9 Nm		
	Clamping screw for cartridge	FS 2094 (T 25)	FS 2096 (SW 4)	
	Tightening torque	8.0 Nm	8.0 Nm	
	Clamping bolt for extension		FS 2095	
	Clamping screw for bridge			FS 2100 (SW 4)
	Clamping screw for cartridge / counterweight			FS 2097 (SW 4)
	Tightening torque			8.0 Nm
	Threaded plug for coolant			FS 2098 (SW 1,5)
	Gasket for bridge			FS 2099

For basic bodies for assembly parts, see page C 116.

IP = Torx Plus

Accessories

	Screwdriver for indexable insert	FS 1483 (IP 8)
	Screwdriver for extension	FS 1174 (T 25)
	Allen key DIN 911	SW 1,5 / SW 4
	Coolant supply adaptor for bridge	EB 636

IP = Torx Plus

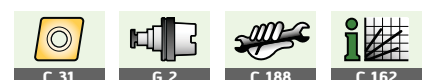

Reamers R 4060

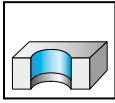

- diameter range 6-25 mm
- tolerance H6 for through holes

Tool	Designation	D _c mm	d ₁ mm	l ₄ mm	l ₅ mm	l ₈ mm	Z	kg	No. of indexable inserts	Indexable insert type
	R4060.Z10.06H6.00.C-E1	6	10	62	43	15	1	0,05	1	P 65... - 00R - ...
	R4060.Z10.07H6.0.C-E1	7	10	65	42	25	1	0,05	1	P 65... - 0R - ...
	R4060.Z10.08H6.0.C-E1	8	10	73	42	25	1	0,06	1	
	R4060.Z10.09H6.1.C-E1	9	10	73	42	25	1	0,06	1	P 65... - 1R - ...
	R4060.Z10.10H6.1.C-E1	10	10	74	41	25	1	0,07	1	
	R4060.Z16.11H6.1.C-E1	11	16	81	52	25	1	0,12	1	
	R4060.Z16.12H6.1.C-E1	12	16	81	52	25	1	0,13	1	P 65... - 2R - ...
	R4060.Z16.13H6.2.C-E1	13	16	81	52	25	1	0,14	1	
	R4060.Z16.14H6.2.C-E1	14	16	81	52	25	1	0,14	1	
	R4060.Z16.15H6.2.C-E1	15	16	82	51	25	1	0,14	1	
	R4060.Z16.16H6.2.C-E1	16	16	82	51	25	1	0,15	1	
	R4060.Z20.17H6.2.C-E1	17	20	100	55	25	1	0,23	1	
	R4060.Z20.18H6.2.C-E1	18	20	100	55	25	1	0,24	1	
	R4060.Z20.19H6.2.C-E1	19	20	100	55	25	1	0,24	1	P 65... - 4R - ...
	R4060.Z20.20H6.4.C-E1	20	20	100	55	30	1	0,26	1	
	R4060.Z25.21H6.4.C-E1	21	25	128	63	30	1	0,41	1	
	R4060.Z25.22H6.4.C-E1	22	25	129	62	30	1	0,42	1	
	R4060.Z25.23H6.4.C-E1	23	25	129	62	30	1	0,43	1	
	R4060.Z25.24H6.4.C-E1	24	25	129	62	30	1	0,48	1	
	R4060.Z25.25H6.4.C-E1	25	25	129	62	30	1	0,48	1	

Bodies, assembly parts and wrenches are included in the scope of delivery.

R 4060.. C: Guide pads are made of Cermet, suitable for ISO material groups P, M, K.

Assembly parts		D _c mm	6	7-8	9	10-12	13-19	20-25
	Clamp		PK247	PK249	PK250	PK251	PK252	PK253
	Clamping screw		FS202 (Torx 6)	FS2023 (SW 0,9)	FS2024 (SW 1,3)	FS2024 (SW 1,3)	FS2025 (SW 1,5)	FS2026 (SW 2)
	Ball		FS2018	FS2018	FS2019	FS2019	FS2020	FS2021
	Adjusting screw		FS2027 (SW 0,9)	FS2027 (SW 0,9)	FS2028 (SW 1,3)	FS2028 (SW 1,3)	FS2029 (SW 1,5)	FS2030 (SW 2)

Accessories		D _c mm	6	7-8	9-12	13-19	20-25
	Key ISO 2936		ISO2936-0,9	ISO2936-0,9	ISO2936-1,3 (SW 1,3)		ISO2936-1,5 (SW 1,5)
	Screwdriver		FS1063 (Torx 6)				

Indexable inserts

	Number of cutting edges	l ₁ x l ₂ mm	s mm	rake angle	Chamfer	P		M		K		N		S		H	
						HC	HT	HC	HW	HC	HT	HC	HW	HC	HW	HC	HW
						WXK05	WCE10	WXP15	WK10	WXK05	WCE10	WXP15	WK10	WXK05	WCE10	WXP15	WK10
P6500-00R-A88-E1	1	11 X 1,5	1	0	E1												
P6500-00R-B88-E1	1	11 X 1,5	1	6	E1	☺	☺	☺	☺	☺	☺	☺	☺	☺	☺	☺	☺
P6500-00R-B88-E5	1	11 X 1,5	1	6	E5	☺	☺	☺	☺	☺	☺	☺	☺	☺	☺	☺	☺
P6500-0R-A88-E1	2	20 X 2,5	1,2	0	E1												
P6500-0R-B88-E1	2	20 X 2,5	1,2	6	E1	☺	☺	☺	☺	☺	☺	☺	☺	☺	☺	☺	☺
P6500-0R-B88-E5	2	20 X 2,5	1,2	6	E5	☺	☺	☺	☺	☺	☺	☺	☺	☺	☺	☺	☺
P6500-1R-A88-E1	2	20 X 3,0	1,5	0	E1												
P6500-1R-B88-E1	2	20 X 3,0	1,5	6	E1	☺	☺	☺	☺	☺	☺	☺	☺	☺	☺	☺	☺
P6500-1R-B88-E5	2	20 X 3,0	1,5	6	E5	☺	☺	☺	☺	☺	☺	☺	☺	☺	☺	☺	☺
P6500-2R-A88-E1	2	20 X 4,5	2	0	E1												
P6500-2R-B88-E1	2	20 X 4,5	2	6	E1	☺	☺	☺	☺	☺	☺	☺	☺	☺	☺	☺	☺
P6500-2R-B88-E5	2	20 X 4,5	2	6	E5	☺	☺	☺	☺	☺	☺	☺	☺	☺	☺	☺	☺
P6500-4R-A88-E1	2	25 X 7,0	2,3	0	E1												
P6500-4R-B88-E1	2	25 X 7,0	2,3	6	E1	☺	☺	☺	☺	☺	☺	☺	☺	☺	☺	☺	☺
P6500-4R-B88-E5	2	25 X 7,0	2,3	6	E5	☺	☺	☺	☺	☺	☺	☺	☺	☺	☺	☺	☺

HC = Coated carbide
 HT = Cermet
 HW = Uncoated carbide

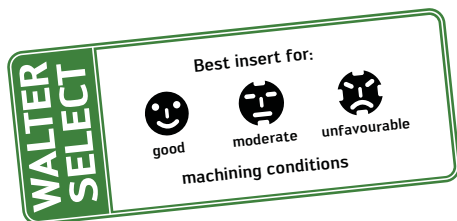

Reamers R 4061

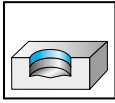

- diameter range 8-25 mm
- tolerance H6 for blind holes

Tool	Designation	D _c mm	d ₁ mm	l ₄ mm	l ₅ mm	l ₈ mm	Z	kg	No. of indexable inserts	Indexable insert type
	R4061.Z10.08H6.0.C-E1	8	10	73	42	25	1	0,05	1	P 65... - 0R - ...
	R4061.Z10.09H6.1.C-E1	9	10	73	41	25	1	0,06	1	P 65... - 1R - ...
	R4061.Z10.10H6.1.C-E1	10	10	74	41	25	1	0,06	1	
	R4061.Z16.11H6.1.C-E1	11	16	81	41	25	1	0,12	1	
	R4061.Z16.12H6.1.C-E1	12	16	81	52	25	1	0,13	1	P 65... - 2R - ...
	R4061.Z16.13H6.2.C-E1	13	16	81	52	25	1	0,14	1	
	R4061.Z16.14H6.2.C-E1	14	16	81	52	25	1	0,14	1	
	R4061.Z16.15H6.2.C-E1	15	16	82	51	25	1	0,15	1	
	R4061.Z16.16H6.2.C-E1	16	16	82	51	25	1	0,16	1	
	R4061.Z20.17H6.2.C-E1	17	20	100	51	25	1	0,23	1	P 65... - 4R - ...
	R4061.Z20.18H6.2.C-E1	18	20	100	55	25	1	0,24	1	
	R4061.Z20.19H6.2.C-E1	19	20	100	55	25	1	0,24	1	
	R4061.Z20.20H6.4.C-E1	20	20	100	55	30	1	0,25	1	P 65... - 4R - ...
	R4061.Z25.21H6.4.C-E1	21	25	128	63	30	1	0,26	1	
	R4061.Z25.22H6.4.C-E1	22	25	129	63	30	1	0,27	1	
	R4061.Z25.23H6.4.C-E1	23	25	129	62	30	1	0,28	1	
	R4061.Z25.24H6.4.C-E1	24	25	129	62	30	1	0,29	1	
R4061.Z25.25H6.4.C-E1	25	25	129	62	30	1	0,49	1		

Bodies, assembly parts and wrenches are included in the scope of delivery.

R 4060.. C: Guide pads are made of Cermet, suitable for ISO material groups P, M, K.

Assembly parts		D _c mm	8	9	10-12	13-19	20-25
	Clamp		PK249	PK250	PK251	PK252	PK253
	Clamping screw		FS2023 (SW 0,9)	FS2024 (SW 1,3)	FS2024 (SW 1,3)	FS2025 (SW 1,5)	FS2026 (SW 2)
	Ball		FS2018	FS2019	FS2019	FS2020	FS2021
	Adjusting screw		FS2027 (SW 0,9)	FS2028 (SW 1,3)	FS2028 (SW 1,3)	FS2029 (SW 1,5)	FS2030 (SW 2)

Accessories		D _c mm	8	9-12	13-19	20-25
	Key ISO 2936		ISO2936-0,9	ISO2936-1,3 (SW 1,3)	ISO2936-1,5 (SW 1,5)	ISO2936-2 (SW 2)

Indexable inserts

	Number of cutting edges	l ₁ x l ₂ mm	s mm	rake angle	Chamfer	P		M		K		N		S		H	
						HC	HT	HC	HW	HC	HT	HC	HW	HC	HW	HC	HW
						WXX05	WCE10	WXP15	WK10	WXX05	WCE10	WXP15	WK10	WXX05	WCE10	WXP15	WK10
P6500-0R-A88-E1	2	20 X 2,5	1,2	0	E1												
P6500-0R-B88-E1	2	20 X 2,5	1,2	6	E1												
P6500-0R-B88-E5	2	20 X 2,5	1,2	6	E5												
P6500-1R-A88-E1	2	20 X 3,0	1,5	0	E1												
P6500-1R-B88-E1	2	20 X 3,0	1,5	6	E1												
P6500-1R-B88-E5	2	20 X 3,0	1,5	6	E5												
P6500-2R-A88-E1	2	20 X 4,5	2	0	E1												
P6500-2R-B88-E1	2	20 X 4,5	2	6	E1												
P6500-2R-B88-E5	2	20 X 4,5	2	6	E5												
P6500-4R-A88-E1	2	25 X 7,0	2,3	0	E1												
P6500-4R-B88-E1	2	25 X 7,0	2,3	6	E1												
P6500-4R-B88-E5	2	25 X 7,0	2,3	6	E5												

HC = Coated carbide
 HT = Cermet
 HW = Uncoated carbide

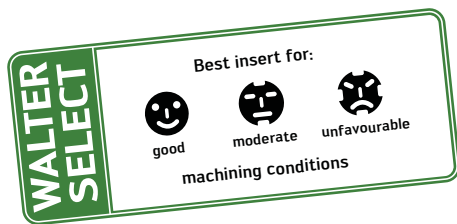

Setting devices for reamers

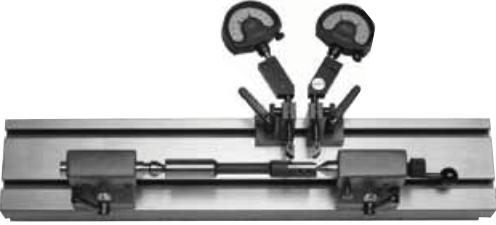
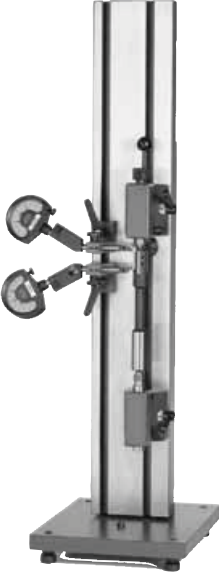
Setting device	Designation	Distance between centres [mm]	Centre height [mm]	Adjustable up to $D_{C \max}$ [mm]
	EG-350-H	350	50	60
	EG-500-V	500	50	60
	EG-800-V	800	100	150

The gauges are not included in the scope of delivery.

Spare parts	for EG-350-H	for EG-500-V	for EG-800-V	Description
Calliper angular adaptors	112302P050	112302P050	112302P050	30° / L = 50 mm
Tail stock	RST-50-EG	RST-50-EG		for a centre height of 50 mm
			RST-100-EG	for a centre height of 100 mm
Calliper holder	TH-50	TH-50		for a centre height of 50 mm
			TH-100	for a centre height of 100 mm
Centre no. 3	V610.350.03	V610.350.03		$d_{\max} = 17 \text{ mm}$, 60°
Calliper stylus	1131510			Carbide measuring surface 8 mm Measuring distance min. 6 mm

Spare parts are included in the scope of delivery.

Setting devices for reamers

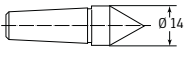
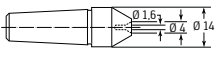
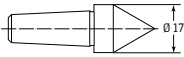
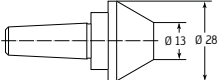
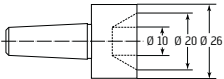
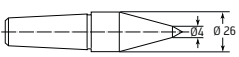
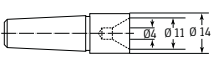
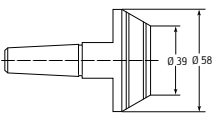
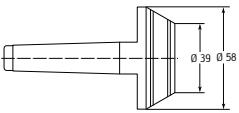
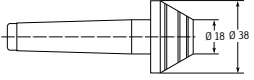
Accessories	Description	For EG-350-H	For EG-500-V	For EG-800-V
	Centre d max = 14 mm, 60°	V610.350.01	V610.350.01	
	Centre d max = 14 mm, 60° End face with chamfer dia. = 4 mm	V610.350.02	V610.350.02	
	Centre* d max = 17 mm, 60°	V610.350.03	V610.350.03	
	Centre d min = 13 mm, d max = 28 mm Truncated cone 60°	V610.350.04	V610.350.04	
	Centre d min = 10 mm, d max = 26 mm End face Ø = 20 mm with chamfer 60°	V610.350.05	V610.350.05	
	Centre d min = 4 mm, d max = 26 mm, 60° / 30°	V610.350.06	V610.350.06	
	Centre d max = 14 mm End face Ø = 11 mm with chamfer 60°	V610.350.07	V610.350.07	
	Centre for holding HSK 40, 50 and 63 adaptors	V610.350.08	V610.350.08	
	Centre with shank MK 2 for HSK 40, 50, 63 for RST-100			V610.800.01
	Centre with shank MK 2 for HSK 80, 100 for RST-100			V610.800.02
Calliper	HM measuring surface B = 12 mm Measuring distance min. ~ 2 mm	1131510-So-12		
Analogue gauge	Mahr Millimess dial comparator model 1003	4334000		
Digital gauge	Mahr MarCator 1087	4337060		
Measuring extension	Extension for indicators and Millimess	573 / 29-10		





* Contained in basic unit
Optional accessories

Product range overview

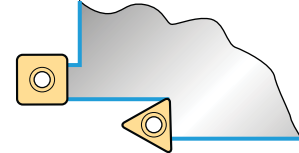
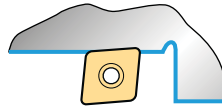
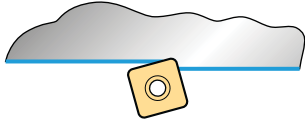
Standard assembly parts for Walter special boring tools

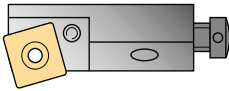
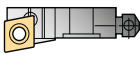
Boring and counterboring

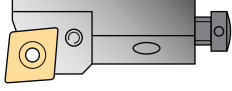
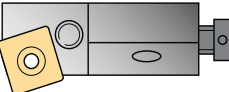
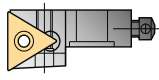
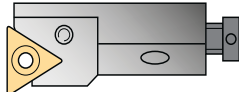
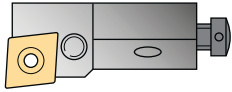

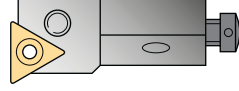
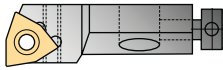
$K = 75^\circ$	$K = 90^\circ$	$K = 90^\circ$	$K = 95^\circ$
 <p>$D_c \text{ min}$ 50 mm PSKN R/L Page C 131</p>	 <p>$D_c \text{ min}$ 14,5 mm FR/FL 670 20 mm FR/FL 671 Page C 138</p>	 <p>$D_c \text{ min}$ 40 mm SCFC R/L Page C 133</p>	 <p>$D_c \text{ min}$ 50 mm PCLN R/L Page C 130</p>
 <p>$D_c \text{ min}$ 40 mm SSKC R/L Page C 134</p>	 <p>$D_c \text{ min}$ 20 mm FR/FL 672 Page C 140</p>	 <p>$D_c \text{ min}$ 50 mm PTFN R/L Page C 132</p>	 <p>$D_c \text{ min}$ 40 mm SCLC R/L Page C 133</p>
	 <p>$D_c \text{ min}$ 14,5 mm FR 679 20 mm FR 680 Page C 138</p>	 <p>$D_c \text{ min}$ 40 mm STFC R/L 50 mm PTFC R/L Page C 136</p>	
		 <p>$D_c \text{ min}$ 40 mm SWFC R/L Page C 131</p>	

Chamfering and counterboring			Precision boring
K = 15°	K = 45°	K = 60°	K = 90°
<p>$D_{c \text{ min}}$ 20 mm FR 701 $D_{c \text{ min}}$ 25 mm FR/FL 702 Page C 141</p>	<p>$D_{c \text{ min}}$ 20 mm FR 699 $D_{c \text{ min}}$ 25 mm FR/FL 704 Page C 141</p>	<p>$D_{c \text{ min}}$ 20 mm FR/FL 698 $D_{c \text{ min}}$ 25 mm FR 705 Page C 142</p>	<p>$D_{c \text{ min}}$ 28 mm FR/FL 710 Page C 143</p>
K = 30°	K = 45°	K = 60°	K = 95°
<p>$D_{c \text{ min}}$ 20 mm FR 675 Page C 139</p>	<p>$D_{c \text{ min}}$ 20 mm FR/FL 673 Page C 139</p>	<p>$D_{c \text{ min}}$ 20 mm FR/FL 674 Page C 139</p>	<p>Wiper $D_{c \text{ min}}$ 28 mm FR/FL 717 Page C 143</p>
	K = 45°	K = 75°	K = 90°
	<p>$D_{c \text{ min}}$ 40 mm SSSC R/L $D_{c \text{ min}}$ 60 mm PSSC R/L Page C 135</p>	<p>$D_{c \text{ min}}$ 20 mm FR 697 $D_{c \text{ min}}$ 25 mm FR 706 Page C 142</p>	<p>$D_{c \text{ min}}$ 36 mm FR/FL 709 Page C 144</p>
		K = 75°	K = 95°
		<p>$D_{c \text{ min}}$ 20 mm FR/FL 707 Page C 140</p>	<p>Wiper $D_{c \text{ min}}$ 28 mm FR/FL 711 Page C 144</p>
		K = 75°	
		<p>$D_{c \text{ min}}$ 40 mm SSRC R/L Page C 134</p>	

ISO cartridges

PCLN

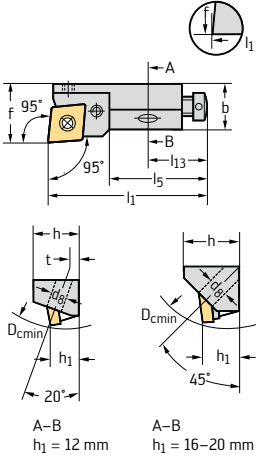

Tool

 $\kappa = 95^\circ$

Designation	h_1	b mm	D_{cmin} mm	d_8 mm	l_{13} mm	f mm	h mm	l_1 mm	l_5 mm	t mm	Insert type
PCLNR/L12CA-12	12	16	50	7	20	20	20	55	28	6	CNM . 1204 ..
PCLNR/L16CA-12	16	20	60	9	25	25	25	63	35		
PCLNR/L20CA-16	20	20	70	9	30	25	30	70	40		CNM . 1606 ..

Measured with master insert CNM . 120408 / CNM . 160612.

For radial / axial adjustment range, see page C 192.

Bodies and assembly parts are included in the scope of delivery.

Assembly parts

Insert type h_1	CNM . 1204 . . 12	CNM . 1204 . . 16	CNM . 1606 . . 20
Shim		AP134-CN1216	AP135-CN1624
Lever	KN109	KN102	KN104
Clamping screw for indexable insert	FS332 (SW 2,5)	FS352 (SW 3)	FS354 (SW 3)
Pipe pin		RS102	RS103
Assembly plug		MD101	MD102
Adjusting screw, axial	FS335	FS338	FS339
Adjusting screw, radial	FS334	FS337	FS337

Accessories

Insert type h_1	CNM . 1204 . . 12	CNM . 1204 . . 16	CNM . 1606 . . 20
Screw ISO 7380	FS977	FS975	FS975
Allen key ISO 2936	ISO 2936-2.5 (SW 2,5)	ISO 2936-3 (SW 3)	ISO 2936-3 (SW 3)



ISO cartridges PSKN



Tool		Designation	l ₁₄ mm	h ₁	b mm	D _{cmin} mm	d ₈ mm	l ₁₃ mm	f mm	h mm	l ₁ mm	l ₅ mm	t mm	Insert type	
κ = 75° 		PSKNR/L12CA-12	3,1	12	15	50	7	20	20	20	55	32	6	SNM . 1204 . .	
		PSKNR/L16CA-12	3,1	16	20	60	9	25	25	25	63	37			
		PSKNR/L20CA-15	3,8	20	20	70	9	30	25	30	70	40			SNM . 1506 . .

Measured with master insert SNM . 120408 / SNM . 150612.
 For radial / axial adjustment range, see page C 192.
 Bodies and assembly parts are included in the scope of delivery.

Assembly parts	Insert type h ₁	SNM . 1204 . . 12	SNM . 1204 . . 16	SNM . 1506 . . 20
	Shim		AP141-SN1216	AP142-SN1524
	Lever	KN109	KN102	KN104
	Clamping screw for insert	FS332 (SW 2,5)	FS352 (SW 3)	FS354 (SW 3)
	Pipe pin		RS102	RS103
	Assembly plug		MD101	MD102
	Adjusting screw, axial	FS335	FS338	FS339
	Adjusting screw, radial	FS333	FS337	FS337

Accessories	Indexable insert type h ₁	SNM . 1204 . . 12	SNM . 1204 . . 16	SNM . 1506 . . 20
	Allen key ISO 2936	ISO 2936-2,5 (SW 2,5)	ISO 2936-3 (SW 3)	ISO 2936-3 (SW 3)
	Screw ISO 7380	FS977	FS975	FS975

ISO cartridges

PTFN

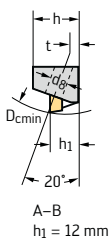
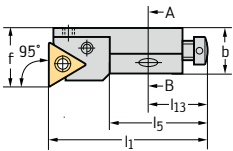

Tool

 $\kappa = 90^\circ$

Designation	h ₁	b mm	D _{cmin} mm	d ₈ mm	l ₁₃ mm	f mm	h mm	l ₁ mm	l ₅ mm	t mm	Insert type
PTFNR/L12CA-16	12	15	50	7	20	20	20	55	32,5	6	TNM . 1604 . .

Measured with master insert TNM . 160408.
 For radial / axial adjustment range, see page C 192.
 Bodies and assembly parts are included in the scope of delivery.

Assembly parts

Indexable insert type h ₁	TNM . 1604 . . 12
Lever	KN108
Clamping screw for insert	FS331 (SW 2)
Adjusting screw, axial	FS335
Adjusting screw, radial	FS333

Accessories

Indexable insert type h ₁	TNM . 1604 . . 12
Screw ISO 7380	FS977
Allen key ISO 2936	ISO 2936-2 (SW 2)



ISO cartridges SCLC / SCFC



Tool	Designation	h_1	b mm	D_{cmin} mm	d_8 mm	l_{13} mm	f mm	h mm	l_1 mm	l_5 mm	t mm	Indexable insert type
$\kappa = 95^\circ$	SCLCR/L10CA-09	10	11	40	7	20	14	5	50	33	5	CC...09T3..
	SCLCR/L12CA-12	12	16	50	7	20	20	20	55	32	6	CC...1204..
$\kappa = 90^\circ$	SCFCR/L10CA-09	10	11	40	7	20	14	15	50	33	5	CC...09T3..
	SCFCR/L12CA-12	12	16	50	7	20	20	20	55	32	6	CC...1204..

Measured with master insert CC...09T308 / CC...120408.

For radial / axial adjustment range, see page C 192. Bodies and assembly parts are included in the scope of delivery.

Assembly parts	Indexable insert type h_1	CC...09T3.. 10	CC...1204.. 12
	Clamping screw for indexable insert Tightening torque	FS359 (Torx 15) 2,5 Nm	FS1029 (Torx 20) 5,0 Nm
	Adjusting screw, radial	FS369	FS334
	Adjusting screw, axial	FS335	FS335

Accessories	Indexable insert type h_1	CC...09T3.. 10	CC...1204.. 12
	Screw ISO 7380	FS976	FS977
	Screwdriver	FS229 (Torx 15)	FS228 (Torx 20)

ISO cartridges SSSC / SSKC



Tool	Designation	l_{14} mm	h_1	b mm	D_{cmin} mm	d_8 mm	l_{13} mm	f mm	h mm	l_1 mm	l_5 mm	t mm	Indexable insert type
$\kappa = 75^\circ$ 	SSKCR/L10CA-09	2,2	10	11	40	7	20	14	15	50	33	5	SC...09T3..
$\kappa = 75^\circ$ 	SSRRCR/L10CA-09		10	11	40	7	20	14	15	50	33	5	SC...09T3..

Measured with master insert SC...09T308 / SC...120408.

For radial / axial adjustment range, see page C 192. Bodies and assembly parts are included in the scope of delivery.

Assembly parts	Indexable insert type h_1	SC...09T3... 10
	Clamping screw for insert	FS359 (Torx 15) 2,5 Nm
	Adjusting screw, radial	FS369
	Adjusting screw, axial	FS335

Accessories	Indexable insert type h_1	SC...09T3... 10
	Screw ISO 7380	FS976
	Screwdriver	FS229 (Torx 15)



ISO cartridges SSSC / PSSC



Tool		Designation	l ₁₄ mm	h ₁	b mm	D _{cmin} mm	d ₈ mm	l ₁₃ mm	f mm	h mm	l ₁ mm	l ₅ mm	t mm	Indexable insert type
κ = 45°		PSSCR/L16CA-12	8,3	16	20	60	9	25	25	25	53	39		SC...1204..
		SSSCR/L10CA-09	6,1	10	11	40	7	20	14	15	44	33	5	SC...09T3..
	A-B h ₁ = 12 mm													
	A-B h ₁ = 16 mm													

Measured with master insert SC...09T308 / SC...120408.

For radial / axial adjustment range, see page C 192.

Bodies and assembly parts are included in the scope of delivery.

Assembly parts	Indexable insert type h ₁	SC...09T3... 10	SC...1204... 16
	Lever		KN116
	Clamping screw for insert	FS359 (Torx 15) 2,5 Nm	FS376
	Adjusting screw, axial	FS335	FS335
	Adjusting screw, radial	FS369	FS337

Accessories	Indexable insert type h ₁	SC...09T3... 10	SC...1204... 16
	Screw ISO 7380	FS976	FS975
	Screwdriver	FS229 (Torx 15)	
	Allen key ISO 2936		ISO 2936-2,5 (SW 2,5)



ISO cartridges SWFC



Tool	Designation	h_1	b mm	D_{cmin} mm	d_8 mm	l_{13} mm	f mm	h mm	l_1 mm	l_5 mm	t mm	Indexable insert type
$\kappa = 90^\circ 30'$ 	SWFCR/L10CA-06	10	11	40	7	20	14	15	50	33	5	WC...06T3...

Measured with master insert WC...06T308.
 For radial / axial adjustment range, see page C 192.
 Bodies and assembly parts are included in the scope of delivery.

Assembly parts	Indexable insert type h_1	WC...06T3... 10
	Clamping screw for insert	FS359 (Torx 15)
	Adjusting screw, radial	FS369
	Adjusting screw, axial	FS335

Accessories	Indexable insert type h_1	WC...06T3... 10
	Screw ISO 7380	FS976
	Screwdriver	FS229 (Torx 15)

Mini Cartridge 90°



Tool	Designation	D _{c min} mm	d ₈ mm	l ₁₃ mm	f mm	h ₁ mm	l ₁ mm	t mm	Indexable insert type
κ = 90° 	FR670/FL670	14,5	3,4	10,5	8	6	25	2,3	CP .. 0502 ..
	FR671/FL671	20	3,4	10,5	9,7	6	25	2,3	CC .. 0602 ..
κ = 90° 	FR679	14,5	3,4	10,5	8	6	25	2,3	WC .. 0302 ..
	FR680	20	3,4	10,5	9,7	6	25	2,3	WC .. 0402 ..

Measured with master insert CP..050202 / CC..060202.

For radial / axial adjustment range, see page C 192.

Bodies, assembly parts and wrenches are included in the scope of delivery.

Assembly parts	Indexable insert type	WC .. 0302 ..	WC .. 0402 ..
	Clamping screw for insert Tightening torque	FS1020 (Torx 7) 0,6 Nm	FS924 (Torx 8)
	Adjusting screw, radial	FS493	FS493
	Adjusting screw, axial	FS1023	FS1023
	Fastening screw	FS1024	FS1024

Accessories	Indexable insert type	WC .. 0302 ..	WC .. 0402 ..
	Screwdriver	FS309 (Torx 7)	FS230 (Torx 8)

Mini Cartridge 30, 45 & 60°



Tool	Designation	l ₁₄ mm	D _{cmin} mm	d ₈ mm	l ₁₃ mm	f mm	h ₁ mm	l ₁ mm	t mm	Indexable insert type
κ = 30° 	FR675	5,2	20	4,5	12	10,8	8	22,8	3,2	TC..1102..
κ = 45° 	FR673	7,4	20	4,5	12	10,8	8	20,6	3,2	TC..1102..
κ = 60° 	FR674	9,1	20	4,5	12	11	8	18,9	3,2	TC..1102..

Measured with master insert TC..110202.

For radial / axial adjustment range, see page C 192. Bodies, assembly parts and wrenches are included in the scope of delivery.

Assembly parts	Indexable insert type	TC..1102..
	Clamping screw for insert	FS375 (Torx 7)
	Adjusting screw, radial	FS494
	Adjusting screw, axial	FS1023
	Fastening screw	FS2106

Accessories	Indexable insert type	TC..1102..
	Screwdriver	FS309 (Torx 7)

Mini Cartridge 75 & 90°



Tool	Designation	l ₁₄ mm	D _{c min} mm	d ₈ mm	l ₁₃ mm	f mm	h ₁ mm	l ₁ mm	t mm	Indexable insert type
κ = 75° 	FR707/FL707	10,1	20	4,5	12	11	8	17,9	3,2	TC .. 1102 ..
κ = 90° 	FR672/FL672		20	4,5	12	11	8	28	3,2	TC .. 1102 ..

Measured with master insert TC..110202.

For radial / axial adjustment range, see page C 192.

Bodies, assembly parts and wrenches are included in the scope of delivery.

Assembly parts	Indexable insert type	TC .. 1102 ..
	Clamping screw for insert	FS375 (Torx 7)
	Adjusting screw, radial	FS494
	Adjusting screw, axial	FS1023
	Fastening screw	FS2106

Accessories	Indexable insert type	TC .. 1102 ..
	Screwdriver	FS309 (Torx 7)



Mini Cartridge 15 & 45°



Tool		l_{14} mm	D_{cmin} mm	d_8 mm	l_{13} mm	f mm	h_1 mm	l_1 mm	t mm	Indexable insert type
$\kappa = 15^\circ$ A-B	FR701	1,4	20	3,4	10,5	9,7	6	23,6	2,3	P 284... - 1
	FR702/FL702	1,7	25	4,5	12	11,5	8	26,3	3,2	P 284... - 2
$\kappa = 45^\circ$ A-B	FR699	3,7	20	3,4	10,5	9,7	6	22,2	2,3	P 284... - 1
	FR704/FL704	4,6	25	4,5	12	11,5	8	23,4	3,2	P 284... - 2

Measured with master insert P 284.. - 1 / P 284.. - 2.

For radial / axial adjustment range, see page C 192.

Bodies, assembly parts and wrenches are included in the scope of delivery.

Assembly parts		Indexable insert type	P 284... - 1	P 284... - 2
	Adjusting screw, radial		FS493	FS494
	Adjusting screw, axial		FS1023	FS1023
	Fastening screw		FS1024	FS2106
	Clamping screw for insert		FS924 (Torx 8)	FS1005 (Torx 8)
	Tightening torque			1,0 Nm

Accessories		Indexable insert type	P 284... - 1	P 284... - 2
	Screwdriver		FS230 (Torx 8)	FS230 (Torx 8)

Mini Cartridge 60°



Tool	Designation	l ₁₄ mm	D _{cmin} mm	d ₈ mm	l ₁₃ mm	f mm	h ₁ mm	l ₁ mm	t mm	Indexable insert type
κ = 60° 	FR698/FL698	4,8	20	3,4	10,5	9,7	6	20,2	2,3	P 284 .. - 1
	FR705	5,9	25	4,5	12	11,5	8	22,1	3,2	P 284 .. - 2
κ = 75° 	FR697	5,5	20	3,4	10,5	9,7	6	19,5	2,3	P 284 .. - 1
	FR706	6,8	25	4,5	12	11,5	8	21,2	3,2	P 284 .. - 2

Measured with master insert P 284.. - 1 / P 284.. - 2.

For radial / axial adjustment range, see page C 192.

Bodies, assembly parts and wrenches are included in the scope of delivery.

Assembly parts	Indexable insert type	P 284 .. - 1	P 284 .. - 2
	Adjusting screw, radial	FS493	FS494
	Adjusting screw, axial	FS1023	FS1023
	Fastening screw	FS1024	FS2106
	Clamping screw for insert	FS924 (Torx 8)	FS1005 (Torx 8)
	Tightening torque		1,0 Nm

Accessories	Indexable insert type	P 284 .. - 1	P 284 .. - 2
	Screwdriver	FS230 (Torx 8)	FS230 (Torx 8)



Precision boring cartridge



Tool	Designation	D _{cmin} mm	d ₈ mm	l ₁₃ mm	f mm	h ₁ mm	l ₁ mm	t mm	Indexable insert type
κ = 90° A-B	FR710/FL710	28	4,5	9,25	16	8,5	45,8	1	CC . . 0602 . .
κ = 95° A-B	FR717/FL717	28	4,5	9,25	16	8,5	45,8	1	CC . . 0602 . .

Measured with master insert CC . . 060204.
 For radial / axial adjustment range, see page C 192.
 Bodies and assembly parts are included in the scope of delivery.

Assembly parts	Indexable insert type	CC . . 0602 . .
	Clamping screw	FS1129 (Torx 8)
	Clamping screw for cartridge	FS1354
	Compression piece	FS369
	Adjusting screw, axial	FS1355
	Adjusting screw, radial	FS2106



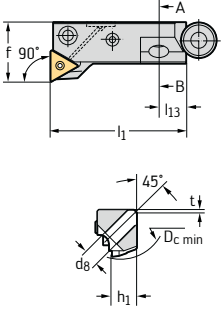
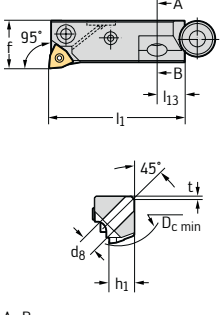

Accessories	Indexable insert type	CC . . 0602 . .
	Screwdriver	FS257 (Torx 8)

Precision boring cartridge



Tool	Designation	D_{cmin} mm	d_8 mm	l_{13} mm	f mm	h_1 mm	l_1 mm	t mm	Indexable insert type
$\kappa = 90^\circ$  A-B	FR709/FL709	36	4,5	9,25	20	8,5	45,8	1	TC . . 1102 . .
$\kappa = 95^\circ$  A-B	FR711/FL711	28	4,5	9,25	16	8,5	45,8	1	WC . . 0402 . .

Measured with master insert TC . . 110204.
 For radial / axial adjustment range, see page C 192.
 Bodies and assembly parts are included in the scope of delivery.

Assembly parts	Indexable insert type	TC . . 1102 . .
	Clamping screw	FS1129 (Torx 8)
	Clamping screw for cartridge	FS1354
	Compression piece	FS369
	Adjusting screw, axial	FS1355
	Adjusting screw, radial	FS2106

Accessories	Indexable insert type	TC . . 1102 . .
	Screwdriver	FS257 (Torx 8)



Cutting data for drilling with Xtra-tec® Point Drill D_C 12–38 mm

Material group	Structure of main material groups and identification letters		Brinell hardness HB	Tensile strength R _m N/mm ²	Machining group ¹			Insert geometry			
								Starting values for feed f [mm/rev]			
								P6001 P6002			
								D _C [mm]			
								12,0–15,9	16,0–21,9	22,0–31,99	
P	Unalloyed steel	C ≤ 0,25%	annealed	125	428	P1	●●		0,2	0,25	0,3
		C > 0,25 ... ≤ 0,55 %	annealed	190	639	P2	●●		0,2	0,25	0,3
		C > 0,25 ... ≤ 0,55 %	tempered	210	708	P3	●●		0,2	0,25	0,3
		C > 0,55 %	annealed	190	639	P4	●●		0,2	0,25	0,3
		C > 0,55 %	tempered	300	1013	P5	●●		0,15	0,2	0,22
		free cutting steel (short-chipping)	annealed	220	745	P6	●●	●	0,18	0,22	0,25
	Low-alloyed steel		annealed	175	591	P7	●●		0,2	0,25	0,3
			tempered	300	1013	P8	●●		0,2	0,25	0,3
			tempered	380	1282	P9	●●		0,18	0,22	0,25
			tempered	430	1477	P10	●●		0,15	0,2	0,22
	High-alloyed steel and high-alloyed tool steel		annealed	200	675	P11	●●		0,15	0,2	0,22
			hardened and tempered	300	1013	P12	●●		0,12	0,15	0,2
			hardened and tempered	400	1361	P13	●●		0,1	0,12	0,8
	Stainless steel		ferritic / martensitic, annealed	200	675	P14	●●		0,15	0,2	0,22
			martensitic, tempered	330	1114	P15	●●		0,12	0,15	0,2
M	Stainless steel		austenitic, quench hardened	200	675	M1	●●				
			austenitic, precipitation hardened (PH)	300	1013	M2					
			austenitic / ferritic, duplex	230	778	M3	●●				
K	Malleable cast iron		ferritic	200	675	K1	●●	●	0,2	0,25	0,3
			pearlitic	260	867	K2	●●	●	0,2	0,25	0,3
	Grey cast iron		low tensile strength	180	602	K3	●●	●	0,2	0,25	0,4
			high tensile strength / austenitic	245	825	K4	●●	●	0,2	0,25	0,4
	Cast iron with spheroidal graphite		ferritic	155	518	K5	●●	●	0,2	0,25	0,35
			pearlitic	265	885	K6	●●	●	0,2	0,25	0,35
		GGV (CGI)		200	675	K7	●●	●	0,18	0,2	0,25
N	Aluminium wrought alloys		cannot be hardened	30	–	N1	●●				
			hardenable, hardened	100	343	N2	●●				
	Cast aluminium alloys		≤ 12 % Si, cannot be hardened	75	260	N3	●●				
			≤ 12 % Si, hardenable, hardened	90	314	N4	●●				
			> 12 % Si, cannot be hardened	130	447	N5	●●	●			
	Magnesium alloys			70	250	N6	●●				
	Copper and copper alloys (bronze / brass)		unalloyed, electrolytic copper	100	343	N7	●●				
			brass, bronze, red brass	90	314	N8	●●				
		Cu-alloys, short-chipping	110	382	N9	●●	●				
	high-strength, Ampco		300	1013	N10						
S	Heat-resistant alloys	Fe-based		annealed	200	675	S1	●●			
				hardened	280	943	S2	●●			
		Ni or Co base		annealed	250	839	S3	●●			
				hardened	350	1177	S4	●●			
				cast	320	1076	S5	●●			
	Titanium alloys		pure titanium	200	675	S6					
			α and β alloys, hardened	375	1262	S7	●●				
		β alloys	410	1396	S8	●●					
	Tungsten alloys			300	1013	S9					
	Molybdenum alloys			300	1013	S10					
H	Hardened steel		hardened and tempered	50 HRC	–	H1					
			hardened and tempered	55 HRC	–	H2					
			hardened and tempered	60 HRC	–	H3					
	Hardened cast iron		hardened and tempered	55 HRC	–	H4					
O	Thermoplasts		without abrasive fillers			O1					
	Thermosetting plastics		without abrasive fillers			O2					
	Plastic, glass-fibre reinforced		GFRP			O3					
	Plastic, carbon-fibre reinforced		CFRP			O4					
	Plastic, aramid fibre reinforced		AFRP			O5					
	Graphite (technical)			80 Shore		O6					

¹ The machining groups are assigned from H 8 onwards.

- Recommended application (the specified cutting data are regarded as starting values for the recommended application).
- Possible application. Limited to 2 x D_C drilling depth. MQL (minimum quantity lubrication) or compressed air is recommended.

Centring with a B4011 / B4013 is recommended when using the B4017.
A pilot hole approx. 1 x D_C with a B4011 / B4013 is strictly necessary when using the B4010!

Cutting data for drilling with Xtra-tec® Insert Drill D_C 13.5–59 mm

Material group	Structure of main material groups and identification letters		Brinell hardness HB	Tensile strength R _m N/mm ²	Machining group ¹		Insert geometry						
							Starting values for feed f [mm/rev]						
							A 57						
							Size -1	Size -2	Size -3	Size -4	Size -5 Size -6	Size -7 Size -8	
D _C [mm]						13,5–16,4	16,5–20,4	20,5–24,4	24,5–29,4	29,5–42,4	42,5–59,4		
P	Unalloyed steel	C ≤ 0,25%	annealed	125	428	P1	●●	0,05	0,06	0,06	0,09	0,12	0,13
		C > 0,25 ... ≤ 0,55 %	annealed	190	639	P2	●●	0,07	0,09	0,10	0,13	0,18	0,19
		C > 0,25 ... ≤ 0,55 %	tempered	210	708	P3	●●	0,07	0,09	0,10	0,13	0,18	0,19
		C > 0,55 %	annealed	190	639	P4	●●	0,07	0,09	0,10	0,13	0,18	0,19
		C > 0,55 %	tempered	300	1013	P5	●●	0,07	0,09	0,10	0,13	0,18	0,19
		free cutting steel (short-chipping)	annealed	220	745	P6	●● ●	0,07	0,09	0,10	0,13	0,18	0,19
	Low-alloyed steel		annealed	175	591	P7	●●	0,08	0,10	0,12	0,15	0,20	0,21
			tempered	300	1013	P8	●●	0,07	0,09	0,10	0,13	0,15	0,16
			tempered	380	1282	P9	●●	0,07	0,09	0,10	0,13	0,15	0,16
			tempered	430	1477	P10	●●	0,05	0,06	0,06	0,09	0,12	0,13
High-alloyed steel and high-alloyed tool steel		annealed	200	675	P11	●●	0,08	0,10	0,12	0,15	0,18	0,19	
		hardened and tempered	300	1013	P12	●●	0,07	0,09	0,10	0,13	0,15	0,16	
		hardened and tempered	400	1361	P13	●●	0,06	0,08	0,09	0,12	0,14	0,15	
Stainless steel		ferritic / martensitic, annealed	200	675	P14	●●	0,07	0,09	0,10	0,13	0,15	0,16	
		martensitic, tempered	330	1114	P15	●●	0,06	0,08	0,09	0,12	0,14	0,15	
M	Stainless steel	austenitic, quench hardened	200	675	M1	●●	0,06	0,07	0,08	0,10	0,13	0,14	
		austenitic, precipitation hardened (PH)	300	1013	M2	●●	0,06	0,07	0,08	0,10	0,13	0,14	
		austenitic / ferritic, duplex	230	778	M3	●●	0,06	0,07	0,08	0,10	0,13	0,14	
K	Malleable cast iron	ferritic	200	675	K1	●● ●	0,09	0,12	0,14	0,17	0,22	0,23	
		pearlitic	260	867	K2	●● ●	0,07	0,09	0,11	0,14	0,19	0,20	
	Grey cast iron	low tensile strength	180	602	K3	●● ●	0,10	0,13	0,15	0,18	0,23	0,24	
		high tensile strength / austenitic	245	825	K4	●● ●	0,08	0,10	0,12	0,15	0,20	0,21	
	Cast iron with spheroidal graphite	ferritic	155	518	K5	●● ●	0,10	0,13	0,15	0,18	0,23	0,24	
		pearlitic	265	885	K6	●●	0,08	0,10	0,12	0,18	0,23	0,24	
	GGV (CGI)	200	675	K7	●● ●	0,09	0,12	0,14	0,17	0,22	0,23		
N	Aluminium wrought alloys	cannot be hardened	30	–	N1								
		hardenable, hardened	100	343	N2	●●							
	Cast aluminium alloys	≤ 12 % Si, cannot be hardened	75	260	N3	●●							
		≤ 12 % Si, hardenable, hardened	90	314	N4	●●							
		> 12 % Si, cannot be hardened	130	447	N5	●● ●							
	Magnesium alloys		70	250	N6	●●							
	Copper and copper alloys (bronze / brass)	unalloyed, electrolytic copper	100	343	N7								
brass, bronze, red brass		90	314	N8	●●								
Cu-alloys, short-chipping		110	382	N9	●● ●								
	high-strength, Ampco	300	1013	N10	●● ●	0,06	0,07	0,08	0,10	0,13	0,14		
S	Heat-resistant alloys	Fe-based	annealed	200	675	S1	●●						
			hardened	280	943	S2	●●						
		Ni or Co base	annealed	250	839	S3	●●						
			hardened	350	1177	S4	●●						
			cast	320	1076	S5	●●						
	Titanium alloys	pure titanium	200	675	S6								
	α and β alloys, hardened	375	1262	S7	●●								
	β alloys	410	1396	S8	●●								
	Tungsten alloys	300	1013	S9	●●	0,05	0,06	0,06	0,09	0,11	0,12		
	Molybdenum alloys	300	1013	S10	●●	0,05	0,06	0,06	0,09	0,11	0,12		
H	Hardened steel	hardened and tempered	50 HRC	–	H1	●●	0,05	0,06	0,06	0,09	0,10	0,10	
		hardened and tempered	55 HRC	–	H2	●●	0,05	0,06	0,06	0,09	0,10	0,10	
		hardened and tempered	60 HRC	–	H3	●●							
	Hardened cast iron	hardened and tempered	55 HRC	–	H4	●●	0,05	0,06	0,06	0,09	0,10	0,10	
O	Thermoplasts	without abrasive fillers			O1	●● ●							
	Thermosetting plastics	without abrasive fillers			O2	●● ●							
	Plastic, glass-fibre reinforced	GFRP			O3								
	Plastic, carbon-fibre reinforced	CFRP			O4								
	Plastic, aramid fibre reinforced	AFRP			O5								
	Graphite (technical)		80 Shore			O6	●● ●	0,09	0,12	0,14	0,17	0,22	0,23

¹ The machining groups are assigned from H 8 onwards.

- Recommended application (the specified cutting data are regarded as starting values for the recommended application).
- Possible application. Limited to 2 x D_C drilling depth. MQL (minimum quantity lubrication) or compressed air is recommended.

When using drills > 3 x D the following reductions are recommended:
 > 3 x D: cutting speed v_c –20 %, feed f –30 % when spot drilling, feed f –50 % when spot drilling on angled surfaces.
 > 4 x D: cutting speed v_c –30 %, feed f –40 % when spot drilling.

The specified cutting data are average recommended values.
For special applications, adjustment is recommended.

Insert geometry												Cutting material grade Outer insert [P484.P.]											
Starting values for feed f [mm/rev]												Starting values for cutting speed v _c [m/min]											
E 57						E 67						HC											
Size -1	Size -2	Size -3	Size -4	Size -5 Size -6	Size -7 Size -8	Size -1	Size -2	Size -3	Size -4	Size -5 Size -6	Size -7 Size -8	WKP 25 f [mm/rev]			WKP 35 f [mm/rev]			WSP 45 f [mm/rev]					
D _c [mm]						D _c [mm]						0,06	0,10	0,16	0,06	0,10	0,16	0,06	0,10	0,16			
13,5-16,4	16,5-20,4	20,5-24,4	24,5-29,4	29,5-42,4	42,5-59,4	13,5-16,4	16,5-20,4	20,5-24,4	24,5-29,4	29,5-42,4	42,5-59,4												
0,05	0,06	0,06	0,09	0,12	0,13	0,05	0,06	0,06	0,09	0,12	0,13	350	320		300	270		250	220				
0,06	0,07	0,08	0,11	0,17	0,18	0,06	0,07	0,08	0,11	0,17	0,18	260	240	220	220	200	180	170	160	150			
0,06	0,07	0,08	0,11	0,17	0,18							240	220	200	200	180	150	150	140	130			
0,06	0,07	0,08	0,11	0,17	0,18							220	200	180	180	150	140	140	130	120			
0,06	0,07	0,08	0,11	0,17	0,18							190	170	150	150	130	120	130	120	110			
0,06	0,07	0,08	0,11	0,17	0,18							220	200	180	180	150	140	140	130	120			
0,06	0,08	0,10	0,13	0,19	0,20	0,06	0,08	0,10	0,14	0,20	0,21	260	240	220	220	200	180	170	160	160			
0,06	0,07	0,08	0,11	0,14	0,15							230	210	190	190	170	140	140	130	120			
0,06	0,07	0,08	0,11	0,14	0,15							210	190	170	180	160	130	140	120	110			
0,05	0,06	0,06	0,09	0,11	0,12							190	170	160	170	140	130	140	120	110			
0,06	0,08	0,10	0,13	0,17	0,18	0,06	0,08	0,10	0,12	0,16	0,17	220	200	180	200	170	150	140	130	120			
0,06	0,07	0,08	0,11	0,14	0,15							200	170	150	180	140	130	130	120	110			
0,05	0,06	0,07	0,10	0,13	0,14							190	160	140	170	130	120	120	110	100			
0,06	0,07	0,08	0,11	0,14	0,15	0,06	0,07	0,08	0,11	0,14	0,15				190	170	150	140	130	120			
0,05	0,06	0,07	0,10	0,13	0,14	0,05	0,06	0,07	0,10	0,13	0,15				150	130	120	120	110	100			
0,06	0,07	0,08	0,10	0,13	0,14	0,06	0,07	0,09	0,12	0,14	0,15				220	200	180	180	170	150			
0,06	0,07	0,08	0,10	0,13	0,14	0,06	0,07	0,09	0,12	0,14	0,15				150	130	110	130	110	100			
0,06	0,07	0,08	0,10	0,13	0,14	0,06	0,07	0,09	0,12	0,14	0,15				120	100	80	100	80	70			
0,07	0,09	0,11	0,14	0,21	0,22	0,07	0,09	0,11	0,14	0,21	0,22	210	190	170	190	180	160	170	140	120			
0,05	0,07	0,08	0,11	0,18	0,19	0,05	0,07	0,09				190	140	120	130	120	110	130	120	110			
0,08	0,10	0,12	0,15	0,22	0,23	0,08	0,10	0,12	0,15	0,22	0,23	220	200	180	200	190	170	180	160	130			
0,06	0,08	0,09	0,12	0,19	0,20							180	150	130	150	130	110	150	130	110			
0,08	0,10	0,12	0,15	0,22	0,23	0,08	0,10	0,12	0,15	0,22	0,23	150	140	130	140	120	110	150	130	120			
0,06	0,08	0,09	0,12	0,22	0,23	0,06	0,08					140	130	120	120	110	100	120	110	110			
0,07	0,09	0,11	0,14	0,21	0,22	0,07	0,09	0,11	0,14	0,21	0,22	180	150	130	150	130	110	150	130	110			
0,07	0,09	0,10	0,12	0,17	0,18	0,07	0,09	0,11	0,12	0,17	0,18							450	450	450			
0,08	0,10	0,12	0,15	0,17	0,18	0,08	0,10	0,12	0,15	0,17	0,18							300	300	300			
0,08	0,10	0,12	0,15	0,17	0,18	0,08	0,10	0,12	0,15	0,17	0,18							250	250	250			
0,08	0,10	0,12	0,15	0,17	0,18	0,08	0,10	0,12	0,15	0,17	0,18							200	200	200			
0,08	0,10	0,12	0,15	0,17	0,18	0,08	0,10	0,12	0,15	0,17	0,18							300	300	300			
0,10	0,12	0,14	0,17	0,22	0,23	0,10	0,12	0,14	0,17	0,22	0,23							300	250	200			
0,10	0,12	0,14	0,17	0,22	0,23	0,10	0,12	0,14	0,17	0,22	0,23							350	300	250			
0,06	0,07	0,08	0,10	0,13	0,14	0,06	0,07	0,09	0,12	0,14	0,15				150	130	110	130	110	100			
0,05	0,06	0,07	0,10	0,13	0,14	0,05	0,06	0,07	0,10	0,13	0,14	100	100		100	100		90	90				
0,05	0,06	0,06	0,09	0,11	0,12	0,05	0,06	0,06	0,09	0,11	0,12	80	80		80	80		70	70				
0,05	0,06	0,07	0,10	0,12	0,13	0,05	0,06	0,07	0,10	0,12	0,13	60	60		60	60		50	50				
0,05	0,06	0,06	0,09	0,11	0,12	0,05	0,06	0,06	0,09	0,11	0,12	50	50		50	50		40	40				
0,05	0,06	0,06	0,09	0,11	0,12	0,05	0,06	0,06	0,09	0,11	0,12	50	50		50	50		40	40				
0,05	0,06	0,07	0,10	0,12	0,13	0,05	0,06	0,07	0,10	0,12	0,13				50	50		50	45				
0,05	0,06	0,06	0,09	0,11	0,12	0,05	0,06	0,06	0,09	0,11	0,12				50	50		40	40				
0,05	0,06	0,06	0,09	0,11	0,12	0,05	0,06	0,06	0,09	0,11	0,12	70	60										
0,05	0,06	0,06	0,09	0,11	0,12	0,05	0,06	0,06	0,09	0,11	0,12	70	60										
0,05	0,06	0,06	0,09	0,10	0,10							70	60	50									
0,05	0,06	0,06	0,09	0,10	0,10							60	50	50									
0,05	0,06	0,06	0,09	0,10	0,10							60	50	50									
0,16	0,18	0,20	0,25	0,30	0,30	0,16	0,18	0,20	0,25	0,30	0,30				400	400	400	400	400	400			
0,12	0,14	0,18	0,20	0,25	0,25	0,12	0,14	0,18	0,20	0,25	0,25	300	300	300	300	300	300	300	300	300			
0,07	0,09	0,11	0,14	0,21	0,22							300	250	200	250	200	150	250	200	150			

HC = Coated carbide

Cutting data for drilling with Stardrill D_c 10–18 mm

Material group	Structure of main material groups and identification letters		Brinell hardness HB	Tensile strength R _m N/mm ²	Machining group ¹			Indexable insert geometry			
								Starting values for feed f (mm/rev)			
								LCMX .. -B57			
								D _c [mm]			
								10,0–12,0	12,1–18,0		
P	Unalloyed steel	C ≤ 0,25%	annealed	125	428	P1	●●		0,05	0,06	
		C > 0,25 ... ≤ 0,55 %	annealed	190	639	P2	●●		0,06	0,08	
		C > 0,25 ... ≤ 0,55 %	tempered	210	708	P3	●●				
		C > 0,55 %	annealed	190	639	P4	●●				
		C > 0,55 %	tempered	300	1013	P5	●●				
	free cutting steel (short-chipping)	annealed	220	745	P6	●●	●				
	Low-alloyed steel	annealed	175	591	P7	●●		0,06	0,07		
		tempered	300	1013	P8	●●					
		tempered	380	1282	P9	●●					
		tempered	430	1477	P10	●●					
	High-alloyed steel and high-alloyed tool steel	annealed	200	675	P11	●●					
		hardened and tempered	300	1013	P12	●●					
		hardened and tempered	400	1361	P13	●●					
	Stainless steel	ferritic / martensitic, annealed	200	675	P14	●●					
		martensitic, tempered	330	1114	P15	●●					
M	Stainless steel	austenitic, quench hardened		200	675	M1	●●		0,05	0,06	
		austenitic, precipitation hardened (PH)		300	1013	M2	●●		0,05	0,06	
		austenitic / ferritic, duplex		230	778	M3	●●		0,05	0,06	
K	Malleable cast iron	ferritic		200	675	K1	●●	●	0,09	0,10	
		pearlitic		260	867	K2	●●	●	0,07	0,08	
	Grey cast iron	low tensile strength		180	602	K3	●●	●	0,09	0,10	
		high tensile strength / austenitic		245	825	K4	●●	●	0,07	0,08	
	Cast iron with spheroidal graphite	ferritic		155	518	K5	●●	●	0,07	0,09	
		pearlitic		265	885	K6	●●		0,06	0,08	
GGV (CGI)			200	675	K7	●●	●	0,09	0,10		
N	Aluminium wrought alloys	cannot be hardened		30	–	N1					
		hardenable, hardened		100	343	N2	●●				
	Cast aluminium alloys	≤ 12 % Si, cannot be hardened		75	260	N3	●●				
		≤ 12 % Si, hardenable, hardened		90	314	N4	●●				
		> 12 % Si, cannot be hardened		130	447	N5	●●	●			
	Magnesium alloys			70	250	N6	●●				
	Copper and copper alloys (bronze / brass)	unalloyed, electrolytic copper			100	343	N7				
brass, bronze, red brass				90	314	N8	●●				
Cu-alloys, short-chipping				110	382	N9	●●	●			
high-strength, Ampco				300	1013	N10	●●	●			
S	Heat-resistant alloys	Fe-based	annealed		200	675	S1	●●		0,05	0,06
			hardened		280	943	S2	●●			
		Ni or Co base	annealed		250	839	S3	●●			
			hardened		350	1177	S4	●●			
			cast		320	1076	S5	●●			
	Titanium alloys	pure titanium			200	675	S6				
		α and β alloys, hardened			375	1262	S7	●●		0,05	0,06
		β alloys			410	1396	S8	●●		0,05	0,06
	Tungsten alloys				300	1013	S9	●●			
	Molybdenum alloys				300	1013	S10	●●			
H	Hardened steel	hardened and tempered		50 HRC	–	H1	●●				
		hardened and tempered		55 HRC	–	H2	●●				
		hardened and tempered		60 HRC	–	H3					
	Hardened cast iron	hardened and tempered			55 HRC	–	H4	●●			
O	Thermoplasts	without abrasive fillers				O1	●●	●			
	Thermosetting plastics	without abrasive fillers				O2	●●	●			
	Plastic, glass-fibre reinforced	GFRP				O3					
	Plastic, carbon-fibre reinforced	CFRP				O4					
	Plastic, aramid fibre reinforced	AFRP				O5					
	Graphite (technical)				80 Shore		O6	●●	●	0,07	0,09

¹ The machining groups are assigned from H 8 onwards.

- Recommended application (the specified cutting data are regarded as starting values for the recommended application).
- Possible application. Limited to 2 x D_c drilling depth. MQL (minimum quantity lubrication) or compressed air is recommended.

When using drills > 3 x D the following reductions are recommended:

> 3 x D: cutting speed v_c –20 %, feed f –30 % when spot drilling, feed f –50 % when spot drilling on angled surfaces.

The specified cutting data are average recommended values.
For special applications, adjustment is recommended.

Indexable insert geometry				Cutting material grades											
Starting values for feed f [mm/rev]				Starting values for cutting speed v _c [m/min]											
LCMX...-D57		LCMX...-E57		HC											
D _c [mm]		D _c [mm]		WAP20 f [mm/rev]		WKP25 f [mm/rev]		WKP35 f [mm/rev]		WSP45 f [mm/rev]		WTP35 f [mm/rev]		WXP40 f [mm/rev]	
10,0- 12,0	12,1- 18,0	10,0- 12,0	12,1- 18,0	0,06	0,1	0,06	0,1	0,06	0,1	0,06	0,1	0,06	0,1	0,06	0,1
0,06	0,07	0,07	0,10	260	240	290	260	260	240	220	200	220	200	200	180
0,06	0,08	0,08	0,12	240	220	260	240	220	200	160	150	160	150	150	140
0,06	0,08	0,08	0,12	240	220	260	240	220	200	160	150	160	150	150	140
0,06	0,08	0,08	0,12	240	220	260	240	220	200	160	150	160	150	150	140
0,05	0,06	0,07	0,10	180	160	200	180	150	130	130	120	130	120	120	110
0,05	0,06	0,07	0,10	180	160	200	180	150	130	130	120	130	120	120	110
0,07	0,08	0,08	0,12	240	220	260	240	220	200	180	170	180	170	150	140
0,07	0,08	0,08	0,10	200	180	220	200	190	170	150	130	150	130	140	120
0,07	0,08	0,08	0,10	200	180	220	200	190	170	150	130	150	130	140	120
0,05	0,06	0,06	0,08	180	160	200	180	150	130	130	120	130	120	120	110
0,06	0,08	0,07	0,10	200	180	220	200	180	170	140	130	140	130	130	120
0,05	0,07	0,06	0,08	160	150	180	170	150	140	130	120	130	120	120	110
0,06	0,07	0,07	0,09	150	140	170	160	140	130	120	110	120	110	110	100
0,06	0,08	0,07	0,10	200	180			180	170	140	130	140	130	130	120
0,06	0,07	0,07	0,09	150	140	170	160	140	130	120	110	120	110	110	100
0,06	0,07							220	200	180	160	180	160	160	150
0,06	0,07							150	130	130	110	120	110	110	100
0,06	0,07							120	100	100	80	90	80	80	70
0,10	0,12	0,10	0,14	220	200	240	220	220	200	170	150	180	160	160	140
0,08	0,10	0,08	0,12	160	150	180	170	180	150	140	130	140	130	130	120
0,10	0,12	0,10	0,14	220	200	240	220	220	200	170	150	180	160	160	140
0,08	0,10	0,08	0,12	160	150	180	170	180	150	140	130	140	130	130	120
0,08	0,10	0,10	0,12	150	140	170	150	150	140	140	130	130	120	130	120
0,07	0,08	0,08	0,10	130	120	140	130	140	130	120	110	120	110	110	100
0,10	0,12	0,10	0,14	160	150	180	170	180	150	140	130	140	130	130	120
0,08	0,10									450	450	400	400		
0,08	0,10									300	300	300	300		
0,08	0,10									250	250	250	250		
0,08	0,10									200	200	200	200		
0,08	0,10									300	300	300	300		
0,08	0,10	0,08	0,10									300	250		
0,07	0,09	0,07	0,09									290	240		
0,06	0,08											130	110		
0,05	0,06	0,05	0,06					100	100			80	80	80	80
0,04	0,05	0,04	0,05					80	80			60	60	60	60
0,04	0,05	0,04	0,05					60	60			50	50	50	50
0,04	0,05	0,04	0,05					50	50			40	40	40	40
0,04	0,05	0,04	0,05					50	50			40	40	40	40
0,05	0,06									50	40	50	40		
0,05	0,06							50	50	40	40	50	50		
0,05	0,06			70	60	70	60								
0,05	0,06			70	60	70	60								
0,04	0,05			70	60	70	60								
0,04	0,05			60	50	60	50								
0,04	0,05			60	50	60	50								
0,12	0,14	0,12	0,14					400	400	400	400	400	400	400	400
0,10	0,12	0,10	0,12	300	300	300	300	300	300	300	300	300	300	300	300
0,06	0,08	0,06	0,08	300	250	300	250	250	200	250	200	250	200	250	200

HC = Coated carbide

Cutting data for drilling with Stardrill D_c 16–58 mm

Material group	Structure of main material groups and identification letters		Brinell hardness HB	Tensile strength R _m N/mm ²	Machining group ¹			Insert geometry			
								Starting values for feed f [mm/rev]			
								P28467 P28477			
								D _c (mm)			
							15,8–20,4	20,5–30,4	>30,4		
P	Unalloyed steel	C ≤ 0,25%	annealed	125	428	P1	●●		0,07	0,10	0,10
		C > 0,25 ... ≤ 0,55 %	annealed	190	639	P2	●●		0,08	0,10	0,16
		C > 0,25 ... ≤ 0,55 %	tempered	210	708	P3	●●		0,08	0,09	0,12
		C > 0,55 %	annealed	190	639	P4	●●		0,08	0,10	0,16
		C > 0,55 %	tempered	300	1013	P5	●●		0,06	0,07	0,10
		free cutting steel (short-chipping)	annealed	220	745	P6	●●	●	0,08	0,09	0,12
	Low-alloyed steel		annealed	175	591	P7	●●		0,08	0,10	0,16
			tempered	300	1013	P8	●●		0,07	0,08	0,10
			tempered	380	1282	P9	●●		0,06	0,07	0,09
			tempered	430	1477	P10	●●		0,05	0,06	0,08
	High-alloyed steel and high-alloyed tool steel		annealed	200	675	P11	●●		0,07	0,09	0,16
			hardened and tempered	300	1013	P12	●●		0,05	0,07	0,11
			hardened and tempered	400	1361	P13	●●		0,05	0,06	0,08
	Stainless steel		ferritic / martensitic, annealed	200	675	P14	●●		0,07	0,09	0,12
			martensitic, tempered	330	1114	P15	●●		0,06	0,07	0,09
		annealed	200	675	M1	●●		0,05	0,07	0,09	
M	Stainless steel	austenitic, quench hardened	200	675	M1	●●		0,05	0,07	0,09	
		austenitic, precipitation hardened (PH)	300	1013	M2	●●		0,05	0,07	0,09	
		austenitic / ferritic, duplex	230	778	M3	●●		0,05	0,07	0,09	
K	Malleable cast iron	ferritic	200	675	K1	●●	●	0,10	0,12	0,20	
		pearlitic	260	867	K2	●●	●	0,08	0,10	0,16	
	Grey cast iron	low tensile strength	180	602	K3	●●	●	0,10	0,12	0,20	
		high tensile strength / austenitic	245	825	K4	●●	●	0,08	0,10	0,16	
	Cast iron with spheroidal graphite	ferritic	155	518	K5	●●	●	0,10	0,12	0,20	
		pearlitic	265	885	K6	●●		0,07	0,08	0,14	
	GGV (CGI)		200	675	K7	●●	●	0,10	0,12	0,20	
N	Aluminium wrought alloys	cannot be hardened	30	–	N1						
		hardenable, hardened	100	343	N2	●●					
	Cast aluminium alloys	≤ 12 % Si, cannot be hardened	75	260	N3	●●					
		≤ 12 % Si, hardenable, hardened	90	314	N4	●●					
		> 12 % Si, cannot be hardened	130	447	N5	●●	●				
	Magnesium alloys		70	250	N6	●●					
	Copper and copper alloys (bronze / brass)	unalloyed, electrolytic copper		100	343	N7			0,10	0,12	0,20
		brass, bronze, red brass		90	314	N8	●●		0,10	0,12	0,16
		Cu-alloys, short-chipping		110	382	N9	●●	●	0,10	0,11	0,09
		high-strength, Ampco		300	1013	N10	●●	●	0,05	0,07	0,09
S	Heat-resistant alloys	Fe-based	annealed	200	675	S1	●●		0,05	0,08	0,12
			hardened	280	943	S2	●●		0,05	0,06	0,08
		Ni or Co base	annealed	250	839	S3	●●		0,05	0,08	0,10
			hardened	350	1177	S4	●●		0,05	0,06	0,08
			cast	320	1076	S5	●●		0,05	0,06	0,08
	Titanium alloys	pure titanium		200	675	S6					
		α and β alloys, hardened		375	1262	S7	●●		0,05	0,06	0,07
		β alloys		410	1396	S8	●●		0,05	0,06	0,08
	Tungsten alloys		300	1013	S9	●●		0,05	0,06	0,08	
	Molybdenum alloys		300	1013	S10	●●		0,05	0,06	0,08	
H	Hardened steel	hardened and tempered	50 HRC	–	H1	●●		0,05	0,07	0,10	
		hardened and tempered	55 HRC	–	H2	●●		0,05	0,07	0,10	
		hardened and tempered	60 HRC	–	H3						
	Hardened cast iron	hardened and tempered	55 HRC	–	H4	●●		0,05	0,07	0,10	
O	Thermoplasts	without abrasive fillers			O1	●●	●				
	Thermosetting plastics	without abrasive fillers			O2	●●	●				
	Plastic, glass-fibre reinforced	GFRP			O3						
	Plastic, carbon-fibre reinforced	CFRP			O4						
	Plastic, aramid fibre reinforced	AFRP			O5						
	Graphite (technical)		80 Shore		O6	●●	●				

¹ The machining groups are assigned from H 8 onwards.

- Recommended application (the specified cutting data are regarded as starting values for the recommended application).
- Possible application. Limited to 2 x D_c drilling depth. MQL (minimum quantity lubrication) or compressed air is recommended.

When using drills > 3 x D the following reductions are recommended:

- > 3 x D: cutting speed v_c –20 %, feed f –30 % when spot drilling, feed f –50 % when spot drilling on angled surfaces.
- > 4 x D: cutting speed v_c –30 %, feed f –40 % when spot drilling.

The specified cutting data are average recommended values.
For special applications, adjustment is recommended.

Insert geometry							Cutting material grades																
Starting values for feed f [mm/rev]							Starting values for cutting speed v _c [m/min]																
P28469 P28479			P28475				HC																
D _c [mm]			D _c [mm]				WAP20 f [mm/rev]				WKP25 f [mm/rev]				WKP35 f [mm/rev]				WSP45 f [mm/rev]				
15,8– 20,4	20,5– 30,4	>30,4	15,8 20,4	20,5– 30,4	>30,4		0,06	0,1	0,16	0,2	0,06	0,1	0,16	0,2	0,06	0,1	0,16	0,2	0,06	0,1	0,16	0,2	
0,08	0,10	0,10	0,09	0,10	0,10		260	240	220		350	320			300	270			250	220			
0,08	0,10	0,16	0,08	0,10	0,20		240	220	200	180	260	240	220	200	220	200	180	150	170	160	150	120	120
0,08	0,10	0,16	0,08	0,10	0,16		220	200	180	160	240	220	200	180	200	180	150	140	150	140	130	110	110
0,08	0,10	0,16	0,08	0,10	0,20		240	220	200	180	220	200	180	200	180	150	140	150	140	130	120	110	110
			0,07	0,07	0,12		170	150	140		190	170	150		150	130	120		130	120	110	110	
0,08	0,10	0,16	0,08	0,10	0,16		200	180	160	150	220	200	180	170	180	150	140	140	140	130	120	110	110
0,08	0,10	0,16	0,08	0,10	0,16		240	220	200	180	260	240	220	200	220	200	180	150	170	160	160	130	130
			0,07	0,08	0,14		200	180	160		230	210	190		190	170	140		140	130	120	120	
			0,07	0,07	0,10						210	190	170		180	160	130		140	120	110	110	
			0,06	0,07	0,09						190	170	160		170	140	130		140	120	110	110	
0,08	0,10	0,16	0,08	0,09	0,12		200	180	160		220	200	180		200	170	150		140	130	120	120	
			0,06	0,08	0,10		160	150	140		200	170	150		180	140	130		130	120	110	110	
			0,06	0,07	0,09						190	160	140		170	130	120		120	110	100	100	
0,07	0,09	0,12	0,08	0,09	0,12		200	180	160						190	170	150		140	130	120	120	
			0,07	0,08	0,10										150	130	120		120	110	100	100	
0,06	0,08	0,09													220	200	180		180	170	150	150	
0,06	0,08	0,09													150	130	110		130	110	100	100	
0,06	0,08	0,09													120	100	80		100	80	70	70	
0,10	0,12	0,20	0,10	0,12	0,25		220	200	180	160	210	190	170		190	180	160						
0,08	0,10	0,16	0,08	0,10	0,20		160	150	140	130	190	140	120		130	120	110						
0,10	0,12	0,20	0,10	0,12	0,25		220	200	180	160	220	200	180	150	200	190	170	150					
0,08	0,10	0,16	0,08	0,10	0,20		160	150	140	130	180	150	130	90	150	130	110	120					
0,10	0,12	0,20	0,10	0,12	0,20		150	140	130	120	150	140	130	100	140	120	110	120					
0,07	0,09	0,15	0,07	0,09	0,19		120	110	100	90	140	130	120	90	120	110	100	110					
0,10	0,12	0,20	0,10	0,12	0,25		150	130	110	100	180	150	130	110	150	130	110	100					
0,08	0,10	0,20																	450	450	450		
0,08	0,10	0,12																	300	300	300	300	
0,08	0,10	0,12																	250	250	250	250	
0,08	0,10	0,16	0,08	0,10	0,16																		
0,08	0,10	0,12																	300	300	300		
0,10	0,12	0,20																					
0,10	0,12	0,20																	300	250	200		
0,10	0,12	0,20																	350	300	250		
0,06	0,08	0,09																	130	110	100		
0,06	0,08	0,12									100	100			100	100			90	90			
0,05	0,06	0,08									80	80			80	80			70	70			
0,05	0,06	0,08									60	60			60	60			50	50			
											50	50			50	50			40	40			
											50	50			50	50			40	40			
0,05	0,06	0,07													50	50			50	45			
0,05	0,06	0,08													50	50			40	40			
0,05	0,06	0,08									70	60											
0,05	0,06	0,08									70	60											
			0,05	0,07	0,10						70	60	50										
			0,05	0,07	0,10						60	50	50										
			0,05	0,07	0,10						60	50	50										
0,16	0,20	0,30													400	400	400	400	400	400	400	400	400
0,12	0,18	0,25													300	300	300	300	300	300	300	300	300
0,08	0,14	0,20													300	250	200	200	250	200	150	150	150

HC = Coated carbide

Cutting data for drilling with Stardrill D_c 16–58 mm

Material group	Structure of main material groups and identification letters		Brinell hardness HB	Tensile strength R _m N/mm ²	Machining group ¹			Insert geometry			
								Starting values for feed f [mm/rev]			
								P28467 P28477			
								15,8–20,4	20,5–30,4	>30,4	
								D _c (mm)			
P	Unalloyed steel	C ≤ 0.25%	annealed	125	428	P1	●●		0,07	0,10	0,10
		C > 0.25 ... ≤ 0.55 %	annealed	190	639	P2	●●		0,08	0,10	0,16
		C > 0.25 ... ≤ 0.55 %	tempered	210	708	P3	●●		0,08	0,09	0,12
		C > 0.55 %	annealed	190	639	P4	●●		0,08	0,10	0,16
		C > 0.55 %	tempered	300	1013	P5	●●		0,06	0,07	0,10
		free cutting steel (short-chipping)	annealed	220	745	P6	●●	●	0,08	0,09	0,12
	Low-alloyed steel		annealed	175	591	P7	●●		0,08	0,10	0,16
			tempered	300	1013	P8	●●		0,07	0,08	0,10
			tempered	380	1282	P9	●●		0,06	0,07	0,09
			tempered	430	1477	P10	●●		0,05	0,06	0,08
	High-alloyed steel and high-alloyed tool steel		annealed	200	675	P11	●●		0,07	0,09	0,16
			hardened and tempered	300	1013	P12	●●		0,05	0,07	0,11
	Stainless steel		hardened and tempered	400	1361	P13	●●		0,05	0,06	0,08
		Stainless steel	ferritic / martensitic, annealed	200	675	P14	●●		0,07	0,09	0,12
			martensitic, tempered	330	1114	P15	●●		0,06	0,07	0,09
M	Stainless steel		austenitic, quench hardened	200	675	M1	●●		0,05	0,07	0,09
		austenitic, precipitation hardened (PH)	300	1013	M2	●●		0,05	0,07	0,09	
		austenitic / ferritic, duplex	230	778	M3	●●		0,05	0,07	0,09	
K	Malleable cast iron	ferritic	200	675	K1	●●	●	0,10	0,12	0,20	
		pearlitic	260	867	K2	●●	●	0,08	0,10	0,16	
	Grey cast iron	low tensile strength	180	602	K3	●●	●	0,10	0,12	0,20	
		high tensile strength / austenitic	245	825	K4	●●	●	0,08	0,10	0,16	
	Cast iron with spheroidal graphite	ferritic	155	518	K5	●●	●	0,10	0,12	0,20	
		pearlitic	265	885	K6	●●	●	0,07	0,08	0,14	
	GGV (CGI)		200	675	K7	●●	●	0,10	0,12	0,20	
N	Aluminium wrought alloys	cannot be hardened	30	–	N1						
		hardenable, hardened	100	343	N2	●●					
	Cast aluminium alloys	≤ 12 % Si, cannot be hardened	75	260	N3	●●					
		≤ 12 % Si, hardenable, hardened	90	314	N4	●●					
		> 12 % Si, cannot be hardened	130	447	N5	●●	●				
	Magnesium alloys		70	250	N6	●●					
	Copper and copper alloys (bronze / brass)	unalloyed, electrolytic copper		100	343	N7			0,10	0,12	0,20
brass, bronze, red brass			90	314	N8	●●		0,10	0,12	0,16	
Cu-alloys, short-chipping			110	382	N9	●●	●	0,10	0,11	0,09	
high-strength, Ampco			300	1013	N10	●●	●	0,05	0,07	0,09	
S	Heat-resistant alloys	Fe-based	annealed	200	675	S1	●●		0,05	0,08	0,12
			hardened	280	943	S2	●●		0,05	0,06	0,08
		Ni or Co base	annealed	250	839	S3	●●		0,05	0,08	0,10
			hardened	350	1177	S4	●●		0,05	0,06	0,08
			cast	320	1076	S5	●●		0,05	0,06	0,08
	Titanium alloys	pure titanium		200	675	S6					
		α and β alloys, hardened		375	1262	S7	●●		0,05	0,06	0,07
		β alloys		410	1396	S8	●●		0,05	0,06	0,08
	Tungsten alloys		300	1013	S9	●●		0,05	0,06	0,08	
	Molybdenum alloys		300	1013	S10	●●		0,05	0,06	0,08	
H	Hardened steel	hardened and tempered	50 HRC	–	H1	●●		0,05	0,07	0,10	
		hardened and tempered	55 HRC	–	H2	●●		0,05	0,07	0,10	
		hardened and tempered	60 HRC	–	H3	●●					
	Hardened cast iron	hardened and tempered	55 HRC	–	H4	●●		0,05	0,07	0,10	
O	Thermoplasts	without abrasive fillers			O1	●●	●				
	Thermosetting plastics	without abrasive fillers			O2	●●	●				
	Plastic, glass-fibre reinforced	GFRP			O3						
	Plastic, carbon-fibre reinforced	CFRP			O4						
	Plastic, aramid fibre reinforced	AFRP			O5						
	Graphite (technical)		80 Shore		O6	●●	●				

¹ The machining groups are assigned from H 8 onwards.

- Recommended application (the specified cutting data are regarded as starting values for the recommended application).
- Possible application. Limited to 2 x D_c drilling depth. MQL (minimum quantity lubrication) or compressed air is recommended.

When using drills > 3 x D the following reductions are recommended:
 > 3 x D: cutting speed v_c –20 %, feed f –30 % when spot drilling, feed f –50 % when spot drilling on angled surfaces.
 > 4 x D: cutting speed v_c –30 %, feed f –40 % when spot drilling.

The specified cutting data are average recommended values.
For special applications, adjustment is recommended.

Insert geometry						Cutting material grades																
Starting values for feed f [mm/rev]						Starting values for cutting speed v _c [m/min]																
P28469 P28479			P28475			HC												HW				
D _c [mm]			D _c [mm]			WTP35 f [mm/rev]				WAK15 f [mm/rev]				WXP40 f [mm/rev]				WK40 f [mm/rev]				
15,8– 20,4	20,5– 30,4	>30,4	15,8 20,4	20,5– 30,4	>30,4	0,06	0,1	0,16	0,2	0,06	0,1	0,16	0,2	0,06	0,1	0,16	0,2	0,06	0,1	0,16		
0,08	0,10	0,10	0,09	0,10	0,10	220	200	180						200	180	160						
0,08	0,10	0,16	0,08	0,10	0,20	160	150	130	120					150	140	130	120					
0,08	0,10	0,16	0,08	0,10	0,16	150	140	130						140	130	120						
0,08	0,10	0,16	0,08	0,10	0,20	160	150	130	120					150	140	130	120					
			0,07	0,07	0,12	130	120	110						120	110	100						
0,08	0,10	0,16	0,08	0,10	0,16	160	150	130	120					150	140	130	120					
0,08	0,10	0,16	0,08	0,10	0,16	180	170	150	130					150	140	130	120					
			0,07	0,08	0,14	150	130	120						140	120	110						
			0,07	0,07	0,10																	
			0,06	0,07	0,09																	
0,08	0,10	0,16	0,08	0,09	0,12	140	130	120						130	120	110						
			0,06	0,08	0,10	130	120	110						120	110	100						
			0,06	0,07	0,09																	
	0,07	0,09	0,12	0,08	0,09	0,12	140	130	100					130	120	110						
				0,07	0,08	0,10																
0,06	0,08	0,09				170	150							150	140							
0,06	0,08	0,09																				
0,06	0,08	0,09																				
0,10	0,12	0,20	0,10	0,12	0,25																	
0,08	0,10	0,16	0,08	0,10	0,20																	
0,10	0,12	0,20	0,10	0,12	0,25	180	160	140	130	240	220	200	180	160	140	120	100					
0,08	0,10	0,16	0,08	0,10	0,20	140	130	120	110	170	150	130	110	130	120	100	80					
0,10	0,12	0,20	0,10	0,12	0,20	130	120	110	100	160	140	130	120	130	120	110	100					
0,07	0,09	0,15	0,07	0,09	0,19	120	110	100	90	140	130	120	110	110	100	100	90					
0,10	0,12	0,20	0,10	0,12	0,25	140	130	120	110	170	150	130	110	130	120	100	80					
0,08	0,10	0,20																			450	400
0,08	0,10	0,12				300	300	300	300												400	400
0,08	0,10	0,12				250	250	250	250	250	250	250	250								300	300
0,08	0,10	0,16	0,08	0,10	0,16																200	200
0,08	0,10	0,12				300	300	300													300	300
0,10	0,12	0,20																			400	350
0,10	0,12	0,20				300	250	200		450	420										300	260
0,10	0,12	0,20				300	250	200													300	260
0,06	0,08	0,09				130	110	100														
0,06	0,08	0,12				80	80							80	80			70	70			
0,05	0,06	0,08				60	60							60	60			50	50			
0,05	0,06	0,08				50	50							50	50			40	40			
						40	40							40	40			30	30			
						40	40							40	40			30	30			
0,05	0,06	0,07																				
0,05	0,06	0,08																				
0,05	0,06	0,08																				
0,05	0,06	0,08																				
			0,05	0,07	0,10																	
			0,05	0,07	0,10																	
			0,05	0,07	0,10																	
0,16	0,20	0,30				400	400	400	400	450	450	450	450	400	400	400	400					
0,12	0,18	0,25				300	300	300	300	350	350	350	350	300	300	300	300					
0,08	0,14	0,20				250	200	150	150	300	250	200	200	250	200	150	150					

HC = Coated carbide
HW = Uncoated carbide

Cutting data for drilling with WOMX / WOEX indexable inserts

Material group	Structure of main material groups and identification letters		Brinell hardness HB	Tensile strength R _m N/mm ²	Machining group ¹		Insert geometry				
							Starting values for feed f [mm/rev]				
							WOMX-B57				
							D _c (mm)				
							14–19,9	20–24,9	25–44,9	>45	
P	Unalloyed steel	C ≤ 0,25%	annealed	125	428	P1	●●	0,05	0,07	0,08	0,10
		C > 0,25 ... ≤ 0,55 %	annealed	190	639	P2	●●	0,05	0,07	0,08	0,10
		C > 0,25 ... ≤ 0,55 %	tempered	210	708	P3	●●	0,05	0,07	0,08	0,10
		C > 0,55 %	annealed	190	639	P4	●●	0,05	0,07	0,08	0,10
		C > 0,55 %	tempered	300	1013	P5	●●	0,05	0,07	0,08	0,10
		free cutting steel (short-chipping)	annealed	220	745	P6	●● ●	0,06	0,07	0,08	0,10
	Low-alloyed steel		annealed	175	591	P7	●●	0,06	0,07	0,08	0,10
			tempered	300	1013	P8	●●	0,06	0,07	0,08	0,10
			tempered	380	1282	P9	●●	0,06	0,07	0,08	0,10
			tempered	430	1477	P10	●●	0,04	0,05	0,06	0,09
	High-alloyed steel and high-alloyed tool steel		annealed	200	675	P11	●●	0,04	0,05	0,06	0,09
			hardened and tempered	300	1013	P12	●●	0,04	0,05	0,06	0,09
			hardened and tempered	400	1361	P13	●●	0,04	0,05	0,06	0,09
	Stainless steel		ferritic / martensitic, annealed	200	675	P14	●●	0,04	0,05	0,08	0,10
			martensitic, tempered	330	1114	P15	●●	0,04	0,05	0,08	0,10
		austenitic, quench hardened	200	675	M1	●●	0,04	0,06	0,07	0,10	
M	Stainless steel	austenitic, precipitation hardened (PH)		300	1013	M2	●●	0,04	0,06	0,07	0,10
		austenitic / ferritic, duplex		230	778	M3	●●	0,04	0,06	0,07	0,10
			ferritic	200	675	K1	●● ●	0,05	0,07	0,09	0,12
K	Malleable cast iron	pearlitic		260	867	K2	●● ●	0,05	0,07	0,09	0,12
			low tensile strength	180	602	K3	●● ●	0,05	0,07	0,09	0,12
	Grey cast iron	high tensile strength / austenitic		245	825	K4	●● ●	0,05	0,07	0,09	0,12
			ferritic	155	518	K5	●● ●	0,04	0,05	0,09	0,12
	Cast iron with spheroidal graphite	pearlitic		265	885	K6	●●	0,04	0,05	0,09	0,12
			GGV (CGI)	200	675	K7	●● ●	0,05	0,07	0,09	0,12
	N	Aluminium wrought alloys	cannot be hardened		30	–	N1	●●			
hardenable, hardened				100	343	N2	●●				
Cast aluminium alloys		≤ 12 % Si, cannot be hardened		75	260	N3	●●				
		≤ 12 % Si, hardenable, hardened		90	314	N4	●●				
		> 12 % Si, cannot be hardened		130	447	N5	●●				
Magnesium alloys			70	250	N6	●●					
Copper and copper alloys (bronze / brass)		unalloyed, electrolytic copper		100	343	N7	●●				
		brass, bronze, red brass		90	314	N8	●●				
		Cu-alloys, short-chipping		110	382	N9	●●				
		high-strength, Ampco		300	1013	N10	●●				
S	Heat-resistant alloys	Fe-based	annealed	200	675	S1	●●	0,04	0,05	0,06	0,06
			hardened	280	943	S2	●●	0,04	0,05	0,06	0,06
		Ni or Co base	annealed	250	839	S3	●●				
			hardened	350	1177	S4	●●				
			cast	320	1076	S5	●●				
	Titanium alloys	pure titanium		200	675	S6	●●				
		α and β alloys, hardened		375	1262	S7	●●				
		β alloys		410	1396	S8	●●				
	Tungsten alloys		300	1013	S9	●●					
	Molybdenum alloys		300	1013	S10	●●					
H	Hardened steel	hardened and tempered		50 HRC	–	H1	●●				
		hardened and tempered		55 HRC	–	H2	●●				
		hardened and tempered		60 HRC	–	H3	●●				
	Hardened cast iron		55 HRC	–	H4	●●					
O	Thermoplasts	without abrasive fillers				O1	●● ●				
	Thermosetting plastics	without abrasive fillers				O2	●● ●				
	Plastic, glass-fibre reinforced	GFRP				O3	●●				
	Plastic, carbon-fibre reinforced	CFRP				O4	●●				
	Plastic, aramid fibre reinforced	AFRP				O5	●●				
	Graphite (technical)		80 Shore			O6	●● ●				

¹ The machining groups are assigned from H 8 onwards.

- Recommended application (the specified cutting data are regarded as starting values for the recommended application).
- Possible application. Limited to 2 x D_c drilling depth. MQL (minimum quantity lubrication) or compressed air is recommended.

Cutting data for boring

Material group	Structure of main material groups and identification letters		Brinell hardness HB	Tensile strength R _m N/mm ²	Machining group ¹		Insert geometry									
							Starting values for feed f [mm/rev]									
							-E47 D _c [mm]			-PM5 D _c [mm]						
			<44	>44-73	>73	<44	>44-73	>73								
P	Unalloyed steel	C ≤ 0,25%	annealed	125	428	P1	●●	0,20	0,30	0,40	2,20	0,30	0,40			
		C > 0,25 ... ≤ 0,55 %	annealed	190	639	P2	●●	0,16	0,24	0,40	0,16	0,24	0,40			
		C > 0,25 ... ≤ 0,55 %	tempered	210	708	P3	●●	0,15	0,22	0,35	0,15	0,22	0,35			
		C > 0,55 %	annealed	190	639	P4	●●	0,14	0,20	0,30	0,14	0,20	0,30			
		C > 0,55 %	tempered	300	1013	P5	●●	0,12	0,18	0,25	0,12	0,18	0,25			
		free cutting steel (short-chipping)	annealed	220	745	P6	●● ●	0,15	0,22	0,35	0,15	0,22	0,35			
	Low-alloyed steel		annealed	175	591	P7	●●	0,20	0,30	0,40	0,20	0,30	0,40			
			tempered	300	1013	P8	●●	0,14	0,20	0,30	0,14	0,20	0,30			
			tempered	380	1282	P9	●●	0,12	0,18	0,25	0,12	0,18	0,25			
			tempered	430	1477	P10	●●	0,10	0,15	0,20	0,10	0,15	0,20			
	High-alloyed steel and high-alloyed tool steel		annealed	200	675	P11	●●	0,14	0,20	0,30	0,14	0,20	0,30			
			hardened and tempered	300	1013	P12	●●	0,13	0,18	0,27	0,13	0,18	0,27			
			hardened and tempered	400	1361	P13	●●	0,10	0,15	0,20	0,10	0,15	0,20			
	Stainless steel		ferritic / martensitic, annealed	200	675	P14	●●	0,12	0,16	0,24	0,12	0,16	0,24			
			martensitic, tempered	330	1114	P15	●●	0,12	0,16	0,24	0,12	0,16	0,24			
		austenitic, quench hardened	200	675	M1	●●	0,12	0,16	0,24	0,12	0,16	0,24				
M	Stainless steel	austenitic, precipitation hardened (PH)		300	1013	M2	●●	0,12	0,16	0,24	0,12	0,16	0,24			
		austenitic / ferritic, duplex		230	778	M3	●●	0,12	0,16	0,24	0,12	0,16	0,24			
			ferritic	200	675	K1	●● ●	0,18	0,26	0,34	0,18	0,26	0,34			
K	Malleable cast iron	pearlitic		260	867	K2	●● ●	0,16	0,24	0,30	0,16	0,24	0,30			
			low tensile strength	180	602	K3	●● ●	0,20	0,30	0,40	0,20	0,30	0,40			
	Grey cast iron	high tensile strength / austenitic		245	825	K4	●● ●	0,16	0,24	0,30	0,16	0,24	0,30			
			ferritic	155	518	K5	●● ●	0,20	0,30	0,40	0,20	0,30	0,40			
	Cast iron with spheroidal graphite	pearlitic		265	885	K6	●●	0,16	0,24	0,30	0,16	0,24	0,30			
			GGV (CGI)		200	675	K7	●● ●	0,18	0,26	0,34	0,18	0,26	0,34		
N	Aluminium wrought alloys	cannot be hardened		30	-	N1	●●									
		hardenable, hardened		100	343	N2	●●									
	Cast aluminium alloys	≤ 12 % Si, cannot be hardened		75	260	N3	●● ●									
		≤ 12 % Si, hardenable, hardened		90	314	N4	●● ●									
		> 12 % Si, cannot be hardened		130	447	N5	●● ●									
	Magnesium alloys		70	250	N6	●● ●										
	Copper and copper alloys (bronze / brass)	unalloyed, electrolytic copper		100	343	N7	●●	0,16	0,24	0,40	0,16	0,24	0,40			
		brass, bronze, red brass		90	314	N8	●● ●	0,16	0,24	0,40	0,16	0,24	0,40			
		Cu-alloys, short-chipping		110	382	N9	●● ●	0,16	0,24	0,40	0,16	0,24	0,40			
		high-strength, Ampco		300	1013	N10	●●									
S	Heat-resistant alloys	Fe-based	annealed	200	675	S1	●●	0,10	0,15	0,20	0,10	0,15	0,20			
			hardened	280	943	S2	●●	0,10	0,15	0,20	0,10	0,15	0,20			
		Ni or Co base	annealed	250	839	S3	●●	0,10	0,15	0,20	0,10	0,15	0,20			
			hardened	350	1177	S4	●●	0,10	0,15	0,20	0,10	0,15	0,20			
			cast	320	1076	S5	●●	0,10	0,15	0,20	0,10	0,15	0,20			
	Titanium alloys	pure titanium		200	675	S6										
		α and β alloys, hardened		375	1262	S7	●●	0,14	0,16	0,24	0,14	0,16	0,24			
	β alloys		410	1396	S8	●●	0,12	0,14	0,22	0,12	0,14	0,22				
Tungsten alloys		300	1013	S9												
Molybdenum alloys		300	1013	S10												
H	Hardened steel	hardened and tempered		50 HRC	-	H1										
		hardened and tempered		55 HRC	-	H2										
		hardened and tempered		60 HRC	-	H3										
	Hardened cast iron	hardened and tempered		55 HRC	-	H4										
O	Thermoplasts	without abrasive fillers				O1										
	Thermosetting plastics	without abrasive fillers				O2										
	Plastic, glass-fibre reinforced	GFRP				O3										
	Plastic, carbon-fibre reinforced	CFRP				O4										
	Plastic, aramid fibre reinforced	AFRP				O5										
	Graphite (technical)			80 Shore			O6									

¹ The machining groups are assigned from H 8 onwards.

- Recommended application (the specified cutting data are regarded as starting values for the recommended application).
- Possible application. Cutting speed v_c -30 %, with compressed air or MQL (minimum quantity lubrication).

The specified cutting data are average recommended values.
For special applications, adjustment is recommended.

Insert geometry				Cutting material grade																			
Starting values for feed f [mm/rev]				Starting values for cutting speed v _c [m/min]																			
-PF2 / -PM2			-PF4 / -PS5			WPP01 / WPP10			WPP20			WPP30			WSM10			WSM20			WSM30		
D _c [mm]			D _c [mm]			f [mm/rev]			f [mm/rev]			f [mm/rev]			f [mm/rev]			f [mm/rev]			f [mm/rev]		
<44	>44-73	>73	<44	>44-73	>73	0,1	0,2	0,4	0,1	0,2	0,4	0,1	0,2	0,4	0,1	0,2	0,4	0,1	0,2	0,4	0,1	0,2	0,4
			0,16	0,24	0,32	300	280		280	260	240	260	240	220				240	220		220	20	
			0,13	0,19	0,32	280	260		260	240	220	220	200	180				180	160		160	140	
			0,12	0,18	0,28	260	240		240	220	200	200	180	160				140	120		120	100	
			0,11	0,16	0,24	250	220		220	200	180	180	160	140				160	140		140	120	
			0,10	0,14	0,20	220	200		200	180	160	140	130	120									
			0,12	0,18	0,28	260	240		240	220	200	200	180	160				160	140		140	120	
			0,16	0,24	0,32	280	260		260	240	220	220	200	180									
			0,11	0,16	0,24	240	220		220	200	180	180	160	150									
			0,10	0,14	0,20	210	190		190	170	150	130	120	110									
			0,08	0,12	0,16	180	160		160	120	100	120	100	80									
			0,11	0,16	0,24	220	200		220	200		180	160	150									
			0,11	0,16	0,24	180	160		180	160		160	150	140									
			0,08	0,12	0,16	180	160		160	120	100	120	100	80									
			0,10	0,13	0,19				220	200		160	130										
			0,10	0,13	0,19				170	150		130	110										
			0,10	0,13	0,19							220	200		220	170		200	180		140	100	70
			0,10	0,13	0,19							180	160		160	120		150	120		110	100	50
			0,10	0,13	0,19							200	180		180	140		170	140		130	120	60
			0,14	0,22	0,30	220	200	160	200	180	140	180	160	120									
			0,13	0,19	0,24	170	150	140	160	150	130	160	140	120									
			0,16	0,24	0,32	240	220	180	220	200	160	200	180	140									
			0,13	0,19	0,24	170	150	140	160	150	130	160	140	120									
			0,16	0,24	0,32	200	180	160	180	160	140	150	140	120									
			0,13	0,19	0,24	180	160	140	160	140	130	160	130	110									
			0,14	0,22	0,30	165	150	130															
	0,24	0,30	0,40																				
	0,24	0,30	0,40																				
	0,24	0,30	0,40																				
	0,24	0,30	0,40																				
	0,24	0,30	0,40																				
	0,24	0,30	0,40	0,13	0,19	0,32	300	250	220	300	250	200											
	0,24	0,30	0,40	0,13	0,19	0,32	350	300	250	330	300	250											
	0,24	0,30	0,40	0,13	0,19	0,32	400	360	300	350	330	300											
			0,08	0,12	0,16										90	90		80	80		60	35	
			0,08	0,12	0,16										70	70		60	60		40	30	
			0,08	0,12	0,16										60	60		50	50		40	20	
			0,08	0,12	0,16										50	50		40	40		35	20	
			0,08	0,12	0,16										50	50		40	40		30	10	
			0,11	0,13	0,19										60	60		50	50				
			0,09	0,11	0,16										50	50		40	40				

HC = Coated carbide

Cutting data for boring

Material group	Structure of main material groups and identification letters		Brinell hardness HB	Tensile strength R_{m} N/mm ²	Machining group ¹		Insert geometry						
							Starting values for feed f [mm/rev]						
							– E47			– PM5			
							D _c [mm]		D _c [mm]		D _c [mm]		
						<44	>44-73	>73	<44	>44-73	>73		
P	Unalloyed steel	C ≤ 0,25%	annealed	125	428	P1	●●	0,20	0,30	0,40	2,20	0,30	0,40
		C > 0,25 ... ≤ 0,55 %	annealed	190	639	P2	●●	0,16	0,24	0,40	0,16	0,24	0,40
		C > 0,25 ... ≤ 0,55 %	tempered	210	708	P3	●●	0,15	0,22	0,35	0,15	0,22	0,35
		C > 0,55 %	annealed	190	639	P4	●●	0,14	0,20	0,30	0,14	0,20	0,30
		C > 0,55 %	tempered	300	1013	P5	●●	0,12	0,18	0,25	0,12	0,18	0,25
		free cutting steel (short-chipping)	annealed	220	745	P6	●● ●	0,15	0,22	0,35	0,15	0,22	0,35
	Low-alloyed steel		annealed	175	591	P7	●●	0,20	0,30	0,40	0,20	0,30	0,40
			tempered	300	1013	P8	●●	0,14	0,20	0,30	0,14	0,20	0,30
			tempered	380	1282	P9	●●	0,12	0,18	0,25	0,12	0,18	0,25
			tempered	430	1477	P10	●●	0,10	0,15	0,20	0,10	0,15	0,20
	High-alloyed steel and high-alloyed tool steel		annealed	200	675	P11	●●	0,14	0,20	0,30	0,14	0,20	0,30
			hardened and tempered	300	1013	P12	●●	0,13	0,18	0,27	0,13	0,18	0,27
			hardened and tempered	400	1361	P13	●●	0,10	0,15	0,20	0,10	0,15	0,20
	Stainless steel		ferritic / martensitic, annealed	200	675	P14	●●	0,12	0,16	0,24	0,12	0,16	0,24
			martensitic, tempered	330	1114	P15	●●	0,12	0,16	0,24	0,12	0,16	0,24
		free cutting steel (short-chipping)	220	745	P6	●● ●	0,15	0,22	0,35	0,15	0,22	0,35	
M	Stainless steel	austenitic, quench hardened	200	675	M1	●●	0,12	0,16	0,24	0,12	0,16	0,24	
		austenitic, precipitation hardened (PH)	300	1013	M2	●●	0,12	0,16	0,24	0,12	0,16	0,24	
		austenitic / ferritic, duplex	230	778	M3	●●	0,12	0,16	0,24	0,12	0,16	0,24	
K	Malleable cast iron	ferritic	200	675	K1	●● ●	0,18	0,26	0,34	0,18	0,26	0,34	
		pearlitic	260	867	K2	●● ●	0,16	0,24	0,30	0,16	0,24	0,30	
	Grey cast iron	low tensile strength	180	602	K3	●● ●	0,20	0,30	0,40	0,20	0,30	0,40	
		high tensile strength / austenitic	245	825	K4	●● ●	0,16	0,24	0,30	0,16	0,24	0,30	
	Cast iron with spheroidal graphite	ferritic	155	518	K5	●● ●	0,20	0,30	0,40	0,20	0,30	0,40	
		pearlitic	265	885	K6	●●	0,16	0,24	0,30	0,16	0,24	0,30	
	GGV (CGI)		200	675	K7	●● ●	0,18	0,26	0,34	0,18	0,26	0,34	
N	Aluminium wrought alloys	cannot be hardened	30	–	N1	●●							
		hardenable, hardened	100	343	N2	●●							
	Cast aluminium alloys	≤ 12 % Si, cannot be hardened	75	260	N3	●● ●							
		≤ 12 % Si, hardenable, hardened	90	314	N4	●● ●							
		> 12 % Si, cannot be hardened	130	447	N5	●● ●							
	Magnesium alloys		70	250	N6	●● ●							
	Copper and copper alloys (bronze / brass)	unalloyed, electrolytic copper	100	343	N7	●●	0,16	0,24	0,40	0,16	0,24	0,40	
		brass, bronze, red brass	90	314	N8	●● ●	0,16	0,24	0,40	0,16	0,24	0,40	
		Cu-alloys, short-chipping	110	382	N9	●● ●	0,16	0,24	0,40	0,16	0,24	0,40	
		high-strength, Ampco	300	1013	N10	●●							
S	Heat-resistant alloys	Fe-based	annealed	200	675	S1	●●	0,10	0,15	0,20	0,10	0,15	0,20
			hardened	280	943	S2	●●	0,10	0,15	0,20	0,10	0,15	0,20
		Ni or Co base	annealed	250	839	S3	●●	0,10	0,15	0,20	0,10	0,15	0,20
			hardened	350	1177	S4	●●	0,10	0,15	0,20	0,10	0,15	0,20
			cast	320	1076	S5	●●	0,10	0,15	0,20	0,10	0,15	0,20
	Titanium alloys	pure titanium	200	675	S6	●●							
		α and β alloys, hardened	375	1262	S7	●●	0,14	0,16	0,24	0,14	0,16	0,24	
		β alloys	410	1396	S8	●●	0,12	0,14	0,22	0,12	0,14	0,22	
	Tungsten alloys		300	1013	S9	●●							
	Molybdenum alloys		300	1013	S10	●●							
H	Hardened steel	hardened and tempered	50 HRC	–	H1								
		hardened and tempered	55 HRC	–	H2								
		hardened and tempered	60 HRC	–	H3								
	Hardened cast iron	hardened and tempered	55 HRC	–	H4								
O	Thermoplasts	without abrasive fillers			O1								
	Thermosetting plastics	without abrasive fillers			O2								
	Plastic, glass-fibre reinforced	GFRP			O3								
	Plastic, carbon-fibre reinforced	CFRP			O4								
	Plastic, aramid fibre reinforced	AFRP			O5								
	Graphite (technical)		80 Shore			O6							

¹ The machining groups are assigned from H 8 onwards.

- Recommended application (the specified cutting data are regarded as starting values for the recommended application).
- Possible application. Cutting speed v_c –30 %, with compressed air or MQL (minimum quantity lubrication).

The specified cutting data are average recommended values.
For special applications, adjustment is recommended.

Insert geometry						Cutting material grade														
Starting values for feed f [mm/rev]						Starting values for cutting speed v _c [m/min]														
– PF2 / – PM2			– PF4 / – PS5			HC									HW					
D _c [mm]			D _c [mm]			WAK10			WAK20			WAK30			WXN10			WK1		
<44	>44-73	>73	<44	>44-73	>73	f [mm/rev]			f [mm/rev]			f [mm/rev]			f [mm/rev]			f [mm/rev]		
						0,1	0,2	0,4	0,1	0,2	0,4	0,1	0,2	0,4	0,1	0,2	0,4	0,1	0,2	0,4
				0,16	0,24	0,32														
				0,13	0,19	0,32														
				0,12	0,18	0,28														
				0,11	0,16	0,24														
				0,10	0,14	0,20														
				0,12	0,18	0,28														
				0,16	0,24	0,32														
				0,11	0,16	0,24														
				0,10	0,14	0,20														
				0,08	0,12	0,16														
				0,11	0,16	0,24														
				0,11	0,16	0,24														
				0,08	0,12	0,16														
				0,10	0,13	0,19														
				0,10	0,13	0,19														
				0,10	0,13	0,19														
				0,14	0,22	0,30	280	250	210	210	190	180	140	125	110					
				0,13	0,19	0,24	220	200	150	170	150	110	120	100	70					
				0,16	0,24	0,32	390	350	260	350	320	200	310	290	140					
				0,13	0,19	0,24	250	220	170	190	170	130	130	120	90					
				0,16	0,24	0,32	260	230	190	200	180	150	140	130	110					
				0,13	0,19	0,24	190	170	150	150	130	110	110	90	70					
				0,14	0,22	0,30	190	160	120	160	140	120	120	100	80					
	0,24	0,30	0,40												1000*	1000*	1000*	1000*	1000*	
	0,24	0,30	0,40												900	900	900	800	800	
	0,24	0,30	0,40												500	500	500	500	500	500
	0,24	0,30	0,40												400	400	400	400	400	400
	0,24	0,30	0,40												300	300	300	300	300	300
	0,24	0,30	0,40												500	500	500	500	500	500
	0,24	0,30	0,40	0,13	0,19	0,32									450	400	350	450	400	350
	0,24	0,30	0,40	0,13	0,19	0,32									400	350	300	400	350	300
	0,24	0,30	0,40	0,13	0,19	0,32									350	300	250	350	300	250
				0,08	0,12	0,16														
				0,08	0,12	0,16														
				0,08	0,12	0,16														
				0,08	0,12	0,16														
				0,11	0,13	0,19												45	45	
				0,09	0,11	0,16												40	40	

HC = Coated carbide
HW = Uncoated carbide

* Observe limit speeds.

Cutting data for precision boring

Material group	Structure of main material groups and identification letters		Brinell hardness HB	Tensile strength R _m N/mm ²	Machining group ¹		Starting values for cutting speed v _c [m/min]			
							HC WPP01 / WPP10			
							L/D			
							3 x D _c	4 x D _c	6 x D _c	
P	Unalloyed steel	C ≤ 0,25%	annealed	125	428	P1	●●	355	320	195
		C > 0,25 ... ≤ 0,55 %	annealed	190	639	P2	●●	335	265	160
		C > 0,25 ... ≤ 0,55 %	tempered	210	708	P3	●●	300	240	150
		C > 0,55 %	annealed	190	639	P4	●●	290	230	140
		C > 0,55 %	tempered	300	1013	P5	●●	255	205	125
		free cutting steel (short-chipping)	annealed	220	745	P6	●● ●	300	240	150
	Low-alloyed steel		annealed	175	591	P7	●●	330	265	160
			tempered	300	1013	P8	●●	275	220	140
			tempered	380	1282	P9	●●	245	195	115
			tempered	430	1477	P10	●●	200	160	80
	High-alloyed steel and high-alloyed tool steel		annealed	200	675	P11	●●	275	220	140
			hardened and tempered	300	1013	P12	●●	230	195	115
			hardened and tempered	400	1361	P13	●●	210	170	90
	Stainless steel		ferritic / martensitic, annealed	200	675	P14	●●	275	205	140
			martensitic, tempered	330	1114	P15	●●	210	180	100
M	Stainless steel		austenitic, quench hardened	200	675	M1	●●			
			austenitic, precipitation hardened (PH)	300	1013	M2	●●			
			austenitic / ferritic, duplex	230	778	M3	●●			
K	Malleable cast iron		ferritic	200	675	K1	●● ●	280	235	130
			pearlitic	260	867	K2	●● ●	220	185	115
	Grey cast iron		low tensile strength	180	602	K3	●● ●	300	255	150
			high tensile strength / austenitic	245	825	K4	●● ●	220	185	115
	Cast iron with spheroidal graphite		ferritic	155	518	K5	●●	275	220	140
			pearlitic	265	885	K6	●●	255	195	125
	GGV (CGI)		200	675	K7	●●	235	175	105	
N	Aluminium wrought alloys		cannot be hardened	30	-	N1	●●			
			hardenable, hardened	100	343	N2	●●			
	Cast aluminium alloys		≤ 12 % Si, cannot be hardened	75	260	N3	●●			
			≤ 12 % Si, hardenable, hardened	90	314	N4	●●			
			> 12 % Si, cannot be hardened	130	447	N5	●●			
	Magnesium alloys			70	250	N6	●●			
		Copper and copper alloys (bronze / brass)		unalloyed, electrolytic copper	100	343	N7	●●	285	230
	brass, bronze, red brass		90	314	N8	●●	345	275		
	Cu-alloys, short-chipping		110	382	N9	●●				
	high-strength, Ampco	300	1013	N10						
S	Heat-resistant alloys	Fe-based		annealed	200	675	S1	●●		
				hardened	280	943	S2	●●		
		Ni or Co base		annealed	250	839	S3	●●		
				hardened	350	1177	S4	●●		
				cast	320	1076	S5	●●		
	Titanium alloys		pure titanium	200	675	S6				
			α and β alloys, hardened	375	1262	S7	●●			
	β alloys	410	1396	S8	●●					
	Tungsten alloys		300	1013	S9					
	Molybdenum alloys		300	1013	S10					
H	Hardened steel		hardened and tempered	50 HRC	-	H1	●● ●			
			hardened and tempered	55 HRC	-	H2	●● ●			
			hardened and tempered	60 HRC	-	H3	●● ●			
		Hardened cast iron		hardened and tempered	55 HRC	-	H4	●●		
O	Thermoplasts		without abrasive fillers			O1				
	Thermosetting plastics		without abrasive fillers			O2				
	Plastic, glass-fibre reinforced		GFRP			O3				
	Plastic, carbon-fibre reinforced		CFRP			O4				
	Plastic, aramid fibre reinforced		AFRP			O5				
	Graphite (technical)			80 Shore			O6			

¹ The machining groups are assigned from H 8 onwards.

- Recommended application (the specified cutting data are regarded as starting values for the recommended application).
- Possible application. MQL (minimum quantity lubrication) or compressed air is recommended.

Cutting data for precision boring

Material group	Structure of main material groups and identification letters		Brinell hardness HB	Tensile strength R _m N/mm ²	Machining group ¹			Starting values for cutting speed v _c [m/min]		
								HW		
								WK1		
								L/D		
								3 x D _c	4 x D _c	6 x D _c
P	Unalloyed steel	C ≤ 0,25%	annealed	125	428	P1	●●			
		C > 0,25 ... ≤ 0,55 %	annealed	190	639	P2	●●			
		C > 0,25 ... ≤ 0,55 %	tempered	210	708	P3	●●			
		C > 0,55 %	annealed	190	639	P4	●●			
		C > 0,55 %	tempered	300	1013	P5	●●			
		free cutting steel (short-chipping)	annealed	220	745	P6	●●	●		
	Low-alloyed steel		annealed	175	591	P7	●●			
			tempered	300	1013	P8	●●			
			tempered	380	1282	P9	●●			
			tempered	430	1477	P10	●●			
	High-alloyed steel and high-alloyed tool steel		annealed	200	675	P11	●●			
			hardened and tempered	300	1013	P12	●●			
			hardened and tempered	400	1361	P13	●●			
	Stainless steel		ferritic / martensitic, annealed	200	675	P14	●●			
			martensitic, tempered	330	1114	P15	●●			
M	Stainless steel	austenitic, quench hardened	200	675	M1	●●				
		austenitic, precipitation hardened (PH)	300	1013	M2	●●				
		austenitic / ferritic, duplex	230	778	M3	●●				
K	Malleable cast iron	ferritic	200	675	K1	●●	●	160	120	90
		pearlitic	260	867	K2	●●	●	150	120	90
	Grey cast iron	low tensile strength	180	602	K3	●●	●	210	170	120
		high tensile strength / austenitic	245	825	K4	●●	●	150	120	90
	Cast iron with spheroidal graphite	ferritic	155	518	K5	●●		170	140	100
		pearlitic	265	885	K6	●●		140	110	70
	GGV (CGI)		200	675	K7	●●				
N	Aluminium wrought alloys	cannot be hardened	30	-	N1	●●		750	600	400
		hardenable, hardened	100	343	N2	●●		600	480	330
	Cast aluminium alloys	≤ 12 % Si, cannot be hardened	75	260	N3	●●		600	480	330
		≤ 12 % Si, hardenable, hardened	90	314	N4	●●		450	360	250
		> 12 % Si, cannot be hardened	130	447	N5	●●		350	350	200
	Magnesium alloys		70	250	N6	●●		550	450	300
	Copper and copper alloys (bronze / brass)	unalloyed, electrolytic copper		100	343	N7	●●		300	240
brass, bronze, red brass			90	314	N8	●●		250	180	130
Cu-alloys, short-chipping			110	382	N9	●●		300	240	170
high-strength, Ampco			300	1013	N10					
S	Heat-resistant alloys	Fe-based	annealed	200	675	S1	●●			
			hardened	280	943	S2	●●			
		Ni or Co base	annealed	250	839	S3	●●			
			hardened	350	1177	S4	●●			
			cast	320	1076	S5	●●			
	Titanium alloys	pure titanium	200	675	S6					
		α and β alloys, hardened	375	1262	S7	●●				
		β alloys	410	1396	S8	●●				
	Tungsten alloys		300	1013	S9					
	Molybdenum alloys		300	1013	S10					
H	Hardened steel	hardened and tempered	50 HRC	-	H1	●●	●			
		hardened and tempered	55 HRC	-	H2	●●	●			
		hardened and tempered	60 HRC	-	H3	●●	●			
	Hardened cast iron	hardened and tempered	55 HRC	-	H4	●●				
O	Thermoplasts	without abrasive fillers			O1					
	Thermosetting plastics	without abrasive fillers			O2					
	Plastic, glass-fibre reinforced	GFRP			O3					
	Plastic, carbon-fibre reinforced	CFRP			O4					
	Plastic, aramid fibre reinforced	AFRP			O5					
	Graphite (technical)		80 Shore		O6					

¹ The machining groups are assigned from H 8 onwards.

- Recommended application (the specified cutting data are regarded as starting values for the recommended application).
- Possible application. MQL (minimum quantity lubrication) or compressed air is recommended.

Cutting data for reaming

Material group	Structure of main material groups and identification letters		Brinell hardness HB	Tensile strength R _m N/mm ²	Machining group ¹		Reaming oversize in Ø [mm]		
							D _c [mm] <9	D _c [mm] >9	
P	Unalloyed steel	C ≤ 0.25%	annealed	125	428	P1	●●	0,1-0,2	0,2-0,3
		C > 0.25 ... ≤ 0.55 %	annealed	190	639	P2	●●	0,1-0,2	0,2-0,3
		C > 0.25 ... ≤ 0.55 %	tempered	210	708	P3	●●	0,1-0,2	0,2-0,3
		C > 0.55 %	annealed	190	639	P4	●●	0,1-0,2	0,2-0,3
		C > 0.55 %	tempered	300	1013	P5	●●	0,1-0,2	0,2-0,3
	free cutting steel (short-chipping)	annealed	220	745	P6	●●	0,1-0,2	0,2-0,3	
	Low-alloyed steel	annealed	175	591	P7	●●	0,1-0,2	0,2-0,3	
		tempered	300	1013	P8	●●	0,1-0,2	0,2-0,3	
		tempered	380	1282	P9	●●	0,1-0,2	0,2-0,3	
		tempered	430	1477	P10	●●	0,1-0,2	0,2-0,3	
	High-alloyed steel and high-alloyed tool steel	annealed	200	675	P11	●●	0,1-0,2	0,2-0,3	
		hardened and tempered	300	1013	P12	●●	0,1-0,2	0,2-0,3	
		hardened and tempered	400	1361	P13	●●	0,1-0,2	0,2-0,3	
	Stainless steel	ferritic / martensitic, annealed	200	675	P14	●●	0,1-0,2	0,2-0,3	
		martensitic, tempered	330	1114	P15	●●	0,1-0,2	0,2-0,3	
austenitic, quench hardened austenitic, precipitation hardened (PH) austenitic / ferritic, duplex		200 / 300 / 230	675 / 1013 / 778	M1 / M2 / M3	●● / ●● / ●●	0,10 / 0,10 / 0,10	0,1-0,2 / 0,1-0,2 / 0,1-0,2		
K	Malleable cast iron	ferritic	200	675	K1	●●	0,2-0,3	0,3-0,5	
		pearlitic	260	867	K2	●●	0,2-0,3	0,3-0,5	
	Grey cast iron	low tensile strength	180	602	K3	●●	0,2-0,3	0,3-0,5	
		high tensile strength / austenitic	245	825	K4	●●	0,2-0,3	0,3-0,5	
	Cast iron with spheroidal graphite	ferritic	155	518	K5	●●	0,2-0,3	0,3-0,5	
		pearlitic	265	885	K6	●●	0,2-0,3	0,3-0,5	
	GGV (CGI)		200	675	K7	●●	0,2-0,3	0,3-0,5	
N	Aluminium wrought alloys	cannot be hardened	30	-	N1	●●	0,2-0,3	0,3-0,5	
		hardenable, hardened	100	343	N2	●●	0,2-0,3	0,3-0,5	
	Cast aluminium alloys	≤ 12 % Si, cannot be hardened	75	260	N3	●●	0,2-0,3	0,3-0,5	
		≤ 12 % Si, hardenable, hardened	90	314	N4	●●	0,2-0,3	0,3-0,5	
		> 12 % Si, cannot be hardened	130	447	N5	●●	0,2-0,3	0,3-0,5	
	Magnesium alloys		70	250	N6	●●	0,2-0,3	0,3-0,5	
	Copper and copper alloys (bronze / brass)	unalloyed, electrolytic copper	100	343	N7	●●	0,2-0,3	0,3-0,5	
brass, bronze, red brass		90	314	N8	●●	0,2-0,3	0,3-0,5		
Cu-alloys, short-chipping		110	382	N9	●●	0,2-0,3	0,3-0,5		
high-strength, Ampco		300	1013	N10	●●	0,2-0,3	0,3-0,5		
S	Heat-resistant alloys	Fe-based	annealed	200	675	S1	●●	0,10	0,1-0,2
			hardened	280	943	S2	●●	0,10	0,1-0,2
		Ni or Co base	annealed	250	839	S3	●●	0,10	0,1-0,2
			hardened	350	1177	S4	●●	0,10	0,1-0,2
			cast	320	1076	S5	●●	0,10	0,1-0,2
	Titanium alloys	pure titanium	200	675	S6	●●	0,10	0,1-0,2	
		α and β alloys, hardened	375	1262	S7	●●	0,10	0,1-0,2	
		β alloys	410	1396	S8	●●	0,10	0,1-0,2	
Tungsten alloys		300	1013	S9	●●	0,10	0,1-0,2		
Molybdenum alloys		300	1013	S10	●●	0,10	0,1-0,2		
H	Hardened steel	hardened and tempered	50 HRC	-	H1	●●	0,10	0,1-0,2	
		hardened and tempered	55 HRC	-	H2	●●	0,10	0,1-0,2	
		hardened and tempered	60 HRC	-	H3	●●	0,10	0,1-0,2	
	Hardened cast iron	hardened and tempered	55 HRC	-	H4	●●	0,10	0,1-0,2	
O	Thermoplasts	without abrasive fillers			O1				
	Thermosetting plastics	without abrasive fillers			O2				
	Plastic, glass-fibre reinforced	GFRP			O3				
	Plastic, carbon-fibre reinforced	CFRP			O4				
	Plastic, aramid fibre reinforced	AFRP			O5				
	Graphite (technical)		80 Shore		O6				

¹ The machining groups are assigned from H 8 onwards.

- Recommended application (the specified cutting data are regarded as starting values for the recommended application).
- Possible application.

The specified cutting data are average recommended values.
For special applications, adjustment is recommended.

Starting values for feed f_z [mm/rev]	Cutting material grade				
	Starting values for cutting speed v_c [m/min]				
	HC		HW	CT	
	WXP15	WXK05	WK10	WCE10	
0.12	60	80		120	
0.12	60	80		120	
0.12	60	80		120	
0.12	60	80		120	
0.12	60	80		120	
0.12	60	80		120	
0.12	60	80		120	
0.12	60	80		120	
0.12	60	80		120	
0.12	40	60		80	
0.12	40	60		80	
0.08	40	60			
0.12	40	60		70	
0.08	40	60			
0.10	40	60	20		
0.08	40	60	20		
0.08	40	40	20		
0.15	80	80	40		
0.15	80	80	40		
0.15	100	100	50		
0.15	100	100	50		
0.15	100	100	50	150	
0.15	100	100	50	150	
0.15	60	60	50		
0.10			150		
0.10			150		
0.10			150		
0.10			150		
0.10			150		
0.15			120		
0.15			120		
0.15			120		
0.15			120		
0.05		40			
0.05		40			
0.05		40			
0.05		40			
0.05		40			
0.05		40			
0.05		40			
0.05		40			
0.05		40			
0.05		40			
0.05		40			
0.05		40			
0.08		20			
0.05		15			
0.05		15			
0.05		15			

HC = Coated carbide
HW = Uncoated carbide
CT = Cermet

Cutting material application tables – Drilling

Grades for drilling																			
Walter grade designation	Standard designation	Workpiece material group							Application range							Coating procedure	Coating structure	Indexable insert example	
		P	M	K	N	S	H	O	01	05	10	15	20	25	30				35
		Steel	Stainless steel	Cast iron	NF metals	Difficult to cut materials	Hard materials	Other											
WAP 20	HC – P 20	●●																	
	HC – K 30			●															
WKP 25	HC – P 25	●●																	
	HC – K 25			●●															
WKP 35	HC – P 35	●●																	
	HC – K 35			●●															
WMP 35	HC – P 35	●●																	
	HC – M 35		●●																
	HC – S 35						●●												
WSP 45	HC – P 45	●●																	
	HC – M 45		●●																
	HC – S 45						●●												
WTP 35	HC – P 35	●●																	
	HC – M 35		●																
	HC – S 35						●												
WXP 45	HC – P 45	●●																	
	HC – K 45		●																
WAK 15	HC – K 15			●●															
WXK 25	HC – K 25			●●															
	HC – P 15	●																	
WXP 40	HC – P 40	●●																	
	HC – M 30		●●																
	HC – S 30						●												
WNN 25	HC – N 25				●●														
	HC – O 25							●											

HC = Coated carbide
HW = Uncoated carbide

- Primary application
- Other application

Cutting material application tables – Boring & precision boring

Grades for boring and precision boring																				
Walter grade designation	Standard designation	Workpiece material group							Application range							Coating procedure	Coating structure	Indexable insert example		
		P	M	K	N	S	H	O	01	05	10	15	20	25	30				35	40
		Steel	Stainless steel	Cast iron	NF metals	Difficult-to-machine materials	Hard materials	Other												
WPP 01	HC – P 01	●●																		
	HC – K 10			●																
WPP 10	HC – P 10	●●																		
	HC – K 20			●																
WPP 20	HC – P 20	●●																		
	HC – K 30			●																
WPP 30	HC – P 30	●●																		
WXM 15	HC – P 15	●●																		
	HC – M 15		●																	
	HC – K 15			●																
WTP 35	HC – P 35	●●																		
	HC – M 35		●																	
	HC – S 35					●														
WSM 10	HC – M 10		●●																	
	HC – S 10					●●														
	HC – P 10	●																		
WSM 20	HC – M 20		●●																	
	HC – S 20					●●														
	HC – P 20	●																		
WSM 30	HC – M 30		●●																	
	HC – S 30					●●														
	HC – P 30	●																		
WAK 10	HC – K 10			●●																
	HC – H 30						●													
WAK 15	HC – K 15			●●																
WAK 20	HC – K 20			●●																
	HC – P 10	●																		
WAK 30	HC – K 30			●●																
	HC – P 40	●																		

BL = CBN with low CBN content
 BH = CBN with high CBN content
 DP = Polycrystalline diamond
 HC = Coated carbide
 HW = Uncoated carbide
 HT = Cermet
 ●● Primary application
 ● Other application

Cutting material application tables – Boring, precision boring & reaming

Grades for boring and precision boring (continued)

Walter grade designation	Standard designation	Workpiece material group							Application range									Coating composition	Indexable insert example		
		P	M	K	N	S	H	O	01	05	10	15	20	25	30	35	40			45	
		Steel	Stainless steel	Cast iron	NF metals	Difficult-to-machine materials	Hard materials	Other													
WXN 10	HC – N 10				●●															TiCN ^{plus}	
	HC – M 01		●																		
WK 1	HW – N 10				●●															—	
WCB 30	BL – H 05						●●													—	
WCB 50	BH – H 10						●●													—	
	BH – K 10			●																—	
WCB 80	BH – K 05			●●																—	
	BH – H 15						●													—	
WCD 10	DP – N 10				●●															—	

BL = CBN with low CBN content
 BH = CBN with high CBN content
 DP = Polycrystalline diamond
 HC = Coated carbide
 HW = Uncoated carbide
 HT = Cermet

●● Primary application
 ● Other application











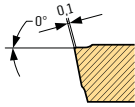

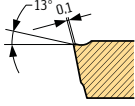

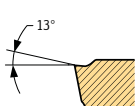
Grades for reaming

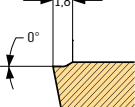
Walter grade designation	Standard designation	Workpiece material group							Application range									Coating procedure	Coating structure	Indexable insert example		
		P	M	K	N	S	H	O	01	05	10	15	20	25	30	35	40				45	
		Steel	Stainless steel	Cast iron	NF metals	Difficult-to-machine materials	Hard materials	Other														
WXP 15	HC – P 15	●●																		PVD	TiN	
	HC – M 15		●●																			
	HC – K 15			●●																		
WK 10	HW – N 10	●		●	●●															—	—	
WCE 10	HT – P 15	●●																		—	—	
WXK 05	HC – K 05	●	●	●●			●													—	—	

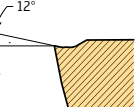
BL = CBN with low CBN content
 BH = CBN with high CBN content
 DP = Polycrystalline diamond
 HC = Coated carbide
 HW = Uncoated carbide
 HT = Cermet

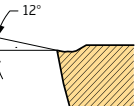
●● Primary application
 ● Other application

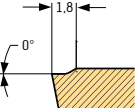

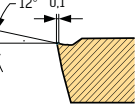

Geometry overview of indexable drilling inserts

Drilling		Workpiece material group							Section Main cutting edge
		P	M	K	N	S	H	O	
Geometry	Remarks / field of applications	Steel	Stainless steel	Cast iron	NF metals	Difficult-to-machine materials	Hard materials	Other	
	A57 – The stable one – 0° rake angle – For unfavourable machining conditions mainly For cast iron and steel materials	●●	●	●●		●			
	E57 – The universal one – 13° rake angle – For medium machining conditions – For cast iron and steel, but also for stainless and difficult to cut materials	●●	●●	●●	●	●			
	E67 – The special one – 13° rake angle – Special geometry for optimum chip formation – For long-chipping materials, e.g. St37, stainless and also difficult to cut materials and aluminium	●●	●●		●	●●			
	P28467 – The universal one (fully ground circumference) – 0° rake angle – High diameter accuracy – For unfavourable machining conditions – For cast iron and steel materials	●●		●●					
	P28469 – The sharp one (fully ground circumference) – 12° rake angle – High diameter accuracy – For good machining conditions – For long-chipping materials	●●	●●	●	●	●●			
	P28475 – The universal one (circumference sintered) – 12° rake angle – Average diameter accuracy – For medium machining conditions – For cast iron and steel materials	●●		●●					
	P28477 – The stable one (circumference sintered) – 0° rake angle – Average diameter accuracy – For unfavourable machining conditions – For cast iron and steel materials	●●	●	●●		●			
	P28479 – The sharp one (circumference sintered) – 12° rake angle – Average diameter accuracy – For good machining conditions – For long-chipping materials	●●		●●					



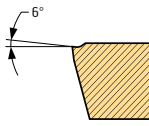

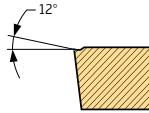
●● Primary application
 ● Other application

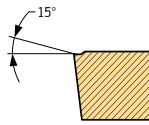
Geometry overview of indexable drilling inserts

Drilling (continued)

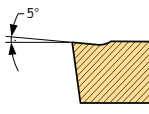

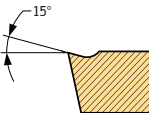

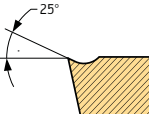





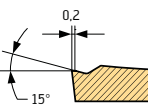
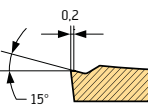

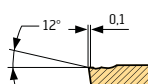
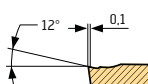

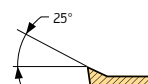
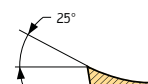
Geometry	Remarks / field of applications	Workpiece material group							Section Main cutting edge	ap [mm]	f [mm]
		P	M	K	N	S	H	O			
		Steel	Stainless steel	Cast iron	NF metals	Difficult-to-machine materials	Hard materials	Other			
 <p>LCMX-B57 – The stable one – 6° rake angle – For unfavourable machining conditions – For long-chipping materials</p>		••		••							
 <p>LCMX-D57 – The universal one – 12° rake angle – For medium machining conditions</p>		••	••	••	•	•					
 <p>LCMX-E57 – The easy-cutting one – 15° rake angle – For good machining conditions – Short-chipping materials</p>		••	••		••	••					

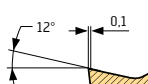
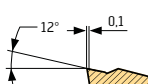
Precision boring

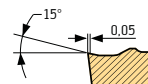
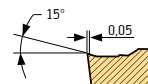
 <p>X5 – The stable one – 5° rake angle – For cast iron and steel materials – For unfavourable machining conditions</p>		••		••						0,1–0,3	0,03–0,15
 <p>X15 – The universal one – 15° rake angle – For steel, stainless materials and difficult to cut materials – Long projection lengths</p>		••	••	•	•	•				0,1–0,3	0,03–0,15
 <p>X25 – The soft one – 25° rake angle – Aluminium, soft steels, long-chipping materials</p>		••	•		••	•				0,1–0,3	0,03–0,15

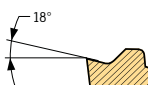
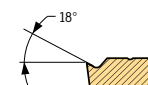
•• Primary application
 • Other application

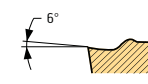
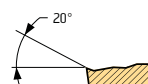
Counterboring / precision boring

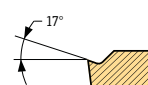
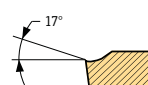
Geometry	Remarks on field of applications	Workpiece material group							Section Main cutting edge	Section Radius	ap [mm]	f [mm]
		P	M	K	N	S	H	O				
	E47 - The universal one – 15° rake angle – Flexible universal geometry for almost all cutting depths – For materials in ISO machining groups P, M, K and S	••	••	••	•	••					0,3–6,3	0,07–0,45
	PS5 – Semi-Finishing – Universal insert for semi-machining to medium machining – Can also be used for counterboring	••	••	••		•				0,16–2,5	0,08–0,32	
	PM2 – Universal insert for non-ferrous metal materials – Sharp cutting edge with fully ground circumference – Polished rake face	•	•		••	•				0,4–3,0	0,02–0,80	
	PM5 – Universal insert geometry, medium / roughing operations – Extremely large chip breaking area	••	••	••		•				0,4–5,0	0,1–0,50	
 Wiper	PF – Finishing with wiper technology – High surface quality – High feed rates	••	••	••		•				0,30–3,0	0,12–0,60	
	PF2 – Finishing insert with fully ground circumference – Long, small diameter shafts with vibration tendency – Low cutting forces	••	••	•	••	••				0,25–1,6	0,02–0,25	
	PF4 – Finishing insert – Outstanding chip control – Can also be used for precision boring	••	••			••				0,15–1,0	0,08–0,30	
	PF5 – Finishing insert with fully ground circumference – Can also be used for precision boring – Extremely narrow chip breaker groove	••	••			•				0,1–0,8	0,04–0,16	

•• Primary application
 • Other application

Tool diameter-tolerance ranges for Walter insert drill B 421x

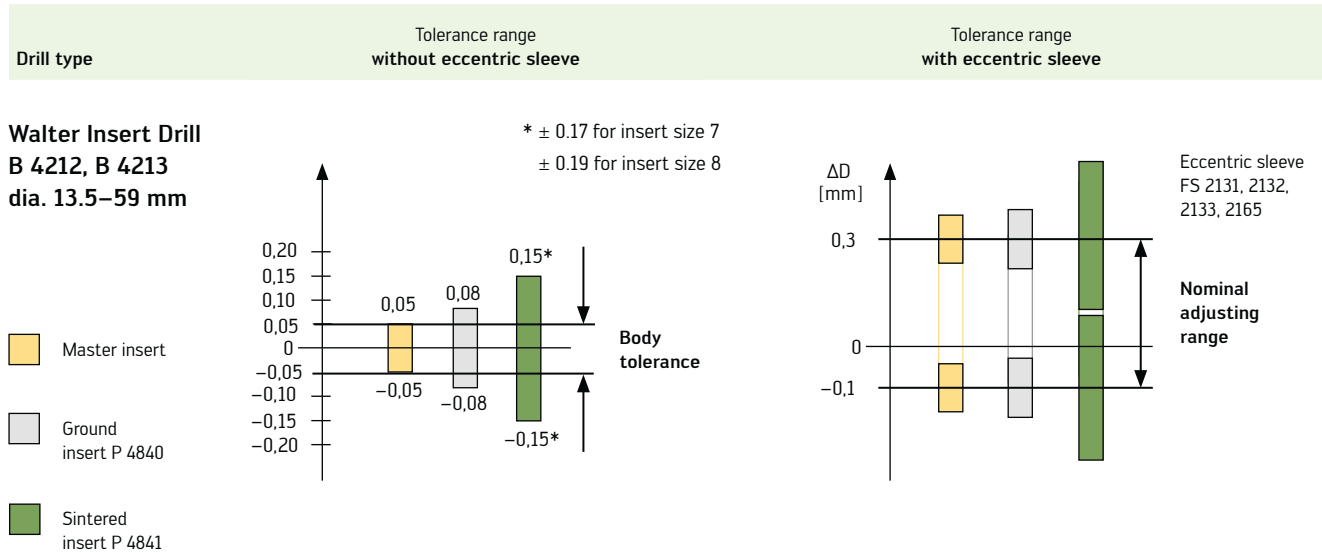

The resulting workpiece diameter may differ due to the drilling depth, workpiece material, feed rate and chip removal conditions.

Tool diameter tolerance ranges for Walter Stardrill B 321x

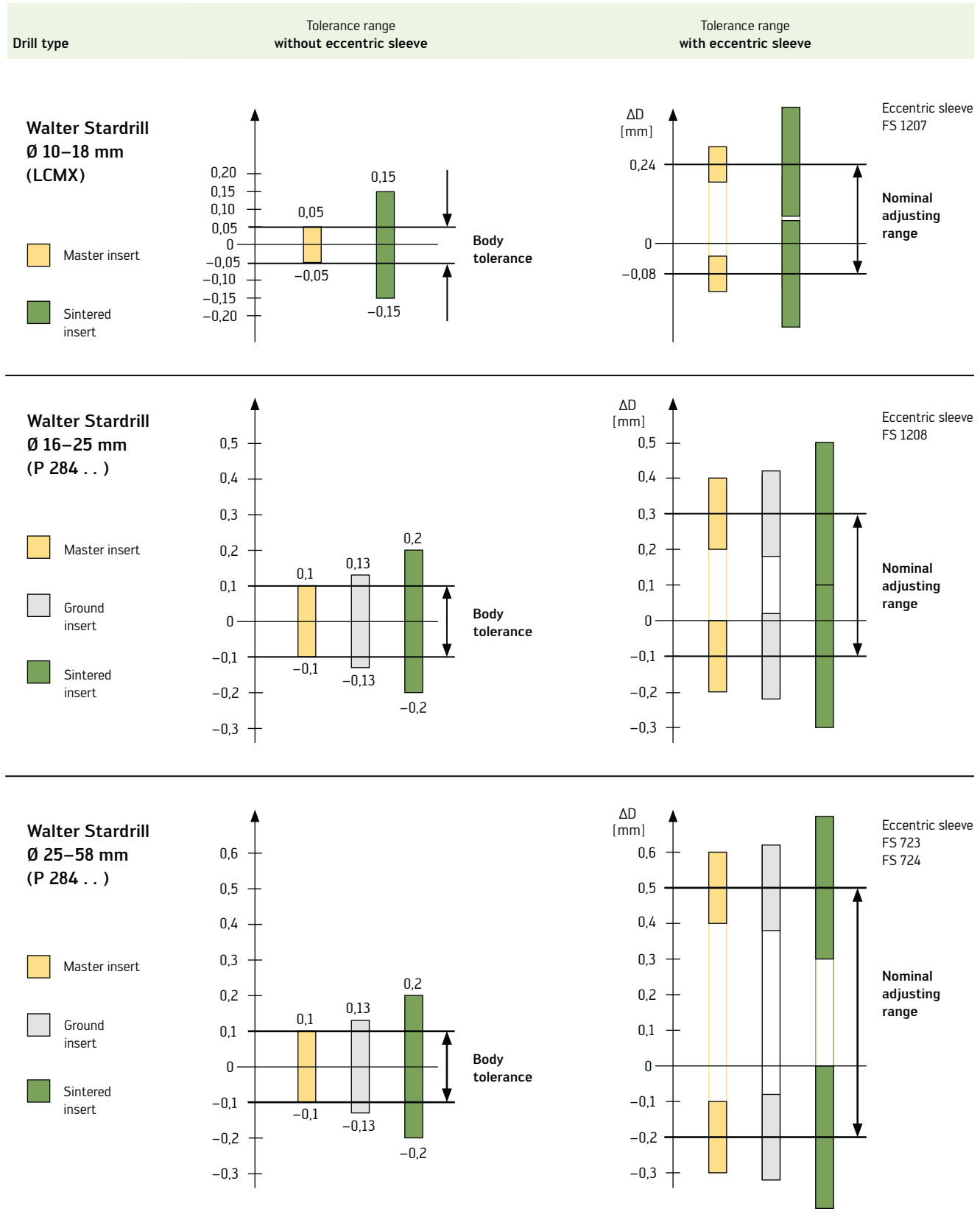

The resulting workpiece diameter may differ due to the drilling depth, workpiece material, feed rate and chip removal conditions.

Drilling with X offset Xtra-tec® Insert Drill B 421x

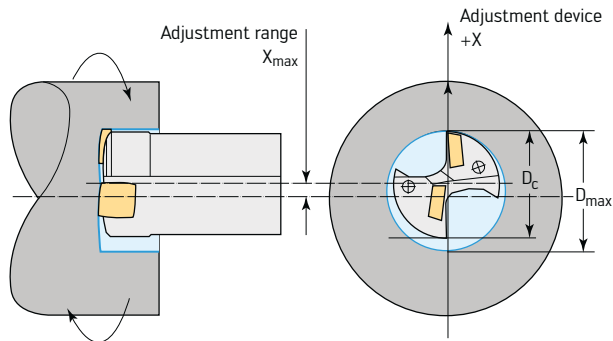

Drilling with X offset:

Drill: stationary

Workpiece: rotating

$$D = D_c + 2 \cdot X$$

Insert size	Range 1			Range 2	
	D _c mm	Delta x mm	D _{max} mm	Delta x _{max} mm	D _{max} mm
1	13,5	0,5	14,5	0,7	14,9
	14	0,35	14,7	0,6	15,2
	14,5	0,3	15,1	0,5	15,5
	15	0,2	15,4	0,45	15,9
	15,5	0,15	15,8	0,35	16,2
	16	0,05	16,1	0,3	16,6
	16,4	0	–	0,2	16,8
	16,5	0,6	17,7	0,9	18,3
2	17	0,5	18	0,75	18,5
	17,5	0,35	18,2	0,6	18,7
	18	0,3	18,6	0,55	19,1
	18,5	0,2	18,9	0,45	19,4
	19	0,15	19,3	0,4	19,8
	19,5	0,07	19,64	0,3	20,1
	20	0	20	0,25	20,5
	20,4*	0	–	0,15	20,7
3	20,5	0,35	21,2	0,7	21,9
	21	0,3	21,6	0,6	22,2
	21,5	0,17	21,84	0,45	22,4
	22	0,15	22,3	0,45	22,9
	22,5	0,02	22,54	0,3	23,1
	23	0	–	0,3	23,6
	23,5*	0	–	0,18	23,86
	24*	0	–	0,15	24,3
4	24,4*	0	–	0	–
	24,5	0,5	25,5	0,85	26,2
	25	0,35	25,7	0,75	26,5
	25,5	0,25	26	0,6	26,7
	26	0,15	26,3	0,55	27,1
	26,5	0,05	26,6	0,4	27,3
	27	0	–	0,4	27,8
	27,5	0	–	0,25	28
5	28*	0	–	0,25	28,5
	28,5*	0	–	0,12	28,74
	29*	0	–	0,1	29,2
	29,4*	0	–	0	–
	29,5	0,7	30,9	1,1	31,7
	30	0,6	31,2	1	32
	31	0,45	31,9	0,8	32,6
	32	0,3	32,6	0,7	33,4
6	33	0,15	33,3	0,5	34
	34	0	–	0,4	34,8
	35*	0	–	0,3	35,6
	35,4*	0	–	0,2	35,8

Insert size	Range 1			Range 2		
	D _c mm	Delta x mm	D _{max} mm	Delta x _{max} mm	D _{max} mm	
6	35,5	0,8	37,1	1,4	38,3	
	36	0,7	37,4	1,25	38,5	
	37	0,55	38,1	1,1	39,2	
	38	0,4	38,8	0,95	39,9	
	39	0,25	39,5	0,8	40,6	
	40	0,1	40,2	0,65	41,3	
	41	0	–	0,55	42,1	
	42	0	–	0,4	42,8	
	42,4	0	–	0,3	43	
	7	42,5	0,95	44,4	1,65	45,8
		43	0,85	44,7	1,5	46
		44	0,7	45,4	1,35	46,7
45		0,55	46,1	1,2	47,4	
46		0,4	46,8	1,1	48,2	
47		0,25	47,5	0,95	48,9	
48		0,15	48,3	0,8	49,6	
49		0	–	0,65	50,3	
50		0	–	0,55	51,1	
50,4		0	–	0,45	51,3	
8		50,5	1,05	52,6	1,85	54,2
		51	0,95	52,9	1,75	54,5
	52	0,8	53,6	1,6	55,2	
	53	0,65	54,3	1,45	55,9	
	54	0,55	55,1	1,35	56,7	
	55	0,4	55,8	1,2	57,4	
	56	0,3	56,6	1,1	58,2	
	57	0,15	57,3	0,95	58,9	
	58	0	–	0,8	59,6	
	59	0	–	0,7	60,4	
	59,4	0	–	0,6	60,6	

* Outer insert with wiper edge (P4840P . . .) can only be used 2x.

Maximum out of centre positioning for Walter Stardrill B 321x

1. Adjustment range for Walter Stardrill $D_c = 16-58$ mm with indexable inserts P 284 . .

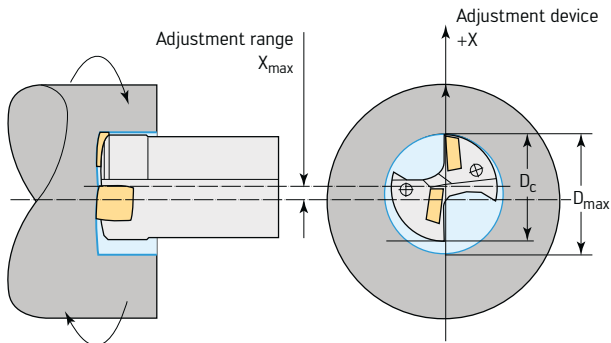

Drilling with X offset:
 Drill: stationary
 Workpiece: rotating

$$D = D_c + 2 \cdot X$$

Insert size	Range 1			Range 2	
	D_c mm	X_{max} mm	D_{max} mm	X_{max} mm	D_{max} mm
1	16	1,0	18,0	1,8	19,6
	17	0,8	18,6	1,5	20,0
	18	0,7	19,4	1,3	20,6
	19	0,5	20,0	1,0	21,0
	20	0,3	20,6	0,8	21,6
2	21	1,1	23,2	2,0	25,0
	22	0,9	23,8	1,7	25,4
	23	0,8	24,6	1,5	26,0
	24	0,6	25,2	1,2	26,4
	25	0,4	25,8	1,0	27,0
3	26	1,0	28,0	1,7	29,4
	27	0,8	28,6	1,4	29,8
	28	0,6	29,2	1,2	30,4
	29	0,4	29,8	0,9	30,8
	30	0,3	30,6	0,7	31,4
4	31	1,1	33,2	1,9	34,8
	32	0,9	33,8	1,6	35,2
	33	0,7	34,4	1,4	35,8
	34	0,5	35,0	1,1	36,2
	35	0,3	35,6	0,8	36,6
	36	0,2	36,4	0,6	37,2

Insert size	Range 1			Range 2	
	D_c mm	X_{max} mm	D_{max} mm	X_{max} mm	D_{max} mm
5	37	0,9	38,8	1,8	40,6
	38	0,7	39,4	1,5	41,0
	39	0,5	40,0	1,2	41,4
	40	0,5	41,0	1,2	42,4
	41	0,4	41,8	0,9	42,8
	42	0,2	42,4	0,6	43,2
	43	1,1	45,2	2,2	47,4
6	44	0,9	45,8	1,9	47,8
	45	0,7	46,4	1,6	48,2
	46	0,9	47,8	1,6	49,2
	47	0,7	48,4	1,3	49,6
	48	0,5	49,0	1,0	50,2
	49	0,3	49,6	0,8	50,6
	50	0,2	50,4	0,6	51,2
7	51	1,1	53,2	2,3	55,6
	52	0,9	53,8	2,0	56,0
	53	0,8	54,6	1,7	56,4
	54	1,1	56,2	2,0	58,0
	55	0,9	56,8	1,7	58,4
	56	0,7	57,4	1,5	59,0
	57	0,6	58,2	1,2	59,4
	58	0,4	58,8	0,9	59,8
	59	0,2	59,4	0,5	60,0

Range 1: Possible adjustment under normal conditions

Range 2: Adjustment only achievable under optimum conditions

2. Adjustment range for Walter Stardrill $D_c = 10-18$ mm with indexable inserts LCMX . .

$X = +0,2$ mm / $-0,1$ mm $\rightarrow \Delta D = +0,4$ mm / $-0,2$ mm

Drilling strategy Xtra-tec® Point Drill B 401x

Drilling depth > 5 x D_c

Centring hole
B 4011 .. / B 4013 .. Ø ca. 0,7 x D_c

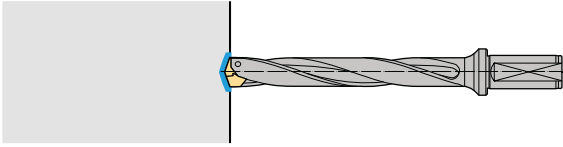

n = - 20 %
f = - 50 %

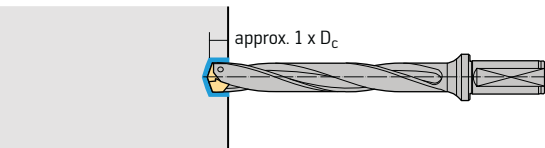

n = 100 %
f = 100 %

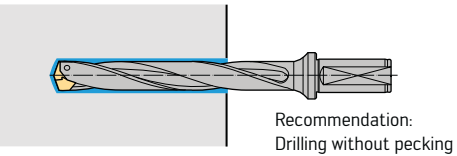

Drilling depth > 7 x D_c

Pilot hole
B 4011 .. / B 4013 ..

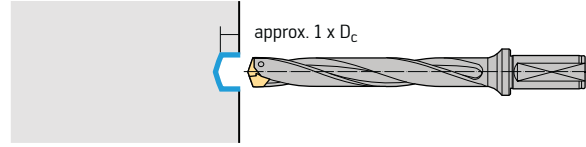

max. approx. 500 rpm

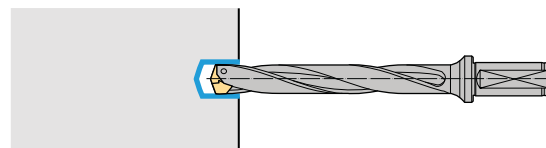

n = - 20 %
f = - 50 %

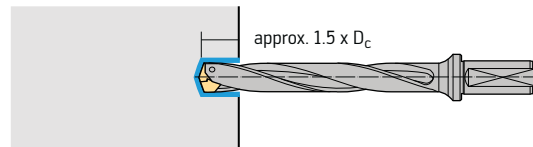

n = 100 %
f = 100 %

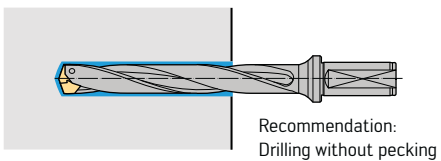

Recommended values for Xtra·tec® point drill B401x

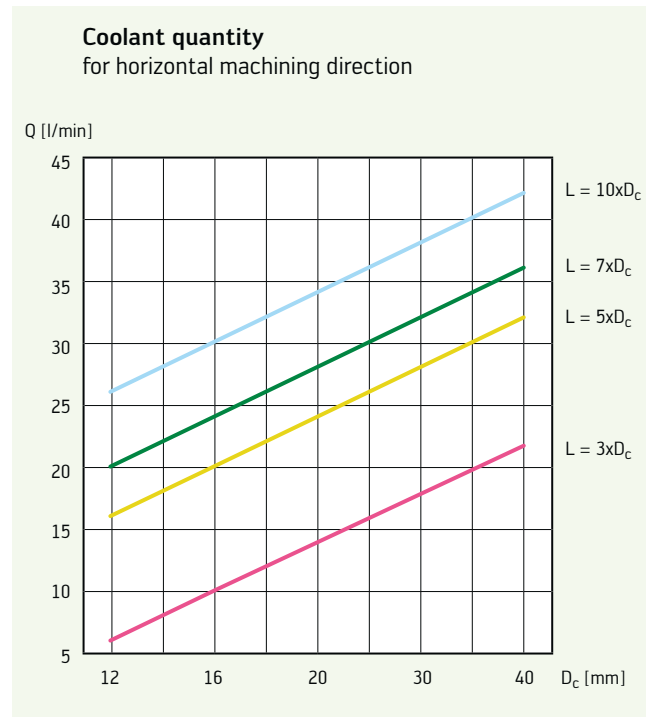
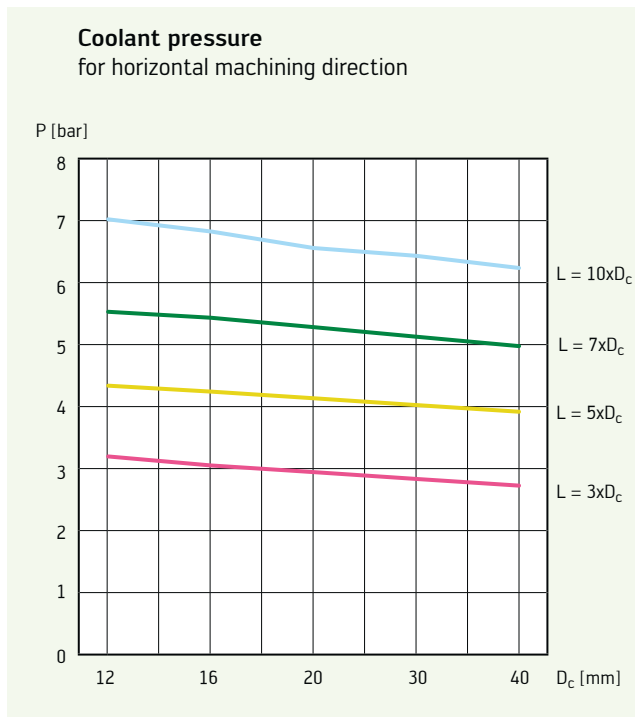

Recommended values for Xtra·tec® insert drill B421x

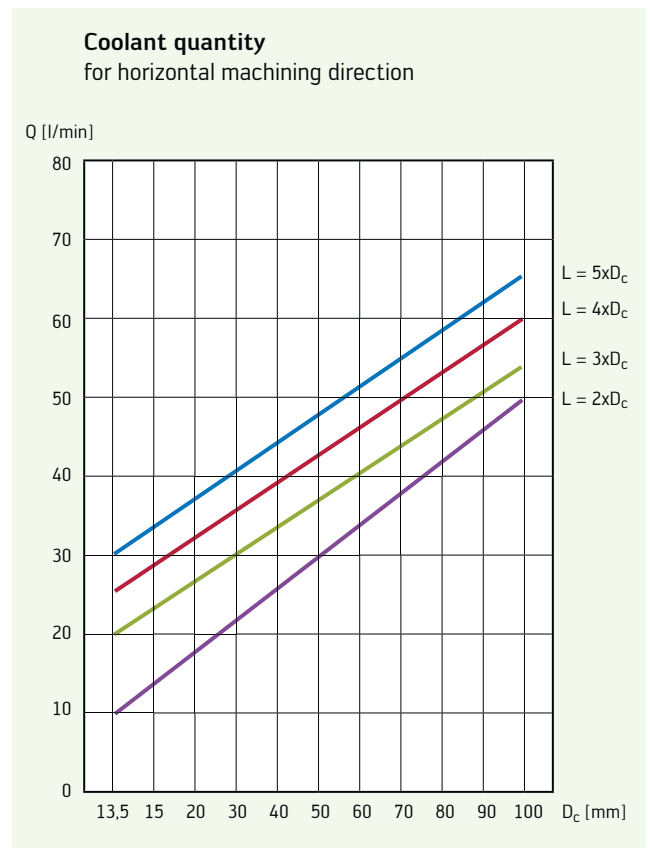
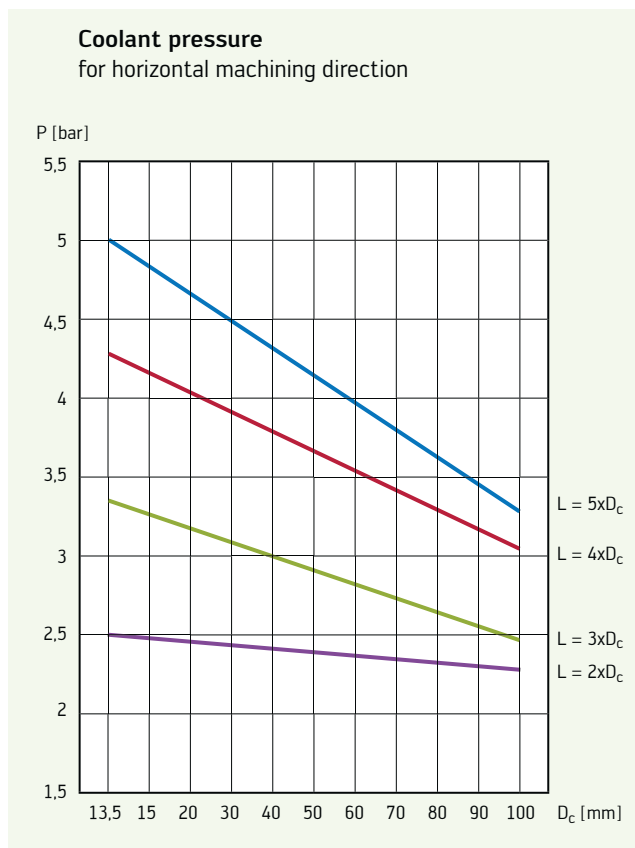

Increase or reduction of coolant flow rate Q and coolant pressure P compared with minimum values:

Bad chip breaking: increase of up to +50 %
 Vertical machining direction: increase of 30–40 %

Recommended values for drilling Xtra-tec® Point Drill B401x

Material: C45 – (1.0503) steel, cast steel [Rm = 650 N/mm²]

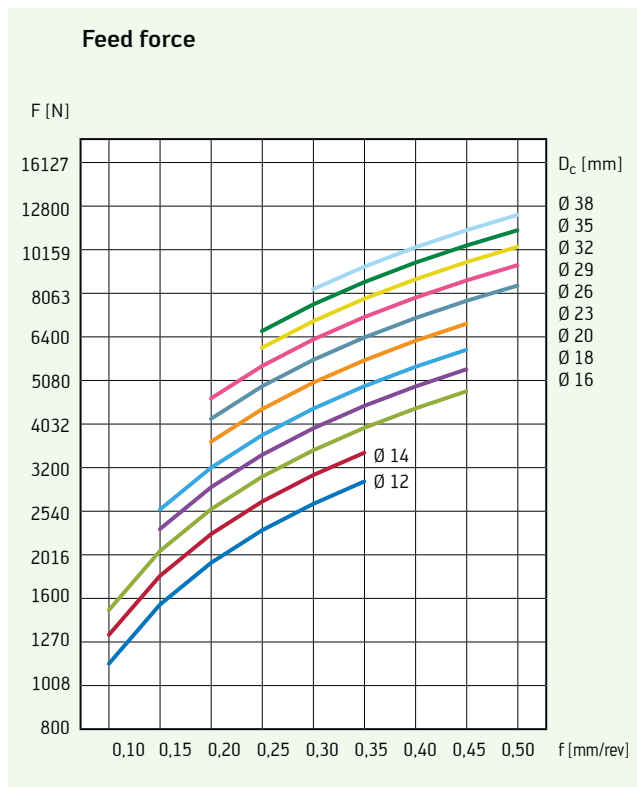
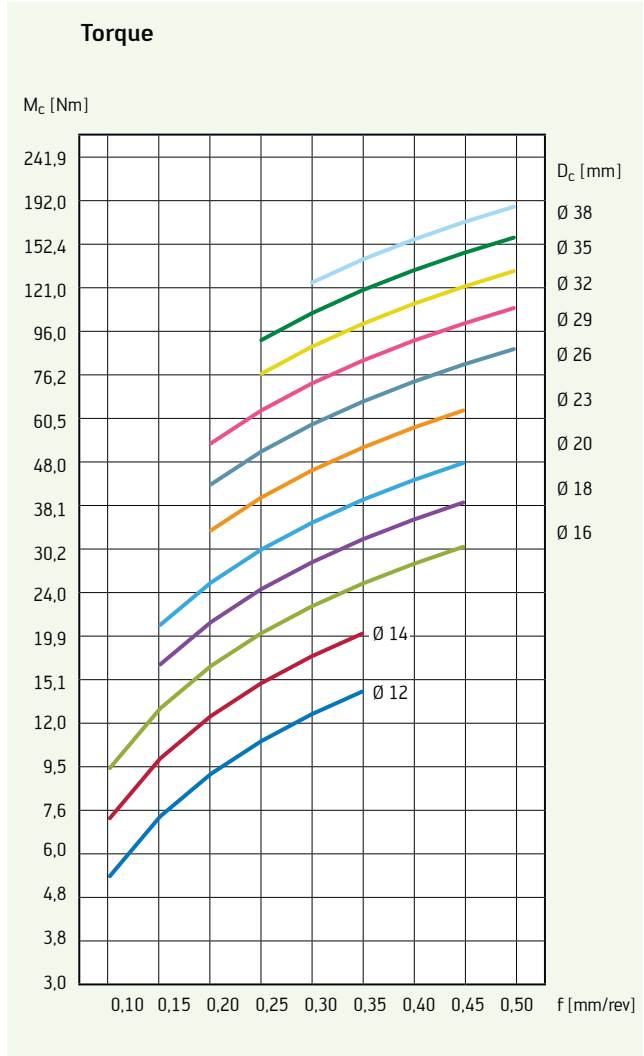
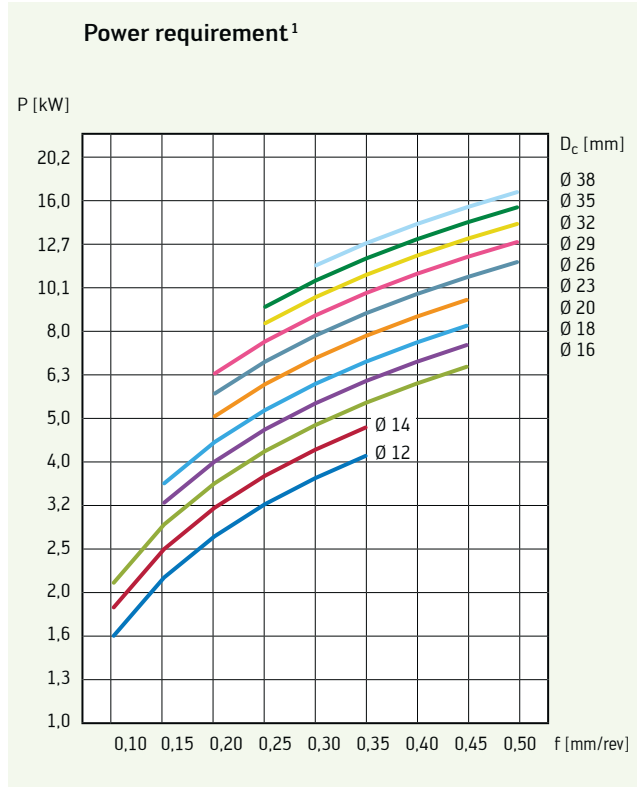

The power requirement¹ data is based on a cutting speed of 100 m/min. If the cutting speed is doubled, the power requirement also doubles, i.e. the power requirement is directly proportional to the cutting speed. For steels with a higher tensile strength, the power and torque required are correspondingly higher.

Recommended values for drilling Xtra·tec® Point Drill B401x

Material: 42CrMo4 – CrMo-alloyed heat treatable steel [Rm = 750–900 N/mm²]

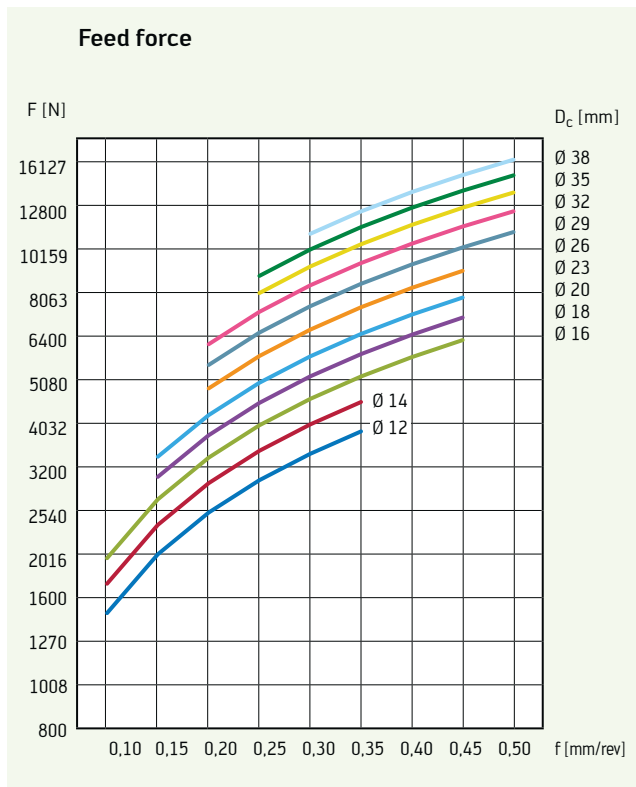
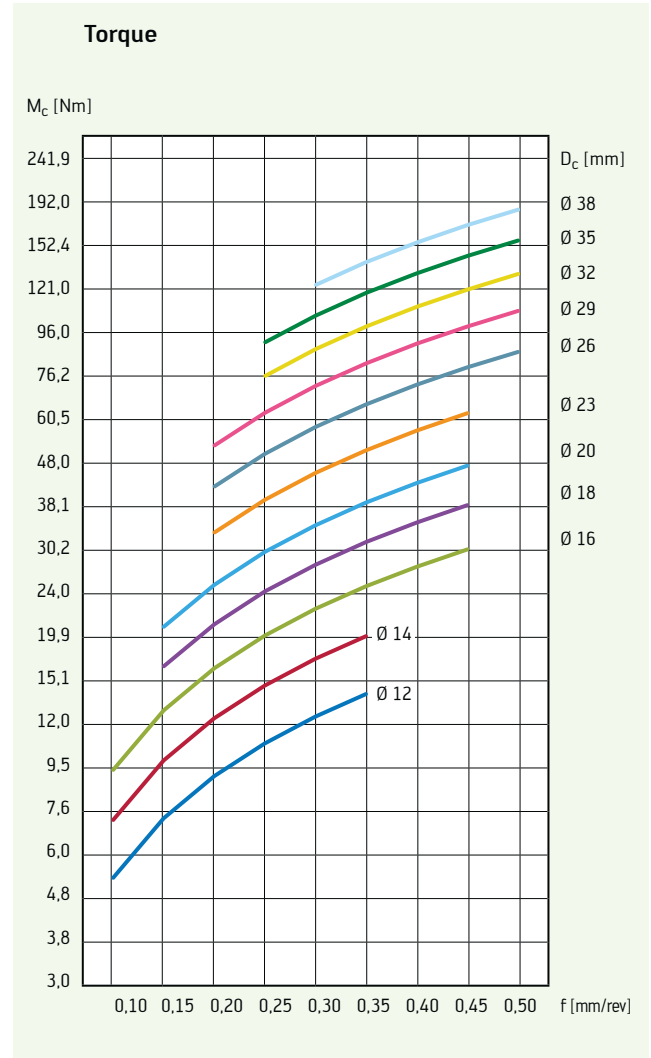
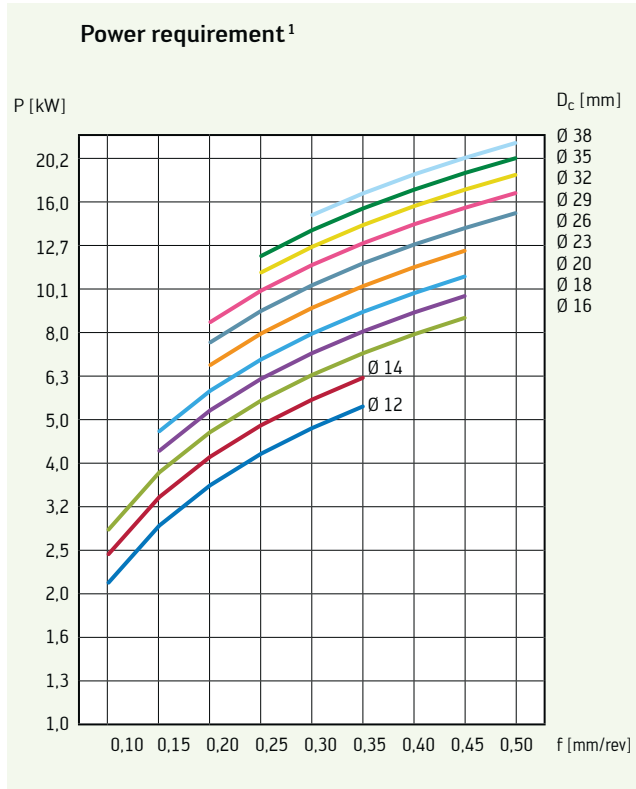

The power requirement¹ data is based on a cutting speed of 100 m/min.

If the cutting speed is doubled, the power requirement also doubles, i.e. the power requirement is directly proportional to the cutting speed.

For steels with a higher tensile strength, the power and torque required are correspondingly higher.

Recommended values for drilling Xtra-tec® Point Drill B401x

Material: GG25 – (0.6025) cast iron, ferritic [180-200 HB]

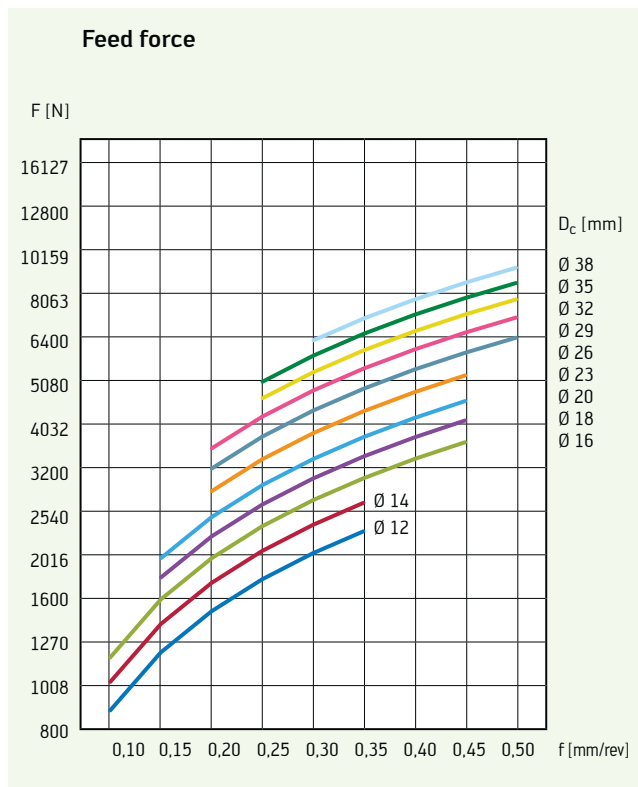
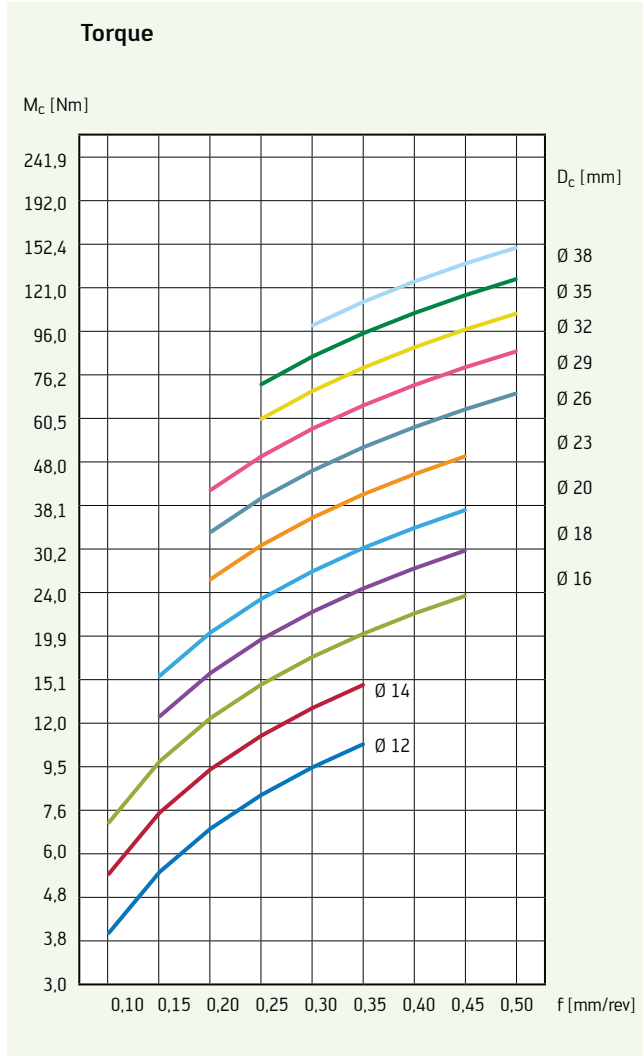
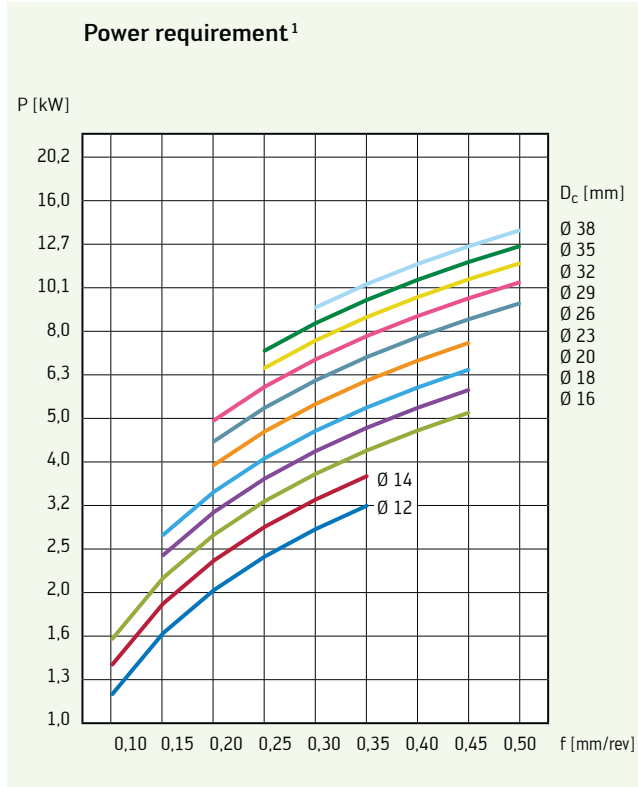

The power requirement¹ data is based on a cutting speed of 100 m/min.

If the cutting speed is doubled, the power requirement also doubles, i.e. the power requirement is directly proportional to the cutting speed.

For cast iron with a higher tensile strength, the power and torque required are correspondingly higher.

Recommended values for drilling Xtra·tec® Point Drill B401x

Material: GGG70 – (0.7070) cast iron with spheroidal graphite [Rm = 690 N/mm²]

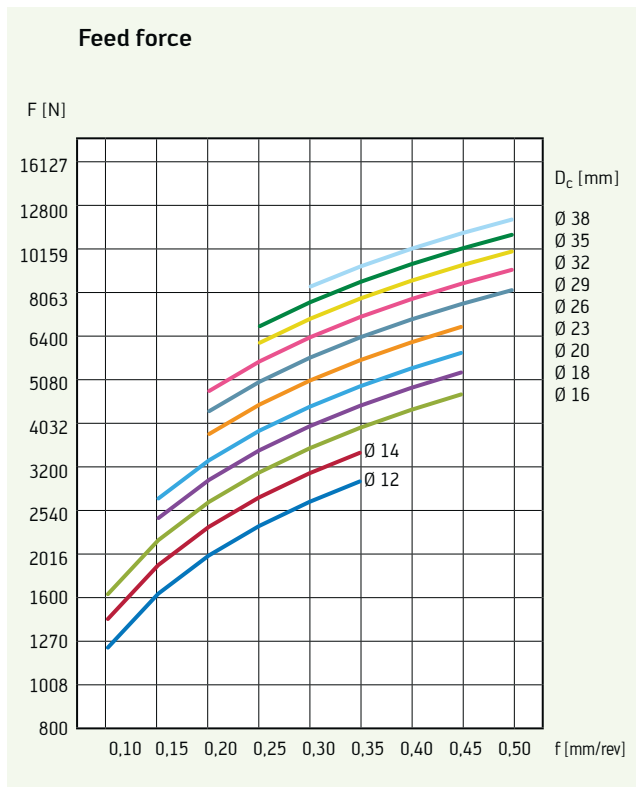
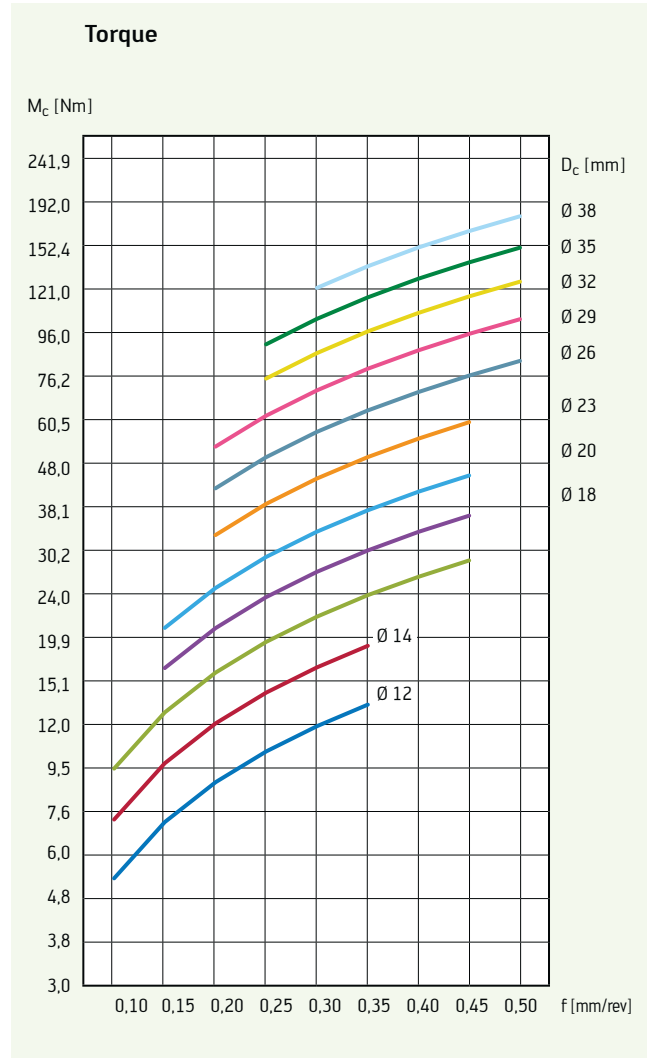
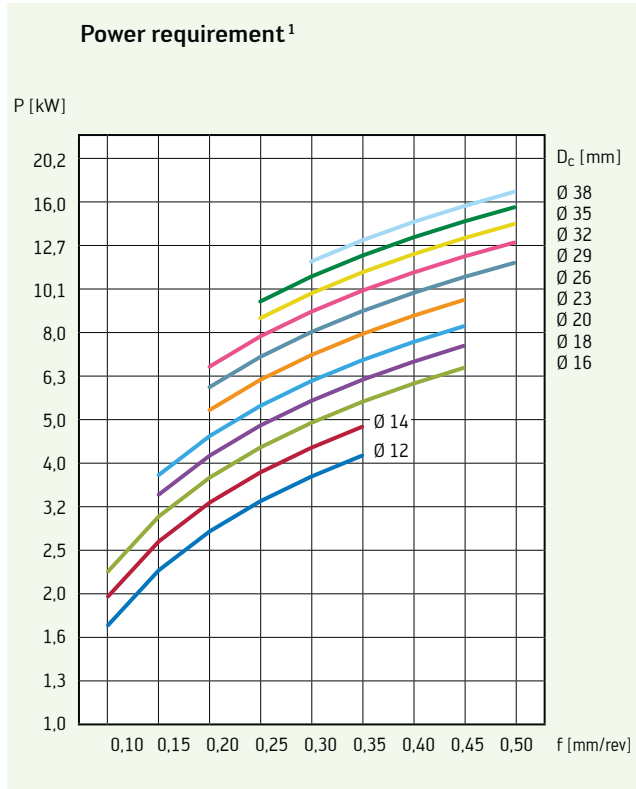

The power requirement¹ data is based on a cutting speed of 100 m/min.

If the cutting speed is doubled, the power requirement also doubles, i.e. the power requirement is directly proportional to the cutting speed.

For cast iron with a higher tensile strength, the power and torque required are correspondingly higher.

Recommended values for drilling Xtra-tec® Insert Drill B421x

Material: C45 – (1.0503) steel, cast steel [$R_m = 650 \text{ N/mm}^2$]

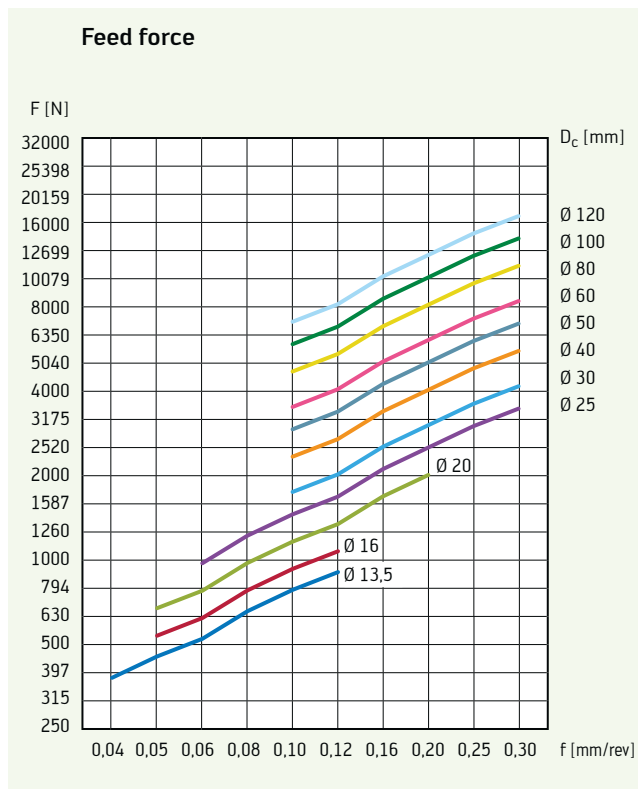
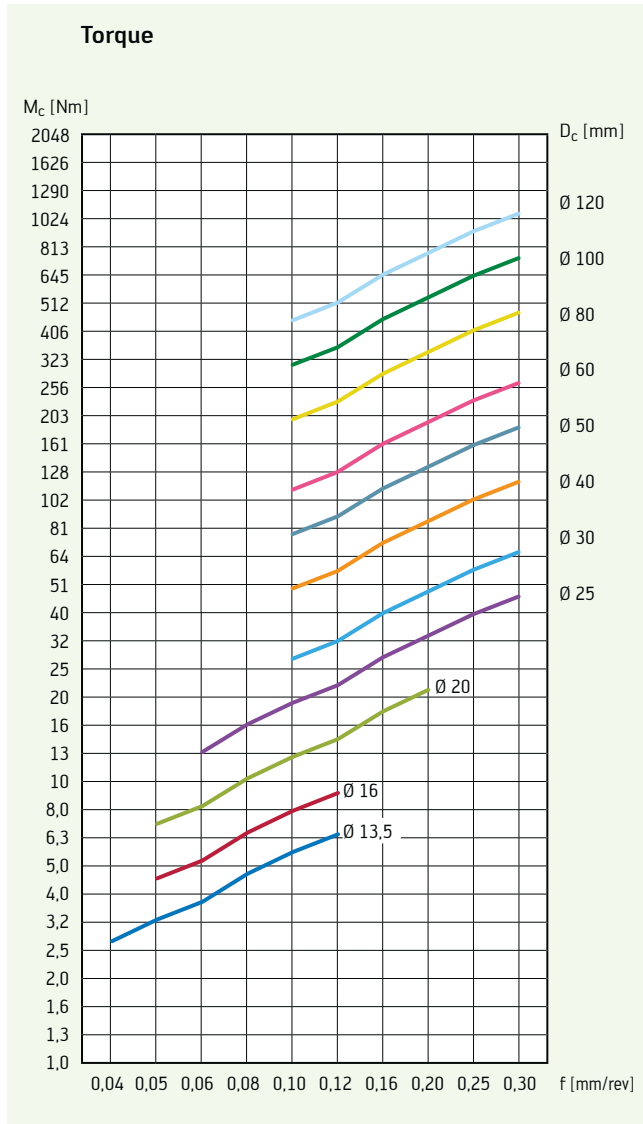
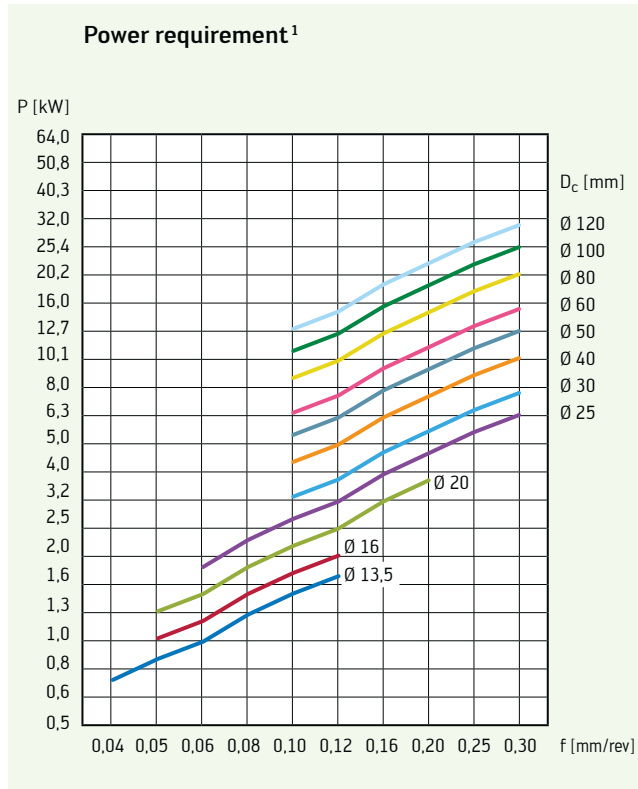

The power requirement¹ data is based on a cutting speed of 100 m/min.

If the cutting speed is doubled, the power requirement also doubles, i.e. the power requirement is directly proportional to the cutting speed.

For steels with a higher tensile strength, the power and torque required are correspondingly higher.

Recommended values for drilling Xtra-tec® Insert Drill B421x

Material: 42CrMo4 – CrMo-alloyed heat treatable steel [Rm = 750–900 N/mm²]

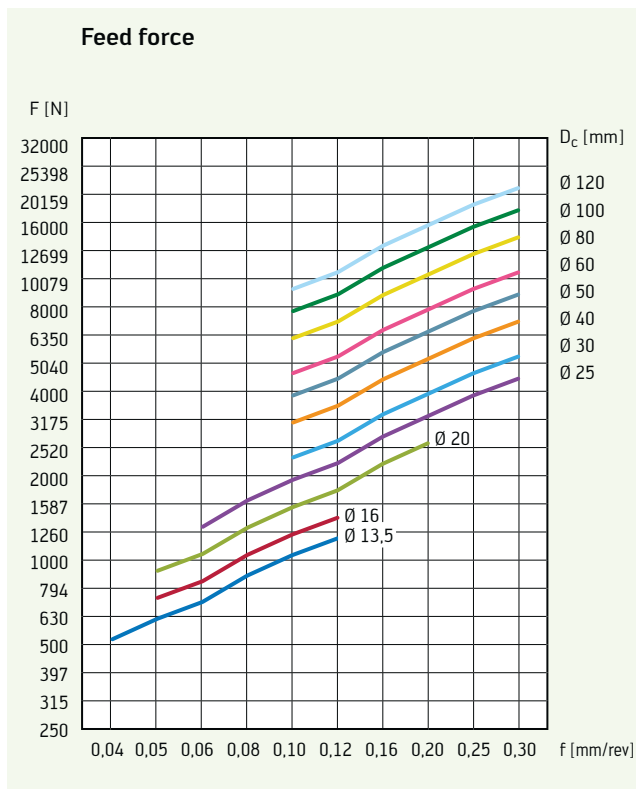
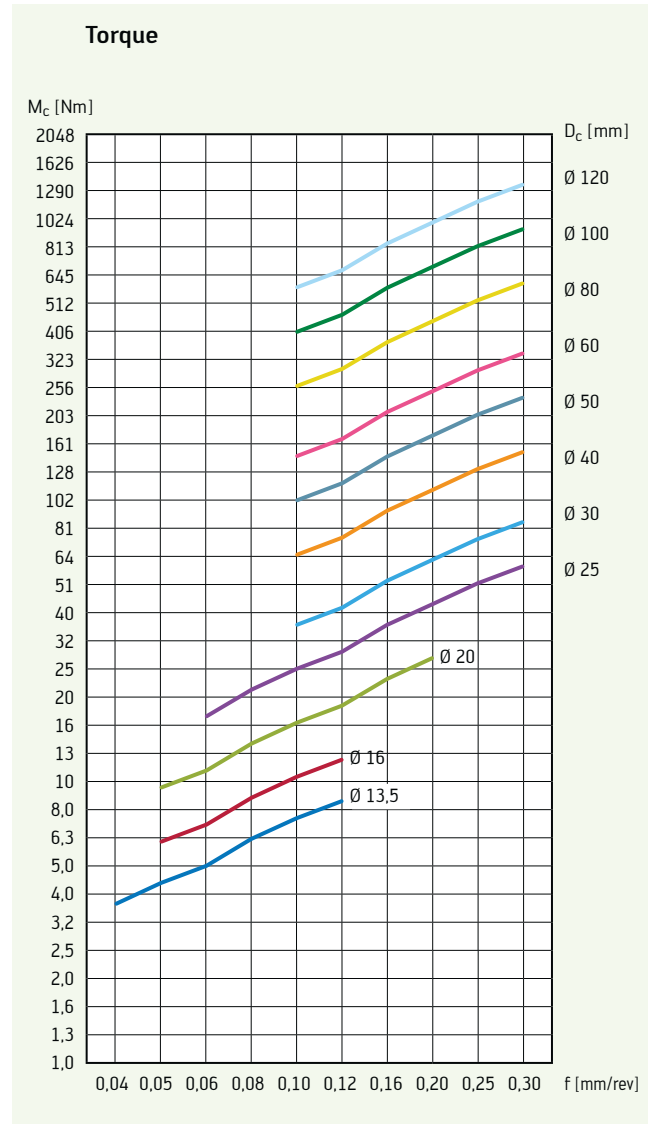
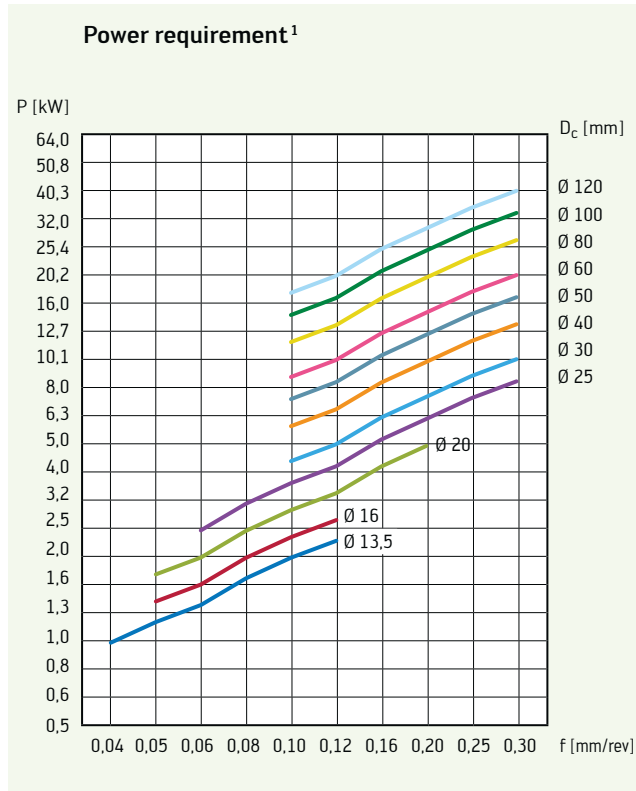

The power requirement¹ data is based on a cutting speed of 100 m/min.

If the cutting speed is doubled, the power requirement also doubles, i.e. the power requirement is directly proportional to the cutting speed.

For steels with a higher tensile strength, the power and torque required are correspondingly higher.

Recommended values for drilling Xtra-tec® Insert Drill B421x

Material: GG25 – (0.6025) cast iron, ferritic [180-200 HB]

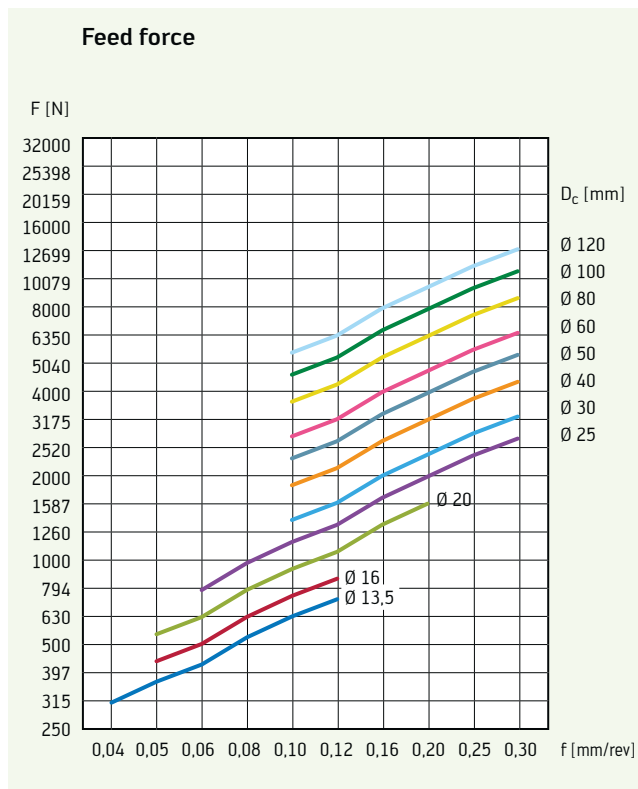
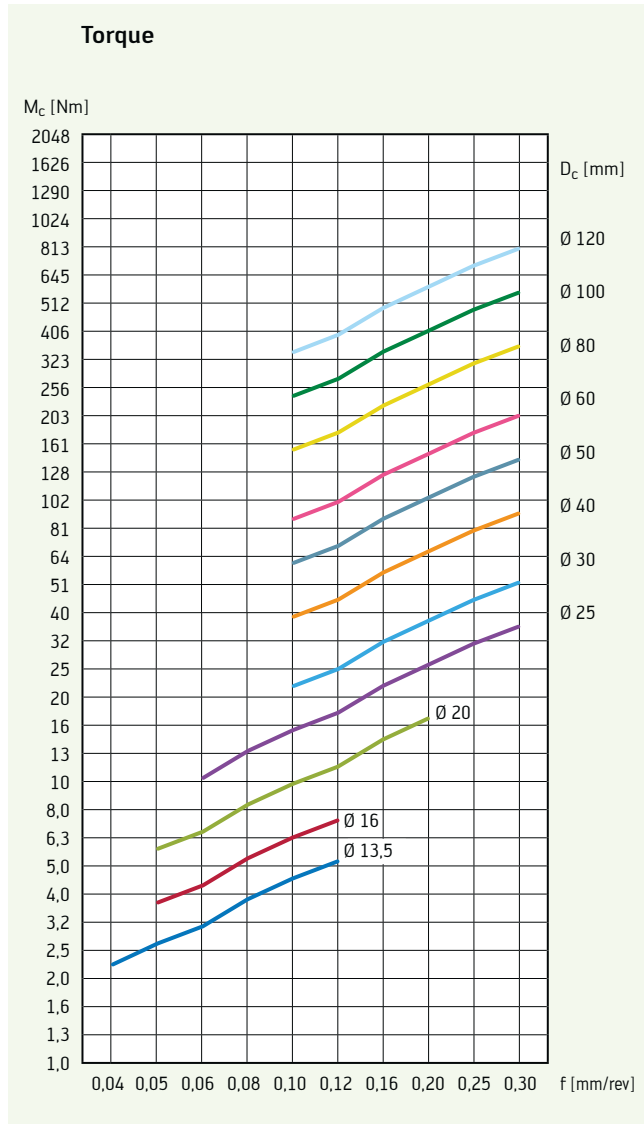
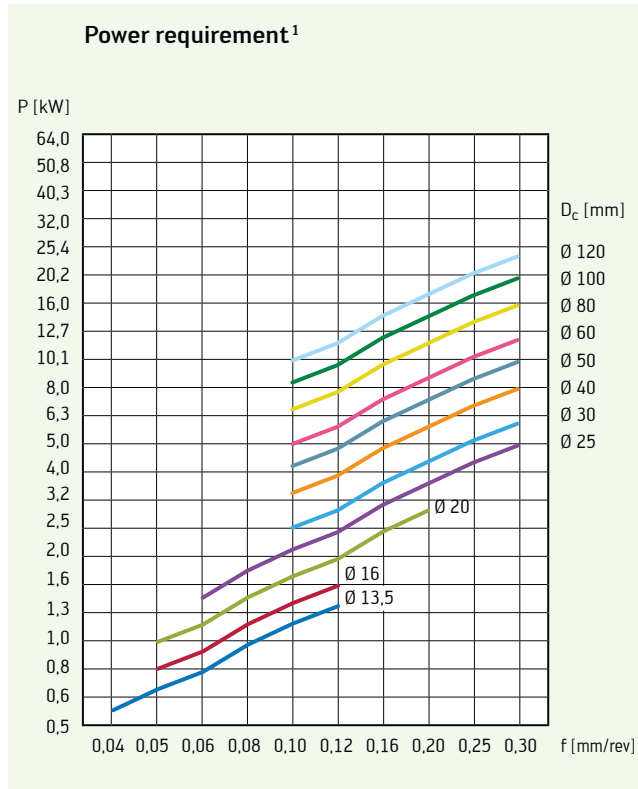

The power requirement¹ data is based on a cutting speed of 100 m/min.

If the cutting speed is doubled, the power requirement also doubles, i.e. the power requirement is directly proportional to the cutting speed.

For cast iron with a higher tensile strength, the power and torque required are correspondingly higher.

Recommended values for drilling Xtra·tec® Insert Drill B421x

Material: GGG70 – (0.7070) cast iron with spheroidal graphite [Rm = 690 N/mm²]

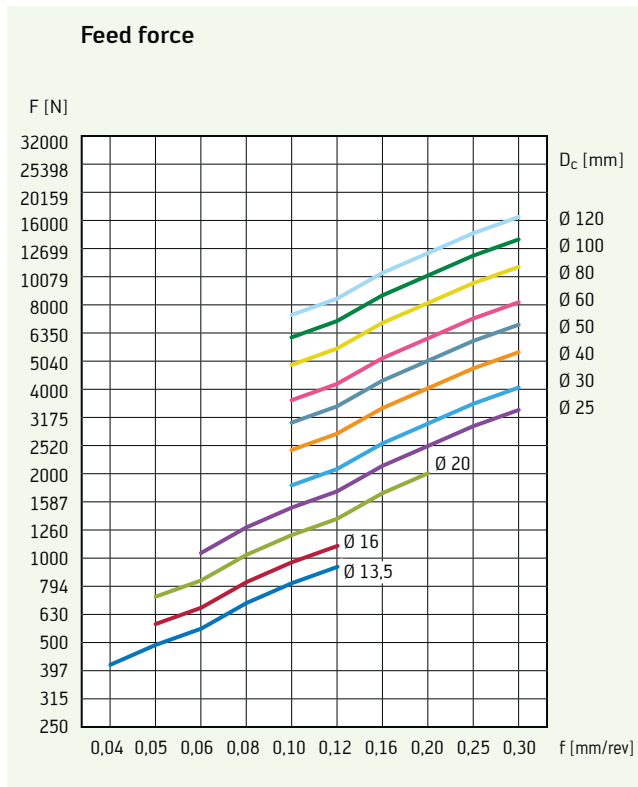
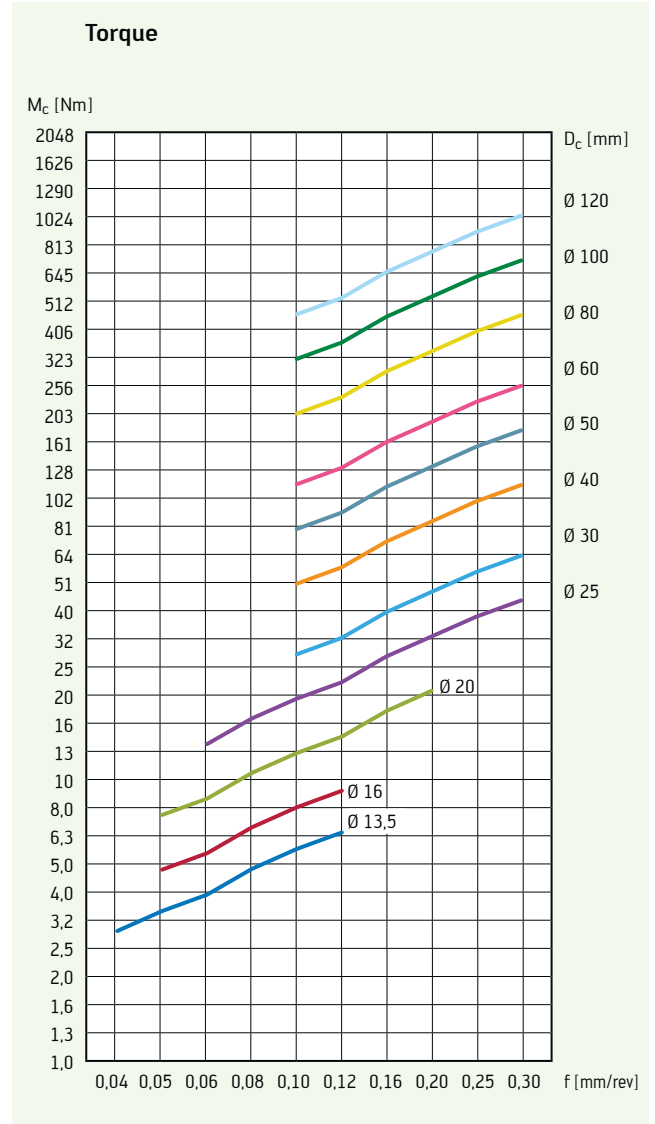
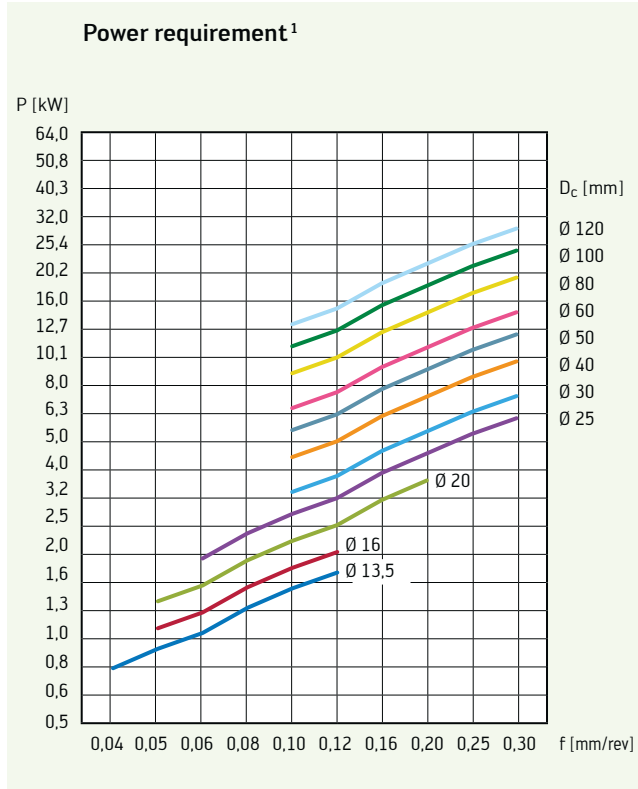

The power requirement¹ data is based on a cutting speed of 100 m/min.

If the cutting speed is doubled, the power requirement also doubles, i.e. the power requirement is directly proportional to the cutting speed.

For cast iron with a higher tensile strength, the power and torque required are correspondingly higher.

Setting instructions for Walter Precision boring tools B 3230 / B 4030

These tools have a highly precise adjustment mechanism.

The scale graduation permits trouble-free adjustment of the cutting edges in the μ range.

Walter Precision^{MINI}

1. Slide tool or insert holder ①, using a reducing sleeve ② if necessary, into the locating bore of the base body ③ until both clamping screws ④ have an effect.
2. Align the cutting edge with the marking provided on the face of the boring head and tighten the two screws ④.
3. Move base body ③ to required position by rotating the adjusting screw ⑤ with the clamping screw ⑥ slackened.
The scale slide with vernier scale allows for a precise reading of the diameter change (1 DIV = 0.01 mm in diameter, with vernier scale 1 DIV = 0.002 mm in diameter).
4. Tighten clamping screw ⑥.

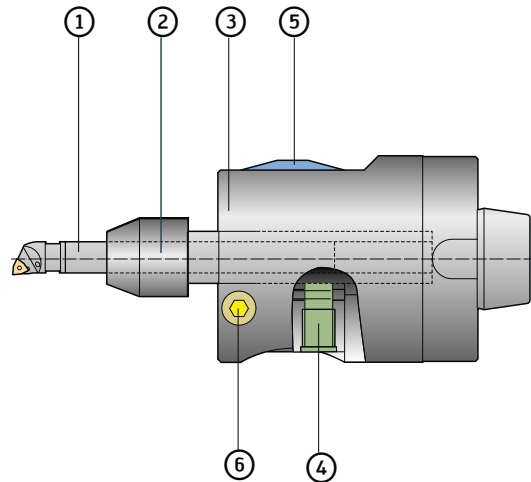

Walter Precision^{MEDIUM}

1. Position cartridge ① in cartridge guide of base body ③ and secure with clamping screws ④.
2. Slacken clamping screws ⑥.
3. Move cartridge holder into required position by rotating the adjusting screw ⑤ with the clamping screw ⑥ slackened.
The scale slide with vernier scale allows for a precise reading of the diameter change (1 DIV = 0.01 mm in diameter, with vernier scale 1 DIV = 0.002 mm in diameter).
4. Tighten clamping screw ⑥.

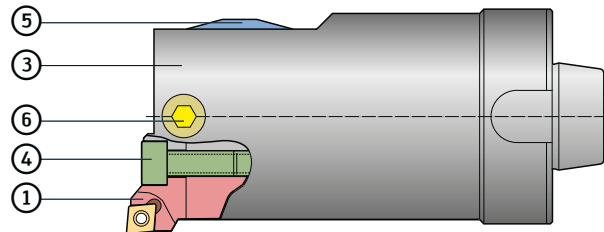

General information

Observe the path restriction of the base body. When adjusting, never use force. Periodical lubrication (approx. every 20 operating hours) via the lubricating nipple (face of base body) guarantees extremely high precision coupled with a long service life.

We recommend using a light machine oil such as Mobil Vactra Oil No. 2, BP Energol HLP-32, Klueber Isoflex PDP 94.

Operating instructions for the Walter Precision^{DIGITAL} B 4035

Clamping / diameter adjustment

1. Switch on the digital display by pressing the "ON / Reset" button.
2. Slacken clamping screw ①.
3. Adjust boring range using adjusting screw ② using an Allen key (SW4) and reading off the display at the same time.
Display = actual adjusting distance
+ = diameter increase - = diameter reduction
4. Tighten clamping screw ①.

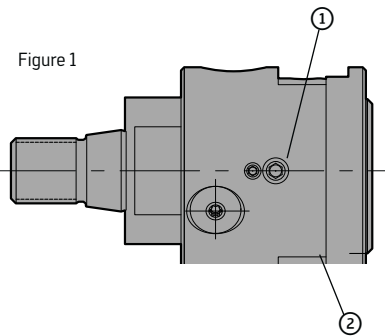

Mini boring tools Ø 3–10 mm

1. Insert adaptor ③ into bore of body and secure with the two tapered grub screws ②.
2. Insert mini insert holder ① up to Ø 14.7 mm into the adaptor.
3. Align cutting position via the surface ④ at the end of the shank.
4. Clamp mini insert holder via the tapered grub screw ⑤ (4 Nm).
5. Diameter adjustment in acc. with Fig. 1.

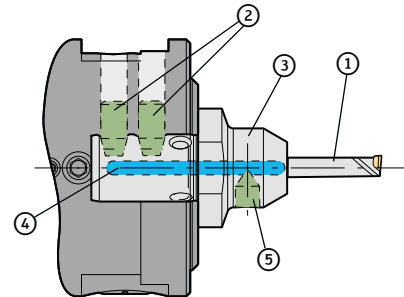

Boring bar Ø 20–32 mm

1. Clamp boring bar ① in body with the two fastening screws ②.
2. Diameter adjustment in acc. with fig. 1.

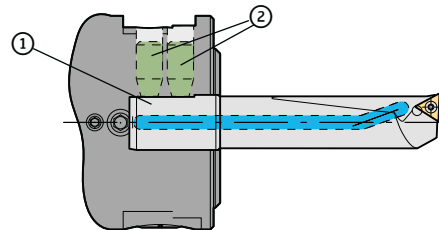

Extension and cartridges Ø 32–68 mm

1. Secure extensions ① in body with the two tapered grub screws ②.
2. Place cartridge ③ in serrations of extension and clamp with screw ④ (8 Nm).
3. Pre-set cartridge ③ to Ø on basis of scale.
4. Diameter adjustment in acc. with fig. 1.

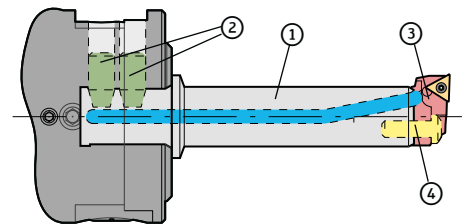

Bridges with lubricant transfer piece Cartridges for unscrewing and counterweight Ø 68–124 mm

1. Insert coolant transfer piece ⑥ into locating bore in body and secure with the two tapered grub screws ⑦.
2. Secure bridge ① to body (8 Nm) with 4 fastening screws ②.
3. Place cartridge ③ onto bridge (next to coolant outlet).
4. Roughly preset cartridge to required Ø using scale. Tighten with clamping screw ④ (8 Nm).
5. Fit counterweight ⑤ at opposite side, align to Ø using scale and secure.
6. Diameter adjustment in acc. with fig. 1.

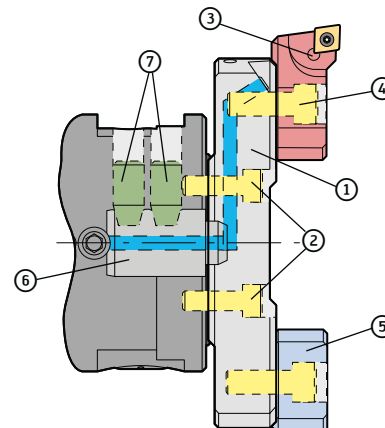

Detailed operating instructions including notes on balancing compensation are included with the tool kit.

Precision boring cartridge

Method of operation

- ① Axial adjustment (1 mm) via wedge element
 - ② Fastening screw (5–6 Nm)
 - ③ Fine adjustment
0.001 mm in diameter per graduation mark
Radial adjusting distance 0.3 mm
 - ④ Lubricating nipple
Recommended lubricant
Lithium soap grease NLGi class 1 KP1N10
e.g. Fuchs Renolit GL 1
- The maintenance interval depends on the application conditions.
Re-greasing should be needed about every 4 weeks in the event of continuous use.
- ⑤ Rotational speed max. 10,000 rpm



Adjusting instructions for balance compensation Walter Precision^{MINI} precision boring tools B 4030

- ① Angle scale
- ② Adjusting ring A
- ③ Adjusting ring B
- ④ Clamping screw

1. Set required diameter (see page C 188).
2. Rotate adjusting rings ② + ③ to the neutral position and secure ① (Figure 1).
3. Take imbalance values from the settings table (included in delivery).
Take account of the corner radius R.
4. Example:
Tool diameter 28.5 mm
Imbalance U
5. Set imbalance value 350 gmm of adjusting ring A ② on 160° of angle scale ① and secure the ring (Figure 2).
6. Set imbalance value 350 gmm of adjusting ring B ③ to zero value of adjusting ring A ② and secure the ring (Figure 3).

Figure 1

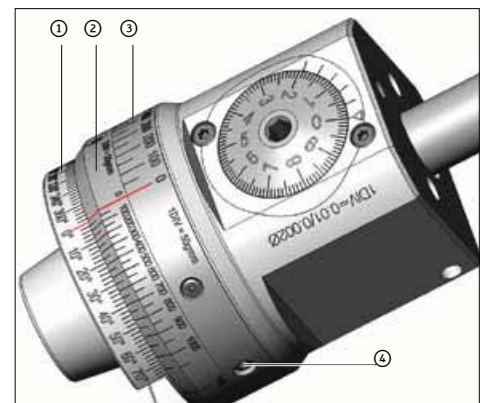

Figure 2

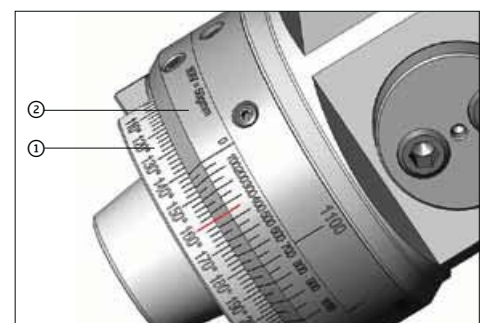
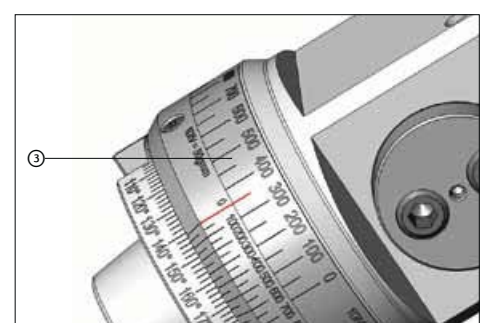

Figure 3



Assembly instructions for Walter bridge-type boring tools

Walter Boring^{MAXI} Boring tool B 3220 / B 3224

- ① Basic body
- ② Bridge
- ③ Clamping screws for bridge
- ④ Cartridge holder
- ⑤ Cartridge
- ⑥ Clamping screws for cartridge

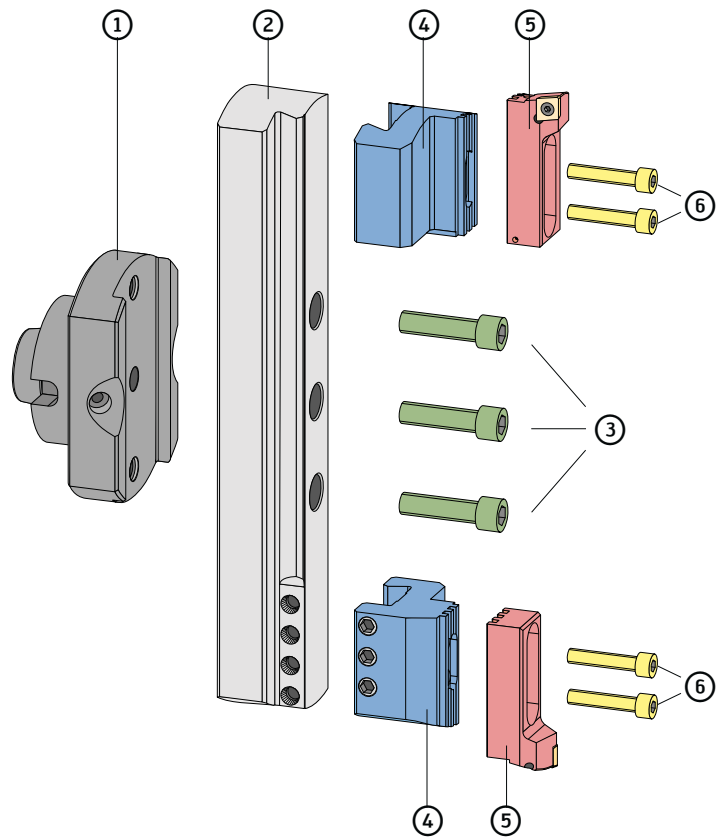

Walter Precision^{MAXI} Precision boring tool B 3230 / B 3234

- ① Basic body
- ② Bridge
- ③ Clamping screws for bridge
- ④ Cartridge holder with cartridge
- ⑤ Balance compensation

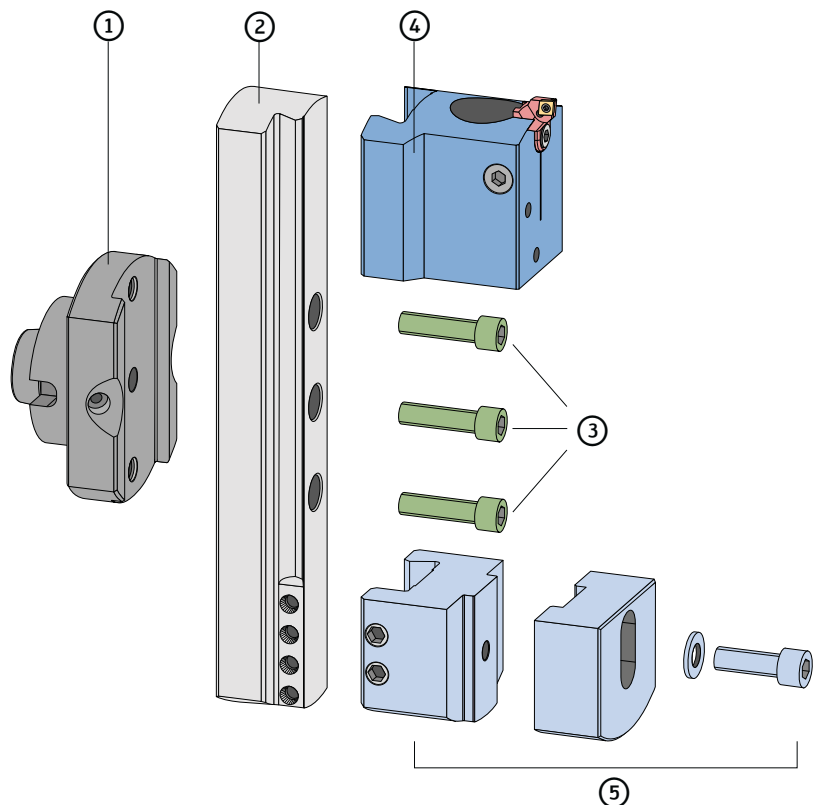

Application information

Adjustment range of Walter Boring two flute boring tool B 3220

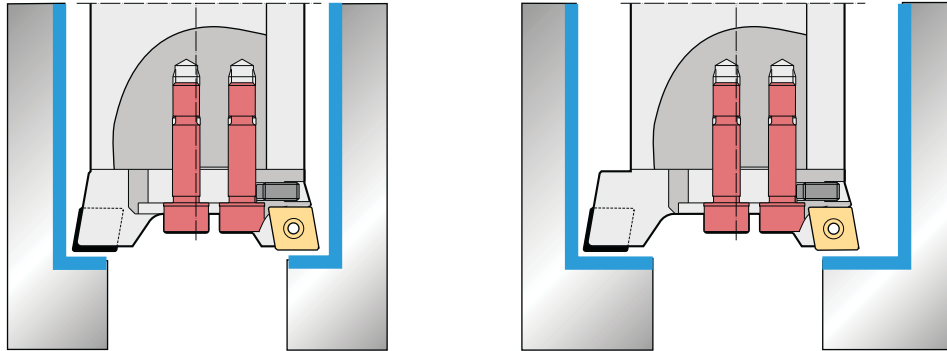

Adjustment range of standard assembly parts for Walter special boring tools

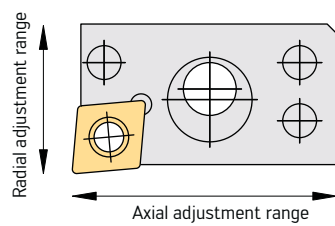

Group	Page	Axial	Radial
ISO cartridges	C 130	2 mm	0,5 mm
Walter mini cartridges	C 138	1,0 mm	0,5 mm
Walter precision boring cartridges	C 143	1,0 mm	0,3 mm

Cutting orientation for ScrewFit precision boring tools

The cutting orientation ensures that the position of the cutting edge is suitably aligned with the adaptor groove or indexing surface ("German corner").

If the ScrewFit interface is tightened with a defined torque, it is ensured that the cutting edge lies at $0^\circ \pm 15^\circ$.

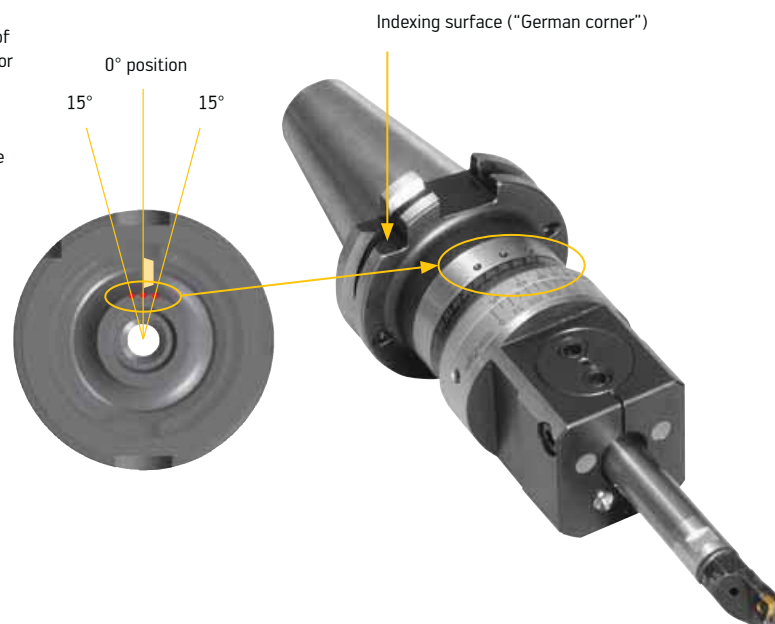

Notes on high-speed cutting

- Maximum permissible speed: The limiting values shown in the tables should not be exceeded. Otherwise the functionality and / or reliability are not guaranteed.
- Only use original Walter inserts and assembly parts (screws etc.). Recommendation: After having changed the inserts at least five times, new screws should be fitted.
- Adhere to the torques specified in the catalogue.
- Balancing:
 - Balancing in two steps is required when milling in the upper speed range (> 6,000):
 - Basic balancing of tool body including inserts (carried out by Walter upon request). The tool adaptor must also be balanced!
 - Fine balancing of the cutter when fully mounted on the adaptor. The fine balancing operation is strongly recommended as even the smallest eccentricity can seriously affect the balance status.
- Short projection lengths reduce concentricity faults or an imbalance as well as increase spindle life. The specified speeds apply to the use of tools without additional extensions.
- Safety guards:
 - Appropriate safety guards or machine encapsulations must be used to securely collect particles which spin off such as chips or cutting edges that are broken as a result of collisions.

- Damaged tools:
 - The operating speed must be specified when arranging the repair of the HSC tool.
 - Only Walter may carry out repairs on Walter tools for HSC machining operations.
- Technical progress:
 - As research and standardisation on HSC machining operations is ongoing, we reserve the right to make technical changes. The discussion on balancing specifications is still in progress. The results of the "Balancing" study group of the Technical University in Darmstadt show that the quality category G16 is usually sufficient.

1. Walter Boring tools B 3220 / B 3221

Diameter range D _C [mm]	n _{max} [1/min]
20–24	16.000
26–33	12.000
33–41	10.000
41–55	7.800
55–70	5.800
70–90	4.600
90–110	3.700
110–153	2.900
150–220	2.100
220–290	1.450
290–360	1.100
360–430	900
430–500	750
500–570	650
570–640	550

The specified limiting speeds refer to symmetrically set tools (Z=2).
For non-symmetrically set tools (Z=1), the values are reduced by 50 %.

2. Walter Precision boring tools B 3230

Diameter range D _C [mm]	n _{max} [1/min]
2–45,5*	6.000
20–26	12.000
26–33	10.000
33–41	8.100
41–55	6.450
55–70	4.850
70–90	3.835
90–110	3.090
110–153	2.390
150–220	1.440
220–290	1.090
290–360	880
360–430	740
430–500	630
500–570	550
570–640	490

* The boring bar should be positioned as centrally as possible. Use the largest boring bar size possible.

3. Walter Precision boring tools B 4030

Diameter range D _C [mm]	n _{max} [1/min]
2–10*	14.000
10–20*	12.000
20–45*	8.000
33–41	15.000
41–55	11.500
55–70	9.000
70–90	7.000
90–110	5.500
110–153	4.000

4. Walter Precision^{DIGITAL} boring tools B 4035

Diameter range D _C [mm]	n _{max} [1/min]
3–20	16.000
20–32	12.000
32–80	10.000
50–68	8.000
68–96	6.000
96–124	5.000

* The boring bar should be positioned as centrally as possible. Use the largest boring bar size possible.

Technical information on reaming

Poor surface

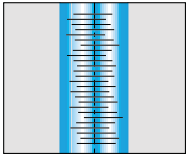

- Check material removal
- Improve cooling (connection, pressure, quality)
- Lower feed rate, increase rake angle
- Select other chamfer geometry (insert / reaming tool)
- Check axial position of indexable insert

Chatter marks

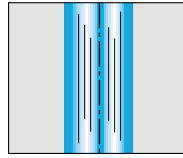

- Check concentricity (workpiece / tool)
- Enlarge backtaper

Retraction marks

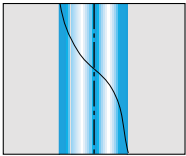

- Improve cooling (connection, pressure, quality)
- Check concentricity (workpiece / tool)
- Enlarge backtaper

Eccentric bore

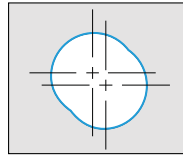

- Check clamping of workpiece
- Check dimension
- Check concentricity (workpiece / tool)
- Check axial position of indexable insert

Conical entry

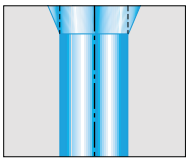

- Lower feed rate
- Check concentricity (workpiece / tool)
- Check backtaper
- Check concentricity of tool

Conical bore

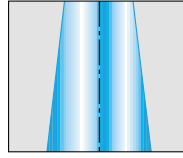

- Check concentricity (workpiece / tool)
- Check backtaper

Deformed bore

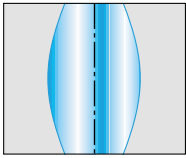

- Check clamping of workpiece

Off-centre bore

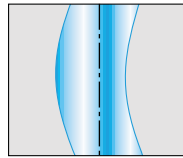

- Select other chamfer geometry (insert / reaming tool)
- Check axial position of indexable insert

Diameter too large

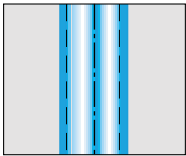

- Check concentricity (workpiece / tool)
- Reset reamer

Lubricants

To achieve maximum service life and the best hole quality, adhere to the following guidelines:

- An internal coolant supply should preferably always be used. Only use external cooling with reaming tools R 4060 up to $\varnothing 20$ = reaming depth $1 \times D$ over $\varnothing 20$ = reaming depth < dimension l_4 (= length of guide rail) Reduce cutting data.
- With steel, aluminium, cast iron: use water-soluble oils with min. 40 % mineral oil.
- Concentration: oil solution with min. 6–8 % concentration
- Filtration: 30–50 μm
- Quantity: min. 0.5 l/min/mm tool diameter (e.g. reaming tools $\varnothing 10$, minimum quantity 5 l/min.)

Concentricity – Rotating application (machining centre)

- max. deviation 0.01 mm
- Recommendation: hydraulic collet chuck or precision collet

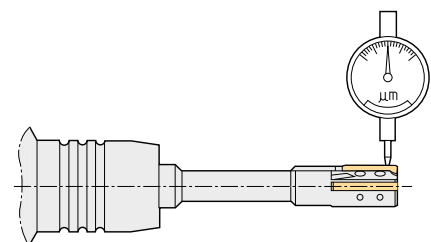

Setting device

See page C 126.

Indexable insert change and diameter setting with Walter reaming tools

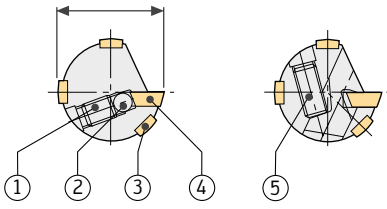

1. Slacken the 2 adjusting screws ① by rotating them anticlockwise by 1/4 of a turn.



4. Press the insert firmly against the axial limit stop and the positioning balls ⑤.



2. Slacken the 2 clamping screws ②.



5. Tighten the clamping screw, to do this hold the key at the short end.



3. Thoroughly clean the insert seat and the insert. Turn the insert ④ or insert a new one.



6. Set the gauge on the guide rail lying behind the cutting ③ edge to zero.



7. Measuring point A:
Set the insert using adjusting ① screw so that the cutting edge is 0.02/0.015 mm above the guide pad (see picture below). This setting corresponds with the diameter marked "SD" on the tool body.

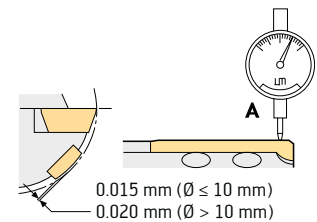

8. Measuring point B:
set gauge on guide rail to 0 (similar to point 6). Then set the insert to a diameter where a taper of 1 μm per mm of cutting length is achieved.

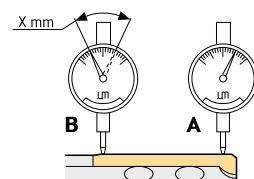

Insert size	00	0	1	2	4
Value X [mm]	0,01	0,02	0,025		

Taper 1/1000 (0.01 mm / 10 mm)

N.B.: specified setting dimensions only apply to standard catalogue tools.



Threading

	Information	D 2
WALTER PROTOTYP SOLID CARBIDE, HSS AND HSS-E (-PM) THREADING TOOLS	Product range overview	D 4
	Designation key	D 14
	Product ranges	D 16
	Walter Select – Thread tapping	D 18
	Walter Prototyp taps	
	M, MJ	D 36
	MF	D 134
	UNC / UNF / UN-8	D 79
	G / Rc / Rp / NPT / NPTF / Pg / BSW / Tr	D 232
	Insert helicoil threads	D 264
	Walter Select – Thread forming	D 328
	Walter Prototyp thread formers M, MF, UNC / UNF, G	D 330
	Walter Prototyp threading dies	D 362
	Walter Select – Thread milling	D 368
	Walter Prototyp thread milling cutters	D 370
TECHNICAL INFORMATION	Cutting data	D 396
	Type description	D 398
	Feed rate tables	D 399
	Coatings and surface treatments	D 400
	Application information	D 404
	The thread forming process	D 411
	Synchronous machining	D 412
	Strategies in thread milling	D 413
	Thread types according DIN	D 416
	Tolerance units	D 424
Thread tap drill diameter	D 426	

Threading tools

The highly innovative threading solutions of the Walter Prototyp competence brand make it possible to reduce costs, increase productivity and enhance competitive advantage. The comprehensive range of catalogue products offers the right tool whatever the machining method or process: HSS-E (-PM) and solid carbide taps and thread formers as well as milling cutters and indexable inserts. From > size M1, these tools are available as part of the standard range.

1 TMO and TMO HRC orbital thread mills

- Solid carbide thread milling cutters with TiCN and TAX coating
- For particularly small threads from M1.6 upwards
- TMO HRC specially developed for hardened materials up to 65 HRC from size M2 upwards

2 TM and TMC thread milling cutters

- Solid carbide thread milling cutters with TiCN coating for universal use up to a lead of 3 mm
- Thread milling with chamfering (TMC) possible in one operation up to a lead of 2 mm

3 Thread milling cutters with indexable inserts

- For large threads < M20
- Single- and double insert toolholder for double the feed rate



7

**4 TMD thread milling cutter**

- Drilling, countersinking and thread milling in one operation
- Three-edged solid carbide tool for high feeds and with low rate of wear per tooth
- With NHC coating for machining aluminium and with TAX coating for grey cast iron

5 Paradur® HSC

- Taps in micrograin carbide and special geometry for blind hole threads in steel up to 55 HRC
- With internal cooling and TiCN coating

6 Protodyn® (S) Eco plus

- HSS-E thread formers with new geometry with regard to the lead chamfer and the polygon
- Tool with special surface treatment with TiN and TiCN coating in the product range

7 Paradur® Eco HT

- HSS-E-PM blind hole taps for universal use
- The tool with THL coating is particularly suitable for adverse chip formation and difficult materials
- Particularly cost-effective with wet or dry machining

8

**8 Prototex® Eco HT**

- HSS-E-PM through hole taps for universal use
- TiN and THL coating for long tool life

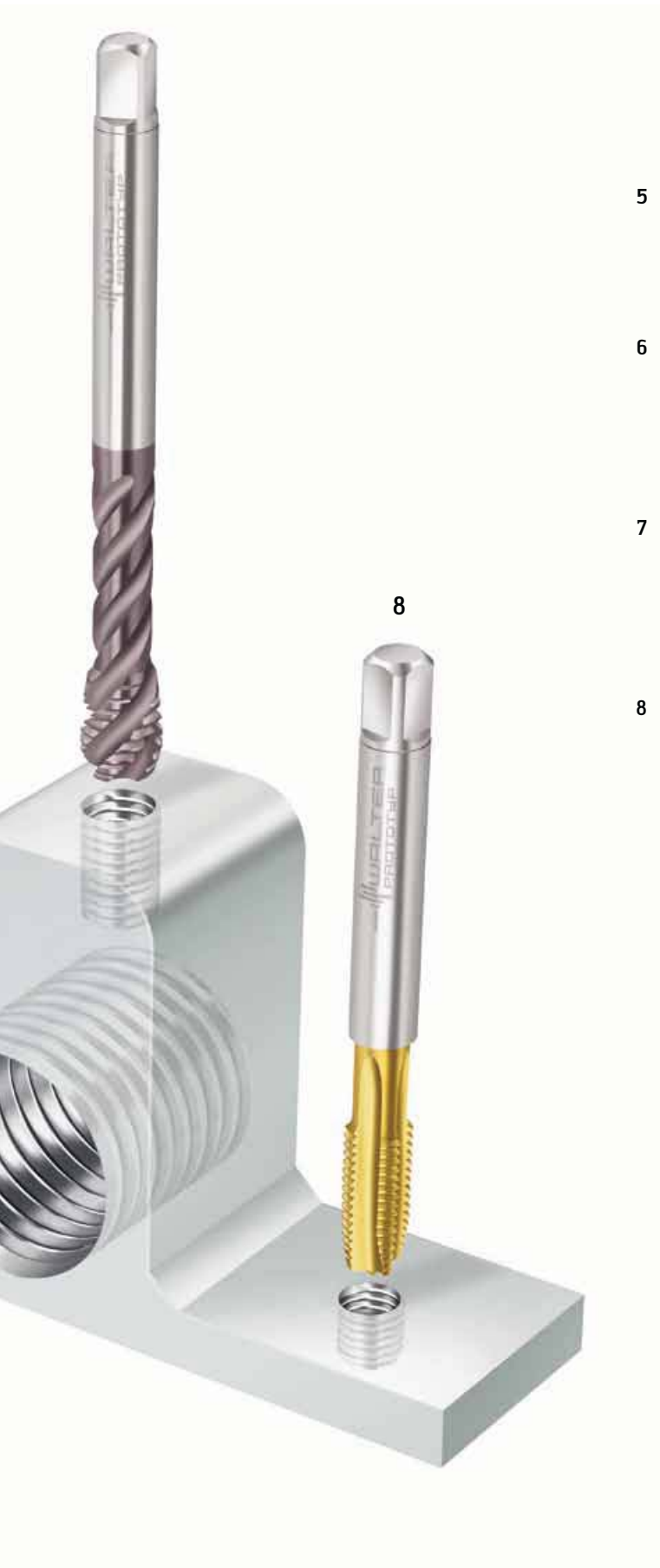



Product range overview of taps – threads in blind holes

Thread depth	1,5 x D _N										
Type	Paradur® N		Paradur® N		Paradur® N15		Paradur® Inox® 25		Paradur® NI / NI Insert		
Cutting tool material	Solid carbide		HSS-E		HSS-E		HSS-E		HSS-E-PM		
Coating	TiCN		uncoated/TiN/TiCN		uncoated		TiN		uncoated		
Application											
	Dimension	Page	Dimension	Page	Dimension	Page	Dimension	Page	Dimension	Page	
M	M3 – M12	D 126	M2 – M36	D 83	M2 – M30	D 297	M5 – M20	D 103	M2 – M20	D 117	
MJ											
MF			M4 x 0,5 – M36 x 1,5	D 156			M10 x 1 – M24 x 1,5	D 166			
UNC			1-64 UNC – 1-8 UNC	D 189					2-56 UNC – 3/4-10 UNC	D 196	
UNJC											
UNF			0-80 UNF – 1-12 UNF	D 215					6-40 UNF – 5/8-18 UNF	D 222	
UNJF											
UNEF											
UN-8											
G			G 1/8 – G 1	D 239			G1/4 – G3/4	D 243			
RC											
RP											
NPT			1/16-27 NPT – 1-11 1/2 NPT	D 252					1/16-27 NPT – 1-11 1/2 NPT	D 253	
NPSM											
NPTF			1/16-27 NPTF – 3/4-14 NPTF	D 257							
Pg											
BSW											
TR											
EG M									EG M4 – EG M8	D 270	
EG MF											
EG UNC											
EG UNF									EG UNF 10-32 – EG UNF 3/8-24	D 285	

Thread depth	2,5 x D _N								
Type	Paradur® Synchronspeed		Paradur® H 24		Paradur® STE		Paradur® Inox®		
Cutting tool material	HSS-E		HSS-E-PM		HSS-E		HSS-E		
Coating	vap/TiN/THL		uncoated		uncoated/THL		vap/TiCN/TiN/THL		
Application									
	Dimension	Page	Dimension	Page	Dimension	Page	Dimension	Page	
M	M2 – M24	D 104	M3 – M16	D 86	M4 – M24	D 98	M1,6 – M42	D 99	
MJ									
MF	M8 x 1 – M16 x 1,5	D 167			M8 x 1 – M18 x 1,5	D 163	M4 x 0,5 – M27 x 2	D 164	
UNC							2-56 UNC – 1 1/2-6 UNC	D 193	
UNJC									
UNF							6-40 UNF – 1-12 UNF	D 219	
UNJF									
UNEF									
UN-8							1-8 UN – 2-8 UN	D 229	
G	G1/8 – G1/2	D 247			G1/8 – G1/2	D 241	G 1/8-G 1	D 242	
RC									
RP									
NPT							1/16-27 NPT – 1-11 1/2 NPT	D 255	
NPSM									
NPTF							1/16-27 NPFT – 1/2-14 NPFT	D 258	
Pg									
BSW									
TR									
EG M									
EG MF									
EG UNC									
EG UNF									



1,5 x D _N			2 x D _N							
Paradur® NI 10			Paradur® HSC		Paradur® TI / TI Insert		Paradur® TI Plus		Paradur® Sprint	
HSS-E-PM			Solid carbide		HSS-E-PM		HSS-E-PM		HSS-E-PM	
uncoated/TiN			TiCN		uncoated/TiCN		ACN		TiN/TiCN	
										
Dimension	Page		Dimension	Page	Dimension	Page	Dimension	Page	Dimension	Page
M	M3 – M16	D 119	M6 – M12	D 125	M1 – M36	D 121	M2 – M20	D 123	M3 – M20	D 302
MJ	MJ3 – MJ16	D 120			MJ3 – MJ16	D 122				
MF	M8 x 1 – M12 x 1,5	D 172	M6 x 0,75 – M16 x 1,5	D 175	M8 x 0,75 – M16 x 1	D 173	M6 x 0,75 – M14 x 1,5	D 174	M8 x 1 – M20 x 1,5	D 313
UNC					6-32 UNC – 5/8-11 UNC	D 199				
UNJC	UNJC 4-40 – UNJC 3/8-16	D 198								
UNF					6-40 UNF – 5/8-18 UNF	D 224	10-32 UNJF – 3/8-24 UNJF	D 226		
UNJF	6-40 UNJF – 3/8-24 UNJF	D 223								
UNEF										
UN-8										
G										
RC										
RP										
NPT										
NPSM										
NPTF										
Pg										
BSW										
TR										
EG M					EG M4 – EG M8	D 271				
EG MF										
EG UNC					EG UNC 4-40 – EG UNC 8-32	D 277				
EG UNF					EG UNF 10-32 – EG UNF 3/8-24	D 286				





Paradur® VA		Paradur® Megasprint	
HSS-E		HSS-E-PM	
uncoated/vap/TiN		TiN	
			
Dimension	Page	Dimension	Page
M	M1,6 – M24	M6 – M20	D 304
MJ			
MF	M8x1 – M30x2		
UNC			
UNJC			
UNF			
UNJF			
UNEF			
UN-8			
G	G 1/8 – G 1		
RC			
RP			
NPT			
NPSM			
NPTF			
Pg			
BSW			
TR			
EG M			
EG MF			
EG UNC			
EG UNF			

Product range overview of taps – threads in blind holes

Thread depth	3,0 x D _N							
Type	Paradur® Eco HT		Paradur® WSH / WSH Insert		Paradur® Secur		Paradur® Uni	
Cutting tool material	HSS-E-PM		HSS-E		HSS-E-PM		HSS-E	
Coating	TiN/THL		uncoated/TiN		TiN		uncoated/vap/TiN/TiCN	
Application								
								
	Dimension	Page	Dimension	Page	Dimension	Page	Dimension	Page
M	M2 – M42	D 72	M1,6 – M36	D 87	M4 – M30	D 97	M2 – M36	D 298
MJ								
MF	M6 x 0,75 – M22 x 1,5	D 147	M2,5 x 0,35 – M36 x 2	D 158			M4 x 0,5 – M30 x 2	D 311
UNC	2-56 UNC – 3/4-10 UNC	D 187	2-56 UNC – 1 1/2-6 UNC	D 191				
UNJC								
UNF	4-48 UNF – 3/4-16 UNF	D 213	1-72 UNF – 1 1/2-12 UNF	D 217				
UNJF								
UNEF			1/4-32 UNEF – 1-20 UNEF	D 227				
UN-8			1 1/8-8 UN – 2 1/4-8 UN	D 228				
G	G 1/8 – G 1	D 237	G1/8 – G2	D 240			G 1/8 – G 1	D 317
RC								
RP								
NPT								
NPSM								
NPTF								
Pg								
BSW			1/8-40 BSW – 1-8 BSW	D 261				
TR								
EG M			EG M 2,5 – EG M 24	D 267				
EG MF			EG MF 8 x 1 – EG MF 16 x 1,5	D 272				
EG UNC			EG UNC 6-32 – EG UNC 1/4-20	D 274				
EG UNF			EG UNF 6-40 – EG UNF 1/2-20	D 282				

Thread depth	3,0 x D _N							
Type	Paradur® WLM Synchrospeed		KMB WST		Paradur® Inox® 50 Insert		Paradur® Engine	
Cutting tool material	HSS-E		HSS-E		HSS-E		Solid carbide	
Coating	uncoated/CRN		uncoated		vap		uncoated	
Application								
								
	Dimension	Page	Dimension	Page	Dimension	Page	Dimension	Page
M	M3 – M10	D 114	M3 – M12	D 63			M6 – M12	D 129
MJ								
MF							M10 x 1 – M16 x 1,5	D 177
UNC								
UNJC								
UNF								
UNJF								
UNEF								
UN-8								
G								
RC								
RP								
NPT								
NPSM								
NPTF								
Pg								
BSW								
TR								
EG M					EG M 2,5 – EG M 16	D 268		
EG MF								
EG UNC					EG UNC 4-40 – EG UNC 1/2-13	D 275		
EG UNF					EG UNF 10-32 – EG UNF 1/4-28	D 283		

3,0 x D _N									
Paradur® Sprint 50			Paradur® AL		Paradur® W40		Paradur® WLM + WLM Insert		
HSS-E-PM			HSS-E		HSS-E		HSS-E		
vap/TAFT			uncoated		uncoated		uncoated		
									
Dimension	Page	Dimension	Page	Dimension	Page	Dimension	Page	Dimension	Page
M	M2 – M20	D 303	M2 – M20	D 306	M3 – M20	D 300	M1,6 – M20	D 111	
MJ									
MF	M8 x 1 – M20 x 1,5	D 314					M8 x 0,75 – M22 x 1,5	D 171	
UNC							2-56 UNC – 3/8-16 UNC	D 195	
UNJC									
UNF									
UNJF									
UNEF									
UN-8									
G							G 1/8	D 246	
RC									
RP									
NPT									
NPSM									
NPTF									
Pg									
BSW									
TR									
EG M							EG M 2,5 – EG M 16	D 269	
EG MF									
EG UNC							EG UNC 6-32 – EG UNC 3/8-16	D 276	
EG UNF							EG UNF 10-32 – EG UNF 1/2-20	D 284	

3,5 x D _N										
Paradur® HT		Paradur® NH		Paradur® WTH		Paradur® Short Chip soft		Paradur® WTH Inox 50		
HSS-E		HSS-E		HSS-E		HSS-E		HSS-E		
uncoated/TiN		uncoated/TiN		uncoated/THL		vap/TiN		vap/TiN		
										
Dimension	Page	Dimension	Page	Dimension	Page	Dimension	Page	Dimension	Page	
M	M4 – M36	D 81	M4 – M12	D 85	M3 – M64	D 94	M5 – M20	D 97	M1,6 – M36	D 102
MJ										
MF	M12 x 1,5 – M33 x 2	D 155			M12 x 1,5 – M52 x 3	D 161	M8 x 1 – M16 x 1,5	D 162		
UNC										
UNJC										
UNF										
UNJF										
UNEF										
UN-8										
G								G1/8 – G1/4	D 244	
RC										
RP										
NPT										
NPSM										
NPTF										
Pg										
BSW										
TR										
EG M										
EG MF										
EG UNC										
EG UNF										

Product range overview of taps – threads in through holes





Thread depth	1,0 x D _N		1,5 x D _N				2 x D _N	
Type	Prototex® OS		Prototex® HSC		Paradur® Combi		Prototex® TiNi / TiNi Insert	
Cutting tool material	HSS-E		Solid carbide		HSS-E		HSS-E-PM	
Coating	uncoated		TiCN		uncoated		uncoated/TiCN	
Application								
	Dimension	Page	Dimension	Page	Dimension	Page	Dimension	Page
M	M1 – M10	D 40	M6 – M12	D 71	M3 – M12	D 59	M1 – M27	D 56
MJ								
MF			M6 x 0,75 – M16 x 1,5	D 146			M8 x 0,75 – M16 x 1	D 144
UNC							2-56 UNC – 3/4-10 UNC	D 185
UNJC								
UNF							4-48 UNF – 5/8-18 UNF	D 209
UNJF								
UNEF								
UN-8								
G								
RC								
RP								
NPT								
NPSM								
NPTF								
Pg								
BSW								
TR								
EG M							EG M4 – EG M8	D 266
EG MF								
EG UNC							EG UNC 4-40 – EG UNC 8-32	D 278
EG UNF							EG UNF 10-32 – EG UNF 3/8-24	D 281





Thread depth	3,0 x D _N							
Type	Prototex® Uni		Prototex® Sprint		Prototex® AL		Prototex® Megasprint	
Cutting tool material	HSS-E		HSS-E-PM		HSS-E		HSS-E-PM	
Coating	uncoated/TiN/TiCN		TiN/TiCN		uncoated		TiN	
Application								
	Dimension	Page	Dimension	Page	Dimension	Page	Dimension	Page
M	M2 – M42	D 290	M3 – M20	D 293	M2 – M10	D 295	M6 – M20	D 294
MJ								
MF	M3 x 0,35 – M50 x 1,5	D 307	M8 x 1 – M20 x 1,5	D 310				
UNC								
UNJC								
UNF								
UNJF								
UNEF								
UN-8								
G	G1 1/16 – G2	D 315						
RC								
RP								
NPT								
NPSM								
NPTF								
Pg								
BSW								
TR								
EG M								
EG MF								
EG UNC								
EG UNF								

2 x D _N					3,0 x D _N				
Prototex® TiNi Plus		TMB Trapez		Prototex® Synchrospeed		Prototex®		Prototex® H / H Insert	
HSS-E-PM		HSS-E		HSS-E		HSS-E		HSS-E	
ACN		uncoated		THL/TiN		uncoated/TiN		uncoated/TiN/TiCN	
Dimension	Page	Dimension	Page	Dimension	Page	Dimension	Page	Dimension	Page
M	M2 – M20	D 58		M2 – M24	D 55	M1 – M20	D 43	M2 – M56	D 47
MJ									
MF	M6 x 0,75 – M14 x 1,5	D 145		M8 x 1 – M16 x 1,5	D 143	M2 x 0,25 – M10 x 1	D 136	M4 x 0,5 – M50 x 1	D 137
UNC						1-64 UNC – 10-24 UNC	D 181	2-56 UNC – 1 1/2-6 UNC	D 183
UNJC									
UNF						0-80 UNF – 1/4-28 UNF	D 204	5/16-24 UNF – 1 1/2-12UNF	D 206
UNJF	10-32 UNJF – 3/8-24 UNJF	D 211							
UNEF								1/4-32 UNEF – 1-20 UNEF	D 212
UN-8									
G				G1/8 – G1/2	D 235			G1/8 – G2	D 233
RC									
RP									
NPT									
NPSM									
NPTF									
Pg									
BSW						BSW 1/8-40 – BSW 7/8-9	D 260		
TR			TR8 x 1,5 - TR30 x 6	D 262					
EG M								EG M2,5 – EG M16	D 264
EG MF									
EG UNC								EG UNC 6-32 – EG UNC 1/4-20	D 273
EG UNF								EG UNF 6-40 – EG UNF 1/2-20	D 279

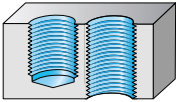
3,0 x D _N					3,5 x D _N			
Prototex InoX® / InoX® Insert		Prototex® VA		KMB H		Prototex® Eco HT		
HSS-E		HSS-E		HSS-E		HSS-E-PM		
vap/TiN/TiCN		uncoated/vap/TiN		uncoated		TiN/THL		
Dimension	Page	Dimension	Page	Dimension	Page	Dimension	Page	
M	M1 – M36	D 53	M1,6 – M24	D 292	M3 – M12	D 65	M2 – M24	D 36
MJ								
MF	M5 x 0,5 – M24 x 1,5	D 141	M8 x 1 – M24 x 2	D 309			M6 x 0,75 – M22 x 1,5	D 134
UNC	2-56 UNC – 1-8 UNC	D 184					2-56 UNC – 5/8-11 UNC	D 179
UNJC								
UNF	5-44 UNF – 1-12 UNF	D 207					4-48 UNF – 5/8-18 UNF	D 202
UNJF								
UNEF								
UN-8								
G	G1/8 – G1	D 234	G1/8 – G1	D 316			G1/8 – G1	D 232
RC								
RP								
NPT								
NPSM								
NPTF								
Pg					PG7 – PG21	D 259		
BSW								
TR								
EG M	EG M2,5 – EG M8	D 265						
EG MF								
EG UNC								
EG UNF	EG UNF 8-36 – EG UNF 1/4-28	D 280						

Product range overview of taps – threads in blind and through holes



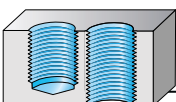



Thread depth	1,5 x D _N						2,0 x D _N			
Type	Paradur® H		Paradur® HC		Paradur Inox® 40		Paradur® Hard		Paradur® Hard Plus	
Cutting tool material	HSS-E		HSS-E		HSS-E		Solid carbide		Solid carbide	
Coating	uncoated/TiN		uncoated		uncoated		TiCN		TiCN	
Application										
	Dimension	Page	Dimension	Page	Dimension	Page	Dimension	Page	Dimension	Page
M	M1 – M42	D 78	M1 – M42	D 296			M3 – M16	D 132	M3 – M16	D 133
MJ										
MF	M2 x 0,25 – M52 x 3	D 150								
UNC										
UNJC										
UNF										
UNJF										
UNEF										
UN-8										
G	G1/8 – G2 1/2	D 238								
RC	RC1/8 – RC 1 1/2	D 249								
RP	RP1/8 – RP 1 1/2	D 250								
NPT	1/16-27 NPT – 2-11 1/2 NPT	D 251			1/8-27 NPT – 1/2-14 NPT	D 254				
NPSM										
NPTF	1/16-27 NPTF – 1-11 1/2 NPTF	D 256								

Thread depth	3,0 x D _N						3,5 x D _N			
Type	Paradur® Eco CI		KMB MS		Paradur® CI		Paradur® GG		Paradur® MS	
Cutting tool material	HSS-E-PM		HSS-E		HSS-E-PM		Solid carbide		HSS-E	
Coating	nid/TiCN		uncoated		nid/TAFT		uncoated/TAFT		uncoated	
Application										
	Dimension	Page	Dimension	Page	Dimension	Page	Dimension	Page	Dimension	Page
M	M3 – M30	D 106	M2 – M8	D 64	M3 – M30	D 305	M5 – M10	D 128	M2 – M10	D 115
MJ										
MF	M6 x 0,75 – M30 x 1,5	D 168					M8 x 1 – M12 x 1,5	D 176		
UNC	6-32 UNC – 7/8-9 UNC	D 194								
UNJC										
UNF	6-40 UNF – 7/8-14 UNF	D 221								
UNJF										
UNEF										
UN-8										
G	G1/8 – G 1 1/2	D 245	G1/8 – G 1 1/2	D 236						

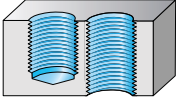
2,0 x D_N

	Paradur® Hard Scraper		Paradur® AP		Paradur® FT		HGB		HGB Inox		HGB TI	
	Solid carbide		HSS-E		HSS-E-PM		HSS		HSS-E		HSS-E	
	TiCN		nit		uncoated		uncoated		vap		nid	
												
	Dimension	Page	Dimension	Page	Dimension	Page	Dimension	Page	Dimension	Page	Dimension	Page
M			M3 – M20	D 116	M3 – M10	D 124	M2 – M30	D 60	M2 – M30	D 61	M3 – M12	D 62
MJ												
MF												
UNC												
UNJC												
UNF												
UNJF												
UNEF												
UN-8												
G	G1/8 – G1/4	D 248										
RC												
RP												
NPT												
NPSM												
NPTF												







Product range overview of thread formers – threads in blind and through holes

Thread depth	2,0 x D _N		3,0 x D _N						3,5 x D _N			
Type	Protodyn® Eco LM		Protodyn®		Protodyn® Plus		Protodyn® Eco Plus		Protodyn® C		Protodyn® S	
Cutting tool material	HSS-E		Solid carbide		HSS-E		HSS-E		HSS-E		Solid carbide	
Coating	CRN		TiCN		TiN		TiN/TiCN		uncoated/nid		TiCN	
Application	      											
	Dimension	Page	Dimension	Page	Dimension	Page	Dimension	Page	Dimension	Page	Dimension	Page
M	M2 – M12	D 339	M3 – M10	D 349	M1 – M24	D 342	M2 – M20	D 330	M1 – M10	D 319	M5 – M12	D 350
MJ												
MF			M8x1 – M16x1,5	D 358			M8 x 1 – M16 x 1,5	D 351				
UNC												
UNJC												
UNF												
UNJF												
UNEF												
UN-8												
G												







Product range overview of thread milling cutters – threads in blind and through holes

Thread depth	1,5 x D _N						2,0 x D _N			
Type	Thread milling cutter 27		Thread milling cutter Ni 27		Thread milling cutter 10		Thread milling cutter hard 10		Thread milling cutter 10°	
Cutting tool material	Solid carbide		Solid carbide		Solid carbide		Solid carbide		Solid carbide	
Coating	uncoated/TiCN		TiCN		uncoated/TiCN		TAX		uncoated/TiCN	
Shank	DIN 6535 HA		DIN 6535 HA		DIN 6535 HA/HB		DIN 6535 HA/HB		DIN 6535 HA/HB	
Application	     									
	Dimension	Page	Dimension	Page	Dimension	Page	Dimension	Page	Dimension	Page
M	M6 – M14	D 371					M6 – M16	D 370	M6 – M16	D 373
MJ			MJ4 – MJ12	D 372					M6 x 0,5 – M28 x 2	D 374
MF	M10x1 – M24x3	D 377					M12 x 1 – M14 x 1,5	D 370		
UNC									1/4UNC – 8UNC	D 382
UNJC										
UNF									10/32 – 3/4 UNF	D 383
UNJF			10-32 UNJF – 1/2 UNJF	D 381						
UNEF										
UN-8										
G										
RC										
RP										
NPT										
NPTF										

3,5 x D_N

	Protodyn® S		Protodyn® S Plus		Protodyn® S Eco Plus		Protodyn® SC		Protodyn® SF		Protodyn® S Eco Inox		Protodyn® S Synchrospeed	
	HSS-E		HSS-E		HSS-E		HSS-E		HSS-E		HSS-E		HSS-E	
	TiN		TiN		TiN/TiCN		uncoated/nid		TiCN		TiN		TiN/TiCN	
														
	Dimension	Page	Dimension	Page	Dimension	Page	Dimension	Page	Dimension	Page	Dimension	Page	Dimension	Page
M			M2 – M24	D 345	M2 – M20	D 333	M3 – M10	D 321	M3 – M16	D 323	M2 – M12	D 338	M3 – M12	D 340
MJ														
MF	M10 x 1 – M16 x 1,5	D 357	M4 x 0,5 – M24 x 1,5	D 356	M8 x 1 – M16 x 1,5	D 352			M8 x 1 – M16 x 1,5	D 324			M8 x 1 – M16 x 1,5	D 355
UNC			UNC 2-56 – UNC 5/8-11	D 359										
UNJC														
UNF			UNF 2-64 – UNF 5/8-18	D 360										
UNJF														
UNEF														
UN														
G			G 1/8 – G1	D 361					G 1/8 – G1/2	D 325				

3,0 x D_N

	Thread milling cutter TMC		Orbital thread mill TMO		Orbital thread mill TMO HRC		Thread milling cutter TMD		Orbital thread mill TMO		Thread milling cutter GFR	
	Solid carbide		Solid carbide		Solid carbide		Solid carbide		Solid carbide		Solid carbide	
	uncoated/TiCN		TiCN		TAX		TAX/NHC		uncoated/TiCN		TiCN	
	DIN 6535 HA/HB		DIN 6535 HA		DIN 6535 HA		DIN 6535 HA		DIN 6535 HA		DIN 1835 B	
												
	Dimension	Page	Dimension	Page	Dimension	Page	Dimension	Page	Dimension	Page	Dimension	Page
M	M3 – M16	D 378	M1,6 – M12	D 387	M2 – M6	D 386	M6 – M12	D 391	M1,6 – M8	D 388	P 2,5...5,0	D 393
MJ												
MF											P 1,0...5,0	D 393
UNC									1-64UNC – 5/16UNC	D 389		
UNJC												
UNF									2-54UNF – 5/16UNF	D 390		
UNJF												
UNEF												
UN												
G											G11 – G14	D 393
RC												
RP												
NPT												
NPTF												

Designation key for taps

Example

E	2	0	5	6	3	4	2
1	2	3	4	5	6	7	8

1
Tool range
blank DIN threading tools
A ANSI
D Thread formers
E Eco
I ISO dimensions
J JIS dimensions
S Synchrospeed

2
Tool type
0 Taper tap
1 Intermediate tap
2 Plug tap or machine tap
3 Set
4 Interrupted teeth (AZ)
8 Solid carbide

3
Thread type
0 Metric
1 Metric fine
2 UNC / UN
3 UNF / UNEF
4 G / Rp / Rc
5 NPT / NPSM
6 NPTF
7 PG
8 BSW / W
9 Tr

4
Design type
0 Hand tap
1 Short machine tap
2 Prototex®, spiral point
3 Paradur®, straight flutes (or Prototex® H)
4 Paradur®, low-helix
5 Paradur® high-helix flutes > 25°
6 Protodyn®
7 Machine nut tap, short shank
8 AMB / MMB / Trapezoidal, long shank
9 Stepped AMB/MMB, trapezoidal tap set

5
Tolerance, including shank
0 ISO1/4H, 4HX, 3B, 3BX reinforced shank
1 ISO2/6H, 6HX, 2B, 2BX reinforced shank
2 5G reinforced shank
3 ISO3/6G, 6GX reinforced shank
4 7G, 7GX reinforced shank
5 ISO1/4H, 4HX, 3B, 3BX passing through shank
6 ISO2/6H, 6HX, 2B, 2BX passing through shank
7 5G passing through shank
8 ISO3/6G, 6GX passing through shank
9 7G, 7GX passing through shank

6
Tap type
0 ST / N-C / H-A
1 N-A / H-C
2 W / NH / AP
3 Inox / Inox 25 / HT
4 Inox 50 / CU / grey cast iron
5 WTH Inox 50 / MS
6 WLM / TI / FT
7 WSH / Combi / PR
8 NI / Hard
9 WTH / LG / Hard Plus

7
Modification
0 no modifications
1 Internal cooling lubrication supply, axial exit
2 Different thread type
3 Extended shank
4 Internal cooling lubrication supply, radial exit
5 Combination of various points
6 Different number of flutes
7 Reduced/different helix
8 Left-hand thread
9 Insert

8
Surface treatment
0 without
2 THL
4 CRN
5 TiN
6 TiCN
7 TAF

Designation key for solid carbide thread milling cutters

Example

H	5	0	4	5	0	1	6
1	2	3	4	5	6	7	8

1
Tool range
H Solid carbide thread milling cutters

2
Tool type
5 Thread milling cutter 9 Toolholder/accessories

3
Thread type
0 Metric 1 Metric fine 2 UNC / UN 3 UNF / UNEF 4 G / Rp / Rc 5 NPT / NPSM 6 NPTF 7 PG 8 BSW / W 9 Tr

4
Tool version
3 Shank thread milling cutter, thin version, short dimensions 4 Shank thread milling cutter, short version 5 Shank thread milling cutter 6 Shank 7 Thread milling cutter

5
Tool version
0 Bolt thread milling cutter, right handed 1 Nut thread milling cutter, RH-cutting 10° helix 2 Nut and bolt thread milling cutter, RH-cutting 3 Nut thread milling cutter, RH-cutting, for hardened steel 4 Nut thread milling cutter, right handed, without countersink, slim version 5 Nut thread milling cutter, RH-cutting, 27° helix 6 Nut thread milling cutter, RH-cutting, 27° helix, rounded profile

6
Shank/bore version
0 Cylindrical shank DIN 1835 A 1 Cylindrical shank DIN 1835 B

7
Coolant supply
0 Without internal cooling 1 With internal cooling

8
Coating
2 NHC-coated 6 TiCN-coated 8 TAX-coated

Product families

Taps	
Eco	Product range for particularly cost-effective wet or dry machining (MQCL)
Synchrospeed	Product range for rigid thread machining without floating chuck
N	For normal materials
W	For soft materials
WSH	For deep threads in soft materials
WTH	For particularly deep threads in soft materials
ST / STE	For steel materials
H	For super-high-strength materials
Inox	For stainless and high-alloyed steels
TI	For titanium alloys and similar materials
NI	For nickel alloys and similar materials
TiNi	For titanium alloys and nickel alloys
CU	For copper, copper alloys and similar materials
LG	For aluminium alloys and magnesium alloys
Insert	For thread inserts
WLM	For soft, long-chipping materials
CI	For grey cast iron
MS	For short-chipping copper-zinc alloys
AP	For Ampco materials
FT	For titanium carbide hard materials
PR	For extruded materials, duroplastics
HT	For high-strength steels and short-chipping materials
NH	For super-high-strength steels
HS	For abrasive, short-chipping materials
NI / Hard	For hard machining up to 63 HRC
LM	For machining light alloy
N15	For easy applications in long- and short-chipping materials
W40	For blind hole threads in softer steel materials
Constant	Without lubrication grooves
HC	For easy applications in long- and short-chipping materials
VA	For stainless and super-high-alloyed materials

Product families

Taps	
AL	For long-chipping aluminium alloys
Sprint	For use in a broad material spectrum (higher-performance cutting data)
Megasprint	As "Sprint" but with internal cooling
Sprint 50	For deeper blind hole threads in a broad material spectrum
Secur	Problem-solver for bird nesting and swarf packing in soft, long-chipping materials thanks to special geometry
HSC	"High Speed Cutting", for high cutting speeds
Engine	For short-chipping cast iron workpieces in the automotive industry
Short Chip	For short chips in soft, long-chipping materials
C	Thread former without lubrication grooves
SC	Thread former with lubrication grooves
SF	Thread former with lubrication grooves, for higher performance

Thread milling cutter	
TMD	Thread Milling and Drilling
TMC	Thread milling cutter with countersink
TMO	Thread Milling Orbital
TMO HRC	Orbital for hard machining up to 65 HRC
10	Thread milling cutter with 10° helix angle
27	Thread milling cutter with 27° helix angle
Ni 27	Thread milling cutter for nickel alloys and 27° helix angle

Walter Select for threading applications

Step by step to the correct tool

STEP 1

Define the **material** to be machined, see page H 8 onwards.

Note down the machining group that corresponds to your material, e.g.: P10.

Code letter	Machining group	Groups of the materials to be machined	
P	P1–P15	Steel	All types of steel and cast steel, with the exception of steel with an austenitic structure
M	M1–M3	Stainless steel	Stainless austenitic steel and austenitic-ferritic steel and cast steel
K	K1–K7	Cast iron	Grey cast iron, cast iron with spheroidal graphite, malleable cast iron, cast iron with vermicular graphite
N	N1–N10	NF metals	Aluminium and other non-ferrous metals, non-ferrous materials
S	S1–S10	High temperature alloys and titanium alloys	Heat resisting special alloys based on iron, nickel and cobalt, titanium and titanium alloys
H	H1–H4	Hard materials	Hardened steel, hardened cast iron materials, chilled cast iron
O	O1–O6	Other	Plastics, glass and carbon fibre reinforced plastics, graphite

STEP 2

Select your **intended application**.

Thread cutting Solid carbide / HSS										
	Blind hole					Through hole				
depth	1,5 × D _N	2,0 × D _N	2,5 × D _N	3,0 × D _N	3,5 × D _N	1,5 × D _N	2,0 × D _N	2,5 × D _N	3,0 × D _N	3,5 × D _N
Solid carbide / page	D 20	D 21	D 21	D 21	D 21	D 20	D 21	D 21	D 21	D 21
HSS / page	D 22	D 23	D 25	D 25	D 27	D 28	D 29	D 30	D 30	D 31

Thread forming			
	Blind hole		Through hole
depth	2,0 × D _N		> 3,5 × D _N
Page	D 328		D 329

Thread milling				
	Internal Blind hole / through hole			External
depth	1,5 × D _N	2,0 × D _N	3,0 × D _N	< 2,0 × D _N
Page	D 368	D 369	D 369	D 369

STEP 3

Select the tool that matches the following criteria:

- Material group
- Thread type
- Thread depth

Walter Select – tapping
Blind and through hole machining
Solid carbide

WALTER SELECT
 Primary application
 Additional application

Type	1.5 x D _N	
	Paradur® N	Prototex® HSC
M	D 126	D 71
MJ		
MF		D 146
UNC	UNJC	
UNF	UNJF	
UNEF	UN-B	
G		
RC	RP	
NPT	NPSM	
NPTF		
Pg	BSW	
TR		
EG M	EG MF	
EG UNC		
EG UNF		
Coating	uncoated/TiCN	TiCN
Application	BH	TH

BH = Blind hole
TH = Through hole

Material group	Workpiece material	Brinell hardness HB	Tensile strength R _m N/mm²	Machining group	Image	
					Uncoated	TiCN
P	Unalloyed and low-alloyed steel	annealed (tempered)	210	700	P1, P2, P3, P4, P7	
		Free cutting steel	220	750	P6	
		tempered	300	1010	P5, P8	••
		tempered	380	1280	P9	•••
		tempered	430	1480	P10	•••
P	High-alloyed steel and high-alloyed tool steel	annealed	200	670	P11	
		hardened and tempered	300	1010	P12	••
		hardened and tempered	400	1360	P13	•••
		tempered	430	1480	P10	•••
M	Stainless steel	ferritic / martensitic, annealed	200	670	P14	
		martensitic, tempered	330	1110	P15	
M	Stainless steel	austenitic, duplex	230	780	M1, M3	
		austenitic, precipitation hardened (PH)	300	1010	M2	
K	Grey cast iron	Cast iron	245			

STEP 4

Following tool selection, reference is given to the relevant page in the catalogue.

On the bottom right of the catalogue page, you will find a reference to the cutting data table.

Thread tapping

Machine tap Prototex® H

≤3xD_N

- HSS-E
- chamfer form B = 3.5 - 5 thread
- materials from 200 to 1000 N/mm² or 32 HRC
- for long-chipping materials

	P	M	K	N	S	H	O
uncoated	••	••	••	••	••	••	••
TiN	••	••	••	••	••	••	••

MF
DIN 13

DIN 374	ISO2/6H	D _N	P mm	l ₁ js16 mm	L _c mm	d ₁ h9 mm	□ h12 mm	l ₂ mm	N	uncoated designation 21360	TiN designation 2136005
M 4		0,5	63	12	2,8	2,1	5	3	3	-M4X0,5	-M5X0,5
M 5		0,5	70	13	3,5	2,7	6	3	3	-M5X0,5	-M6X0,5
M 6		0,5	80	15	4,5	3,4	6	3	3	-M6X0,5	-M6X0,5
M 6		0,75	80	15	4,5	3,4	6	3	3	-M6X0,75	-M6X0,75
M 8		0,5	80	15	6	4,9	8	3	3	-M8X0,5	-M8X0,5
M 8		0,75	80	15	6	4,9	8	3	3	-M8X0,75	-M8X0,75

STEP 5

Select the cutting data for the tool type, see page D 396 onwards.

Cutting data for tapping, thread forming, and thread milling

Material group	Classification of the main material groups and code letters	Brinell hardness HB	Tensile strength R _m N/mm²	Machining group	Tapping					
					v _c [m/min]	v _c [m/min]	v _c [m/min]			
P	Unalloyed steel	C ≤ 0.25 %	annealed	125	428	P1	15	30	E	
		C > 0.25 ... ≤ 0.55 %	annealed	190	639	P2	15	30	E	
		C > 0.25 ... ≤ 0.55 %	tempered	210	708	P3	12,5	25	E	
		C > 0.55 %	annealed	190	639	P4	15	30	E	
		C > 0.55 %	tempered	300	1013	P5	45	15	E	
	Low-alloyed steel	machining steel (short-chipping)	annealed	220	745	P6	15	30	E	
			annealed	175	591	P7	15	30	E	
			tempered	300	1013	P8	50	7,5	15	E
			tempered	380	1282	P9	35	4	7,5	E
			tempered	430	1477	P10	20	2	4	O
High-alloyed steel and high-alloyed tool steel		annealed	200	675	P11	15	30	E		
		hardened and tempered	300	1013	P12	50	7,5	15	E	
		hardened and tempered	400	1361	P13	30	3	6	O	
		tempered	430	1477	P10	20	2	4	O	
Stainless steel	ferritic / martensitic, annealed	200	675	P14	5	10	10	E		
	martensitic, tempered	330	1114	P15	2	4	4	E		
M	Stainless steel	austenitic, quench hardened	200	675	M1	5	10	10	E	
		austenitic, precipitation hardened (PH)	300	1013	M2	3	6	6	E	
	Stainless steel	austenitic, duplex	230	778	M3	3	6	8	E	

Walter Select – tapping



Blind and through hole machining

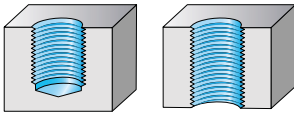





Solid carbide



BH = Blind hole
TH = Through hole

Thread depth	1,5 x D _N	
	Paradur® N	Prototex® HSC
Type	Page	Page
M	D 126	D 71
MJ		
MF		D 146
UNC	UNJC	
UNF	UNJF	
UNEF	UN-8	
G		
RC	RP	
NPT	NPSM	
NPTF		
Pg	BSW	
TR		
EG M	EG MF	
EG UNC		
EG UNF		
Coating	uncoated/TICN	TICN
Application	BH	TH

Material group	Classification of the main material groups and code letters		Brinell hardness HB	Tensile strength R _m N/mm ²	Machining group		
	Workpiece material						
P	Unalloyed and low-alloyed steel	annealed (tempered)	210	700	P1, P2, P3, P4, P7		
		Free cutting steel	220	750	P6		
		tempered	300	1010	P5, P8	•	
		tempered	380	1280	P9	••	
	High-alloyed steel and high-alloyed tool steel	tempered	430	1480	P10	•	
		annealed	200	670	P11		
hardened and tempered		300	1010	P12	••		
Stainless steel	hardened and tempered	400	1360	P13	•		
	ferritic / martensitic, annealed	200	670	P14			
	martensitic, tempered	330	1110	P15			
M	Stainless steel	austenitic, duplex	230	780	M1, M3		
		austenitic, precipitation hardened (PH)	300	1010	M2		
K	Grey cast iron		245	–	K3, K4	•	•
	Cast iron with spheroidal graphite GGV (CGI)	ferritic, pearlitic	365	–	K1, K2, K5, K6	••	••
			200	–	K7	•	•
N	Aluminium wrought alloys	cannot be hardened	30	–	N1		
		hardenable, hardened	100	340	N2		
	Cast aluminium alloys	≤ 12 % Si	90	310	N3, N4	••	
		> 12 % Si	130	450	N5	•	
	Magnesium alloys		70	250	N6	••	
	Copper and copper alloys (bronze/brass)	unalloyed, electrolytic copper		100	340	N7	
Brass, bronze, red brass			90	310	N8		
Cu-alloys, short-chipping			110	380	N9		
high-strength, Ampco			300	1010	N10		
S	Heat-resistant alloys	Fe-based	280	940	S1, S2		
		Ni-based or Co-based	250	840	S3		
		Ni-based or Co-based	350	1080	S4, S5		
	Titanium alloys	Pure titanium	200	670	S6		
		α and β alloys, hardened	375	1260	S7		
		β alloys	410	1400	S8		
	Tungsten alloys		300	1010	S9		
Molybdenum alloys		300	1010	S10			
H	Hardened steel		50 HRC	–	H1		
			55 HRC	–	H2, H4		
			60 HRC	–	H3		
O	Thermoplasts	without abrasive fillers			O1		
	Thermosetting plastics	without abrasive fillers			O2	•	
	Fibre-reinforced plastic	GFRP, AFRP			O3, O5	•	
		CFRP			O4	•	
Graphite (technical)			65	O6			

	2,0 x D _N				3,0 x D _N		3,5 x D _N
	Paradur® HSC	Paradur® Hard	Paradur® Hard Plus	Paradur® Hard Scraper	Paradur® Engine	Paradur® HS	Paradur® G6
	Page	Page	Page	Page	Page	Page	Page
	D 125	D 132	D 133		D 129	D 130	D 128
	D 175				D 177	D 178 D 201 D 231	D 176
				D 248			
	TiCN BH	TiCN BH+TH	TiCN BH+TH	TiCN BH+TH	uncoated BH	uncoated/TiCN BH+TH	uncoated/TAFT BH+TH
							
	••						
	••						
	••						
	••						
	••						
	•				••	•	••
	••				••	•	••
	•				••	•	••
	•				••	•	•
	••				••	••	•
	•				•	••	•
						•	
						••	
						•	
		•	•	•		•	
		•	•	•		•	
		•	•	•			
		•	•	•			
	••					•	
	••	••	••	••			
		••	••	••			
						••	
						••	
						••	
							••

Walter Select – tapping

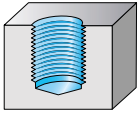

Blind hole machining

HSS-E (-PM)



BH = Blind hole
TH = Through hole

Thread depth		1,5 x D _N	
Type		Paradur® H	Paradur® N
		Page	Page
M		D 78	D 83
MJ			
MF		D 150	D 156
UNC	UNJC		D 189
UNF	UNJF		D 215
UNEF	UN-8		
G		D 238	D 239
RC	RP	D 249 / D 250	
NPT	NPSM	D 251	D 252
NPTF		D 256	D 257
Pg	BSW		
TR			
EG M	EG MF		
EG UNC			
EG UNF			
Coating		uncoated/ TiN	uncoated/ TiN/TiCN
Application		BH/TH	BH

Material group	Classification of the main material groups and code letters		Birnell hardness HB	Tensile strength R _m N/mm ²	Machining group			
	Workpiece material							
P	Unalloyed and low-alloyed steel	annealed (tempered)	210	700	P1, P2, P3, P4, P7		●●	
		Free cutting steel	220	750	P6		●●	
		tempered	300	1010	P5, P8			
		tempered	380	1280	P9			
		tempered	430	1480	P10			
	High-alloyed steel and high-alloyed tool steel	annealed	200	670	P11			
		hardened and tempered	300	1010	P12			
		hardened and tempered	400	1360	P13			
	Stainless steel	ferritic / martensitic, annealed	200	670	P14			
		martensitic, tempered	330	1110	P15			
M	Stainless steel	austenitic, duplex	230	780	M1, M3			
		austenitic, precipitation hardened (PH)	300	1010	M2			
	Grey cast iron		245	–	K3, K4			
K	Cast iron with spheroidal graphite	ferritic, pearlitic	365	–	K1, K2, K5, K6	●	●●	
	GGV (CGI)		200	–	K7			
N	Aluminium wrought alloys	cannot be hardened	30	–	N1		●●	
		hardenable, hardened	100	340	N2	●	●●	
	Cast aluminium alloys	≤ 12 % Si	90	310	N3, N4	●	●●	
		> 12 % Si	130	450	N5	●	●	
	Magnesium alloys		70	250	N6	●	●●	
	Copper and copper alloys (bronze / brass)	unalloyed, electrolytic copper	100	340	N7			
		Brass, bronze, red brass	90	310	N8	●	●	
Cu-alloys, short-chipping		110	380	N9	●	●		
	high-strength, Ampco	300	1010	N10				
S	Heat-resistant alloys	Fe-based	280	940	S1, S2			
		Ni-based or Co-based	250	840	S3			
		Ni-based or Co-based	350	1080	S4, S5			
	Titanium alloys	Pure titanium	200	670	S6			
		α and β alloys, hardened	375	1260	S7			
	β alloys	410	1400	S8				
	Tungsten alloys		300	1010	S9			
	Molybdenum alloys		300	1010	S10			
H	Hardened steel		50 HRC	–	H1			
			55 HRC	–	H2, H4			
			60 HRC	–	H3			
O	Thermoplasts	without abrasive fillers			O1			
	Thermosetting plastics	without abrasive fillers			O2	●		
	Fibre-reinforced plastic	GFRP, AFRP			O3, O5	●		
		CFRP			O4	●		
	Graphite (technical)			65	O6	●		

	1,5 x D _N				2,0 x D _N				
	Paradur Inox® 25	Paradur Inox® 40	Paradur® Ni	Paradur® Ni 10	Paradur® AP	Paradur® Ti	Paradur® Ti plus	Paradur® FT	HGB
	Page	Page	Page	Page	Page	Page	Page	Page	Page
	D 103		D 117	D 119	D 116	D 121	D 123	D 124	D 60
	D 166			D 120		D 122			
				D 172		D 173	D 174		
			D 196	D 198		D 199			
			D 222	D 223		D 224	D 226		
	D 243								
		D 254	D 253						
			D 270						
			D 285						
	TiN	uncoated	uncoated	uncoated/ TiN	nit	uncoated/ TiCN	ACN	uncoated	uncoated
	BH	BH/TH	BH	BH	BH/TH	BH	BH	BH/TH	BH/TH
		•							•
	••	•••		•		••			•
		•		••		•			
	••	••	•	••		••			
	••	••				••			
	••	••							
	••	••							
		•							•
									•
									•
									•
									•
									•
									•
					••				•
			••	•		•		•	
			•	••		•	••		
						••	••		
			•	••		•		•	
			•			•		•	
								•	
								•	
								•	

Walter Select – Tapping

Blind hole machining

HSS-E (-PM)

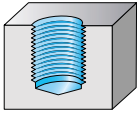

BH = Blind hole
TH = Through hole

i = only for synchronous machining

Thread depth	2,0 x D _N	
Type	H6B Inox	H6B Ti
	Page	Page
M	D 61	D 62
MJ		
MF		
UNC	UNJC	
UNF	UNJF	
UNEF	UN-8	
G		
RC	RP	
NPT	NPSM	
NPTF		
Pg	BSW	
TR		
EG M	EG MF	
EG UNC		
EG UNF		
Coating	vap	nid
Application	BH/TH	BH/TH

Material group	Classification of the main material groups and code letters		Brinell hardness HB	Tensile strength R _m N/mm ²	Machining group	
	Workpiece material					
P	Unalloyed and low-alloyed steel	annealed (tempered)	210	700	P1, P2, P3, P4, P7	
		Free cutting steel	220	750	P6	
		tempered	300	1010	P5, P8	
		tempered	380	1280	P9	
		tempered	430	1480	P10	
	High-alloyed steel and high-alloyed tool steel	annealed	200	670	P11	
hardened and tempered		300	1010	P12		
hardened and tempered		400	1360	P13		
Stainless steel	ferritic / martensitic, annealed	200	670	P14	●	
	martensitic, tempered	330	1110	P15	●	
M	Stainless steel	austenitic, duplex	230	780	M1, M3	●
		austenitic, precipitation hardened (PH)	300	1010	M2	●
K	Grey cast iron		245	–	K3, K4	
	Cast iron with spheroidal graphite	ferritic, pearlitic	365	–	K1, K2, K5, K6	
	GGV (CGI)		200	–	K7	
N	Aluminium wrought alloys	cannot be hardened	30	–	N1	
		hardenable, hardened	100	340	N2	
	Cast aluminium alloys	≤ 12 % Si	90	310	N3, N4	
		> 12 % Si	130	450	N5	
	Magnesium alloys		70	250	N6	
		Copper and copper alloys (bronze / brass)	unalloyed, electrolytic copper	100	340	N7
S	Heat-resistant alloys	Brass, bronze, red brass	90	310	N8	
		Cu-alloys, short-chipping	110	380	N9	
		high-strength, Ampco	300	1010	N10	
	Titanium alloys	Fe-based	280	940	S1, S2	
		Ni-based or Co-based	250	840	S3	●
		Ni-based or Co-based	350	1080	S4, S5	●
		Pure titanium	200	670	S6	
		α and β alloys, hardened	375	1260	S7	●
	Tungsten alloys	β alloys	410	1400	S8	●
		Molybdenum alloys	300	1010	S9	
H	Hardened steel		50 HRC	–	H1	
			55 HRC	–	H2, H4	
			60 HRC	–	H3	
O	Thermoplasts	without abrasive fillers			O1	
	Thermosetting plastics	without abrasive fillers			O2	
	Fibre-reinforced plastic	GFRP, AFRP			O3, O5	
		CFRP			O4	
Graphite (technical)			65		O6	

	2,5 x D _N				3,0 x D _N			
	Paradur® H 24	Paradur® STE	Paradur® Inox	Paradur® Synchrospeed	Paradur® Eco HT	Paradur® WSH	Paradur® Secur	Paradur® Eco CI
Page	Page	Page	Page	Page	Page	Page	Page	Page
D 86	D 98	D 99	D 104	D 72	D 87	D 97	D 106	
	D 163	D 164	D 167	D 147	D 158		D 168	
		D 193		D 187	D 191		D 194	
		D 219		D 213	D 217		D 221	
		D 229			D 227			
	D 241	D 242	D 247	D 237	D 240		D 245	
		D 255				D 261		
		D 258						
						D 267 / D 272		
						D 274		
						D 282		
uncoated	uncoated/THL	vap/TiCN/TiN/THL	vap/THL/TiN	TiN/THL	uncoated/TiN	TiN	nid /TiCN	
BH	BH	BH	BH	BH	BH	BH	BH/TH	
	•	•	••	••	••	•	••	
	••	••	•••	•••	•••	••	••	
•	•	••	••	••				
			•	••				
•	•	••	••	••				
	•	••	••	••				
	•	••	••	••				
	•	••	••	••			••	
			•	•			•	
			••	••	•		••	
			••	••	•	••		
			•	•			••	
			•	•			••	
			•	•				
			•	•				
			•	•				
			•	•				
			•	•				
			•	•				
			•	•				
			•	•				
			•	•				
			•	•			•	
			•	•			••	
			•	•			•	
			•	•			••	

Walter Select – Tapping

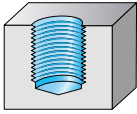

Blind hole machining

HSS-E (-PM)



BH = Blind hole
TH = Through hole

Thread depth		3,0 x D _N	
Type		Paradur® WLM	Paradur® WLM Synchronspeed
		Page	Page
M		D 111	D 114
MJ			
MF		D 171	
UNC	UNJC	D 195	
UNF	UNJF		
UNEF	UN-8		
G		D 246	
RC	RP		
NPT	NPSM		
NPTF			
Pg	BSW		
TR			
EG M	EG MF	D 269	
EG UNC		D 276	
EG UNF		D 284	
Coating		uncoated	uncoated/CRN
Application		BH	BH

Material group	Classification of the main material groups and code letters		Brinell hardness HB	Tensile strength R _m N/mm ²	Machining group		
	Workpiece material						
P	Unalloyed and low-alloyed steel	annealed (tempered)	210	700	P1, P2, P3, P4, P7		●
		Free cutting steel	220	750	P6		●
		tempered	300	1010	P5, P8		
		tempered	380	1280	P9		
		tempered	430	1480	P10		
	High-alloyed steel and high-alloyed tool steel	annealed	200	670	P11		
hardened and tempered		300	1010	P12			
hardened and tempered		400	1360	P13			
Stainless steel	ferritic / martensitic, annealed	200	670	P14			
	martensitic, tempered	330	1110	P15			
M	Stainless steel	austenitic, duplex	230	780	M1, M3		
		austenitic, precipitation hardened (PH)	300	1010	M2		
K	Grey cast iron		245	–	K3, K4		
	Cast iron with spheroidal graphite	ferritic, pearlitic	365	–	K1, K2, K5, K6		
	GGV (CGI)		200	–	K7		
N	Aluminium wrought alloys	cannot be hardened	30	–	N1	●●	●●
		hardenable, hardened	100	340	N2	●●	●●
	Cast aluminium alloys	≤ 12 % Si	90	310	N3, N4	●●	●
		> 12 % Si	130	450	N5		
	Magnesium alloys		70	250	N6		●
		Copper and copper alloys (bronze / brass)	unalloyed, electrolytic copper	100	340	N7	●●
Brass, bronze, red brass	90		310	N8		●	
Cu-alloys, short-chipping	110		380	N9			
high-strength, Ampco	300		1010	N10			
S	Heat-resistant alloys	Fe-based	280	940	S1, S2		
		Ni-based or Co-based	250	840	S3		
		Ni-based or Co-based	350	1080	S4, S5		
	Titanium alloys	Pure titanium	200	670	S6	●●	●●
		α and β alloys, hardened	375	1260	S7		
		β alloys	410	1400	S8		
	Tungsten alloys		300	1010	S9		
Molybdenum alloys		300	1010	S10			
H	Hardened steel		50 HRC	–	H1		
			55 HRC	–	H2, H4		
			60 HRC	–	H3		
O	Thermoplasts	without abrasive fillers			O1	●●	●●
	Thermosetting plastics	without abrasive fillers			O2		
	Fibre-reinforced plastic	GFRP, AFRP			O3, O5		
		CFRP			O4		
Graphite (technical)			65	O6			

3,0 x D _N		3,5 x D _N						
KMB WST	KMB MS	Paradur® HT	Paradur® NH	Paradur® WTH	Paradur® Short Chip Soft	Paradur® WTH Inox 50	Paradur® MS	
Page D 63	Page D 64	Page D 81	Page D 85	Page D 94	Page D 97	Page D 102	Page D 115	
		D 155		D 161	D 162			
	D 236					D 244		
uncoated BH	uncoated BH/TH	uncoated/TiN BH	uncoated/TiN BH	uncoated/THL BH	vap/TiN BH	vap/TiN BH	uncoated BH/TH	
••		•	•	•	••	••		
••		••	••	••	••	•		
		••	••			••		
••		•				•		
		••				••		
		••				•		
						••		
						•		
						••		
		•				•		
•		••	••	•	••			
•		•		•				
•		•		•				
•		•		•				
		•		•				
		•		•				
	••	•	•				•	
		•	•				••	
	•	•	•				•	
		••	••				••	
		•	•				•	

Walter Select – Tapping Through hole machining HSS-E (-PM)

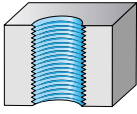

BH = Blind hole
TH = Through hole

Thread depth	1,0 x D _N	1,5 x D _N	
Type	Prototex® 0S	Paradur® H	
	Page	Page	
M	D 40	D 78	
MJ			
MF		D 150	
UNC	UNJC		
UNF	UNJF		
UNEF	UN-8		
G		D 238	
RC	RP	D 249 / D 250	
NPT	NPSM	D 251	
NPTF		D 256	
Pg	BSW		
TR			
EG M	EG MF		
EG UNC			
EG UNF			
Coating	uncoated	uncoated/TiN	
Application	TH	BH/TH	

Material group	Classification of the main material groups and code letters		Bridell hardness HB	Tensile strength R _m N/mm ²	Machining group				
	Workpiece material								
P	Unalloyed and low-alloyed steel	annealed (tempered)	210	700	P1, P2, P3, P4, P7	••			
		Free cutting steel	220	750	P6	••			
		tempered	300	1010	P5, P8				
		tempered	380	1280	P9				
		tempered	430	1480	P10				
	High-alloyed steel and high-alloyed tool steel	annealed	200	670	P11				
		hardened and tempered	300	1010	P12				
hardened and tempered		400	1360	P13					
Stainless steel	ferritic / martensitic, annealed	200	670	P14					
	martensitic, tempered	330	1110	P15					
M	Stainless steel	austenitic, duplex	230	780	M1, M3				
		austenitic, precipitation hardened (PH)	300	1010	M2				
K	Grey cast iron		245	–	K3, K4				
	Cast iron with spheroidal graphite	ferritic, pearlitic	365	–	K1, K2, K5, K6		•		
	GGV (CGI)		200	–	K7				
N	Aluminium wrought alloys	cannot be hardened	30	–	N1	•			
		hardenable, hardened	100	340	N2	•	•		
	Cast aluminium alloys	≤ 12 % Si	90	310	N3, N4		•		
		> 12 % Si	130	450	N5		•		
	Magnesium alloys		70	250	N6		•		
		Copper and copper alloys (bronze / brass)	unalloyed, electrolytic copper	100	340	N7			
			Brass, bronze, red brass	90	310	N8		•	
Cu-alloys, short-chipping	110		380	N9		•			
high-strength, Ampco	300		1010	N10					
S	Heat-resistant alloys	Fe-based	280	940	S1, S2				
		Ni-based or Co-based	250	840	S3				
		Ni-based or Co-based	350	1080	S4, S5				
	Titanium alloys	Pure titanium	200	670	S6				
		α and β alloys, hardened	375	1260	S7				
		β alloys	410	1400	S8				
	Tungsten alloys		300	1010	S9				
	Molybdenum alloys		300	1010	S10				
	H	Hardened steel		50 HRC	–	H1			
				55 HRC	–	H2, H4			
			60 HRC	–	H3				
O	Thermoplasts	without abrasive fillers			O1				
	Thermosetting plastics	without abrasive fillers			O2		•		
	Fibre-reinforced plastic	GFRP, AFRP			O3, O5		•		
		CFRP			O4		•		
Graphite (technical)			65		O6		•		



	1,5 x D _N		2,0 x D _N				
	Paradur Inox® 40	Paradur® Combi	Prototex® TiNi	Prototex® TiNi plus	TMB Trapez	Paradur® FT	Paradur® AP
	Page	Page	Page	Page	Page	Page	Page
		D 59	D 56	D 58		D 124	D 116
			D 144	D 145			
			D 185				
			D 209	D 211			
	D 254						
					D 262		
			D 266				
			D 278				
			D 281				
	uncoated BH/TH	uncoated TH	uncoated/TiCN TH	ACN TH	uncoated TH	uncoated BH/TH	nit BH/TH
	•	••			•		
	••	••			••		
	•		••				
			••				
	•	•			•		
	••		••		••		
	•						
	••						
	••		••				
					••		
	•	•			•		
		•	•		••		
	•		•		••		
		•					
		••			••		
			••	••			
			••	••			
			•			•	
			•			•	
							••
			••			•	
			••	••		•	
			••	••			
			•			•	
			•				
						•	
						•	
						•	

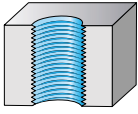



Walter Select – Tapping Through hole machining HSS-E (-PM)



BH = Blind hole
TH = Through hole

Thread depth		3,0 x D _N	
Type		Prototex®	Prototex® H
		Page	Page
M		D 43	D 47
MJ			
MF		D 136	D 137
UNC	UNJC	D 181	D 183
UNF	UNJF	D 204	D 206
UNEF	UN-8		D 212
G			D 233
RC	RP		
NPT	NPSM		
NPTF			
Pg	BSW	D 260	D 260
TR			
EG M	EG MF		D 264
EG UNC			D 273
EG UNF			D 279
Coating		uncoated/TiN	uncoated/ TiN/TiCN
Application		TH	TH

Material group	Classification of the main material groups and code letters		Birmell hardness HB	Tensile strength R _m N/mm ²	Machining group			
	Workpiece material							
P	Unalloyed and low-alloyed steel	annealed (tempered)	210	700	P1, P2, P3, P4, P7	●●	●	
		Free cutting steel	220	750	P6	●●	●●	
		tempered	300	1010	P5, P8		●	
		tempered	380	1280	P9			
		tempered	430	1480	P10			
	High-alloyed steel and high-alloyed tool steel	annealed	200	670	P11	●	●●	
		hardened and tempered	300	1010	P12		●	
		hardened and tempered	400	1360	P13			
	Stainless steel	ferritic / martensitic, annealed	200	670	P14			
		martensitic, tempered	330	1110	P15			
M	Stainless steel	austenitic, duplex	230	780	M1, M3			
		austenitic, precipitation hardened (PH)	300	1010	M2			
	Grey cast iron		245	–	K3, K4			
K	Cast iron with spheroidal graphite	ferritic, pearlitic	365	–	K1, K2, K5, K6		●●	
	GGV (CGI)		200	–	K7			
N	Aluminium wrought alloys	cannot be hardened	30	–	N1	●●	●	
		hardenable, hardened	100	340	N2	●●	●	
	Cast aluminium alloys	≤ 12 % Si	90	310	N3, N4	●	●●	
		> 12 % Si	130	450	N5		●	
	Magnesium alloys		70	250	N6		●	
	Copper and copper alloys (bronze / brass)	unalloyed, electrolytic copper	100	340	N7	●		
		Brass, bronze, red brass	90	310	N8			
Cu-alloys, short-chipping		110	380	N9				
	high-strength, Ampco	300	1010	N10				
S	Heat-resistant alloys	Fe-based	280	940	S1, S2			
		Ni-based or Co-based	250	840	S3			
		Ni-based or Co-based	350	1080	S4, S5			
	Titanium alloys	Pure titanium	200	670	S6			
		α and β alloys, hardened	375	1260	S7			
	β alloys	410	1400	S8				
	Tungsten alloys		300	1010	S9			
	Molybdenum alloys		300	1010	S10			
H	Hardened steel		50 HRC	–	H1			
			55 HRC	–	H2, H4			
			60 HRC	–	H3			
O	Thermoplasts	without abrasive fillers			O1	●●	●	
	Thermosetting plastics	without abrasive fillers			O2			
	Fibre-reinforced plastic	GFRP, AFRP				O3, O5		
		CFRP				O4		
	Graphite (technical)			65	O6			

	3,0 x D _N			3,5 x D _N	
	Prototex Inox®	Prototex® SynchroSpeed	Paradur® Eco CI	Prototex® Eco HT	Paradur® MS
	Page	Page	Page	Page	Page
	D 53	D 55	D 106	D 36	D 115
	D 141	D 143	D 168	D 134	
	D 184		D 194	D 179	
	D 207		D 221	D 202	
	D 234	D 235	D 245	D 232	
	D 265				
	D 280				
	vap/TiCN/TiN	THL/TiN	rid/TiCN	TiN/THL	uncoated
	TH	TH	BH/TH	TH	BH/TH
					
	•	••		••	
	••	••		••	
	••	••		••	
	•	••		•	
	••	••		••	
	••	••		••	
	••	••		••	
	••	••		••	
	••	••		••	
	••	••		••	
		•	••	•	
		••	•	••	
		•	••	•	
		••		••	
		••	••	••	
		••	••	••	
		••	••	•	
		••	••	•	•
		••	••	•	••
		••			
		••			
		••		•	
		••			
		••		•	
			•		•
			••		•
			••		•
			•		

Walter Select – Tapping



Blind hole machining

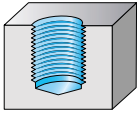







HSS-E (-PM) selection



BH = Blind hole
TH = Through hole

Thread depth	1,5 x D _N	
	Paradur® HC	Paradur® N 15
Type	Page	Page
M	D 296	D 297
MJ		
MF		
UNC	UNJC	
UNF	UNJF	
UNEF	UN-8	
G		
RC	RP	
NPT	NPSM	
NPTF		
Pg	BSW	
TR		
EG M	EG MF	
EG UNC		
EG UNF		
Coating	uncoated	uncoated
Application	BH/TH	BH

Material group	Classification of the main material groups and code letters		Brinell hardness HB	Tensile strength R _m N/mm ²	Machining group		
	Workpiece material						
P	Unalloyed and low-alloyed steel	annealed (tempered)	210	700	P1, P2, P3, P4, P7		●
		Free cutting steel	220	750	P6		●
		tempered	300	1010	P5, P8		
		tempered	380	1280	P9		
		tempered	430	1480	P10		
	High-alloyed steel and high-alloyed tool steel	annealed	200	670	P11		●
		hardened and tempered	300	1010	P12		
hardened and tempered		400	1360	P13			
Stainless steel	ferritic / martensitic, annealed	200	670	P14			
	martensitic, tempered	330	1110	P15			
M	Stainless steel	austenitic, duplex	230	780	M1, M3		
		austenitic, precipitation hardened (PH)	300	1010	M2		
K	Grey cast iron		245	–	K3, K4		
	Cast iron with spheroidal graphite GGV (CGI)	ferritic, pearlitic	365	–	K1, K2, K5, K6	●	●
			200	–	K7		
N	Aluminium wrought alloys	cannot be hardened	30	–	N1		●
		hardenable, hardened	100	340	N2	●	●
	Cast aluminium alloys	≤ 12 % Si	90	310	N3, N4	●	●
		> 12 % Si	130	450	N5	●	●
	Magnesium alloys		70	250	N6	●	●
	Copper and copper alloys (bronze / brass)	unalloyed, electrolytic copper	100	340	N7		●
		Brass, bronze, red brass	90	310	N8	●	●
Cu-alloys, short-chipping		110	380	N9	●	●	
high-strength, Ampco		300	1010	N10			
S	Heat-resistant alloys	Fe-based	280	940	S1, S2		
		Ni-based or Co-based	250	840	S3		
		Ni-based or Co-based	350	1080	S4, S5		
	Titanium alloys	Pure titanium	200	670	S6		
		α and β alloys, hardened	375	1260	S7		
		β alloys	410	1400	S8		
	Tungsten alloys		300	1010	S9		
Molybdenum alloys		300	1010	S10			
H	Hardened steel		50 HRC	–	H1		
			55 HRC	–	H2, H4		
			60 HRC	–	H3		
O	Thermoplasts	without abrasive fillers			O1		
	Thermosetting plastics	without abrasive fillers			O2	●	
	Fibre-reinforced plastic	GFRP, AFRP			O3, O5	●	
		CFRP			O4	●	
Graphite (technical)			65		O6	●	

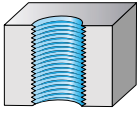

	2,0 x D _N	2,5 x D _N		3,0 x D _N				
	Paradur® Sprint	Paradur® VA	Paradur® Megasprint	Paradur® Uni	Paradur® Sprint 50	Paradur® W40	Paradur® CI	Paradur® AL
	Page	Page	Page	Page	Page	Page	Page	Page
	D 302	D 301	D 304	D 298	D 303	D 300	D 305	D 306
	D 313	D 312		D 311	D 314			
		D 318		D 317				
	TiN/TiCN	uncoated/vap/TiN	TiN	uncoated	vap/TAFT	uncoated	nid/TAFT	uncoated
	BH	BH	BH	BH	BH	BH	BH/TH	BH
								
				•		•		•
	•		•	••	•	•		
	•	••	•		•			
				••		•		
	•	••	•		•			
	•	••	•		•			
	•	••	•		•			
	•	••	•		•			
							•	
	•	•	•	•		•	•	
				•		•	•	•
				•		•	•	•
	•	•	•	•		•	•	•
							•	
								•
								•
								•
								•

Walter Select – Tapping Through hole machining HSS-E (-PM) selection



BH = Blind hole
TH = Through hole

Thread depth	1,5 x D _N	3,0 x D _N	
Type	Paradur® HC	Prototex® Uni	
	Page	Page	
M	D 296	D 290	
MJ			
MF		D 307	
UNC	UNJC		
UNF	UNJF		
UNEF	UN-8		
G		D 315	
RC	RP		
NPT	NPSM		
NPTF			
Pg	BSW		
TR			
EG M	EG MF		
EG UNC			
EG UNF			
Coating	uncoated	uncoated/ TiN/TiCN	
Application	BH/TH	TH	

Material group	Classification of the main material groups and code letters		Birmell hardness HB	Tensile strength R _m N/mm ²	Machining group			
	Workpiece material							
P	Unalloyed and low-alloyed steel	annealed (tempered)	210	700	P1, P2, P3, P4, P7		●	
		Free cutting steel	220	750	P6		●●	
		tempered	300	1010	P5, P8		●	
		tempered	380	1280	P9			
		tempered	430	1480	P10			
	High-alloyed steel and high-alloyed tool steel	annealed	200	670	P11		●●	
		hardened and tempered	300	1010	P12		●●	
		hardened and tempered	400	1360	P13			
	Stainless steel	ferritic / martensitic, annealed	200	670	P14			
		martensitic, tempered	330	1110	P15			
M	Stainless steel	austenitic, duplex	230	780	M1, M3			
		austenitic, precipitation hardened (PH)	300	1010	M2			
	Grey cast iron		245	–	K3, K4	●		
K	Cast iron with spheroidal graphite	ferritic, pearlitic	365	–	K1, K2, K5, K6	●	●●	
	GGV (CGI)		200	–	K7	●		
N	Aluminium wrought alloys	cannot be hardened	30	–	N1		●	
		hardenable, hardened	100	340	N2	●	●	
	Cast aluminium alloys	≤ 12 % Si	90	310	N3, N4	●	●●	
		> 12 % Si	130	450	N5	●	●	
	Magnesium alloys		70	250	N6	●	●	
	Copper and copper alloys (bronze / brass)	unalloyed, electrolytic copper	100	340	N7			
		Brass, bronze, red brass	90	310	N8	●		
Cu-alloys, short-chipping		110	380	N9	●			
	high-strength, Ampco	300	1010	N10				
S	Heat-resistant alloys	Fe-based	280	940	S1, S2			
		Ni-based or Co-based	250	840	S3			
		Ni-based or Co-based	350	1080	S4, S5			
	Titanium alloys	Pure titanium	200	670	S6			
		α and β alloys, hardened	375	1260	S7			
	β alloys	410	1400	S8				
	Tungsten alloys		300	1010	S9			
	Molybdenum alloys		300	1010	S10			
H	Hardened steel		50 HRC	–	H1			
			55 HRC	–	H2, H4			
			60 HRC	–	H3			
O	Thermoplasts	without abrasive fillers			O1		●	
	Thermosetting plastics	without abrasive fillers			O2	●		
	Fibre-reinforced plastic	GFRP, AFRP			O3, O5	●		
		CFRP			O4	●		
	Graphite (technical)			65	O6	●		

Machine tap Prototex® Eco HT

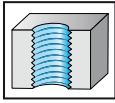

 $\leq 3,5 \times D_N$

- HSS-E-PM
- chamfer form B = 3.5 - 5 thread
- enlarged core diameter
- materials from 500 to 1350 N/mm² or 42 HRC
- for long-chipping materials
- suitable for minimum quantity lubrication

M
DIN 13

	P	M	K	N	S	H	O
TiN	●	●	●	●	●		●
THL	●	●	●	●	●		●

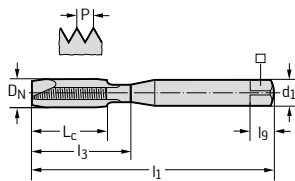
DIN 371 6HX



D _N	P mm	l ₁ js16 mm	L _c mm	l ₃ ±1 mm	d ₁ h9 mm	□ h12 mm	l ₉ mm	N	TiN designation E2021305	THL designation E2021302
M 2	0,4	45	6	9	2,8	2,1	5	3	-M2	-M2
M 2,5	0,45	50	8	12,5	2,8	2,1	5	3	-M2.5	-M2.5
M 3	0,5	56	9	18	3,5	2,7	6	3	-M3	-M3
M 4	0,7	63	12	21	4,5	3,4	6	3	-M4	-M4
M 5	0,8	70	13	25	6	4,9	8	3	-M5	-M5
M 6	1	80	15	30	6	4,9	8	3	-M6	-M6
M 8	1,25	90	18	35	8	6,2	9	3	-M8	-M8
M 10	1,5	100	20	39	10	8	11	3	-M10	-M10

DIN 376 6HX

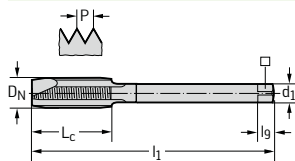

D _N	P mm	l ₁ js16 mm	L _c mm	l ₃ ±1 mm	d ₁ h9 mm	□ h12 mm	l ₉ mm	N	TiN designation E2026305	THL designation E2026302
M 12	1,75	110	23	-	9	7	10	4	-M12	-M12
M 14	2	110	25	-	11	9	12	4	-M14	-M14
M 16	2	110	25	-	12	9	12	4	-M16	-M16
M 18	2,5	125	30	-	14	11	14	4	-M18	-M18
M 20	2,5	140	30	-	16	12	15	4	-M20	-M20
M 24	3	160	36	-	18	14,5	17	4	-M24	-M24

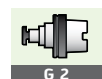

G 2



D 396

Machine tap Prototex® Eco HT



$\leq 3,5 \times D_N$

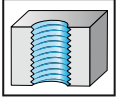

- HSS-E-PM
- chamfer form B = 3.5 - 5 thread
- enlarged core diameter
- materials from 500 to 1350 N/mm² or 42 HRC
- for long-chipping materials
- suitable for minimum quantity lubrication

M

DIN 13

	P	M	K	N	S	H	O
TiN	●	●	●	●	●		●
THL	●	●	●	●	●		●

DIN 371 6GX		D_N	P mm	l_1 js16 mm	L_c mm	l_3 ± 1 mm	d_1 h9 mm	\square h12 mm	l_g mm	N	TiN designation E2023305	THL designation E2023302
		M 2	0,4	45	6	9	2,8	2,1	5	3	-M2	-M2
		M 2,5	0,45	50	8	12,5	2,8	2,1	5	3	-M2.5	-M2.5
		M 3	0,5	56	9	18	3,5	2,7	6	3	-M3	-M3
		M 4	0,7	63	12	21	4,5	3,4	6	3	-M4	-M4
		M 5	0,8	70	13	25	6	4,9	8	3	-M5	-M5
		M 6	1	80	15	30	6	4,9	8	3	-M6	-M6
		M 8	1,25	90	18	35	8	6,2	9	3	-M8	-M8
		M 10	1,5	100	20	39	10	8	11	3	-M10	-M10

DIN 376 6GX		D_N	P mm	l_1 js16 mm	L_c mm	l_3 ± 1 mm	d_1 h9 mm	\square h12 mm	l_g mm	N	TiN designation E2028305	THL designation E2028302
		M 12	1,75	110	23	-	9	7	10	4	-M12	-M12
		M 14	2	110	25	-	11	9	12	4	-M14	-M14
		M 16	2	110	25	-	12	9	12	4	-M16	-M16

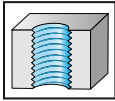

Machine tap Prototex® Eco HT

 $\leq 3,5 \times D_N$

- HSS-E-PM
- chamfer form B = 3.5 - 5 thread
- enlarged core diameter
- materials from 500 to 1350 N/mm² or 42 HRC
- for long-chipping materials
- suitable for minimum quantity lubrication

M

DIN 13

	P	M	K	N	S	H	O
THL	●	●	●	●	●		●

DIN 371 6HX

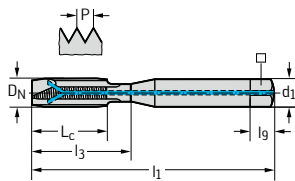

D_N	P mm	l_1 js16 mm	L_c mm	l_3 ± 1 mm	d_1 h9 mm	\square h12 mm	l_g mm	N	THL designation E2021342
M 6	1	80	15	30	6	4,9	8	3	-M6
M 8	1,25	90	18	35	8	6,2	9	3	-M8
M 10	1,5	100	20	39	10	8	11	3	-M10

DIN 376 6HX

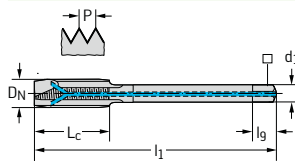

D_N	P mm	l_1 js16 mm	L_c mm	l_3 ± 1 mm	d_1 h9 mm	\square h12 mm	l_g mm	N	THL designation E2026342
M 12	1,75	110	23	-	9	7	10	4	-M12
M 16	2	110	25	-	12	9	12	4	-M16



G 2



D 396

Machine tap Prototex® Eco HT



$\leq 3,5 \times D_N$

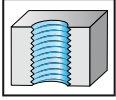

- HSS-E-PM
- chamfer form B = 3.5 - 5 thread
- Left-hand thread
- enlarged core diameter
- long-chipping materials from 500 to 1350 N/mm² or 42 HRC
- suitable for minimum quantity lubrication

M

DIN 13

	P	M	K	N	S	H	O
THL	●	●	●	●	●		●

DIN 371 6HX		D_N	P mm	l_1 js16 mm	L_c mm	l_3 ± 1 mm	d_1 h9 mm	\square h12 mm	l_g mm	N	THL designation E2021382
	M 3 LH		0,5	56	9	18	3,5	2,7	6	3	-M3
	M 4 LH		0,7	63	12	21	4,5	3,4	6	3	-M4
	M 5 LH		0,8	70	13	25	6	4,9	8	3	-M5
	M 6 LH		1	80	15	30	6	4,9	8	3	-M6
	M 8 LH		1,25	90	18	35	8	6,2	9	3	-M8
	M 10 LH		1,5	100	20	39	10	8	11	3	-M10

DIN 376 6HX		D_N	P mm	l_1 js16 mm	L_c mm	l_3 ± 1 mm	d_1 h9 mm	\square h12 mm	l_g mm	N	THL designation E2026382
	M 12 LH		1,75	110	23	-	9	7	10	4	-M12
	M 16 LH		2	110	25	-	12	9	12	4	-M16
	M 20 LH		2,5	140	30	-	16	12	15	4	-M20

Machine tap Prototex® OS

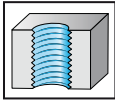

 $\leq 1 \times D_N$

- HSS-E
- chamfer form B = 3.5 - 5 thread
- materials from 200 to 700 N/mm² or 14 HRC
- for long-chipping materials

M

DIN 13

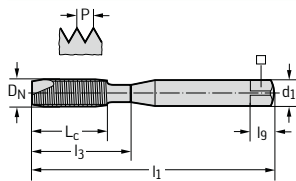
	P	M	K	N	S	H	O
uncoated	●●			●			

DIN 371 ISO2/6H

D _N	P mm	l ₁ js16 mm	L _c mm	l ₃ ±1 mm	d ₁ h9 mm	□ h12 mm	l _g mm	N	uncoated designation 20211
M 1	0,25	40	5	-	2,5	2,1	5	2	-M1 ¹
M 1,2	0,25	40	5	-	2,5	2,1	5	2	-M1.2 ¹
M 1,4	0,3	40	6,5	-	2,5	2,1	5	2	-M1.4 ¹
M 1,6	0,35	40	7	-	2,5	2,1	5	2	-M1.6 ¹
M 1,7	0,35	40	7	-	2,5	2,1	5	2	-M1.7 ¹
M 1,8	0,35	40	7	-	2,5	2,1	5	2	-M1.8 ¹
M 2	0,4	45	6	9	2,8	2,1	5	2	-M2
M 2,5	0,45	50	8	12,5	2,8	2,1	5	2	-M2.5
M 2,6	0,45	50	8	12,5	2,8	2,1	5	2	-M2.6
M 3	0,5	56	9	18	3,5	2,7	6	2	-M3
M 4	0,7	63	12	21	4,5	3,4	6	2	-M4
M 5	0,8	70	13	25	6	4,9	8	2	-M5
M 6	1	80	15	30	6	4,9	8	3	-M6
M 8	1,25	90	18	35	8	6,2	9	3	-M8
M 10	1,5	100	20	39	10	8	11	3	-M10

 $\leq M 1,4$: 5H, $\geq M 1,6$: ISO 2/6H

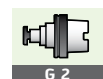
¹without neck

G 2



D 396

Machine tap Prototex® OS



$\leq 1 \times D_N$

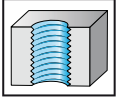

- HSS-E
- chamfer form B = 3.5 - 5 thread
- materials from 200 to 700 N/mm² or 14 HRC
- for long-chipping materials

M

DIN 13

	P	M	K	N	S	H	O
uncoated	●●			●			

DIN 371	ISO3/6G								
D_N	P mm	l_1 js16 mm	L_c mm	d_1 h9 mm	\square h12 mm	l_g mm	N	uncoated designation 20231	
M 1,4	0,3	40	6,5	2,5	2,1	5	2	-M1.4 ¹	
M 1,6	0,35	40	7	2,5	2,1	5	2	-M1.6 ¹	

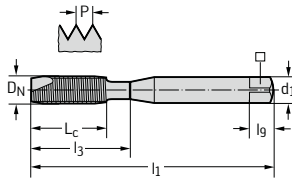

$\leq M 1,4$: 5G, $\geq M 1,6$: ISO 3/6G

¹without neck

Machine tap Paradur® N



$\leq 3 \times D_N$

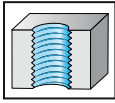

- HSS-E
- chamfer form D = 3.5 - 5 thread
- 15° left-hand spiral
- materials from 200 to 1000 N/mm² or 32 HRC
- for long-chipping materials

M

DIN 13

	P	M	K	N	S	H	O
uncoated	●●	●	●●	●●	●	●	●

DIN 371 ISO2/6H		P mm	l_1 js16 mm	L_c mm	l_3 ± 1 mm	d_1 h9 mm	\square h12 mm	l_g mm	N	uncoated designation 20411
D_N										
M 3		0,5	56	9	18	3,5	2,7	6	3	-M3
M 4		0,7	63	12	21	4,5	3,4	6	3	-M4
M 5		0,8	70	13	25	6	4,9	8	3	-M5
M 6		1	80	15	30	6	4,9	8	3	-M6

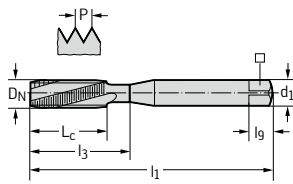

DIN 376 ISO2/6H		P mm	l_1 js16 mm	L_c mm	l_3 ± 1 mm	d_1 h9 mm	\square h12 mm	l_g mm	N	uncoated designation 20461
D_N										
M 6		1	80	15	-	4,5	3,4	6	3	-M6
M 8		1,25	90	18	-	6	4,9	8	3	-M8
M 10		1,5	100	20	-	7	5,5	8	3	-M10
M 12		1,75	110	23	-	9	7	10	3	-M12

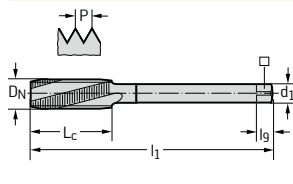

Machine tap Prototex®



$\leq 3 \times D_N$

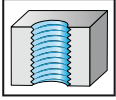

- HSS-E
- chamfer form B = 3.5 - 5 thread
- materials from 200 to 700 N/mm² or 14 HRC
- for long-chipping materials

M

DIN 13

	P	M	K	N	S	H	O
uncoated	●●			●●			●
TiN	●●			●●			●

DIN 371 ISO2/6H		D_N	P mm	l_1 js16 mm	L_c mm	l_3 ± 1 mm	d_1 h9 mm	\square h12 mm	l_g mm	N	uncoated designation 20210	TiN designation 202105
		M 1	0,25	40	5	-	2,5	2,1	5	2	-M1 ¹	
		M 1,2	0,25	40	5	-	2,5	2,1	5	2	-M1.2 ¹	-M1.2
		M 1,4	0,3	40	6,5	-	2,5	2,1	5	2	-M1.4 ¹	-M1.4
		M 1,6	0,35	40	7	-	2,5	2,1	5	2	-M1.6 ¹	-M1.6
		M 1,8	0,35	40	7	-	2,5	2,1	5	2	-M1.8 ¹	
		M 2	0,4	45	6	9	2,8	2,1	5	2	-M2	-M2
		M 2,2	0,45	45	7	12	2,8	2,1	5	2	-M2.2	
		M 2,3	0,4	45	7	12	2,8	2,1	5	2	-M2.3	
		M 2,5	0,45	50	8	12,5	2,8	2,1	5	2	-M2.5	-M2.5
		M 2,6	0,45	50	8	12,5	2,8	2,1	5	2	-M2.6	
		M 3	0,5	56	9	18	3,5	2,7	6	2	-M3	-M3
		M 3,5	0,6	56	11	20	4	3	6	2	-M3.5	-M3.5
		M 4	0,7	63	12	21	4,5	3,4	6	2	-M4	-M4
		M 4,5	0,75	70	13	25	6	4,9	8	2	-M4.5	
		M 5	0,8	70	13	25	6	4,9	8	2	-M5	-M5
		M 6	1	80	15	30	6	4,9	8	2	-M6	-M6

$\leq M 1,4$: 5H, $\geq M 1,6$: ISO 2/6H

¹without neck

Machine tap Prototex®





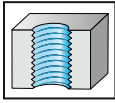















$\leq 3 \times D_N$



- HSS-E
- chamfer form B = 3.5 - 5 thread
- materials from 200 to 700 N/mm² or 14 HRC
- for long-chipping materials

M
DIN 13

	P	M	K	N	S	H	O
uncoated	●●			●●			●
TiN	●●			●●			●

DIN 371 ISO3/6G		D_N	P mm	l_1 js16 mm	L_c mm	l_3 ± 1 mm	d_1 h9 mm	\square h12 mm	l_g mm	N	uncoated designation 20230	TiN designation 202305
		M 2	0,4	45	6	9	2,8	2,1	5	2	-M2	-M2
		M 2,2	0,45	45	7	12	2,8	2,1	5	2	-M2.2	
		M 2,3	0,4	45	7	12	2,8	2,1	5	2	-M2.3	
		M 2,5	0,45	50	8	12,5	2,8	2,1	5	2	-M2.5	-M2.5
		M 2,6	0,45	50	8	12,5	2,8	2,1	5	2	-M2.6	
		M 3	0,5	56	9	18	3,5	2,7	6	2	-M3	-M3
		M 3,5	0,6	56	11	20	4	3	6	2	-M3.5	-M3.5
		M 4	0,7	63	12	21	4,5	3,4	6	2	-M4	-M4
		M 5	0,8	70	13	25	6	4,9	8	2	-M5	-M5



G 2



D 396

Machine tap Prototex®



$\leq 3 \times D_N$

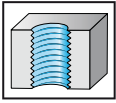

- HSS-E
- chamfer form B = 3.5 - 5 thread
- materials from 200 to 700 N/mm² or 14 HRC
- for long-chipping materials

M

DIN 13

	P	M	K	N	S	H	O
uncoated	●●			●●			●

DIN 371 IS01/4H		D_N	P mm	l_1 js16 mm	L_c mm	l_3 ± 1 mm	d_1 h9 mm	\square h12 mm	l_g mm	N	uncoated designation 20200
	M 1,6	0,35	40	7	-	2,5	2,1	5	2	-M1.6 ¹	
	M 2	0,4	45	6	9	2,8	2,1	5	2	-M2	
	M 2,2	0,45	45	7	12	2,8	2,1	5	2	-M2.2	
	M 2,5	0,45	50	8	12,5	2,8	2,1	5	2	-M2.5	
	M 3	0,5	56	9	18	3,5	2,7	6	2	-M3	
	M 3,5	0,6	56	11	20	4	3	6	2	-M3.5	
	M 4	0,7	63	12	21	4,5	3,4	6	2	-M4	
	M 5	0,8	70	13	25	6	4,9	8	2	-M5	
	M 6	1	80	15	30	6	4,9	8	2	-M6	
	M 8	1,25	90	18	35	8	6,2	9	3	-M8	
M 10	1,5	100	20	39	10	8	11	3	-M10		

¹without neck

Machine tap Prototex®



$\leq 3 \times D_N$

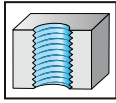

- HSS-E
- chamfer form B = 3.5 - 5 thread
- Left-hand thread
- materials from 200 to 700 N/mm² or 14 HRC
- for long-chipping materials

M

DIN 13

	P	M	K	N	S	H	O
uncoated	●●			●●			●

DIN 371 ISO2/6H			l_1 js16 mm	L_c mm	l_3 ± 1 mm	d_1 h9 mm	\square h12 mm	l_g mm	N	uncoated designation 20218
D_N	P mm									
M 2 LH	0,4	45	6	9	2,8	2,1	5	2	-M2	
M 3 LH	0,5	56	9	18	3,5	2,7	6	2	-M3	
M 4 LH	0,7	63	12	21	4,5	3,4	6	2	-M4	
M 5 LH	0,8	70	13	25	6	4,9	8	2	-M5	
M 6 LH	1	80	15	30	6	4,9	8	3	-M6	
M 8 LH	1,25	90	18	35	8	6,2	9	3	-M8	
M 10 LH	1,5	100	20	39	10	8	11	3	-M10	

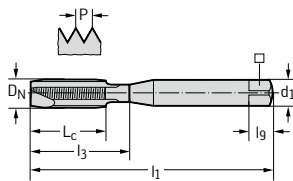

DIN 376 ISO2/6H			l_1 js16 mm	L_c mm	l_3 ± 1 mm	d_1 h9 mm	\square h12 mm	l_g mm	N	uncoated designation 20268
D_N	P mm									
M 12 LH	1,75	110	23	-	9	7	10	3	-M12	
M 16 LH	2	110	25	-	12	9	12	3	-M16	
M 20 LH	2,5	140	30	-	16	12	15	3	-M20	

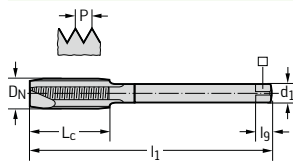

Machine tap Prototex® H



$\leq 3 \times D_N$

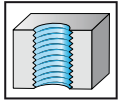

- HSS-E
- chamfer form B = 3.5 - 5 thread
- materials from 200 to 1000 N/mm² or 32 HRC
- for long-chipping materials

M

DIN 13

	P	M	K	N	S	H	O
uncoated	●	●	●	●	●	●	●
TiN	●	●	●	●	●	●	●
TiCN	●	●	●	●	●	●	●

DIN 371 ISO2/6H

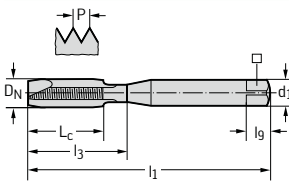

D _N	P mm	l ₁ js16 mm	L _c mm	l ₃ ±1 mm	d ₁ h9 mm	□ h12 mm	l _g mm	N	uncoated designation 20310	TIN designation 203105	TICN designation 2031006
M 2	0,4	45	6	9	2,8	2,1	5	3	-M2	-M2	-M2
M 2,2	0,45	45	7	12	2,8	2,1	5	3	-M2.2	-M2.2	
M 2,5	0,45	50	8	12,5	2,8	2,1	5	3	-M2.5	-M2.5	-M2.5
M 3	0,5	56	9	18	3,5	2,7	6	3	-M3	-M3	-M3
M 3,5	0,6	56	11	20	4	3	6	3	-M3.5		
M 4	0,7	63	12	21	4,5	3,4	6	3	-M4	-M4	-M4
M 5	0,8	70	13	25	6	4,9	8	3	-M5	-M5	-M5
M 6	1	80	15	30	6	4,9	8	3	-M6	-M6	-M6
M 7	1	80	15	30	7	5,5	8	3	-M7	-M7	
M 8	1,25	90	18	35	8	6,2	9	3	-M8	-M8	-M8
M 10	1,5	100	20	39	10	8	11	3	-M10	-M10	-M10

DIN 376 ISO2/6H

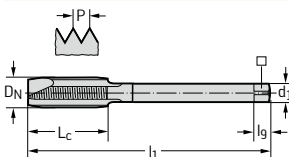

D _N	P mm	l ₁ js16 mm	L _c mm	l ₃ ±1 mm	d ₁ h9 mm	□ h12 mm	l _g mm	N	uncoated designation 20360	TIN designation 2036005	TICN designation 2036006
M 2	0,4	45	6	-	1,4	1,12	4	3	-M2		
M 2,5	0,45	50	8	-	1,8	1,4	4	3	-M2.5		
M 3	0,5	56	9	-	2,2	1,8	4	3	-M3		
M 4	0,7	63	12	-	2,8	2,1	5	3	-M4		
M 5	0,8	70	13	-	3,5	2,7	6	3	-M5		
M 6	1	80	15	-	4,5	3,4	6	3	-M6	-M6	-M6
M 7	1	80	15	-	5,5	4,3	7	3	-M7		
M 8	1,25	90	18	-	6	4,9	8	3	-M8	-M8	-M8
M 9	1,25	90	18	-	7	5,5	8	3	-M9		
M 10	1,5	100	20	-	7	5,5	8	3	-M10	-M10	-M10
M 12	1,75	110	23	-	9	7	10	3	-M12	-M12	-M12
M 14	2	110	25	-	11	9	12	3	-M14	-M14	
M 16	2	110	25	-	12	9	12	3	-M16	-M16	-M16
M 18	2,5	125	30	-	14	11	14	4	-M18	-M18	
M 20	2,5	140	30	-	16	12	15	4	-M20	-M20	-M20
M 22	2,5	140	30	-	18	14,5	17	4	-M22		
M 24	3	160	36	-	18	14,5	17	4	-M24	-M24	-M24
M 27	3	160	36	-	20	16	19	4	-M27	-M27	-M27
M 30	3,5	180	42	-	22	18	21	4	-M30	-M30	-M30
M 33	3,5	180	42	-	25	20	23	4	-M33		
M 36	4	200	48	-	28	22	25	4	-M36	-M36	
M 39	4	200	48	-	32	24	27	4	-M39		
M 42	4,5	200	54	-	32	24	27	4	-M42		
M 45	4,5	220	54	-	36	29	32	4	-M45		
M 48	5	250	60	-	36	29	32	4	-M48		
M 52	5	250	60	-	40	32	35	4	-M52		
M 56	5,5	250	66	-	40	32	35	4	-M56		



Machine tap Prototex® H

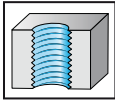

 $\leq 3 \times D_N$

- HSS-E
- chamfer form B = 3.5 - 5 thread
- materials from 200 to 1000 N/mm² or 32 HRC
- for long-chipping materials

M
DIN 13

	P	M	K	N	S	H	O
uncoated	●●	●	●	●●	●	●	●
TiN	●●	●	●	●●	●	●	●

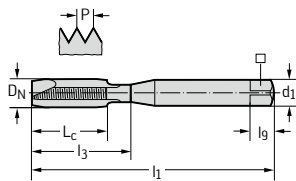
DIN 371 ISO3/6G



D_N	P mm	l_1 js16 mm	L_c mm	l_3 ± 1 mm	d_1 h9 mm	\square h12 mm	l_g mm	N	uncoated designation 20330	TiN designation 2033005
M 2,5	0,45	50	8	12,5	2,8	2,1	5	3	-M2.5	
M 3	0,5	56	9	18	3,5	2,7	6	3	-M3	
M 3,5	0,6	56	11	20	4	3	6	3	-M3.5	
M 4	0,7	63	12	21	4,5	3,4	6	3	-M4	
M 5	0,8	70	13	25	6	4,9	8	3	-M5	
M 6	1	80	15	30	6	4,9	8	3	-M6	-M6
M 7	1	80	15	30	7	5,5	8	3	-M7	
M 8	1,25	90	18	35	8	6,2	9	3	-M8	-M8
M 10	1,5	100	20	39	10	8	11	3	-M10	-M10

DIN 376 ISO3/6G

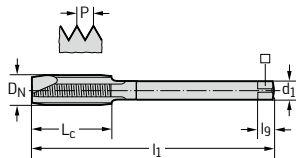

D_N	P mm	l_1 js16 mm	L_c mm	l_3 ± 1 mm	d_1 h9 mm	\square h12 mm	l_g mm	N	uncoated designation 20380
M 5	0,8	70	13	-	3,5	2,7	6	3	-M5
M 6	1	80	15	-	4,5	3,4	6	3	-M6
M 8	1,25	90	18	-	6	4,9	8	3	-M8
M 10	1,5	100	20	-	7	5,5	8	3	-M10
M 12	1,75	110	23	-	9	7	10	3	-M12
M 14	2	110	25	-	11	9	12	3	-M14
M 16	2	110	25	-	12	9	12	3	-M16
M 18	2,5	125	30	-	14	11	14	4	-M18
M 20	2,5	140	30	-	16	12	15	4	-M20
M 24	3	160	36	-	18	14,5	17	4	-M24



G 2



D 396

Machine tap Prototex® H



$\leq 3 \times D_N$

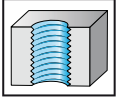

- HSS-E
- chamfer form B = 3.5 - 5 thread
- materials from 200 to 1000 N/mm² or 32 HRC
- for long-chipping materials

M

DIN 13

	P	M	K	N	S	H	O
uncoated	●●		●	●●			●
TiN	●●		●	●●			●

DIN 371 7G											uncoated designation 20340	TIN designation 2034005
D_N	P mm	l_1 js16 mm	L_c mm	l_3 ±1 mm	d_1 h9 mm	\square h12 mm	l_g mm	N				
M 2	0,4	45	6	11	2,8	2,1	5	3			-M2	-M2
M 2,5	0,45	50	8	12,5	2,8	2,1	5	3			-M2.5	-M2.5
M 2,6	0,45	50	8	14	2,8	2,1	5	3			-M2.6	
M 3	0,5	56	9	18	3,5	2,7	6	3			-M3	-M3
M 3,5	0,6	56	11	20	4	3	6	3			-M3.5	-M3.5
M 4	0,7	63	12	21	4,5	3,4	6	3			-M4	-M4
M 5	0,8	70	13	25	6	4,9	8	3			-M5	-M5
M 6	1	80	15	30	6	4,9	8	3			-M6	-M6
M 8	1,25	90	18	35	8	6,2	9	3			-M8	-M8
M 10	1,5	100	20	39	10	8	11	3			-M10	-M10

DIN 376 7G											uncoated designation 20390	TIN designation 2039005
D_N	P mm	l_1 js16 mm	L_c mm	l_3 ±1 mm	d_1 h9 mm	\square h12 mm	l_g mm	N				
M 12	1,75	110	23	-	9	7	10	3			-M12	-M12
M 16	2	110	25	-	12	9	12	3			-M16	-M16
M 20	2,5	140	30	-	16	12	15	4			-M20	-M20

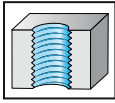

Machine tap Prototex® H

 $\leq 3 \times D_N$

- HSS-E
- overall length L = long
- chamfer form B = 3.5 - 5 thread
- materials from 200 to 1000 N/mm² or 32 HRC
- for long-chipping materials

M
DIN 13

	P	M	K	N	S	H	O
uncoated	●	●	●	●	●	●	●
TiN	●	●	●	●	●	●	●

~DIN 371 ISO2/6H

D_N	P mm	l_1 js16 mm	L_c mm	l_3 ± 1 mm	d_1 h9 mm	\square h12 mm	l_g mm	N	uncoated designation 2031030	TiN designation 2031035
M 3	0,5	112	9	18	3,5	2,7	6	3	-M3	-M3
M 4	0,7	112	12	21	4,5	3,4	6	3	-M4	-M4
M 5	0,8	125	13	25	6	4,9	8	3	-M5	-M5
M 6	1	125	15	30	6	4,9	8	3	-M6	-M6
M 8	1,25	140	18	40	8	6,2	9	3	-M8	-M8
M 10	1,5	160	20	50	10	8	11	3	-M10	-M10

~DIN 376 ISO2/6H

D_N	P mm	l_1 js16 mm	L_c mm	l_3 ± 1 mm	d_1 h9 mm	\square h12 mm	l_g mm	N	uncoated designation 2036030	TiN designation 2036035
M 5	0,8	125	13	-	3,5	2,7	6	3	-M5	-M5
M 6	1	125	15	-	4,5	3,4	6	3	-M6	-M6
M 8	1,25	140	18	-	6	4,9	8	3	-M8	-M8
M 10	1,5	160	20	-	7	5,5	8	3	-M10	-M10
M 12	1,75	180	23	-	9	7	10	3	-M12	-M12
M 14	2	180	25	-	11	9	12	3	-M14	-M14
M 16	2	200	25	-	12	9	12	3	-M16	-M16
M 20	2,5	224	30	-	16	12	15	4	-M20	-M20



G 2



D 396

Machine tap Prototex® H



$\leq 3 \times D_N$

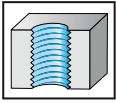

- HSS-E
- overall length XL = extra long
- chamfer form B = 3.5 - 5 thread
- materials from 200 to 1000 N/mm² or 32 HRC
- for long-chipping materials

M

DIN 13

	P	M	K	N	S	H	O
uncoated	●●	●	●	●●	●	●	●

~DIN 371 ISO2/6H		D_N	P mm	l_1 js16 mm	L_c mm	l_3 ± 1 mm	d_1 h9 mm	\square h12 mm	l_g mm	N	uncoated designation 20217
	M 4	0,7	125	12	21	4,5	3,4	6	3	-M4	
	M 5	0,8	140	13	25	6	4,9	8	3	-M5	
	M 6	1	160	15	30	6	4,9	8	3	-M6	

~DIN 376 ISO2/6H		D_N	P mm	l_1 js16 mm	L_c mm	l_3 ± 1 mm	d_1 h9 mm	\square h12 mm	l_g mm	N	uncoated designation 20267
	M 8	1,25	180	18	-	6	4,9	8	3	-M8	
	M 10	1,5	200	20	-	7	5,5	8	3	-M10	
	M 12	1,75	220	23	-	9	7	10	3	-M12	
	M 14	2	220	25	-	11	9	12	3	-M14	
	M 16	2	220	25	-	12	9	12	3	-M16	
	M 20	2,5	280	30	-	16	12	15	4	-M20	

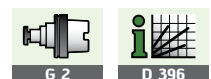

Machine tap Prototex® H AZ



$\leq 3 \times D_N$

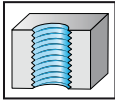

- HSS-E
- chamfer form B = 3.5 - 5 thread
- materials from 200 to 1000 N/mm² or 32 HRC
- for long-chipping materials
- for thin-walled workpieces
- interrupted teeth

M

DIN 13

	P	M	K	N	S	H	O
uncoated	●●	●	●●	●●	●	●	●

DIN 371 ISO2/6H		D_N	P mm	l_1 js16 mm	L_c mm	l_3 ± 1 mm	d_1 h9 mm	\square h12 mm	l_g mm	N	uncoated designation 40310
		M 3	0,5	56	9	18	3,5	2,7	6	3	-M3
		M 4	0,7	63	12	21	4,5	3,4	6	3	-M4
		M 5	0,8	70	13	25	6	4,9	8	3	-M5
		M 6	1	80	15	30	6	4,9	8	3	-M6
		M 8	1,25	90	18	35	8	6,2	9	3	-M8
		M 10	1,5	100	20	39	10	8	11	3	-M10

DIN 376 ISO2/6H		D_N	P mm	l_1 js16 mm	L_c mm	l_3 ± 1 mm	d_1 h9 mm	\square h12 mm	l_g mm	N	uncoated designation 40360
		M 12	1,75	110	23	-	9	7	10	3	-M12
		M 14	2	110	25	-	11	9	12	3	-M14
		M 16	2	110	25	-	12	9	12	3	-M16
		M 20	2,5	140	30	-	16	12	15	4	-M20
		M 24	3	160	36	-	18	14,5	17	4	-M24

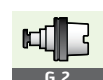

Machine tap Prototex Inox®



$\leq 3 \times D_N$

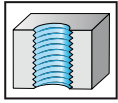

- HSS-E
- chamfer form B = 3.5 - 5 thread
- enlarged core diameter
- materials from 350 to 1200 N/mm² or 36 HRC
- for long-chipping materials

M

DIN 13

	P	M	K	N	S	H	O
vap	●●	●●	■	■	■	■	■
TiN	●●	●●	■	■	■	■	■
TiCN	●●	●●	■	■	■	■	■

DIN 371 6HX

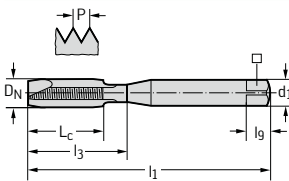

D _N	P mm	l ₁ js16 mm	L _c mm	l ₃ ±1 mm	d ₁ h9 mm	□ h12 mm	l _g mm	N	VAP designation 20213	TIN designation 202135	TICN designation 2021306
M 1	0,25	40	5	-	2,5	2,1	5	2	-M1 ¹		
M 1,2	0,25	40	5	-	2,5	2,1	5	2	-M1.2 ¹		
M 1,4	0,3	40	6,5	-	2,5	2,1	5	2	-M1.4 ¹		
M 1,6	0,35	40	7	-	2,5	2,1	5	2	-M1.6 ¹		
M 1,7	0,35	40	7	-	2,5	2,1	5	2	-M1.7 ¹		
M 1,8	0,35	40	7	-	2,5	2,1	5	2	-M1.8 ¹		
M 2	0,4	45	6	9	2,8	2,1	5	2	-M2	-M2	-M2
M 2,3	0,4	45	7	12	2,8	2,1	5	2	-M2.3		
M 2,2	0,45	45	7	12	2,8	2,1	5	2	-M2.2		
M 2,5	0,45	50	8	12,5	2,8	2,1	5	2	-M2.5	-M2.5	-M2.5
M 2,6	0,45	50	8	12,5	2,8	2,1	5	2	-M2.6		
M 3	0,5	56	9	18	3,5	2,7	6	2	-M3	-M3	-M3
M 3,5	0,6	56	11	20	4	3	6	2	-M3.5	-M3.5	-M3.5
M 4	0,7	63	12	21	4,5	3,4	6	3	-M4	-M4	-M4
M 4,5	0,75	70	13	25	6	4,9	8	3	-M4.5		
M 5	0,8	70	13	25	6	4,9	8	3	-M5	-M5	-M5
M 6	1	80	15	30	6	4,9	8	3	-M6	-M6	-M6
M 7	1	80	15	30	7	5,5	8	3	-M7		
M 8	1,25	90	18	35	8	6,2	9	3	-M8	-M8	-M8
M 9	1,25	90	18	35	9	7	10	3	-M9		
M 10	1,5	100	20	39	10	8	11	3	-M10	-M10	-M10

¹without neck

DIN 376 6HX

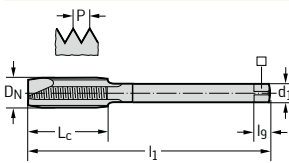

D _N	P mm	l ₁ js16 mm	L _c mm	l ₃ ±1 mm	d ₁ h9 mm	□ h12 mm	l _g mm	N	VAP designation 20263	TIN designation 202635	TICN designation 2026306
M 5	0,8	70	13	-	3,5	2,7	6	3	-M5		-M5
M 6	1	80	15	-	4,5	3,4	6	3	-M6		-M6
M 8	1,25	90	18	-	6	4,9	8	3	-M8		-M8
M 10	1,5	100	20	-	7	5,5	8	3	-M10		-M10
M 12	1,75	110	23	-	9	7	10	4	-M12	-M12	-M12
M 14	2	110	25	-	11	9	12	4	-M14	-M14	-M14
M 16	2	110	25	-	12	9	12	4	-M16	-M16	-M16
M 18	2,5	125	30	-	14	11	14	4	-M18		
M 20	2,5	140	30	-	16	12	15	4	-M20	-M20	-M20
M 22	2,5	140	30	-	18	14,5	17	4	-M22		
M 24	3	160	36	-	18	14,5	17	4	-M24		-M24
M 27	3	160	36	-	20	16	19	4	-M27		
M 30	3,5	180	42	-	22	18	21	4	-M30		
M 33	3,5	180	42	-	25	20	23	5	-M33		
M 36	4	200	48	-	28	22	25	5	-M36		

≤M 1,4: 5HX



Machine tap Prototex Inox®

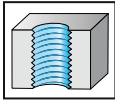

 $\leq 3 \times D_N$

- HSS-E
- chamfer form B = 3.5 - 5 thread
- enlarged core diameter
- materials from 350 to 1200 N/mm² or 36 HRC
- for long-chipping materials

M
DIN 13

	P	M	K	N	S	H	O
vap	●●	●●	●	●	●	●	●
TiCN	●●	●●	●	●	●	●	●

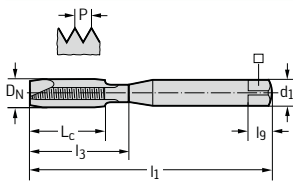
DIN 371 6GX



D_N	P mm	l_1 js16 mm	L_c mm	l_3 ± 1 mm	d_1 h9 mm	\square h12 mm	l_g mm	N	VAP designation 20233	TiCN designation 2023306
M 3	0,5	56	9	18	3,5	2,7	6	2	-M3	-M3
M 4	0,7	63	12	21	4,5	3,4	6	3	-M4	-M4
M 5	0,8	70	13	25	6	4,9	8	3	-M5	-M5
M 6	1	80	15	30	6	4,9	8	3	-M6	-M6
M 7	1	80	15	30	7	5,5	8	3	-M7	-M7
M 8	1,25	90	18	35	8	6,2	9	3	-M8	-M8
M 10	1,5	100	20	39	10	8	11	3	-M10	-M10

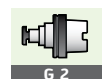

G 2



D 396

Machine tap Prototex® Synchronspeed



$\leq 3 \times D_N$

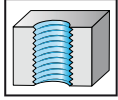

- HSS-E
- chamfer form B = 3.5 - 5 thread
- materials from 1400 N/mm² or 44 HRC
- for long-chipping materials
- only for synchronous machining (rigid tapping)
- suitable for minimum quantity lubrication

M

DIN 13

	P	M	K	N	S	H	O
TiN	●●	●●	●●	●●	●●		●●
THL	●●	●●	●●	●●	●●		●●

~DIN 371 6HX										TIN designation S2021305	THL designation S2021302
D_N	P mm	l_1 js16 mm	L_c mm	l_3 ± 1 mm	d_1 h6 mm	\square h12 mm	l_g mm	N			
Shank DIN 1835 B											
M 2	0,4	70	4	9	6	4,9	8	3		-M2	-M2
M 2,5	0,45	70	4,5	12,5	6	4,9	8	3		-M2,5	-M2,5
M 3	0,5	70	5	18	6	4,9	8	3		-M3	-M3
M 4	0,7	70	7	21	6	4,9	8	3		-M4	-M4
M 5	0,8	70	8	25	6	4,9	8	3		-M5	-M5
M 6	1	80	10	30	6	4,9	8	3		-M6	-M6
M 8	1,25	90	12,5	35	8	6,2	9	3		-M8	-M8
M 10	1,5	100	15	39	10	8	11	3		-M10	-M10

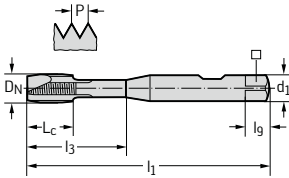

~DIN 376 6HX										TIN designation S2026305	THL designation S2026302
D_N	P mm	l_1 js16 mm	L_c mm	l_3 ± 1 mm	d_1 h6 mm	\square h12 mm	l_g mm	N			
Shank DIN 1835 B											
M 12	1,75	110	17,5	42	12	9	12	3		-M12	-M12
M 14	2	110	20	49	14	11	14	3		-M14	-M14
M 16	2	110	20	55	16	12	15	4		-M16	-M16
M 20	2,5	140	25	-	16	12	15	4		-M20	-M20
M 24	3	160	30	-	20	16	19	4		-M24	-M24

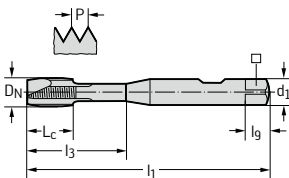

Machine tap
Prototex® TiNi



$\leq 2 \times D_N$

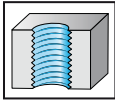

- HSS-E-PM
- chamfer form B = 3.5 - 5 thread
- materials from 700 to 1400 N/mm² or 44 HRC
- for long-chipping materials

M
DIN 13

	P	M	K	N	S	H	O
uncoated	●●	●●	■	●	●●		
TiCN	●●	●●	■	●	●●		

~DIN 371 6HX

D_N	P mm	l_1 js16 mm	L_c mm	l_3 ±1 mm	d_1 h9 mm	\square h12 mm	l_g mm	N	uncoated designation 202161	TiCN designation 2021616
M 1	0,25	40	5	-	2,5	2,1	5	2	-M1 ¹	
M 1,2	0,25	40	5	-	2,5	2,1	5	2	-M1.2 ¹	
M 1,4	0,3	40	5	-	2,5	2,1	5	2	-M1.4 ¹	
M 1,6	0,35	40	5	-	2,5	2,1	5	2	-M1.6 ¹	
M 1,8	0,35	40	5	-	2,5	2,1	5	2	-M1.8 ¹	
M 2	0,4	45	8	-	2,8	2,1	5	2	-M2 ¹	-M2
M 2,2	0,45	45	8	-	2,8	2,1	5	2	-M2.2 ¹	
M 2,5	0,45	50	9	-	2,8	2,1	5	2	-M2.5 ¹	-M2.5
M 3	0,5	56	10	-	3,5	2,7	6	2	-M3 ¹	-M3
M 3,5	0,6	56	12	-	4	3	6	3	-M3.5 ¹	-M3.5
M 4	0,7	63	13	-	4,5	3,4	6	3	-M4 ¹	-M4
M 4,5	0,75	70	13	-	6	4,9	8	3	-M4.5 ¹	
M 5	0,8	70	16	-	6	4,9	8	3	-M5 ¹	-M5
M 6	1	80	15	23	6	4,9	8	3	-M6	-M6
M 8	1,25	90	18	29,5	8	6,2	9	3	-M8	-M8
M 10	1,5	100	20	33,5	10	8	11	3	-M10	-M10

¹without neck

DIN 376 6HX

D_N	P mm	l_1 js16 mm	L_c mm	l_3 ±1 mm	d_1 h9 mm	\square h12 mm	l_g mm	N	uncoated designation 202661
M 12	1,75	110	23	-	9	7	10	4	-M12
M 14	2	110	25	-	11	9	12	4	-M14
M 16	2	110	25	-	12	9	12	4	-M16
M 20	2,5	140	30	-	16	12	15	4	-M20
M 24	3	160	36	-	18	14,5	17	4	-M24
M 27	3	160	36	-	20	16	19	4	-M27

≤M 1,4: 5HX, ≥ M1,6: 6HX



G 2

D 396

Machine tap Prototex® TiNi



$\leq 2 \times D_N$

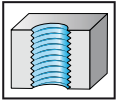

- HSS-E-PM
- chamfer form B = 3.5 - 5 thread
- materials from 700 to 1400 N/mm² or 44 HRC
- for long-chipping materials

M

DIN 13

	P	M	K	N	S	H	O
uncoated	●●	●●	●●	●	●●		

~DIN 371 4HX		D_N	P mm	l_1 js16 mm	L_c mm	l_3 ± 1 mm	d_1 h9 mm	\square h12 mm	l_9 mm	N	uncoated designation 202061
	M 2	0,4	45	8	-	2,8	2,1	5	2	-M2 ¹	
	M 2,5	0,45	50	9	-	2,8	2,1	5	2	-M2.5 ¹	
	M 3	0,5	56	10	-	3,5	2,7	6	2	-M3 ¹	
	M 3,5	0,6	56	12	-	4	3	6	3	-M3.5 ¹	
	M 4	0,7	63	13	-	4,5	3,4	6	3	-M4 ¹	
	M 5	0,8	70	16	-	6	4,9	8	3	-M5 ¹	
	M 6	1	80	15	23	6	4,9	8	3	-M6	
	M 8	1,25	90	18	29,5	8	6,2	9	3	-M8	
	M 10	1,5	100	20	33,5	10	8	11	3	-M10	

¹without neck

Machine tap Prototex® TiNi Plus

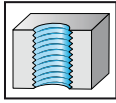
 $\leq 2 \times D_N$

- HSS-E-PM
- chamfer form B = 3.5 - 5 thread
- materials from 700 to 1400 N/mm² or 44 HRC
- for long-chipping materials

M

DIN 13

	P	M	K	N	S	H	O
ACN					●●		

~DIN 371 6HX		D_N	P mm	l_1 js16 mm	L_c mm	l_3 ± 1 mm	d_1 h9 mm	\square h12 mm	l_g mm	N	ACN designation 2021763
	M 2		0,4	45	8	-	2,8	2,1	5	2	-M2
	M 2,5		0,45	50	9	-	2,8	2,1	5	2	-M2.5
	M 3		0,5	56	10	-	3,5	2,7	6	2	-M3
	M 3,5		0,6	56	12	-	4	3	6	3	-M3.5
	M 4		0,7	63	13	-	4,5	3,4	6	3	-M4
	M 5		0,8	70	16	-	6	4,9	8	3	-M5
	M 6		1	80	15	23	6	4,9	8	3	-M6
	M 8		1,25	90	18	29,5	8	6,2	9	3	-M8
	M 10		1,5	100	20	33,5	10	8	11	3	-M10

DIN 376 6HX		D_N	P mm	l_1 js16 mm	L_c mm	l_3 ± 1 mm	d_1 h9 mm	\square h12 mm	l_g mm	N	ACN designation 2026763
	M 12		1,75	110	23	-	9	7	10	4	-M12
	M 16		2	110	25	-	12	9	12	4	-M16
	M 20		2,5	140	30	-	16	12	15	4	-M20



Machine tap Paradur® Combi



$\leq 1,5 \times D_N$

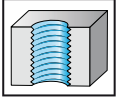

- HSS-E
- chamfer form C = 2 - 3 thread
- 30° helix angle
- materials from 200 to 1000 N/mm² or 32 HRC
- for long-chipping materials

M

DIN 13

	P	M	K	N	S	H	O
uncoated	●●	■	●	●	■	■	■

~DIN 371 ISO2/6H		D_N	P mm	l_1 js16 mm	L_c mm	d_s mm	L_s mm	l_3 ± 1 mm	d_1 h9 mm	\square h12 mm	l_g mm	N	uncoated designation 20417
	M 3	0,5	63	11	2,5	10	22	3,5	2,7	6	2	-M3	
	M 4	0,7	75	14	3,3	11	26	4,5	3,4	6	2	-M4	
	M 5	0,8	80	16	4,2	12	19	6	4,9	8	2	-M5	
	M 6	1	85	18	5	13	32	6	4,9	8	2	-M6	

~DIN 376 ISO2/6H		D_N	P mm	l_1 js16 mm	L_c mm	d_s mm	L_s mm	l_3 ± 1 mm	d_1 h9 mm	\square h12 mm	l_g mm	N	uncoated designation 20467
	M 8	1,25	90	14	6,8	18	-	6	4,9	8	2	-M8	
	M 10	1,5	100	17	8,5	24	-	7	5,5	8	4	-M10	
	M 12	1,75	125	20	10,25	25	-	9	7	10	4	-M12	

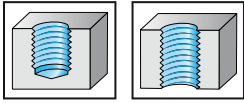

Manual tap set HGB

 $\leq 2 \times D_N$

- HSS
- overall length S = short
- chamfer form A, D, C
- materials from 200 to 850 N/mm² or 25 HRC
- for long and short-chipping materials

M

DIN 13

	P	M	K	N	S	H	O
uncoated	●	●	●	●	●	●	●

DIN 352	ISO2/6H	D_N	P mm	l_1 js16 mm	L_c mm	l_3 ± 1 mm	d_1 h9 mm	\square h12 mm	l_9 mm	N	uncoated designation 30060
		M 2	0,4	36	8	-	2,8	2,1	5	3	-M2 ¹
		M 2,5	0,45	40	9	-	2,8	2,1	5	3	-M2.5 ¹
		M 3	0,5	40	9	13,5	3,5	2,7	6	3	-M3
		M 4	0,7	45	11	16,5	4,5	3,4	6	3	-M4
		M 5	0,8	50	13	19	6	4,9	8	3	-M5
		M 6	1	56	15	27	6	4,9	8	3	-M6
		M 8	1,25	63	19	-	6	4,9	8	3	-M8
		M 10	1,5	70	22	-	7	5,5	8	3	-M10
		M 12	1,75	75	25	-	9	7	10	4	-M12
		M 16	2	80	25	-	12	9	12	4	-M16
		M 20	2,5	95	32	-	16	12	15	4	-M20
		M 24	3	110	34	-	18	14,5	17	4	-M24
		M 30	3,5	125	40	-	22	18	21	4	-M30

 $\leq M 1,4; 5H, \geq M 1,6: ISO 2/6H$

Ordering code includes initial, intermediate and final cutter

¹without neck

Manual tap set HGB Inox



$\leq 2 \times D_N$

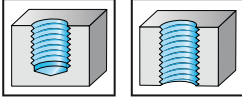

- HSS-E
- overall length S = short
- chamfer form D, D, C
- materials from 400 to 1200 N/mm² or 36 HRC
- for long-chipping materials

M

DIN 13

	P	M	K	N	S	H	O
vap	●	●					

DIN 352 6HX		D_N	P mm	l_1 js16 mm	L_c mm	l_3 ± 1 mm	d_1 h9 mm	\square h12 mm	l_g mm	N	VAP designation 30063
		M 2	0,4	36	8	-	2,8	2,1	5	3	-M2 ¹
		M 2,5	0,45	40	9	-	2,8	2,1	5	3	-M2.5 ¹
		M 3	0,5	40	9	13,5	3,5	2,7	6	3	-M3
		M 4	0,7	45	11	16,5	4,5	3,4	6	3	-M4
		M 5	0,8	50	13	19	6	4,9	8	3	-M5
		M 6	1	56	15	27	6	4,9	8	3	-M6
		M 8	1,25	63	19	-	6	4,9	8	3	-M8
		M 10	1,5	70	22	-	7	5,5	8	4	-M10
		M 12	1,75	75	25	-	9	7	10	4	-M12
		M 16	2	80	25	-	12	9	12	4	-M16
		M 20	2,5	95	32	-	16	12	15	4	-M20
		M 24	3	110	34	-	18	14,5	17	4	-M24
		M 30	3,5	125	40	-	22	18	21	4	-M30

Ordering code includes initial, intermediate and final cutter

¹without neck

Manual tap set HGB TI

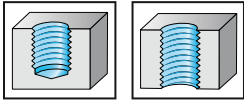
 $\leq 2 \times D_N$

- HSS-E
- overall length S = short
- chamfer form D, D, C
- materials from 700 to 1500 N/mm² or 47 HRC
- for long-chipping materials

M

DIN 13

	P	M	K	N	S	H	O
nid					●		

DIN 352 6HX		D_N	P mm	l_1 js16 mm	L_c mm	l_3 ± 1 mm	d_1 h9 mm	\square h12 mm	l_9 mm	N	NID designation 30016
		M 3	0,5	40	9	13,5	3,5	2,7	6	3	-M3
		M 4	0,7	45	11	16,5	4,5	3,4	6	3	-M4
		M 5	0,8	50	13	19	6	4,9	8	3	-M5
		M 6	1	56	15	27	6	4,9	8	3	-M6
		M 8	1,25	63	19	-	6	4,9	8	4	-M8
		M 10	1,5	70	22	-	7	5,5	8	4	-M10
		M 12	1,75	75	25	-	9	7	10	4	-M12

Ordering code includes initial, intermediate and final cutter

Short machine tap KMB WST



$\leq 3 \times D_N$

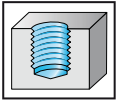

- HSS-E
- overall length S = short
- chamfer form C = 2 - 3 thread
- 40° helix angle
- materials from 200 to 1000 N/mm² or 32 HRC
- for long-chipping materials

M

DIN 13

	P	M	K	N	S	H	O
uncoated	●●		●	●			

DIN 2184-2 ISO2/6H		D_N	P mm	l_1 js16 mm	L_c mm	l_3 ± 1 mm	d_1 h9 mm	\square h12 mm	l_g mm	N	uncoated designation 20167
		M 3	0,5	40	6	13,5	3,5	2,7	6	3	-M3
		M 4	0,7	45	7	16,5	4,5	3,4	6	3	-M4
		M 5	0,8	50	8	19	6	4,9	8	3	-M5
		M 6	1	56	10	27	6	4,9	8	3	-M6
		M 8	1,25	63	12	-	6	4,9	8	3	-M8
		M 10	1,5	70	15	-	7	5,5	8	3	-M10
		M 12	1,75	75	16	-	9	7	10	3	-M12

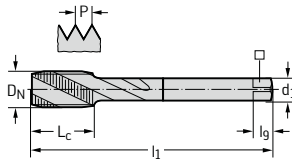

Short machine tap KMB MS

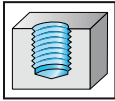

 $\leq 3 \times D_N$

- HSS-E
- overall length S = short
- chamfer form E = 1.5 - 2 thread
- materials from 350 to 850 N/mm² or 25 HRC
- for short-chipping materials

M

DIN 13

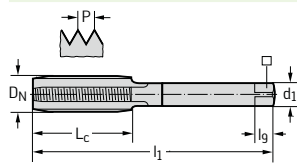
	P	M	K	N	S	H	O
uncoated				●●			●

DIN 2184-2 ISO2/6H

D _N	P mm	l ₁ js16 mm	L _c mm	l ₃ ±1 mm	d ₁ h9 mm	□ h12 mm	l _g mm	N	uncoated designation 20165
M 2	0,4	36	8	-	2,8	2,1	5	3	-M2 ¹
M 2,5	0,45	40	9	-	2,8	2,1	5	3	-M2.5 ¹
M 3	0,5	40	9	13,5	3,5	2,7	6	3	-M3
M 3,5	0,6	45	10	15	4	3	6	3	-M3.5
M 4	0,7	45	11	16,5	4,5	3,4	6	3	-M4
M 5	0,8	50	13	19	6	4,9	8	3	-M5
M 6	1	56	15	27	6	4,9	8	3	-M6
M 8	1,25	63	19	-	6	4,9	8	3	-M8

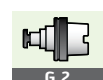
¹without neck

Short machine tap KMB H



$\leq 3 \times D_N$

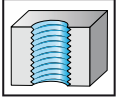

- HSS-E
- overall length S = short
- chamfer form B = 3.5 - 5 thread
- materials from 200 to 1000 N/mm² or 32 HRC
- for long-chipping materials

M

DIN 13

	P	M	K	N	S	H	O
uncoated	●●	●	●●	●●	●	●	●

DIN 2184-2 ISO2/6H		P	l_1 js16	L_c	l_3 ± 1	d_1 h9	\square h12	l_g	N	uncoated designation 20160
D_N	P mm	mm	mm	mm	mm	mm	mm	mm		
M 3	0,5	40	9	13,5	3,5	2,7	6	3		-M3
M 4	0,7	45	11	16,5	4,5	3,4	6	3		-M4
M 5	0,8	50	13	19	6	4,9	8	3		-M5
M 6	1	56	15	27	6	4,9	8	3		-M6
M 8	1,25	63	19	-	6	4,9	8	3		-M8
M 10	1,5	70	22	-	7	5,5	8	3		-M10
M 12	1,75	75	25	-	9	7	10	3		-M12

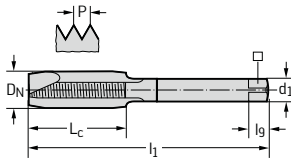

Machine nut tap MMB

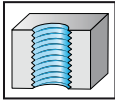

 $\leq 1 \times D_N$

- HSS-E
- materials from 200 to 900 N/mm² or 28 HRC
- for long-chipping materials

M
DIN 13

	P	M	K	N	S	H	O
uncoated	●●						

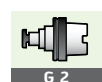
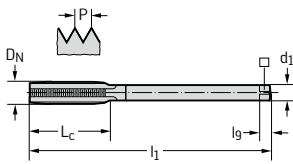
DIN 357	ISO2/6H	D_N	P mm	l_1 mm	L_c mm	d_1 h12 mm	\square h12 mm	l_g mm	N	uncoated designation 20890
		M 2	0,4	66	16	1,4	1,12	4	3	-M2
		M 2,5	0,45	70	20	1,7	1,25	4	3	-M2.5
		M 3	0,5	70	22	2,2	1,8	4	3	-M3
		M 4	0,7	90	25	2,8	2,1	5	3	-M4
		M 5	0,8	100	28	3,5	2,7	6	3	-M5
		M 6	1	110	32	4,5	3,4	6	3	-M6
		M 8	1,25	125	40	6	4,9	8	3	-M8
		M 10	1,5	140	45	7	5,5	8	3	-M10
		M 12	1,75	180	50	9	7	10	3	-M12
		M 16	2	200	63	12	9	12	3	-M16



Autom. nut thread tap AMB



$\leq 1 \times D_N$

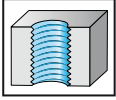

- HSS-E
- overall length L = long
- chamfer 18 x P
- materials from 200 to 900 N/mm² or 28 HRC
- for long-chipping materials

M

DIN 13

	P	M	K	N	S	H	O
nid	●●						

Streicher 2 AN, 3 AN ISO3/6G

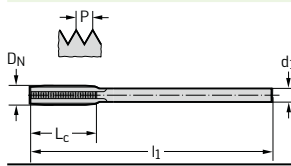

D _N	P mm	l ₁ mm	L _c mm	d ₁ h12 mm	N	NID designation 20801
M 3	0,5	250	12	2,3	3	-M3
M 3,5	0,6	250	14,5	2,7	3	-M3.5
M 4	0,7	250	17	3	3	-M4
M 5	0,8	250	19	3,9	3	-M5
M 6	1	250	24	4,6	3	-M6
M 8	1,25	250	30	6,1	3	-M8



Autom. nut thread tap AMB



$\leq 1 \times D_N$

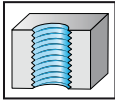

- HSS-E
- overall length L = long
- chamfer 18 x P
- materials from 200 to 900 N/mm² or 28 HRC
- for long-chipping materials

M
DIN 13

	P	M	K	N	S	H	O
TiN	●●						

MAS 14 7G

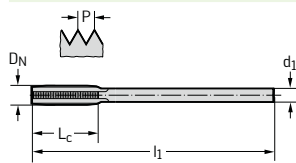

D _N	P mm	l ₁ mm	L _c mm	d ₁ h12 mm	N	TiN designation 2084805
M 5	0,8	271	19	3,9	5	-M5
M 6	1	271	24	4,6	5	-M6
M 8	1,25	271	30	6,1	5	-M8
M 10	1,5	271	36	8	5	-M10
M 12	1,75	271	42	9,4	5	-M12

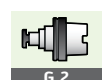

Autom. nut thread tap AMB Inox

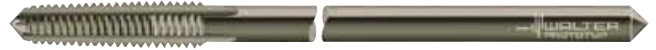

$\leq 1 \times D_N$

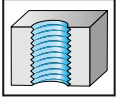

- HSS-E
- overall length L = long
- chamfer 18 x P
- materials from 400 to 1100 N/mm² or 33 HRC
- for long-chipping materials

M

DIN 13

	P	M	K	N	S	H	O
nid		●●					

MAS 14, T-STAR 10 6HX		D_N	P mm	l_1 mm	L_c mm	d_1 h12 mm	N	NID designation 20844
	M 6		1	271	24	4,6	5	-M6
	M 8		1,25	271	30	6,1	5	-M8
	M 10		1,5	271	36	8	5	-M10
	M 12		1,75	271	42	9,4	5	-M12

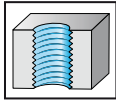

Stepped AMB Protostep Inox

 $\leq 1 \times D_N$

- HSS-E
- overall length L = long
- materials from 400 to 1100 N/mm² or 33 HRC
- for long-chipping materials
- three-stage

M

DIN 13

	P	M	K	N	S	H	O
vap		●●					

MAS 8 6HX

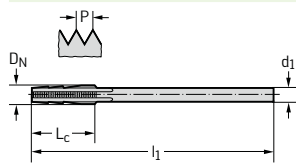

D _N	P mm	l ₁ mm	L _c mm	d ₁ h12 mm	N	VAP designation 20934
M 3	0,5	195	12	2,3	3	-M3
M 4	0,7	195	17	3	3	-M4

MAS 14, T-STAR 10 6HX

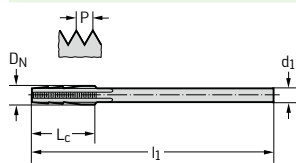

D _N	P mm	l ₁ mm	L _c mm	d ₁ h12 mm	N	VAP designation 20944
M 5	0,8	271	19	3,9	3	-M5
M 6	1	271	24	4,6	3	-M6
M 8	1,25	271	30	6,1	3	-M8
M 10	1,5	271	36	8	3	-M10
M 12	1,75	271	42	9,4	4	-M12

MAS 20, T-STAR 20 6HX

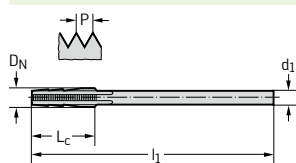

D _N	P mm	l ₁ mm	L _c mm	d ₁ h12 mm	N	VAP designation 20954
M 14	2	435	48	11,1	4	-M14
M 16	2	435	48	13,2	4	-M16

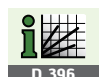
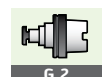

Machine tap Prototex® HSC



$\leq 1,5 \times D_N$

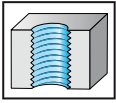

- solid carbide
- chamfer form B = 3.5 - 5 thread
- materials from 850 to 1400 N/mm² or 44 HRC
- for long-chipping materials
- cooling grooves on the shank

M

DIN 13

	P	M	K	N	S	H	O
TiCN	●●		●●				

DIN 371 6HX		D_N	P mm	l_1 js16 mm	L_c mm	l_3 ± 1 mm	d_1 h6 mm	\square h12 mm	l_g mm	N	TiCN designation 8021006
		M 6	1	80	19	30	6	4,9	8	3	-M6
		M 8	1,25	90	22	35	8	6,2	9	4	-M8
		M 10	1,5	100	24	39	10	8	11	4	-M10

DIN 376 6HX		D_N	P mm	l_1 js16 mm	L_c mm	l_3 ± 1 mm	d_1 h6 mm	\square h12 mm	l_g mm	N	TiCN designation 8026006
		M 12	1,75	110	23	-	9	7	10	5	-M12

Machine tap Paradur® Eco HT

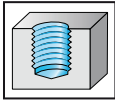
 $\leq 3 \times D_N$

- HSS-E-PM
- chamfer form C = 2 - 3 thread
- 45° helix angle
- enlarged core diameter
- long-chipping materials from 500 to 1250 N/mm² or 38 HRC
- suitable for minimum quantity lubrication

M
DIN 13

	P	M	K	N	S	H	O
TiN	●	●	●	●	●		●
THL	●	●	●	●	●		●

~DIN 371 6HX		D_N	P mm	l_1 js16 mm	L_c mm	l_3 ± 1 mm	d_1 h9 mm	\square h12 mm	l_g mm	N	TiN designation E2051305	THL designation E2051302
		M 2	0,4	45	4	7,6	2,8	2,1	5	3	-M2 ⁴	-M2 ⁴
		M 2,5	0,45	50	4	9,3	2,8	2,1	5	3	-M2.5 ⁴	-M2.5 ⁴
		M 3	0,5	56	6	11	3,5	2,7	6	3	-M3	-M3
		M 4	0,7	63	7	14,8	4,5	3,4	6	3	-M4	-M4
		M 5	0,8	70	8	20,7	6	4,9	8	3	-M5	-M5
		M 6	1	80	10	25	6	4,9	8	3	-M6	-M6
		M 8	1,25	90	12	35	8	6,2	9	3	-M8	-M8
		M 10	1,5	100	15	39	10	8	11	3	-M10	-M10

⁴without back taper

DIN 376 6HX		D_N	P mm	l_1 js16 mm	L_c mm	l_3 ± 1 mm	d_1 h9 mm	\square h12 mm	l_g mm	N	TiN designation E2056305	THL designation E2056302
		M 12	1,75	110	16	-	9	7	10	4	-M12	-M12
		M 14	2	110	20	-	11	9	12	4	-M14	-M14
		M 16	2	110	20	-	12	9	12	4	-M16	-M16
		M 18	2,5	125	25	-	14	11	14	4	-M18	-M18
		M 20	2,5	140	25	-	16	12	15	4	-M20	-M20
		M 24	3	160	30	-	18	14,5	17	4	-M24	-M24

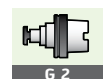

G 2



D 396

Machine tap Paradur® Eco HT



$\leq 3 \times D_N$

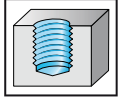

- HSS-E-PM
- chamfer form C = 2 - 3 thread
- 45° helix angle
- enlarged core diameter
- long-chipping materials from 500 to 1250 N/mm² or 38 HRC
- suitable for minimum quantity lubrication

M

DIN 13

	P	M	K	N	S	H	O
TiN	●	●	●	●	●		●
THL	●	●	●	●	●		●

~DIN 371 6GX		D_N	P mm	l_1 js16 mm	L_c mm	l_3 ± 1 mm	d_1 h9 mm	\square h12 mm	l_g mm	N	TiN designation E2053305	THL designation E2053302
		M 2	0,4	45	4	7,6	2,8	2,1	5	3	-M2 ⁴	-M2 ⁴
		M 2,5	0,45	50	4	9,3	2,8	2,1	5	3	-M2.5 ⁴	-M2.5 ⁴
		M 3	0,5	56	6	11	3,5	2,7	6	3	-M3	-M3
		M 4	0,7	63	7	14,8	4,5	3,4	6	3	-M4	-M4
		M 5	0,8	70	8	20,7	6	4,9	8	3	-M5	-M5
		M 6	1	80	10	25	6	4,9	8	3	-M6	-M6
		M 8	1,25	90	12	35	8	6,2	9	3	-M8	-M8
		M 10	1,5	100	15	39	10	8	11	3	-M10	-M10

⁴without back taper

DIN 376 6GX		D_N	P mm	l_1 js16 mm	L_c mm	l_3 ± 1 mm	d_1 h9 mm	\square h12 mm	l_g mm	N	TiN designation E2058305	THL designation E2058302
		M 12	1,75	110	16	-	9	7	10	4	-M12	-M12
		M 14	2	110	20	-	11	9	12	4	-M14	-M14
		M 16	2	110	20	-	12	9	12	4	-M16	-M16

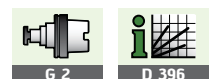

Machine tap Paradur® Eco HT

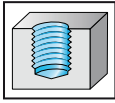
 $\leq 3 \times D_N$

- HSS-E-PM
- chamfer form C = 2 - 3 thread
- 45° helix angle
- enlarged core diameter
- long-chipping materials from 500 to 1250 N/mm² or 38 HRC
- for long-chipping materials

M

DIN 13

	P	M	K	N	S	H	O
THL	●	●	●	●	●		●

~DIN 371 6HX		D_N	P mm	l_1 js16 mm	L_c mm	l_3 ± 1 mm	d_1 h9 mm	\square h12 mm	l_g mm	N	THL designation E2051312
	M 4	0,7	63	7	14,8	4,5	3,4	6	3	-M4	
	M 5	0,8	70	8	20,7	6	4,9	8	3	-M5	
	M 6	1	80	10	25	6	4,9	8	3	-M6	
	M 8	1,25	90	12	35	8	6,2	9	3	-M8	
	M 10	1,5	100	15	39	10	8	11	3	-M10	

DIN 376 6HX		D_N	P mm	l_1 js16 mm	L_c mm	l_3 ± 1 mm	d_1 h9 mm	\square h12 mm	l_g mm	N	THL designation E2056312
	M 12	1,75	110	16	-	9	7	10	4	-M12	
	M 16	2	110	20	-	12	9	12	4	-M16	
	M 20	2,5	140	25	-	16	12	15	4	-M20	
	M 24	3	160	30	-	18	14,5	17	4	-M24	



Machine tap Paradur® Eco HT



$\leq 3 \times D_N$

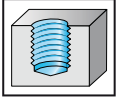

- HSS-E-PM
- chamfer form C = 2 - 3 thread
- 45° helix angle
- enlarged core diameter
- long-chipping materials from 500 to 1250 N/mm² or 38 HRC
- suitable for minimum quantity lubrication

M

DIN 13

	P	M	K	N	S	H	O
THL	●	●	●	●	●		●

DIN 371 6HX		D_N	P mm	l_1 js16 mm	L_c mm	l_3 ± 1 mm	d_1 h9 mm	\square h12 mm	l_g mm	N	THL designation E2051342
	M 8		1,25	90	12	35	8	6,2	9	3	-M8
	M 10		1,5	100	15	39	10	8	11	3	-M10

DIN 376 6HX		D_N	P mm	l_1 js16 mm	L_c mm	l_3 ± 1 mm	d_1 h9 mm	\square h12 mm	l_g mm	N	THL designation E2056342
	M 12		1,75	110	16	-	9	7	10	4	-M12
	M 16		2	110	20	-	12	9	12	4	-M16

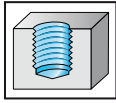

Machine tap Paradur® Eco HT

 $\leq 3x D_N$

- HSS-E-PM
- chamfer form C = 2 - 3 thread
- 45° helix angle - left-hand thread
- enlarged core diameter
- long-chipping materials from 500 to 1250 N/mm² or 38 HRC
- suitable for minimum quantity lubrication

M

DIN 13

	P	M	K	N	S	H	O
THL	●	●	●	●	●		●

~DIN 371 6HX		D_N	P mm	l_1 js16 mm	L_c mm	l_3 ± 1 mm	d_1 h9 mm	\square h12 mm	l_g mm	N	THL designation E2051382
		M 3 LH	0,5	56	6	11	3,5	2,7	6	3	-M3
		M 4 LH	0,7	63	7	14,8	4,5	3,4	6	3	-M4
		M 5 LH	0,8	70	8	20,7	6	4,9	8	3	-M5
		M 6 LH	1	80	10	25	6	4,9	8	3	-M6
		M 8 LH	1,25	90	12	35	8	6,2	9	3	-M8
		M 10 LH	1,5	100	15	39	10	8	11	3	-M10

DIN 376 6HX		D_N	P mm	l_1 js16 mm	L_c mm	l_3 ± 1 mm	d_1 h9 mm	\square h12 mm	l_g mm	N	THL designation E2056382
		M 12 LH	1,75	110	16	-	9	7	10	4	-M12
		M 14 LH	2	110	20	-	11	9	12	4	-M14
		M 16 LH	2	110	20	-	12	9	12	4	-M16
		M 18 LH	2,5	125	25	-	14	11	14	4	-M18
		M 20 LH	2,5	140	25	-	16	12	15	4	-M20



G 2



D 396

Machine tap Paradur® Eco HT



$\leq 3 \times D_N$

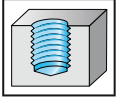

- HSS-E-PM
- chamfer form E = 1.5 - 2 thread
- 45° helix angle
- enlarged core diameter
- long-chipping materials from 500 to 1250 N/mm² or 38 HRC
- suitable for minimum quantity lubrication

M

DIN 13

	P	M	K	N	S	H	O
THL	●	●	●	●	●		●

~DIN 371 6HX		D_N	P mm	l_1 js16 mm	L_c mm	l_3 ± 1 mm	d_1 h9 mm	\square h12 mm	l_g mm	N	THL designation E2051802
	M 4		0,7	63	7	14,8	4,5	3,4	6	3	-M4
	M 5		0,8	70	8	20,7	6	4,9	8	3	-M5
	M 6		1	80	10	25	6	4,9	8	3	-M6
	M 8		1,25	90	12	35	8	6,2	9	4	-M8
	M 10		1,5	100	15	39	10	8	11	4	-M10

DIN 376 6HX		D_N	P mm	l_1 js16 mm	L_c mm	l_3 ± 1 mm	d_1 h9 mm	\square h12 mm	l_g mm	N	THL designation E2056802
	M 12		1,75	110	16	-	9	7	10	4	-M12
	M 16		2	110	20	-	12	9	12	5	-M16
	M 20		2,5	140	25	-	16	12	15	5	-M20
	M 24		3	160	30	-	18	14,5	17	5	-M24



Machine tap Paradur® H

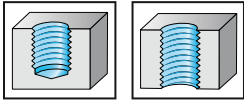

 $\leq 1,5 \times D_N$

- HSS-E
- chamfer form C = 2 - 3 thread
- materials from 200 to 1000 N/mm² or 32 HRC
- for long and short-chipping materials

M
DIN 13

	P	M	K	N	S	H	O
uncoated			●	●●			●
TiN			●	●●			●

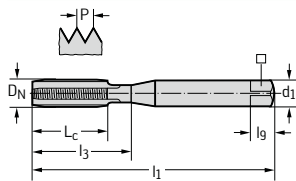
DIN 371 ISO2/6H



D _N	P mm	l ₁ js16 mm	L _c mm	l ₃ ±1 mm	d ₁ h9 mm	□ h12 mm	l _g mm	N	uncoated designation 20311	TiN designation 203115
M 1	0,25	40	5	-	2,5	2,1	5	3	-M1 ¹	
M 1,2	0,25	40	5	-	2,5	2,1	5	3	-M1.2 ¹	
M 1,4	0,3	40	6,5	-	2,5	2,1	5	3	-M1.4 ¹	
M 1,6	0,35	40	7	-	2,5	2,1	5	3	-M1.6 ¹	
M 1,7	0,35	40	7	-	2,5	2,1	5	3	-M1.7 ¹	
M 1,8	0,35	40	7	-	2,5	2,1	5	3	-M1.8 ¹	
M 2	0,4	45	6	9	2,8	2,1	5	3	-M2	
M 2,2	0,45	45	7	12	2,8	2,1	5	3	-M2.2	
M 2,3	0,4	45	7	12	2,8	2,1	5	3	-M2.3	
M 2,5	0,45	50	8	12,5	2,8	2,1	5	3	-M2.5	
M 2,6	0,45	50	8	12,5	2,8	2,1	5	3	-M2.6	
M 3	0,5	56	9	18	3,5	2,7	6	3	-M3	-M3
M 3,5	0,6	56	11	20	4	3	6	3	-M3.5	-M3.5
M 4	0,7	63	12	21	4,5	3,4	6	3	-M4	-M4
M 5	0,8	70	13	25	6	4,9	8	3	-M5	-M5
M 6	1	80	15	30	6	4,9	8	3	-M6	-M6
M 7	1	80	15	30	7	5,5	8	3	-M7	-M7
M 8	1,25	90	18	35	8	6,2	9	3	-M8	-M8
M 10	1,5	100	20	39	10	8	11	3	-M10	-M10

≤M 1,4: 5H, ≥ M1,6: ISO 2/6H

¹without neck

Machine tap Paradur® H

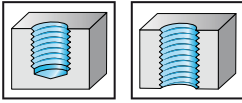
 $\leq 1,5 \times D_N$

- HSS-E
- chamfer form C = 2 - 3 thread
- materials from 200 to 1000 N/mm² or 32 HRC
- for long and short-chipping materials

M

DIN 13

	P	M	K	N	S	H	O
uncoated			●	●●			●

DIN 376	ISO2/6H	D_N	P mm	l_1 js16 mm	L_c mm	d_1 h9 mm	\square h12 mm	l_g mm	N	uncoated designation 20361
		M 2	0,4	45	6	1,4	1,12	4	3	-M2
		M 2,5	0,45	50	8	1,8	1,4	4	3	-M2.5
		M 3	0,5	56	9	2,2	1,8	4	3	-M3
		M 4	0,7	63	12	2,8	2,1	5	3	-M4
		M 5	0,8	70	13	3,5	2,7	6	3	-M5
		M 6	1	80	15	4,5	3,4	6	3	-M6
		M 8	1,25	90	18	6	4,9	8	3	-M8
		M 10	1,5	100	20	7	5,5	8	3	-M10
		M 12	1,75	110	23	9	7	10	3	-M12
		M 14	2	110	25	11	9	12	3	-M14
		M 16	2	110	25	12	9	12	3	-M16
		M 18	2,5	125	30	14	11	14	4	-M18
		M 20	2,5	140	30	16	12	15	4	-M20
		M 24	3	160	36	18	14,5	17	4	-M24
		M 27	3	160	36	20	16	19	4	-M27
		M 30	3,5	180	42	22	18	21	4	-M30
		M 33	3,5	180	42	25	20	23	4	-M33
		M 36	4	200	48	28	22	25	4	-M36
		M 42	4,5	200	54	32	24	27	4	-M42

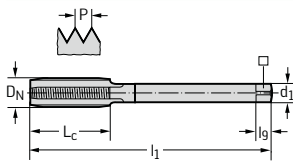

Machine tap Paradur® H AZ

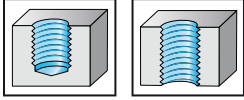
 $\leq 1,5 \times D_N$

- HSS-E
- chamfer form C = 2 - 3 thread
- materials from 200 to 1000 N/mm² or 32 HRC
- for long and short-chipping materials
- for thin-walled workpieces

M

DIN 13

	P	M	K	N	S	H	O
uncoated			●●	●●			●

DIN 371 ISO2/6H											uncoated designation 40311
D _N	P mm	l ₁ js16 mm	L _c mm	l ₃ ±1 mm	d ₁ h9 mm	□ h12 mm	l ₉ mm	N			
M 3	0,5	56	9	18	3,5	2,7	6	3			-M3
M 4	0,7	63	12	21	4,5	3,4	6	3			-M4
M 5	0,8	70	13	25	6	4,9	8	3			-M5
M 6	1	80	15	30	6	4,9	8	3			-M6
M 8	1,25	90	18	35	8	6,2	9	3			-M8
M 10	1,5	100	20	39	10	8	11	3			-M10

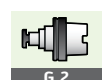
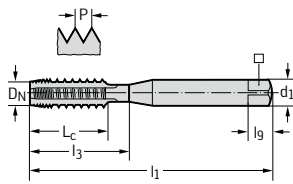

G 2



D 396

Machine tap Paradur® HT



$\leq 3,5 \times D_N$

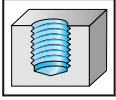

- HSS-E
- chamfer form C = 2 - 3 thread
- materials from 500 to 1400 N/mm² or 44 HRC
- for long and short-chipping materials

M

DIN 13

	P	M	K	N	S	H	O
uncoated	●●		●●	●			●
TiN	●●		●●	●			●

DIN 371 ISO2/6H		D_N	P mm	l_1 js16 mm	L_c mm	l_3 ± 1 mm	d_1 h9 mm	\square h12 mm	l_g mm	N	uncoated designation 203111	TIN designation 203115
		M 4	0,7	63	12	21	4,5	3,4	6	3		-M4
		M 5	0,8	70	13	25	6	4,9	8	3	-M5	-M5
		M 6	1	80	15	30	6	4,9	8	3	-M6	-M6
		M 8	1,25	90	18	35	8	6,2	9	3	-M8	-M8
		M 10	1,5	100	20	39	10	8	11	3	-M10	-M10

DIN 376 ISO2/6H		D_N	P mm	l_1 js16 mm	L_c mm	l_3 ± 1 mm	d_1 h9 mm	\square h12 mm	l_g mm	N	uncoated designation 203611	TIN designation 203615
		M 12	1,75	110	23	-	9	7	10	3	-M12	-M12

Machine tap Paradur® HT

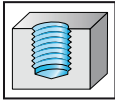
 $\leq 4 \times D_N$

- HSS-E
- overall length L = long
- chamfer form C = 2 - 3 thread
- materials from 500 to 1400 N/mm² or 44 HRC
- for long and short-chipping materials

M
DIN 13

	P	M	K	N	S	H	O
TiN	●●	●	●●	●	●	●	●

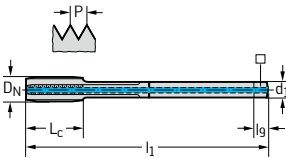
~DIN 376 IS02/6H		D_N	P mm	l_1 js16 mm	L_c mm	l_3 ± 1 mm	d_1 h9 mm	\square h12 mm	l_9 mm	N	TiN designation 2036155
		M 8	1,25	110	18	50	6	4,9	8	3	-M8
		M 10	1,5	125	20	60	7	5,5	8	3	-M10
		M 12	1,75	140	23	80	9	7	10	3	-M12
		M 14	2	140	25	80	11	9	12	3	-M14
		M 16	2	160	25	100	12	9	12	3	-M16
		M 20	2,5	180	30	120	16	12	15	3	-M20
		M 22	2,5	200	30	120	18	14,5	17	3	-M22
		M 24	3	200	36	120	18	14,5	17	4	-M24
		M 27	3	225	36	145	20	16	19	4	-M27
		M 30	3,5	250	42	160	22	18	21	4	-M30
		M 33	3,5	275	42	160	25	20	23	4	-M33
		M 36	4	300	48	180	28	22	25	5	-M36



Machine tap Paradur® N



$\leq 1,5 \times D_N$

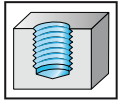

- HSS-E
- chamfer form C = 2 - 3 thread
- 15° helix angle
- materials from 200 to 1000 N/mm² or 32 HRC
- for long-chipping materials

M

DIN 13

	P	M	K	N	S	H	O
uncoated	●●		●●	●●			
TiN	●●		●●	●●			
TiCN	●●		●●	●●			

DIN 371 ISO2/6H											uncoated designation 20410	TIN designation 204105	TICN designation 2041006
D _N	P mm	l ₁ js16 mm	L _c mm	l ₃ ±1 mm	d ₁ h9 mm	□ h12 mm	l _g mm	N					
M 2	0,4	45	4	9	2,8	2,1	5	3			-M2		
M 2,5	0,45	50	4	12,5	2,8	2,1	5	3			-M2.5		
M 3	0,5	56	6	18	3,5	2,7	6	3			-M3	-M3	
M 3,5	0,6	56	6,5	20	4	3	6	3			-M3.5		
M 4	0,7	63	7	21	4,5	3,4	6	3			-M4	-M4	-M4
M 5	0,8	70	8	25	6	4,9	8	3			-M5	-M5	-M5
M 6	1	80	10	30	6	4,9	8	3			-M6	-M6	-M6
M 7	1	80	10	30	7	5,5	8	3			-M7		
M 8	1,25	90	12	35	8	6,2	9	3			-M8	-M8	-M8
M 10	1,5	100	15	39	10	8	11	3			-M10	-M10	-M10

DIN 376 ISO2/6H											uncoated designation 20460	TIN designation 204605	TICN designation 2046006
D _N	P mm	l ₁ js16 mm	L _c mm	l ₃ ±1 mm	d ₁ h9 mm	□ h12 mm	l _g mm	N					
M 3	0,5	56	6	-	2,2	1,8	4	3			-M3		
M 4	0,7	63	7	-	2,8	2,1	5	3			-M4		
M 5	0,8	70	8	-	3,5	2,7	6	3			-M5		
M 6	1	80	10	-	4,5	3,4	6	3			-M6		
M 8	1,25	90	12	-	6	4,9	8	3			-M8		
M 10	1,5	100	15	-	7	5,5	8	3			-M10		
M 12	1,75	110	16	-	9	7	10	3			-M12	-M12	-M12
M 14	2	110	20	-	11	9	12	3			-M14	-M14	-M14
M 16	2	110	20	-	12	9	12	3			-M16	-M16	-M16
M 18	2,5	125	25	-	14	11	14	4			-M18		
M 20	2,5	140	25	-	16	12	15	4			-M20	-M20	-M20
M 22	2,5	140	25	-	18	14,5	17	4			-M22		
M 24	3	160	30	-	18	14,5	17	4			-M24		
M 30	3,5	180	35	-	22	18	21	4			-M30		
M 36	4	200	40	-	28	22	25	4			-M36		

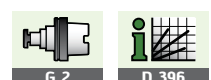

Machine tap Paradur® N

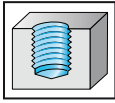

 $\leq 1,5 \times D_N$

- HSS-E
- chamfer form C = 2 - 3 thread
- 15° helix angle
- materials from 200 to 1000 N/mm² or 32 HRC
- for long-chipping materials

M
DIN 13

	P	M	K	N	S	H	O
uncoated	●●	●	●●	●●	●	●	●

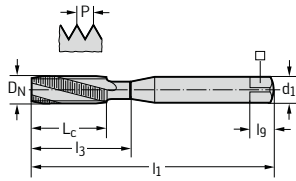
DIN 371 ISO3/6G		P	l_1 js16 mm	L_c mm	l_3 ± 1 mm	d_1 h9 mm	\square h12 mm	l_g mm	N	uncoated designation 20430
D_N		mm	mm	mm	mm	mm	mm	mm		
M 2		0,4	45	4	9	2,8	2,1	5	3	-M2
M 2,5		0,45	50	4	12,5	2,8	2,1	5	3	-M2.5
M 3		0,5	56	6	18	3,5	2,7	6	3	-M3
M 4		0,7	63	7	21	4,5	3,4	6	3	-M4
M 5		0,8	70	8	25	6	4,9	8	3	-M5
M 6		1	80	10	30	6	4,9	8	3	-M6
M 8		1,25	90	12	35	8	6,2	9	3	-M8
M 10		1,5	100	15	39	10	8	11	3	-M10



DIN 376 ISO3/6G		P	l_1 js16 mm	L_c mm	l_3 ± 1 mm	d_1 h9 mm	\square h12 mm	l_g mm	N	uncoated designation 20480
D_N		mm	mm	mm	mm	mm	mm	mm		
M 12		1,75	110	16	-	9	7	10	3	-M12
M 16		2	110	20	-	12	9	12	3	-M16

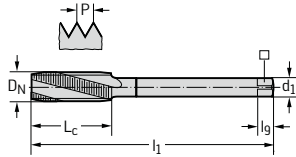

Machine tap Paradur® NH



$\leq 3,5 \times D_N$

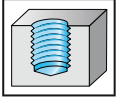

- HSS-E
- chamfer form C = 2 - 3 thread
- 15° helix angle
- materials from 400 to 1200 N/mm² or 36 HRC
- for long-chipping materials

M

DIN 13

	P	M	K	N	S	H	O
uncoated	●●		●●	●			●
TiN	●●		●●	●			●

DIN 371 ISO2/6H		D_N	P mm	l_1 js16 mm	L_c mm	l_3 ± 1 mm	d_1 h9 mm	\square h12 mm	l_g mm	N	uncoated designation 2041210	TiN designation 2041215
		M 4	0,7	63	12	21	4,5	3,4	6	3		-M4
		M 5	0,8	70	13	25	6	4,9	8	3	-M5	-M5
		M 6	1	80	15	30	6	4,9	8	3	-M6	-M6
		M 8	1,25	90	18	35	8	6,2	9	3	-M8	-M8
		M 10	1,5	100	20	39	10	8	11	3	-M10	-M10

DIN 376 ISO2/6H		D_N	P mm	l_1 js16 mm	L_c mm	l_3 ± 1 mm	d_1 h9 mm	\square h12 mm	l_g mm	N	uncoated designation 2046210	TiN designation 2046215
		M 12	1,75	110	23	-	9	7	10	4	-M12	-M12

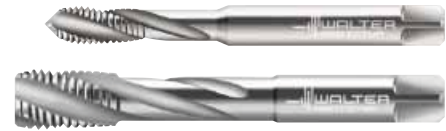
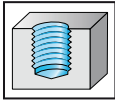

Machine tap Paradur® H 24

 $\leq 2,5 \times D_N$

- HSS-E-PM
- chamfer form C = 2 - 3 thread
- 24° helix angle
- materials from 500 to 1400 N/mm² or 44 HRC
- for long-chipping materials

M

DIN 13

	P	M	K	N	S	H	O
uncoated	●		●				

~DIN 371 6HX										
D_N	P mm	l_1 js16 mm	L_c mm	l_3 ± 1 mm	d_1 h9 mm	\square h12 mm	l_g mm	N	uncoated designation 204107	
M 3	0,5	56	11	-	3,5	2,7	6	3	-M3 ¹	
M 4	0,7	63	15	-	4,5	3,4	6	3	-M4 ¹	
M 5	0,8	70	18,5	-	6	4,9	8	3	-M5 ¹	
M 6	1	80	15	30	6	4,9	8	3	-M6	
M 8	1,25	90	18	38	8	6,2	9	3	-M8	
M 10	1,5	100	20	45	10	8	11	3	-M10	

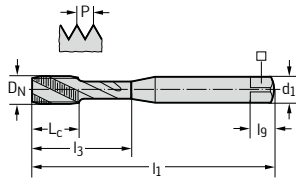
¹without neck

DIN 376 6HX										
D_N	P mm	l_1 js16 mm	L_c mm	l_3 ± 1 mm	d_1 h9 mm	\square h12 mm	l_g mm	N	uncoated designation 204607	
M 12	1,75	110	23	-	9	7	10	4	-M12	
M 16	2	110	25	-	12	9	12	4	-M16	

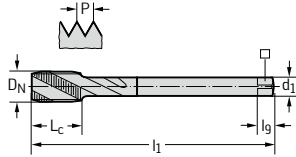

Machine tap Paradur® WSH



$\leq 3 \times D_N$

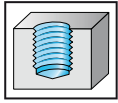

- HSS-E
- chamfer form C = 2 - 3 thread
- 45° helix angle
- materials from 200 to 1000 N/mm² or 32 HRC
- for long-chipping materials

M

DIN 13

	P	M	K	N	S	H	O
uncoated	●●		●	●			
TiN	●●		●	●			

DIN 371 ISO2/6H			l_1 js16 mm	L_c mm	l_3 ± 1 mm	d_1 h9 mm	\square h12 mm	l_g mm	N	uncoated designation 20517	TiN designation 205175
	M 1,6	0,35	40	6	-	2,5	2,1	5	2	-M1,6 ¹	
	M 2	0,4	45	4	9	2,8	2,1	5	3	-M2	-M2
	M 2,2	0,45	45	4	12	2,8	2,1	5	3	-M2,2	
	M 2,5	0,45	50	4	12,5	2,8	2,1	5	3	-M2,5	-M2,5
	M 2,6	0,45	50	4	12,5	2,8	2,1	5	3	-M2,6	
	M 3	0,5	56	6	18	3,5	2,7	6	3	-M3	-M3
	M 3,5	0,6	56	6,5	20	4	3	6	3	-M3,5	-M3,5
	M 4	0,7	63	7	21	4,5	3,4	6	3	-M4	-M4
	M 4,5	0,75	70	8	25	6	4,9	8	3	-M4,5	
	M 5	0,8	70	8	25	6	4,9	8	3	-M5	-M5
M 6	1	80	10	30	6	4,9	8	3	-M6	-M6	
M 7	1	80	10	30	7	5,5	8	3	-M7		
M 8	1,25	90	12	35	8	6,2	9	3	-M8	-M8	
M 10	1,5	100	15	39	10	8	11	3	-M10	-M10	

¹without neck

DIN 376 ISO2/6H			l_1 js16 mm	L_c mm	l_3 ± 1 mm	d_1 h9 mm	\square h12 mm	l_g mm	N	uncoated designation 20567	TiN designation 205675
	M 4	0,7	63	7	-	2,8	2,1	5	3	-M4	
	M 5	0,8	70	8	-	3,5	2,7	6	3	-M5	
	M 6	1	80	10	-	4,5	3,4	6	3	-M6	
	M 8	1,25	90	12	-	6	4,9	8	3	-M8	
	M 9	1,25	90	13	-	7	5,5	8	3	-M9	
	M 10	1,5	100	15	-	7	5,5	8	3	-M10	
	M 11	1,5	100	15	-	8	6,2	9	3	-M11	
	M 12	1,75	110	16	-	9	7	10	4	-M12	-M12
	M 14	2	110	20	-	11	9	12	4	-M14	-M14
	M 16	2	110	20	-	12	9	12	4	-M16	-M16
	M 18	2,5	125	25	-	14	11	14	4	-M18	-M18
	M 20	2,5	140	25	-	16	12	15	4	-M20	-M20
	M 22	2,5	140	25	-	18	14,5	17	4	-M22	
	M 24	3	160	30	-	18	14,5	17	4	-M24	
	M 27	3	160	30	-	20	16	19	4	-M27	
	M 30	3,5	180	35	-	22	18	21	4	-M30	
M 33	3,5	180	35	-	25	20	23	4	-M33		
M 36	4	200	40	-	28	22	25	4	-M36		



Machine tap
Paradur® WSH

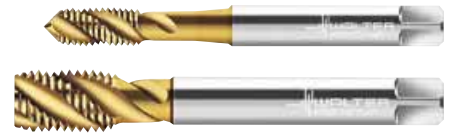

$\leq 3 \times D_N$

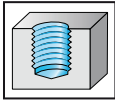

- HSS-E
- chamfer form C = 2 - 3 thread
- 45° helix angle
- materials from 200 to 1000 N/mm² or 32 HRC
- for long-chipping materials

M
DIN 13

	P	M	K	N	S	H	O
uncoated	●●		●	●			
TiN	●●		●	●			

DIN 371 IS03/6G		D_N	P mm	l_1 js16 mm	L_c mm	l_3 ± 1 mm	d_1 h9 mm	\square h12 mm	l_g mm	N	uncoated designation 20537	TiN designation 2053705
	M 2	0,4	45	4	9	2,8	2,1	5	3	-M2		
	M 2,3	0,4	45	4	12	2,8	2,1	5	3	-M2.3		
	M 2,5	0,45	50	4	12,5	2,8	2,1	5	3	-M2.5	-M2.5	
	M 3	0,5	56	6	18	3,5	2,7	6	3	-M3	-M3	
	M 3,5	0,6	56	6,5	20	4	3	6	3	-M3.5		
	M 4	0,7	63	7	21	4,5	3,4	6	3	-M4	-M4	
	M 5	0,8	70	8	25	6	4,9	8	3	-M5	-M5	
	M 6	1	80	10	30	6	4,9	8	3	-M6	-M6	
	M 8	1,25	90	12	35	8	6,2	9	3	-M8	-M8	
	M 10	1,5	100	15	39	10	8	11	3	-M10	-M10	

DIN 376 IS03/6G		D_N	P mm	l_1 js16 mm	L_c mm	l_3 ± 1 mm	d_1 h9 mm	\square h12 mm	l_g mm	N	uncoated designation 20587	TiN designation 2058705
	M 6	1	80	10	-	4,5	3,4	6	3	-M6		
	M 8	1,25	90	13	-	6	4,9	8	3	-M8		
	M 10	1,5	100	15	-	7	5,5	8	3	-M10		
	M 12	1,75	110	16	-	9	7	10	4	-M12	-M12	
	M 14	2	110	20	-	11	9	12	4	-M14		
	M 16	2	110	20	-	12	9	12	4	-M16	-M16	



Machine tap Paradur® WSH



$\leq 3 \times D_N$

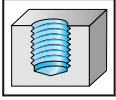

- HSS-E
- chamfer form C = 2 - 3 thread
- 45° helix angle
- materials from 200 to 1000 N/mm² or 32 HRC
- for long-chipping materials

M

DIN 13

	P	M	K	N	S	H	O
uncoated	●●		●	●			
TiN	●●		●	●			

DIN 371 7G		D_N	P mm	l_1 js16 mm	L_c mm	l_3 ± 1 mm	d_1 h9 mm	\square h12 mm	l_g mm	N	uncoated designation 20547	TiN designation 2054705
		M 2	0,4	45	4	9	2,8	2,1	5	3	-M2	
		M 2,5	0,45	50	4	12,5	2,8	2,1	5	3	-M2.5	
		M 3	0,5	56	6	18	3,5	2,7	6	3	-M3	-M3
		M 4	0,7	63	7	21	4,5	3,4	6	3	-M4	-M4
		M 5	0,8	70	8	25	6	4,9	8	3	-M5	-M5
		M 6	1	80	10	30	6	4,9	8	3	-M6	-M6
		M 8	1,25	90	12	35	8	6,2	9	3	-M8	-M8
		M 10	1,5	100	15	39	10	8	11	3	-M10	-M10

DIN 376 7G		D_N	P mm	l_1 js16 mm	L_c mm	l_3 ± 1 mm	d_1 h9 mm	\square h12 mm	l_g mm	N	uncoated designation 20597	TiN designation 2059705
		M 12	1,75	110	16	-	9	7	10	4	-M12	-M12
		M 16	2	110	20	-	12	9	12	4	-M16	-M16
		M 20	2,5	140	25	-	16	12	15	4	-M20	-M20
		M 24	3	160	30	-	18	14,5	17	4	-M24	-M24



Machine tap
Paradur® WSH



$\leq 3 \times D_N$

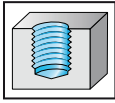

- HSS-E
- chamfer form C = 2 - 3 thread
- 45° helix angle
- materials from 200 to 1000 N/mm² or 32 HRC
- for long-chipping materials

M

DIN 13

	P	M	K	N	S	H	O
uncoated	●●	●	●	●	●	●	●

DIN 371 IS01/4H		D_N	P mm	l_1 js16 mm	L_c mm	l_3 ± 1 mm	d_1 h9 mm	\square h12 mm	l_g mm	N	uncoated designation 205174
	M 2	0,4	45	4	9	2,8	2,1	5	3	-M2	
	M 2,5	0,45	50	4	12,5	2,8	2,1	5	3	-M2.5	
	M 3	0,5	56	6	18	3,5	2,7	6	3	-M3	
	M 4	0,7	63	7	21	4,5	3,4	6	3	-M4	
	M 5	0,8	70	8	25	6	4,9	8	3	-M5	
	M 6	1	80	10	30	6	4,9	8	3	-M6	
	M 7	1	80	10	30	7	5,5	8	3	-M7	
	M 8	1,25	90	12	35	8	6,2	9	3	-M8	
	M 10	1,5	100	15	39	10	8	11	3	-M10	



Machine tap Paradur® WSH

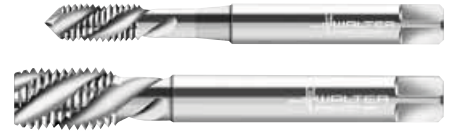

$\leq 3 \times D_N$

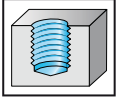

- HSS-E
- chamfer form C = 2 - 3 thread
- 45° helix angle
- left-hand thread
- materials from 200 to 1000 N/mm² or 32 HRC
- for long-chipping materials

M

DIN 13

	P	M	K	N	S	H	O
uncoated	●●		●	●			

DIN 371 ISO2/6H			l_1 js16 mm	L_c mm	l_3 ± 1 mm	d_1 h9 mm	\square h12 mm	l_g mm	N	uncoated designation 205178
D_N	P mm									
M 3 LH	0,5		56	6	18	3,5	2,7	6	3	-M3
M 4 LH	0,7		63	7	21	4,5	3,4	6	3	-M4
M 5 LH	0,8		70	8	25	6	4,9	8	3	-M5
M 6 LH	1		80	10	30	6	4,9	8	3	-M6
M 8 LH	1,25		90	12	35	8	6,2	9	3	-M8
M 10 LH	1,5		100	15	39	10	8	11	3	-M10

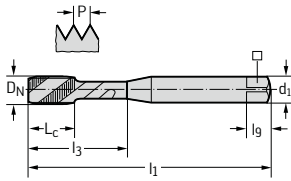

DIN 376 ISO2/6H			l_1 js16 mm	L_c mm	l_3 ± 1 mm	d_1 h9 mm	\square h12 mm	l_g mm	N	uncoated designation 205678
D_N	P mm									
M 12 LH	1,75		110	16	-	9	7	10	4	-M12
M 16 LH	2		110	20	-	12	9	12	4	-M16
M 20 LH	2,5		140	25	-	16	12	15	4	-M20
M 24 LH	3		160	30	-	18	14,5	17	4	-M24
M 30 LH	3,5		180	35	-	22	18	21	4	-M30

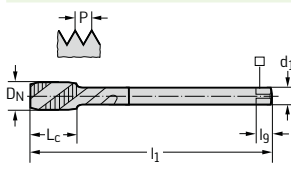

**Machine tap
Paradur® WSH**



$\leq 3 \times D_N$

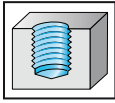

- HSS-E
- overall length XL = extra long
- chamfer form C = 2 - 3 thread
- 45° helix angle
- materials from 200 to 1000 N/mm² or 32 HRC
- for long-chipping materials

M

DIN 13

	P	M	K	N	S	H	O
uncoated	●●	●	●	●	●	●	●

~DIN 371 ISO2/6H

D_N	P mm	l_1 js16 mm	L_c mm	l_3 ± 1 mm	d_1 h9 mm	\square h12 mm	l_g mm	N	uncoated designation 205173
M 4	0,7	125	7	21	4,5	3,4	6	3	-M4
M 5	0,8	140	8	25	6	4,9	8	3	-M5
M 6	1	160	10	30	6	4,9	8	3	-M6

~DIN 376 ISO2/6H

D_N	P mm	l_1 js16 mm	L_c mm	l_3 ± 1 mm	d_1 h9 mm	\square h12 mm	l_g mm	N	uncoated designation 205673
M 8	1,25	180	12	-	6	4,9	8	3	-M8
M 10	1,5	200	15	-	7	5,5	8	3	-M10
M 12	1,75	220	16	-	9	7	10	4	-M12
M 14	2	220	20	-	11	9	12	4	-M14
M 16	2	220	20	-	12	9	12	4	-M16
M 18	2,5	250	25	-	14	11	14	4	-M18
M 20	2,5	280	25	-	16	12	15	4	-M20



Machine tap Paradur® WSH AZ



$\leq 3 \times D_N$

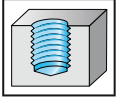

- HSS-E
- chamfer form C = 2 - 3 thread
- 45° helix angle
- materials from 200 to 1000 N/mm² or 32 HRC
- for long-chipping materials
- for thin-walled workpieces

M

DIN 13

	P	M	K	N	S	H	O
uncoated	●●		●				

DIN 371 ISO2/6H	D_N	P mm	l_1 js16 mm	L_c mm	$l_3 \pm 1$ mm	d_1 h9 mm	\square h12 mm	l_g mm	N	uncoated designation 40517
	M 3	0,5	56	6	18	3,5	2,7	6	3	-M3
	M 4	0,7	63	7	21	4,5	3,4	6	3	-M4
	M 5	0,8	70	8	25	6	4,9	8	3	-M5
	M 6	1	80	10	30	6	4,9	8	3	-M6
	M 8	1,25	90	12	35	8	6,2	9	3	-M8
	M 10	1,5	100	15	39	10	8	11	3	-M10

DIN 376 ISO2/6H	D_N	P mm	l_1 js16 mm	L_c mm	$l_3 \pm 1$ mm	d_1 h9 mm	\square h12 mm	l_g mm	N	uncoated designation 40567
	M 12	1,75	110	16	-	9	7	10	4	-M12

Machine tap Paradur® WTH

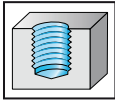

 $\leq 3,5 \times D_N$

- HSS-E
- chamfer form C = 2 - 3 thread
- 45° helix angle
- materials from 200 to 1000 N/mm² or 32 HRC
- for long-chipping materials

M
DIN 13

	P	M	K	N	S	H	O
uncoated	●●		●	●			
THL	●●		●	●			

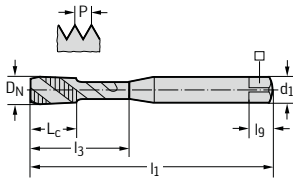
DIN 371 ISO2/6H		l_1 js16 mm	L_c mm	l_3 ± 1 mm	d_1 h9 mm	\square h12 mm	l_g mm	N	uncoated designation 20519	THL designation 2051902
D_N	P mm									
M 4	0,7	63	7	21	4,5	3,4	6	3	-M4	-M4
M 5	0,8	70	8	25	6	4,9	8	3	-M5	-M5
M 6	1	80	10	30	6	4,9	8	3	-M6	-M6
M 8	1,25	90	12	35	8	6,2	9	3	-M8	-M8
M 10	1,5	100	15	39	10	8	11	3	-M10	-M10



DIN 376 ISO2/6H		l_1 js16 mm	L_c mm	l_3 ± 1 mm	d_1 h9 mm	\square h12 mm	l_g mm	N	uncoated designation 20569	THL designation 2056902
D_N	P mm									
M 6	1	80	10	-	4,5	3,4	6	3	-M6	
M 8	1,25	90	12	-	6	4,9	8	3	-M8	
M 10	1,5	100	15	-	7	5,5	8	3	-M10	
M 12	1,75	110	16	-	9	7	10	3	-M12	-M12
M 14	2	110	20	-	11	9	12	3	-M14	
M 16	2	110	20	-	12	9	12	3	-M16	-M16
M 18	2,5	125	25	-	14	11	14	4	-M18	
M 20	2,5	140	25	-	16	12	15	4	-M20	-M20
M 22	2,5	140	25	-	18	14,5	17	4	-M22	
M 24	3	160	30	-	18	14,5	17	4	-M24	-M24
M 27	3	160	30	-	20	16	19	4	-M27	
M 30	3,5	180	35	-	22	18	21	4	-M30	-M30
M 33	3,5	180	35	-	25	20	23	4	-M33	
M 36	4	200	40	-	28	22	25	4	-M36	
M 39	4	200	40	-	32	24	27	4	-M39	
M 42	4,5	200	45	-	32	24	27	4	-M42	
M 45	4,5	220	45	-	36	29	32	4	-M45	
M 48	5	250	50	-	36	29	32	4	-M48	
M 52	5	250	50	-	40	32	35	5	-M52	
M 56	5,5	250	55	-	40	32	35	5	-M56	
M 60	5,5	280	55	-	45	35	38	5	-M60	
M 64	6	315	60	-	50	39	42	6	-M64	

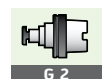
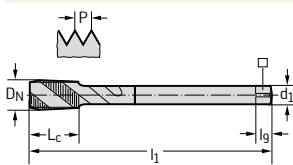

Machine tap Paradur® WTH



$\leq 3,5 \times D_N$

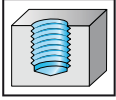

- HSS-E
- overall length L = long
- chamfer form C = 2 - 3 thread
- 45° helix angle
- materials from 200 to 1000 N/mm² or 32 HRC
- for long-chipping materials

M

DIN 13

	P	M	K	N	S	H	O
uncoated	●	●	●	●	●	●	●
THL	●	●	●	●	●	●	●

~DIN 371 ISO2/6H		D_N	P mm	l_1 js16 mm	L_c mm	l_3 ± 1 mm	d_1 h9 mm	\square h12 mm	l_g mm	N	uncoated designation 2051830	THL designation 2051832
	M 3	0,5	112	6	18	3,5	2,7	6	3	-M3	-M3	
	M 4	0,7	112	7	21	4,5	3,4	6	3	-M4	-M4	
	M 5	0,8	125	8	25	6	4,9	8	3	-M5	-M5	
	M 6	1	125	10	30	6	4,9	8	3	-M6	-M6	
	M 8	1,25	140	13	40	8	6,2	9	3	-M8	-M8	
	M 10	1,5	160	15	50	10	8	11	3	-M10	-M10	

~DIN 376 ISO2/6H		D_N	P mm	l_1 js16 mm	L_c mm	l_3 ± 1 mm	d_1 h9 mm	\square h12 mm	l_g mm	N	uncoated designation 2056830	THL designation 2056832
	M 8	1,25	140	13	-	6	4,9	8	3	-M8	-M8	
	M 10	1,5	160	15	-	7	5,5	8	3	-M10	-M10	
	M 12	1,75	180	16	-	9	7	10	3	-M12	-M12	
	M 14	2	180	20	-	11	9	12	3	-M14	-M14	
	M 16	2	200	20	-	12	9	12	3	-M16	-M16	
	M 20	2,5	224	25	-	16	12	15	4	-M20	-M20	

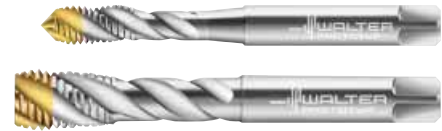
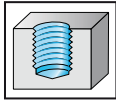

Machine tap Paradur® Secur

 $\leq 3 \times D_N$

- HSS-E-PM
- chamfer form C = 2 - 3 thread
- 45° helix angle
- enlarged core diameter
- long-chipping materials from 350 to 850 N/mm² or 25 HRC
- suitable for minimum quantity lubrication

M

DIN 13

	P	M	K	N	S	H	O
TiN	●●			●●			

~DIN 371 6HX		D_N	P mm	l_1 js16 mm	L_c mm	l_3 ± 1 mm	d_1 h9 mm	\square h12 mm	l_g mm	N	TiN designation E2051905
	M 4		0,7	63	7	14,8	4,5	3,4	6	3	-M4
	M 5		0,8	70	8	20,7	6	4,9	8	3	-M5
	M 6		1	80	10	25	6	4,9	8	3	-M6
	M 8		1,25	90	12	35	8	6,2	9	3	-M8
	M 10		1,5	100	15	39	10	8	11	3	-M10

DIN 376 6HX		D_N	P mm	l_1 js16 mm	L_c mm	l_3 ± 1 mm	d_1 h9 mm	\square h12 mm	l_g mm	N	TiN designation E2056905
	M 12		1,75	110	16	-	9	7	10	4	-M12
	M 16		2	110	20	-	12	9	12	4	-M16
	M 20		2,5	140	25	-	16	12	15	4	-M20
	M 24		3	160	30	-	18	14,5	17	4	-M24
	M 30		3,5	180	35	-	22	18	21	5	-M30



G 2



D 396

Machine tap Paradur® Short Chip soft



$\leq 3,5 \times D_N$

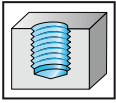

- HSS-E
- chamfer form C = 2 - 3 thread
- 15° helix angle
- enlarged core diameter
- materials from 350 to 850 N/mm² or 25 HRC
- for long-chipping materials

M

DIN 13

	P	M	K	N	S	H	O
TiN/vap	●●	●	●●	●	●	●	●

~DIN 371 ISO2/6H		D_N	P mm	l_1 js16 mm	L_c mm	l_3 ± 1 mm	d_1 h9 mm	\square h12 mm	l_g mm	N	TIN/VAP designation 2041055
		M 5	0,8	70	7	20,7	6	4,9	8	3	-M5
		M 6	1	80	8,5	25	6	4,9	8	3	-M6
		M 8	1,25	90	11	35	8	6,2	9	3	-M8
		M 10	1,5	100	14	39	10	8	11	3	-M10

~DIN 376 ISO2/6H		D_N	P mm	l_1 js16 mm	L_c mm	l_3 ± 1 mm	d_1 h9 mm	\square h12 mm	l_g mm	N	TIN/VAP designation 2046055
		M 12	1,75	110	17	-	9	7	10	3	-M12
		M 16	2	110	22,5	-	12	9	12	4	-M16
		M 20	2,5	140	28	-	16	12	15	4	-M20



Machine tap Paradur® STE

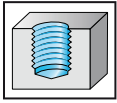

 $\leq 2,5 \times D_N$

- HSS-E
- chamfer form E = 1.5 - 2 thread
- 40° helix angle
- materials from 350 to 1200 N/mm² or 36 HRC
- for long-chipping materials

M
DIN 13

	P	M	K	N	S	H	O
uncoated	●	●	●	●			
THL	●	●	●	●			

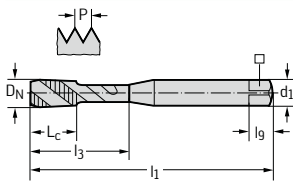
DIN 371 6HX



D_N	P mm	l_1 js16 mm	L_c mm	l_3 ± 1 mm	d_1 h9 mm	\square h12 mm	l_g mm	N	uncoated designation 205106	THL designation 2051062
M 4	0,7	63	7	21	4,5	3,4	6	3	-M4	-M4
M 5	0,8	70	8	25	6	4,9	8	3	-M5	-M5
M 6	1	80	10	30	6	4,9	8	3	-M6	-M6
M 8	1,25	90	12	35	8	6,2	9	4	-M8	-M8
M 10	1,5	100	15	39	10	8	11	4	-M10	-M10

DIN 376 6HX

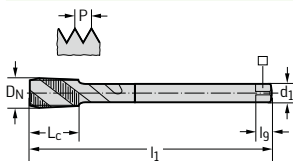

D_N	P mm	l_1 js16 mm	L_c mm	l_3 ± 1 mm	d_1 h9 mm	\square h12 mm	l_g mm	N	uncoated designation 205606	THL designation 2056062
M 12	1,75	110	16	-	9	7	10	4	-M12	-M12
M 16	2	110	20	-	12	9	12	5	-M16	-M16
M 20	2,5	140	25	-	16	12	15	5	-M20	-M20
M 24	3	160	30	-	18	14,5	17	5	-M24	-M24

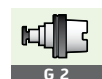

Machine tap Paradur Inox®



$\leq 2,5 \times D_N$

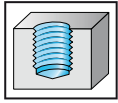

- HSS-E
- chamfer form C = 2 - 3 thread
- 40° helix angle
- enlarged core diameter
- materials from 350 to 1200 N/mm² or 36 HRC
- for long-chipping materials

M

DIN 13

	P	M	K	N	S	H	O
vap	●	●	●	●	●	●	●
TiN	●	●	●	●	●	●	●
TiCN	●	●	●	●	●	●	●

DIN 371 6HX

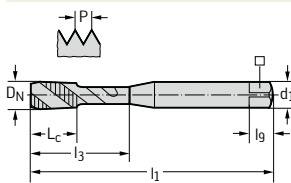

D _N	P mm	l ₁ js16 mm	L _c mm	l ₃ ±1 mm	d ₁ h9 mm	□ h12 mm	l _g mm	N	VAP designation 20513	TiN designation 205135	TiCN designation 2051306
M 1,6	0,35	40	6	-	2,5	2,1	5	3	-M1.6 ¹⁴		
M 1,7	0,35	40	6	-	2,5	2,1	5	3	-M1.7 ¹⁴		
M 1,8	0,35	40	6	-	2,5	2,1	5	3	-M1.8 ¹⁴		
M 2	0,4	45	4	9	2,8	2,1	5	3	-M2 ⁴	-M2	-M2 ⁴
M 2,5	0,45	50	4	12,5	2,8	2,1	5	3	-M2.5 ⁴	-M2.5	-M2.5 ⁴
M 3	0,5	56	6	18	3,5	2,7	6	3	-M3	-M3	-M3
M 3,5	0,6	56	6,5	20	4	3	6	3	-M3.5		
M 4	0,7	63	7	21	4,5	3,4	6	3	-M4	-M4	-M4
M 4,5	0,75	70	8	25	6	4,9	8	3	-M4.5		
M 5	0,8	70	8	25	6	4,9	8	3	-M5	-M5	-M5
M 6	1	80	10	30	6	4,9	8	3	-M6	-M6	-M6
M 7	1	80	10	30	7	5,5	8	3	-M7		
M 8	1,25	90	12	35	8	6,2	9	3	-M8	-M8	-M8
M 10	1,5	100	15	39	10	8	11	3	-M10	-M10	-M10

¹without neck

⁴without back taper

DIN 376 6HX

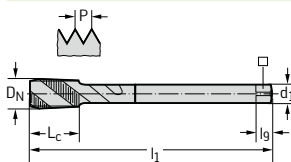

D _N	P mm	l ₁ js16 mm	L _c mm	l ₃ ±1 mm	d ₁ h9 mm	□ h12 mm	l _g mm	N	VAP designation 20563	TiN designation 205635	TiCN designation 2056306
M 6	1	80	10	-	4,5	3,4	6	3	-M6		-M6
M 8	1,25	90	12	-	6	4,9	8	3	-M8		-M8
M 10	1,5	100	15	-	7	5,5	8	3	-M10		-M10
M 12	1,75	110	16	-	9	7	10	4	-M12	-M12	-M12
M 14	2	110	20	-	11	9	12	4	-M14		
M 16	2	110	20	-	12	9	12	4	-M16	-M16	-M16
M 18	2,5	125	25	-	14	11	14	4	-M18		
M 20	2,5	140	25	-	16	12	15	4	-M20	-M20	-M20
M 22	2,5	140	25	-	18	14,5	17	4	-M22		
M 24	3	160	30	-	18	14,5	17	4	-M24		-M24
M 27	3	160	30	-	20	16	19	5	-M27		
M 30	3,5	180	35	-	22	18	21	5	-M30		-M30
M 33	3,5	180	35	-	25	20	23	5	-M33		
M 36	4	200	40	-	28	22	25	5	-M36		
M 42	4,5	200	45	-	32	24	27	5	-M42		



Machine tap Paradur Inox®



$\leq 2,5 \times D_N$

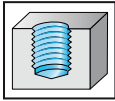

- HSS-E
- chamfer form C = 2 - 3 thread
- 40° helix angle
- enlarged core diameter
- materials from 350 to 1200 N/mm² or 36 HRC
- for long-chipping materials

M
DIN 13

	P	M	K	N	S	H	O
vap	●	●	●	■	■	■	■
TiCN	●	●	●	■	■	■	■

DIN 371 6GX

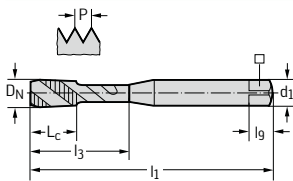

D _N	P mm	l ₁ js16 mm	L _c mm	l ₃ ±1 mm	d ₁ h9 mm	□ h12 mm	l _g mm	N	VAP designation 20533	TiCN designation 2053306
M 3	0,5	56	6	18	3,5	2,7	6	3	-M3	-M3
M 4	0,7	63	7	21	4,5	3,4	6	3	-M4	-M4
M 5	0,8	70	8	25	6	4,9	8	3	-M5	-M5
M 6	1	80	10	30	6	4,9	8	3	-M6	-M6
M 8	1,25	90	12	35	8	6,2	9	3	-M8	-M8
M 10	1,5	100	15	39	10	8	11	3	-M10	-M10

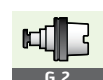

Machine tap Paradur Inox®



$\leq 2,5 \times D_N$

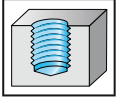

- HSS-E
- overall length XL = extra long
- chamfer form C = 2 - 3 thread
- 40° helix angle
- materials from 350 to 1200 N/mm² or 36 HRC
- for long-chipping materials

M

DIN 13

	P	M	K	N	S	H	O
THL	●●	●●	●				

~DIN 371 6HX		D_N	P mm	l_1 js16 mm	L_c mm	l_3 ± 1 mm	d_1 h9 mm	\square h12 mm	l_g mm	N	THL designation 2051332
	M 4		0,7	125	7	21	4,5	3,4	6	3	-M4
	M 5		0,8	140	8	25	6	4,9	8	3	-M5
	M 6		1	160	10	30	6	4,9	8	3	-M6

~DIN 376 6HX		D_N	P mm	l_1 js16 mm	L_c mm	l_3 ± 1 mm	d_1 h9 mm	\square h12 mm	l_g mm	N	THL designation 2056332
	M 8		1,25	180	12	-	6	4,9	8	3	-M8
	M 10		1,5	200	15	-	7	5,5	8	3	-M10
	M 12		1,75	220	16	-	9	7	10	4	-M12
	M 16		2	220	20	-	12	9	12	4	-M16
	M 20		2,5	280	25	-	16	12	15	4	-M20



Machine tap Paradur® WTH Inox 50

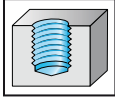

 $\leq 3,5 \times D_N$

- HSS-E
- chamfer form C = 2 - 3 thread
- 50° helix angle
- materials from 350 to 1200 N/mm² or 36 HRC
- for long-chipping materials

M
DIN 13

	P	M	K	N	S	H	O
vap	●●	●●	■	■	■	■	■
TiN	●●	●●	■	■	■	■	■

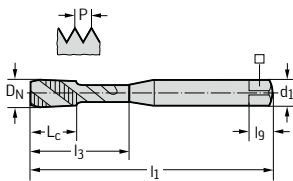
DIN 371 6HX



D _N	P mm	l ₁ js16 mm	L _c mm	l ₃ ±1 mm	d ₁ h9 mm	□ h12 mm	l _g mm	N	VAP designation 205199	TiN designation 2051995
M 1,6	0,35	40	6	-	2,5	2,1	5	2	-M1.6 ¹⁴	
M 2	0,4	45	4	9	2,8	2,1	5	3	-M2 ⁴	-M2
M 2,2	0,45	45	4	12	2,8	2,1	5	3	-M2.2 ⁴	
M 2,3	0,4	45	4	12	2,8	2,1	5	3	-M2.3 ⁴	
M 2,5	0,45	50	4	12,5	2,8	2,1	5	3	-M2.5 ⁴	
M 2,6	0,45	50	4	12,5	2,8	2,1	5	3	-M2.6 ⁴	
M 3	0,5	56	6	18	3,5	2,7	6	3	-M3	-M3
M 3,5	0,6	56	6,5	20	4	3	6	3	-M3.5	
M 4	0,7	63	7	21	4,5	3,4	6	3	-M4	-M4
M 5	0,8	70	8	25	6	4,9	8	3	-M5	-M5
M 6	1	80	10	30	6	4,9	8	3	-M6	-M6
M 7	1	80	10	30	7	5,5	8	3	-M7	
M 8	1,25	90	12	35	8	6,2	9	3	-M8	-M8
M 10	1,5	100	15	39	10	8	11	3	-M10	-M10

¹⁴without neck

⁴without back taper

DIN 376 6HX

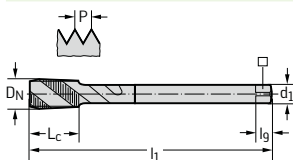

D _N	P mm	l ₁ js16 mm	L _c mm	l ₃ ±1 mm	d ₁ h9 mm	□ h12 mm	l _g mm	N	VAP designation 205699	TiN designation 2056995
M 6	1	80	10	-	4,5	3,4	6	3	-M6	
M 8	1,25	90	12	-	6	4,9	8	3	-M8	
M 10	1,5	100	15	-	7	5,5	8	3	-M10	-M10
M 12	1,75	110	16	-	9	7	10	4	-M12	-M12
M 14	2	110	20	-	11	9	12	4	-M14	-M14
M 16	2	110	20	-	12	9	12	4	-M16	-M16
M 18	2,5	125	25	-	14	11	14	4	-M18	-M18
M 20	2,5	140	25	-	16	12	15	4	-M20	-M20
M 24	3	160	30	-	18	14,5	17	4	-M24	-M24
M 27	3	160	30	-	20	16	19	5	-M27	
M 30	3,5	180	35	-	22	18	21	5	-M30	
M 33	3,5	180	35	-	25	20	23	5	-M33	
M 36	4	200	40	-	28	22	25	5	-M36	

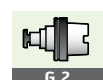

Machine tap Paradur Inox® 25



$\leq 1,5 \times D_N$

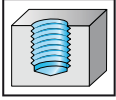

- HSS-E
- chamfer form E = 1.5 - 2 thread
- 25° helix angle
- materials from 350 to 1200 N/mm² or 36 HRC
- for long-chipping materials

M

DIN 13

	P	M	K	N	S	H	O
TiN	●●	●●	●●	●●	●●	●●	●●

~DIN 371 6HX		D_N	P mm	l_1 js16 mm	L_c mm	l_3 ± 1 mm	d_1 h9 mm	\square h12 mm	l_g mm	N	TiN designation 2051315
		M 5	0,8	70	8	19	6	4,9	8	4	-M5
		M 6	1	80	10	22	6	4,9	8	4	-M6
		M 8	1,25	90	13	28	8	6,2	9	5	-M8
		M 10	1,5	100	15	32	10	8	11	5	-M10

DIN 376 6HX		D_N	P mm	l_1 js16 mm	L_c mm	l_3 ± 1 mm	d_1 h9 mm	\square h12 mm	l_g mm	N	TiN designation 2056315
		M 12	1,75	110	16	-	9	7	10	5	-M12
		M 14	2	110	20	-	11	9	12	5	-M14
		M 16	2	110	20	-	12	9	12	5	-M16
		M 20	2,5	140	25	-	16	12	15	5	-M20



Machine tap Paradur® Synchronspeed



$\leq 2,5 \times D_N$

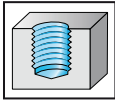

- HSS-E
- chamfer form C = 2 - 3 thread
- 40° helix angle
- long-chipping materials to 1300 N/mm² or 40 HRC
- only for synchronous machining (rigid tapping)
- suitable for minimum quantity lubrication

M
DIN 13

	P	M	K	N	S	H	O
THL	●	●	●	●	●		●
TiN/vap	●	●	●	●	●		●

~DIN 371 6HX		D_N	P mm	l_1 js16 mm	L_c mm	l_3 ± 1 mm	d_1 h6 mm	\square h12 mm	l_g mm	N	THL designation S2051302	TIN/VAP designation S2051305
Shank DIN 1835 B												
		M 2	0,4	70	4	7,6	6	4,9	8	3	-M2	-M2
		M 2,5	0,45	70	4,5	9,3	6	4,9	8	3	-M2.5	-M2.5
		M 3	0,5	70	5	11	6	4,9	8	3	-M3	-M3
		M 4	0,7	70	7	14,8	6	4,9	8	3	-M4	-M4
		M 5	0,8	70	8,5	20,7	6	4,9	8	3	-M5	-M5
		M 6	1	80	10,5	25	6	4,9	8	3	-M6	-M6
		M 8	1,25	90	13,5	35	8	6,2	9	3	-M8	-M8
		M 10	1,5	100	16	39	10	8	11	3	-M10	-M10

~DIN 376 6HX		D_N	P mm	l_1 js16 mm	L_c mm	l_3 ± 1 mm	d_1 h6 mm	\square h12 mm	l_g mm	N	THL designation S2056302	TIN/VAP designation S2056305
Shank DIN 1835 B												
		M 12	1,75	110	18,5	42	12	9	12	3	-M12	-M12
		M 14	2	110	21	49	14	11	14	3	-M14	-M14
		M 16	2	110	21	55	16	12	15	4	-M16	-M16
		M 20	2,5	140	26,5	-	16	12	15	4	-M20	-M20
		M 24	3	160	32	-	20	16	19	4	-M24	-M24



G 2



D 396

Machine tap Paradur® Synchronspeed



$\leq 2,5 \times D_N$

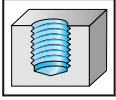

- HSS-E
- chamfer form C = 2 - 3 thread
- 40° helix angle
- long-chipping materials to 1300 N/mm² or 40 HRC
- only for synchronous machining (rigid tapping)
- suitable for minimum quantity lubrication

M

DIN 13

	P	M	K	N	S	H	O
THL	●	●	●	●	●		●
TiN/vap	●	●	●	●	●		●

~DIN 371 6HX		D_N	P mm	l_1 js16 mm	L_c mm	l_3 ± 1 mm	d_1 h6 mm	\square h12 mm	l_g mm	N	THL designation S2051312	TIN/VAP designation S2051315
Shank DIN 1835 B		M 5	0,8	70	8,5	20,7	6	4,9	8	3	-M5	-M5
		M 6	1	80	10,5	25	6	4,9	8	3	-M6	-M6
		M 8	1,25	90	13,5	35	8	6,2	9	3	-M8	-M8
		M 10	1,5	100	16	39	10	8	11	3	-M10	-M10

~DIN 376 6HX		D_N	P mm	l_1 js16 mm	L_c mm	l_3 ± 1 mm	d_1 h6 mm	\square h12 mm	l_g mm	N	THL designation S2056312	TIN/VAP designation S2056315
Shank DIN 1835 B		M 12	1,75	110	18,5	42	12	9	12	3	-M12	-M12
		M 14	2	110	21	49	14	11	14	3	-M14	-M14
		M 16	2	110	21	55	16	12	15	4	-M16	-M16
		M 20	2,5	140	26,5	-	16	12	15	4	-M20	-M20



Machine tap Paradur® Eco CI

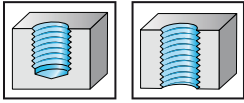

 $\leq 3 \times D_N$

- HSS-E-PM
- chamfer form C = 2 - 3 thread
- materials from 100 to 1000 N/mm² or 32 HRC
- for short-chipping materials
- suitable for minimum quantity lubrication
- Xtra-treat™ surface treatment

M
DIN 13

	P	M	K	N	S	H	O
nid			●●	●●			●●
TiCN			●●	●●			●●

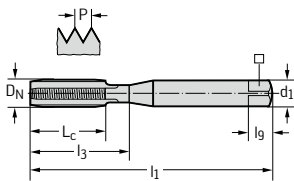
DIN 371 6HX



D _N	P mm	l ₁ js16 mm	L _c mm	l ₃ ±1 mm	d ₁ h9 mm	□ h12 mm	l _g mm	N	NID designation E20314	TiCN designation E2031406
M 3	0,5	56	9	18	3,5	2,7	6	3	-M3	-M3
M 4	0,7	63	12	21	4,5	3,4	6	3	-M4	-M4
M 5	0,8	70	13	25	6	4,9	8	4	-M5	-M5
M 6	1	80	15	30	6	4,9	8	4	-M6	-M6
M 7	1	80	15	30	7	5,5	8	4	-M7	-M7
M 8	1,25	90	18	35	8	6,2	9	4	-M8	-M8
M 9	1,25	90	18	35	9	7	10	4	-M9	-M9
M 10	1,5	100	20	39	10	8	11	4	-M10	-M10

DIN 376 6HX

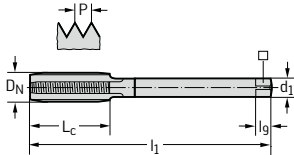

D _N	P mm	l ₁ js16 mm	L _c mm	l ₃ ±1 mm	d ₁ h9 mm	□ h12 mm	l _g mm	N	NID designation E20364	TiCN designation E2036406
M 12	1,75	110	23	-	9	7	10	4	-M12	-M12
M 14	2	110	25	-	11	9	12	4	-M14	-M14
M 16	2	110	25	-	12	9	12	4	-M16	-M16
M 18	2,5	125	30	-	14	11	14	4	-M18	-M18
M 20	2,5	140	30	-	16	12	15	4	-M20	-M20
M 22	2,5	140	30	-	18	14,5	17	4	-M22	-M22
M 24	3	160	36	-	18	14,5	17	5	-M24	-M24
M 30	3,5	180	42	-	22	18	21	5	-M30	-M30

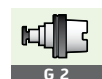

Machine tap Paradur® Eco CI



$\leq 3 \times D_N$

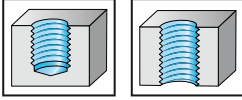

- HSS-E-PM
- chamfer form E = 1.5 - 2 thread
- materials from 100 to 1000 N/mm² or 32 HRC
- for short-chipping materials
- suitable for minimum quantity lubrication
- Xtra-treat™ surface treatment

M

DIN 13

	P	M	K	N	S	H	O
TiCN			●●	●●			●●

DIN 371 6HX		D_N	P mm	l_1 js16 mm	L_c mm	l_3 ± 1 mm	d_1 h9 mm	\square h12 mm	l_g mm	N	TiCN designation E2031466
	M 4		0,7	63	12	21	4,5	3,4	6	3	-M4
	M 5		0,8	70	13	25	6	4,9	8	4	-M5
	M 6		1	80	15	30	6	4,9	8	4	-M6
	M 8		1,25	90	18	35	8	6,2	9	4	-M8
	M 10		1,5	100	20	39	10	8	11	4	-M10

DIN 376 6HX		D_N	P mm	l_1 js16 mm	L_c mm	l_3 ± 1 mm	d_1 h9 mm	\square h12 mm	l_g mm	N	TiCN designation E2036466
	M 12		1,75	110	23	-	9	7	10	4	-M12
	M 16		2	110	25	-	12	9	12	4	-M16
	M 20		2,5	140	30	-	16	12	15	4	-M20
	M 24		3	160	36	-	18	14,5	17	5	-M24

Machine tap Paradur® Eco CI



$\leq 3 \times D_N$

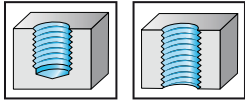

- HSS-E-PM
- overall length XL = extra long
- chamfer form C = 2 - 3 thread
- short-chipping materials from 100 to 1000 N/mm² or 32 HRC
- suitable for minimum quantity lubrication
- Xtra-treat™ surface treatment

M

DIN 13

	P	M	K	N	S	H	O
TiCN			●●	●●			●●

~DIN 371 6HX		D_N	P mm	l_1 js16 mm	L_c mm	l_3 ± 1 mm	d_1 h9 mm	\square h12 mm	l_g mm	N	TiCN designation E2031436
		M 4	0,7	125	12	21	4,5	3,4	6	3	-M4
		M 5	0,8	140	13	25	6	4,9	8	4	-M5
		M 6	1	160	15	30	6	4,9	8	4	-M6
		M 8	1,25	180	18	35	8	6,2	9	4	-M8
		M 10	1,5	200	20	39	10	8	11	4	-M10

~DIN 376 6HX		D_N	P mm	l_1 js16 mm	L_c mm	l_3 ± 1 mm	d_1 h9 mm	\square h12 mm	l_g mm	N	TiCN designation E2036436
		M 12	1,75	220	23	-	9	7	10	4	-M12
		M 16	2	220	25	-	12	9	12	4	-M16
		M 20	2,5	280	30	-	16	12	15	4	-M20



Machine tap Paradur® Eco CI



$\leq 3,5 \times D_N$

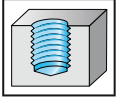

- HSS-E-PM
- chamfer form C = 2 - 3 thread
- materials from 100 to 1000 N/mm² or 32 HRC
- for short-chipping materials
- Xtra-treat™ surface treatment

M

DIN 13

	P	M	K	N	S	H	O
TiCN			●●	●●			●●

DIN 371 6HX		D_N	P mm	l_1 js16 mm	L_c mm	l_3 ± 1 mm	d_1 h9 mm	\square h12 mm	l_g mm	N	TiCN designation E2031416
	M 4		0,7	63	12	21	4,5	3,4	6	3	-M4
	M 5		0,8	70	13	25	6	4,9	8	4	-M5
	M 6		1	80	15	30	6	4,9	8	4	-M6
	M 7		1	80	15	30	7	5,5	8	4	-M7
	M 8		1,25	90	18	35	8	6,2	9	4	-M8
	M 10		1,5	100	20	39	10	8	11	4	-M10

DIN 376 6HX		D_N	P mm	l_1 js16 mm	L_c mm	l_3 ± 1 mm	d_1 h9 mm	\square h12 mm	l_g mm	N	TiCN designation E2036416
	M 12		1,75	110	23	-	9	7	10	4	-M12
	M 14		2	110	25	-	11	9	12	4	-M14
	M 16		2	110	25	-	12	9	12	4	-M16
	M 18		2,5	125	30	-	14	11	14	4	-M18
	M 20		2,5	140	30	-	16	12	15	4	-M20
	M 24		3	160	36	-	18	14,5	17	5	-M24

Machine tap
Paradur® Eco CI



$\leq 3,5 \times D_N$

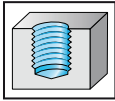

- HSS-E-PM
- chamfer form C = 2 - 3 thread
- materials from 100 to 1000 N/mm² or 32 HRC
- for short-chipping materials
- suitable for minimum quantity lubrication
- Xtra-treat™ surface treatment

M

DIN 13

	P	M	K	N	S	H	O
TiCN			●●	●●			●●

DIN 371 6HX

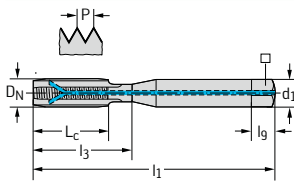

D _N	P mm	l ₁ js16 mm	L _c mm	l ₃ ±1 mm	d ₁ h9 mm	□ h12 mm	l _g mm	N	TiCN designation E2031446
M 6	1	80	15	30	6	4,9	8	4	-M6
M 8	1,25	90	18	35	8	6,2	9	4	-M8
M 10	1,5	100	20	39	10	8	11	4	-M10

DIN 376 6HX

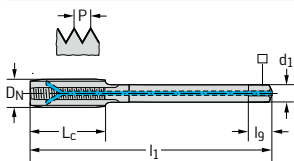

D _N	P mm	l ₁ js16 mm	L _c mm	l ₃ ±1 mm	d ₁ h9 mm	□ h12 mm	l _g mm	N	TiCN designation E2036446
M 12	1,75	110	23	-	9	7	10	4	-M12
M 16	2	110	25	-	12	9	12	4	-M16

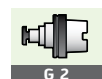

Machine tap Paradur® WLM



$\leq 3 \times D_N$

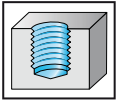

- HSS-E
- chamfer form C = 2 - 3 thread
- 35° helix angle
- materials from 200 to 700 N/mm² or 14 HRC
- for long-chipping materials

M

DIN 13

	P	M	K	N	S	H	O
uncoated				●●	●●		●●

DIN 371 ISO2/6H			l_1 js16 mm	L_c mm	l_3 ± 1 mm	d_1 h9 mm	\square h12 mm	l_g mm	N	uncoated designation 20516
D_N	P mm									
M 1,6	0,35		40	6	-	2,5	2,1	5	2	-M1.6 ¹
M 2	0,4		45	4	9	2,8	2,1	5	2	-M2
M 2,3	0,4		45	4	12	2,8	2,1	5	2	-M2.3
M 2,5	0,45		50	4	12,5	2,8	2,1	5	2	-M2.5
M 3	0,5		56	6	18	3,5	2,7	6	2	-M3
M 3,5	0,6		56	6,5	20	4	3	6	2	-M3.5
M 4	0,7		63	7	21	4,5	3,4	6	2	-M4
M 5	0,8		70	8	25	6	4,9	8	2	-M5
M 6	1		80	10	30	6	4,9	8	2	-M6
M 7	1		80	10	30	7	5,5	8	2	-M7
M 8	1,25		90	12	35	8	6,2	9	2	-M8
M 10	1,5		100	15	39	10	8	11	2	-M10

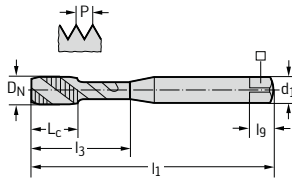

¹without neck

DIN 376 ISO2/6H			l_1 js16 mm	L_c mm	l_3 ± 1 mm	d_1 h9 mm	\square h12 mm	l_g mm	N	uncoated designation 20566
D_N	P mm									
M 6	1		80	10	-	4,5	3,4	6	2	-M6
M 8	1,25		90	12	-	6	4,9	8	2	-M8
M 10	1,5		100	15	-	7	5,5	8	2	-M10
M 12	1,75		110	16	-	9	7	10	3	-M12
M 14	2		110	20	-	11	9	12	3	-M14
M 16	2		110	20	-	12	9	12	3	-M16
M 18	2,5		125	25	-	14	11	14	3	-M18
M 20	2,5		140	25	-	16	12	15	3	-M20

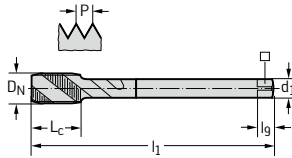

Machine tap Paradur® WLM



$\leq 3 \times D_N$

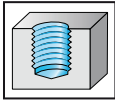

- HSS-E
- chamfer form C = 2 - 3 thread
- 35° helix angle
- materials from 200 to 700 N/mm² or 14 HRC
- for long-chipping materials

M
DIN 13

	P	M	K	N	S	H	O
uncoated				●●	●●		●●

DIN 371	ISO2/6H	D_N	P mm	l_1 js16 mm	L_c mm	l_3 ± 1 mm	d_1 h9 mm	\square h12 mm	l_9 mm	N	uncoated designation 20415
		M 3	0,5	56	6	18	3,5	2,7	6	3	-M3
		M 4	0,7	63	7	21	4,5	3,4	6	3	-M4
		M 5	0,8	70	8	25	6	4,9	8	3	-M5
		M 6	1	80	10	30	6	4,9	8	3	-M6
		M 7	1	80	10	30	7	5,5	8	3	-M7
		M 8	1,25	90	12	35	8	6,2	9	3	-M8
		M 10	1,5	100	15	39	10	8	11	3	-M10

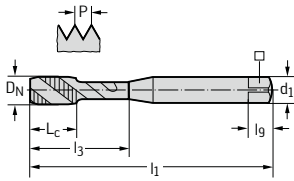

Machine tap Paradur® WLM



$\leq 3 \times D_N$

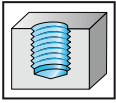

- HSS-E
- chamfer form C = 2 - 3 thread
- 35° helix angle
- materials from 200 to 700 N/mm² or 14 HRC
- for long-chipping materials

M

DIN 13

	P	M	K	N	S	H	O
uncoated				●●	●●		●●

DIN 371	ISO3/6G	D_N	P mm	l_1 js16 mm	L_c mm	l_3 ± 1 mm	d_1 h9 mm	\square h12 mm	l_g mm	N	uncoated designation 20536
		M 2	0,4	45	4	9	2,8	2,1	5	2	-M2
		M 2,5	0,45	50	4	12,5	2,8	2,1	5	2	-M2.5
		M 3	0,5	56	6	18	3,5	2,7	6	2	-M3
		M 3,5	0,6	56	6,5	20	4	3	6	2	-M3.5
		M 4	0,7	63	7	21	4,5	3,4	6	2	-M4
		M 5	0,8	70	8	25	6	4,9	8	2	-M5
		M 6	1	80	10	30	6	4,9	8	2	-M6
		M 8	1,25	90	12	35	8	6,2	9	2	-M8
		M 10	1,5	100	15	39	10	8	11	2	-M10

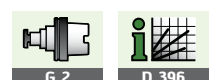
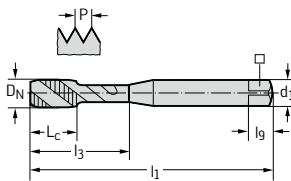

Machine tap Paradur® WLM Synchro.



$\leq 3 \times D_N$

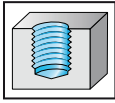

- HSS-E
- chamfer form C = 2 - 3 thread
- 45° helix angle
- materials to 700 N/mm² or 14 HRC
- for long-chipping materials
- only for synchronous machining (rigid tapping)

M
DIN 13

	P	M	K	N	S	H	O
uncoated	●	■	■	●●	●●		●●
CRN	●	■	■	●●	●●		●●

~DIN 371 ISO2/6H		D_N	P mm	l_1 js16 mm	L_c mm	l_3 ± 1 mm	d_1 h6 mm	\square h12 mm	l_g mm	N	uncoated designation S20516	CRN designation S2051604
Shank DIN 1835 B												
		M 3	0,5	70	2,5	18	6	4,9	8	2	-M3	-M3
		M 4	0,7	70	3,6	21	6	4,9	8	2	-M4	-M4
		M 5	0,8	70	4,4	25	6	4,9	8	2	-M5	-M5
		M 6	1	80	5,6	30	6	4,9	8	2	-M6	-M6
		M 8	1,25	90	6,9	35	8	6,2	9	2	-M8	-M8
		M 10	1,5	100	8,2	39	10	8	11	2	-M10	-M10

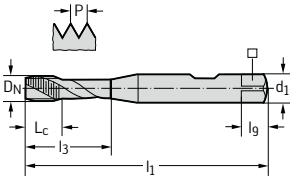

Machine tap Paradur® MS

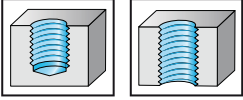
 $\leq 3,5 \times D_N$

- HSS-E
- chamfer form C = 2 - 3 thread
- materials from 350 to 850 N/mm² or 25 HRC
- for short-chipping materials

M

DIN 13

	P	M	K	N	S	H	O
uncoated				●●			●

DIN 371 ISO2/6H		D_N	P mm	l_1 js16 mm	L_c mm	l_3 ± 1 mm	d_1 h9 mm	\square h12 mm	l_g mm	N	uncoated designation 20315
	M 2	0,4	45	6	9	2,8	2,1	5	3	-M2	
	M 2,5	0,45	50	8	12,5	2,8	2,1	5	3	-M2.5	
	M 3	0,5	56	9	18	3,5	2,7	6	3	-M3	
	M 3,5	0,6	56	11	20	4	3	6	3	-M3.5	
	M 4	0,7	63	12	21	4,5	3,4	6	3	-M4	
	M 5	0,8	70	13	25	6	4,9	8	3	-M5	
	M 6	1	80	15	30	6	4,9	8	3	-M6	
	M 8	1,25	90	18	35	8	6,2	9	3	-M8	
	M 10	1,5	100	20	39	10	8	11	3	-M10	

**Machine tap
Paradur® AP**



$\leq 2 \times D_N$

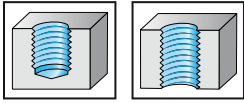

- HSS-E
- chamfer form C = 2 - 3 thread
- materials from 700 to 1500 N/mm² or 47 HRC
- for short-chipping materials
- for Ampco

M

DIN 13

	P	M	K	N	S	H	O
nit					●●		

DIN 371 6HX		D_N	P mm	l_1 js16 mm	L_c mm	l_3 ± 1 mm	d_1 h9 mm	\square h12 mm	l_g mm	N	NIT designation 20312
		M 3	0,5	56	9	18	3,5	2,7	6	3	-M3
		M 4	0,7	63	12	21	4,5	3,4	6	3	-M4
		M 5	0,8	70	13	25	6	4,9	8	3	-M5
		M 6	1	80	15	30	6	4,9	8	3	-M6
		M 8	1,25	90	18	35	8	6,2	9	3	-M8
		M 10	1,5	100	20	39	10	8	11	3	-M10

DIN 376 6HX		D_N	P mm	l_1 js16 mm	L_c mm	l_3 ± 1 mm	d_1 h9 mm	\square h12 mm	l_g mm	N	NIT designation 20362
		M 12	1,75	110	23	-	9	7	10	4	-M12
		M 16	2	110	25	-	12	9	12	4	-M16
		M 20	2,5	140	30	-	16	12	15	4	-M20



Machine tap Paradur® NI



$\leq 1,5 \times D_N$

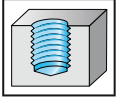

- HSS-E-PM
- chamfer form C = 2 - 3 thread
- 25° helix angle
- materials from 700 to 1400 N/mm² or 44 HRC
- for long-chipping materials

M

DIN 13

	P	M	K	N	S	H	O
uncoated	●				●●		

~DIN 371 6HX		D_N	P mm	l_1 js16 mm	L_c mm	l_3 ± 1 mm	d_1 h9 mm	\square h12 mm	l_g mm	N	uncoated designation 204102
		M 2	0,4	45	8	-	2,8	2,1	5	3	-M2 ¹
		M 2,5	0,45	50	9	-	2,8	2,1	5	3	-M2.5 ¹
		M 3	0,5	56	10	-	3,5	2,7	6	3	-M3 ¹
		M 3,5	0,6	56	12	-	4	3	6	3	-M3.5 ¹
		M 4	0,7	63	13	-	4,5	3,4	6	3	-M4 ¹
		M 5	0,8	70	16	-	6	4,9	8	3	-M5 ¹
		M 6	1	80	15	23	6	4,9	8	3	-M6
		M 8	1,25	90	18	29,5	8	6,2	9	3	-M8
		M 10	1,5	100	20	33,5	10	8	11	4	-M10

¹without neck

DIN 376 6HX		D_N	P mm	l_1 js16 mm	L_c mm	l_3 ± 1 mm	d_1 h9 mm	\square h12 mm	l_g mm	N	uncoated designation 204602
		M 12	1,75	110	23	-	9	7	10	4	-M12
		M 14	2	110	25	-	11	9	12	4	-M14
		M 16	2	110	25	-	12	9	12	4	-M16
		M 18	2,5	125	30	-	14	11	14	5	-M18
		M 20	2,5	140	30	-	16	12	15	5	-M20



Machine tap Paradur® NI



$\leq 1,5 \times D_N$

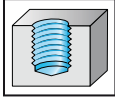

- HSS-E-PM
- chamfer form C = 2 - 3 thread
- 25° helix angle
- materials from 700 to 1400 N/mm² or 44 HRC
- for long-chipping materials

M

DIN 13

	P	M	K	N	S	H	O
uncoated	●				●●		

~DIN 371 4HX		D_N	P mm	l_1 js16 mm	L_c mm	l_3 ± 1 mm	d_1 h9 mm	\square h12 mm	l_g mm	N	uncoated designation 204104
		M 2	0,4	45	8	-	2,8	2,1	5	3	-M2 ¹
		M 3	0,5	56	10	-	3,5	2,7	6	3	-M3 ¹
		M 3,5	0,6	56	12	-	4	3	6	3	-M3.5 ¹
		M 4	0,7	63	13	-	4,5	3,4	6	3	-M4 ¹
		M 5	0,8	70	16	-	6	4,9	8	3	-M5 ¹
		M 6	1	80	15	23	6	4,9	8	3	-M6
		M 8	1,25	90	18	29,5	8	6,2	9	3	-M8
		M 10	1,5	100	20	33,5	10	8	11	4	-M10

¹without neck



G 2

D 396

Machine tap Paradur® NI 10



$\leq 1,5 \times D_N$

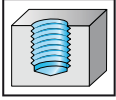

- HSS-E-PM
- chamfer form C = 2 - 3 thread
- 10° helix angle
- materials from 1000 to 1600 N/mm² or 49 HRC
- for long and short-chipping materials

M

DIN 13

	P	M	K	N	S	H	O
uncoated	●●			●	●●		
TiN	●●			●	●●		

~DIN 371 6HX		D_N	P mm	l_1 js16 mm	L_c mm	d_1 h9 mm	\square h12 mm	l_g mm	N	uncoated designation 204101	TIN designation 2041015
		M 3	0,5	56	8	3,5	2,7	6	3	-M3 ¹	-M3 ¹
		M 4	0,7	63	10,5	4,5	3,4	6	3	-M4 ¹	-M4 ¹
		M 5	0,8	70	13	6	4,9	8	3	-M5 ¹	-M5 ¹
		M 6	1	80	16	6	4,9	8	3	-M6 ¹	-M6 ¹
		M 8	1,25	90	20,5	8	6,2	9	3	-M8 ¹	-M8 ¹
		M 10	1,5	100	25,5	10	8	11	3	-M10 ¹	-M10 ¹
		M 12	1,75	110	30,5	12	9	12	4	-M12 ¹	-M12 ¹
		M 16	2	110	39,5	16	12	15	4	-M16 ¹	-M16 ¹

¹without neck

Machine tap Paradur® NI 10

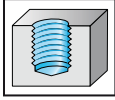
 $\leq 1,5 \times D_N$

- HSS-E-PM
- chamfer form C = 2 - 3 thread
- 10° helix angle
- materials from 1000 to 1600 N/mm² or 49 HRC
- for long and short-chipping materials

MJ

DIN ISO 5855-1
Outside diameter rounded

	P	M	K	N	S	H	O
uncoated	●●	●	●	●	●●	●	●

~DIN 371 4H	D_N	P mm	l_1 js16 mm	L_c mm	d_1 h9 mm	\square h12 mm	l_g mm	N	uncoated designation 2041014
	MJ3*0,5	0,5	56	8	3,5	2,7	6	3	-MJ3 ¹
	MJ4*0,7	0,7	63	10,5	4,5	3,4	6	3	-MJ4 ¹
	MJ5*0,8	0,8	70	13	6	4,9	8	3	-MJ5 ¹
	MJ6*1	1	80	15,5	6	4,9	8	3	-MJ6 ¹
	MJ8*1,25	1,25	90	20,5	8	6,2	9	3	-MJ8 ¹
	MJ10*1,5	1,5	100	25,5	10	8	11	3	-MJ10 ¹
	MJ12*1,75	1,75	110	30,5	12	9	12	4	-MJ12 ¹
	MJ16*2	2	110	39,5	16	12	15	4	-MJ16 ¹

¹without neck



Machine tap Paradur® TI



$\leq 2 \times D_N$

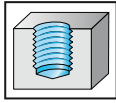

- HSS-E-PM
- chamfer form C = 2 - 3 thread
- 15° helix angle
- materials from 700 to 1400 N/mm² or 44 HRC
- for long-chipping materials

M

DIN 13

	P	M	K	N	S	H	O
uncoated	●●			●	●●		
TiCN	●●			●	●●		

~DIN 371 6HX		D_N	P mm	l_1 js16 mm	L_c mm	l_3 ± 1 mm	d_1 h9 mm	\square h12 mm	l_g mm	N	uncoated designation 20416	TiCN designation 2041606
		M 1	0,25	40	5	-	2,5	2,1	5	3	-M1 ¹	
		M 1,2	0,25	40	5	-	2,5	2,1	5	3	-M1.2 ¹	
		M 1,4	0,3	40	5	-	2,5	2,1	5	3	-M1.4 ¹	
		M 1,6	0,35	40	5	-	2,5	2,1	5	3	-M1.6 ¹	
		M 1,8	0,35	40	5	-	2,5	2,1	5	3	-M1.8 ¹	
		M 2	0,4	45	8	-	2,8	2,1	5	3	-M2 ¹	-M2
		M 2,2	0,45	45	8	-	2,8	2,1	5	3	-M2.2 ¹	
		M 2,5	0,45	50	9	-	2,8	2,1	5	3	-M2.5 ¹	-M2.5
		M 3	0,5	56	10	-	3,5	2,7	6	3	-M3 ¹	-M3
		M 3,5	0,6	56	12	-	4	3	6	3	-M3.5 ¹	
		M 4	0,7	63	13	-	4,5	3,4	6	3	-M4 ¹	-M4
		M 4,5	0,75	70	16	-	6	4,9	8	3	-M4.5 ¹	
		M 5	0,8	70	16	-	6	4,9	8	3	-M5 ¹	-M5
		M 6	1	80	15	23	6	4,9	8	3	-M6	-M6
		M 8	1,25	90	18	29,5	8	6,2	9	3	-M8	-M8
		M 10	1,5	100	20	33,5	10	8	11	3	-M10	-M10

¹without neck

DIN 376 6HX		D_N	P mm	l_1 js16 mm	L_c mm	l_3 ± 1 mm	d_1 h9 mm	\square h12 mm	l_g mm	N	uncoated designation 20466	TiCN designation 2046606
		M 12	1,75	110	23	-	9	7	10	4	-M12	-M12
		M 14	2	110	25	-	11	9	12	4	-M14	
		M 16	2	110	25	-	12	9	12	4	-M16	-M16
		M 20	2,5	140	30	-	16	12	15	4	-M20	
		M 24	3	160	36	-	18	14,5	17	5	-M24	
		M 27	3	160	36	-	20	16	19	5	-M27	
		M 30	3,5	180	42	-	22	18	21	5	-M30	
		M 33	3,5	180	42	-	25	20	23	5	-M33	
		M 36	4	200	48	-	28	22	25	5	-M36	

$\leq M 1,4$: 5HX, $\geq M 1,6$: 6HX

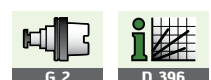

Machine tap Paradur® TI

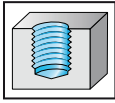
 $\leq 2 \times D_N$

- HSS-E-PM
- chamfer form C = 2 - 3 thread
- 15° helix angle
- materials from 700 to 1400 N/mm² or 44 HRC
- for long-chipping materials

MJ

DIN ISO 5855-1
Outside diameter rounded

	P	M	K	N	S	H	O
uncoated	●●			●	●●		

~DIN 371 4H											uncoated designation 204164
D_N	P mm	l_1 js16 mm	L_c mm	$l_3 \pm 1$ mm	d_1 h9 mm	\square h12 mm	l_g mm	N			
MJ3*0,5	0,5	56	10	-	3,5	2,7	6	3			-MJ3 ¹
MJ4*0,7	0,7	63	13	-	4,5	3,4	6	3			-MJ4 ¹
MJ5*0,8	0,8	70	16	-	6	4,9	8	3			-MJ5 ¹
MJ6*1	1	80	15	23	6	4,9	8	3			-MJ6
MJ8*1,25	1,25	90	18	29,5	8	6,2	9	3			-MJ8
MJ10*1,5	1,5	100	20	33,5	10	8	11	3			-MJ10

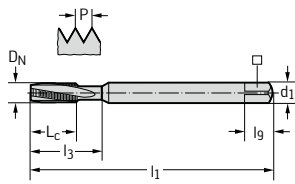
¹without neck

DIN 376 4H											uncoated designation 204664
D_N	P mm	l_1 js16 mm	L_c mm	$l_3 \pm 1$ mm	d_1 h9 mm	\square h12 mm	l_g mm	N			
MJ12*1,75	1,75	110	23	-	9	7	10	4			-MJ12
MJ16*2	2	110	25	-	12	9	12	4			-MJ16

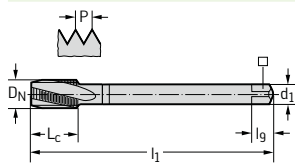

Machine tap Paradur® TI Plus



$\leq 2 \times D_N$

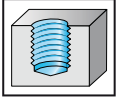

- HSS-E-PM
- chamfer form C = 2 - 3 thread
- 15° helix angle
- materials from 700 to 1400 N/mm² or 44 HRC
- for long-chipping materials

M

DIN 13

	P	M	K	N	S	H	O
ACN					●●		

~DIN 371 6HX		D_N	P mm	l_1 js16 mm	L_c mm	l_3 ± 1 mm	d_1 h9 mm	\square h12 mm	l_g mm	N	ACN designation 2041663
	M 2	0,4	45	8	-	2,8	2,1	5	3	-M2	
	M 2,5	0,45	50	9	-	2,8	2,1	5	3	-M2.5	
	M 3	0,5	56	10	-	3,5	2,7	6	3	-M3	
	M 3,5	0,6	56	12	-	4	3	6	3	-M3.5	
	M 4	0,7	63	13	-	4,5	3,4	6	3	-M4	
	M 5	0,8	70	16	-	6	4,9	8	3	-M5	
	M 6	1	80	15	23	6	4,9	8	3	-M6	
	M 8	1,25	90	18	29,5	8	6,2	9	3	-M8	
	M 10	1,5	100	20	33,5	10	8	11	3	-M10	

DIN 376 6HX		D_N	P mm	l_1 js16 mm	L_c mm	l_3 ± 1 mm	d_1 h9 mm	\square h12 mm	l_g mm	N	ACN designation 2046663
	M 12	1,75	110	23	-	9	7	10	4	-M12	
	M 16	2	110	25	-	12	9	12	4	-M16	
	M 20	2,5	140	30	-	16	12	15	4	-M20	

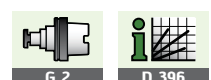

Machine tap Paradur® FT

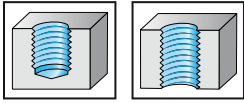

 $\leq 2 \times D_N$

- HSS-E-PM
- chamfer form D = 3.5 - 5 thread
- materials from 900 to 1700 N/mm² or 51 HRC
- for short-chipping materials

M

DIN 13

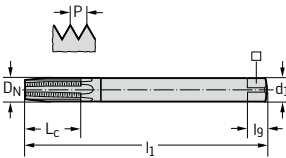
	P	M	K	N	S	H	O
uncoated					●		●

~DIN 371 ISO2/6H	D_N	P mm	l_1 js16 mm	L_c mm	d_1 h9 mm	\square h12 mm	l_g mm	N	uncoated designation 20316
	M 3	0,5	56	11	3,5	2,7	6	3	-M3 ¹
	M 4	0,7	63	13	4,5	3,4	6	5	-M4 ¹
	M 5	0,8	70	16	6	4,9	8	5	-M5 ¹
	M 6	1	80	20	6	4,9	8	5	-M6 ¹
	M 8	1,25	90	25	8	6,2	9	5	-M8 ¹
	M 10	1,5	100	30	10	8	11	5	-M10 ¹

¹without neck

Machine tap Paradur® HSC



$$\leq 2 \times D_N$$

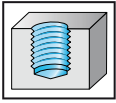

- solid carbide
- chamfer form C = 2 - 3 thread
- 15° helix angle
- for materials from 25 to 55 HRC
- for long and short-chipping materials

M

DIN 13

	P	M	K	N	S	H	O
TiCN	●●	●	●●	●●	●	●●	●

DIN 371 6HX		D_N	P mm	l_1 js16 mm	L_c mm	l_3 ± 1 mm	d_1 h6 mm	\square h12 mm	l_g mm	N	TiCN designation 8041056
		M 6	1	80	15	30	6	4,9	8	3	-M6
		M 8	1,25	90	20	35	8	6,2	9	3	-M8
		M 10	1,5	100	25	39	10	8	11	3	-M10

DIN 376 6HX		D_N	P mm	l_1 js16 mm	L_c mm	l_3 ± 1 mm	d_1 h6 mm	\square h12 mm	l_g mm	N	TiCN designation 8046056	
		M 12	1,75	110	23	-	9	7	10	4	-M12	

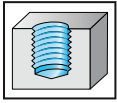

Machine tap Paradur® N

 $\leq 1,5 \times D_N$

- solid carbide
- chamfer form C = 2 - 3 thread
- 15° helix angle
- materials to 1500 N/mm² or 47 HRC
- for long and short-chipping materials

M
DIN 13

	P	M	K	N	S	H	O
uncoated			●●	●●			●
TiCN			●●	●●			●

~DIN 371 ISO2/6H		D_N	P mm	l_1 js16 mm	L_c mm	l_3 ± 1 mm	d_1 h6 mm	\square h12 mm	l_g mm	N	uncoated designation 80410	TiCN designation 8041006
		M 3	0,5	56	10	-	3,5	2,7	6	3	-M3 ¹	-M3 ¹
		M 4	0,7	63	13	-	4,5	3,4	6	3	-M4 ¹	-M4 ¹
		M 5	0,8	70	16	-	6	4,9	8	3	-M5 ¹	-M5 ¹
		M 6	1	80	19	30	6	4,9	8	3	-M6	-M6
		M 8	1,25	90	22	35	8	6,2	9	3	-M8	-M8
		M 10	1,5	100	24	39	10	8	11	3	-M10	-M10

¹without neck

Machine tap Paradur® N



$\leq 3,5 \times D_N$

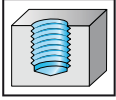

- solid carbide
- chamfer form C = 2 - 3 thread
- 15° helix angle
- materials to 1500 N/mm² or 47 HRC
- for long and short-chipping materials

M

DIN 13

	P	M	K	N	S	H	O
uncoated			●●	●●			●

~DIN 371 ISO2/6H		D_N	P mm	l_1 js16 mm	L_c mm	l_3 ± 1 mm	d_1 h6 mm	\square h12 mm	l_g mm	N	uncoated designation 804101
		M 5	0,8	70	16	-	6	4,9	8	3	-M5 ¹
		M 6	1	80	19	30	6	4,9	8	3	-M6
		M 8	1,25	90	22	35	8	6,2	9	3	-M8
		M 10	1,5	100	24	39	10	8	11	3	-M10

¹without neck

DIN 376 ISO2/6H		D_N	P mm	l_1 js16 mm	L_c mm	l_3 ± 1 mm	d_1 h6 mm	\square h12 mm	l_g mm	N	uncoated designation 804601
		M 12	1,75	110	23	-	9	7	10	3	-M12



**Machine tap
Paradur® GG**



$\leq 3,5 \times D_N$

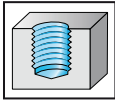

- solid carbide
- chamfer form C = 2 - 3 thread
- materials from 200 to 1500 N/mm² or 47 HRC
- for short-chipping materials

M
DIN 13

	P	M	K	N	S	H	O
uncoated			●●	●			●
TAFT			●●	●			●

~DIN 371 6HX		D_N	P mm	l_1 js16 mm	L_c mm	l_3 ± 1 mm	d_1 h6 mm	\square h12 mm	l_g mm	N	uncoated designation 803141	TAFT designation 8031417
		M 5	0,8	70	16	-	6	4,9	8	4	-M5 ¹	-M5 ¹
		M 6	1	80	19	30	6	4,9	8	4	-M6	-M6
		M 8	1,25	90	22	35	8	6,2	9	4	-M8	-M8
		M 10	1,5	100	24	39	10	8	11	4	-M10	-M10

¹without neck



Machine tap Paradur® Engine

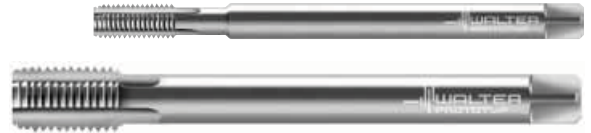

$\leq 3 \times D_N$

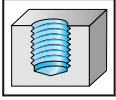

- solid carbide
- overall length L = long
- chamfer form E = 1.5 - 2 thread
- short-chipping materials from 200 to 1000 N/mm² or 32 HRC
- suitable for minimum quantity lubrication
- suitable coating according to requirement

M

DIN 13

	P	M	K	N	S	H	O
uncoated			●●	●●			

~DIN 371 6HX		D_N	P mm	l_1 js16 mm	L_c mm	l_3 ± 1 mm	d_1 h6 mm	\square h12 mm	l_g mm	N	uncoated designation 8031310
	M 6		1	80	15	30	6	4,9	8	3	-M6
	M 7		1	100	15	30	7	5,5	8	3	-M7
	M 8		1,25	120	18	35	8	6,2	9	3	-M8
	M 10		1,5	140	20	39	10	8	11	3	-M10

~DIN 374 6HX		D_N	P mm	l_1 js16 mm	L_c mm	l_3 ± 1 mm	d_1 h6 mm	\square h12 mm	l_g mm	N	uncoated designation 8036310
	M 12		1,75	140	23	-	9	7	10	4	-M12

Machine tap Paradur® HS

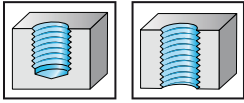

 $\leq 3 \times D_N$

- solid carbide
- chamfer form C = 2 - 3 thread
- for materials to 55 HRC
- for short-chipping materials

M
DIN 13

	P	M	K	N	S	H	O
uncoated			●	●●	●	●	●●
TiCN			●	●●	●	●	●●

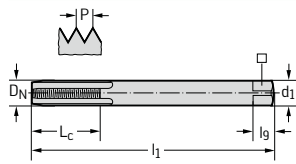
~DIN 371 ISO2/6H	D_N	P mm	l_1 js16 mm	L_c mm	d_1 h6 mm	\square h12 mm	l_g mm	N	uncoated	TiCN
									designation 80311	designation 8031106
	M 3	0,5	56	10	3,5	2,7	6	3	-M3 ¹	-M3 ¹
	M 4	0,7	63	13	4,5	3,4	6	3	-M4 ¹	-M4 ¹
	M 5	0,8	70	16	6	4,9	8	3	-M5 ¹	-M5 ¹
	M 6	1	80	20	6	4,9	8	3	-M6 ¹	-M6 ¹
	M 8	1,25	90	25	8	6,2	9	3	-M8 ¹	-M8 ¹
	M 10	1,5	100	30	10	8	11	3	-M10 ¹	-M10 ¹
	M 12	1,75	110	36	12	9	12	3	-M12 ¹	-M12 ¹

¹without neck

Machine tap Paradur® HS



$\leq 3,5 \times D_N$

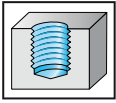

- solid carbide
- chamfer form C = 2 - 3 thread
- materials from 200 to 1700 N/mm² or 51 HRC
- for short-chipping materials

M

DIN 13

	P	M	K	N	S	H	O
TiCN			●	●●	●	●	●●

~DIN 371 ISO2/6H		D_N	P mm	l_1 js16 mm	L_c mm	l_3 ± 1 mm	d_1 h6 mm	\square h12 mm	l_9 mm	N	TiCN designation 8031116
		M 5	0,8	70	16	-	6	4,9	8	3	-M5 ¹
		M 6	1	80	19	30	6	4,9	8	3	-M6
		M 7	1	80	19	30	7	5,5	8	3	-M7
		M 8	1,25	90	22	35	8	6,2	9	3	-M8
		M 10	1,5	100	24	39	10	8	11	3	-M10

¹without neck

Machine tap Paradur® Hard

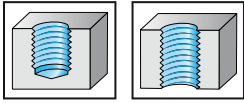
 $\leq 2 \times D_N$

- solid carbide
- chamfer form C = 2 - 3 thread
- for boring core hole 0.1 to 0.2 mm larger
- for materials from 50 to 63 HRC
- for short-chipping materials

M

DIN 13

	P	M	K	N	S	H	O
TiCN					●	●●	

~DIN 371 6HX		D_N	P mm	l_1 js16 mm	L_c mm	d_1 h6 mm	\square h12 mm	l_g mm	N	TiCN designation 8031806
		M 3	0,5	56	8	3,5	2,7	6	4	-M3 ¹
		M 4	0,7	63	11	4,5	3,4	6	5	-M4 ¹
		M 5	0,8	70	13,5	6	4,9	8	5	-M5 ¹
		M 6	1	80	16,5	6	4,9	8	5	-M6 ¹
		M 8	1,25	90	21,5	8	6,2	9	5	-M8 ¹
		M 10	1,5	100	27	10	8	11	5	-M10 ¹
		M 12	1,75	110	32	12	9	12	6	-M12 ¹
		M 16	2	110	41	16	12	15	6	-M16 ¹

¹without neck

Machine tap Paradur® Hard Plus



$\leq 2 \times D_N$

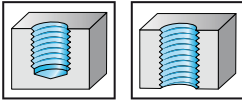

- solid carbide
- chamfer form D = 3.5 - 5 thread
- for boring core hole 0.1 to 0.2 mm larger
- for materials from 50 to 63 HRC
- for short-chipping materials

M

DIN 13

	P	M	K	N	S	H	O
TiCN					●	●●	

~DIN 371 6HX		D_N	P mm	l_1 js16 mm	L_c mm	d_1 h6 mm	\square h12 mm	l_g mm	N	TiCN designation 8031906
		M 3	0,5	56	9	3,5	2,7	6	4	-M3 ¹
		M 4	0,7	63	12	4,5	3,4	6	5	-M4 ¹
		M 5	0,8	70	14,5	6	4,9	8	5	-M5 ¹
		M 6	1	80	18	6	4,9	8	5	-M6 ¹
		M 8	1,25	90	23,5	8	6,2	9	5	-M8 ¹
		M 10	1,5	100	29	10	8	11	5	-M10 ¹
		M 12	1,75	110	34,5	12	9	12	6	-M12 ¹
M 16	2	110	44	16	12	15	6	-M16 ¹		

¹without neck

Machine tap Prototex® Eco HT

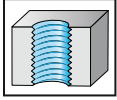
 $\leq 3,5 \times D_N$

- HSS-E-PM
- chamfer form B = 3.5 - 5 thread
- enlarged core diameter
- materials from 500 to 1350 N/mm² or 42 HRC
- for long-chipping materials
- suitable for minimum quantity lubrication

MF

DIN 13

	P	M	K	N	S	H	O
THL	●●	●●	●●	●●	●		●

DIN 374 6HX		D_N	P mm	l_1 js16 mm	L_c mm	d_1 h9 mm	\square h12 mm	l_g mm	N	THL designation E2126302
	M 6	0,75	80	15	4,5	3,4	6	3	-M6X0.75	
	M 8	1	90	18	6	4,9	8	3	-M8X1	
	M 10	1	90	20	7	5,5	8	3	-M10X1	
	M 10	1,25	100	20	7	5,5	8	3	-M10X1.25	
	M 12	1	100	21	9	7	10	4	-M12X1	
	M 12	1,25	100	21	9	7	10	4	-M12X1.25	
	M 12	1,5	100	21	9	7	10	4	-M12X1.5	
	M 14	1,5	100	21	11	9	12	4	-M14X1.5	
	M 16	1,5	100	21	12	9	12	4	-M16X1.5	
	M 18	1,5	110	24	14	11	14	4	-M18X1.5	
	M 20	1,5	125	24	16	12	15	4	-M20X1.5	
	M 22	1,5	125	24	18	14,5	17	4	-M22X1.5	

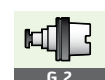

Machine tap Prototex® Eco HT



$\leq 3,5 \times D_N$

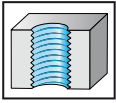

- HSS-E-PM
- chamfer form B = 3.5 - 5 thread
- enlarged core diameter
- materials from 500 to 1350 N/mm² or 42 HRC
- for long-chipping materials
- suitable for minimum quantity lubrication

MF

DIN 13

	P	M	K	N	S	H	O
THL	●	●	●	●	●		●

DIN 374 6HX		D_N	P mm	l_1 js16 mm	L_c mm	d_1 h9 mm	\square h12 mm	l_g mm	N	THL designation E2126342
	M 8	1	90	18	6	4,9	8	3	-M8X1	
	M 10	1	90	20	7	5,5	8	3	-M10X1	
	M 10	1,25	100	20	7	5,5	8	3	-M10X1.25	
	M 12	1	100	21	9	7	10	4	-M12X1	
	M 12	1,25	100	21	9	7	10	4	-M12X1.25	
	M 12	1,5	100	21	9	7	10	4	-M12X1.5	
	M 14	1,5	100	21	11	9	12	4	-M14X1.5	
	M 16	1,5	100	21	12	9	12	4	-M16X1.5	
	M 18	1,5	110	24	14	11	14	4	-M18X1.5	
	M 20	1,5	125	24	16	12	15	4	-M20X1.5	

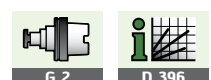

Machine tap Prototex®

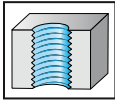
 $\leq 3 \times D_N$

- HSS-E
- chamfer form B = 3.5 - 5 thread
- materials from 200 to 700 N/mm² or 14 HRC
- for long-chipping materials

MF

DIN 13

	P	M	K	N	S	H	O
uncoated	●●			●●			●

DIN 371 ISO2/6H

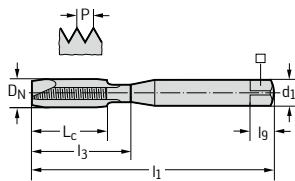

D _N	P mm	l ₁ js16 mm	L _c mm	l ₃ ±1 mm	d ₁ h9 mm	□ h12 mm	l _g mm	N	uncoated designation 21210
M 2	0,25	45	6	9	2,8	2,1	5	2	-M2X0.25
M 2,2	0,25	45	7	12	2,8	2,1	5	2	-M2.2X0.25
M 2,3	0,25	45	7	12	2,8	2,1	5	2	-M2.3X0.25
M 2,5	0,35	50	8	12,5	2,8	2,1	5	2	-M2.5X0.35
M 3	0,35	56	9	18	3,5	2,7	6	2	-M3X0.35
M 3	0,25	56	6	18	3,5	2,7	6	2	-M3X0.25
M 3,5	0,35	56	11	20	4	3	6	2	-M3.5X0.35
M 4	0,5	63	12	21	4,5	3,4	6	2	-M4X0.5
M 4	0,35	63	12	21	4,5	3,4	6	2	-M4X0.35
M 4,5	0,5	70	13	25	6	4,9	8	2	-M4.5X0.5
M 5	0,5	70	13	25	6	4,9	8	3	-M5X0.5
M 5	0,75	70	13	25	6	4,9	8	3	-M5X0.75
M 6	0,5	80	15	30	6	4,9	8	3	-M6X0.5
M 6	0,75	80	15	30	6	4,9	8	3	-M6X0.75
M 7	0,75	80	15	30	7	5,5	8	3	-M7X0.75
M 8	1	90	18	35	8	6,2	9	3	-M8X1
M 10	1	90	20	39	10	8	11	3	-M10X1

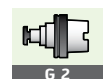

G 2



D 396

Machine tap Prototex® H



$\leq 3 \times D_N$

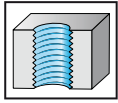

- HSS-E
- chamfer form B = 3.5 - 5 thread
- materials from 200 to 1000 N/mm² or 32 HRC
- for long-chipping materials

MF

DIN 13

	P	M	K	N	S	H	O
uncoated	●●		●	●●			●
TiN	●●		●	●●			●

DIN 374	ISO2/6H	D_N	P mm	l_1 js16 mm	L_c mm	d_1 h9 mm	\square h12 mm	l_g mm	N	uncoated designation 21360	TIN designation 2136005
		M 4	0,5	63	12	2,8	2,1	5	3	-M4X0.5	
		M 5	0,5	70	13	3,5	2,7	6	3	-M5X0.5	-M5X0.5
		M 6	0,5	80	15	4,5	3,4	6	3	-M6X0.5	-M6X0.5
		M 6	0,75	80	15	4,5	3,4	6	3	-M6X0.75	-M6X0.75
		M 8	0,5	80	15	6	4,9	8	3	-M8X0.5	-M8X0.5
		M 8	0,75	80	15	6	4,9	8	3	-M8X0.75	-M8X0.75
		M 8	1	90	18	6	4,9	8	3	-M8X1	-M8X1
		M 9	1	90	18	7	5,5	8	3	-M9X1	
		M 10	0,5	90	20	7	5,5	8	3	-M10X0.5	
		M 10	0,75	90	20	7	5,5	8	3	-M10X0.75	
		M 10	1	90	20	7	5,5	8	3	-M10X1	-M10X1
		M 10	1,25	100	20	7	5,5	8	3	-M10X1.25	-M10X1.25
		M 12	0,5	100	21	9	7	10	4	-M12X0.5	
		M 12	1	100	21	9	7	10	4	-M12X1	-M12X1
		M 12	1,25	100	21	9	7	10	4	-M12X1.25	
		M 12	1,5	100	21	9	7	10	4	-M12X1.5	-M12X1.5
		M 14	1	100	21	11	9	12	4	-M14X1	
		M 14	1,25	100	21	11	9	12	4	-M14X1.25	
		M 14	1,5	100	21	11	9	12	4	-M14X1.5	-M14X1.5
		M 16	1	100	21	12	9	12	4	-M16X1	
		M 16	1,5	100	21	12	9	12	4	-M16X1.5	-M16X1.5
		M 18	1	110	24	14	11	14	4	-M18X1	
		M 18	1,5	110	24	14	11	14	4	-M18X1.5	-M18X1.5
		M 18	2	125	30	14	11	14	4	-M18X2	
		M 20	1	125	24	16	12	15	4	-M20X1	
		M 20	1,5	125	24	16	12	15	4	-M20X1.5	-M20X1.5
		M 20	2	140	30	16	12	15	4	-M20X2	
		M 22	1	125	24	18	14,5	17	4	-M22X1	
		M 22	1,5	125	24	18	14,5	17	4	-M22X1.5	-M22X1.5
		M 22	2	140	26	18	14,5	17	4	-M22X2	
		M 24	1	140	26	18	14,5	17	4	-M24X1	
		M 24	1,5	140	26	18	14,5	17	4	-M24X1.5	-M24X1.5
		M 24	2	140	26	18	14,5	17	4	-M24X2	-M24X2
		M 25	1,5	140	26	18	14,5	17	4	-M25X1.5	
		M 26	1,5	140	26	18	14,5	17	4	-M26X1.5	
		M 27	1	140	26	20	16	19	4	-M27X1	
		M 27	1,5	140	26	20	16	19	4	-M27X1.5	
		M 27	2	140	26	20	16	19	4	-M27X2	-M27X2
		M 28	1,5	140	26	20	16	19	4	-M28X1.5	
		M 30	1	150	26	22	18	21	4	-M30X1	
		M 30	1,5	150	26	22	18	21	4	-M30X1.5	-M30X1.5
		M 30	2	150	26	22	18	21	4	-M30X2	-M30X2
		M 32	1,5	150	26	22	18	21	4	-M32X1.5	
		M 32	2	150	26	22	18	21	4	-M32X2	
		M 33	1,5	160	28	25	20	23	4	-M33X1.5	
		M 33	2	160	28	25	20	23	4	-M33X2	
		M 34	1,5	170	28	28	22	25	4	-M34X1.5	

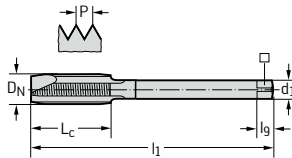

Continued



Machine tap Prototex® H

 $\leq 3 \times D_N$

Continued

	P	M	K	N	S	H	O
uncoated	●●		●	●●			●
TiN	●●		●	●●			●

DIN 374 ISO2/6H		D_N	P mm	l_1 js16 mm	L_c mm	d_1 h9 mm	\square h12 mm	l_g mm	N	uncoated designation 21360	TIN designation 2136005
	M 35	1,5	170	28	28	22	25	4	-M35X1.5		
	M 36	1,5	170	28	28	22	25	4	-M36X1.5		
	M 36	2	170	28	28	22	25	4	-M36X2		
	M 36	3	200	39	28	22	25	4	-M36X3		
	M 38	1,5	170	28	28	22	25	5	-M38X1.5		
	M 39	2	170	28	32	24	27	4	-M39X2		
	M 40	1,5	170	28	32	24	27	5	-M40X1.5		
	M 40	2	170	28	32	24	27	4	-M40X2		
	M 42	1,5	170	28	32	24	27	5	-M42X1.5		
	M 42	2	170	28	32	24	27	4	-M42X2		
	M 42	3	200	42	32	24	27	4	-M42X3		
	M 45	1,5	180	28	36	29	32	5	-M45X1.5		
	M 48	1,5	190	28	36	29	32	5	-M48X1.5		
	M 48	3	225	45	36	29	32	4	-M48X3		
	M 50	1,5	190	28	36	29	32	5	-M50X1.5		

Machine tap Prototex® H



$\leq 3 \times D_N$

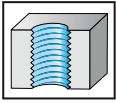

- HSS-E
- chamfer form B = 3.5 - 5 thread
- left-hand thread
- materials from 200 to 1000 N/mm² or 32 HRC
- for long-chipping materials

MF

DIN 13

	P	M	K	N	S	H	O
uncoated	●●		●	●●			●

DIN 374	ISO2/6H	D_N	P mm	l_1 js16 mm	L_c mm	d_1 h9 mm	\square h12 mm	l_g mm	N	uncoated designation 21268
		M 8 LH	1	90	18	6	4,9	8	3	-M8X1
		M 10 LH	1	90	20	7	5,5	8	3	-M10X1
		M 12 LH	1	100	21	9	7	10	4	-M12X1
		M 12 LH	1,5	100	21	9	7	10	4	-M12X1.5
		M 14 LH	1,5	100	21	11	9	12	4	-M14X1.5
		M 16 LH	1	100	21	12	9	12	4	-M16X1
		M 16 LH	1,5	100	21	12	9	12	4	-M16X1.5
		M 18 LH	1,5	110	24	14	11	14	4	-M18X1.5
		M 20 LH	1,5	125	24	16	12	15	4	-M20X1.5

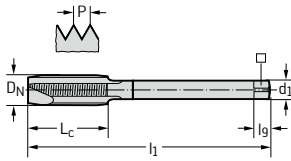

Machine tap Prototex® H

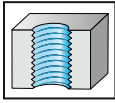
 $\leq 3 \times D_N$

- HSS-E
- chamfer form B = 3.5 - 5 thread
- materials from 200 to 1000 N/mm² or 32 HRC
- for long-chipping materials

MF

DIN 13

	P	M	K	N	S	H	O
uncoated	●●		●	●●			●
TiN	●●		●	●●			●

DIN 374 ISO3/6G

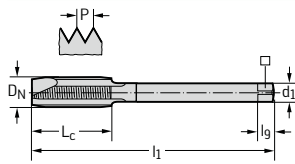

D _N	P mm	l ₁ js16 mm	L _c mm	d ₁ h9 mm	□ h12 mm	l _g mm	N	uncoated designation 21380	TiN designation 2138005
M 4	0,5	63	12	2,8	2,1	5	3	-M4X0.5	
M 5	0,5	70	13	3,5	2,7	6	3	-M5X0.5	
M 6	0,5	80	15	4,5	3,4	6	3	-M6X0.5	
M 6	0,75	80	15	4,5	3,4	6	3	-M6X0.75	
M 8	0,5	80	15	6	4,9	8	3	-M8X0.5	
M 8	0,75	80	15	6	4,9	8	3	-M8X0.75	
M 8	1	90	18	6	4,9	8	3	-M8X1	-M8X1
M 10	1	90	20	7	5,5	8	3	-M10X1	-M10X1
M 10	1,25	100	20	7	5,5	8	3	-M10X1.25	
M 12	1	100	21	9	7	10	4	-M12X1	-M12X1
M 12	1,25	100	21	9	7	10	4	-M12X1.25	
M 12	1,5	100	21	9	7	10	4	-M12X1.5	-M12X1.5
M 14	1,5	100	21	11	9	12	4	-M14X1.5	-M14X1.5
M 16	1,5	100	21	12	9	12	4	-M16X1.5	-M16X1.5
M 18	1,5	110	24	14	11	14	4	-M18X1.5	
M 20	1,5	125	24	16	12	15	4	-M20X1.5	
M 22	1,5	125	24	18	14,5	17	4	-M22X1.5	
M 24	1,5	140	26	18	14,5	17	4	-M24X1.5	

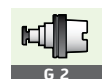

Machine tap Prototex Inox®



$\leq 3 \times D_N$

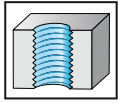

- HSS-E
- chamfer form B = 3.5 - 5 thread
- enlarged core diameter
- materials from 350 to 1200 N/mm² or 36 HRC
- for long-chipping materials

MF

DIN 13

	P	M	K	N	S	H	O
TiN	●	●	■	■	■	■	■
vap	●	●	■	■	■	■	■

DIN 371 6HX		P	l_1 js16	L_c	l_3 ± 1	d_1 h9	\square h12	l_g	N	TiN designation 2121305
D_N	P	mm	mm	mm	mm	mm	mm	mm		
M 5	0,5	70	13	25	6	4,9	8	3		-M5X0.5
M 6	0,5	80	15	30	6	4,9	8	3		-M6X0.5
M 6	0,75	80	15	30	6	4,9	8	3		-M6X0.75

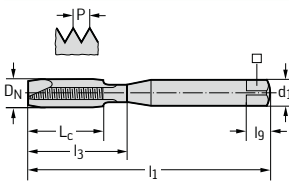

DIN 374 6HX		P	l_1 js16	L_c	l_3 ± 1	d_1 h9	\square h12	l_g	N	VAP designation 21263	TiN designation 2126305
D_N	P	mm	mm	mm	mm	mm	mm	mm			
M 8	0,5	80	15	-	6	4,9	8	3		-M8X0.5	-M8X0.5
M 8	0,75	80	15	-	6	4,9	8	3		-M8X0.75	-M8X0.75
M 8	1	90	18	-	6	4,9	8	3		-M8X1	-M8X1
M 10	0,75	90	20	-	7	5,5	8	3		-M10X0.75	
M 10	1	90	20	-	7	5,5	8	3		-M10X1	-M10X1
M 10	1,25	100	20	-	7	5,5	8	3		-M10X1.25	-M10X1.25
M 12	1	100	21	-	9	7	10	4		-M12X1	
M 12	1,25	100	21	-	9	7	10	4		-M12X1.25	
M 12	1,5	100	21	-	9	7	10	4		-M12X1.5	-M12X1.5
M 14	1	100	21	-	11	9	12	4		-M14X1	
M 14	1,5	100	21	-	11	9	12	4		-M14X1.5	-M14X1.5
M 16	1	100	21	-	12	9	12	4		-M16X1	
M 16	1,5	100	21	-	12	9	12	4		-M16X1.5	-M16X1.5
M 18	1,5	110	24	-	14	11	14	4		-M18X1.5	-M18X1.5
M 20	1,5	125	24	-	16	12	15	4		-M20X1.5	-M20X1.5
M 22	1,5	125	24	-	18	14,5	17	4		-M22X1.5	
M 24	1,5	140	26	-	18	14,5	17	4		-M24X1.5	

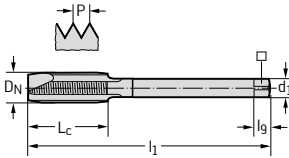

Machine tap Prototex Inox®



$\leq 3 \times D_N$

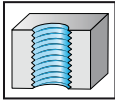

- HSS-E
- chamfer form B = 3.5 - 5 thread
- enlarged core diameter
- materials from 350 to 1200 N/mm² or 36 HRC
- for long-chipping materials

MF

DIN 13

	P	M	K	N	S	H	O
TiN	●●	●●	●●	●●	●●	●●	●●

DIN 374 6GX		D_N	P mm	l_1 js16 mm	L_c mm	d_1 h9 mm	h_{12} mm	l_g mm	N	TiN designation 2128305
		M 12	1,5	100	21	9	7	10	4	-M12X1.5
		M 14	1,5	100	21	11	9	12	4	-M14X1.5
		M 16	1,5	100	21	12	9	12	4	-M16X1.5
		M 20	1,5	125	24	16	12	15	4	-M20X1.5
		M 24	1,5	140	26	18	14,5	17	4	-M24X1.5



Machine tap Prototex® Synchronspeed



$\leq 3 \times D_N$

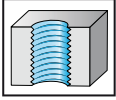

- HSS-E
- chamfer form B = 3.5 - 5 thread
- materials from to 1400 N/mm² or 44 HRC
- for long-chipping materials
- only for synchronous machining (rigid tapping)
- suitable for minimum quantity lubrication

MF

DIN 13

	P	M	K	N	S	H	O
TiN	●	●	●	●	●		●
THL	●	●	●	●	●		●

~DIN 374 6HX		D_N	P mm	l_1 js16 mm	L_c mm	l_3 ± 1 mm	d_1 h6 mm	\square h12 mm	l_g mm	N	TiN designation S2126305	THL designation S2126302
Shank DIN 1835 B												
		M 8	1	90	10	35	8	6,2	9	3	-M8X1	-M8X1
		M 10	1	90	10	39	10	8	11	3	-M10X1	-M10X1
		M 10	1,25	100	12,5	39	10	8	11	3	-M10X1.25	-M10X1.25
		M 12	1,25	100	12,5	42	12	9	12	3	-M12X1.25	-M12X1.25
		M 12	1,5	100	15	42	12	9	12	3	-M12X1.5	-M12X1.5
		M 14	1,5	100	15	49	14	11	14	3	-M14X1.5	-M14X1.5
		M 16	1,5	100	15	50	16	12	15	4	-M16X1.5	-M16X1.5

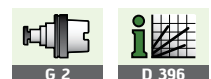
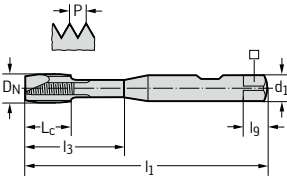

Machine tap Prototex® TiNi

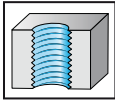
 $\leq 2 \times D_N$

- HSS-E-PM
- chamfer form B = 3.5 - 5 thread
- materials from 700 to 1400 N/mm² or 44 HRC
- for long-chipping materials

MF

DIN 13

	P	M	K	N	S	H	O
uncoated	●●	●●	●	●	●●		

~DIN 371 6HX		D_N	P mm	l_1 js16 mm	L_c mm	l_3 ± 1 mm	d_1 h9 mm	\square h12 mm	l_9 mm	N	uncoated designation 212161
	M 8	0,75	80	10	29	8	6,2	9	3	-M8X0.75	
	M 8	1	90	12	29	8	6,2	9	3	-M8X1	
	M 10	1	90	14	33	10	8	11	3	-M10X1	

DIN 374 6HX		D_N	P mm	l_1 js16 mm	L_c mm	l_3 ± 1 mm	d_1 h9 mm	\square h12 mm	l_9 mm	N	uncoated designation 212661
	M 10	1,25	100	20	-	7	5,5	8	3	-M10X1.25	
	M 12	1	100	16	-	9	7	10	4	-M12X1	
	M 12	1,25	100	21	-	9	7	10	4	-M12X1.25	
	M 12	1,5	100	21	-	9	7	10	4	-M12X1.5	
	M 14	1	100	16	-	11	9	12	4	-M14X1	
	M 14	1,5	100	21	-	11	9	12	4	-M14X1.5	
	M 16	1	100	18	-	12	9	12	4	-M16X1	



Machine tap Prototex® TiNi Plus



$\leq 2 \times D_N$

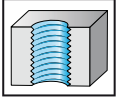

- HSS-E-PM
- chamfer form B = 3.5 - 5 thread
- materials from 700 to 1400 N/mm² or 44 HRC
- for long-chipping materials

MF

DIN 13

	P	M	K	N	S	H	O
ACN					●●		

~DIN 371 6HX		D_N	P mm	l_1 js16 mm	L_c mm	l_3 ± 1 mm	d_1 h9 mm	\square h12 mm	l_g mm	N	ACN designation 2121763
		M 6	0,75	80	15	23	6	4,9	8	3	-M6X0.75
		M 8	0,75	90	18	29,5	8	6,2	9	3	-M8X0.75
		M 8	1	90	18	29,5	8	6,2	9	3	-M8X1
		M 10	1	100	20	33,5	10	8	11	3	-M10X1

DIN 374 6HX		D_N	P mm	l_1 js16 mm	L_c mm	l_3 ± 1 mm	d_1 h9 mm	\square h12 mm	l_g mm	N	ACN designation 2126763
		M 12	1	100	21	-	9	7	10	4	-M12X1
		M 12	1,5	100	21	-	9	7	10	4	-M12X1.5
		M 14	1,5	100	21	-	11	9	12	4	-M14X1.5

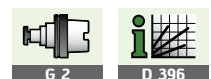

Machine tap
Prototex® HSC



$\leq 1,5 \times D_N$

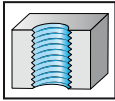

- solid carbide
- chamfer form B = 3.5 - 5 thread
- materials from 850 to 1400 N/mm² or 44 HRC
- for long-chipping materials
- cooling grooves on the shank

MF

DIN 13

	P	M	K	N	S	H	O
TiCN	●●		●●				

DIN 371 6HX

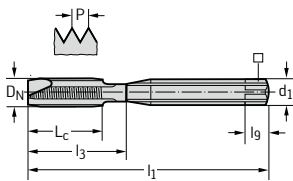

D _N	P mm	l ₁ js16 mm	L _c mm	l ₃ ±1 mm	d ₁ h6 mm	□ h12 mm	l _g mm	N	TiCN designation 8121006
M 6	0,75	80	19	30	6	4,9	8	3	-M6X0.75
M 8	1	90	22	35	8	6,2	9	4	-M8X1
M 10	1	90	24	39	10	8	11	4	-M10X1

DIN 374 6HX

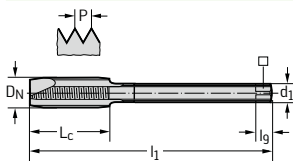

D _N	P mm	l ₁ js16 mm	L _c mm	l ₃ ±1 mm	d ₁ h6 mm	□ h12 mm	l _g mm	N	TiCN designation 8126006
M 12	1	100	21	-	9	7	10	5	-M12X1
M 12	1,5	100	21	-	9	7	10	5	-M12X1.5
M 14	1,5	100	21	-	11	9	12	5	-M14X1.5
M 16	1,5	100	21	-	12	9	12	5	-M16X1.5



Machine tap Paradur® Eco HT



$\leq 3 \times D_N$

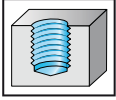

- HSS-E-PM
- chamfer form C = 2 - 3 thread
- 45° helix angle
- enlarged core diameter
- long-chipping materials from 500 to 1250 N/mm² or 38 HRC
- suitable for minimum quantity lubrication

MF

DIN 13

	P	M	K	N	S	H	O
THL	●●	●●	●●	●	●		●

DIN 374 6HX		D_N	P mm	l_1 js16 mm	L_c mm	d_1 h9 mm	\square h12 mm	l_g mm	N	THL designation E2156302
	M 6	0,75	80	10	4,5	3,4	6	3	3	-M6X0.75
	M 8	1	90	13	6	4,9	8	3	3	-M8X1
	M 10	1,25	100	15	7	5,5	8	3	3	-M10X1
	M 10	1	100	13	7	5,5	8	3	3	-M10X1.25
	M 12	1	100	13	9	7	10	4	4	-M12X1
	M 12	1,25	100	13	9	7	10	4	4	-M12X1.25
	M 12	1,5	100	13	9	7	10	4	4	-M12X1.5
	M 14	1,5	100	15	11	9	12	4	4	-M14X1.5
	M 16	1,5	100	15	12	9	12	4	4	-M16X1.5
	M 18	1,5	110	17	14	11	14	4	4	-M18X1.5
	M 20	1,5	125	17	16	12	15	4	4	-M20X1.5
M 22	1,5	125	18	18	14,5	17	5	5	-M22X1.5	

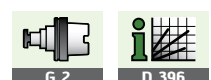

Machine tap
Paradur® Eco HT



$\leq 3 \times D_N$

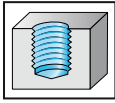

- HSS-E-PM
- chamfer form E = 1.5 - 2 thread
- 45° helix angle
- enlarged core diameter
- long-chipping materials from 500 to 1250 N/mm² or 38 HRC
- suitable for minimum quantity lubrication

MF

DIN 13

	P	M	K	N	S	H	O
THL	●	●	●	●	●		●

DIN 374 6HX		D_N	P mm	l_1 js16 mm	L_c mm	d_1 h9 mm	\square h12 mm	l_g mm	N	THL designation E2156802
		M 8	1	90	13	6	4,9	8	4	-M8X1
		M 10	1	90	12	7	5,5	8	5	-M10X1
		M 12	1,5	100	13	9	7	10	5	-M12X1.5
		M 14	1,5	100	15	11	9	12	5	-M14X1.5



Machine tap Paradur® Eco HT



$\leq 3 \times D_N$

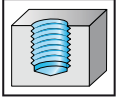

- HSS-E-PM
- chamfer form C = 2 - 3 thread
- 45° helix angle
- enlarged core diameter
- long-chipping materials from 500 to 1250 N/mm² or 38 HRC
- suitable for minimum quantity lubrication

MF

DIN 13

	P	M	K	N	S	H	O
THL	●●	●●	●●	●	●		●

DIN 374 6HX		D_N	P mm	l_1 js16 mm	L_c mm	d_1 h9 mm	\square h12 mm	l_g mm	N	THL designation E2156312
	M 8	1	90	13	6	4,9	8	3	-M8X1	
	M 10	1	90	12	7	5,5	8	3	-M10X1	
	M 10	1,25	100	15	7	5,5	8	3	-M10X1.25	
	M 12	1	100	13	9	7	10	4	-M12X1	
	M 12	1,25	100	13	9	7	10	4	-M12X1.25	
	M 12	1,5	100	13	9	7	10	4	-M12X1.5	
	M 14	1,5	100	15	11	9	12	4	-M14X1.5	
	M 16	1,5	100	15	12	9	12	4	-M16X1.5	
	M 18	1,5	110	17	14	11	14	4	-M18X1.5	
	M 20	1,5	125	17	16	12	15	4	-M20X1.5	

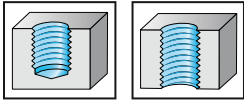

Machine tap Paradur® H

 $\leq 1,5 \times D_N$

- HSS-E
- chamfer form C = 2 - 3 thread
- materials from 200 to 1000 N/mm² or 32 HRC
- for long and short-chipping materials

MF

DIN 13

	P	M	K	N	S	H	O
uncoated			●	●●			●

DIN 371	ISO2/6H	D_N	P mm	l_1 js16 mm	L_c mm	l_3 ± 1 mm	d_1 h9 mm	\square h12 mm	l_g mm	N	uncoated designation 21311
		M 2	0,25	45	6	9	2,8	2,1	5	3	-M2X0.25
		M 2,2	0,25	45	7	12	2,8	2,1	5	3	-M2.2X0.25
		M 2,5	0,35	50	8	12,5	2,8	2,1	5	3	-M2.5X0.35
		M 3	0,35	56	9	18	3,5	2,7	6	3	-M3X0.35
		M 3,5	0,35	56	11	20	4	3	6	3	-M3.5X0.35
		M 4	0,35	63	12	21	4,5	3,4	6	3	-M4X0.35
		M 4	0,5	63	12	21	4,5	3,4	6	3	-M4X0.5
		M 5	0,35	70	13	25	6	4,9	8	3	-M5X0.35
		M 5	0,5	70	13	25	6	4,9	8	3	-M5X0.5
		M 6	0,75	80	15	30	6	4,9	8	3	-M6X0.75
		M 7	0,75	80	15	30	7	5,5	8	3	-M7X0.75

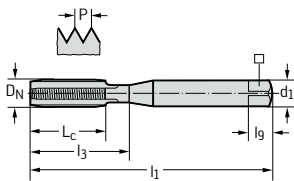

Machine tap Paradur® H



$\leq 1,5 \times D_N$

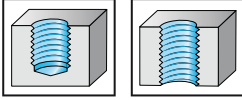

- HSS-E
- chamfer form C = 2 - 3 thread
- materials from 200 to 1000 N/mm² or 32 HRC
- for long and short-chipping materials

MF

DIN 13

	P	M	K	N	S	H	O
uncoated			●	●●			●

DIN 374	ISO2/6H	D_N	P mm	l_1 js16 mm	L_c mm	d_1 h9 mm	\square h12 mm	l_g mm	N	uncoated designation 21361
		M 4	0,5	63	12	2,8	2,1	5	3	-M4X0.5
		M 5	0,5	70	13	3,5	2,7	6	3	-M5X0.5
		M 6	0,5	80	15	4,5	3,4	6	3	-M6X0.5
		M 6	0,75	80	15	4,5	3,4	6	3	-M6X0.75
		M 7	0,5	80	15	5,5	4,3	7	3	-M7X0.5
		M 7	0,75	80	15	5,5	4,3	7	3	-M7X0.75
		M 8	0,5	80	15	6	4,9	8	3	-M8X0.5
		M 8	0,75	80	15	6	4,9	8	3	-M8X0.75
		M 8	1	90	18	6	4,9	8	3	-M8X1
		M 9	0,5	90	15	7	5,5	8	3	-M9X0.5
		M 9	0,75	90	15	7	5,5	8	3	-M9X0.75
		M 9	1	90	18	7	5,5	8	3	-M9X1
		M 10	0,5	90	20	7	5,5	8	3	-M10X0.5
		M 10	0,75	90	20	7	5,5	8	3	-M10X0.75
		M 10	1	90	20	7	5,5	8	3	-M10X1
		M 10	1,25	100	20	7	5,5	8	3	-M10X1.25
		M 11	1	90	20	8	6,2	9	3	-M11X1
		M 12	0,5	100	21	9	7	10	3	-M12X0.5
		M 12	0,75	100	21	9	7	10	4	-M12X0.75
		M 12	1	100	21	9	7	10	4	-M12X1
		M 12	1,25	100	21	9	7	10	4	-M12X1.25
		M 12	1,5	100	21	9	7	10	4	-M12X1.5
		M 14	1	100	21	11	9	12	4	-M14X1
		M 14	1,25	100	21	11	9	12	4	-M14X1.25
		M 14	1,5	100	21	11	9	12	4	-M14X1.5
		M 15	1,5	100	21	12	9	12	4	-M15X1.5
		M 16	1	100	21	12	9	12	4	-M16X1
		M 16	1,5	100	21	12	9	12	4	-M16X1.5
		M 18	1	110	24	14	11	14	4	-M18X1
		M 18	1,5	110	24	14	11	14	4	-M18X1.5
		M 18	2	125	30	14	11	14	4	-M18X2
		M 20	1	125	24	16	12	15	4	-M20X1
		M 20	1,5	125	24	16	12	15	4	-M20X1.5
		M 20	2	140	30	16	12	15	4	-M20X2
		M 22	1	125	24	18	14,5	17	4	-M22X1
		M 22	1,5	125	24	18	14,5	17	4	-M22X1.5
		M 22	2	140	26	18	14,5	17	4	-M22X2
		M 24	1	140	26	18	14,5	17	4	-M24X1
		M 24	1,5	140	26	18	14,5	17	4	-M24X1.5
		M 24	2	140	26	18	14,5	17	4	-M24X2
		M 25	1,5	140	26	18	14,5	17	4	-M25X1.5
		M 26	1,5	140	26	18	14,5	17	4	-M26X1.5
		M 27	1	140	26	20	16	19	4	-M27X1
		M 27	1,5	140	26	20	16	19	4	-M27X1.5
		M 27	2	140	26	20	16	19	4	-M27X2
		M 28	1,5	140	26	20	16	19	4	-M28X1.5
		M 28	2	140	26	20	16	19	4	-M28X2

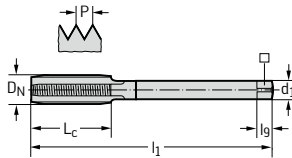

Continued



Machine tap Paradur® H

 $\leq 1,5 \times D_N$

Continued

	P	M	K	N	S	H	O
uncoated			●	●●			●

DIN 374 ISO2/6H		D_N	P mm	l_1 js16 mm	L_c mm	d_1 h9 mm	\square h12 mm	l_g mm	N	uncoated designation 21361
		M 30	1	150	26	22	18	21	4	-M30X1
		M 30	1,5	150	26	22	18	21	4	-M30X1.5
		M 30	2	150	26	22	18	21	4	-M30X2
		M 32	1,5	150	26	22	18	21	4	-M32X1.5
		M 33	1,5	160	28	25	20	23	4	-M33X1.5
		M 33	2	160	28	25	20	23	4	-M33X2
		M 34	1,5	170	28	28	22	25	4	-M34X1.5
		M 35	1,5	170	28	28	22	25	4	-M35X1.5
		M 36	1,5	170	28	28	22	25	4	-M36X1.5
		M 36	2	170	28	28	22	25	4	-M36X2
		M 36	3	200	39	28	22	25	4	-M36X3
		M 38	1,5	170	28	28	22	25	6	-M38X1.5
		M 39	1,5	170	28	32	24	27	6	-M39X1.5
		M 39	2	170	28	32	24	27	4	-M39X2
		M 39	3	200	42	32	24	27	4	-M39X3
		M 40	1,5	170	28	32	24	27	6	-M40X1.5
	M 40	2	170	28	32	24	27	4	-M40X2	
	M 42	1,5	170	28	32	24	27	6	-M42X1.5	
	M 42	2	170	28	32	24	27	4	-M42X2	
	M 42	3	200	42	32	24	27	4	-M42X3	
	M 45	1,5	180	28	36	29	32	6	-M45X1.5	
	M 45	2	180	30	36	29	32	6	-M45X2	
	M 45	3	200	42	36	29	32	4	-M45X3	
	M 48	1,5	190	28	36	29	32	6	-M48X1.5	
	M 48	2	190	30	36	29	32	6	-M48X2	
	M 48	3	225	45	36	29	32	4	-M48X3	
	M 50	1,5	190	28	36	29	32	6	-M50X1.5	
	M 50	2	190	30	36	29	32	6	-M50X2	
	M 52	1,5	190	29	40	32	35	6	-M52X1.5	
	M 52	2	190	32	40	32	35	6	-M52X2	
	M 52	3	225	45	40	32	35	6	-M52X3	

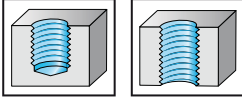

Machine tap Paradur® H

 $\leq 1,5 \times D_N$

- HSS-E
- chamfer form C = 2 - 3 thread
- left-hand thread
- materials from 200 to 1000 N/mm² or 32 HRC
- for long and short-chipping materials

MF

DIN 13

	P	M	K	N	S	H	O
uncoated			●	●●			●

DIN 374	ISO2/6H	D_N	P mm	l_1 js16 mm	L_c mm	d_1 h9 mm	\square h12 mm	l_g mm	N	uncoated designation 21368
		M 4 LH	0,5	63	12	2,8	2,1	5	3	-M4X0.5
		M 5 LH	0,5	70	13	3,5	2,7	6	3	-M5X0.5
		M 6 LH	0,5	80	15	4,5	3,4	6	3	-M6X0.5
		M 6 LH	0,75	80	15	4,5	3,4	6	3	-M6X0.75
		M 8 LH	0,5	80	15	6	4,9	8	3	-M8X0.5
		M 8 LH	0,75	80	15	6	4,9	8	3	-M8X0.75
		M 8 LH	1	90	18	6	4,9	8	3	-M8X1
		M 10 LH	0,75	90	20	7	5,5	8	3	-M10X0.75
		M 10 LH	1	90	20	7	5,5	8	3	-M10X1
		M 12 LH	1	100	21	9	7	10	4	-M12X1
		M 12 LH	1,5	100	21	9	7	10	4	-M12X1.5
		M 14 LH	1	100	21	11	9	12	4	-M14X1
		M 14 LH	1,5	100	21	11	9	12	4	-M14X1.5
		M 16 LH	1	100	21	12	9	12	4	-M16X1
		M 16 LH	1,5	100	21	12	9	12	4	-M16X1.5
		M 18 LH	1,5	110	24	14	11	14	4	-M18X1.5
		M 20 LH	1,5	125	24	16	12	15	4	-M20X1.5
		M 22 LH	1,5	125	24	18	14,5	17	4	-M22X1.5
		M 24 LH	1,5	140	26	18	14,5	17	4	-M24X1.5

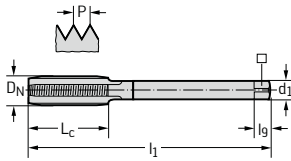

Machine tap Paradur® HN



$\leq 1,5 \times D_N$

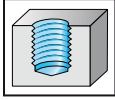

- HSS-E
- chamfer form E = 1.5 - 2 thread
- materials from 400 to 1200 N/mm² or 36 HRC
- for short-chipping materials

MF

DIN 13

	P	M	K	N	S	H	O
uncoated	●●	●	●●	●●	●	●	●

DIN 374 6HX		D_N	P mm	l_1 js16 mm	L_c mm	d_1 h9 mm	\square h12 mm	l_g mm	N	uncoated designation 213614
	M 12		1,5	100	21	9	7	10	5	-M12X1.5
	M 14		1,5	100	21	11	9	12	6	-M14X1.5
	M 16		1,5	100	21	12	9	12	6	-M16X1.5
	M 18		1,5	110	24	14	11	14	6	-M18X1.5
	M 20		1,5	125	24	16	12	15	6	-M20X1.5
	M 22		1,5	125	24	18	14,5	17	6	-M22X1.5



Machine tap Paradur® HT



$\leq 3,5 \times D_N$

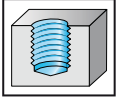

- HSS-E
- chamfer form C = 2 - 3 thread
- materials from 500 to 1400 N/mm² or 44 HRC
- for long and short-chipping materials

MF

DIN 13

	P	M	K	N	S	H	O
uncoated	●●		●●	●			●
TiN	●●		●●	●			●

DIN 374 ISO2/6H		D_N	P mm	l_1 js16 mm	L_c mm	d_1 h9 mm	\square h12 mm	l_g mm	N	uncoated designation 213611	TiN designation 213615
	M 12	1,5	100	21	9	7	10	3		-M12X1.5	
	M 14	1,5	100	21	11	9	12	3	-M14X1.5	-M14X1.5	
	M 16	1,5	100	21	12	9	12	3		-M16X1.5	
	M 18	1,5	110	24	14	11	14	3		-M18X1.5	
	M 20	1,5	125	24	16	12	15	3		-M20X1.5	
	M 22	1,5	125	24	18	14,5	17	3		-M22X1.5	
	M 24	1,5	140	26	18	14,5	17	4		-M24X1.5	
	M 30	2	150	26	22	18	21	4		-M30X2	
	M 33	2	160	28	25	20	23	4		-M33X2	



Machine tap Paradur® N

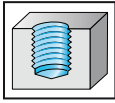

 $\leq 1,5 \times D_N$

- HSS-E
- chamfer form C = 2 - 3 thread
- 15° helix angle
- materials from 200 to 1000 N/mm² or 32 HRC
- for long-chipping materials

MF

DIN 13

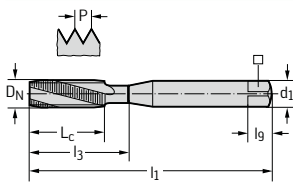
	P	M	K	N	S	H	O
uncoated	●	●	●	●	●	●	●
TiN	●	●	●	●	●	●	●
TiCN	●	●	●	●	●	●	●

DIN 371 ISO2/6H

D _N	P mm	l ₁ js16 mm	L _c mm	l ₃ ±1 mm	d ₁ h9 mm	□ h12 mm	l _g mm	N	uncoated designation 21410		
M 4	0,5	63	7	21	4,5	3,4	6	3	-M4X0.5		
M 5	0,5	70	8	25	6	4,9	8	3	-M5X0.5		
M 6	0,5	80	10	30	6	4,9	8	3	-M6X0.5		
M 6	0,75	80	10	30	6	4,9	8	3	-M6X0.75		

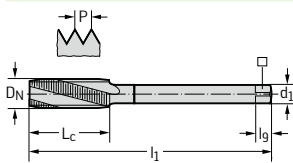
DIN 374 ISO2/6H

D _N	P mm	l ₁ js16 mm	L _c mm	l ₃ ±1 mm	d ₁ h9 mm	□ h12 mm	l _g mm	N	uncoated designation 21460	TiN designation 2146005	TiCN designation 2146006
M 8	0,75	80	10	-	6	4,9	8	3	-M8X0.75	-M8X0.75	
M 8	1	90	12	-	6	4,9	8	3	-M8X1	-M8X1	-M8X1
M 10	1	90	12	-	7	5,5	8	3	-M10X1	-M10X1	-M10X1
M 10	1,25	100	15	-	7	5,5	8	3	-M10X1.25		
M 12	1	100	13	-	9	7	10	3	-M12X1	-M12X1	-M12X1
M 12	1,25	100	13	-	9	7	10	3	-M12X1.25		
M 12	1,5	100	21	-	9	7	10	3	-M12X1.5	-M12X1.5	-M12X1.5
M 14	1	100	15	-	11	9	12	4	-M14X1		
M 14	1,25	100	15	-	11	9	12	4	-M14X1.25		
M 14	1,5	100	21	-	11	9	12	4	-M14X1.5	-M14X1.5	-M14X1.5
M 16	1	100	15	-	12	9	12	4	-M16X1		
M 16	1,5	100	21	-	12	9	12	4	-M16X1.5	-M16X1.5	-M16X1.5
M 18	1,5	110	24	-	14	11	14	4	-M18X1.5	-M18X1.5	-M18X1.5
M 20	1,5	125	24	-	16	12	15	4	-M20X1.5	-M20X1.5	-M20X1.5
M 20	2	140	30	-	16	12	15	4	-M20X2		
M 22	1,5	125	24	-	18	14,5	17	4	-M22X1.5	-M22X1.5	
M 24	1,5	140	26	-	18	14,5	17	4	-M24X1.5	-M24X1.5	
M 24	2	140	26	-	18	14,5	17	4	-M24X2		
M 26	1,5	140	26	-	18	14,5	17	4	-M26X1.5		
M 27	1,5	140	26	-	20	16	19	4	-M27X1.5		
M 27	2	140	26	-	20	16	19	4	-M27X2		
M 28	1,5	140	26	-	20	16	19	4	-M28X1.5		
M 30	1,5	150	26	-	22	18	21	4	-M30X1.5		
M 30	2	150	26	-	22	18	21	4	-M30X2		
M 32	1,5	150	26	-	22	18	21	4	-M32X1.5		
M 33	1,5	160	28	-	25	20	23	4	-M33X1.5		
M 36	1,5	170	28	-	28	22	25	4	-M36X1.5		

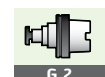

Machine tap Paradur® N



$\leq 1,5 \times D_N$

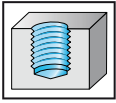

- HSS-E
- chamfer form C = 2 - 3 thread
- 15° helix angle
- materials from 200 to 1000 N/mm² or 32 HRC
- for long-chipping materials

MF

DIN 13

	P	M	K	N	S	H	O
uncoated	●●		●●	●●			
TiN	●●		●●	●●			

DIN 374		ISO3/6G							uncoated designation 21480	TIN designation 2148005
D _N	P mm	l ₁ js16 mm	L _c mm	d ₁ h9 mm	□ h12 mm	l _g mm	N			
M 4	0,5	63	7	2,8	2,1	5	3	-M4X0.5		
M 5	0,5	70	8	3,5	2,7	6	3	-M5X0.5		
M 6	0,5	80	10	4,5	3,4	6	3	-M6X0.5		
M 6	0,75	80	10	4,5	3,4	6	3	-M6X0.75		
M 8	0,75	80	10	6	4,9	8	3	-M8X0.75		
M 8	1	90	12	6	4,9	8	3	-M8X1	-M8X1	
M 10	1	90	12	7	5,5	8	3	-M10X1	-M10X1	
M 12	1	100	13	9	7	10	3	-M12X1	-M12X1	
M 12	1,5	100	21	9	7	10	3	-M12X1.5	-M12X1.5	
M 14	1,5	100	21	11	9	12	4	-M14X1.5	-M14X1.5	
M 16	1,5	100	21	12	9	12	4	-M16X1.5	-M16X1.5	
M 18	1,5	110	24	14	11	14	4	-M18X1.5		
M 20	1,5	125	24	16	12	15	4	-M20X1.5		
M 22	1,5	125	24	18	14,5	17	4	-M22X1.5		

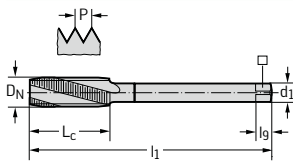

Machine tap Paradur® WSH

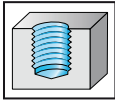
 $\leq 3 \times D_N$

- HSS-E
- chamfer form C = 2 - 3 thread
- 45° helix angle
- materials from 200 to 1000 N/mm² or 32 HRC
- for long-chipping materials

MF

DIN 13

	P	M	K	N	S	H	O
uncoated	●●		●	●			
TiN	●●		●	●			

DIN 371 ISO2/6H

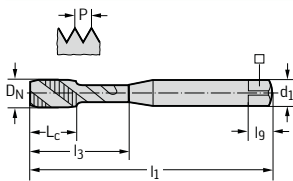

D _N	P mm	l ₁ js16 mm	L _c mm	l ₃ ±1 mm	d ₁ h9 mm	□ h12 mm	l _g mm	N	uncoated designation 21517
M 2,5	0,35	50	4	12,5	2,8	2,1	5	3	-M2.5X0.35
M 3	0,25	56	6	18	3,5	2,7	6	3	-M3X0.25
M 3	0,35	56	6	18	3,5	2,7	6	3	-M3X0.35
M 4	0,35	63	7	21	4,5	3,4	6	3	-M4X0.35
M 4	0,5	63	7	21	4,5	3,4	6	3	-M4X0.5
M 4,5	0,5	70	8	25	6	4,9	8	3	-M4.5X0.5
M 5	0,5	70	8	25	6	4,9	8	3	-M5X0.5
M 6	0,5	80	10	30	6	4,9	8	3	-M6X0.5
M 6	0,75	80	10	30	6	4,9	8	3	-M6X0.75
M 7	0,75	80	10	30	7	5,5	8	3	-M7X0.75
M 8	1	90	12	35	8	6,2	9	3	-M8X1
M 10	1	90	12	39	10	8	11	3	-M10X1

DIN 374 ISO2/6H

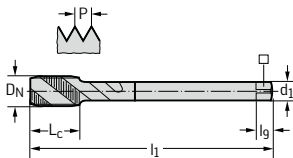

D _N	P mm	l ₁ js16 mm	L _c mm	l ₃ ±1 mm	d ₁ h9 mm	□ h12 mm	l _g mm	N	uncoated designation 21567	TiN designation 2156705
M 8	0,75	80	10	-	6	4,9	8	3	-M8X0.75	
M 8	1	90	12	-	6	4,9	8	3	-M8X1	-M8X1
M 9	1	90	13	-	7	5,5	8	3	-M9X1	
M 10	0,75	90	12	-	7	5,5	8	3	-M10X0.75	
M 10	1	90	12	-	7	5,5	8	3	-M10X1	-M10X1
M 10	1,25	100	15	-	7	5,5	8	3	-M10X1.25	-M10X1.25
M 12	1	100	13	-	9	7	10	4	-M12X1	-M12X1
M 12	1,25	100	13	-	9	7	10	4	-M12X1.25	-M12X1.25
M 12	1,5	100	13	-	9	7	10	4	-M12X1.5	-M12X1.5
M 14	1	100	15	-	11	9	12	4	-M14X1	
M 14	1,25	100	15	-	11	9	12	4	-M14X1.25	
M 14	1,5	100	15	-	11	9	12	4	-M14X1.5	-M14X1.5
M 16	1	100	15	-	12	9	12	4	-M16X1	
M 16	1,5	100	15	-	12	9	12	4	-M16X1.5	-M16X1.5
M 18	1	110	17	-	14	11	14	4	-M18X1	
M 18	1,5	110	17	-	14	11	14	4	-M18X1.5	-M18X1.5
M 20	1	125	17	-	16	12	15	4	-M20X1	
M 20	1,5	125	17	-	16	12	15	4	-M20X1.5	-M20X1.5
M 20	2	140	25	-	16	12	15	4	-M20X2	
M 22	1	125	18	-	18	14,5	17	4	-M22X1	
M 22	1,5	125	18	-	18	14,5	17	4	-M22X1.5	-M22X1.5
M 22	2	140	20	-	18	14,5	17	4	-M22X2	
M 24	1	140	20	-	18	14,5	17	5	-M24X1	
M 24	1,5	140	20	-	18	14,5	17	5	-M24X1.5	
M 24	2	140	20	-	18	14,5	17	5	-M24X2	
M 26	1,5	140	20	-	18	14,5	17	5	-M26X1.5	
M 27	1,5	140	20	-	20	16	19	5	-M27X1.5	
M 27	2	140	20	-	20	16	19	5	-M27X2	

Continued



Machine tap Paradur® WSH

 $\leq 3 \times D_N$

Continued

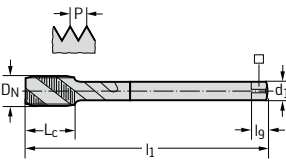
DIN 374 ISO2/6H		D_N	P mm	l_1 js16 mm	L_c mm	l_3 ± 1 mm	d_1 h9 mm	\square h12 mm	l_g mm	N	uncoated designation 21567	TIN designation 2156705
	M 30		1,5	150	20	-	22	18	21	5	-M30X1.5	
	M 30		2	150	20	-	22	18	21	5	-M30X2	
	M 32		1,5	150	20	-	22	18	21	5	-M32X1.5	
	M 33		1,5	160	22	-	25	20	23	5	-M33X1.5	
	M 33		2	160	22	-	25	20	23	5	-M33X2	
	M 36		1,5	170	22	-	28	22	25	5	-M36X1.5	
M 36		2	170	22	-	28	22	25	5	-M36X2		

Machine tap
Paradur® WSH



$\leq 3 \times D_N$

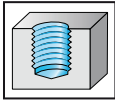

- HSS-E
- chamfer form C = 2 - 3 thread
- 45° helix angle
- materials from 200 to 1000 N/mm² or 32 HRC
- for long-chipping materials

MF

DIN 13

	P	M	K	N	S	H	O
uncoated	●●		●	●			
TiN	●●		●	●			

DIN 374	ISO3/6G	D_N	P mm	l_1 js16 mm	L_c mm	d_1 h9 mm	□ h12 mm	l_g mm	N	uncoated designation 21587	TiN designation 2158705
		M 8	1	90	12	6	4,9	8	3	-M8X1	-M8X1
		M 10	1	90	12	7	5,5	8	3	-M10X1	-M10X1
		M 12	1	100	13	9	7	10	4	-M12X1	-M12X1
		M 12	1,5	100	13	9	7	10	4	-M12X1.5	-M12X1.5
		M 14	1,5	100	15	11	9	12	4	-M14X1.5	-M14X1.5
		M 16	1,5	100	15	12	9	12	4	-M16X1.5	-M16X1.5
		M 18	1,5	110	17	14	11	14	4	-M18X1.5	-M18X1.5

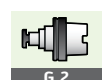
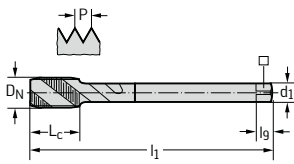

Machine tap Paradur® WTH

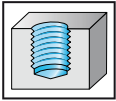
 $\leq 3,5 \times D_N$

- HSS-E
- chamfer form C = 2 - 3 thread
- 45° helix angle
- materials from 200 to 1000 N/mm² or 32 HRC
- for long-chipping materials

MF

DIN 13

	P	M	K	N	S	H	O
uncoated	●●	●	●	●	●	●	●

DIN 374	ISO2/6H	D_N	P mm	l_1 js16 mm	L_c mm	d_1 h9 mm	\square h12 mm	l_g mm	N	uncoated designation 21569
		M 12	1,5	100	13	9	7	10	4	-M12X1.5
		M 14	1,5	100	15	11	9	12	4	-M14X1.5
		M 16	1,5	100	15	12	9	12	4	-M16X1.5
		M 18	1,5	110	17	14	11	14	4	-M18X1.5
		M 20	1,5	125	17	16	12	15	4	-M20X1.5
		M 20	2	140	25	16	12	15	4	-M20X2
		M 22	1,5	125	18	18	14,5	17	4	-M22X1.5
		M 22	2	140	20	18	14,5	17	4	-M22X2
		M 24	1,5	140	20	18	14,5	17	5	-M24X1.5
		M 24	2	140	20	18	14,5	17	5	-M24X2
		M 26	1,5	140	20	18	14,5	17	5	-M26X1.5
		M 27	2	140	20	20	16	19	5	-M27X2
		M 30	1,5	150	20	22	18	21	5	-M30X1.5
		M 30	2	150	20	22	18	21	5	-M30X2
		M 32	1,5	150	20	22	18	21	5	-M32X1.5
		M 33	1,5	160	22	25	20	23	5	-M33X1.5
		M 33	2	160	22	25	20	23	5	-M33X2
		M 36	1,5	170	22	28	22	25	5	-M36X1.5
		M 36	2	170	22	28	22	25	5	-M36X2
		M 36	3	200	30	28	22	25	5	-M36X3
		M 38	1,5	170	22	28	22	25	5	-M38X1.5
		M 39	2	170	22	32	24	27	5	-M39X2
		M 39	3	200	33	32	24	27	5	-M39X3
		M 40	1,5	170	22	32	24	27	5	-M40X1.5
		M 42	1,5	170	22	32	24	27	6	-M42X1.5
		M 42	2	170	22	32	24	27	6	-M42X2
		M 42	3	200	33	32	24	27	6	-M42X3
		M 45	1,5	180	22	36	29	32	6	-M45X1.5
	M 45	2	180	24	36	29	32	6	-M45X2	
	M 48	1,5	190	22	36	29	32	6	-M48X1.5	
	M 48	2	190	24	36	29	32	6	-M48X2	
	M 48	3	225	36	36	29	32	6	-M48X3	
	M 52	2	190	26	40	32	35	6	-M52X2	
	M 52	3	225	36	40	32	35	6	-M52X3	

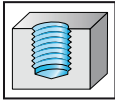

Machine tap Paradur® Short Chip soft

 $\leq 3,5 \times D_N$

- HSS-E
- chamfer form C = 2 - 3 thread
- 15° helix angle
- enlarged core diameter
- materials from 350 to 850 N/mm² or 25 HRC
- for long-chipping materials

MF

DIN 13

	P	M	K	N	S	H	O
TiN/vap	●●		●●				

~DIN 374	ISO2/6H	D_N	P mm	l_1 js16 mm	L_c mm	d_1 h9 mm	\square h12 mm	l_g mm	N	TIN/VAP designation 2146055
		M 8	1	90	11	6	4,9	8	3	-M8X1
		M 10	1	90	14	7	5,5	8	3	-M10X1
		M 12	1	100	17	9	7	10	3	-M12X1
		M 12	1,5	100	17	9	7	10	3	-M12X1.5
		M 14	1,5	100	19,5	11	9	12	4	-M14X1.5
		M 16	1,5	100	22,5	12	9	12	4	-M16X1.5

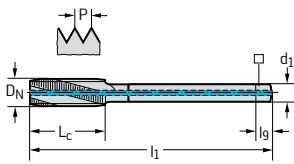

Machine tap Paradur® STE



$\leq 3 \times D_N$

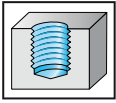

- HSS-E
- chamfer form E = 1.5 - 2 thread
- 40° helix angle
- materials from 350 to 1200 N/mm² or 36 HRC
- for long-chipping materials

MF

DIN 13

	P	M	K	N	S	H	O
THL	●	●	●	●			

DIN 374 6HX		D_N	P mm	l_1 js16 mm	L_c mm	d_1 h9 mm	\square h12 mm	l_g mm	N	THL designation 2156062
	M 8		1	90	13	6	4,9	8	4	-M8X1
	M 10		1	90	12	7	5,5	8	4	-M10X1
	M 12		1,5	100	13	9	7	10	4	-M12X1.5
	M 14		1,5	100	15	11	9	12	5	-M14X1.5
	M 16		1,5	100	15	12	9	12	5	-M16X1.5
	M 18		1,5	110	17	14	11	14	5	-M18X1.5



G 2

D 396

Machine tap Paradur Inox®

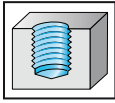
 $\leq 2,5 \times D_N$

- HSS-E
- chamfer form C = 2 - 3 thread
- 40° helix angle
- enlarged core diameter
- materials from 350 to 1200 N/mm² or 36 HRC
- for long-chipping materials

MF

DIN 13

	P	M	K	N	S	H	O
vap	●	●	●				
TiN	●	●	●				

DIN 371 6HX

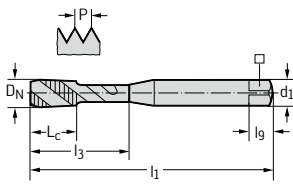

D _N	P mm	l ₁ js16 mm	L _c mm	l ₃ ±1 mm	d ₁ h9 mm	□ h12 mm	l _g mm	N	VAP designation 21513	TiN designation 2151305
M 4	0,5	63	7	21	4,5	3,4	6	3	-M4X0.5	-M4X0.5
M 5	0,5	70	8	25	6	4,9	8	3	-M5X0.5	-M5X0.5
M 6	0,5	80	10	30	6	4,9	8	3	-M6X0.5	-M6X0.5
M 6	0,75	80	10	30	6	4,9	8	3	-M6X0.75	

DIN 374 6HX

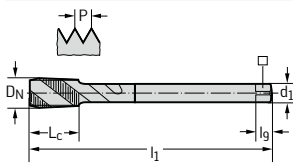

D _N	P mm	l ₁ js16 mm	L _c mm	l ₃ ±1 mm	d ₁ h9 mm	□ h12 mm	l _g mm	N	VAP designation 21563	TiN designation 2156305
M 8	0,5	80	10	-	6	4,9	8	3	-M8X0.5	-M8X0.5
M 8	0,75	80	10	-	6	4,9	8	3	-M8X0.75	-M8X0.75
M 8	1	90	13	-	6	4,9	8	3	-M8X1	-M8X1
M 10	0,75	90	12	-	7	5,5	8	3	-M10X0.75	-M10X0.75
M 10	1	90	12	-	7	5,5	8	3	-M10X1	-M10X1
M 10	1,25	100	15	-	7	5,5	8	3	-M10X1.25	-M10X1.25
M 12	1	100	13	-	9	7	10	4	-M12X1	-M12X1
M 12	1,25	100	13	-	9	7	10	4	-M12X1.25	-M12X1.25
M 12	1,5	100	13	-	9	7	10	4	-M12X1.5	-M12X1.5
M 14	1	100	15	-	11	9	12	4	-M14X1	
M 14	1,5	100	15	-	11	9	12	4	-M14X1.5	-M14X1.5
M 16	1,5	100	15	-	12	9	12	4	-M16X1.5	-M16X1.5
M 18	1,5	110	17	-	14	11	14	4	-M18X1.5	-M18X1.5
M 20	1,5	125	17	-	16	12	15	4	-M20X1.5	-M20X1.5
M 20	2	140	25	-	16	12	15	4	-M20X2	
M 22	1,5	125	18	-	18	14,5	17	5	-M22X1.5	
M 24	1,5	140	20	-	18	14,5	17	5	-M24X1.5	
M 24	2	140	20	-	18	14,5	17	5	-M24X2	
M 27	2	140	20	-	20	16	19	5	-M27X2	



G 2



D 396

Machine tap Paradur Inox®



$\leq 2,5 \times D_N$

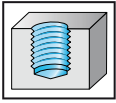

- HSS-E
- chamfer form C = 2 - 3 thread
- 40° helix angle
- enlarged core diameter
- materials from 350 to 1200 N/mm² or 36 HRC
- for long-chipping materials

MF

DIN 13

	P	M	K	N	S	H	O
TiN	●●	●●	●				

DIN 374 6GX		D_N	P mm	l_1 js16 mm	L_c mm	d_1 h9 mm	\square h12 mm	l_g mm	N	TiN designation 2158305
	M 8	1	90	12	6	4,9	8	3	-M8X1	
	M 10	1	90	12	7	5,5	8	3	-M10X1	
	M 12	1	100	13	9	7	10	4	-M12X1	
	M 12	1,5	100	13	9	7	10	4	-M12X1.5	
	M 14	1	100	15	11	9	12	4	-M14X1	
	M 14	1,5	100	15	11	9	12	4	-M14X1.5	
	M 16	1	100	15	12	9	12	4	-M16X1	
	M 16	1,5	100	15	12	9	12	4	-M16X1.5	

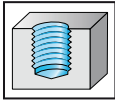

Machine tap Paradur Inox® 25

 $\leq 1,5 \times D_N$

- HSS-E
- chamfer form E = 1.5 - 2 thread
- 25° helix angle
- materials from 350 to 1200 N/mm² or 36 HRC
- for long-chipping materials

MF

DIN 13

	P	M	K	N	S	H	O
TiN	●●	●●	●	●	●	●	●

DIN 374 6HX		D _N	P mm	l ₁ js16 mm	L _c mm	d ₁ h9 mm	□ h12 mm	l _g mm	N	TiN designation 2156315
	M 10		1	90	20	7	5,5	8	5	-M10X1
	M 12		1	100	21	9	7	10	5	-M12X1
	M 12		1,5	100	21	9	7	10	5	-M12X1.5
	M 14		1,5	100	21	11	9	12	5	-M14X1.5
	M 16		1,5	100	21	12	9	12	5	-M16X1.5
	M 18		1,5	110	24	14	11	14	5	-M18X1.5
	M 20		1,5	125	24	16	12	15	6	-M20X1.5
	M 22		1,5	125	24	18	14,5	17	6	-M22X1.5
	M 24		1,5	140	26	18	14,5	17	6	-M24X1.5



G 2



D 396

Machine tap Paradur® Synchronspeed



$\leq 2,5 \times D_N$

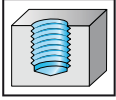

- HSS-E
- chamfer form C = 2 - 3 thread
- 40° helix angle
- long-chipping materials to 1300 N/mm² or 40 HRC
- only for synchronous machining (rigid tapping)
- suitable for minimum quantity lubrication

MF

DIN 13

	P	M	K	N	S	H	O
THL	●	●	●	●	●		●
TiN/vap	●	●	●	●	●		●

~DIN 371 6HX		D_N	P mm	l_1 js16 mm	L_c mm	l_3 ± 1 mm	d_1 h6 mm	\square h12 mm	l_g mm	N	THL designation S2156302	TIN/VAP designation S2156305
Shank DIN 1835 B		M 8	1	90	10,5	35	8	6,2	9	3	-M8X1	-M8X1
		M 10	1	90	10,5	39	10	8	11	3	-M10X1	-M10X1
		M 10	1,25	100	13,5	39	10	8	11	3	-M10X1.25	-M10X1.25
		M 12	1,25	100	13,5	42	12	9	12	3	-M12X1.25	-M12X1.25
		M 12	1,5	100	16	42	12	9	12	3	-M12X1.5	-M12X1.5
		M 14	1,5	100	16	49	14	11	14	4	-M14X1.5	-M14X1.5
		M 16	1,5	100	16	50	16	12	15	4	-M16X1.5	-M16X1.5

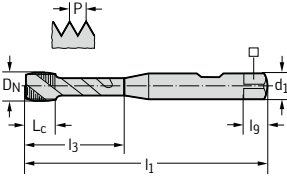

Machine tap Paradur® Eco CI

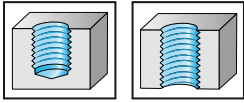

 $\leq 3 \times D_N$

- HSS-E-PM
- chamfer form C = 2 - 3 thread
- materials from 100 to 1000 N/mm² or 32 HRC
- for short-chipping materials
- suitable for minimum quantity lubrication
- Xtra-treat™ surface treatment

MF

DIN 13

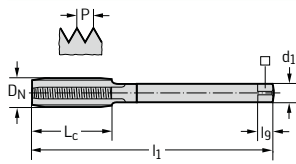
	P	M	K	N	S	H	O
nid			●●	●●			●●
TiCN			●●	●●			●●

DIN 374 6HX

D _N	P mm	l ₁ js16 mm	L _c mm	d ₁ h9 mm	□ h12 mm	l _g mm	N	NID designation E21364	TiCN designation E2136406
M 6	0,75	80	15	4,5	3,4	6	4	-M6X0.75	-M6X0.75
M 8	0,75	80	15	6	4,9	8	4	-M8X0.75	-M8X0.75
M 8	1	90	18	6	4,9	8	4	-M8X1	-M8X1
M 10	1	90	20	7	5,5	8	4	-M10X1	-M10X1
M 10	1,25	100	20	7	5,5	8	4	-M10X1.25	-M10X1.25
M 12	1	100	21	9	7	10	4	-M12X1	-M12X1
M 12	1,25	100	21	9	7	10	4	-M12X1.25	-M12X1.25
M 12	1,5	100	21	9	7	10	4	-M12X1.5	-M12X1.5
M 14	1,5	100	21	11	9	12	4	-M14X1.5	-M14X1.5
M 16	1,5	100	21	12	9	12	4	-M16X1.5	-M16X1.5
M 18	1,5	110	24	14	11	14	4	-M18X1.5	-M18X1.5
M 20	1,5	125	24	16	12	15	4	-M20X1.5	-M20X1.5
M 22	1,5	125	24	18	14,5	17	5	-M22X1.5	-M22X1.5
M 24	1,5	140	26	18	14,5	17	5	-M24X1.5	-M24X1.5
M 26	1,5	140	26	18	14,5	17	5	-M26X1.5	-M26X1.5
M 30	1,5	150	26	22	18	21	5	-M30X1.5	-M30X1.5

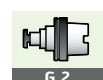

Machine tap Paradur® Eco CI



$\leq 3 \times D_N$

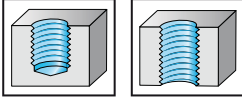

- HSS-E-PM
- chamfer form E = 1.5 - 2 thread
- materials from 100 to 1000 N/mm² or 32 HRC
- for short-chipping materials
- suitable for minimum quantity lubrication
- Xtra-treat™ surface treatment

MF

DIN 13

	P	M	K	N	S	H	O
TiCN			●●	●●			●●

DIN 374 6HX		D_N	P mm	l_1 js16 mm	L_c mm	d_1 h9 mm	\square h12 mm	l_g mm	N	TiCN designation E2136466
	M 8	1	90	18	6	4,9	8	4	-M8X1	
	M 10	1	90	20	7	5,5	8	4	-M10X1	
	M 12	1	100	21	9	7	10	4	-M12X1	
	M 12	1,5	100	21	9	7	10	4	-M12X1.5	
	M 14	1,5	100	21	11	9	12	4	-M14X1.5	
	M 16	1,5	100	21	12	9	12	4	-M16X1.5	
	M 18	1,5	110	24	14	11	14	4	-M18X1.5	
	M 20	1,5	125	24	16	12	15	4	-M20X1.5	
	M 22	1,5	125	24	18	14,5	17	5	-M22X1.5	

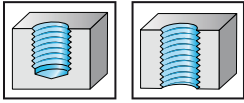

Machine tap Paradur® Eco CI

 $\leq 3 \times D_N$

- HSS-E-PM
- chamfer form C = 2 - 3 thread
- materials from 100 to 1000 N/mm² or 32 HRC
- for short-chipping materials
- Xtra-treat™ surface treatment

MF

DIN 13

	P	M	K	N	S	H	O
TiCN			●●	●●			●●

DIN 374 6HX

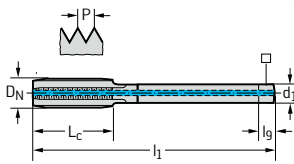

D _N	P mm	l ₁ js16 mm	L _c mm	d ₁ h9 mm	□ h12 mm	l _g mm	N	TiCN designation E2136416
M 8	1	90	18	6	4,9	8	4	-M8X1
M 10	1	90	20	7	5,5	8	4	-M10X1
M 12	1	100	21	9	7	10	4	-M12X1
M 12	1,5	100	21	9	7	10	4	-M12X1.5
M 14	1,5	100	21	11	9	12	4	-M14X1.5
M 16	1,5	100	21	12	9	12	4	-M16X1.5
M 18	1,5	110	24	14	11	14	4	-M18X1.5
M 20	1,5	125	24	16	12	15	4	-M20X1.5
M 22	1,5	125	24	18	14,5	17	5	-M22X1.5



G 2



D 396

Machine tap Paradur® WLM



$\leq 3 \times D_N$

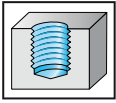

- HSS-E
- chamfer form C = 2 - 3 thread
- 35° helix angle
- materials from 200 to 700 N/mm² or 14 HRC
- for long-chipping materials

MF

DIN 13

	P	M	K	N	S	H	O
uncoated				●●	●●		●●

DIN 374	ISO2/6H	D_N	P mm	l_1 js16 mm	L_c mm	d_1 h9 mm	\square h12 mm	l_g mm	N	uncoated designation 21566
		M 8	0,75	80	10	6	4,9	8	2	-M8X0.75
		M 8	1	90	12	6	4,9	8	2	-M8X1
		M 10	1	90	12	7	5,5	8	3	-M10X1
		M 12	1	100	13	9	7	10	3	-M12X1
		M 12	1,5	100	13	9	7	10	3	-M12X1.5
		M 14	1	100	15	11	9	12	3	-M14X1
		M 14	1,5	100	15	11	9	12	3	-M14X1.5
		M 16	1	100	15	12	9	12	4	-M16X1
		M 16	1,5	100	15	12	9	12	3	-M16X1.5
		M 18	1,5	110	17	14	11	14	4	-M18X1.5
		M 20	1,5	125	17	16	12	15	4	-M20X1.5
		M 22	1,5	125	18	18	14,5	17	4	-M22X1.5

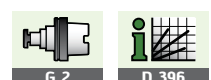
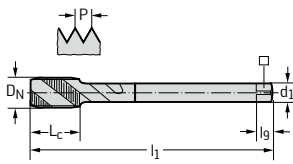

Machine tap Paradur® NI 10

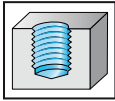
 $\leq 1,5 \times D_N$

- HSS-E-PM
- chamfer form C = 2 - 3 thread
- 10° helix angle
- materials from 1000 N/mm² or 49 HRC
- for long and short-chipping materials

MF

DIN 13

	P	M	K	N	S	H	O
uncoated	●●	●	●	●	●●	●	●

~DIN 371 6HX	D_N	P mm	l_1 js16 mm	L_c mm	d_1 h9 mm	\square h12 mm	l_g mm	N	uncoated designation 214101
	M 8	1	90	20	8	6,2	9	3	-M8X1 ¹
	M 10	1	90	24	10	8	11	3	-M10X1 ¹
	M 10	1,25	100	24,5	10	8	11	3	-M10X1,25 ¹
	M 12	1	100	28	12	9	12	4	-M12X1 ¹
	M 12	1,25	100	28,5	12	9	12	4	-M12X1,25 ¹
	M 12	1,5	100	29,5	12	9	12	4	-M12X1,5 ¹

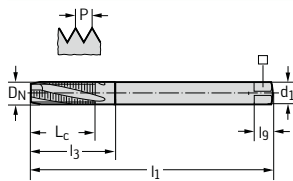
¹without neck

Machine tap Paradur® TI



$\leq 2 \times D_N$

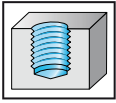

- HSS-E-PM
- chamfer form C = 2 - 3 thread
- 15° helix angle
- materials from 700 to 1400 N/mm² or 44 HRC
- for long-chipping materials

MF

DIN 13

	P	M	K	N	S	H	O
uncoated	●●			●	●●		

~DIN 371 6HX		D_N	P mm	l_1 js16 mm	L_c mm	l_3 ± 1 mm	d_1 h9 mm	\square h12 mm	l_g mm	N	uncoated designation 21416
	M 8	0,75	80	10	29	8	6,2	9	3	-M8X0.75	
	M 8	1	90	12	29	8	6,2	9	3	-M8X1	
	M 10	1	90	14	33	10	8	11	3	-M10X1	

DIN 374 6HX		D_N	P mm	l_1 js16 mm	L_c mm	l_3 ± 1 mm	d_1 h9 mm	\square h12 mm	l_g mm	N	uncoated designation 21466
	M 8	0,75	80	10	-	6	4,9	8	3	-M8X0.75	
	M 8	1	90	12	-	6	4,9	8	3	-M8X1	
	M 10	1	90	14	-	7	5,5	8	3	-M10X1	
	M 10	1,25	100	20	-	7	5,5	8	3	-M10X1.25	
	M 12	1	100	16	-	9	7	10	4	-M12X1	
	M 12	1,25	100	21	-	9	7	10	4	-M12X1.25	
	M 12	1,5	100	21	-	9	7	10	3	-M12X1.5	
	M 14	1	100	16	-	11	9	12	4	-M14X1	
	M 14	1,5	100	21	-	11	9	12	4	-M14X1.5	
	M 16	1	100	18	-	12	9	12	4	-M16X1	

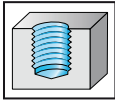

Machine tap Paradur® TI Plus

 $\leq 2 \times D_N$

- HSS-E-PM
- chamfer form C = 2 - 3 thread
- 15° helix angle
- materials from 700 to 1400 N/mm² or 44 HRC
- for long-chipping materials

MF

DIN 13

	P	M	K	N	S	H	O
ACN					●●		

~DIN 371 6HX		D_N	P mm	l_1 js16 mm	L_c mm	l_3 ± 1 mm	d_1 h9 mm	\square h12 mm	l_g mm	N	ACN designation 2141663
	M 6		0,75	80	15	23	6	4,9	8	3	-M6X0.75
	M 8		0,75	90	18	29,5	8	6,2	9	3	-M8X0.75
	M 8		1	90	18	29,5	8	6,2	9	3	-M8X1
	M 10		1	100	20	33,5	10	8	11	3	-M10X1

DIN 374 6HX		D_N	P mm	l_1 js16 mm	L_c mm	l_3 ± 1 mm	d_1 h9 mm	\square h12 mm	l_g mm	N	ACN designation 2146663
	M 12		1	100	21	-	9	7	10	4	-M12X1
	M 12		1,5	100	21	-	9	7	10	4	-M12X1.5
	M 14		1,5	100	21	-	11	9	12	4	-M14X1.5



Machine tap Paradur® HSC



$$\leq 2 \times D_N$$

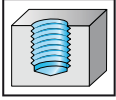

- solid carbide
- chamfer form C = 2 - 3 thread
- 15° helix angle
- for materials from 25 to 55 HRC
- for long-chipping materials

MF

DIN 13

	P	M	K	N	S	H	O
TiCN	●●	●	●●	●●	●	●●	●

DIN 371 6HX		D_N	P mm	l_1 js16 mm	L_c mm	l_3 ± 1 mm	d_1 h6 mm	\square h12 mm	l_g mm	N	TiCN designation 8141056
	M 6		0,75	80	15	30	6	4,9	8	3	-M6X0.75
	M 8		1	90	20	35	8	6,2	9	3	-M8X1
	M 10		1	90	25	39	10	8	11	3	-M10X1

DIN 371 6HX		D_N	P mm	l_1 js16 mm	L_c mm	l_3 ± 1 mm	d_1 h6 mm	\square h12 mm	l_g mm	N	TiCN designation 8146056
	M 12		1	100	20	-	9	7	10	3	-M12X1
	M 12		1,5	100	20	-	9	7	10	4	-M12X1.5
	M 14		1,5	100	21	-	11	9	12	4	-M14X1.5
	M 16		1,5	100	21	-	12	9	12	4	-M16X1.5



**Machine tap
Paradur® GG**



$\leq 3,5 \times D_N$

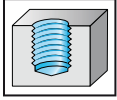

- solid carbide
- chamfer form C = 2 - 3 thread
- materials from 200 to 1500 N/mm² or 47 HRC
- for short-chipping materials

MF

DIN 13

	P	M	K	N	S	H	O
TAFT			●●	●			●

DIN 374 6HX		D_N	P mm	l_1 js16 mm	L_c mm	d_1 h6 mm	\square h12 mm	l_g mm	N	TAFT designation 8136417
		M 8	1	90	12	6	4,9	8	4	-M8X1
		M 10	1	90	14	7	5,5	8	4	-M10X1
		M 12	1,5	100	20	9	7	10	4	-M12X1,5



G 2

D 396

Machine tap Paradur® Engine



$\leq 3 \times D_N$

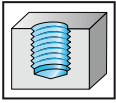

- solid carbide
- overall length L = long
- chamfer form E = 1.5 - 2 thread
- short-chipping materials from 200 to 1000 N/mm² or 32 HRC
- suitable for minimum quantity lubrication
- suitable coating according to requirement

MF

DIN 13

	P	M	K	N	S	H	O
uncoated			●●	●●			

~DIN 374 6HX		D_N	P mm	l_1 js16 mm	L_c mm	d_1 h6 mm	\square h12 mm	l_g mm	N	uncoated designation 8136310
	M 10		1	140	20	7	5,5	8	4	-M10X1
	M 12		1,25	140	21	9	7	10	4	-M12X1.25
	M 12		1,5	140	21	9	7	10	4	-M12X1.5
	M 14		1,25	140	21	11	9	12	4	-M14X1.25
	M 16		1,5	140	21	12	9	12	4	-M16X1.5



Machine tap Paradur® HS



$\leq 3 \times D_N$

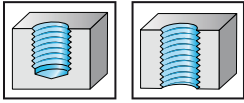

- solid carbide
- chamfer form C = 2 - 3 thread
- for materials to 55 HRC
- for short-chipping materials

MF

DIN 13

	P	M	K	N	S	H	O
uncoated			●	●●	●	●	●●

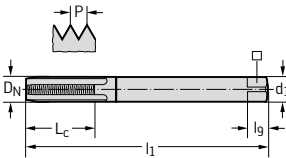
~DIN 371 ISO2/6H		D_N	P mm	l_1 js16 mm	L_c mm	l_3 ± 1 mm	d_1 h6 mm	\square h12 mm	l_g mm	N	uncoated designation 81311
		M 8	1	90	25	-	8	6,2	9	4	-M8X1 ¹
		M 10	1	90	30	-	10	8	11	4	-M10X1 ¹
		M 12	1,5	100	20	42	12	9	12	4	-M12X1.5
		M 14	1,5	100	21	49	14	11	14	4	-M14X1.5
		M 16	1,5	100	21	50	16	12	15	4	-M16X1.5

¹without neck

Machine tap Prototex® Eco HT



$\leq 3,5 \times D_N$

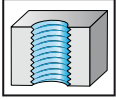

- HSS-E-PM
- chamfer form B = 3.5 - 5 thread
- materials from 500 to 1350 N/mm² or 42 HRC
- for long-chipping materials
- suitable for minimum quantity lubrication

UNC

ASME B1.1

	P	M	K	N	S	H	O
THL	●●	●●	●●	●●	●		●

DIN 2184-1 2B	D _N -P Nom	D _N mm	l ₁ js16 mm	L _c mm	l ₃ ±1 mm	d ₁ h9 mm	□ h12 mm	l _g mm	N	THL designation E2221302
	No. 2-56	2,184	45	7	12	2,8	2,1	5	3	-UNC2
	No. 4-40	2,845	56	9	18	3,5	2,7	6	3	-UNC4
	No. 6-32	3,505	56	11	20	4	3	6	3	-UNC6
	No. 8-32	4,166	63	12	21	4,5	3,4	6	3	-UNC8
	No. 10-24	4,826	70	13	25	6	4,9	8	3	-UNC10
	1/4-20	6,35	80	15	30	7	5,5	8	3	-UNC1/4

DIN 2184-1 2B	D _N -P Nom	D _N mm	l ₁ js16 mm	L _c mm	l ₃ ±1 mm	d ₁ h9 mm	□ h12 mm	l _g mm	N	THL designation E2226302
	5/16-18	7,938	90	18	-	6	4,9	8	3	-UNC5/16
	3/8-16	9,525	100	20	-	7	5,5	8	3	-UNC3/8
	1/2-13	12,7	110	23	-	9	7	10	4	-UNC1/2
	5/8-11	15,875	110	25	-	12	9	12	4	-UNC5/8



Machine tap Prototex® Eco HT



$\leq 3,5 \times D_N$

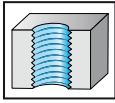

- HSS-E-PM
- chamfer form B = 3.5 - 5 thread
- materials from 500 to 1350 N/mm² or 42 HRC
- for long-chipping materials
- suitable for minimum quantity lubrication

UNC

ASME B1.1

	P	M	K	N	S	H	O
THL	●	●	●	●	●		●

DIN 2184-1 2B	D _N -P Nom	D _N mm	l ₁ js16 mm	L _c mm	l ₃ ±1 mm	d ₁ h9 mm	□ h12 mm	l _g mm	N	THL designation E2221342
	1/4-20	6,35	80	15	30	7	5,5	8	3	-UNC1/4

DIN 2184-1 2B	D _N -P Nom	D _N mm	l ₁ js16 mm	L _c mm	l ₃ ±1 mm	d ₁ h9 mm	□ h12 mm	l _g mm	N	THL designation E2226342
	5/16-18	7,938	90	18	-	6	4,9	8	3	-UNC5/16
	3/8-16	9,525	100	20	-	7	5,5	8	3	-UNC3/8
	1/2-13	12,7	110	23	-	9	7	10	4	-UNC1/2
	5/8-11	15,875	110	25	-	12	9	12	4	-UNC5/8



G 2



D 396

Machine tap Prototex®



$\leq 3 \times D_N$

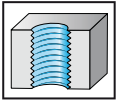

- HSS-E
- chamfer form B = 3.5 - 5 thread
- materials from 200 to 700 N/mm² or 14 HRC
- for long-chipping materials

UNC

ASME B1.1

	P	M	K	N	S	H	O
uncoated	●●			●●			●

DIN 2184-1 2B	D _N -P Nom	D _N mm	l ₁ js16 mm	L _c mm	l ₃ ±1 mm	d ₁ h9 mm	□ h12 mm	l _g mm	N	uncoated designation 22210
	No. 2-56	2,184	45	7	12	2,8	2,1	5	2	-UNC2
	No. 4-40	2,845	56	9	18	3,5	2,7	6	2	-UNC4
	No. 6-32	3,505	56	11	20	4	3	6	2	-UNC6
	No. 8-32	4,166	63	12	21	4,5	3,4	6	2	-UNC8

Machine tap Prototex®

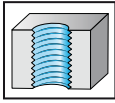
 $\leq 3 \times D_N$

- HSS-E
- chamfer form B = 3.5 - 5 thread
- materials from 200 to 700 N/mm² or 14 HRC
- for long-chipping materials

UNC

ASME B1.1

	P	M	K	N	S	H	O
uncoated	●●			●●			●

DIN 2184-1 3B

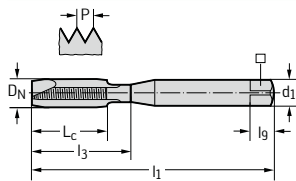

D _N -P Nom	D _N mm	l ₁ js16 mm	L _c mm	l ₃ ±1 mm	d ₁ h9 mm	□ h12 mm	l ₉ mm	N	uncoated designation 22200
No. 1-64	1,854	45	6	9	2,8	2,1	5	2	-UNC1
No. 2-56	2,184	45	7	12	2,8	2,1	5	2	-UNC2
No. 3-48	2,515	50	8	12,5	2,8	2,1	5	2	-UNC3
No. 4-40	2,845	56	9	18	3,5	2,7	6	2	-UNC4
No. 5-40	3,175	56	10	18	3,5	2,7	6	2	-UNC5
No. 6-32	3,505	56	11	20	4	3	6	2	-UNC6
No. 8-32	4,166	63	12	21	4,5	3,4	6	2	-UNC8
No. 10-24	4,826	70	13	25	6	4,9	8	2	-UNC10

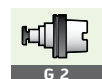

G 2



D 396

Machine tap Prototex® H



$\leq 3 \times D_N$

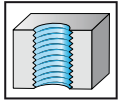

- HSS-E
- chamfer form B = 3.5 - 5 thread
- materials from 200 to 1000 N/mm² or 32 HRC
- for long-chipping materials

UNC

ASME B1.1

	P	M	K	N	S	H	O
uncoated	●	●	●	●	●	●	●
TiN	●	●	●	●	●	●	●

DIN 2184-1 2B		D_N -P Nom	D_N mm	l_1 js16 mm	L_c mm	l_3 ± 1 mm	d_1 h9 mm	\square h12 mm	l_g mm	N	uncoated designation 22310	TIN designation 2231005
	No. 2-56	2,184	45	7	12	2,8	2,1	5	3	-UNC2		
	No. 3-48	2,515	50	8	12,5	2,8	2,1	5	3	-UNC3		
	No. 4-40	2,845	56	9	18	3,5	2,7	6	3	-UNC4		
	No. 5-40	3,175	56	10	18	3,5	2,7	6	3	-UNC5		
	No. 6-32	3,505	56	11	20	4	3	6	3	-UNC6	-UNC6	
	No. 8-32	4,166	63	12	21	4,5	3,4	6	3	-UNC8		
	No. 10-24	4,826	70	13	25	6	4,9	8	3	-UNC10		
	No. 12-24	5,486	80	15	30	6	4,9	8	3	-UNC12		
	1/4-20	6,35	80	15	30	7	5,5	8	3	-UNC1/4		
	5/16-18	7,938	90	18	35	8	6,2	9	3	-UNC5/16		
	3/8-16	9,525	100	20	39	10	8	11	3	-UNC3/8		

DIN 2184-1 2B		D_N -P Nom	D_N mm	l_1 js16 mm	L_c mm	l_3 ± 1 mm	d_1 h9 mm	\square h12 mm	l_g mm	N	uncoated designation 22360	TIN designation 2236005
	7/16-14	11,113	100	20	-	8	6,2	9	3	-UNC7/16		
	1/2-13	12,7	110	23	-	9	7	10	3	-UNC1/2	-UNC1/2	
	9/16-12	14,288	110	25	-	11	9	12	3	-UNC9/16		
	5/8-11	15,875	110	25	-	12	9	12	3	-UNC5/8	-UNC5/8	
	3/4-10	19,05	125	30	-	14	11	14	3	-UNC3/4	-UNC3/4	
	7/8-9	22,225	140	30	-	18	14,5	17	3	-UNC7/8		
	1-8	25,4	160	36	-	18	14,5	17	3	-UNC1		
	1 1/8-7	28,575	180	42	-	22	18	21	4	-UNC1.1/8		
	1 1/4-7	31,75	180	42	-	22	18	21	4	-UNC1.1/4		
	1 1/2-6	38,1	200	48	-	28	22	25	4	-UNC1.1/2		

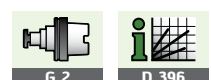

Machine tap Prototex Inox®

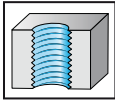
 $\leq 3 \times D_N$

- HSS-E
- chamfer form B = 3.5 - 5 thread
- materials from 350 to 1200 N/mm² or 36 HRC
- for long-chipping materials

UNC

ASME B1.1

	P	M	K	N	S	H	O
vap	●●	●●	■	■	■	■	■
TiN	●●	●●	■	■	■	■	■

DIN 2184-1 2B

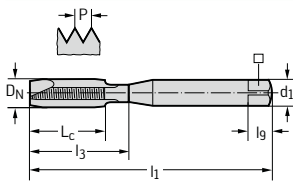

D _N -P Nom	D _N mm	l ₁ js16 mm	L _c mm	l ₃ ±1 mm	d ₁ h9 mm	□ h12 mm	l _g mm	N	VAP designation 22213	TIN designation 2221305
No. 2-56	2,184	45	7	12	2,8	2,1	5	2	-UNC2	-UNC2
No. 3-48	2,515	50	8	12,5	2,8	2,1	5	2	-UNC3	-UNC3
No. 4-40	2,845	56	9	18	3,5	2,7	6	2	-UNC4	-UNC4
No. 5-40	3,175	56	10	18	3,5	2,7	6	2	-UNC5	-UNC5
No. 6-32	3,505	56	11	20	4	3	6	2	-UNC6	-UNC6
No. 8-32	4,166	63	12	21	4,5	3,4	6	3	-UNC8	-UNC8
No. 10-24	4,826	70	13	25	6	4,9	8	3	-UNC10	-UNC10
No. 12-24	5,486	80	15	30	6	4,9	8	3	-UNC12	-UNC12
1/4-20	6,35	80	15	30	7	5,5	8	3	-UNC1/4	-UNC1/4

DIN 2184-1 2B

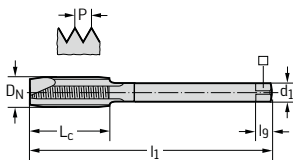

D _N -P Nom	D _N mm	l ₁ js16 mm	L _c mm	l ₃ ±1 mm	d ₁ h9 mm	□ h12 mm	l _g mm	N	VAP designation 22263	TIN designation 2226305
5/16-18	7,938	90	18	-	6	4,9	8	3	-UNC5/16	
3/8-16	9,525	100	20	-	7	5,5	8	3	-UNC3/8	-UNC3/8
7/16-14	11,113	100	20	-	8	6,2	9	3	-UNC7/16	
1/2-13	12,7	110	23	-	9	7	10	4	-UNC1/2	-UNC1/2
9/16-12	14,288	110	25	-	11	9	12	4	-UNC9/16	
5/8-11	15,875	110	25	-	12	9	12	4	-UNC5/8	
3/4-10	19,05	125	30	-	14	11	14	4	-UNC3/4	
7/8-9	22,225	140	30	-	18	14,5	17	4	-UNC7/8	
1-8	25,4	160	36	-	18	14,5	17	4	-UNC1	



G 2



D 396

Machine tap Prototex® TiNi



$$\leq 2 \times D_N$$

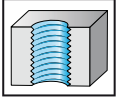

- HSS-E-PM
- chamfer form B = 3.5 - 5 thread
- materials from 700 to 1400 N/mm² or 44 HRC
- for long-chipping materials

UNC

ASME B1.1

	P	M	K	N	S	H	O
uncoated	●●	●●	●●	●	●●		

~DIN 2184-1 2B	D _N -P Nom	D _N mm	l ₁ js16 mm	L _c mm	l ₃ ±1 mm	d ₁ h9 mm	□ h12 mm	l _g mm	N	uncoated designation 22217
	No. 2-56	2,184	45	9	-	2,8	2,1	5	2	-UNC2 ¹
	No. 4-40	2,845	56	10	-	3,5	2,7	6	2	-UNC4 ¹
	No. 5-40	3,175	56	10	-	3,5	2,7	6	2	-UNC5 ¹
	No. 6-32	3,505	56	12	-	4	3	6	3	-UNC6 ¹
	No. 8-32	4,166	63	13	-	4,5	3,4	6	3	-UNC8 ¹
	No. 10-24	4,826	70	16	-	6	4,9	8	3	-UNC10 ¹
	1/4-20	6,35	80	15	25	7	5,5	8	3	-UNC1/4
	5/16-18	7,938	90	18	29,5	8	6,2	9	3	-UNC5/16
	3/8-16	9,525	100	20	33,5	10	8	11	3	-UNC3/8

¹without neck

DIN 2184-1 2B	D _N -P Nom	D _N mm	l ₁ js16 mm	L _c mm	l ₃ ±1 mm	d ₁ h9 mm	□ h12 mm	l _g mm	N	uncoated designation 22267
	7/16-14	11,113	100	20	-	8	6,2	9	4	-UNC7/16
	1/2-13	12,7	110	23	-	9	7	10	4	-UNC1/2
	9/16-12	14,288	110	25	-	11	9	12	4	-UNC9/16
	5/8-11	15,875	110	25	-	12	9	12	4	-UNC5/8
	3/4-10	19,05	125	30	-	14	11	14	4	-UNC3/4

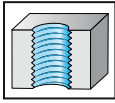

Machine tap Prototex® TiNi

 $\leq 2 \times D_N$

- HSS-E-PM
- chamfer form B = 3.5 - 5 thread
- materials from 700 to 1400 N/mm² or 44 HRC
- for long-chipping materials

UNC

ASME B1.1

	P	M	K	N	S	H	O
uncoated	●●	●●	●	●	●●		

~DIN 2184-1 3B	D _N -P Nom	D _N mm	l ₁ js16 mm	L _c mm	l ₃ ±1 mm	d ₁ h9 mm	□ h12 mm	l _g mm	N	uncoated designation 22207
	No. 2-56	2,184	45	9	-	2,8	2,1	5	2	-UNC2
	No. 4-40	2,845	56	10	-	3,5	2,7	6	2	-UNC4
	No. 5-40	3,175	56	10	-	3,5	2,7	6	2	-UNC5
	No. 6-32	3,505	56	12	-	4	3	6	3	-UNC6
	No. 8-32	4,166	63	13	-	4,5	3,4	6	3	-UNC8
	No. 10-24	4,826	70	16	-	6	4,9	8	3	-UNC10
	1/4-20	6,35	80	15	25	7	5,5	8	3	-UNC1/4
	5/16-18	7,938	90	18	29,5	8	6,2	9	3	-UNC5/16
	3/8-16	9,525	100	20	33,5	10	8	11	3	-UNC3/8

DIN 2184-1 3B	D _N -P Nom	D _N mm	l ₁ js16 mm	L _c mm	l ₃ ±1 mm	d ₁ h9 mm	□ h12 mm	l _g mm	N	uncoated designation 22257
	7/16-14	11,113	100	20	-	8	6,2	9	4	-UNC7/16
	1/2-13	12,7	110	23	-	9	7	10	4	-UNC1/2
	9/16-12	14,288	110	25	-	11	9	12	4	-UNC9/16
	5/8-11	15,875	110	25	-	12	9	12	4	-UNC5/8
	3/4-10	19,05	125	30	-	14	11	14	4	-UNC3/4

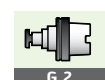

G 2



D 396

Machine tap Paradur® Eco HT



$\leq 3 \times D_N$

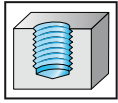

- HSS-E-PM
- chamfer form C = 2 - 3 thread
- 45° helix angle
- long-chipping materials from 500 to 1250 N/mm² or 38 HRC
- for long-chipping materials
- suitable for minimum quantity lubrication

UNC

ASME B1.1

	P	M	K	N	S	H	O
THL	●	●	●	●	●		●

~DIN 2184-1 2B	D _N -P Nom	D _N mm	l ₁ js16 mm	L _c mm	l ₃ ±1 mm	d ₁ h9 mm	□ h12 mm	l _g mm	N	THL designation E2251302
	No. 2-56	2,184	45	4	8,4	2,8	2,1	5	3	-UNC2 ⁴
	No. 4-40	2,845	56	6	11	3,5	2,7	6	3	-UNC4
	No. 6-32	3,505	56	6,5	13,7	4	3	6	3	-UNC6
	No. 8-32	4,166	63	7	17,8	4,5	3,4	6	3	-UNC8
	No. 10-24	4,826	70	8	20,7	6	4,9	8	3	-UNC10
	1/4-20	6,35	80	10	27,3	7	5,5	8	3	-UNC1/4

⁴without back taper

DIN 2184-1 2B	D _N -P Nom	D _N mm	l ₁ js16 mm	L _c mm	l ₃ ±1 mm	d ₁ h9 mm	□ h12 mm	l _g mm	N	THL designation E2256302
	5/16-18	7,938	90	13	-	6	4,9	8	3	-UNC5/16
	3/8-16	9,525	100	15	-	7	5,5	8	3	-UNC3/8
	1/2-13	12,7	110	18	-	9	7	10	4	-UNC1/2
	5/8-11	15,875	110	20	-	12	9	12	4	-UNC5/8

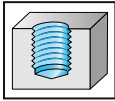

Machine tap Paradur® Eco HT

 $\leq 3 \times D_N$

- HSS-E-PM
- chamfer form C = 2 - 3 thread
- 45° helix angle
- long-chipping materials from 500 to 1250 N/mm² or 38 HRC
- for long-chipping materials

UNC

ASME B1.1

	P	M	K	N	S	H	O
THL	●	●	●	●	●		●

~DIN 2184-1 2B	D _N -P Nom	D _N mm	l ₁ js16 mm	L _c mm	l ₃ ±1 mm	d ₁ h9 mm	□ h12 mm	l _g mm	N	THL designation E2251312
										-UNC1/4
	1/4-20	6,35	80	10	27,3	7	5,5	8	3	-UNC1/4

DIN 2184-1 2B	D _N -P Nom	D _N mm	l ₁ js16 mm	L _c mm	l ₃ ±1 mm	d ₁ h9 mm	□ h12 mm	l _g mm	N	THL designation E2256312
										-UNC5/16
	5/16-18	7,938	90	13	-	6	4,9	8	3	-UNC5/16
	3/8-16	9,525	100	15	-	7	5,5	8	3	-UNC3/8
	1/2-13	12,7	110	18	-	9	7	10	4	-UNC1/2
	5/8-11	15,875	110	20	-	12	9	12	4	-UNC5/8
	3/4-10	19,05	125	25	-	14	11	14	4	-UNC3/4



Machine tap Paradur® N



$\leq 1,5 \times D_N$

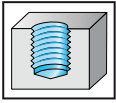

- HSS-E
- chamfer form C = 2 - 3 thread
- 15° helix angle
- materials from 200 to 1000 N/mm² or 32 HRC
- for long-chipping materials

UNC

ASME B1.1

	P	M	K	N	S	H	O
uncoated	●●	■	●●	●●	■	■	■

DIN 2184-1 2B	D _N -P Nom	D _N mm	l ₁ js16 mm	L _c mm	l ₃ ±1 mm	d ₁ h9 mm	□ h12 mm	l _g mm	N	uncoated designation 22410
	No. 1-64	1,854	45	4	9	2,8	2,1	5	3	-UNC1
	No. 2-56	2,184	45	4	12	2,8	2,1	5	3	-UNC2
	No. 3-48	2,515	50	4	12,5	2,8	2,1	5	3	-UNC3
	No. 4-40	2,845	56	6	18	3,5	2,7	6	3	-UNC4
	No. 5-40	3,175	56	6	18	3,5	2,7	6	3	-UNC5
	No. 6-32	3,505	56	6,5	20	4	3	6	3	-UNC6
	No. 8-32	4,166	63	7	21	4,5	3,4	6	3	-UNC8
	No. 10-24	4,826	70	8	25	6	4,9	8	3	-UNC10
	No. 12-24	5,486	80	10	30	6	4,9	8	3	-UNC12
	1/4-20	6,35	80	10	30	7	5,5	8	3	-UNC1/4
	5/16-18	7,938	90	12	35	8	6,2	9	3	-UNC5/16
	3/8-16	9,525	100	15	39	10	8	11	3	-UNC3/8

DIN 2184-1 2B	D _N -P Nom	D _N mm	l ₁ js16 mm	L _c mm	l ₃ ±1 mm	d ₁ h9 mm	□ h12 mm	l _g mm	N	uncoated designation 22460
	7/16-14	11,113	100	15	-	8	6,2	9	3	-UNC7/16
	1/2-13	12,7	110	18	-	9	7	10	3	-UNC1/2
	5/8-11	15,875	110	20	-	12	9	12	3	-UNC5/8
	3/4-10	19,05	125	25	-	14	11	14	4	-UNC3/4
	7/8-9	22,225	140	25	-	18	14,5	17	4	-UNC7/8
	1-8	25,4	160	30	-	18	14,5	17	4	-UNC1

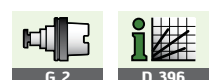

Machine tap Paradur® N

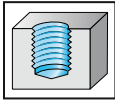
 $\leq 1,5 \times D_N$

- HSS-E
- chamfer form C = 2 - 3 thread
- 15° helix angle
- materials from 200 to 1000 N/mm² or 32 HRC
- for long-chipping materials

UNC

ASME B1.1

	P	M	K	N	S	H	O
uncoated	●●	●	●●	●●	●	●	●

DIN 2184-1 3B	D _N -P Nom	D _N mm	l ₁ js16 mm	L _c mm	l ₃ ±1 mm	d ₁ h9 mm	□ h12 mm	l _g mm	N	uncoated designation 22400
	No. 1-64	1,854	45	4	9	2,8	2,1	5	3	-UNC1
	No. 2-56	2,184	45	4	12	2,8	2,1	5	3	-UNC2
	No. 3-48	2,515	50	4	12,5	2,8	2,1	5	3	-UNC3
	No. 4-40	2,845	56	6	18	3,5	2,7	6	3	-UNC4
	No. 5-40	3,175	56	6	18	3,5	2,7	6	3	-UNC5
	No. 6-32	3,505	56	6,5	20	4	3	6	3	-UNC6
	No. 8-32	4,166	63	7	21	4,5	3,4	6	3	-UNC8
	No. 10-24	4,826	70	8	25	6	4,9	8	3	-UNC10
	No. 12-24	5,486	80	10	30	6	4,9	8	3	-UNC12
	1/4-20	6,35	80	10	30	7	5,5	8	3	-UNC1/4
	5/16-18	7,938	90	12	35	8	6,2	9	3	-UNC5/16
	3/8-16	9,525	100	15	39	10	8	11	3	-UNC3/8

DIN 2184-1 3B	D _N -P Nom	D _N mm	l ₁ js16 mm	L _c mm	l ₃ ±1 mm	d ₁ h9 mm	□ h12 mm	l _g mm	N	uncoated designation 22450
	5/16-18	7,938	90	12	-	6	4,9	8	3	-UNC5/16
	3/8-16	9,525	100	15	-	7	5,5	8	3	-UNC3/8
	7/16-14	11,113	100	15	-	8	6,2	9	3	-UNC7/16
	1/2-13	12,7	110	18	-	9	7	10	3	-UNC1/2
	5/8-11	15,875	110	20	-	12	9	12	3	-UNC5/8
	3/4-10	19,05	125	25	-	14	11	14	4	-UNC3/4
	7/8-9	22,225	140	25	-	18	14,5	17	4	-UNC7/8
	1-8	25,4	160	30	-	18	14,5	17	4	-UNC1



G 2



D 396

Machine tap Paradur® WSH

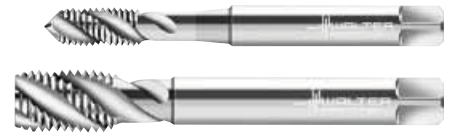

$\leq 3 \times D_N$

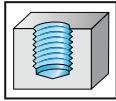

- HSS-E
- chamfer form C = 2 - 3 thread
- 45° helix angle
- materials from 200 to 1000 N/mm² or 32 HRC
- for long-chipping materials

UNC

ASME B1.1

	P	M	K	N	S	H	O
uncoated	●●		●	●			

DIN 2184-1 2B	D _N -P Nom	D _N mm	l ₁ js16 mm	L _c mm	l ₃ ±1 mm	d ₁ h9 mm	□ h12 mm	l _g mm	N	uncoated designation 225170
	No. 2-56	2,184	45	4	12	2,8	2,1	5	3	-UNC2
	No. 3-48	2,515	50	4	12,5	2,8	2,1	5	3	-UNC3
	No. 4-40	2,845	56	6	18	3,5	2,7	6	3	-UNC4
	No. 5-40	3,175	56	6	18	3,5	2,7	6	3	-UNC5
	No. 6-32	3,505	56	6,5	20	4	3	6	3	-UNC6
	No. 8-32	4,166	63	7	21	4,5	3,4	6	3	-UNC8
	No. 10-24	4,826	70	8	25	6	4,9	8	3	-UNC10
	No. 12-24	5,486	80	10	30	6	4,9	8	3	-UNC12
	1/4-20	6,35	80	10	30	7	5,5	8	3	-UNC1/4
	5/16-18	7,938	90	12	35	8	6,2	9	3	-UNC5/16
	3/8-16	9,525	100	15	39	10	8	11	3	-UNC3/8

DIN 2184-1 2B	D _N -P Nom	D _N mm	l ₁ js16 mm	L _c mm	l ₃ ±1 mm	d ₁ h9 mm	□ h12 mm	l _g mm	N	uncoated designation 225670
	7/16-14	11,113	100	15	-	8	6,2	9	3	-UNC7/16
	1/2-13	12,7	110	18	-	9	7	10	4	-UNC1/2
	9/16-12	14,288	110	20	-	11	9	12	4	-UNC9/16
	5/8-11	15,875	110	20	-	12	9	12	4	-UNC5/8
	3/4-10	19,05	125	25	-	14	11	14	4	-UNC3/4
	7/8-9	22,225	140	25	-	18	14,5	17	4	-UNC7/8
	1-8	25,4	160	30	-	18	14,5	17	4	-UNC1
	1 1/8-7	28,575	180	35	-	22	18	21	4	-UNC1.1/8
	1 1/4-7	31,75	180	35	-	22	18	21	4	-UNC1.1/4
	1 1/2-6	38,1	200	40	-	28	22	25	4	-UNC1.1/2

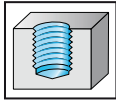

Machine tap Paradur® WSH

 $\leq 3 \times D_N$

- HSS-E
- chamfer form C = 2 - 3 thread
- 45° helix angle
- materials from 200 to 1000 N/mm² or 32 HRC
- for long-chipping materials

UNC

ASME B1.1

	P	M	K	N	S	H	O
uncoated	●	●	●	●			

DIN 2184-1 3B	D _N -P Nom	D _N mm	l ₁ js16 mm	L _c mm	l ₃ ±1 mm	d ₁ h9 mm	□ h12 mm	l _g mm	N	uncoated designation 225174
	No. 2-56	2,184	45	4	12	2,8	2,1	5	3	-UNC2
	No. 3-48	2,515	50	4	12,5	2,8	2,1	5	3	-UNC3
	No. 4-40	2,845	56	6	18	3,5	2,7	6	3	-UNC4
	No. 5-40	3,175	56	6	18	3,5	2,7	6	3	-UNC5
	No. 6-32	3,505	56	6,5	20	4	3	6	3	-UNC6
	No. 8-32	4,166	63	7	21	4,5	3,4	6	3	-UNC8
	No. 10-24	4,826	70	8	25	6	4,9	8	3	-UNC10
	No. 12-24	5,486	80	10	30	6	4,9	8	3	-UNC12
	1/4-20	6,35	80	10	30	7	5,5	8	3	-UNC1/4
	5/16-18	7,938	90	12	35	8	6,2	9	3	-UNC5/16
	3/8-16	9,525	100	15	39	10	8	11	3	-UNC3/8

DIN 2184-1 3B	D _N -P Nom	D _N mm	l ₁ js16 mm	L _c mm	l ₃ ±1 mm	d ₁ h9 mm	□ h12 mm	l _g mm	N	uncoated designation 225674
	5/16-18	7,938	90	13	-	6	4,9	8	3	-UNC5/16
	3/8-16	9,525	100	15	-	7	5,5	8	3	-UNC3/8
	7/16-14	11,113	100	15	-	8	6,2	9	3	-UNC7/16
	1/2-13	12,7	110	18	-	9	7	10	4	-UNC1/2
	9/16-12	14,288	110	20	-	11	9	12	4	-UNC9/16
	5/8-11	15,875	110	20	-	12	9	12	4	-UNC5/8
	3/4-10	19,05	125	25	-	14	11	14	4	-UNC3/4
	7/8-9	22,225	140	25	-	18	14,5	17	4	-UNC7/8
	1-8	25,4	160	30	-	18	14,5	17	4	-UNC1
	1 1/8-7	28,575	180	35	-	22	18	21	4	-UNC1.1/8
	1 1/4-7	31,75	180	35	-	22	18	21	4	-UNC1.1/4
	1 1/2-6	38,1	200	40	-	28	22	25	4	-UNC1.1/2



Machine tap Paradur Inox®



$\leq 2,5 \times D_N$

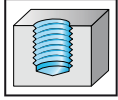

- HSS-E
- chamfer form C = 2 - 3 thread
- 40° helix angle
- materials from 350 to 1200 N/mm² or 36 HRC
- for long-chipping materials

UNC

ASME B1.1

	P	M	K	N	S	H	O
vap	●	●	●	●	●	●	●
TiN	●	●	●	●	●	●	●

DIN 2184-1 2B	D _N -P Nom	D _N mm	l ₁ js16 mm	L _c mm	l ₃ ±1 mm	d ₁ h9 mm	□ h12 mm	l _g mm	N	VAP designation 22513	TIN designation 225135
	No. 2-56	2,184	45	4	12	2,8	2,1	5	3	-UNC2 ⁴	-UNC2 ⁴
	No. 3-48	2,515	50	4	12,5	2,8	2,1	5	3	-UNC3	-UNC3
	No. 4-40	2,845	56	6	18	3,5	2,7	6	3	-UNC4	-UNC4
	No. 5-40	3,175	56	6	18	3,5	2,7	6	3	-UNC5	-UNC5
	No. 6-32	3,505	56	6,5	20	4	3	6	3	-UNC6	-UNC6
	No. 8-32	4,166	63	7	21	4,5	3,4	6	3	-UNC8	-UNC8
	No. 10-24	4,826	70	8	25	6	4,9	8	3	-UNC10	-UNC10
	No. 12-24	5,486	80	10	30	6	4,9	8	3	-UNC12	-UNC12
	1/4-20	6,35	80	10	30	7	5,5	8	3	-UNC1/4	-UNC1/4

⁴without back taper

DIN 2184-1 2B	D _N -P Nom	D _N mm	l ₁ js16 mm	L _c mm	l ₃ ±1 mm	d ₁ h9 mm	□ h12 mm	l _g mm	N	VAP designation 22563	TIN designation 225635
	5/16-18	7,938	90	13	-	6	4,9	8	3	-UNC5/16	-UNC5/16
	3/8-16	9,525	100	15	-	7	5,5	8	3	-UNC3/8	-UNC3/8
	7/16-14	11,113	100	15	-	8	6,2	9	3	-UNC7/16	-UNC7/16
	1/2-13	12,7	110	18	-	9	7	10	4	-UNC1/2	-UNC1/2
	9/16-12	14,288	110	20	-	11	9	12	4	-UNC9/16	-UNC9/16
	5/8-11	15,875	110	20	-	12	9	12	4	-UNC5/8	-UNC5/8
	3/4-10	19,05	125	25	-	14	11	14	4	-UNC3/4	-UNC3/4
	7/8-9	22,225	140	25	-	18	14,5	17	4	-UNC7/8	-UNC7/8
	1-8	25,4	160	30	-	18	14,5	17	4	-UNC1	-UNC1
	1 1/8-7	28,575	180	35	-	22	18	21	5	-UNC1.1/8	
	1 1/4-7	31,75	180	35	-	22	18	21	5	-UNC1.1/4	
	1 1/2-6	38,1	200	40	-	28	22	25	5	-UNC1.1/2	

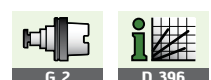

Machine tap Paradur® Eco CI

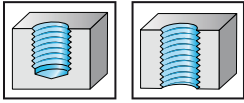
 $\leq 3 \times D_N$

- HSS-E-PM
- chamfer form C = 2 - 3 thread
- materials from 100 to 1000 N/mm² or 32 HRC
- for short-chipping materials
- suitable for minimum quantity lubrication
- Xtra-treat™ surface treatment

UNC

ASME B1.1

	P	M	K	N	S	H	O
nid			●●	●●			●●

DIN 2184-1 2B

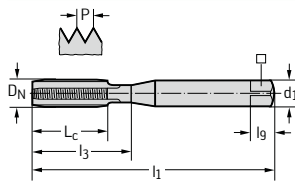

D _N -P Nom	D _N mm	l ₁ js16 mm	L _c mm	l ₃ ±1 mm	d ₁ h9 mm	□ h12 mm	l _g mm	N	NID designation E22314
No. 6-32	3,505	56	11	20	4	3	6	3	-UNC6
No. 8-32	4,166	63	12	21	4,5	3,4	6	3	-UNC8
No. 10-24	4,826	70	13	25	6	4,9	8	4	-UNC10
1/4-20	6,35	80	15	30	7	5,5	8	4	-UNC1/4

DIN 2184-1 2B

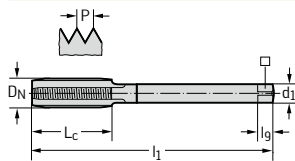

D _N -P Nom	D _N mm	l ₁ js16 mm	L _c mm	l ₃ ±1 mm	d ₁ h9 mm	□ h12 mm	l _g mm	N	NID designation E22364
5/16-18	7,938	90	18	-	6	4,9	8	4	-UNC5/16
3/8-16	9,525	100	20	-	7	5,5	8	4	-UNC3/8
7/16-14	11,113	100	20	-	8	6,2	9	4	-UNC7/16
1/2-13	12,7	110	23	-	9	7	10	4	-UNC1/2
9/16-12	14,288	110	25	-	11	9	12	4	-UNC9/16
5/8-11	15,875	110	25	-	12	9	12	4	-UNC5/8
3/4-10	19,05	125	30	-	14	11	14	4	-UNC3/4
7/8-9	22,225	140	30	-	18	14,5	17	4	-UNC7/8

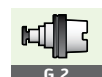

G 2



D 396

Machine tap Paradur® WLM



$\leq 3 \times D_N$

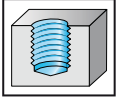

- HSS-E
- chamfer form C = 2 - 3 thread
- 35° helix angle
- materials from 200 to 700 N/mm² or 14 HRC
- for long-chipping materials

UNC

ASME B1.1

	P	M	K	N	S	H	O
uncoated				●●	●●		●●

DIN 2184-1 2B	D _N -P Nom	D _N mm	l ₁ js16 mm	L _c mm	l ₃ ±1 mm	d ₁ h9 mm	□ h12 mm	l _g mm	N	uncoated designation 22516
	No. 2-56	2,184	45	4	12	2,8	2,1	5	2	-UNC2
	No. 4-40	2,845	56	6	18	3,5	2,7	6	2	-UNC4
	No. 5-40	3,175	56	6	18	3,5	2,7	6	2	-UNC5
	No. 6-32	3,505	56	6,5	20	4	3	6	2	-UNC6
	No. 8-32	4,166	63	7	21	4,5	3,4	6	2	-UNC8
	No. 10-24	4,826	70	8	25	6	4,9	8	2	-UNC10
	No. 12-24	5,486	80	10	30	6	4,9	8	2	-UNC12
	1/4-20	6,35	80	10	30	7	5,5	8	2	-UNC1/4
	5/16-18	7,938	90	12	35	8	6,2	9	2	-UNC5/16
	3/8-16	9,525	100	15	39	10	8	11	2	-UNC3/8

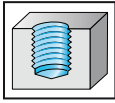

Machine tap Paradur® NI

 $\leq 1,5x D_N$

- HSS-E-PM
- chamfer form C = 2 - 3 thread
- 25° helix angle
- materials from 700 to 1400 N/mm² or 44 HRC
- for long-chipping materials

UNC

ASME B1.1

	P	M	K	N	S	H	O
uncoated	●				●●		

~DIN 2184-1 2B	D _N -P Nom	D _N mm	l ₁ js16 mm	L _c mm	l ₃ ±1 mm	d ₁ h9 mm	□ h12 mm	l _g mm	N	uncoated designation 224102
	No. 2-56	2,184	45	9	-	2,8	2,1	5	3	-UNC2 ¹
	No. 3-48	2,515	50	9	-	2,8	2,1	5	3	-UNC3 ¹
	No. 4-40	2,845	56	10	-	3,5	2,7	6	3	-UNC4 ¹
	No. 5-40	3,175	56	10	-	3,5	2,7	6	3	-UNC5 ¹
	No. 6-32	3,505	56	12	-	4	3	6	3	-UNC6 ¹
	No. 8-32	4,166	63	13	-	4,5	3,4	6	3	-UNC8 ¹
	No. 10-24	4,826	70	16	-	6	4,9	8	3	-UNC10 ¹
	1/4-20	6,35	80	15	25	7	5,5	8	3	-UNC1/4
	5/16-18	7,938	90	18	29,5	8	6,2	9	3	-UNC5/16
	3/8-16	9,525	100	20	33,5	10	8	11	4	-UNC3/8

¹without neck

DIN 2184-1 2B	D _N -P Nom	D _N mm	l ₁ js16 mm	L _c mm	l ₃ ±1 mm	d ₁ h9 mm	□ h12 mm	l _g mm	N	uncoated designation 224602
	7/16-14	11,113	100	20	-	8	6,2	9	4	-UNC7/16
	1/2-13	12,7	110	23	-	9	7	10	4	-UNC1/2
	9/16-12	14,288	110	25	-	11	9	12	4	-UNC9/16
	5/8-11	15,875	110	25	-	12	9	12	4	-UNC5/8
	3/4-10	19,05	125	30	-	14	11	14	5	-UNC3/4



G 2



D 396

Machine tap Paradur® NI



$\leq 1,5 \times D_N$

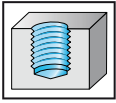

- HSS-E-PM
- chamfer form C = 2 - 3 thread
- 25° helix angle
- materials from 700 to 1400 N/mm² or 44 HRC
- for long-chipping materials

UNC

ASME B1.1

	P	M	K	N	S	H	O
uncoated	●				●●		

~DIN 2184-1 3B	D _N -P Nom	D _N mm	l ₁ js16 mm	L _c mm	l ₃ ±1 mm	d ₁ h9 mm	□ h12 mm	l _g mm	N	uncoated designation 224104
	No. 2-56	2,184	45	9	-	2,8	2,1	5	3	-UNC2
	No. 3-48	2,515	50	9	-	2,8	2,1	5	3	-UNC3
	No. 4-40	2,845	56	10	-	3,5	2,7	6	3	-UNC4
	No. 5-40	3,175	56	10	-	3,5	2,7	6	3	-UNC5
	No. 6-32	3,505	56	12	-	4	3	6	3	-UNC6
	No. 8-32	4,166	63	13	-	4,5	3,4	6	3	-UNC8
	No. 10-24	4,826	70	16	-	6	4,9	8	3	-UNC10
	1/4-20	6,35	80	15	25	7	5,5	8	3	-UNC1/4
	5/16-18	7,938	90	18	29,5	8	6,2	9	3	-UNC5/16
	3/8-16	9,525	100	20	33,5	10	8	11	4	-UNC3/8

DIN 2184-1 3B	D _N -P Nom	D _N mm	l ₁ js16 mm	L _c mm	l ₃ ±1 mm	d ₁ h9 mm	□ h12 mm	l _g mm	N	uncoated designation 224604
	7/16-14	11,113	100	20	-	8	6,2	9	4	-UNC7/16
	1/2-13	12,7	110	23	-	9	7	10	4	-UNC1/2
	9/16-12	14,288	110	25	-	11	9	12	4	-UNC9/16
	5/8-11	15,875	110	25	-	12	9	12	4	-UNC5/8
	3/4-10	19,05	125	30	-	14	11	14	5	-UNC3/4

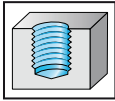

Machine tap Paradur® NI 10

 $\leq 1,5 \times D_N$

- HSS-E-PM
- chamfer form C = 2 - 3 thread
- 10° helix angle
- materials from 1000 to 1600 N/mm² or 49 HRC
- for long and short-chipping materials

UNJC

ASME B1.15
Outside diameter rounded

	P	M	K	N	S	H	O
uncoated	●●			●	●●		

~DIN 2184-1 3B	D _N -P Nom	D _N mm	l ₁ js16 mm	L _c mm	d ₁ h9 mm	□ h12 mm	l _g mm	N	uncoated designation 224101
	No. 4-40 UNJC	2,845	56	8	3,5	2,7	6	3	-UNJC4 ¹
	No. 6-32 UNJC	3,505	56	10	4	3	6	3	-UNJC6 ¹
	No. 8-32 UNJC	4,166	63	11	4,5	3,4	6	3	-UNJC8 ¹
	No. 10-24 UNJC	4,826	70	13,5	6	4,9	8	3	-UNJC10 ¹
	1/4-20 UNJC	6,35	80	17,5	7	5,5	8	3	-UNJC1/4 ¹
	5/16-18 UNJC	7,938	90	21	8	6,2	9	3	-UNJC5/16 ¹
	3/8-16 UNJC	9,525	100	25	10	8	11	3	-UNJC3/8 ¹

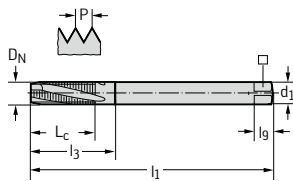

¹without neck

Machine tap Paradur® TI



$\leq 2 \times D_N$

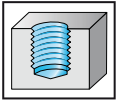

- HSS-E-PM
- chamfer form C = 2 - 3 thread
- 15° helix angle
- materials from 700 to 1400 N/mm² or 44 HRC
- for long-chipping materials

UNC

ASME B1.1

	P	M	K	N	S	H	O
uncoated	●●			●	●●		

~DIN 2184-1 2B	D _N -P Nom	D _N mm	l ₁ js16 mm	L _c mm	l ₃ ±1 mm	d ₁ h9 mm	□ h12 mm	l _g mm	N	uncoated designation 22416
	No. 6-32	3,505	56	12	-	4	3	6	3	-UNC6 ¹
	No. 8-32	4,166	63	13	-	4,5	3,4	6	3	-UNC8 ¹
	No. 10-24	4,826	70	16	-	6	4,9	8	3	-UNC10 ¹
	No. 12-24	5,486	80	15	23	6	4,9	8	3	-UNC12
	1/4-20	6,35	80	15	25	7	5,5	8	3	-UNC1/4
	5/16-18	7,938	90	18	29,5	8	6,2	9	3	-UNC5/16
	3/8-16	9,525	100	20	33,5	10	8	11	3	-UNC3/8

¹without neck

DIN 2184-1 2B	D _N -P Nom	D _N mm	l ₁ js16 mm	L _c mm	l ₃ ±1 mm	d ₁ h9 mm	□ h12 mm	l _g mm	N	uncoated designation 22466
	7/16-14	11,113	100	20	-	8	6,2	9	4	-UNC7/16
	1/2-13	12,7	110	23	-	9	7	10	4	-UNC1/2
	5/8-11	15,875	110	25	-	12	9	12	4	-UNC5/8

Machine tap Paradur® TI

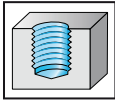
 $\leq 2 \times D_N$

- HSS-E-PM
- chamfer form C = 2 - 3 thread
- 15° helix angle
- materials from 700 to 1400 N/mm² or 44 HRC
- for long-chipping materials

UNC

ASME B1.1

	P	M	K	N	S	H	O
uncoated	●●			●	●●		

~DIN 2184-1 3B	D _N -P Nom	D _N mm	l ₁ js16 mm	L _c mm	l ₃ ±1 mm	d ₁ h9 mm	□ h12 mm	l _g mm	N	uncoated designation 224164
	No. 6-32	3,505	56	12	-	4	3	6	3	-UNC6
	No. 8-32	4,166	63	13	-	4,5	3,4	6	3	-UNC8
	No. 10-24	4,826	70	16	-	6	4,9	8	3	-UNC10
	1/4-20	6,35	80	15	25	7	5,5	8	3	-UNC1/4
	5/16-18	7,938	90	18	29,5	8	6,2	9	3	-UNC5/16
	3/8-16	9,525	100	20	33,5	10	8	11	3	-UNC3/8

DIN 2184-1 3B	D _N -P Nom	D _N mm	l ₁ js16 mm	L _c mm	l ₃ ±1 mm	d ₁ h9 mm	□ h12 mm	l _g mm	N	uncoated designation 224664
	7/16-14	11,113	100	20	-	8	6,2	9	4	-UNC7/16
	1/2-13	12,7	110	23	-	9	7	10	4	-UNC1/2
	5/8-11	15,875	110	25	-	12	9	12	4	-UNC5/8



Machine tap Paradur® HS



$\leq 3 \times D_N$

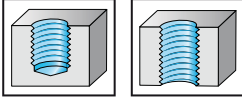

- solid carbide
- chamfer form C = 2 - 3 thread
- for materials to 55 HRC
- for short-chipping materials

UNC

ASME B1.1

	P	M	K	N	S	H	O
TiCN			●	●●	●	●	●●

~DIN 2184-1 2B	D _N -P Nom	D _N mm	l ₁ js16 mm	L _c mm	d ₁ h6 mm	□ h12 mm	l _g mm	N	TICN
									designation 8231106
	No. 10-24	4,826	70	16	6	4,9	8	3	-UNC10 ¹
	1/4-20	6,35	80	20	7	5,5	8	3	-UNC1/4 ¹
	5/16-18	7,938	90	25	8	6,2	9	3	-UNC5/16 ¹
	3/8-16	9,525	100	30	10	8	11	3	-UNC3/8 ¹
	1/2-13	12,7	110	36	12	9	12	3	-UNC1/2 ¹

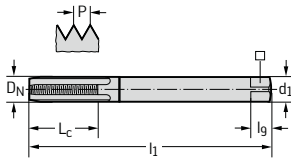

¹without neck

Machine tap Prototex® Eco HT

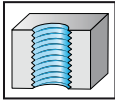
 $\leq 3,5 \times D_N$

- HSS-E-PM
- chamfer form B = 3.5 - 5 thread
- materials from 500 to 1350 N/mm² or 42 HRC
- for long-chipping materials
- suitable for minimum quantity lubrication

UNF

ASME B1.1

	P	M	K	N	S	H	O
THL	●	●	●	●	●		●

DIN 2184-1 2B	D _N -P Nom	D _N mm	l ₁ js16 mm	L _c mm	l ₃ ±1 mm	d ₁ h9 mm	□ h12 mm	l _g mm	N	THL designation E2321302
	No. 4-48	2,845	56	9	18	3,5	2,7	6	3	-UNF4
	No. 6-40	3,505	56	11	20	4	3	6	3	-UNF6
	No. 8-36	4,166	63	12	21	4,5	3,4	6	3	-UNF8
	No. 10-32	4,826	70	13	25	6	4,9	8	3	-UNF10
	1/4-28	6,35	80	15	30	7	5,5	8	3	-UNF1/4

DIN 2184-1 2B	D _N -P Nom	D _N mm	l ₁ js16 mm	L _c mm	l ₃ ±1 mm	d ₁ h9 mm	□ h12 mm	l _g mm	N	THL designation E2326302
	5/16-24	7,938	90	18	-	6	4,9	8	3	-UNF5/16
	3/8-24	9,525	100	20	-	7	5,5	8	3	-UNF3/8
	1/2-20	12,7	100	21	-	9	7	10	4	-UNF1/2
	5/8-18	15,875	100	21	-	12	9	12	4	-UNF5/8



Machine tap Prototex® Eco HT



$\leq 3,5 \times D_N$

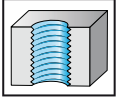

- HSS-E-PM
- chamfer form B = 3.5 - 5 thread
- materials from 500 to 1350 N/mm² or 42 HRC
- for long-chipping materials
- suitable for minimum quantity lubrication

UNF

ASME B1.1

	P	M	K	N	S	H	O
THL	●	●	●	●	●		●

DIN 2184-1 2B	D _N -P Nom	D _N mm	l ₁ js16 mm	L _c mm	l ₃ ±1 mm	d ₁ h9 mm	□ h12 mm	l _g mm	N	THL designation E2321342
	1/4-28	6,35	80	15	30	7	5,5	8	3	-UNF1/4

DIN 2184-1 2B	D _N -P Nom	D _N mm	l ₁ js16 mm	L _c mm	l ₃ ±1 mm	d ₁ h9 mm	□ h12 mm	l _g mm	N	THL designation E2326342
	5/16-24	7,938	90	18	-	6	4,9	8	3	-UNF5/16
	3/8-24	9,525	100	20	-	7	5,5	8	3	-UNF3/8
	1/2-20	12,7	100	21	-	9	7	10	4	-UNF1/2

Machine tap Prototex®

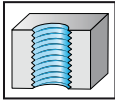
 $\leq 3 \times D_N$

- HSS-E
- chamfer form B = 3.5 - 5 thread
- materials from 200 to 700 N/mm² or 14 HRC
- for long-chipping materials

UNF

ASME B1.1

	P	M	K	N	S	H	O
uncoated	●●			●●			●
TiN	●●			●●			●

DIN 2184-1 2B

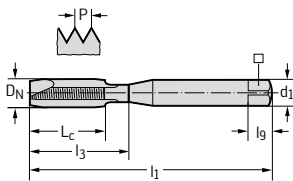

D _N -P Nom	D _N mm	l ₁ js16 mm	L _c mm	l ₃ ±1 mm	d ₁ h9 mm	□ h12 mm	l _g mm	N	uncoated designation 23210	TiN designation 2321005
No. 0-80	1,524	40	8	-	2,5	2,1	5	2	-UNF0 ¹	
No. 1-72	1,854	45	6	9	2,8	2,1	5	2	-UNF1	
No. 2-64	2,184	45	7	12	2,8	2,1	5	2	-UNF2	
No. 3-56	2,515	50	8	12,5	2,8	2,1	5	2	-UNF3	
No. 4-48	2,845	56	9	18	3,5	2,7	6	2	-UNF4	
No. 5-44	3,175	56	10	18	3,5	2,7	6	2	-UNF5	
No. 6-40	3,505	56	11	20	4	3	6	2	-UNF6	
No. 8-36	4,166	63	12	21	4,5	3,4	6	2	-UNF8	
No. 10-32	4,826	70	13	25	6	4,9	8	2	-UNF10	
No. 12-28	5,486	80	15	30	6	4,9	8	3	-UNF12	-UNF12
1/4-28	6,35	80	15	30	7	5,5	8	3	-UNF1/4	-UNF1/4

¹without neck

Machine tap Prototex®



$\leq 3 \times D_N$

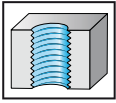

- HSS-E
- chamfer form B = 3.5 - 5 thread
- materials from 200 to 700 N/mm² or 14 HRC
- for long-chipping materials

UNF

ASME B1.1

	P	M	K	N	S	H	O
uncoated	●●			●●			●

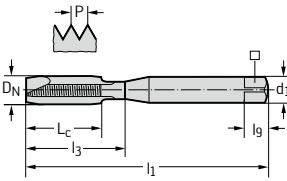
DIN 2184-1 3B	D _N -P Nom	D _N mm	l ₁ js16 mm	L _c mm	l ₃ ±1 mm	d ₁ h9 mm	□ h12 mm	l _g mm	N	uncoated designation 23200
	No. 0-80	1,524	40	8	-	2,5	2,1	5	2	-UNF0
	No. 1-72	1,854	45	6	9	2,8	2,1	5	2	-UNF1
	No. 2-64	2,184	45	7	12	2,8	2,1	5	2	-UNF2
	No. 3-56	2,515	50	8	12,5	2,8	2,1	5	2	-UNF3
	No. 4-48	2,845	56	9	18	3,5	2,7	6	2	-UNF4
	No. 5-44	3,175	56	10	18	3,5	2,7	6	2	-UNF5
	No. 6-40	3,505	56	11	20	4	3	6	2	-UNF6
	No. 8-36	4,166	63	12	21	4,5	3,4	6	2	-UNF8
	No. 10-32	4,826	70	13	25	6	4,9	8	2	-UNF10
	No. 12-28	5,486	80	15	30	6	4,9	8	3	-UNF12
	1/4-28	6,35	80	15	30	7	5,5	8	3	-UNF1/4

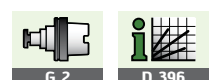

G 2

D 396

Machine tap Prototex® H

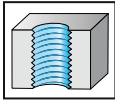
 $\leq 3 \times D_N$

- HSS-E
- chamfer form B = 3.5 - 5 thread
- materials from 200 to 1000 N/mm² or 32 HRC
- for long-chipping materials

UNF

ASME B1.1

	P	M	K	N	S	H	O
uncoated	●	●	●	●	●	●	●
TiN	●	●	●	●	●	●	●

DIN 2184-1 2B	D _N -P Nom	D _N mm	l ₁ js16 mm	L _c mm	d ₁ h9 mm	□ h12 mm	l _g mm	N	uncoated	TIN
									designation 23360	designation 2336005
	5/16-24	7,938	90	18	6	4,9	8	3	-UNF5/16	-UNF5/16
	3/8-24	9,525	100	20	7	5,5	8	3	-UNF3/8	-UNF3/8
	7/16-20	11,113	100	20	8	6,2	9	3	-UNF7/16	-UNF7/16
	1/2-20	12,7	100	21	9	7	10	4	-UNF1/2	-UNF1/2
	9/16-18	14,288	100	21	11	9	12	4	-UNF9/16	
	5/8-18	15,875	100	21	12	9	12	4	-UNF5/8	-UNF5/8
	3/4-16	19,05	110	24	14	11	14	4	-UNF3/4	-UNF3/4
	7/8-14	22,225	125	24	18	14,5	17	4	-UNF7/8	
	1-12	25,4	140	26	18	14,5	17	4	-UNF1	
	1 1/8-12	28,575	150	26	22	18	21	4	-UNF1.1/8	
	1 1/4-12	31,75	150	26	22	18	21	4	-UNF1.1/4	
	1 3/8-12	34,925	170	28	28	22	25	4	-UNF1.3/8	
	1 1/2-12	38,1	170	28	28	22	25	4	-UNF1.1/2	



G 2



D 396

Machine tap Prototex Inox®



$\leq 3 \times D_N$

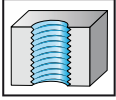

- HSS-E
- chamfer form B = 3.5 - 5 thread
- materials from 350 to 1200 N/mm² or 36 HRC
- for long-chipping materials

UNF

ASME B1.1

	P	M	K	N	S	H	O
vap	●	●	●	●	●	●	●
TiN	●	●	●	●	●	●	●

DIN 2184-1 2B	D _N -P Nom	D _N mm	l ₁ js16 mm	L _c mm	l ₃ ±1 mm	d ₁ h9 mm	□ h12 mm	l _g mm	N	VAP designation 23213	TIN designation 2321305
	No. 5-44	3,175	56	10	18	3,5	2,7	6	2	-UNF5	
	No. 6-40	3,505	56	11	20	4	3	6	2	-UNF6	
	No. 8-36	4,166	63	12	21	4,5	3,4	6	2	-UNF8	
	No. 10-32	4,826	70	13	25	6	4,9	8	3	-UNF10	-UNF10
	No. 12-28	5,486	80	15	30	6	4,9	8	3	-UNF12	
	1/4-28	6,35	80	15	30	7	5,5	8	3	-UNF1/4	-UNF1/4

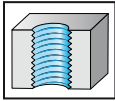

Machine tap Prototex Inox®

 $\leq 3 \times D_N$

- HSS-E
- chamfer form B = 3.5 - 5 thread
- materials from 350 to 1200 N/mm² or 36 HRC
- for long-chipping materials

UNF

ASME B1.1

	P	M	K	N	S	H	O
vap	●●	●●	●	●	●	●	●
TiN	●●	●●	●	●	●	●	●

DIN 2184-1 2B	D _N -P Nom	D _N mm	l ₁ js16 mm	L _c mm	d ₁ h9 mm	□ h12 mm	l _g mm	N	VAP designation 23263	TIN designation 2326305
	5/16-24	7,938	90	18	6	4,9	8	3	-UNF5/16	-UNF5/16
	3/8-24	9,525	100	20	7	5,5	8	3	-UNF3/8	-UNF3/8
	7/16-20	11,113	100	20	8	6,2	9	3	-UNF7/16	-UNF7/16
	1/2-20	12,7	100	21	9	7	10	4	-UNF1/2	-UNF1/2
	9/16-18	14,288	100	21	11	9	12	4	-UNF9/16	
	5/8-18	15,875	100	21	12	9	12	4	-UNF5/8	
	3/4-16	19,05	110	24	14	11	14	4	-UNF3/4	
	7/8-14	22,225	125	24	18	14,5	17	4	-UNF7/8	
	1-12	25,4	140	26	18	14,5	17	4	-UNF1	



Machine tap Prototex® TiNi



$$\leq 2 \times D_N$$

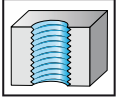

- HSS-E-PM
- chamfer form B = 3.5 - 5 thread
- materials from 700 to 1400 N/mm² or 44 HRC
- for long-chipping materials

UNF

ASME B1.1

	P	M	K	N	S	H	O
uncoated	●●	●●	●●	●	●●		

~DIN 2184-1 2B		D_N -P Nom	D_N mm	l_1 js16 mm	L_c mm	l_3 ± 1 mm	d_1 h9 mm	\square h12 mm	l_g mm	N	uncoated designation 23217
	No. 5-44	3,175	56	10	-	3,5	2,7	6	2	-UNF5	
	No. 6-40	3,505	56	12	-	4	3	6	3	-UNF6	
	No. 10-32	4,826	70	16	-	6	4,9	8	3	-UNF10	
	1/4-28	6,35	80	15	25	7	5,5	8	3	-UNF1/4	
	5/16-24	7,938	90	18	29,5	8	6,2	9	3	-UNF5/16	
	3/8-24	9,525	100	20	33,5	10	8	11	3	-UNF3/8	

DIN 2184-1 2B		D_N -P Nom	D_N mm	l_1 js16 mm	L_c mm	l_3 ± 1 mm	d_1 h9 mm	\square h12 mm	l_g mm	N	uncoated designation 23267
	7/16-20	11,113	100	20	-	8	6,2	9	4	-UNF7/16	
	1/2-20	12,7	100	23	-	9	7	10	4	-UNF1/2	
	5/8-18	15,875	100	25	-	12	9	12	4	-UNF5/8	

Machine tap Prototex® TiNi

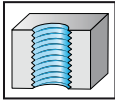
 $\leq 2 \times D_N$

- HSS-E-PM
- chamfer form B = 3.5 - 5 thread
- materials from 700 to 1400 N/mm² or 44 HRC
- for long-chipping materials

UNF

ASME B1.1

	P	M	K	N	S	H	O
uncoated	●●	●●	■	●	●●		

~DIN 2184-1 3B	D _N -P Nom	D _N mm	l ₁ js16 mm	L _c mm	l ₃ ±1 mm	d ₁ h9 mm	□ h12 mm	l ₉ mm	N	uncoated designation 23207
	No. 4-48	2,845	56	10	-	3,5	2,7	6	2	-UNF4 ¹
	No. 5-44	3,175	56	10	-	3,5	2,7	6	2	-UNF5 ¹
	No. 6-40	3,505	56	12	-	4	3	6	3	-UNF6 ¹
	No. 8-36	4,166	63	13	-	4,5	3,4	6	3	-UNF8 ¹
	No. 10-32	4,826	70	16	-	6	4,9	8	3	-UNF10 ¹
	1/4-28	6,35	80	15	25	7	5,5	8	3	-UNF1/4
	5/16-24	7,938	90	18	29,5	8	6,2	9	3	-UNF5/16
	3/8-24	9,525	100	20	33,5	10	8	11	3	-UNF3/8

¹without neck

DIN 2184-1 3B	D _N -P Nom	D _N mm	l ₁ js16 mm	L _c mm	l ₃ ±1 mm	d ₁ h9 mm	□ h12 mm	l ₉ mm	N	uncoated designation 23257
	7/16-20	11,113	100	20	-	8	6,2	9	4	-UNF7/16
	1/2-20	12,7	100	23	-	9	7	10	4	-UNF1/2
	5/8-18	15,875	100	25	-	12	9	12	4	-UNF5/8



Machine tap Prototex® TiNi Plus



$\leq 2 \times D_N$

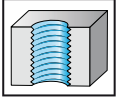

- HSS-E-PM
- chamfer form B = 3.5 - 5 thread
- materials from 700 to 1400 N/mm² or 44 HRC
- for long-chipping materials
- outside diameter rounded

UNJF

ASME B1.15

	P	M	K	N	S	H	O
ACN					●●		

~DIN 2184-1 3B	D _N -P Nom	D _N mm	l ₁ js16 mm	L _c mm	l ₃ ±1 mm	d ₁ h9 mm	□ h12 mm	l _g mm	N	ACN designation 2320763
	No. 10-32 UNJF	4,826	70	16	-	6	4,9	8	3	-UNJF10 ¹
	1/4-28 UNJF	6,35	80	15	25	7	5,5	8	3	-UNJF1/4
	5/16-24 UNJF	7,938	90	18	29,5	8	6,2	9	3	-UNJF5/16
	3/8-24 UNJF	9,525	100	20	33,5	10	8	11	3	-UNJF3/8

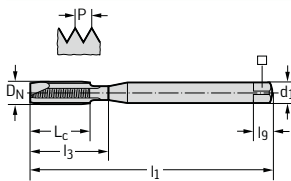

¹without neck

Machine tap Prototex® H

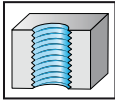
 $\leq 3 \times D_N$

- HSS-E
- chamfer form B = 3.5 - 5 thread
- materials from 200 to 1000 N/mm² or 32 HRC
- for long-chipping materials

UNEF

ASME B1.1

	P	M	K	N	S	H	O
uncoated	●●		●	●●			●

DIN 2184-1 2B	D _N -P Nom	D _N mm	l ₁ js16 mm	L _c mm	d ₁ h9 mm	□ h12 mm	l _g mm	N	uncoated designation 233602
	1/4-32	6,35	80	15	4,5	3,4	6	3	-UNEF1/4
	5/16-32	7,938	90	18	6	4,9	8	3	-UNEF5/16
	3/8-32	9,525	90	20	7	5,5	8	3	-UNEF3/8
	7/16-28	11,113	90	20	8	6,2	9	3	-UNEF7/16
	1/2-28	12,7	100	21	9	7	10	4	-UNEF1/2
	9/16-24	14,288	100	21	11	9	12	4	-UNEF9/16
	5/8-24	15,875	100	21	12	9	12	4	-UNEF5/8
	11/16-24	17,462	110	24	14	11	14	4	-UNEF11/16
	3/4-20	19,05	110	24	14	11	14	4	-UNEF3/4
	7/8-20	22,225	125	24	18	14,5	17	4	-UNEF7/8
	1-20	25,4	140	26	18	14,5	17	4	-UNEF1



G 2



D 396

Machine tap Paradur® Eco HT



$\leq 3 \times D_N$

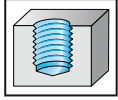

- HSS-E-PM
- chamfer form C = 2 - 3 thread
- 45° helix angle
- long-chipping materials from 500 to 1250 N/mm² or 38 HRC
- for long-chipping materials
- suitable for minimum quantity lubrication

UNF

ASME B1.1

	P	M	K	N	S	H	O
THL	●	●	●	●	●		●

~DIN 2184-1 2B		D_N -P Nom	D_N mm	l_1 js16 mm	L_c mm	l_3 ± 1 mm	d_1 h9 mm	\square h12 mm	l_g mm	N	THL designation E2351302
	No. 4-48	2,845	56	6	11	3,5	2,7	6	3	-UNF4	
	No. 6-40	3,505	56	6,5	13,1	4	3	6	3	-UNF6	
	No. 8-36	4,166	63	7	17,4	4,5	3,4	6	3	-UNF8	
	No. 10-32	4,826	70	8	20,7	6	4,9	8	3	-UNF10	
	1/4-28	6,35	80	10	25,9	7	5,5	8	3	-UNF1/4	

DIN 2184-1 2B		D_N -P Nom	D_N mm	l_1 js16 mm	L_c mm	l_3 ± 1 mm	d_1 h9 mm	\square h12 mm	l_g mm	N	THL designation E2356302
	5/16-24	7,938	90	13	-	6	4,9	8	3	-UNF5/16	
	3/8-24	9,525	100	15	-	7	5,5	8	3	-UNF3/8	
	1/2-20	12,7	100	13	-	9	7	10	4	-UNF1/2	
	5/8-18	15,875	100	15	-	12	9	12	4	-UNF5/8	



Machine tap Paradur® Eco HT

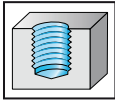

 $\leq 3 \times D_N$

- HSS-E-PM
- chamfer form C = 2 - 3 thread
- 45° helix angle
- long-chipping materials from 500 to 1250 N/mm² or 38 HRC
- for long-chipping materials

UNF

ASME B1.1

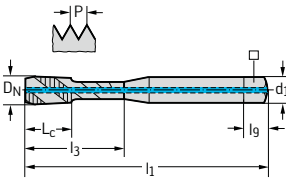
	P	M	K	N	S	H	O
THL	●	●	●	●	●		●

~DIN 2184-1 2B	D _N -P Nom	D _N mm	l ₁ js16 mm	L _c mm	l ₃ ±1 mm	d ₁ h9 mm	□ h12 mm	l _g mm	N	THL designation
										E2351312
	1/4-28	6,35	80	10	25,9	7	5,5	8	3	-UNF1/4

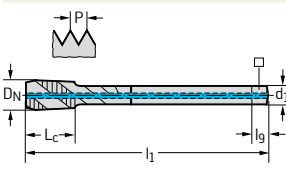
DIN 2184-1 2B	D _N -P Nom	D _N mm	l ₁ js16 mm	L _c mm	l ₃ ±1 mm	d ₁ h9 mm	□ h12 mm	l _g mm	N	THL designation
										E2356312
	5/16-24	7,938	90	12	-	6	4,9	8	3	-UNF5/16
	3/8-24	9,525	100	15	-	7	5,5	8	3	-UNF3/8
	1/2-20	12,7	100	13	-	9	7	10	4	-UNF1/2
	5/8-18	15,875	100	15	-	12	9	12	4	-UNF5/8



Machine tap Paradur® N



$\leq 1,5 \times D_N$

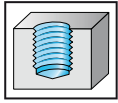

- HSS-E
- chamfer form C = 2 - 3 thread
- 15° helix angle
- materials from 200 to 1000 N/mm² or 32 HRC
- for long-chipping materials

UNF

ASME B1.1

	P	M	K	N	S	H	O
uncoated	●●	■	●●	●●	■	■	■

DIN 2184-1 2B	D _N -P Nom	D _N mm	l ₁ js16 mm	L _c mm	l ₃ ±1 mm	d ₁ h9 mm	□ h12 mm	l _g mm	N	uncoated designation 23410
	No. 0-80	1,524	40	6	-	2,5	2,1	5	3	-UNF0 ¹
	No. 1-72	1,854	45	4	9	2,8	2,1	5	3	-UNF1
	No. 2-64	2,184	45	4	12	2,8	2,1	5	3	-UNF2
	No. 4-48	2,845	56	6	18	3,5	2,7	6	3	-UNF4
	No. 5-44	3,175	56	6	18	3,5	2,7	6	3	-UNF5
	No. 6-40	3,505	56	6,5	20	4	3	6	3	-UNF6
	No. 8-36	4,166	63	7	21	4,5	3,4	6	3	-UNF8
	No. 10-32	4,826	70	8	25	6	4,9	8	3	-UNF10
	No. 12-28	5,486	80	10	30	6	4,9	8	3	-UNF12
	1/4-28	6,35	80	10	30	7	5,5	8	3	-UNF1/4
	5/16-24	7,938	90	12	35	8	6,2	9	3	-UNF5/16
	3/8-24	9,525	100	15	39	10	8	11	3	-UNF3/8

¹without neck

DIN 2184-1 2B	D _N -P Nom	D _N mm	l ₁ js16 mm	L _c mm	l ₃ ±1 mm	d ₁ h9 mm	□ h12 mm	l _g mm	N	uncoated designation 23460
	5/16-24	7,938	90	13	-	6	4,9	8	3	-UNF5/16
	3/8-24	9,525	100	15	-	7	5,5	8	3	-UNF3/8
	7/16-20	11,113	100	15	-	8	6,2	9	3	-UNF7/16
	1/2-20	12,7	100	13	-	9	7	10	3	-UNF1/2
	9/16-18	14,288	100	15	-	11	9	12	4	-UNF9/16
	5/8-18	15,875	100	15	-	12	9	12	4	-UNF5/8
	3/4-16	19,05	110	17	-	14	11	14	4	-UNF3/4
	7/8-14	22,225	125	18	-	18	14,5	17	4	-UNF7/8
	1-12	25,4	140	20	-	18	14,5	17	4	-UNF1

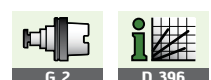

Machine tap Paradur® N

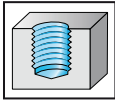
 $\leq 1,5 \times D_N$

- HSS-E
- chamfer form C = 2 - 3 thread
- 15° helix angle
- materials from 200 to 1000 N/mm² or 32 HRC
- for long-chipping materials

UNF

ASME B1.1

	P	M	K	N	S	H	O
uncoated	●●	●	●●	●●	●	●	●

DIN 2184-1 3B	D _N -P Nom	D _N mm	l ₁ js16 mm	L _c mm	l ₃ ±1 mm	d ₁ h9 mm	□ h12 mm	l _g mm	N	uncoated designation 23400
	No. 0-80	1,524	40	6	-	2,5	2,1	5	3	-UNF0
	No. 1-72	1,854	45	4	9	2,8	2,1	5	3	-UNF1
	No. 2-64	2,184	45	4	12	2,8	2,1	5	3	-UNF2
	No. 4-48	2,845	56	6	18	3,5	2,7	6	3	-UNF4
	No. 5-44	3,175	56	6	18	3,5	2,7	6	3	-UNF5
	No. 6-40	3,505	56	6,5	20	4	3	6	3	-UNF6
	No. 8-36	4,166	63	7	21	4,5	3,4	6	3	-UNF8
	No. 10-32	4,826	70	8	25	6	4,9	8	3	-UNF10
	No. 12-28	5,486	80	10	30	6	4,9	8	3	-UNF12
	1/4-28	6,35	80	10	30	7	5,5	8	3	-UNF1/4
	5/16-24	7,938	90	12	35	8	6,2	9	3	-UNF5/16
	3/8-24	9,525	100	15	39	10	8	11	3	-UNF3/8

DIN 2184-1 3B	D _N -P Nom	D _N mm	l ₁ js16 mm	L _c mm	l ₃ ±1 mm	d ₁ h9 mm	□ h12 mm	l _g mm	N	uncoated designation 23450
	5/16-24	7,938	90	13	-	6	4,9	8	3	-UNF5/16
	3/8-24	9,525	100	15	-	7	5,5	8	3	-UNF3/8
	7/16-20	11,113	100	15	-	8	6,2	9	3	-UNF7/16
	1/2-20	12,7	100	13	-	9	7	10	3	-UNF1/2
	9/16-18	14,288	100	15	-	11	9	12	4	-UNF9/16
	5/8-18	15,875	100	15	-	12	9	12	4	-UNF5/8
	3/4-16	19,05	110	17	-	14	11	14	4	-UNF3/4
	7/8-14	22,225	125	18	-	18	14,5	17	4	-UNF7/8
1-12	25,4	140	20	-	18	14,5	17	4	-UNF1	



Machine tap Paradur® WSH



$\leq 3 \times D_N$

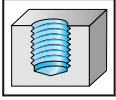

- HSS-E
- chamfer form C = 2 - 3 thread
- 45° helix angle
- materials from 200 to 1000 N/mm² or 32 HRC
- for long-chipping materials

UNF

ASME B1.1

	P	M	K	N	S	H	O
uncoated	●●		●	●			
TiN	●●		●	●			

DIN 2184-1 2B	D _N -P Nom	D _N mm	l ₁ js16 mm	L _c mm	l ₃ ±1 mm	d ₁ h9 mm	□ h12 mm	l _g mm	N	uncoated	TiN
										designation 235170	designation 2351705
	No. 1-72	1,854	45	4	9	2,8	2,1	5	3	-UNF1	
	No. 2-64	2,184	45	4	12	2,8	2,1	5	3	-UNF2	
	No. 3-56	2,515	50	4	12,5	2,8	2,1	5	3	-UNF3	
	No. 4-48	2,845	56	6	18	3,5	2,7	6	3	-UNF4	
	No. 5-44	3,175	56	6	18	3,5	2,7	6	3	-UNF5	
	No. 6-40	3,505	56	6,5	20	4	3	6	3	-UNF6	
	No. 8-36	4,166	63	7	21	4,5	3,4	6	3	-UNF8	
	No. 10-32	4,826	70	8	25	6	4,9	8	3	-UNF10	-UNF10
	No. 12-28	5,486	80	10	30	6	4,9	8	3	-UNF12	
	1/4-28	6,35	80	10	30	7	5,5	8	3	-UNF1/4	-UNF1/4

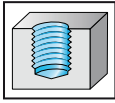

Machine tap Paradur® WSH

 $\leq 3 \times D_N$

- HSS-E
- chamfer form C = 2 - 3 thread
- 45° helix angle
- materials from 200 to 1000 N/mm² or 32 HRC
- for long-chipping materials

UNF

ASME B1.1

	P	M	K	N	S	H	O
uncoated	●●		●	●			
TiN	●●		●	●			

DIN 2184-1 2B	D _N -P Nom	D _N mm	l ₁ js16 mm	L _c mm	d ₁ h9 mm	□ h12 mm	l _g mm	N	uncoated designation 235670	TIN designation 2356705
	5/16-24	7,938	90	13	6	4,9	8	3	-UNF5/16	-UNF5/16
	3/8-24	9,525	100	15	7	5,5	8	3	-UNF3/8	-UNF3/8
	7/16-20	11,113	100	15	8	6,2	9	3	-UNF7/16	-UNF7/16
	1/2-20	12,7	100	13	9	7	10	4	-UNF1/2	-UNF1/2
	9/16-18	14,288	100	15	11	9	12	4	-UNF9/16	-UNF9/16
	5/8-18	15,875	100	15	12	9	12	4	-UNF5/8	-UNF5/8
	3/4-16	19,05	110	17	14	11	14	4	-UNF3/4	-UNF3/4
	7/8-14	22,225	125	18	18	14,5	17	4	-UNF7/8	-UNF7/8
	1-12	25,4	140	20	18	14,5	17	5	-UNF1	-UNF1
	1 1/8-12	28,575	150	20	22	18	21	5	-UNF1.1/8	
	1 1/4-12	31,75	150	20	22	18	21	5	-UNF1.1/4	
	1 3/8-12	34,925	170	22	28	22	25	5	-UNF1.3/8	
	1 1/2-12	38,1	170	22	28	22	25	5	-UNF1.1/2	



G 2



D 396

Machine tap Paradur Inox®



$\leq 2,5 \times D_N$

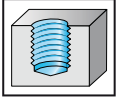

- HSS-E
- chamfer form C = 2 - 3 thread
- 40° helix angle
- materials from 350 to 1200 N/mm² or 36 HRC
- for long-chipping materials

UNF

ASME B1.1

	P	M	K	N	S	H	O
vap	●	●	●	●	●	●	●
TiN	●	●	●	●	●	●	●

DIN 2184-1 2B	D_N -P Nom	D_N mm	l_1 js16 mm	L_c mm	l_3 ± 1 mm	d_1 h9 mm	\square h12 mm	l_g mm	N	VAP designation 23513	TIN designation 235135
	No. 6-40	3,505	56	6,5	20	4	3	6	3	-UNF6	-UNF6
	No. 8-36	4,166	63	7	21	4,5	3,4	6	3	-UNF8	-UNF8
	No. 10-32	4,826	70	8	25	6	4,9	8	3	-UNF10	-UNF10
	No. 12-28	5,486	80	10	30	6	4,9	8	3	-UNF12	-UNF12
	1/4-28	6,35	80	10	30	7	5,5	8	3	-UNF1/4	-UNF1/4

Machine tap Paradur Inox®

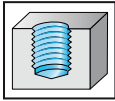
 $\leq 2,5 \times D_N$

- HSS-E
- chamfer form C = 2 - 3 thread
- 40° helix angle
- materials from 350 to 1200 N/mm² or 36 HRC
- for long-chipping materials

UNF

ASME B1.1

	P	M	K	N	S	H	O
vap	●	●	●				
TiN	●	●	●				

DIN 2184-1 2B	D _N -P Nom	D _N mm	l ₁ js16 mm	L _c mm	d ₁ h9 mm	□ h12 mm	l _g mm	N	VAP designation 23563	TIN designation 235635
	5/16-24	7,938	90	13	6	4,9	8	3	-UNF5/16	-UNF5/16
	3/8-24	9,525	100	15	7	5,5	8	3	-UNF3/8	-UNF3/8
	7/16-20	11,113	100	15	8	6,2	9	3	-UNF7/16	-UNF7/16
	1/2-20	12,7	100	13	9	7	10	4	-UNF1/2	-UNF1/2
	9/16-18	14,288	100	15	11	9	12	4	-UNF9/16	-UNF9/16
	5/8-18	15,875	100	15	12	9	12	4	-UNF5/8	-UNF5/8
	3/4-16	19,05	110	17	14	11	14	4	-UNF3/4	-UNF3/4
	7/8-14	22,225	125	18	18	14,5	17	4	-UNF7/8	-UNF7/8
	1-12	25,4	140	20	18	14,5	17	5	-UNF1	-UNF1



G 2



D 396

Machine tap Paradur® Eco Cl



$\leq 3 \times D_N$

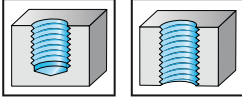

- HSS-E-PM
- chamfer form C = 2 - 3 thread
- materials from 100 to 1000 N/mm² or 32 HRC
- for short-chipping materials
- suitable for minimum quantity lubrication
- Xtra-treat™ surface treatment

UNF

ASME B1.1

	P	M	K	N	S	H	O
nid			●●	●●			●●

DIN 2184-1 2B	D _N -P Nom	D _N mm	l ₁ js16 mm	L _c mm	l ₃ ±1 mm	d ₁ h9 mm	□ h12 mm	l _g mm	N	NID designation E23314
	No. 6-40	3,505	56	11	20	4	3	6	3	-UNF6
	No. 8-36	4,166	63	12	21	4,5	3,4	6	3	-UNF8
	No. 10-32	4,826	70	13	25	6	4,9	8	4	-UNF10
	1/4-28	6,35	80	15	30	7	5,5	8	4	-UNF1/4

DIN 2184-1 2B	D _N -P Nom	D _N mm	l ₁ js16 mm	L _c mm	l ₃ ±1 mm	d ₁ h9 mm	□ h12 mm	l _g mm	N	NID designation E23364
	5/16-24	7,938	90	18	-	6	4,9	8	4	-UNF5/16
	3/8-24	9,525	100	20	-	7	5,5	8	4	-UNF3/8
	7/16-20	11,113	100	20	-	8	6,2	9	4	-UNF7/16
	1/2-20	12,7	100	21	-	9	7	10	4	-UNF1/2
	9/16-18	14,288	100	21	-	11	9	12	4	-UNF9/16
	5/8-18	15,875	100	21	-	12	9	12	4	-UNF5/8
	3/4-16	19,05	110	24	-	14	11	14	4	-UNF3/4
	7/8-14	22,225	125	24	-	18	14,5	17	5	-UNF7/8

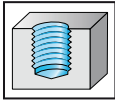

Machine tap Paradur® NI

 $\leq 1,5 \times D_N$

- HSS-E-PM
- chamfer form C = 2 - 3 thread
- 25° helix angle
- materials from 700 to 1400 N/mm² or 44 HRC
- for long-chipping materials

UNF

ASME B1.1

	P	M	K	N	S	H	O
uncoated	●				●●		

~DIN 2184-1 3B	D _N -P Nom	D _N mm	l ₁ js16 mm	L _c mm	l ₃ ±1 mm	d ₁ h9 mm	□ h12 mm	l _g mm	N	uncoated designation 234104
	No. 6-40	3,505	56	12	-	4	3	6	3	-UNF6 ¹
	No. 8-36	4,166	63	13	-	4,5	3,4	6	3	-UNF8 ¹
	No. 10-32	4,826	70	16	-	6	4,9	8	3	-UNF10 ¹
	No. 12-28	5,486	80	15	23	6	4,9	8	3	-UNF12
	1/4-28	6,35	80	15	25	7	5,5	8	3	-UNF1/4
	5/16-24	7,938	90	18	29,5	8	6,2	9	3	-UNF5/16
	3/8-24	9,525	100	20	33,5	10	8	11	4	-UNF3/8

¹without neck

DIN 2184-1 3B	D _N -P Nom	D _N mm	l ₁ js16 mm	L _c mm	l ₃ ±1 mm	d ₁ h9 mm	□ h12 mm	l _g mm	N	uncoated designation 234604
	7/16-20	11,113	100	20	-	8	6,2	9	4	-UNF7/16
	1/2-20	12,7	100	23	-	9	7	10	4	-UNF1/2
	5/8-18	15,875	100	25	-	12	9	12	4	-UNF5/8



Machine tap Paradur® NI 10



$\leq 1,5 \times D_N$

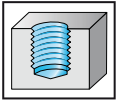

- HSS-E-PM
- chamfer form C = 2 - 3 thread
- 10° helix angle
- materials from 1000 to 1600 N/mm² or 49 HRC
- for long and short-chipping materials

UNJF

ASME B1.15
Outside diameter rounded

	P	M	K	N	S	H	O
uncoated	●●	●	●	●	●●	●	●

~DIN 2184-1 3B	D _N -P Nom	D _N mm	l ₁ js16 mm	L _c mm	d ₁ h9 mm	□ h12 mm	l _g mm	N	uncoated designation 234101
	No. 6-40 UNJF	3,505	56	9,5	4	3	6	3	-UNJF6 ¹
	No. 8-36 UNJF	4,166	63	11	4,5	3,4	6	3	-UNJF8 ¹
	No. 10-32 UNJF	4,826	70	12,5	6	4,9	8	3	-UNJF10 ¹
	1/4-28 UNJF	6,35	80	16	7	5,5	8	3	-UNJF1/4 ¹
	5/16-24 UNJF	7,938	90	19,5	8	6,2	9	3	-UNJF5/16 ¹
	3/8-24 UNJF	9,525	100	23	10	8	11	3	-UNJF3/8 ¹

¹without neck

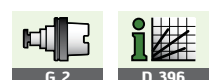

Machine tap Paradur® TI

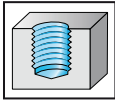
 $\leq 2 \times D_N$

- HSS-E-PM
- chamfer form C = 2 - 3 thread
- 15° helix angle
- materials from 700 to 1400 N/mm² or 44 HRC
- for long-chipping materials

UNF

ASME B1.1

	P	M	K	N	S	H	O
uncoated	●●			●	●●		

~DIN 2184-1 2B	D _N -P Nom	D _N mm	l ₁ js16 mm	L _c mm	l ₃ ±1 mm	d ₁ h9 mm	□ h12 mm	l _g mm	N	uncoated designation 23416
	No. 6-40	3,505	56	12	-	4	3	6	3	-UNF6 ¹
	No. 8-36	4,166	63	13	-	4,5	3,4	6	3	-UNF8 ¹
	No. 10-32	4,826	70	16	-	6	4,9	8	3	-UNF10 ¹
	No. 12-28	5,486	80	15	23	6	4,9	8	3	-UNF12
	1/4-28	6,35	80	15	25	7	5,5	8	3	-UNF1/4
	5/16-24	7,938	90	18	29,5	8	6,2	9	3	-UNF5/16
	3/8-24	9,525	100	20	33,5	10	8	11	3	-UNF3/8

¹without neck

DIN 2184-1 2B	D _N -P Nom	D _N mm	l ₁ js16 mm	L _c mm	l ₃ ±1 mm	d ₁ h9 mm	□ h12 mm	l _g mm	N	uncoated designation 23466
	7/16-20	11,113	100	20	-	8	6,2	9	4	-UNF7/16
	1/2-20	12,7	100	23	-	9	7	10	4	-UNF1/2
	5/8-18	15,875	100	25	-	12	9	12	4	-UNF5/8



Machine tap Paradur® TI



$\leq 2 \times D_N$

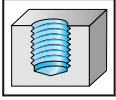

- HSS-E-PM
- chamfer form C = 2 - 3 thread
- 15° helix angle
- materials from 700 to 1400 N/mm² or 44 HRC
- for long-chipping materials

UNF

ASME B1.1

	P	M	K	N	S	H	O
uncoated	●●			●	●●		

~DIN 2184-1 3B		D_N -P Nom	D_N mm	l_1 js16 mm	L_c mm	l_3 ± 1 mm	d_1 h9 mm	\square h12 mm	l_g mm	N	uncoated designation 234164
	No. 6-40	3,505	56	12	-	4	3	6	3	-UNF6	
	No. 8-36	4,166	63	13	-	4,5	3,4	6	3	-UNF8	
	No. 10-32	4,826	70	16	-	6	4,9	8	3	-UNF10	
	No. 12-28	5,486	80	15	23	6	4,9	8	3	-UNF12	
	1/4-28	6,35	80	15	25	7	5,5	8	3	-UNF1/4	
	5/16-24	7,938	90	18	29,5	8	6,2	9	3	-UNF5/16	
	3/8-24	9,525	100	20	33,5	10	8	11	3	-UNF3/8	

DIN 2184-1 3B		D_N -P Nom	D_N mm	l_1 js16 mm	L_c mm	l_3 ± 1 mm	d_1 h9 mm	\square h12 mm	l_g mm	N	uncoated designation 234664
	7/16-20	11,113	100	20	-	8	6,2	9	4	-UNF7/16	
	1/2-20	12,7	100	23	-	9	7	10	4	-UNF1/2	
	5/8-18	15,875	100	25	-	12	9	12	4	-UNF5/8	

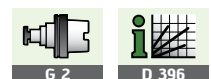

Machine tap Paradur® TI Plus



$\leq 2 \times D_N$

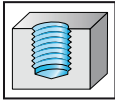

- HSS-E-PM
- chamfer form C = 2 - 3 thread
- 15° helix angle
- materials from 700 to 1400 N/mm² or 44 HRC
- for long-chipping materials

UNJF

ASME B1.15
Outside diameter rounded

	P	M	K	N	S	H	O
ACN					●●		

~DIN 2184-1 3B	D _N -P Nom	D _N mm	l ₁ js16 mm	L _c mm	l ₃ ±1 mm	d ₁ h9 mm	□ h12 mm	l ₉ mm	N	ACN designation 2340663
	No. 10-32 UNJF	4,826	70	16	-	6	4,9	8	3	-UNJF10
	1/4-28 UNJF	6,35	80	15	25	7	5,5	8	3	-UNJF1/4
	5/16-24 UNJF	7,938	90	18	29,5	8	6,2	9	3	-UNJF5/16
	3/8-24 UNJF	9,525	100	20	33,5	10	8	11	3	-UNJF3/8



Machine tap Paradur® WSH



$\leq 3 \times D_N$

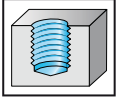

- HSS-E
- chamfer form C = 2 - 3 thread
- 45° helix angle
- materials from 200 to 1000 N/mm² or 32 HRC
- for long-chipping materials

UNEF

ASME B1.1

	P	M	K	N	S	H	O
uncoated	●●		●	●			

DIN 2184-1 2B	D _N -P Nom	D _N mm	l ₁ js16 mm	L _c mm	d ₁ h9 mm	□ h12 mm	l _g mm	N	uncoated designation 235672
	1/4-32	6,35	80	10	4,5	3,4	6	3	-UNEF1/4
	5/16-32	7,938	90	13	6	4,9	8	3	-UNEF5/16
	3/8-32	9,525	90	12	7	5,5	8	3	-UNEF3/8
	7/16-28	11,113	90	15	8	6,2	9	3	-UNEF7/16
	1/2-28	12,7	100	13	9	7	10	4	-UNEF1/2
	9/16-24	14,288	100	15	11	9	12	4	-UNEF9/16
	5/8-24	15,875	100	15	12	9	12	4	-UNEF5/8
	11/16-24	17,462	110	17	14	11	14	4	-UNEF11/16
	3/4-20	19,05	110	17	14	11	14	4	-UNEF3/4
	7/8-20	22,225	125	18	18	14,5	17	4	-UNEF7/8
	1-20	25,4	140	20	18	14,5	17	5	-UNEF1

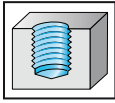

Machine tap Paradur® WSH

 $\leq 3 \times D_N$

- HSS-E
- chamfer form C = 2 - 3 thread
- 45° helix angle
- materials from 200 to 1000 N/mm² or 32 HRC
- for long-chipping materials

UN - 8

ASME B1.1

	P	M	K	N	S	H	O
uncoated	●●		●	●			

DIN 2184-1 2B	D _N -P Nom	D _N mm	l ₁ js16 mm	L _c mm	d ₁ h9 mm	□ h12 mm	l _g mm	N	uncoated designation 265676
	1 1/8-8	28,575	180	30	22	18	21	5	-UN1.1/8
	1 1/4-8	31,75	180	30	22	18	21	5	-UN1.1/4
	1 3/8-8	34,925	200	30	28	22	25	5	-UN1.3/8
	1 1/2-8	38,1	200	30	28	22	25	5	-UN1.1/2
	1 5/8-8	41,275	200	33	32	24	27	6	-UN1.5/8
	1 3/4-8	44,45	200	33	36	29	32	6	-UN1.3/4
	1 7/8-8	47,625	225	36	36	29	32	6	-UN1.7/8
	2-8	50,8	225	36	40	32	35	6	-UN2
	2 1/4-8	57,15	250	36	45	35	38	6	-UN2.1/4



Machine tap Paradur Inox®



$\leq 2,5 \times D_N$

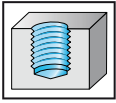

- HSS-E
- chamfer form C = 2 - 3 thread
- 40° helix angle
- materials from 350 to 1200 N/mm² or 36 HRC
- for long-chipping materials

UN - 8

ASME B1.1

	P	M	K	N	S	H	O
vap	●●	●●	●				

DIN 2184-1 3B	D _N -P Nom	D _N mm	l ₁ js16 mm	L _c mm	d ₁ h9 mm	□ h12 mm	l _g mm	N	VAP designation 225532
	1-8	25,4	160	30	18	14,5	17	4	-UN1
	1 1/8-8	28,575	180	30	22	18	21	4	-UN1.1/8
	1 1/4-8	31,75	180	30	22	18	21	4	-UN1.1/4
	1 3/8-8	34,925	200	30	28	22	25	5	-UN1.3/8
	1 1/2-8	38,1	200	30	28	22	25	5	-UN1.1/2
	1 5/8-8	41,275	200	33	32	24	27	5	-UN1.5/8
	1 3/4-8	44,45	200	33	36	29	32	6	-UN1.3/4
	1 7/8-8	47,625	225	36	36	29	32	6	-UN1.7/8
	2-8	50,8	225	36	40	32	35	6	-UN2

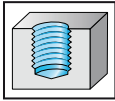

Machine tap Paradur Inox®

 $\leq 2,5 \times D_N$

- HSS-E
- chamfer form C = 2 - 3 thread
- 40° helix angle
- materials from 350 to 1200 N/mm² or 36 HRC
- for long-chipping materials

UN - 8

ASME B1.1

	P	M	K	N	S	H	O
vap	●●	●●	●				

DIN 2184-1 2B	D _N -P Nom	D _N mm	l ₁ js16 mm	L _c mm	d ₁ h9 mm	□ h12 mm	l _g mm	N	VAP designation 225632
	1-8	25,4	160	30	18	14,5	17	4	-UN1
	1 1/8-8	28,575	180	30	22	18	21	4	-UN1.1/8
	1 1/4-8	31,75	180	30	22	18	21	4	-UN1.1/4
	1 3/8-8	34,925	200	30	28	22	25	5	-UN1.3/8
	1 1/2-8	38,1	200	30	28	22	25	5	-UN1.1/2
	1 5/8-8	41,275	200	33	32	24	27	5	-UN1.5/8
	1 3/4-8	44,45	200	33	36	29	32	6	-UN1.3/4
	1 7/8-8	47,625	225	36	36	29	32	6	-UN1.7/8
	2-8	50,8	225	36	40	32	35	6	-UN2



Machine tap Paradur® HS



$\leq 3 \times D_N$

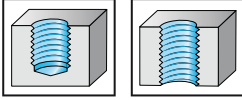

- solid carbide
- chamfer form C = 2 - 3 thread
- for materials to 55 HRC
- for short-chipping materials

UNF

ASME B1.1

	P	M	K	N	S	H	O
TiCN			●	●●	●	●	●●

~DIN 2184-1 2B	D _N -P Nom	D _N mm	l ₁ js16 mm	L _c mm	l ₃ ±1 mm	d ₁ h6 mm	□ h12 mm	l _g mm	N	TiCN
										designation 8331106
	No. 10-32	4,826	70	16	-	6	4,9	8	3	-UNF10 ¹
	1/4-28	6,35	80	20	-	7	5,5	8	3	-UNF1/4 ¹
	5/16-24	7,938	90	25	-	8	6,2	9	3	-UNF5/16 ¹
	3/8-24	9,525	90	30	-	10	8	11	3	-UNF3/8 ¹
	1/2-20	12,7	100	20	44,5	12	9	12	4	-UNF1/2

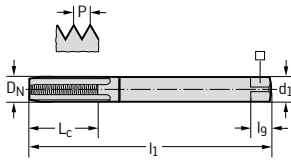

¹without neck

Machine tap Prototex® Eco HT

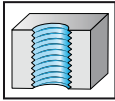







 $\leq 3,5 \times D_N$

- HSS-E-PM
- chamfer form B = 3.5 - 5 thread
- materials from 500 to 1350 N/mm² or 42 HRC
- for long-chipping materials
- suitable for minimum quantity lubrication

G

DIN EN ISO 228

	P	M	K	N	S	H	O
THL	●	●	●	●	●		●

DIN 5156 G-X	D _N Nom	D _N mm	Threads per inch	l ₁ js16 mm	L _c mm	d ₁ h9 mm	□ h12 mm	l _g mm	N	THL designation E2426302
	G 1/8	9,728	28	90	20	7	5,5	8	3	-G1/8
	G 1/4	13,157	19	100	21	11	9	12	4	-G1/4
	G 3/8	16,662	19	100	21	12	9	12	4	-G3/8
	G 1/2	20,955	14	125	24	16	12	15	4	-G1/2
	G 5/8	22,911	14	125	24	18	14,5	17	4	-G5/8
	G 3/4	26,441	14	140	26	20	16	19	5	-G3/4
	G 1	33,249	11	160	28	25	20	23	5	-G1

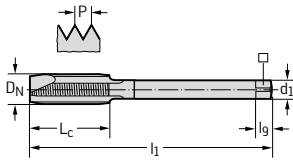

G 2



D 396

Machine tap Prototex® H



$\leq 3 \times D_N$

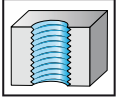

- HSS-E
- chamfer form B = 3.5 - 5 thread
- materials from 200 to 1000 N/mm² or 32 HRC
- for long-chipping materials

G

DIN EN ISO 228

	P	M	K	N	S	H	O
uncoated	●●		●	●●			●
TiN	●●		●	●●			●

DIN 5156		D_N Nom	D_N mm	Threads per inch	l_1 js16 mm	L_c mm	d_1 h9 mm	\square h12 mm	l_g mm	N	uncoated designation 24360	TiN designation 2436005
	G 1/8	9,728	28	90	20	7	5,5	8	3	-G1/8	-G1/8	
	G 1/4	13,157	19	100	21	11	9	12	3	-G1/4	-G1/4	
	G 3/8	16,662	19	100	21	12	9	12	4	-G3/8	-G3/8	
	G 1/2	20,955	14	125	24	16	12	15	4	-G1/2	-G1/2	
	G 5/8	22,911	14	125	24	18	14,5	17	4	-G5/8		
	G 3/4	26,441	14	140	26	20	16	19	4	-G3/4	-G3/4	
	G 7/8	30,201	14	150	26	22	18	21	4	-G7/8		
	G 1	33,249	11	160	28	25	20	23	4	-G1	-G1	
	G 1 1/8	37,897	11	170	28	28	22	25	4	-G1.1/8		
	G 1 1/4	41,91	11	170	28	32	24	27	4	-G1.1/4		
	G 1 1/2	47,803	11	190	30	36	29	32	5	-G1.1/2		
	G 1 3/4	53,746	11	190	32	40	32	35	5	-G1.3/4		
	G 2	59,614	11	220	34	45	35	38	5	-G2		

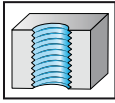

Machine tap Prototex Inox®

 $\leq 3 \times D_N$

- HSS-E
- chamfer form B = 3.5 - 5 thread
- materials from 350 to 1200 N/mm² or 36 HRC
- for long-chipping materials

G

DIN EN ISO 228

	P	M	K	N	S	H	O
vap	●	●	●	●	●	●	●
TiN	●	●	●	●	●	●	●

DIN 5156

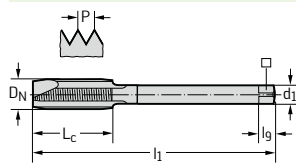

D _N Nom	D _N mm	Threads per inch	l ₁ js16 mm	L _c mm	d ₁ h9 mm	□ h12 mm	l _g mm	N	VAP designation 24263	TIN designation 2426305
G 1/8	9,728	28	90	20	7	5,5	8	3	-G1/8	-G1/8
G 1/4	13,157	19	100	21	11	9	12	4	-G1/4	-G1/4
G 3/8	16,662	19	100	21	12	9	12	4	-G3/8	-G3/8
G 1/2	20,955	14	125	24	16	12	15	4	-G1/2	-G1/2
G 5/8	22,911	14	125	24	18	14,5	17	4	-G5/8	-G5/8
G 3/4	26,441	14	140	26	20	16	19	4	-G3/4	-G3/4
G 7/8	30,201	14	150	26	22	18	21	5	-G7/8	
G 1	33,249	11	160	28	25	20	23	5	-G1	-G1



Machine tap Prototex® Synchronspeed



$\leq 3 \times D_N$

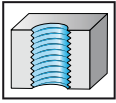

- HSS-E
- chamfer form B = 3.5 - 5 thread
- materials from to 1400 N/mm² or 44 HRC
- for long-chipping materials
- only for synchronous machining (rigid tapping)
- suitable for minimum quantity lubrication

G

DIN EN ISO 228

	P	M	K	N	S	H	O
THL	●●	●●	●●	●●	●●		●●

~DIN 5156 G-X	D _N Nom	D _N mm	Threads per inch	l ₁ js16 mm	L _c mm	l ₃ ±1 mm	d ₁ h6 mm	□ h12 mm	l _g mm	N	THL
											designation S2426302
Shank DIN 1835 B	G 1/8	9,728	28	90	9,1	39	10	8	11	3	-G1/8
	G 1/4	13,157	19	100	13,4	46	14	11	14	3	-G1/4
	G 3/8	16,662	19	100	13,4	50	16	12	15	4	-G3/8
	G 1/2	20,955	14	125	18,1	62,5	20	16	19	4	-G1/2

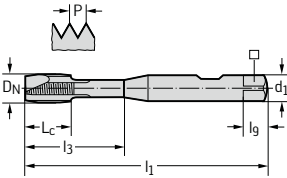

Short machine tap KMB MS



$\leq 3,5 \times D_N$

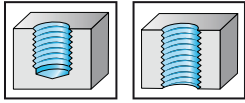

- HSS-E
- overall length S = short
- chamfer form F = 1 - 1.5 thread
- materials from 350 to 850 N/mm² or 25 HRC
- for short-chipping materials

G

DIN EN ISO 228

	P	M	K	N	S	H	O
uncoated				●●			●

DIN 5157	D _N Nom	D _N mm	Threads per inch	l ₁ js16 mm	L _c mm	d ₁ h9 mm	□ h12 mm	l _g mm	N	uncoated designation 24165
+ 0.05 mm oversize	G 1/8	9,728	28	63	20	7	5,5	8	3	-G1/8
	G 1/4	13,157	19	70	20	11	9	12	4	-G1/4
	G 3/8	16,662	19	70	20	12	9	12	4	-G3/8
	G 1/2	20,955	14	80	22	16	12	15	6	-G1/2
	G 5/8	22,911	14	80	22	18	14,5	17	6	-G5/8
	G 3/4	26,441	14	90	22	20	16	19	6	-G3/4
	G 1	33,249	11	100	25	25	20	23	6	-G1
	G 1 1/2	47,803	11	140	32	36	29	32	6	-G1.1/2

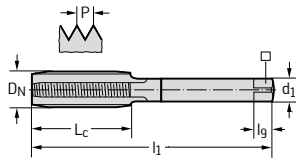

DIN 5157	D _N Nom	D _N mm	Threads per inch	l ₁ js16 mm	L _c mm	d ₁ h9 mm	□ h12 mm	l _g mm	N	uncoated designation 24195
+ 0.1 mm oversize	G 1/8	9,728	28	63	20	7	5,5	8	3	-G1/8
	G 1/4	13,157	19	70	20	11	9	12	4	-G1/4
	G 3/8	16,662	19	70	20	12	9	12	4	-G3/8
	G 1/2	20,955	14	80	22	16	12	15	6	-G1/2
	G 5/8	22,911	14	80	22	18	14,5	17	6	-G5/8
	G 3/4	26,441	14	90	22	20	16	19	6	-G3/4

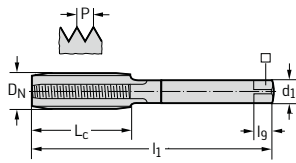

Machine tap Paradur® Eco HT



$\leq 3 \times D_N$

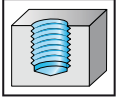

- HSS-E-PM
- chamfer form C = 2 - 3 thread
- 45° helix angle
- long-chipping materials from 500 to 1250 N/mm² or 38 HRC
- for long-chipping materials
- suitable for minimum quantity lubrication

G

DIN EN ISO 228

	P	M	K	N	S	H	O
THL	●	●	●	●	●		●

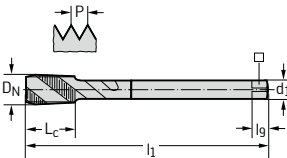
DIN 5156 G-X	D _N Nom	D _N mm	Threads per inch	l ₁ js16 mm	L _c mm	d ₁ h9 mm	□ h12 mm	l _g mm	N	THL designation E2456302
	G 1/8	9,728	28	90	12	7	5,5	8	3	-G1/8
	G 1/4	13,157	19	100	15	11	9	12	4	-G1/4
	G 3/8	16,662	19	100	15	12	9	12	4	-G3/8
	G 1/2	20,955	14	125	18	16	12	15	4	-G1/2
	G 5/8	22,911	14	125	18	18	14,5	17	4	-G5/8
	G 3/4	26,441	14	140	20	20	16	19	5	-G3/4
	G 1	33,249	11	160	22	25	20	23	5	-G1



G 2

D 396

Machine tap Paradur® H

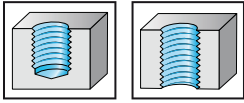

 $\leq 1,5 \times D_N$

- HSS-E
- chamfer form C = 2 - 3 thread
- materials from 200 to 1000 N/mm² or 32 HRC
- for long and short-chipping materials

G

DIN EN ISO 228

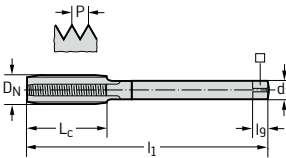
	P	M	K	N	S	H	O
uncoated			●	●●			●

DIN 5156	D _N Nom	D _N mm	Threads per inch	l ₁ js16 mm	L _c mm	d ₁ h9 mm	□ h12 mm	l _g mm	N	uncoated
										designation 24361
	G 1/8	9,728	28	90	20	7	5,5	8	3	-G1/8
	G 1/4	13,157	19	100	21	11	9	12	4	-G1/4
	G 3/8	16,662	19	100	21	12	9	12	4	-G3/8
	G 1/2	20,955	14	125	24	16	12	15	4	-G1/2
	G 5/8	22,911	14	125	24	18	14,5	17	4	-G5/8
	G 3/4	26,441	14	140	26	20	16	19	4	-G3/4
	G 7/8	30,201	14	150	26	22	18	21	4	-G7/8
	G 1	33,249	11	160	28	25	20	23	4	-G1
	G 1 1/4	41,91	11	170	28	32	24	27	4	-G1.1/4
	G 1 1/2	47,803	11	190	30	36	29	32	6	-G1.1/2
	G 2	59,614	11	220	34	45	35	38	6	-G2
	G 2 1/2	75,184	11	275	38	50	39	42	6	-G2.1/2



Machine tap Paradur® N



$\leq 1,5 \times D_N$

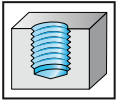

- HSS-E
- chamfer form C = 2 - 3 thread
- 15° helix angle
- materials from 200 to 1000 N/mm² or 32 HRC
- for long-chipping materials

G

DIN EN ISO 228

	P	M	K	N	S	H	O
uncoated	●●	●	●●	●●	●	●	●

DIN 5156	D _N Nom	D _N mm	Threads per inch	l ₁ js16 mm	L _c mm	d ₁ h9 mm	□ h12 mm	l _g mm	N	uncoated designation 24460
	G 1/8	9,728	28	90	20	7	5,5	8	3	-G1/8
	G 1/4	13,157	19	100	21	11	9	12	4	-G1/4
	G 3/8	16,662	19	100	21	12	9	12	4	-G3/8
	G 1/2	20,955	14	125	24	16	12	15	4	-G1/2
	G 3/4	26,441	14	140	26	20	16	19	4	-G3/4
	G 1	33,249	11	160	28	25	20	23	4	-G1

Machine tap Paradur® WSH

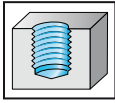

 $\leq 3 \times D_N$

- HSS-E
- chamfer form C = 2 - 3 thread
- 40° helix angle
- materials from 200 to 1000 N/mm² or 32 HRC
- for long-chipping materials

G

DIN EN ISO 228

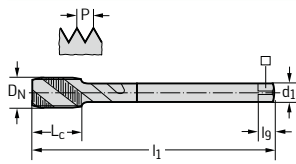
	P	M	K	N	S	H	O
uncoated	●●		●	●			
TiN	●●		●	●			

DIN 5156

D _N Nom	D _N mm	Threads per inch	l ₁ js16 mm	L _C mm	d ₁ h9 mm	□ h12 mm	l _g mm	N	uncoated designation 24567	TiN designation 2456705
G 1/8	9,728	28	90	12	7	5,5	8	3	-G1/8	-G1/8
G 1/4	13,157	19	100	15	11	9	12	4	-G1/4	-G1/4
G 3/8	16,662	19	100	15	12	9	12	4	-G3/8	-G3/8
G 1/2	20,955	14	125	18	16	12	15	4	-G1/2	-G1/2
G 5/8	22,911	14	125	18	18	14,5	17	4	-G5/8	
G 3/4	26,441	14	140	20	20	16	19	5	-G3/4	-G3/4
G 7/8	30,201	14	150	20	22	18	21	5	-G7/8	
G 1	33,249	11	160	22	25	20	23	5	-G1	-G1
G 1 1/8	37,897	11	170	22	28	22	25	5	-G1.1/8	
G 1 1/4	41,91	11	170	22	32	24	27	6	-G1.1/4	
G 1 1/2	47,803	11	190	24	36	29	32	6	-G1.1/2	
G 1 3/4	53,746	11	190	26	40	32	35	6	-G1.3/4	
G 2	59,614	11	220	28	45	35	38	6	-G2	



G 2



D 396

Machine tap Paradur® STE



$\leq 3 \times D_N$

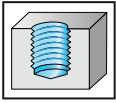

- HSS-E
- chamfer form E = 1.5 - 2 thread
- 40° helix angle
- materials from 350 to 1200 N/mm² or 36 HRC
- for long-chipping materials

G

DIN EN ISO 228

	P	M	K	N	S	H	O
uncoated	●	●	●	●			
THL	●	●	●	●			

DIN 5156	D _N Nom	D _N mm	Threads per inch	l ₁ js16 mm	L _c mm	d ₁ h9 mm	□ h12 mm	l _g mm	N	uncoated	THL
										designation 245606	designation 2456062
	G 1/8	9,728	28	90	12	7	5,5	8	4	-G1/8	-G1/8
	G 1/4	13,157	19	100	15	11	9	12	5	-G1/4	-G1/4
	G 3/8	16,662	19	100	15	12	9	12	5	-G3/8	-G3/8
	G 1/2	20,955	14	125	18	16	12	15	5	-G1/2	-G1/2

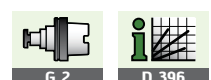

Machine tap Paradur Inox®

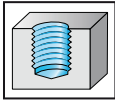
 $\leq 2,5 \times D_N$

- HSS-E
- chamfer form C = 2 - 3 thread
- 40° helix angle
- materials from 350 to 1200 N/mm² or 36 HRC
- for long-chipping materials

G

DIN EN ISO 228

	P	M	K	N	S	H	O
vap	●	●	●				
TiN	●	●	●				

DIN 5156		D_N Nom	D_N mm	Threads per inch	l_1 js16 mm	L_c mm	d_1 h9 mm	h_{12} mm	l_g mm	N	VAP designation 24563	TiN designation 2456305
		G 1/8	9,728	28	90	12	7	5,5	8	3	-G1/8	-G1/8
		G 1/4	13,157	19	100	15	11	9	12	4	-G1/4	-G1/4
		G 3/8	16,662	19	100	15	12	9	12	4	-G3/8	-G3/8
		G 1/2	20,955	14	125	18	16	12	15	4	-G1/2	-G1/2
		G 5/8	22,911	14	125	18	18	14,5	17	4	-G5/8	-G5/8
		G 3/4	26,441	14	140	20	20	16	19	5	-G3/4	-G3/4
		G 7/8	30,201	14	150	20	22	18	21	5	-G7/8	
		G 1	33,249	11	160	22	25	20	23	5	-G1	-G1



Machine tap Paradur Inox® 25



$\leq 1,5 \times D_N$

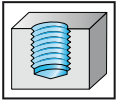

- HSS-E
- chamfer form E = 1.5 - 2 thread
- 25° helix angle
- materials from 350 to 1200 N/mm² or 36 HRC
- for long-chipping materials

G

DIN EN ISO 228

	P	M	K	N	S	H	O
TiN	●●	●●	●●	●●	●●	●●	●●

DIN 5156	D _N Nom	D _N mm	Threads per inch	l ₁ js16 mm	L _c mm	d ₁ h9 mm	□ h12 mm	l _g mm	N	TiN
										designation 2456315
	G 1/4	13,157	19	100	18	11	9	12	5	-G1/4
	G 3/8	16,662	19	100	22	12	9	12	5	-G3/8
	G 1/2	20,955	14	125	25	16	12	15	6	-G1/2
	G 5/8	22,911	14	125	25	18	14,5	17	6	-G5/8
	G 3/4	26,441	14	140	28	20	16	19	6	-G3/4

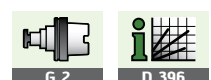

Machine tap Paradur® WTH Inox 50



$\leq 3,5 \times D_N$

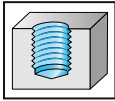

- HSS-E
- chamfer form C = 2 - 3 thread
- 50° helix angle
- materials from 350 to 1200 N/mm² or 36 HRC
- for long-chipping materials

G

DIN EN ISO 228

	P	M	K	N	S	H	O
vap	●●	●●	●	●	●	●	●

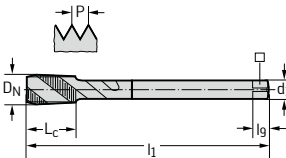
DIN 5156	D _N Nom	D _N mm	Threads per inch	l ₁ js16 mm	L _c mm	d ₁ h9 mm	□ h12 mm	l _g mm	N	VAP designation 245699
	G 1/8	9,728	28	90	12	7	5,5	8	3	-G1/8
	G 1/4	13,157	19	100	15	11	9	12	4	-G1/4



Machine tap Paradur® Eco Cl



$\leq 3 \times D_N$

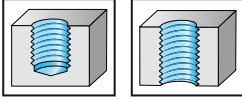

- HSS-E-PM
- chamfer form C = 2 - 3 thread
- materials from 100 to 1000 N/mm² or 32 HRC
- for short-chipping materials
- suitable for minimum quantity lubrication
- Xtra-treat™ surface treatment

G

DIN EN ISO 228

	P	M	K	N	S	H	O
nid			●●	●●			●●
TiCN			●●	●●			●●

DIN 5156 G-X		D_N Nom	D_N mm	Threads per inch	l_1 js16 mm	L_c mm	d_1 h9 mm	\square h12 mm	l_g mm	N	NID designation E24364	TiCN designation E2436406
		G 1/8	9,728	28	90	20	7	5,5	8	4	-G1/8	-G1/8
		G 1/4	13,157	19	100	21	11	9	12	4	-G1/4	-G1/4
		G 3/8	16,662	19	100	21	12	9	12	5	-G3/8	-G3/8
		G 1/2	20,955	14	125	24	16	12	15	5	-G1/2	-G1/2
		G 3/4	26,441	14	140	26	20	16	19	6	-G3/4	-G3/4
		G 1	33,249	11	160	28	25	20	23	6	-G1	-G1
		G 1 1/4	41,91	11	170	28	32	24	27	6	-G1.1/4	-G1.1/4
		G 1 1/2	47,803	11	190	30	36	29	32	6	-G1.1/2	-G1.1/2

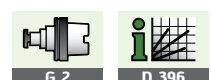

Machine tap
Paradur® WLM



$\leq 3 \times D_N$

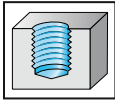

- HSS-E
- chamfer form C = 2 - 3 thread
- 35° helix angle
- materials from 200 to 700 N/mm² or 14 HRC
- for long-chipping materials

G

DIN EN ISO 228

	P	M	K	N	S	H	O
uncoated				●●	●●		●●

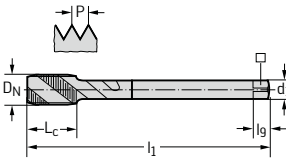
DIN 5156	D _N Nom	D _N mm	Threads per inch	l ₁ js16 mm	L _c mm	d ₁ h9 mm	□ h12 mm	l _g mm	N	uncoated designation 245660
	G 1/8	9,728	28	90	12	7	5,5	8	3	-G1/8



G 2

D 396

Machine tap Paradur® Synchronspeed



$\leq 2,5 \times D_N$

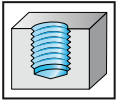

- HSS-E
- chamfer form C = 2 - 3 thread
- 40° helix angle
- long-chipping materials to 1300 N/mm² or 40 HRC
- only for synchronous machining (rigid tapping)
- suitable for minimum quantity lubrication

G

DIN EN ISO 228

	P	M	K	N	S	H	O
THL	●	●	●	●	●		●

~DIN 5156 G-X	D _N Nom	D _N mm	Threads per inch	l ₁ js16 mm	L _c mm	l ₃ ±1 mm	d ₁ h6 mm	□ h12 mm	l _g mm	N	THL designation S2456302
Shank DIN 1835 B	G 1/8	9,728	28	90	9,5	39	10	8	11	3	-G1/8
	G 1/4	13,157	19	100	14	46	14	11	14	3	-G1/4
	G 3/8	16,662	19	100	14	50	16	12	15	4	-G3/8
	G 1/2	20,955	14	125	19	62,5	20	16	19	4	-G1/2

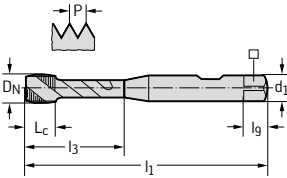

Machine tap Paradur® Hard Scraper



$\leq 2 \times D_N$

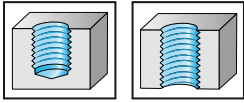

- solid carbide
- chamfer form C = 2 - 3 thread
- for boring core hole 0.1 to 0.2 mm larger
- for materials from 50 to 63 HRC
- for short-chipping materials

G

DIN EN ISO 228

	P	M	K	N	S	H	O
TiCN					●	●●	

PWZ-Norm	D_N Nom	D_N mm	Threads per inch	l_1 js16 mm	L_c mm	d_1 h6 mm	\square h12 mm	l_g mm	N	TiCN designation 8431206
	G 1/8	9,728	28	90	23,5	10	8	11	5	-G1/8 ¹
	G 1/4	13,157	19	100	32,5	12	9	12	6	-G1/4

¹without neck



G 2

D 396

Machine tap Paradur® H

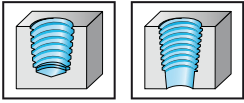

- HSS-E
- chamfer form C = 2 - 3 thread
- materials from 200 to 1000 N/mm² or 32 HRC
- for long and short-chipping materials

Rc

DIN EN 10226-2
1:16

	P	M	K	N	S	H	O
uncoated			●	●●			●

PWZ-Norm	D _N Nom	Threads per inch	l ₁ js16 mm	L _c mm	d ₁ h9 mm	□ h12 mm	l _g mm	N	uncoated designation 24167
	Rc 1/8	28	90	13	7	5,5	8	4	-RC1/8
	Rc 1/4	19	100	20	11	9	12	4	-RC1/4
	Rc 3/8	19	110	20	12	9	12	4	-RC3/8
	Rc 1/2	14	125	26	16	12	15	5	-RC1/2
	Rc 3/4	14	140	26	20	16	19	5	-RC3/4
	Rc 1	11	150	32	25	20	23	5	-RC1
	Rc 1 1/4	11	160	32	32	24	27	6	-RC1.1/4
	Rc 1 1/2	11	180	32	36	29	32	6	-RC1.1/2

Machine tap Paradur® H

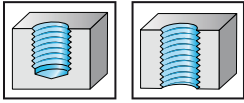
 $\leq 1,5 \times D_N$

- HSS-E
- chamfer form C = 2 - 3 thread
- materials from 200 to 1000 N/mm² or 32 HRC
- for long and short-chipping materials

Rp

DIN EN 10226-1

	P	M	K	N	S	H	O
uncoated			●	●●			●

DIN 5156

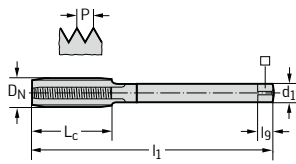

D _N Nom	D _N mm	Threads per inch	l ₁ js16 mm	L _C mm	d ₁ h9 mm	□ h12 mm	l _g mm	N	uncoated designation 243612
Rp 1/8	9,728	28	90	20	7	5,5	8	3	-RP1/8
Rp 1/4	13,157	19	100	21	11	9	12	4	-RP1/4
Rp 3/8	16,662	19	100	21	12	9	12	4	-RP3/8
Rp 1/2	20,955	14	125	24	16	12	15	4	-RP1/2
Rp 3/4	26,441	14	140	26	20	16	19	4	-RP3/4
Rp 1	33,249	11	160	28	25	20	23	4	-RP1
Rp 1 1/2	47,803	11	190	30	36	29	32	6	-RP1.1/2

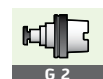

Machine tap Paradur® H

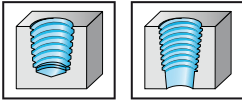

- HSS-E
- chamfer form C = 2 - 3 thread
- materials from 200 to 1000 N/mm² or 32 HRC
- for long and short-chipping materials

NPT

ASME B1.20.1
1:16

	P	M	K	N	S	H	O
uncoated			●	●●			●

PWZ-Norm	D _N Nom	Threads per inch	l ₁ js16 mm	L _c mm	d ₁ h9 mm	□ h12 mm	l _g mm	N	uncoated designation 25167
	1/16-27	27	80	14	8	6,2	9	3	-NPT1/16
	1/8-27	27	90	14	11	9	12	3	-NPT1/8
	1/4-18	18	100	20	14	11	14	3	-NPT1/4
	3/8-18	18	110	20	16	12	15	4	-NPT3/8
	1/2-14	14	125	26	18	14,5	17	4	-NPT1/2
	3/4-14	14	140	26	22	18	21	5	-NPT3/4
	1-11 1/2	11,5	150	31	28	22	25	5	-NPT1
	1 1/4-11 1/2	11,5	160	31	32	24	27	5	-NPT1.1/4
	1 1/2-11 1/2	11,5	160	31	36	29	32	6	-NPT1.1/2
	2-11 1/2	11,5	180	31	45	35	38	7	-NPT2



G 2

D 396

Machine tap Paradur® N

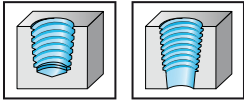

- HSS-E
- chamfer form C = 2 - 3 thread
- 15° helix angle
- materials from 200 to 1000 N/mm² or 32 HRC
- for long-chipping materials

NPT

ASME B1.20.1
1:16

	P	M	K	N	S	H	O
vap	●●		●●	●●			

PWZ-Norm	D _N Nom	Threads per inch	l ₁ js16 mm	L _c mm	d ₁ h9 mm	□ h12 mm	l _g mm	N	VAP designation 25460
	1/16-27	27	80	14	8	6,2	9	3	-NPT1/16
	1/8-27	27	90	14	11	9	12	3	-NPT1/8
	1/4-18	18	100	20	14	11	14	3	-NPT1/4
	3/8-18	18	110	20	16	12	15	4	-NPT3/8
	1/2-14	14	125	26	18	14,5	17	4	-NPT1/2
	3/4-14	14	140	26	22	18	21	5	-NPT3/4
	1-11 1/2	11,5	150	31	28	22	25	5	-NPT1



Machine tap Paradur® NI

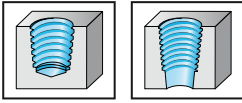

- HSS-E
- chamfer form C = 2 - 3 thread
- 15° helix angle
- materials from 700 to 1400 N/mm² or 44 HRC
- for long-chipping materials

NPT

ASME B1.20.1
1:16

	P	M	K	N	S	H	O
uncoated	●				●●		

PWZ-Norm	D _N Nom	Threads per inch	l ₁ js16 mm	L _c mm	d ₁ h9 mm	□ h12 mm	l _g mm	N	uncoated designation 25467
	1/16-27	27	80	14	8	6,2	9	3	-NPT1/16
	1/8-27	27	90	14	11	9	12	4	-NPT1/8
	1/4-18	18	100	20	14	11	14	4	-NPT1/4
	3/8-18	18	110	20	16	12	15	5	-NPT3/8
	1/2-14	14	125	26	18	14,5	17	5	-NPT1/2
	3/4-14	14	140	26	22	18	21	5	-NPT3/4
	1-11 1/2	11,5	150	31	28	22	25	5	-NPT1

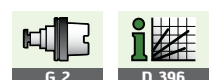

Machine tap
Paradur Inox® 40

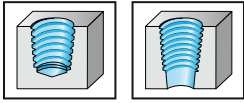

- HSS-E
- chamfer form C = 2 - 3 thread
- 40° helix angle
- materials from 350 to 1200 N/mm² or 36 HRC
- for long-chipping materials

NPT

ASME B1.20.1
1:16

	P	M	K	N	S	H	O
uncoated	●	●	●	●			

PWZ-Norm	D _N Nom	Threads per inch	l ₁ js16 mm	L _c mm	d ₁ h9 mm	□ h12 mm	l _g mm	N	uncoated designation 255630
	1/8-27	27	90	14	11	9	12	3	-NPT1/8
	1/4-18	18	100	20	14	11	14	3	-NPT1/4
	3/8-18	18	110	20	16	12	15	4	-NPT3/8
	1/2-14	14	125	26	18	14,5	17	4	-NPT1/2



Machine tap Paradur Inox®

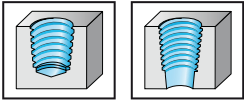

- HSS-E
- chamfer form C = 2 - 3 thread
- 30° helix angle
- materials from 350 to 1200 N/mm² or 36 HRC
- for long-chipping materials

NPT

ASME B1.20.1
1:16

	P	M	K	N	S	H	O
vap	●	●	●	●	●	●	●
THL	●	●	●	●	●	●	●

PWZ-Norm	D _N Nom	Threads per inch	l ₁ js16 mm	L _c mm	d ₁ h9 mm	□ h12 mm	l _g mm	N	VAP designation 25567	THL designation 2556702
									-NPT1/16	-NPT1/8
	1/16-27	27	80	14	8	6,2	9	3	-NPT1/16	-NPT1/8
	1/8-27	27	90	14	11	9	12	4	-NPT1/8	-NPT1/4
	1/4-18	18	100	20	14	11	14	4	-NPT1/4	-NPT1/4
	3/8-18	18	110	20	16	12	15	5	-NPT3/8	-NPT3/8
	1/2-14	14	125	26	18	14,5	17	5	-NPT1/2	-NPT1/2
	3/4-14	14	140	26	22	18	21	5	-NPT3/4	
	1-11 1/2	11,5	150	31	28	22	25	5	-NPT1	

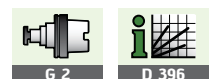

Machine tap Paradur® H

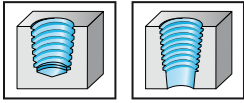

- HSS-E
- chamfer form C = 2 - 3 thread
- materials from 200 to 1000 N/mm² or 32 HRC
- for long and short-chipping materials

NPTF

ASME B1.20.3
1:16

	P	M	K	N	S	H	O
uncoated			●	●●			●

PWZ-Norm	D _N Nom	Threads per inch	l ₁ js16 mm	L _c mm	d ₁ h9 mm	□ h12 mm	l _g mm	N	uncoated designation 26167
	1/16-27	27	80	14	8	6,2	9	3	-NPTF1/16
	1/8-27	27	90	14	11	9	12	3	-NPTF1/8
	1/4-18	18	100	20	14	11	14	3	-NPTF1/4
	3/8-18	18	110	20	16	12	15	4	-NPTF3/8
	1/2-14	14	125	26	18	14,5	17	4	-NPTF1/2
	3/4-14	14	140	26	22	18	21	5	-NPTF3/4
	1-11 1/2	11,5	150	31	28	22	25	5	-NPTF1



Machine tap Paradur® N

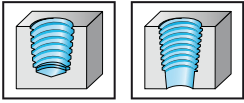

- HSS-E
- chamfer form C = 2 - 3 thread
- 15° helix angle
- materials from 200 to 1000 N/mm² or 32 HRC
- for long-chipping materials

NPTF

ASME B1.20.3
1:16

	P	M	K	N	S	H	O
vap	●●		●●	●●			

PWZ-Norm	D _N Nom	Threads per inch	l ₁ js16 mm	L _c mm	d ₁ h9 mm	□ h12 mm	l _g mm	N	VAP
									designation 26460
	1/16-27	27	80	14	8	6,2	9	3	-NPTF1/16
	1/8-27	27	90	14	11	9	12	3	-NPTF1/8
	1/4-18	18	100	20	14	11	14	3	-NPTF1/4
	3/8-18	18	110	20	16	12	15	4	-NPTF3/8
	1/2-14	14	125	26	18	14,5	17	4	-NPTF1/2
	3/4-14	14	140	26	22	18	21	5	-NPTF3/4



G 2

D 396

Machine tap Paradur Inox®

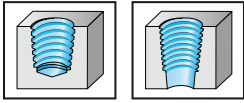

- HSS-E
- chamfer form C = 2 - 3 thread
- 30° helix angle
- materials from 350 to 1200 N/mm² or 36 HRC
- for long-chipping materials

NPTF

ASME B1.20.3
1:16

	P	M	K	N	S	H	O
vap	●●	●●	●				

PWZ-Norm	D _N Nom	Threads per inch	l ₁ js16 mm	L _c mm	d ₁ h9 mm	□ h12 mm	l _g mm	N	VAP designation 26567
	1/16-27	27	80	14	8	6,2	9	3	-NPTF1/16
	1/8-27	27	90	14	11	9	12	4	-NPTF1/8
	1/4-18	18	100	20	14	11	14	4	-NPTF1/4
	1/2-14	14	125	26	18	14,5	17	5	-NPTF1/2



G 2

D 396

Short machine tap KMB H



$\leq 3 \times D_N$

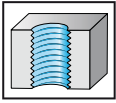

- HSS-E
- overall length S = short
- chamfer form B = 3.5 - 5 thread
- materials from 200 to 1000 N/mm² or 32 HRC
- for long-chipping materials

Pg

DIN 40430

	P	M	K	N	S	H	O
uncoated	●●		●●	●●			●

DIN 40 432		D_N Nom	D_N mm	Threads per inch	l_1 js16 mm	L_c mm	d_1 h9 mm	\square h12 mm	l_g mm	N	uncoated designation 27160
		Pg 7	12,5	20	70	20	9	7	10	4	-PG7
		Pg 9	15,2	18	70	20	12	9	12	4	-PG9
		Pg 11	18,6	18	80	22	14	11	14	4	-PG11
		Pg 13,5	20,4	18	80	22	16	12	15	4	-PG13.5
		Pg 16	22,5	18	80	22	18	14,5	17	4	-PG16
		Pg 21	28,3	16	90	22	22	18	21	4	-PG21

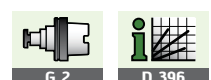

Machine tap Prototex® / Prototex® H

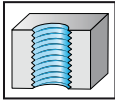
 $\leq 3 \times D_N$

- HSS-E
- chamfer form B = 3.5 - 5 thread
- materials from 200 to 700 N/mm² or 14 HRC
- for long-chipping materials

BSW

BS84

	P	M	K	N	S	H	O
uncoated	●	●	●	●			●

DIN 2184-1 mc	D _N Nom	D _N mm	Threads per inch	l ₁ js16 mm	L _c mm	l ₃ ±1 mm	d ₁ h9 mm	□ h12 mm	l _g mm	N	uncoated designation 28210
	1/8-40	3,175	40	56	10	18	3,5	2,7	6	2	-BSW1/8
	3/16-24	4,763	24	70	13	25	6	4,9	8	2	-BSW3/16
	1/4-20	6,35	20	80	15	30	7	5,5	8	3	-BSW1/4
	5/16-18	7,938	18	90	18	35	8	6,2	9	3	-BSW5/16
	3/8-16	9,525	16	100	20	39	10	8	11	3	-BSW3/8

DIN 2184-1 mc	D _N Nom	D _N mm	Threads per inch	l ₁ js16 mm	L _c mm	l ₃ ±1 mm	d ₁ h9 mm	□ h12 mm	l _g mm	N	uncoated designation 28360
	7/16-14	11,113	14	100	20	-	8	6,2	9	3	-BSW7/16
	1/2-12	12,7	12	110	23	-	9	7	10	3	-BSW1/2
	5/8-11	15,875	11	110	25	-	12	9	12	3	-BSW5/8
	3/4-10	19,05	10	125	30	-	14	11	14	4	-BSW3/4
	1-8	25,4	8	160	36	-	18	14,5	17	4	-BSW1
	7/8-9	22,225	9	140	30	-	18	14,5	17	4	-BSW7/8



Machine tap Paradur® WSH



$\leq 3 \times D_N$

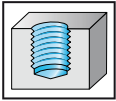

- HSS-E
- chamfer form C = 2 - 3 thread
- 45° helix angle
- materials from 200 to 1000 N/mm² or 32 HRC
- for long-chipping materials

BSW

BS84

	P	M	K	N	S	H	O
uncoated	●	●	●	●			

DIN 2184-1 mc	D _N Nom	D _N mm	Threads per inch	l ₁ js16 mm	L _c mm	l ₃ ±1 mm	d ₁ h9 mm	□ h12 mm	l _g mm	N	uncoated designation 28517
	1/8-40	3,175	40	56	6	18	3,5	2,7	6	3	-BSW1/8
	3/16-24	4,763	24	70	8	25	6	4,9	8	3	-BSW3/16
	1/4-20	6,35	20	80	10	30	7	5,5	8	3	-BSW1/4
	5/16-18	7,938	18	90	12	35	8	6,2	9	3	-BSW5/16
	3/8-16	9,525	16	100	15	39	10	8	11	3	-BSW3/8

DIN 2184-1 mc	D _N Nom	D _N mm	Threads per inch	l ₁ js16 mm	L _c mm	l ₃ ±1 mm	d ₁ h9 mm	□ h12 mm	l _g mm	N	uncoated designation 28567
	7/16-14	11,113	14	100	15	-	8	6,2	9	3	-BSW7/16
	1/2-12	12,7	12	110	18	-	9	7	10	3	-BSW1/2
	5/8-11	15,875	11	110	20	-	12	9	12	4	-BSW5/8
	3/4-10	19,05	10	125	25	-	14	11	14	4	-BSW3/4
	1-8	25,4	8	160	30	-	18	14,5	17	4	-BSW1
	7/8-9	22,225	9	140	25	-	18	14,5	17	4	-BSW7/8

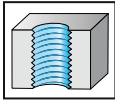

Trapezoidal cut tap TMB

 $\leq 2 \times D_N$

- HSS-E
- chamfer 24 x P
- 5° left-hand spiral
- materials from 200 to 900 N/mm² or 28 HRC
- for long and short-chipping materials

Tr

DIN 103

	P	M	K	N	S	H	O
uncoated	●●	●	●●	●●	●	●	●

PWZ-Norm 7H

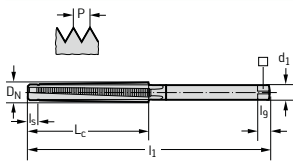

D _N	l ₁ js16 mm	L _c mm	l _s mm	d ₁ h9 mm	□ h12 mm	l _g mm	N	uncoated designation 29100
Tr 8	90	45	6	6	4,9	8	3	-TR8X1.5
Tr 10	135	60	7	7	5,5	8	3	-TR10X2
Tr 10	145	90	8	7	5,5	8	3	-TR10X3
Tr 12	175	90	8	8	6,2	9	3	-TR12X3
Tr 14	180	90	9	10	8	11	3	-TR14X3
Tr 14	215	120	10	10	8	11	3	-TR14X4
Tr 16	220	120	10	11	9	12	3	-TR16X4
Tr 18	225	120	12	12	9	12	3	-TR18X4
Tr 20	230	120	12	14	11	14	3	-TR20X4
Tr 22	265	150	15	16	12	15	3	-TR22X5
Tr 24	275	150	15	18	14,5	17	3	-TR24X5
Tr 28	285	150	18	22	18	21	3	-TR28X5
Tr 26	295	150	18	20	16	19	3	-TR26X5
Tr 30	320	180	21	22	18	21	4	-TR30X6

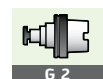

Trapezoidal cut tap TMB



$\leq 2 \times D_N$

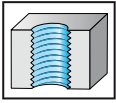

- HSS-E
- chamfer 24 x P
- 5° right-hand helix
- left-hand thread
- materials from 200 to 900 N/mm² or 28 HRC
- for long and short-chipping materials

Tr

DIN 103

	P	M	K	N	S	H	O
uncoated	●●	●	●●	●●	●	●	●

PWZ-Norm 7H		l_1 js16 mm	L_c mm	l_s mm	d_1 h9 mm	\square h12 mm	l_g mm	N	uncoated designation 29900
D_N	Tr 10 LH	135	60	7	7	5,5	8	3	-TR10X2
	Tr 12 LH	175	90	8	8	6,2	9	3	-TR12X3
	Tr 14 LH	215	120	10	10	8	11	3	-TR14X4
	Tr 16 LH	220	120	10	11	9	12	3	-TR16X4
	Tr 18 LH	225	120	12	12	9	12	3	-TR18X4
	Tr 20 LH	230	120	12	14	11	14	3	-TR20X4
	Tr 22 LH	265	150	15	16	12	15	3	-TR22X5
	Tr 24 LH	275	150	15	18	14,5	17	3	-TR24X5
	Tr 28 LH	285	150	18	22	18	21	3	-TR28X5
	Tr 26 LH	295	150	18	20	16	19	3	-TR26X5
	Tr 30 LH	320	180	21	22	18	21	4	-TR30X6

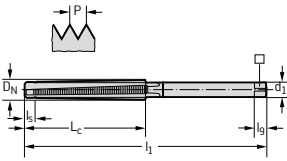

Machine tap Prototex® H Insert



$\leq 3 \times D_N$

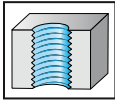

- HSS-E
- chamfer form B = 3.5 - 5 thread
- materials from 200 to 1000 N/mm² or 32 HRC
- for long-chipping materials

EgM

DIN 8140

	P	M	K	N	S	H	O
uncoated	●●		●	●●			●

DIN 40 435 6H mod	D _N Nom	P mm	l ₁ js16 mm	L _c mm	l ₃ ±1 mm	d ₁ h9 mm	□ h12 mm	l _g mm	N	uncoated designation 203031
	EG M 2,5	0,45	56	9	18	3,5	2,7	6	3	-EGM2.5
	EG M 3	0,5	63	12	21	4,5	3,4	6	3	-EGM3
	EG M 3,5	0,6	70	13	25	6	4,9	8	3	-EGM3.5
	EG M 4	0,7	70	13	25	6	4,9	8	3	-EGM4
	EG M 5	0,8	80	15	30	6	4,9	8	3	-EGM5
	EG M 6	1	90	18	35	8	6,2	9	3	-EGM6
	EG M 8	1,25	100	20	39	10	8	11	3	-EGM8

DIN 40 435 6H mod	D _N Nom	P mm	l ₁ js16 mm	L _c mm	l ₃ ±1 mm	d ₁ h9 mm	□ h12 mm	l _g mm	N	uncoated designation 203531
	EG M 10	1,5	100	21	-	9	7	10	3	-EGM10
	EG M 12	1,75	110	25	-	11	9	12	3	-EGM12
	EG M 14	2	110	25	-	12	9	12	3	-EGM14
	EG M 16	2	125	30	-	14	11	14	4	-EGM16



G 2



D 396

Machine tap Prototex Inox® Insert



$\leq 3 \times D_N$

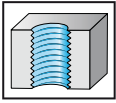

- HSS-E
- chamfer form B = 3.5 - 5 thread
- materials from 350 to 1200 N/mm² or 36 HRC
- for long-chipping materials

EgM

DIN 8140

	P	M	K	N	S	H	O
vap	●●	●●	●	●	●	●	●

DIN 40 435 6H mod		D_N Nom	P mm	l_1 js16 mm	L_c mm	l_3 ± 1 mm	d_1 h9 mm	\square h12 mm	l_g mm	N	VAP designation 203039
	EG M 2,5	0,45	56	9	18	3,5	2,7	6	2	-EGM2.5	
	EG M 3	0,5	63	12	21	4,5	3,4	6	2	-EGM3	
	EG M 4	0,7	70	13	25	6	4,9	8	3	-EGM4	
	EG M 5	0,8	80	15	30	6	4,9	8	3	-EGM5	
	EG M 6	1	90	18	35	8	6,2	9	3	-EGM6	
	EG M 8	1,25	100	20	39	10	8	11	3	-EGM8	



Machine tap Prototex® TiNi Insert



$\leq 2 \times D_N$

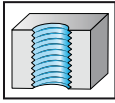

- HSS-E-PM
- chamfer form B = 3.5 - 5 thread
- materials from 700 to 1400 N/mm² or 44 HRC
- for long-chipping materials

EgM

LN 9499

	P	M	K	N	S	H	O
uncoated	●●	●●	●	●	●●		

~DIN 40 435 4H		D_N Nom	P mm	l_1 js16 mm	L_c mm	l_3 ± 1 mm	d_1 h9 mm	\square h12 mm	l_9 mm	N	uncoated designation 20207
		EG M 4	0,7	70	16	-	6	4,9	8	3	-EGM4 ¹
		EG M 5	0,8	80	15	23	6	4,9	8	3	-EGM5
		EG M 6	1	90	18	29	8	6,2	9	3	-EGM6
		EG M 8	1,25	100	20	33	10	8	11	3	-EGM8

¹without neck

Machine tap Paradur® WSH Insert

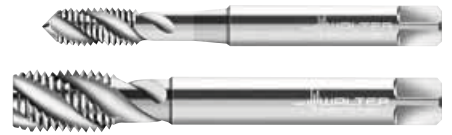

$\leq 3 \times D_N$

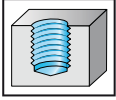

- HSS-E
- chamfer form C = 2 - 3 thread
- 45° helix angle
- materials from 200 to 1000 N/mm² or 32 HRC
- for long-chipping materials

EgM

DIN 8140

	P	M	K	N	S	H	O
uncoated	●●		●				

DIN 40 435 6H mod		D_N Nom	P mm	l_1 js16 mm	L_c mm	l_3 ± 1 mm	d_1 h9 mm	\square h12 mm	l_g mm	N	uncoated designation 205051
	EG M 2,5	0,45	56	6	18	3,5	2,7	6	3	-EGM2.5	
	EG M 3	0,5	63	7	21	4,5	3,4	6	3	-EGM3	
	EG M 4	0,7	70	8	25	6	4,9	8	3	-EGM4	
	EG M 5	0,8	80	10	30	6	4,9	8	3	-EGM5	
	EG M 6	1	90	12	35	8	6,2	9	3	-EGM6	
	EG M 8	1,25	100	15	39	10	8	11	3	-EGM8	

DIN 40 435 6H mod		D_N Nom	P mm	l_1 js16 mm	L_c mm	l_3 ± 1 mm	d_1 h9 mm	\square h12 mm	l_g mm	N	uncoated designation 205551
	EG M 10	1,5	100	13	-	9	7	10	4	-EGM10	
	EG M 12	1,75	110	20	-	11	9	12	4	-EGM12	
	EG M 14	2	110	20	-	12	9	12	4	-EGM14	
	EG M 16	2	125	25	-	14	11	14	4	-EGM16	
	EG M 20	2,5	160	25	-	18	14,5	17	4	-EGM20	
	EG M 24	3	160	30	-	20	16	19	4	-EGM24	



Machine tap
Paradur Inox® 50 Insert



$\leq 3 \times D_N$

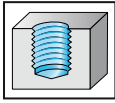

- HSS-E
- chamfer form C = 2 - 3 thread
- 50° helix angle
- materials from 350 to 1200 N/mm² or 36 HRC
- for long-chipping materials

EgM

DIN 8140

	P	M	K	N	S	H	O
vap	●●	●●	●	●	●	●	●

DIN 40 435 6H mod		D_N Nom	P mm	l_1 js16 mm	L_c mm	l_3 ± 1 mm	d_1 h9 mm	\square h12 mm	l_g mm	N	VAP designation 205059
	EG M 2,5	0,45	56	6	18	3,5	2,7	6	3	-EGM2.5	
	EG M 3	0,5	63	7	21	4,5	3,4	6	3	-EGM3	
	EG M 4	0,7	70	8	25	6	4,9	8	3	-EGM4	
	EG M 5	0,8	80	10	30	6	4,9	8	3	-EGM5	
	EG M 6	1	90	12	35	8	6,2	9	3	-EGM6	
	EG M 8	1,25	100	15	39	10	8	11	3	-EGM8	

DIN 40 435 6H mod		D_N Nom	P mm	l_1 js16 mm	L_c mm	l_3 ± 1 mm	d_1 h9 mm	\square h12 mm	l_g mm	N	VAP designation 205559
	EG M 10	1,5	100	13	-	9	7	10	4	-EGM10	
	EG M 12	1,75	110	20	-	11	9	12	4	-EGM12	
	EG M 14	2	110	20	-	12	9	12	4	-EGM14	
	EG M 16	2	125	25	-	14	11	14	4	-EGM16	



G 2



D 396

Machine tap Paradur® WLM Insert



$\leq 3 \times D_N$

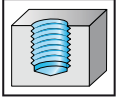

- HSS-E
- chamfer form C = 2 - 3 thread
- 35° helix angle
- materials from 200 to 700 N/mm² or 14 HRC
- for long-chipping materials

EgM

DIN 8140

	P	M	K	N	S	H	O
uncoated				●●	●●		●●

DIN 40 435 6H mod		D_N Nom	P mm	l_1 js16 mm	L_c mm	l_3 ± 1 mm	d_1 h9 mm	\square h12 mm	l_g mm	N	uncoated designation 20505
	EG M 2,5	0,45	56	6	18	3,5	2,7	6	2	-EGM2.5	
	EG M 3	0,5	63	7	21	4,5	3,4	6	2	-EGM3	
	EG M 4	0,7	70	8	25	6	4,9	8	2	-EGM4	
	EG M 5	0,8	80	10	30	6	4,9	8	3	-EGM5	
	EG M 6	1	90	12	35	8	6,2	9	3	-EGM6	
	EG M 8	1,25	100	15	39	10	8	11	3	-EGM8	

DIN 40 435 6H mod		D_N Nom	P mm	l_1 js16 mm	L_c mm	l_3 ± 1 mm	d_1 h9 mm	\square h12 mm	l_g mm	N	uncoated designation 20555
	EG M 10	1,5	100	13	-	9	7	10	3	-EGM10	
	EG M 12	1,75	110	20	-	11	9	12	3	-EGM12	
	EG M 16	2	125	25	-	14	11	14	4	-EGM16	

Machine tap Paradur® NI Insert



$\leq 1,5 \times D_N$

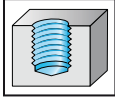

- HSS-E-PM
- chamfer form C = 2 - 3 thread
- 25° helix angle
- materials from 700 to 1400 N/mm² or 44 HRC
- for long-chipping materials

EgM

LN 9499

	P	M	K	N	S	H	O
uncoated	●●	●	●●	●	●	●	●

~DIN 40 435 4H		D_N Nom	P mm	l_1 js16 mm	L_c mm	l_3 ± 1 mm	d_1 h9 mm	\square h12 mm	l_9 mm	N	uncoated designation 204089
		EG M 4	0,7	70	16	-	6	4,9	8	3	-EGM4 ¹
		EG M 5	0,8	80	15	23	6	4,9	8	3	-EGM5
		EG M 6	1	90	18	29	8	6,2	9	3	-EGM6
		EG M 8	1,25	100	20	33,5	10	8	11	4	-EGM8

¹without neck



G 2

D 396

Machine tap Paradur® TI Insert



$\leq 2 \times D_N$

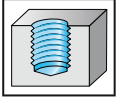

- HSS-E-PM
- chamfer form C = 2 - 3 thread
- 15° helix angle
- materials from 700 to 1400 N/mm² or 44 HRC
- for long-chipping materials

EgM

LN 9499

	P	M	K	N	S	H	O
uncoated	●●			●	●●		

~DIN 40 435 4H		D_N Nom	P mm	l_1 js16 mm	L_c mm	l_3 ± 1 mm	d_1 h9 mm	\square h12 mm	l_g mm	N	uncoated designation 204069
		EG M 4	0,7	70	16	-	6	4,9	8	3	-EGM4 ¹
		EG M 5	0,8	80	15	23	6	4,9	8	3	-EGM5
		EG M 6	1	90	18	29	8	6,2	9	3	-EGM6
		EG M 8	1,25	100	20	33,5	10	8	11	3	-EGM8

¹without neck

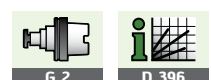

Machine tap Paradur® WSH Insert



$\leq 3 \times D_N$

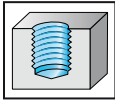

- HSS-E
- chamfer form C = 2 - 3 thread
- 45° helix angle
- materials from 200 to 1000 N/mm² or 32 HRC
- for long-chipping materials

EgMF

DIN 8140

	P	M	K	N	S	H	O
uncoated	●●		●				

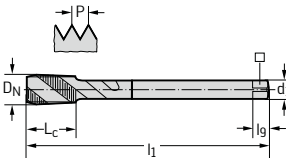
DIN 40 435 6H mod	D_N Nom	P mm	l_1 js16 mm	L_c mm	d_1 h9 mm	\square h12 mm	l_g mm	N	uncoated designation 21551
	EG M 8	1	90	12	7	5,5	8	3	-EGM8X1
	EG M 10	1	100	13	9	7	10	3	-EGM10X1
	EG M 12	1,5	100	15	11	9	12	4	-EGM12X1.5
	EG M 14	1,5	100	15	12	9	12	4	-EGM14X1.5
	EG M 16	1,5	110	17	14	11	14	4	-EGM16X1.5

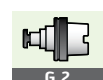

Machine tap Prototex® H Insert



$\leq 3 \times D_N$

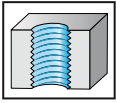

- HSS-E
- chamfer form B = 3.5 - 5 thread
- materials from 200 to 1000 N/mm² or 32 HRC
- for long-chipping materials

EgUNC

NASM 33537

	P	M	K	N	S	H	O
uncoated	●●		●	●●			●

DIN 2184-1 3B	D _N -P Nom	D _N mm	l ₁ js16 mm	L _c mm	l ₃ ±1 mm	d ₁ h9 mm	□ h12 mm	l _g mm	N	uncoated designation 223031
	EG no. 6-32	4,536	70	13	25	6	4,9	8	3	-EGUNC6
	EG no. 8-32	5,197	80	15	30	6	4,9	8	3	-EGUNC8
	EG no. 10-24	6,201	80	15	30	7	5,5	8	3	-EGUNC10
	EG 1/4-20	8	90	18	35	8	6,2	9	3	-EGUNC1/4

Machine tap Paradur® WSH Insert



$\leq 3 \times D_N$

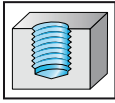

- HSS-E
- chamfer form C = 2 - 3 thread
- 45° helix angle
- materials from 200 to 1000 N/mm² or 32 HRC
- for long-chipping materials

EgUNC

NASM 33537

	P	M	K	N	S	H	O
uncoated	●●		●				

DIN 2184-1 3B

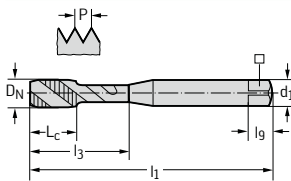

D _N -P Nom	D _N mm	l ₁ js16 mm	L _c mm	l ₃ ±1 mm	d ₁ h9 mm	□ h12 mm	l ₉ mm	N	uncoated designation 225051
EG Nr. 6-32	4,536	70	8	25	6	4,9	8	3	-EGUNC6
EG Nr. 8-32	5,197	80	10	30	6	4,9	8	3	-EGUNC8
EG Nr.10-24	6,201	80	10	30	7	5,5	8	3	-EGUNC10
EG 1/4-20	8	90	12	35	8	6,2	9	3	-EGUNC1/4

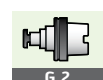

Machine tap Paradur Inox® 50 Insert



$\leq 3 \times D_N$

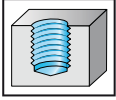

- HSS-E
- chamfer form C = 2 - 3 thread
- 50° helix angle
- materials from 350 to 1200 N/mm² or 36 HRC
- for long-chipping materials

EgUNC

NASM 33537

	P	M	K	N	S	H	O
vap	●●	●●	●●	●●	●●	●●	●●

DIN 2184-1 3B	D _N -P Nom	D _N mm	l ₁ js16 mm	L _c mm	l ₃ ±1 mm	d ₁ h9 mm	□ h12 mm	l _g mm	N	VAP designation 225059
	EG no. 4-40	3,67	63	7	21	4,5	3,4	6	3	-EGUNC4
	EG no. 6-32	4,536	70	8	25	6	4,9	8	3	-EGUNC6
	EG no. 8-32	5,197	80	10	30	6	4,9	8	3	-EGUNC8
	EG no. 10-24	6,201	80	10	30	7	5,5	8	3	-EGUNC10
	EG 1/4-20	8	90	12	35	8	6,2	9	3	-EGUNC1/4

DIN 2184-1 3B	D _N -P Nom	D _N mm	l ₁ js16 mm	L _c mm	l ₃ ±1 mm	d ₁ h9 mm	□ h12 mm	l _g mm	N	VAP designation 225559
	EG 5/16-18	9,771	100	15	-	7	5,5	8	3	-EGUNC5/16
	EG 3/8-16	11,587	100	13	-	9	7	10	3	-EGUNC3/8
	EG 1/2-13	15,238	110	20	-	12	9	12	4	-EGUNC1/2



Machine tap
Paradur® WLM Insert



$\leq 3 \times D_N$

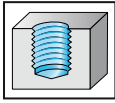

- HSS-E
- chamfer form C = 2 - 3 thread
- 35° helix angle
- materials from 200 to 700 N/mm² or 14 HRC
- for long-chipping materials

EgUNC

NASM 33537

	P	M	K	N	S	H	O
uncoated				●●	●●		●●

DIN 2184-1 3B	D _N -P Nom	D _N mm	l ₁ js16 mm	L _c mm	l ₃ ±1 mm	d ₁ h9 mm	□ h12 mm	l _g mm	N	uncoated designation 22505
	EG no. 6-32	4,536	70	8	25	6	4,9	8	2	-EGUNC6
	EG no. 8-32	5,197	80	10	30	6	4,9	8	2	-EGUNC8
	EG no. 10-24	6,201	80	10	30	7	5,5	8	2	-EGUNC10
	EG 1/4-20	8	90	12	35	8	6,2	9	2	-EGUNC1/4

DIN 2184-1 3B	D _N -P Nom	D _N mm	l ₁ js16 mm	L _c mm	l ₃ ±1 mm	d ₁ h9 mm	□ h12 mm	l _g mm	N	uncoated designation 22555
	EG 5/16-18	9,771	100	15	-	7	5,5	8	2	-EGUNC5/16
	EG 3/8-16	11,587	100	13	-	9	7	10	3	-EGUNC3/8



Machine tap Paradur® TI Insert



$\leq 2 \times D_N$

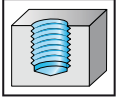

- HSS-E-PM
- chamfer form C = 2 - 3 thread
- 15° helix angle
- materials from 700 to 1400 N/mm² or 44 HRC
- for long-chipping materials

EgUNC

NASM 33537

	P	M	K	N	S	H	O
uncoated	●●			●	●●		

~DIN 2184-1 3B	D _N -P Nom	D _N mm	l ₁ js16 mm	L _c mm	l ₃ ±1 mm	d ₁ h9 mm	□ h12 mm	l _g mm	N	uncoated designation 224069
	EG no. 4-40	3,67	63	13	-	4,5	3,4	6	3	-EGUNC4 ¹
	EG no. 6-32	4,536	70	16	-	6	4,9	8	3	-EGUNC6 ¹
	EG no. 8-32	5,197	80	15	23	6	4,9	8	3	-EGUNC8

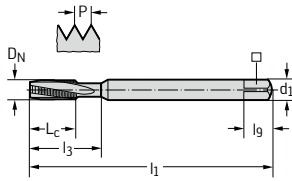

¹without neck

Machine tap Prototex® TiNi Insert



$\leq 2 \times D_N$

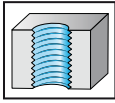

- HSS-E-PM
- chamfer form B = 3.5 - 5 thread
- materials from 700 to 1400 N/mm² or 44 HRC
- for long-chipping materials

EgUNC

NASM 33537

	P	M	K	N	S	H	O
uncoated	●●	●●	●	●	●●		

DIN 2184-1 3B	D_N -P Nom	D_N mm	l_1 js16 mm	L_c mm	l_3 ± 1 mm	d_1 h9 mm	\square h12 mm	l_9 mm	N	uncoated designation 222079
	EG no. 4-40	3,67	63	13	-	4,5	3,4	6	3	-EGUNC4 ¹
	EG no. 6-32	4,536	70	16	-	6	4,9	8	3	-EGUNC6 ¹
	EG no. 8-32	5,197	80	15	23	6	4,9	8	3	-EGUNC8

¹without neck



Machine tap Prototex® H Insert



$\leq 3 \times D_N$

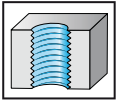

- HSS-E
- chamfer form B = 3.5 - 5 thread
- materials from 200 to 1000 N/mm² or 32 HRC
- for long-chipping materials

EgUNF

NASM 33537

	P	M	K	N	S	H	O
uncoated	●●		●	●●			●

DIN 2184-1 3B	D _N -P Nom	D _N mm	l ₁ js16 mm	L _c mm	l ₃ ±1 mm	d ₁ h9 mm	□ h12 mm	l _g mm	N	uncoated designation 233031
	EG no. 6-40	4,33	70	13	25	6	4,9	8	3	-EGUNF6
	EG no. 8-36	5,083	80	15	30	6	4,9	8	3	-EGUNF8
	EG no. 10-32	5,857	80	15	30	6	4,9	8	3	-EGUNF10
	EG 1/4-28	7,528	90	18	35	8	6,2	9	3	-EGUNF1/4

DIN 2184-1 3B	D _N -P Nom	D _N mm	l ₁ js16 mm	L _c mm	l ₃ ±1 mm	d ₁ h9 mm	□ h12 mm	l _g mm	N	uncoated designation 233531
	EG 5/16-24	9,313	90	20	-	7	5,5	8	3	-EGUNF5/16
	EG 3/8-24	10,9	90	20	-	8	6,2	9	3	-EGUNF3/8
	EG 7/16-20	12,763	100	21	-	9	7	10	4	-EGUNF7/16
	EG 1/2-20	14,35	100	21	-	11	9	12	4	-EGUNF1/2

Machine tap Prototex Inox® Insert



$\leq 3 \times D_N$

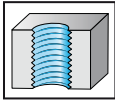

- HSS-E
- chamfer form B = 3.5 - 5 thread
- materials from 350 to 1200 N/mm² or 36 HRC
- for long-chipping materials

EgUNF

NASM 33537

	P	M	K	N	S	H	O
vap	●	●	●	●	●	●	●

DIN 2184-1 3B

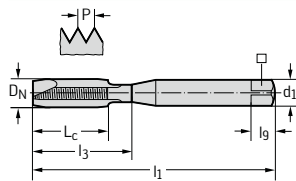

D _N -P Nom	D _N mm	l ₁ js16 mm	L _c mm	l ₃ ±1 mm	d ₁ h9 mm	□ h12 mm	l _g mm	N	VAP designation 233039
EG no. 8-36	5,083	80	15	30	6	4,9	8	3	-EGUNF8
EG no. 10-32	5,857	80	15	30	6	4,9	8	3	-EGUNF10
EG 1/4-28	7,528	90	18	35	8	6,2	9	3	-EGUNF1/4

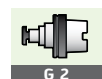

Machine tap Prototex® TiNi Insert



$\leq 2 \times D_N$

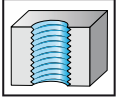

- HSS-E-PM
- chamfer form B = 3.5 - 5 thread
- materials from 700 to 1400 N/mm² or 44 HRC
- for long-chipping materials

EgUNF

NASM 33537

	P	M	K	N	S	H	O
uncoated	●●	●●	●●	●	●●		

~DIN 2184-1 3B		D_N -P Nom	D_N mm	l_1 js16 mm	L_c mm	l_3 ± 1 mm	d_1 h9 mm	\square h12 mm	l_g mm	N	uncoated designation 232079
	EG no. 10-32	5,857	80	15	23	6	4,9	8	8	3	-EGUNF10
	EG 1/4-28	7,528	90	18	29,5	8	6,2	9	9	3	-EGUNF1/4
	EG 5/16-24	9,313	100	20	33,5	10	8	11	11	3	-EGUNF5/16

DIN 2184-1 3B		D_N -P Nom	D_N mm	l_1 js16 mm	L_c mm	l_3 ± 1 mm	d_1 h9 mm	\square h12 mm	l_g mm	N	uncoated designation 232579
	EG 3/8-24	10,9	100	20	-	8	6,2	9	9	3	-EGUNF3/8

Machine tap Paradur® WSH Insert



$\leq 3 \times D_N$

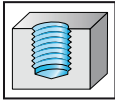

- HSS-E
- chamfer form C = 2 - 3 thread
- 45° helix angle
- materials from 200 to 1000 N/mm² or 32 HRC
- for long-chipping materials

EgUNF

NASM 33537

	P	M	K	N	S	H	O
uncoated	●●		●				

DIN 2184-1 3B	D _N -P Nom	D _N mm	l ₁ js16 mm	L _c mm	l ₃ ±1 mm	d ₁ h9 mm	□ h12 mm	l _g mm	N	uncoated designation 235051
	EG no. 6-40	4,33	70	8	25	6	4,9	8	3	-EGUNF6
	EG no. 8-36	5,083	80	10	30	6	4,9	8	3	-EGUNF8
	EG no. 10-32	5,857	80	10	30	6	4,9	8	3	-EGUNF10
	EG 1/4-28	7,528	90	12	35	8	6,2	9	3	-EGUNF1/4

DIN 2184-1 3B	D _N -P Nom	D _N mm	l ₁ js16 mm	L _c mm	l ₃ ±1 mm	d ₁ h9 mm	□ h12 mm	l _g mm	N	uncoated designation 235551
	EG 5/16-24	9,313	90	12	-	7	5,5	8	3	-EGUNF5/16
	EG 3/8-24	10,9	90	15	-	8	6,2	9	3	-EGUNF3/8
	EG 7/16-20	12,763	100	13	-	9	7	10	4	-EGUNF7/16
	EG 1/2-20	14,35	100	15	-	11	9	12	4	-EGUNF1/2



Machine tap Paradur Inox® 50 Insert



$\leq 3 \times D_N$

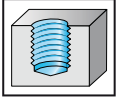

- HSS-E
- chamfer form C = 2 - 3 thread
- 50° helix angle
- materials from 350 to 1200 N/mm² or 36 HRC
- for long-chipping materials

EgUNF

NASM 33537

	P	M	K	N	S	H	O
vap	●●	●●	●●	●●	●●	●●	●●

DIN 2184-1 3B	D _N -P Nom	D _N mm	l ₁ js16 mm	L _c mm	l ₃ ±1 mm	d ₁ h9 mm	□ h12 mm	l _g mm	N	VAP designation 235059
	EG no. 10-32	5,857	80	10	30	6	4,9	8	3	-EGUNF10
	EG 1/4-28	7,528	90	12	35	8	6,2	9	3	-EGUNF1/4

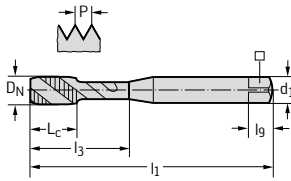

Machine tap
Paradur® WLM Insert



$\leq 3 \times D_N$

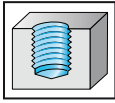

- HSS-E
- chamfer form C = 2 - 3 thread
- 35° helix angle
- materials from 200 to 700 N/mm² or 14 HRC
- for long-chipping materials

EgUNF

NASM 33537

	P	M	K	N	S	H	O
uncoated				●●	●●		●●

DIN 2184-1 3B	D _N -P Nom	D _N mm	l ₁ js16 mm	L _c mm	l ₃ ±1 mm	d ₁ h9 mm	□ h12 mm	l _g mm	N	uncoated designation 23505
	EG no. 10-32	5,857	80	10	30	6	4,9	8	2	-EGUNF10
	EG 1/4-28	7,528	90	12	35	8	6,2	9	3	-EGUNF1/4

DIN 2184-1 3B	D _N -P Nom	D _N mm	l ₁ js16 mm	L _c mm	l ₃ ±1 mm	d ₁ h9 mm	□ h12 mm	l _g mm	N	uncoated designation 23555
	EG 5/16-24	9,313	90	12	-	7	5,5	8	3	-EGUNF5/16
	EG 3/8-24	10,9	90	15	-	8	6,2	9	3	-EGUNF3/8
	EG 7/16-20	12,763	100	13	-	9	7	10	3	-EGUNF7/16
	EG 1/2-20	14,35	100	15	-	11	9	12	3	-EGUNF1/2



Machine tap Paradur® NI Insert



$\leq 1,5 \times D_N$

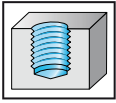

- HSS-E-PM
- chamfer form C = 2 - 3 thread
- 25° helix angle
- materials from 700 to 1400 N/mm² or 44 HRC
- for long-chipping materials

EgUNF

NASM 33537

	P	M	K	N	S	H	O
uncoated	●●	●	●●	●	●		

~DIN 2184-1 3B		D_N -P Nom	D_N mm	l_1 js16 mm	L_c mm	l_3 ± 1 mm	d_1 h9 mm	\square h12 mm	l_g mm	N	uncoated designation 234079
	EG no. 10-32	5,857	80	15	23	6	4,9	8	3	3	-EGUNF10
	EG 1/4-28	7,528	90	18	29,5	8	6,2	9	3	3	-EGUNF1/4
	EG 5/16-24	9,313	100	20	33,5	10	8	11	4	4	-EGUNF5/16

DIN 2184-1 3B		D_N -P Nom	D_N mm	l_1 js16 mm	L_c mm	l_3 ± 1 mm	d_1 h9 mm	\square h12 mm	l_g mm	N	uncoated designation 234579
	EG 3/8-24	10,9	100	20	-	8	6,2	9	4	4	-EGUNF3/8



Machine tap Paradur® TI Insert



$\leq 2 \times D_N$

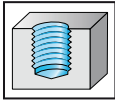

- HSS-E-PM
- chamfer form C = 2 - 3 thread
- 15° helix angle
- materials from 700 to 1400 N/mm² or 44 HRC
- for long-chipping materials

EgUNF

NASM 33537

	P	M	K	N	S	H	O
uncoated	●●	●	●	●	●●	●	●

~DIN 2184-1 3B		D_N -P Nom	D_N mm	l_1 js16 mm	L_c mm	l_3 ± 1 mm	d_1 h9 mm	\square h12 mm	l_g mm	N	uncoated designation 234069
	EG no. 10-32	5,857	80	15	23	6	4,9	8	3	3	-EGUNF10
	EG 1/4-28	7,528	90	18	29,5	8	6,2	9	3	3	-EGUNF1/4
	EG 5/16-24	9,313	100	20	33,5	10	8	11	3	3	-EGUNF5/16

DIN 2184-1 3B		D_N -P Nom	D_N mm	l_1 js16 mm	L_c mm	l_3 ± 1 mm	d_1 h9 mm	\square h12 mm	l_g mm	N	uncoated designation 234569
	EG 3/8-24	10,9	100	20	-	8	6,2	9	4	4	-EGUNF3/8





Machine tap Prototex® Constant



$\leq 1 \times D_N$

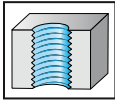

- HSS-E
- chamfer form B = 3.5 - 5 thread
- materials from 200 to 700 N/mm² or 14 HRC
- for long-chipping materials

M
DIN 13

	P	M	K	N	S	H	O
uncoated	●●			●●			

DIN 371	ISO2/6H	D_N	P mm	l_1 js16 mm	L_c mm	l_3 ± 1 mm	d_1 h9 mm	\square h12 mm	l_g mm	N	uncoated designation 70211
		M 1	0,25	40	5	-	2,5	2,1	5	2	-M1
		M 1,2	0,25	40	5	-	2,5	2,1	5	2	-M1.2
		M 1,4	0,3	40	6,5	-	2,5	2,1	5	2	-M1.4
		M 1,6	0,35	40	7	-	2,5	2,1	5	2	-M1.6
		M 1,7	0,35	40	7	-	2,5	2,1	5	2	-M1.7
		M 2	0,4	45	6	9	2,8	2,1	5	2	-M2
		M 2,5	0,45	50	8	12,5	2,8	2,1	5	2	-M2.5
		M 3	0,5	56	9	18	3,5	2,7	6	2	-M3
		M 4	0,7	63	12	21	4,5	3,4	6	2	-M4
		M 5	0,8	70	13	25	6	4,9	8	2	-M5
		M 6	1	80	15	30	6	4,9	8	3	-M6
		M 8	1,25	90	18	35	8	6,2	9	3	-M8
		M 10	1,5	100	20	39	10	8	11	3	-M10

$\leq M 1.4: 5H, \geq M 1.6: ISO 2/6H$



Machine tap Prototex® H



$\leq 3 \times D_N$

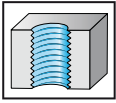

- HSS-E
- overall length L = long
- chamfer form B = 3.5 - 5 thread
- materials from 200 to 1000 N/mm² or 32 HRC
- for long-chipping materials

M

DIN 13

	P	M	K	N	S	H	O
uncoated	●●		●	●●			●

~DIN 376 ISO2/6H		D_N	P mm	l_1 js16 mm	L_c mm	d_1 h9 mm	\square h12 mm	l_g mm	N	uncoated designation 7026050
	M 3		0,5	70	18	2,2	-	-	3	-M3
	M 4		0,7	90	22	2,8	2,1	5	3	-M4
	M 5		0,8	100	24	3,5	2,7	6	3	-M5
	M 6		1	110	25	4,5	3,4	6	3	-M6
	M 8		1,25	125	28	6	4,9	8	3	-M8
	M 10		1,5	140	30	7	5,5	8	3	-M10
	M 12		1,75	180	35	9	7	10	3	-M12
M 14		2	200	35	11	9	12	3	-M14	



**Machine tap
Prototex® Uni**



$\leq 3 \times D_N$

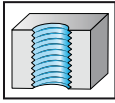

- HSS-E
- chamfer form B = 3.5 - 5 thread
- materials from 200 to 1000 N/mm² or 32 HRC
- for long-chipping materials

M
DIN 13

	P	M	K	N	S	H	O
uncoated	●●	●	●	●●	●	●	●
vap	●●	●	●	●●	●	●	●
TiN	●●	●	●	●●	●	●	●
TiCN	●●	●	●	●●	●	●	●

DIN 371 ISO2/6H

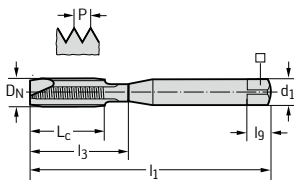

D _N	P mm	l ₁ js16 mm	L _c mm	l ₃ ±1 mm	d ₁ h9 mm	□ h12 mm	l _g mm	N	uncoated designation 70310	VAP designation 7031003	TIN designation 7031005	TICN designation 7031006
M 2	0,4	45	6	9	2,8	2,1	5	2	-M2			
M 2,5	0,45	50	8	12,5	2,8	2,1	5	2	-M2.5			
M 2,6	0,45	50	8	12,5	2,8	2,1	5	2	-M2.6			
M 3	0,5	56	9	18	3,5	2,7	6	3	-M3	-M3	-M3	-M3
M 3,5	0,6	56	11	20	4	3	6	3	-M3.5		-M3.5	
M 4	0,7	63	12	21	4,5	3,4	6	3	-M4	-M4	-M4	-M4
M 5	0,8	70	13	25	6	4,9	8	3	-M5	-M5	-M5	-M5
M 6	1	80	15	30	6	4,9	8	3	-M6	-M6	-M6	-M6
M 7	1	80	15	30	7	5,5	8	3	-M7		-M7	
M 8	1,25	90	18	35	8	6,2	9	3	-M8	-M8	-M8	-M8
M 9	1,25	90	18	35	9	7	10	3	-M9			
M 10	1,5	100	20	39	10	8	11	3	-M10	-M10	-M10	-M10

DIN 376 ISO2/6H

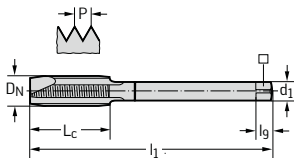

D _N	P mm	l ₁ js16 mm	L _c mm	l ₃ ±1 mm	d ₁ h9 mm	□ h12 mm	l _g mm	N	uncoated designation 70360	VAP designation 7036003	TIN designation 7036005	TICN designation 7036006
M 2	0,4	45	6	-	1,4	1,12	4	2	-M2			
M 2,5	0,45	50	8	-	1,8	1,4	4	2	-M2.5			
M 3	0,5	56	9	-	2,2	1,8	4	3	-M3			
M 4	0,7	63	12	-	2,8	2,1	5	3	-M4			
M 5	0,8	70	13	-	3,5	2,7	6	3	-M5			
M 6	1	80	15	-	4,5	3,4	6	3	-M6			
M 8	1,25	90	18	-	6	4,9	8	3	-M8			
M 9	1,25	90	18	-	7	5,5	8	3	-M9			
M 10	1,5	100	20	-	7	5,5	8	3	-M10			
M 12	1,75	110	23	-	9	7	10	3	-M12	-M12	-M12	-M12
M 14	2	110	25	-	11	9	12	3	-M14	-M14	-M14	-M14
M 16	2	110	25	-	12	9	12	3	-M16	-M16	-M16	-M16
M 18	2,5	125	30	-	14	11	14	3	-M18		-M18	
M 20	2,5	140	30	-	16	12	15	3	-M20		-M20	
M 22	2,5	140	30	-	18	14,5	17	3	-M22			
M 24	3	160	36	-	18	14,5	17	3	-M24			
M 27	3	160	36	-	20	16	19	4	-M27			
M 30	3,5	180	42	-	22	18	21	4	-M30			
M 33	3,5	180	42	-	25	20	23	4	-M33			
M 36	4	200	48	-	28	22	25	4	-M36			
M 39	4	200	48	-	32	24	27	4	-M39			
M 42	4,5	200	54	-	32	24	27	4	-M42			



Machine tap Prototex® Uni



$\leq 3 \times D_N$

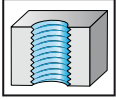

- HSS-E
- chamfer form B = 3.5 - 5 thread
- materials from 200 to 1000 N/mm² or 32 HRC
- for long-chipping materials

M

DIN 13

	P	M	K	N	S	H	O
uncoated	●●	●	●	●●	●	●	●

DIN 371 ISO3/6G		P	l ₁ js16	L _c	l ₃ ±1	d ₁ h9	□ h12	l _g	N	uncoated designation 70230
D _N	P	mm	mm	mm	mm	mm	mm	mm		
M 2	0,4	45	6	9	2,8	2,1	5	2	-M2	
M 2,5	0,45	50	8	12,5	2,8	2,1	5	2	-M2.5	

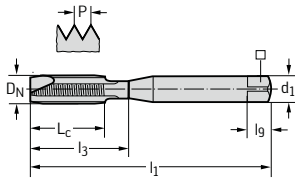

DIN 371 ISO3/6G		P	l ₁ js16	L _c	l ₃ ±1	d ₁ h9	□ h12	l _g	N	uncoated designation 70330
D _N	P	mm	mm	mm	mm	mm	mm	mm		
M 3	0,5	56	9	18	3,5	2,7	6	3	-M3	
M 4	0,7	63	11	21	4,5	3,4	6	3	-M4	
M 5	0,8	70	13	25	6	4,9	8	3	-M5	
M 6	1	80	15	30	6	4,9	8	3	-M6	
M 8	1,25	90	18	35	8	6,2	9	3	-M8	
M 10	1,5	100	20	39	10	8	11	3	-M10	

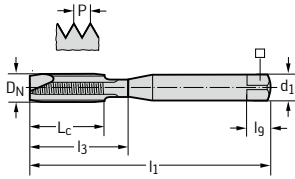

DIN 376 ISO3/6G		P	l ₁ js16	L _c	l ₃ ±1	d ₁ h9	□ h12	l _g	N	uncoated designation 70380
D _N	P	mm	mm	mm	mm	mm	mm	mm		
M 12	1,75	110	23	-	9	7	10	3	-M12	
M 14	2	110	25	-	11	9	12	3	-M14	
M 16	2	110	25	-	12	9	12	3	-M16	

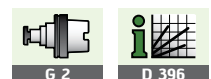
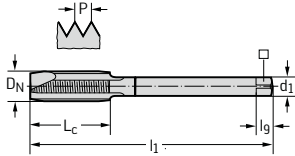

Machine tap Prototex® VA

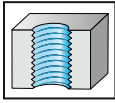

 $\leq 3 \times D_N$

- HSS-E
- chamfer form B = 3.5 - 5 thread
- materials from 700 to 1200 N/mm² or 36 HRC
- for long-chipping materials

M
DIN 13

	P	M	K	N	S	H	O
uncoated	●	●	●	●	●	●	●
vap	●	●	●	●	●	●	●
TiN	●	●	●	●	●	●	●

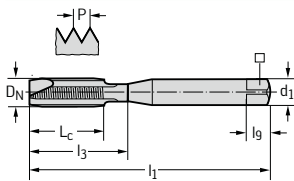
DIN 371 6HX



D _N	P mm	l ₁ js16 mm	L _c mm	l ₃ ±1 mm	d ₁ h9 mm	□ h12 mm	l _g mm	N	uncoated designation 7021300	VAP designation 70213	TiN designation 7021305
M 1,6	0,35	40	7	-	2,5	2,1	5	2	-M1.6		
M 2	0,4	45	6	9	2,8	2,1	5	2	-M2		-M2
M 2,2	0,45	45	7	12	2,8	2,1	5	2	-M2.2		
M 2,3	0,4	45	7	12	2,8	2,1	5	2	-M2.3		
M 2,5	0,45	50	8	12,5	2,8	2,1	5	2	-M2.5		
M 2,6	0,45	50	8	12,5	2,8	2,1	5	2	-M2.6		
M 3	0,5	56	9	18	3,5	2,7	6	3	-M3	-M3	-M3
M 3,5	0,6	56	11	20	4	3	6	3	-M3.5		
M 4	0,7	63	12	21	4,5	3,4	6	3	-M4	-M4	-M4
M 5	0,8	70	13	25	6	4,9	8	3	-M5	-M5	-M5
M 6	1	80	15	30	6	4,9	8	3	-M6	-M6	-M6
M 7	1	80	15	30	7	5,5	8	3	-M7		
M 8	1,25	90	18	35	8	6,2	9	3	-M8	-M8	-M8
M 10	1,5	100	20	39	10	8	11	3	-M10	-M10	-M10

DIN 376 6HX

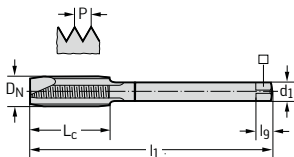

D _N	P mm	l ₁ js16 mm	L _c mm	l ₃ ±1 mm	d ₁ h9 mm	□ h12 mm	l _g mm	N	uncoated designation 7026300	VAP designation 70263
M 12	1,75	110	23	-	9	7	10	3	-M12	-M12
M 14	2	110	25	-	11	9	12	3	-M14	-M14
M 16	2	110	25	-	12	9	12	3	-M16	-M16
M 18	2,5	125	30	-	14	11	14	3	-M18	
M 20	2,5	140	30	-	16	12	15	3	-M20	
M 22	2,5	140	30	-	18	14,5	17	4	-M22	
M 24	3	160	36	-	18	14,5	17	4	-M24	



Machine tap Prototex® Sprint



$\leq 3 \times D_N$

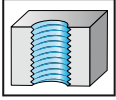

- HSS-E-PM
- chamfer form B = 3.5 - 5 thread
- materials from 350 to 1200 N/mm² or 36 HRC
- for long-chipping materials

M

DIN 13

	P	M	K	N	S	H	O
TiN	●	●	●	●	●	●	●
TiCN	●	●	●	●	●	●	●

DIN 371 ISO2/6H		P	l_1 js16	L_c	l_3 ± 1	d_1 h9	\square h12	l_g	N	TiN designation 7021365	TiCN designation 7021366
D_N	mm	mm	mm	mm	mm	mm	mm	mm			
M 3	0,5	56	9	18	3,5	2,7	6	3	-M3	-M3	
M 4	0,7	63	12	21	4,5	3,4	6	3	-M4	-M4	
M 5	0,8	70	13	25	6	4,9	8	3	-M5	-M5	
M 6	1	80	15	30	6	4,9	8	3	-M6	-M6	
M 8	1,25	90	18	35	8	6,2	9	3	-M8	-M8	
M 10	1,5	100	20	39	10	8	11	3	-M10	-M10	

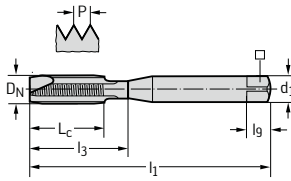

DIN 376 ISO2/6H		P	l_1 js16	L_c	l_3 ± 1	d_1 h9	\square h12	l_g	N	TiN designation 7026365
D_N	mm	mm	mm	mm	mm	mm	mm	mm		
M 12	1,75	110	23	-	9	7	10	3	-M12	
M 14	2	110	25	-	11	9	12	3	-M14	
M 16	2	110	25	-	12	9	12	3	-M16	
M 18	2,5	125	30	-	14	11	14	3	-M18	
M 20	2,5	140	30	-	16	12	15	3	-M20	

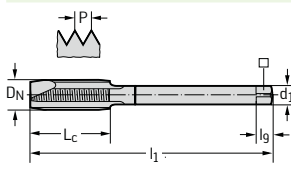

Machine tap Prototex® Megasprint



$\leq 3 \times D_N$

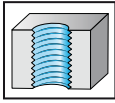

- HSS-E-PM
- chamfer form B = 3.5 - 5 thread
- materials from 350 to 1200 N/mm² or 36 HRC
- for long-chipping materials

M

DIN 13

	P	M	K	N	S	H	O
TiN	●	●	●	●	●	●	●

DIN 371 ISO2/6H

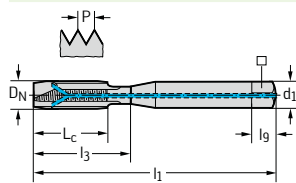

D _N	P mm	l ₁ js16 mm	L _c mm	l ₃ ±1 mm	d ₁ h9 mm	□ h12 mm	l _g mm	N	TiN designation 7021345
M 6	1	80	15	30	6	4,9	8	3	-M6
M 8	1,25	90	18	35	8	6,2	9	3	-M8
M 10	1,5	100	20	39	10	8	11	3	-M10

DIN 376 ISO2/6H

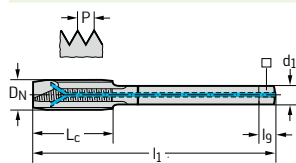

D _N	P mm	l ₁ js16 mm	L _c mm	l ₃ ±1 mm	d ₁ h9 mm	□ h12 mm	l _g mm	N	TiN designation 7026345
M 12	1,75	110	23	-	9	7	10	3	-M12
M 16	2	110	25	-	12	9	12	3	-M16
M 20	2,5	140	30	-	16	12	15	3	-M20

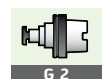

Machine tap Prototex® AL



$\leq 3 \times D_N$

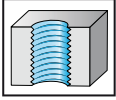

- HSS-E
- chamfer form B = 3.5 - 5 thread
- materials from 200 to 700 N/mm² or 14 HRC
- for long-chipping materials

M

DIN 13

	P	M	K	N	S	H	O
uncoated	●	●	●	●	●	●	●

DIN 371 ISO2/6H		D_N	P mm	l_1 js16 mm	L_c mm	l_3 ± 1 mm	d_1 h9 mm	\square h12 mm	l_g mm	N	uncoated designation 70210
	M 2	0,4	45	6	9	2,8	2,1	5	2	-M2	
	M 2,5	0,45	50	8	12,5	2,8	2,1	5	2	-M2.5	
	M 3	0,5	56	9	18	3,5	2,7	6	2	-M3	
	M 4	0,7	63	12	21	4,5	3,4	6	2	-M4	
	M 5	0,8	70	13	25	6	4,9	8	2	-M5	
	M 6	1	80	15	30	6	4,9	8	3	-M6	
	M 8	1,25	90	18	35	8	6,2	9	3	-M8	
	M 10	1,5	100	20	39	10	8	11	3	-M10	

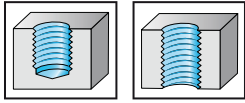

Machine tap Paradur® HC

 $\leq 1,5 \times D_N$

- HSS-E
- chamfer form C = 2 - 3 thread
- materials from 200 to 1000 N/mm² or 32 HRC
- for long and short-chipping materials

M

DIN 13

	P	M	K	N	S	H	O
uncoated			●	●			●

DIN 371	ISO2/6H										uncoated designation 70311
D_N	P mm	l_1 js16 mm	L_c mm	$l_3 \pm 1$ mm	d_1 h9 mm	\square h12 mm	l_g mm	N			
M 1	0,25	40	5	-	2,5	2,1	5	3			-M1
M 1,1	0,25	40	5	-	2,5	2,1	5	3			-M1.1
M 1,2	0,25	40	5	-	2,5	2,1	5	3			-M1.2
M 1,4	0,3	40	6,5	-	2,5	2,1	5	3			-M1.4
M 1,6	0,35	40	7	-	2,5	2,1	5	3			-M1.6
M 1,7	0,35	40	7	-	2,5	2,1	5	3			-M1.7
M 1,8	0,35	40	7	-	2,5	2,1	5	3			-M1.8
M 2	0,4	45	6	9	2,8	2,1	5	3			-M2
M 2,5	0,45	50	8	12,5	2,8	2,1	5	3			-M2.5
M 2,6	0,45	50	8	12,5	2,8	2,1	5	3			-M2.6
M 3	0,5	56	9	18	3,5	2,7	6	3			-M3
M 3,5	0,6	56	11	20	4	3	6	3			-M3.5
M 4	0,7	63	12	21	4,5	3,4	6	3			-M4
M 5	0,8	70	13	25	6	4,9	8	3			-M5
M 6	1	80	15	30	6	4,9	8	3			-M6
M 7	1	80	15	30	7	5,5	8	3			-M7
M 8	1,25	90	18	35	8	6,2	9	3			-M8
M 10	1,5	100	20	39	10	8	11	3			-M10

DIN 376	ISO2/6H										uncoated designation 70361
D_N	P mm	l_1 js16 mm	L_c mm	$l_3 \pm 1$ mm	d_1 h9 mm	\square h12 mm	l_g mm	N			
M 2	0,4	45	6	-	1,4	1,12	4	3			-M2
M 2,5	0,45	50	8	-	1,8	1,4	4	3			-M2.5
M 3	0,5	56	9	-	2,2	1,8	4	3			-M3
M 3,5	0,6	56	11	-	2,5	2,1	5	3			-M3.5
M 4	0,7	63	12	-	2,8	2,1	5	3			-M4
M 5	0,8	70	13	-	3,5	2,7	6	3			-M5
M 6	1	80	15	-	4,5	3,4	6	3			-M6
M 8	1,25	90	18	-	6	4,9	8	3			-M8
M 10	1,5	100	20	-	7	5,5	8	3			-M10
M 12	1,75	110	23	-	9	7	10	3			-M12
M 14	2	110	25	-	11	9	12	3			-M14
M 16	2	110	25	-	12	9	12	3			-M16
M 18	2,5	125	30	-	14	11	14	3			-M18
M 20	2,5	140	30	-	16	12	15	3			-M20
M 22	2,5	140	30	-	18	14,5	17	4			-M22
M 24	3	160	36	-	18	14,5	17	4			-M24
M 27	3	160	36	-	20	16	19	4			-M27
M 30	3,5	180	42	-	22	18	21	4			-M30
M 36	4	200	48	-	28	22	25	4			-M36
M 42	4,5	200	54	-	32	24	27	4			-M42

 $\leq M 14: 5H, \geq M 16: ISO 2/6H$

Machine tap Paradur® N15



$\leq 1,5 \times D_N$

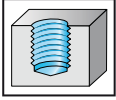

- HSS-E
- chamfer form C = 2 - 3 thread
- 15° helix angle
- materials from 200 to 1000 N/mm² or 32 HRC
- for long-chipping materials

M

DIN 13

	P	M	K	N	S	H	O
uncoated	●	●	●	●	●	●	●

DIN 371 ISO2/6H			l_1 js16 mm	L_c mm	l_3 ± 1 mm	d_1 h9 mm	\square h12 mm	l_g mm	N	uncoated designation 70410
D_N	P mm									
M 2	0,4		45	6	9	2,8	2,1	5	3	-M2
M 2,5	0,45		50	8	12,5	2,8	2,1	5	3	-M2.5
M 3	0,5		56	9	18	3,5	2,7	6	3	-M3
M 3,5	0,6		56	11	20	4	3	6	3	-M3.5
M 4	0,7		63	12	21	4,5	3,4	6	3	-M4
M 5	0,8		70	13	25	6	4,9	8	3	-M5
M 6	1		80	15	30	6	4,9	8	3	-M6
M 8	1,25		90	18	35	8	6,2	9	3	-M8
M 10	1,5		100	20	39	10	8	11	3	-M10

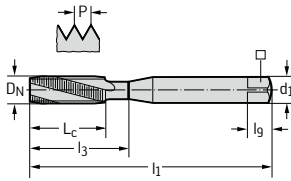

DIN 376 ISO2/6H			l_1 js16 mm	L_c mm	l_3 ± 1 mm	d_1 h9 mm	\square h12 mm	l_g mm	N	uncoated designation 70460
D_N	P mm									
M 8	1,25		90	18	-	6	4,9	8	3	-M8
M 10	1,5		100	20	-	7	5,5	8	3	-M10
M 12	1,75		110	23	-	9	7	10	3	-M12
M 14	2		110	25	-	11	9	12	3	-M14
M 16	2		110	25	-	12	9	12	3	-M16
M 18	2,5		125	30	-	14	11	14	3	-M18
M 20	2,5		140	30	-	16	12	15	3	-M20
M 24	3		160	36	-	18	14,5	17	4	-M24
M 30	3,5		180	42	-	22	18	21	4	-M30

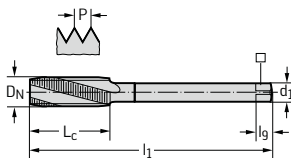

Machine tap
Paradur® Uni



$\leq 3 \times D_N$

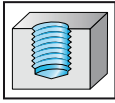

- HSS-E
- chamfer form C = 2 - 3 thread
- 40° helix angle
- materials from 200 to 1000 N/mm² or 32 HRC
- for long-chipping materials

M
DIN 13

	P	M	K	N	S	H	O
uncoated	●●	●	●	●	●	●	●
vap	●●	●	●	●	●	●	●
TiN	●●	●	●	●	●	●	●
TiCN	●●	●	●	●	●	●	●

DIN 371 ISO2/6H

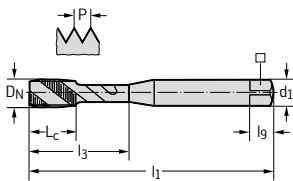

D _N	P mm	l ₁ js16 mm	L _c mm	l ₃ ±1 mm	d ₁ h9 mm	□ h12 mm	l _g mm	N	uncoated designation 7051770	VAP designation 7051773	TIN designation 7051775	TICN designation 7051776
M 2	0,4	45	4	9	2,8	2,1	5	3	-M2			
M 2,3	0,4	45	4	12	2,8	2,1	5	3	-M2.3			
M 2,5	0,45	50	4	12,5	2,8	2,1	5	3	-M2.5			
M 2,6	0,45	50	4	12,5	2,8	2,1	5	3	-M2.6			
M 3	0,5	56	6	18	3,5	2,7	6	3	-M3	-M3	-M3	-M3
M 3,5	0,6	56	6,5	20	4	3	6	3	-M3.5			
M 4	0,7	63	7	21	4,5	3,4	6	3	-M4	-M4	-M4	-M4
M 5	0,8	70	8	25	6	4,9	8	3	-M5	-M5	-M5	-M5
M 6	1	80	10	30	6	4,9	8	3	-M6	-M6	-M6	-M6
M 7	1	80	10	30	7	5,5	8	3	-M7		-M7	
M 8	1,25	90	12	35	8	6,2	9	3	-M8	-M8	-M8	-M8
M 10	1,5	100	15	39	10	8	11	3	-M10	-M10	-M10	-M10

DIN 376 ISO2/6H

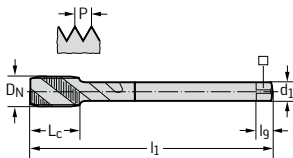

D _N	P mm	l ₁ js16 mm	L _c mm	l ₃ ±1 mm	d ₁ h9 mm	□ h12 mm	l _g mm	N	uncoated designation 7056770	VAP designation 7056773	TIN designation 7056775	TICN designation 7056776
M 3	0,5	56	6	-	2,2	-	-	3	-M3			
M 4	0,7	63	7	-	2,8	2,1	5	3	-M4			
M 5	0,8	70	8	-	3,5	2,7	6	3	-M5			
M 6	1	80	10	-	4,5	3,4	6	3	-M6			
M 8	1,25	90	12	-	6	4,9	8	3	-M8			
M 10	1,5	100	15	-	7	5,5	8	3	-M10			
M 12	1,75	110	16	-	9	7	10	3	-M12	-M12	-M12	-M12
M 14	2	110	20	-	11	9	12	3	-M14	-M14	-M14	-M14
M 16	2	110	20	-	12	9	12	4	-M16	-M16	-M16	-M16
M 18	2,5	125	25	-	14	11	14	4	-M18		-M18	
M 20	2,5	140	25	-	16	12	15	4	-M20		-M20	
M 22	2,5	140	25	-	18	14,5	17	4	-M22			
M 24	3	160	30	-	18	14,5	17	4	-M24			
M 27	3	160	30	-	20	16	19	4	-M27			
M 30	3,5	180	35	-	22	18	21	4	-M30			
M 33	3,5	180	35	-	25	20	23	4	-M33			
M 36	4	200	40	-	28	22	25	4	-M36			



Machine tap Paradur® Uni



$\leq 3 \times D_N$

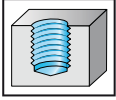

- HSS-E
- chamfer form C = 2 - 3 thread
- 40° helix angle
- materials from 200 to 1000 N/mm² or 32 HRC
- for long-chipping materials

M

DIN 13

	P	M	K	N	S	H	O
uncoated	●●		●	●			

DIN 371 ISO3/6G		P	l_1 js16	L_c	l_3 ± 1	d_1 h9	\square h12	l_g	N	uncoated designation 7053770
D_N	P	mm	mm	mm	mm	mm	mm	mm		
M 2	0,4		45	4	9	2,8	2,1	5	3	-M2
M 3	0,5		56	6	18	3,5	2,7	6	3	-M3
M 4	0,7		63	7	21	4,5	3,4	6	3	-M4
M 5	0,8		70	8	25	6	4,9	8	3	-M5
M 6	1		80	10	30	6	4,9	8	3	-M6
M 8	1,25		90	12	35	8	6,2	9	3	-M8
M 10	1,5		100	15	39	10	8	11	3	-M10

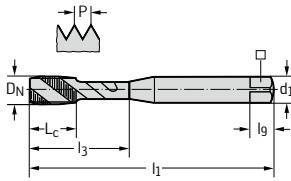

DIN 376 ISO3/6G		P	l_1 js16	L_c	l_3 ± 1	d_1 h9	\square h12	l_g	N	uncoated designation 7058770
D_N	P	mm	mm	mm	mm	mm	mm	mm		
M 12	1,75		110	16	-	9	7	10	3	-M12
M 14	2		110	20	-	11	9	12	3	-M14
M 16	2		110	20	-	12	9	12	4	-M16
M 18	2,5		125	25	-	14	11	14	4	-M18
M 20	2,5		140	25	-	16	12	15	4	-M20

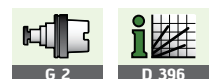
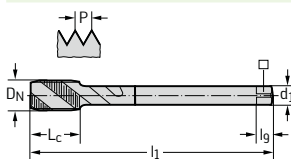

Machine tap Paradur® W40

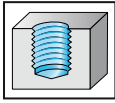
 $\leq 3 \times D_N$

- HSS-E
- chamfer form C = 2 - 3 thread
- 40° helix angle
- materials from 200 to 1000 N/mm² or 32 HRC
- for long-chipping materials

M

DIN 13

	P	M	K	N	S	H	O
uncoated	●	■	●	●	■	■	■

DIN 371 ISO2/6H		D_N	P mm	l_1 js16 mm	L_c mm	l_3 ± 1 mm	d_1 h9 mm	\square h12 mm	l_g mm	N	uncoated designation 705175
	M 3	0,5	56	6	18	3,5	2,7	6	3	-M3	
	M 3,5	0,6	56	6,5	20	4	3	6	3	-M3.5	
	M 4	0,7	63	7	21	4,5	3,4	6	3	-M4	
	M 5	0,8	70	8	25	6	4,9	8	3	-M5	
	M 6	1	80	10	30	6	4,9	8	3	-M6	
	M 8	1,25	90	12	35	8	6,2	9	3	-M8	
	M 10	1,5	100	15	39	10	8	11	3	-M10	

DIN 376 ISO2/6H		D_N	P mm	l_1 js16 mm	L_c mm	l_3 ± 1 mm	d_1 h9 mm	\square h12 mm	l_g mm	N	uncoated designation 705675
	M 3	0,5	56	6	-	2,2	-	-	3	-M3	
	M 4	0,7	63	7	-	2,8	2,1	5	3	-M4	
	M 5	0,8	70	8	-	3,5	2,7	6	3	-M5	
	M 6	1	80	10	-	4,5	3,4	6	3	-M6	
	M 8	1,25	90	12	-	6	4,9	8	3	-M8	
	M 10	1,5	100	15	-	7	5,5	8	3	-M10	
	M 12	1,75	110	16	-	9	7	10	3	-M12	
	M 14	2	110	20	-	11	9	12	3	-M14	
	M 16	2	110	20	-	12	9	12	4	-M16	
	M 18	2,5	125	25	-	14	11	14	4	-M18	
	M 20	2,5	140	25	-	16	12	15	4	-M20	



G 2



D 396

Machine tap Paradur® VA



$\leq 2,5 \times D_N$

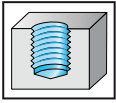

- HSS-E
- chamfer form C = 2 - 3 thread
- 35° helix angle
- materials from 700 to 1200 N/mm² or 36 HRC
- for long-chipping materials

M

DIN 13

	P	M	K	N	S	H	O
uncoated	●	●	●	●			
vap	●	●	●	●			
TiN	●	●	●	●			

DIN 371 6HX		D_N	P mm	l_1 js16 mm	L_c mm	l_3 ± 1 mm	d_1 h9 mm	\square h12 mm	l_g mm	N	uncoated designation 7051300	VAP designation 705130	TIN designation 7051305
		M 1,6	0,35	40	6	-	2,5	2,1	5	3	-M1.6		
		M 2	0,4	45	4	9	2,8	2,1	5	3	-M2		
		M 2,5	0,45	50	4	12,5	2,8	2,1	5	3	-M2.5		
		M 3	0,5	56	6	18	3,5	2,7	6	3	-M3	-M3	-M3
		M 3,5	0,6	56	6,5	20	4	3	6	3	-M3.5		
		M 4	0,7	63	7	21	4,5	3,4	6	3	-M4	-M4	-M4
		M 5	0,8	70	8	25	6	4,9	8	3	-M5	-M5	-M5
		M 6	1	80	10	30	6	4,9	8	3	-M6	-M6	-M6
		M 8	1,25	90	12	35	8	6,2	9	3	-M8	-M8	-M8
		M 10	1,5	100	15	39	10	8	11	3	-M10	-M10	-M10

DIN 376 6HX		D_N	P mm	l_1 js16 mm	L_c mm	l_3 ± 1 mm	d_1 h9 mm	\square h12 mm	l_g mm	N	uncoated designation 7056300	VAP designation 705630
		M 12	1,75	110	16	-	9	7	10	4	-M12	-M12
		M 14	2	110	20	-	11	9	12	4	-M14	-M14
		M 16	2	110	20	-	12	9	12	4	-M16	-M16
		M 18	2,5	125	25	-	14	11	14	4	-M18	
		M 20	2,5	140	25	-	16	12	15	4	-M20	
		M 22	2,5	140	25	-	18	14,5	17	4	-M22	
		M 24	3	160	30	-	18	14,5	17	4	-M24	

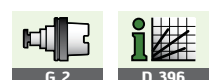

Machine tap Paradur® Sprint

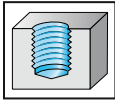

 $\leq 2 \times D_N$

- HSS-E-PM
- chamfer form C = 2 - 3 thread
- 40° helix angle
- materials from 350 to 1200 N/mm² or 36 HRC
- for long-chipping materials

M
DIN 13

	P	M	K	N	S	H	O
TiN	●	●	●	●			
TiCN	●	●	●	●			

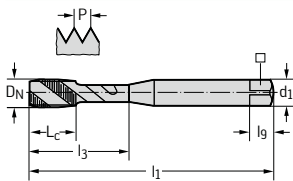
DIN 371 ISO2/6H



D _N	P mm	l ₁ js16 mm	L _c mm	l ₃ ±1 mm	d ₁ h9 mm	□ h12 mm	l _g mm	N	TiN designation 7051365	TiCN designation 7051366
M 3	0,5	56	6	18	3,5	2,7	6	3	-M3	-M3
M 4	0,7	63	7	21	4,5	3,4	6	3	-M4	-M4
M 5	0,8	70	8	25	6	4,9	8	3	-M5	-M5
M 6	1	80	10	30	6	4,9	8	3	-M6	-M6
M 8	1,25	90	12	35	8	6,2	9	3	-M8	-M8
M 10	1,5	100	15	39	10	8	11	3	-M10	-M10

DIN 376 ISO2/6H

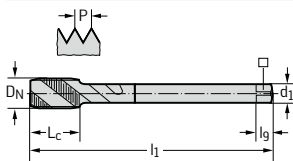

D _N	P mm	l ₁ js16 mm	L _c mm	l ₃ ±1 mm	d ₁ h9 mm	□ h12 mm	l _g mm	N	TiN designation 7056365
M 12	1,75	110	16	-	9	7	10	3	-M12
M 14	2	110	20	-	11	9	12	3	-M14
M 16	2	110	20	-	12	9	12	4	-M16
M 18	2,5	125	25	-	14	11	14	4	-M18
M 20	2,5	140	25	-	16	12	15	4	-M20



Machine tap Paradur® Sprint 50



$\leq 3 \times D_N$

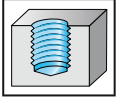

- HSS-E-PM
- chamfer form C = 2 - 3 thread
- 50° helix angle
- materials from 350 to 1200 N/mm² or 36 HRC
- for long-chipping materials

M

DIN 13

	P	M	K	N	S	H	O
vap	●	●	■	■	■	■	■
TAFT	●	●	■	■	■	■	■

DIN 371 6HX		D_N	P mm	l_1 js16 mm	L_c mm	l_3 ± 1 mm	d_1 h9 mm	\square h12 mm	l_g mm	N	VAP designation 7051503	TAFT designation 7051507
	M 2	0,4	45	4	9	2,8	2,1	5	3	-M2		
	M 3	0,5	56	6	18	3,5	2,7	6	3	-M3	-M3	
	M 4	0,7	63	7	21	4,5	3,4	6	3	-M4	-M4	
	M 5	0,8	70	8	25	6	4,9	8	3	-M5	-M5	
	M 6	1	80	10	30	6	4,9	8	3	-M6	-M6	
	M 8	1,25	90	12	35	8	6,2	9	3	-M8	-M8	
	M 10	1,5	100	15	39	10	8	11	3	-M10	-M10	

DIN 376 6HX		D_N	P mm	l_1 js16 mm	L_c mm	l_3 ± 1 mm	d_1 h9 mm	\square h12 mm	l_g mm	N	VAP designation 7056503	TAFT designation 7056507
	M 12	1,75	110	16	-	9	7	10	3	-M12	-M12	
	M 14	2	110	20	-	11	9	12	3	-M14		
	M 16	2	110	20	-	12	9	12	4	-M16	-M16	
	M 18	2,5	125	25	-	14	11	14	4	-M18		
	M 20	2,5	140	25	-	16	12	15	4	-M20	-M20	

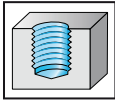

Machine tap Paradur® Megasprint

 $\leq 2,5 \times D_N$

- HSS-E-PM
- chamfer form C = 2 - 3 thread
- 40° helix angle
- materials from 350 to 1200 N/mm² or 36 HRC
- for long-chipping materials

M

DIN 13

	P	M	K	N	S	H	O
TiN	●	●	●	●			

DIN 371 ISO2/6H											TiN designation 7051315
D_N	P mm	l_1 js16 mm	L_c mm	$l_3 \pm 1$ mm	d_1 h9 mm	\square h12 mm	l_g mm	N			
M 6	1	80	10	30	6	4,9	8	3			-M6
M 8	1,25	90	12	35	8	6,2	9	3			-M8
M 10	1,5	100	15	39	10	8	11	3			-M10

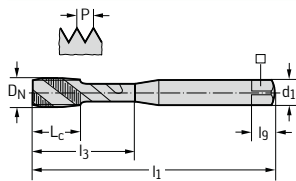

DIN 376 ISO2/6H											TiN designation 7056315
D_N	P mm	l_1 js16 mm	L_c mm	$l_3 \pm 1$ mm	d_1 h9 mm	\square h12 mm	l_g mm	N			
M 12	1,75	110	16	-	9	7	10	3			-M12
M 14	2	110	20	-	11	9	12	3			-M14
M 16	2	110	20	-	12	9	12	4			-M16
M 18	2,5	125	25	-	14	11	14	4			-M18
M 20	2,5	140	25	-	16	12	15	4			-M20

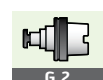
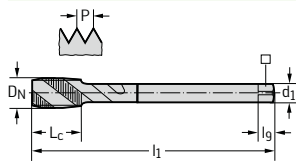

Machine tap Paradur® CI



$\leq 3 \times D_N$

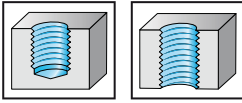

- HSS-E-PM
- chamfer form C = 2 - 3 thread
- materials from 100 to 1000 N/mm² or 32 HRC
- for short-chipping materials

M

DIN 13

	P	M	K	N	S	H	O
nid			●	●			
TAFT			●	●			

DIN 371 6HX		D_N	P mm	l_1 js16 mm	L_c mm	l_3 ± 1 mm	d_1 h9 mm	\square h12 mm	l_g mm	N	NID designation 703146	TAFT designation 7031407
		M 3	0,5	56	9	18	3,5	2,7	6	3	-M3	-M3
		M 3,5	0,6	56	11	20	4	3	6	3	-M3.5	
		M 4	0,7	63	12	21	4,5	3,4	6	3	-M4	-M4
		M 5	0,8	70	13	25	6	4,9	8	3	-M5	-M5
		M 6	1	80	15	30	6	4,9	8	3	-M6	-M6
		M 7	1	80	15	30	7	5,5	8	4	-M7	
		M 8	1,25	90	18	35	8	6,2	9	4	-M8	-M8
		M 10	1,5	100	20	39	10	8	11	4	-M10	-M10

DIN 376 6HX		D_N	P mm	l_1 js16 mm	L_c mm	l_3 ± 1 mm	d_1 h9 mm	\square h12 mm	l_g mm	N	NID designation 70364	TAFT designation 7036407
		M 6	1	80	15	-	4,5	3,4	6	3	-M6	
		M 8	1,25	90	18	-	6	4,9	8	4	-M8	
		M 10	1,5	100	20	-	7	5,5	8	4	-M10	
		M 12	1,75	110	23	-	9	7	10	4	-M12	-M12
		M 14	2	110	25	-	11	9	12	4	-M14	-M14
		M 16	2	110	25	-	12	9	12	4	-M16	-M16
		M 18	2,5	125	30	-	14	11	14	4	-M18	-M18
		M 20	2,5	140	30	-	16	12	15	4	-M20	-M20
		M 24	3	160	36	-	18	14,5	17	5	-M24	
		M 30	3,5	180	42	-	22	18	21	5	-M30	

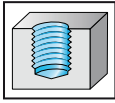

Machine tap Paradur® AL

 $\leq 3 \times D_N$

- HSS-E
- chamfer form C = 2 - 3 thread
- 45° helix angle
- materials from 200 to 700 N/mm² or 14 HRC
- for long-chipping materials

M

DIN 13

	P	M	K	N	S	H	O
uncoated	●	●	●	●	●	●	●

DIN 371 ISO2/6H

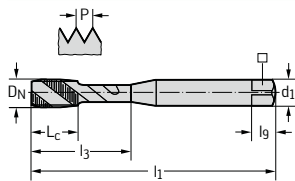

D _N	P mm	l ₁ js16 mm	L _c mm	l ₃ ±1 mm	d ₁ h9 mm	□ h12 mm	l _g mm	N	uncoated designation 705167
M 2	0,4	45	4	9	2,8	2,1	5	2	-M2
M 2,5	0,45	50	4	12,5	2,8	2,1	5	2	-M2.5
M 3	0,5	56	6	18	3,5	2,7	6	2	-M3
M 4	0,7	63	7	21	4,5	3,4	6	2	-M4
M 5	0,8	70	8	25	6	4,9	8	2	-M5
M 6	1	80	10	30	6	4,9	8	2	-M6
M 8	1,25	90	12	35	8	6,2	9	2	-M8
M 10	1,5	100	15	39	10	8	11	2	-M10

DIN 376 ISO2/6H

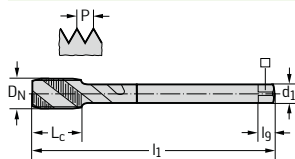

D _N	P mm	l ₁ js16 mm	L _c mm	l ₃ ±1 mm	d ₁ h9 mm	□ h12 mm	l _g mm	N	uncoated designation 70566
M 12	1,75	110	16	-	9	7	10	3	-M12
M 14	2	110	20	-	11	9	12	3	-M14
M 16	2	110	20	-	12	9	12	3	-M16
M 20	2,5	140	25	-	16	12	15	3	-M20

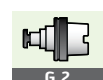

G 2



D 396

Machine tap Prototex® Uni



$\leq 3 \times D_N$

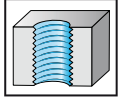

- HSS-E
- chamfer form B = 3.5 - 5 thread
- materials from 200 to 1000 N/mm² or 32 HRC
- for long-chipping materials

MF

DIN 13

	P	M	K	N	S	H	O
uncoated	●●	●	●	●●	●	●	●

DIN 374	ISO2/6H	D_N	P mm	l_1 js16 mm	L_c mm	d_1 h9 mm	\square h12 mm	l_g mm	N	uncoated designation 71360
		M 3	0,35	56	9	2,2	-	-	3	-M3X0.35
		M 3,5	0,35	56	11	2,5	2,1	5	3	-M3.5X0.35
		M 4	0,5	63	12	2,8	2,1	5	3	-M4X0.5
		M 5	0,5	70	13	3,5	2,7	6	3	-M5X0.5
		M 6	0,5	80	15	4,5	3,4	6	3	-M6X0.5
		M 6	0,75	80	15	4,5	3,4	6	3	-M6X0.75
		M 7	0,75	80	15	5,5	4,3	7	3	-M7X0.75
		M 8	0,5	80	15	6	4,9	8	3	-M8X0.5
		M 8	0,75	80	15	6	4,9	8	3	-M8X0.75
		M 8	1	90	18	6	4,9	8	3	-M8X1
		M 9	1	90	18	7	5,5	8	3	-M9X1
		M 10	0,75	90	20	7	5,5	8	3	-M10X0.75
		M 10	1	90	20	7	5,5	8	3	-M10X1
		M 10	1,25	100	20	7	5,5	8	3	-M10X1.25
		M 12	1	100	21	9	7	10	4	-M12X1
		M 12	1,25	100	21	9	7	10	4	-M12X1.25
		M 12	1,5	100	21	9	7	10	4	-M12X1.5
		M 14	1	100	21	11	9	12	4	-M14X1
		M 14	1,25	100	21	11	9	12	4	-M14X1.25
		M 14	1,5	100	21	11	9	12	4	-M14X1.5
		M 15	1	100	21	12	9	12	4	-M15X1
		M 16	1	100	21	12	9	12	4	-M16X1
		M 16	1,5	100	21	12	9	12	4	-M16X1.5
		M 18	1	110	24	14	11	14	4	-M18X1
		M 18	1,5	110	24	14	11	14	4	-M18X1.5
		M 18	2	125	30	14	11	14	4	-M18X2
		M 20	1	125	24	16	12	15	4	-M20X1
		M 20	1,5	125	24	16	12	15	4	-M20X1.5
		M 20	2	140	30	16	12	15	4	-M20X2
		M 22	1	125	24	18	14,5	17	4	-M22X1
		M 22	1,5	125	24	18	14,5	17	4	-M22X1.5
		M 24	1	140	26	18	14,5	17	4	-M24X1
		M 24	1,5	140	26	18	14,5	17	4	-M24X1.5
		M 24	2	140	26	18	14,5	17	4	-M24X2
		M 25	1,5	140	26	18	14,5	17	4	-M25X1.5
		M 26	1,5	140	26	18	14,5	17	4	-M26X1.5
		M 27	1,5	140	26	20	16	19	4	-M27X1.5
		M 27	2	140	26	20	16	19	4	-M27X2
		M 28	1,5	140	26	20	16	19	4	-M28X1.5
		M 30	1	150	26	22	18	21	4	-M30X1
		M 30	1,5	150	26	22	18	21	4	-M30X1.5
		M 30	2	150	26	22	18	21	4	-M30X2
		M 32	1,5	150	26	22	18	21	4	-M32X1.5
		M 33	1,5	160	28	25	20	23	4	-M33X1.5
		M 34	1,5	170	28	28	22	25	4	-M34X1.5
		M 35	1,5	170	28	28	22	25	4	-M35X1.5
		M 36	1,5	170	28	28	22	25	6	-M36X1.5

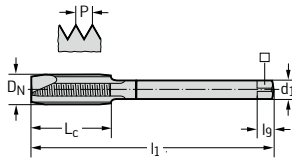

Continued



**Machine tap
Prototex® Uni**



$\leq 3 \times D_N$

Continued

	P	M	K	N	S	H	O
uncoated	●●		●	●●		●	

DIN 374 ISO2/6H		D_N	P mm	l_1 js16 mm	L_c mm	d_1 h9 mm	h_{12} mm	l_g mm	N	uncoated designation 71360
		M 38	1,5	170	28	28	22	25	6	-M38X1.5
		M 40	1,5	170	28	32	24	27	6	-M40X1.5
		M 42	1,5	170	28	32	24	27	6	-M42X1.5
		M 45	1,5	180	28	36	29	32	6	-M45X1.5
		M 48	1,5	190	28	36	29	32	6	-M48X1.5
		M 50	1,5	190	28	36	29	32	6	-M50X1.5



Machine tap Prototex® VA



$\leq 3 \times D_N$

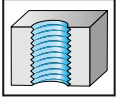

- HSS-E
- chamfer form B = 3.5 - 5 thread
- materials from 700 to 1200 N/mm² or 36 HRC
- for long-chipping materials

MF

DIN 13

	P	M	K	N	S	H	O
uncoated	●●	●●	●●	●			

DIN 374 6HX		D_N	P mm	l_1 js16 mm	L_c mm	d_1 h9 mm	\square h12 mm	l_g mm	N	uncoated designation 7126300
	M 8	1	90	18	6	4,9	8	3	-M8X1	
	M 10	1	90	20	7	5,5	8	3	-M10X1	
	M 10	1,25	100	20	7	5,5	8	3	-M10X1.25	
	M 12	1	100	21	9	7	10	4	-M12X1	
	M 12	1,5	100	21	9	7	10	4	-M12X1.5	
	M 14	1,5	100	21	11	9	12	4	-M14X1.5	
	M 16	1,5	100	21	12	9	12	5	-M16X1.5	
	M 18	1,5	110	24	14	11	14	5	-M18X1.5	
	M 20	1,5	125	24	16	12	15	5	-M20X1.5	
	M 22	1,5	125	24	18	14,5	17	5	-M22X1.5	
M 24	1,5	140	26	18	14,5	17	5	-M24X1.5		
M 24	2	140	26	18	14,5	17	5	-M24X2		

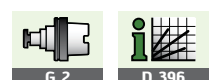

Machine tap Prototex® Sprint



$\leq 3 \times D_N$

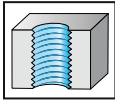

- HSS-E-PM
- chamfer form B = 3.5 - 5 thread
- materials from 350 to 1200 N/mm² or 36 HRC
- for long-chipping materials

MF

DIN 13

	P	M	K	N	S	H	O
TiN	●	●	●	●			

DIN 374	ISO2/6H	D_N	P mm	l_1 js16 mm	L_c mm	d_1 h9 mm	\square h12 mm	l_g mm	N	TiN designation 7126365
		M 8	1	90	18	6	4,9	8	3	-M8X1
		M 10	1	90	20	7	5,5	8	3	-M10X1
		M 12	1,25	100	21	9	7	10	4	-M12X1.25
		M 12	1,5	100	21	9	7	10	4	-M12X1.5
		M 14	1,5	100	21	11	9	12	4	-M14X1.5
		M 16	1,5	100	21	12	9	12	4	-M16X1.5
		M 18	1,5	110	24	14	11	14	4	-M18X1.5
		M 20	1,5	125	24	16	12	15	4	-M20X1.5

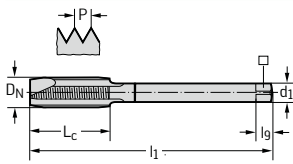

Machine tap Paradur® Uni

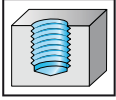
 $\leq 3 \times D_N$

- HSS-E
- chamfer form C = 2 - 3 thread
- 45° helix angle
- materials from 200 to 1000 N/mm² or 32 HRC
- for long-chipping materials

MF

DIN 13

	P	M	K	N	S	H	O
uncoated	●●		●	●			

DIN 374	ISO2/6H	D_N	P mm	l_1 js16 mm	L_c mm	d_1 h9 mm	\square h12 mm	l_g mm	N	uncoated designation 7156770
		M 4	0,5	63	7	2,8	2,1	5	3	-M4X0.5
		M 5	0,5	70	8	3,5	2,7	6	3	-M5X0.5
		M 6	0,5	80	10	4,5	3,4	6	3	-M6X0.5
		M 6	0,75	80	10	4,5	3,4	6	3	-M6X0.75
		M 8	0,75	80	10	6	4,9	8	3	-M8X0.75
		M 8	1	90	12	6	4,9	8	3	-M8X1
		M 10	1	90	12	7	5,5	8	3	-M10X1
		M 10	1,25	100	15	7	5,5	8	3	-M10X1.25
		M 12	1	100	13	9	7	10	4	-M12X1
		M 12	1,25	100	13	9	7	10	4	-M12X1.25
		M 12	1,5	100	13	9	7	10	4	-M12X1.5
		M 14	1,5	100	15	11	9	12	4	-M14X1.5
		M 16	1,5	100	15	12	9	12	5	-M16X1.5
		M 18	1,5	110	17	14	11	14	5	-M18X1.5
		M 20	1,5	125	17	16	12	15	5	-M20X1.5
		M 22	1,5	125	18	18	14,5	17	5	-M22X1.5
		M 24	1,5	140	20	18	14,5	17	5	-M24X1.5
		M 26	1,5	140	20	18	14,5	17	5	-M26X1.5
		M 27	1,5	140	20	20	16	19	5	-M27X1.5
		M 27	2	140	20	20	16	19	5	-M27X2
		M 28	1,5	140	20	20	16	19	5	-M28X1.5
		M 30	1,5	150	20	22	18	21	5	-M30X1.5
		M 30	2	150	20	22	18	21	5	-M30X2



Machine tap Paradur® VA

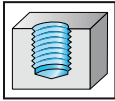

 $\leq 2,5 \times D_N$

- HSS-E
- chamfer form C = 2 - 3 thread
- 35° helix angle
- materials from 700 to 1200 N/mm² or 36 HRC
- for long-chipping materials

MF

DIN 13

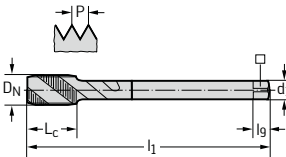
	P	M	K	N	S	H	O
uncoated	●●	●●	●	●			

DIN 374 6HX	D_N	P mm	l_1 js16 mm	L_c mm	d_1 h9 mm	\square h12 mm	l_g mm	N	uncoated designation 7156300
	M 8	1	90	13	6	4,9	8	3	-M8X1
	M 10	1	90	12	7	5,5	8	3	-M10X1
	M 10	1,25	100	15	7	5,5	8	3	-M10X1.25
	M 12	1	100	13	9	7	10	4	-M12X1
	M 12	1,5	100	13	9	7	10	4	-M12X1.5
	M 14	1,5	100	15	11	9	12	4	-M14X1.5
	M 16	1,5	100	15	12	9	12	5	-M16X1.5
	M 18	1,5	110	17	14	11	14	5	-M18X1.5
	M 20	1,5	125	17	16	12	15	5	-M20X1.5
	M 22	1,5	125	18	18	14,5	17	5	-M22X1.5
	M 24	1,5	140	20	18	14,5	17	5	-M24X1.5
	M 27	1,5	140	20	20	16	19	5	-M27X1.5
	M 30	2	150	20	22	18	21	5	-M30X2



G 2



D 396

Machine tap Paradur® Sprint



$\leq 2 \times D_N$

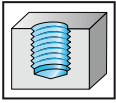

- HSS-E-PM
- chamfer form C = 2 - 3 thread
- 40° helix angle
- materials from 350 to 1200 N/mm² or 36 HRC
- for long-chipping materials

MF

DIN 13

	P	M	K	N	S	H	O
TiN	●	●	●	●			

DIN 374	ISO2/6H	D_N	P mm	l_1 js16 mm	L_c mm	d_1 h9 mm	\square h12 mm	l_g mm	N	TiN designation 7156365
		M 8	1	90	12	6	4,9	8	3	-M8X1
		M 10	1	90	12	7	5,5	8	3	-M10X1
		M 10	1,25	100	15	7	5,5	8	3	-M10X1.25
		M 12	1,5	100	13	9	7	10	4	-M12X1.5
		M 14	1,5	100	15	11	9	12	4	-M14X1.5
		M 16	1,5	100	15	12	9	12	5	-M16X1.5
		M 18	1,5	110	17	14	11	14	5	-M18X1.5
		M 20	1,5	125	17	16	12	15	5	-M20X1.5

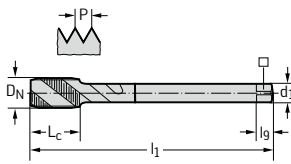

Machine tap Paradur® Sprint 50

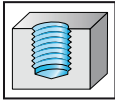
 $\leq 3 \times D_N$

- HSS-E-PM
- chamfer form C = 2 - 3 thread
- 50° helix angle
- materials from 350 to 1200 N/mm² or 36 HRC
- for long-chipping materials

MF

DIN 13

	P	M	K	N	S	H	O
TAFT	●	●	●	●	●	●	●

DIN 374 6HX	D_N	P mm	l_1 js16 mm	L_c mm	d_1 h9 mm	\square h12 mm	l_g mm	N	TAFT designation 7156507
	M 8	1	90	12	6	4,9	8	3	-M8X1
	M 10	1	90	12	7	5,5	8	3	-M10X1
	M 10	1,25	100	15	7	5,5	8	3	-M10X1.25
	M 12	1	100	13	9	7	10	4	-M12X1
	M 12	1,25	100	13	9	7	10	4	-M12X1.25
	M 12	1,5	100	13	9	7	10	4	-M12X1.5
	M 14	1,5	100	15	11	9	12	4	-M14X1.5
	M 16	1,5	100	15	12	9	12	5	-M16X1.5
	M 18	1,5	110	17	14	11	14	5	-M18X1.5
	M 20	1,5	125	17	16	12	15	5	-M20X1.5



G 2



D 396

Machine tap Prototex® Uni



$\leq 3 \times D_N$

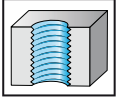

- HSS-E
- chamfer form B = 3.5 - 5 thread
- materials from 200 to 1000 N/mm² or 32 HRC
- for long-chipping materials

G

DIN EN ISO 228

	P	M	K	N	S	H	O
uncoated	●●		●	●●		●	

DIN 5156	D _N Nom	D _N mm	Threads per inch	l ₁ js16 mm	L _c mm	d ₁ h9 mm	□ h12 mm	l _g mm	N	uncoated designation 74360
	G 1/16	7,723	28	90	18	6	4,9	8	3	-G1/16
	G 1/8	9,728	28	90	20	7	5,5	8	3	-G1/8
	G 1/4	13,157	19	100	21	11	9	12	4	-G1/4
	G 3/8	16,662	19	100	21	12	9	12	4	-G3/8
	G 1/2	20,955	14	125	24	16	12	15	4	-G1/2
	G 5/8	22,911	14	125	24	18	14,5	17	4	-G5/8
	G 3/4	26,441	14	140	26	20	16	19	4	-G3/4
	G 7/8	30,201	14	150	26	22	18	21	4	-G7/8
	G 1	33,249	11	160	28	25	20	23	4	-G1
	G 1 1/4	41,91	11	170	28	32	24	27	4	-G1.1/4
	G 1 1/2	47,803	11	190	30	36	29	32	5	-G1.1/2
	G 2	59,614	11	220	34	45	35	-	5	-G2

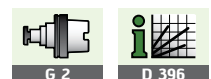

Machine tap Prototex® VA



$\leq 3 \times D_N$

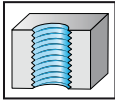

- HSS-E
- chamfer form B = 3.5 - 5 thread
- materials from 700 to 1200 N/mm² or 36 HRC
- for long-chipping materials

G

DIN EN ISO 228

	P	M	K	N	S	H	O
uncoated	●●	●●	●	●	●	●	●

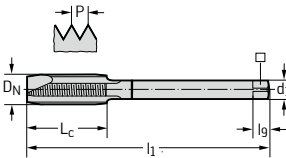
DIN 5156 G-X	D _N Nom	D _N mm	Threads per inch	l ₁ js16 mm	L _c mm	d ₁ h9 mm	□ h12 mm	l _g mm	N	uncoated designation 7426300
	G 1/8	9,728	28	90	20	7	5,5	8	3	-G1/8
	G 1/4	13,157	19	100	21	11	9	12	4	-G1/4
	G 3/8	16,662	19	100	21	12	9	12	5	-G3/8
	G 1/2	20,955	14	125	24	16	12	15	5	-G1/2
	G 3/4	26,441	14	140	26	20	16	19	5	-G3/4
	G 1	33,249	11	160	28	25	20	23	6	-G1

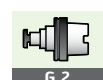

G 2



D 396

Machine tap Paradur® Uni



$\leq 3 \times D_N$

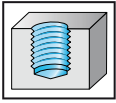

- HSS-E
- chamfer form C = 2 - 3 thread
- 40° helix angle
- materials from 200 to 1000 N/mm² or 32 HRC
- for long-chipping materials

G

DIN EN ISO 228

	P	M	K	N	S	H	O
uncoated	●●		●	●			

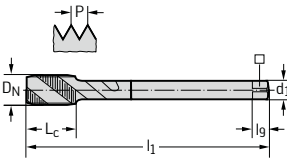
DIN 5156	D _N Nom	D _N mm	Threads per inch	l ₁ js16 mm	L _c mm	d ₁ h9 mm	□ h12 mm	l _g mm	N	uncoated designation 7456770
	G 1/8	9,728	28	90	12	7	5,5	8	3	-G1/8
	G 1/4	13,157	19	100	15	11	9	12	4	-G1/4
	G 3/8	16,662	19	100	15	12	9	12	4	-G3/8
	G 1/2	20,955	14	125	18	16	12	15	4	-G1/2
	G 5/8	22,911	14	125	18	18	14,5	17	5	-G5/8
	G 3/4	26,441	14	140	20	20	16	19	5	-G3/4
	G 1	33,249	11	160	22	25	20	23	5	-G1

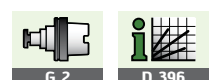

Machine tap Paradur® VA

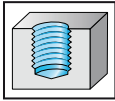
 $\leq 2,5 \times D_N$

- HSS-E
- chamfer form C = 2 - 3 thread
- 35° helix angle
- materials from 700 to 1200 N/mm² or 36 HRC
- for long-chipping materials

G

DIN EN ISO 228

	P	M	K	N	S	H	O
uncoated	●	●	●	●			

DIN 5156 G-X	D _N Nom	D _N mm	Threads per inch	l ₁ js16 mm	L _c mm	d ₁ h9 mm	□ h12 mm	l _g mm	N	uncoated designation 7456300
	G 1/8	9,728	28	90	12	7	5,5	8	3	-G1/8
	G 1/4	13,157	19	100	15	11	9	12	4	-G1/4
	G 3/8	16,662	19	100	15	12	9	12	4	-G3/8
	G 1/2	20,955	14	125	18	16	12	15	4	-G1/2
	G 3/4	26,441	14	140	20	20	16	19	5	-G3/4
	G 1	33,249	11	160	22	25	20	23	5	-G1



G 2



D 396

Machine thread former Protodyn® C



$\leq 3 \times D_N$

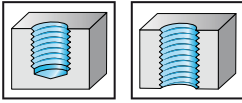

- HSS-E
- chamfer form C = 2 - 3,5 thread
- materials from 200 to 700 N/mm² or 14 HRC
- for long-chipping materials

M

DIN 13

	P	M	K	N	S	H	O
uncoated	●						
nid	●						

DIN 2174 6HX		D_N	P mm	l_1 js16 mm	L_c mm	l_3 ± 1 mm	d_1 h9 mm	\square h12 mm	l_g mm	uncoated designation D7061100	NID designation D70611
		M 1	0,25	40	5,5	-	2,5	2,1	5	-M1	-M1
		M 1,2	0,25	40	5,5	-	2,5	2,1	5	-M1.2	-M1.2
		M 1,4	0,3	40	7	-	2,5	2,1	5	-M1.4	-M1.4
		M 1,6	0,35	40	8	-	2,5	2,1	5	-M1.6	-M1.6
		M 2	0,4	45	6	11	2,8	2,1	5	-M2	-M2
		M 2,3	0,4	45	7	12	2,8	2,1	5	-M2.3	
		M 2,5	0,45	50	8	12,5	2,8	2,1	5	-M2.5	-M2.5
		M 2,6	0,45	50	8	14	2,8	2,1	5	-M2.6	
		M 3	0,5	56	9	18	3,5	2,7	6	-M3	-M3
		M 3,5	0,6	56	11	20	4	3	6	-M3.5	-M3.5
		M 4	0,7	63	12	21	4,5	3,4	6	-M4	-M4
		M 5	0,8	70	13	25	6	4,9	8	-M5	-M5
		M 6	1	80	15	30	6	4,9	8	-M6	-M6
		M 8	1,25	90	18	35	8	6,2	9	-M8	-M8
		M 10	1,5	100	20	39	10	8	11	-M10	-M10

$\leq M 1.4: 5HX, \geq M 1.6: 6HX$

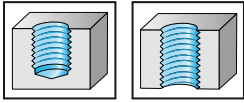

Machine thread former Protodyn® C

 $\leq 3 \times D_N$

- HSS-E
- chamfer form C = 2 - 3.5 thread
- materials from 200 to 1000 N/mm² or 32 HRC
- for long-chipping materials

M

DIN 13

	P	M	K	N	S	H	O
uncoated	●						

DIN 2174 6GX

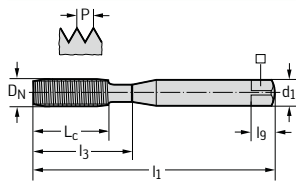

D _N	P mm	l ₁ js16 mm	L _c mm	l ₃ ±1 mm	d ₁ h9 mm	□ h12 mm	l _g mm	uncoated designation D7063100
M 2	0,4	45	6	11	2,8	2,1	5	-M2
M 3	0,5	56	9	18	3,5	2,7	6	-M3
M 4	0,7	63	12	21	4,5	3,4	6	-M4
M 5	0,8	70	13	25	6	4,9	8	-M5
M 6	1	80	15	30	6	4,9	8	-M6
M 8	1,25	90	18	35	8	6,2	9	-M8
M 10	1,5	100	20	39	10	8	11	-M10

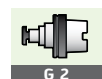

G 2



D 396

Machine thread former Protodyn® SC



$\leq 3,5 \times D_N$

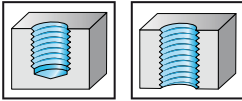

- HSS-E
- chamfer form C = 2 - 3,5 thread
- materials from 200 to 1000 N/mm² or 32 HRC
- for long-chipping materials

M

DIN 13

	P	M	K	N	S	H	O
uncoated	●	●	●	●	●	●	●
nid	●	●	●	●	●	●	●

DIN 2174 6HX		D_N	P mm	l_1 js16 mm	L_c mm	l_3 ± 1 mm	d_1 h9 mm	\square h12 mm	l_g mm	N	uncoated designation D7061700	NID designation D70617
	M 3	0,5	56	9	18	3,5	2,7	6	4	-M3	-M3	
	M 3,5	0,6	56	11	20	4	3	6	4	-M3.5	-M3.5	
	M 4	0,7	63	12	21	4,5	3,4	6	5	-M4	-M4	
	M 5	0,8	70	13	25	6	4,9	8	5	-M5	-M5	
	M 6	1	80	15	30	6	4,9	8	5	-M6	-M6	
	M 7	1	80	15	30	7	5,5	8	5	-M7		
	M 8	1,25	90	18	35	8	6,2	9	5	-M8	-M8	
	M 10	1,5	100	20	39	10	8	11	5	-M10	-M10	

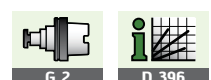

Machine thread former Protodyn® SC



$\leq 3,5 \times D_N$

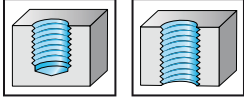

- HSS-E
- chamfer form C = 2 - 3.5 thread
- materials from 200 to 1000 N/mm² or 32 HRC
- for long-chipping materials

M

DIN 13

	P	M	K	N	S	H	O
uncoated	●			●			

DIN 2174 6GX

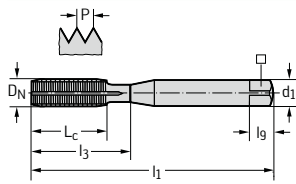

D _N	P mm	l ₁ js16 mm	L _c mm	l ₃ ±1 mm	d ₁ h9 mm	□ h12 mm	l _g mm	N	uncoated designation D7063700
M 3	0,5	56	9	18	3,5	2,7	6	4	-M3
M 4	0,7	63	12	21	4,5	3,4	6	5	-M4
M 5	0,8	70	13	25	6	4,9	8	5	-M5
M 6	1	80	15	30	6	4,9	8	5	-M6
M 8	1,25	90	18	35	8	6,2	9	5	-M8
M 10	1,5	100	20	39	10	8	11	5	-M10

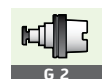

G 2



D 396

Machine thread former Protodyn® SF



$\leq 3,5 \times D_N$

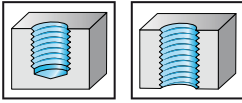

- HSS-E
- chamfer form C = 2 - 3,5 thread
- materials from 200 to 1200 N/mm² or 36 HRC
- for long-chipping materials

M

DIN 13

	P	M	K	N	S	H	O
TiCN	●●	●●	●●	●●	●		

DIN 2174 6HX		D_N	P mm	l_1 js16 mm	L_c mm	l_3 ± 1 mm	d_1 h9 mm	\square h12 mm	l_g mm	N	TiCN designation D7061706
	M 3		0,5	56	9	18	3,5	2,7	6	4	-M3
	M 4		0,7	63	12	21	4,5	3,4	6	5	-M4
	M 5		0,8	70	13	25	6	4,9	8	5	-M5
	M 6		1	80	15	30	6	4,9	8	5	-M6
	M 8		1,25	90	18	35	8	6,2	9	5	-M8
	M 10		1,5	100	20	39	10	8	11	5	-M10

DIN 2174 6HX		D_N	P mm	l_1 js16 mm	L_c mm	l_3 ± 1 mm	d_1 h9 mm	\square h12 mm	l_g mm	N	TiCN designation D7066706
	M 12		1,75	110	23	-	9	7	10	5	-M12
	M 14		2	110	25	-	11	9	12	6	-M14
	M 16		2	110	25	-	12	9	12	6	-M16

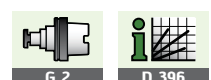

G 2

D 396

Machine thread former Protodyn® SF



$\leq 3,5 \times D_N$

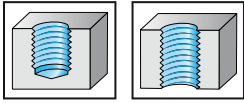

- HSS-E
- chamfer form C = 2 - 3.5 thread
- materials from 200 to 1200 N/mm² or 36 HRC
- for long-chipping materials

MF

DIN 13

	P	M	K	N	S	H	O
TiCN	●●	●●	●	●●	●		

DIN 2174 6HX		D_N	P mm	l_1 js16 mm	L_c mm	d_1 h9 mm	□ h12 mm	l_g mm	TiCN designation D7166706
	M 8		1	90	18	6	4,9	8	-M8X1
	M 10		1	90	20	7	5,5	8	-M10X1
	M 10		1,25	100	20	7	5,5	8	-M10X1.25
	M 12		1	100	21	9	7	10	-M12X1
	M 12		1,5	100	21	9	7	10	-M12X1.5
	M 14		1,5	100	21	11	9	12	-M14X1.5
	M 16		1,5	100	21	12	9	12	-M16X1.5



Machine thread former Protodyn® SF



$\leq 3,5 \times D_N$

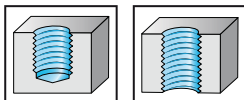

- HSS-E
- chamfer form C = 2 - 3,5 thread
- materials from 200 to 1200 N/mm² or 36 HRC
- for long-chipping materials

G

DIN EN ISO 228

	P	M	K	N	S	H	O
TiCN	●●	●●	●●	●●	●		

DIN 2189 G-X		D_N Nom	D_N mm	Threads per inch	l_1 js16 mm	L_c mm	d_1 h9 mm	\square h12 mm	l_g mm	TiCN designation D7466706
	G 1/8		9,728	28	90	20	7	5,5	8	-G1/8
	G 1/4		13,157	19	100	21	11	9	12	-G1/4
	G 3/8		16,662	19	100	21	12	9	12	-G3/8
	G 1/2		20,955	14	125	24	16	12	15	-G1/2

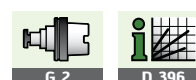

Thread cutting oil Protofluid



- for general applications in
thread cutting and thread forming

P	M	K	N	S	H	O
●●	●●	●●	●			

Litres	Designation SP
0,25	-1/4
0,25 (x 12)	-1/4-12
5	-5

Properties	Dimension	Protofluid
Density at 15 °C	kg/m ³	884
Viscosity at 40 °C	mm ² /s	23,4
Flash point (COC)	°C	195
Pour point	°C	-15

Cutting oil Hangsterfer's Hardcut



- for difficult-to-cut steel, titanium and
nickel alloys and special materials

P	M	K	N	S	H	O
				●●	●●	

Litres	Designation SH
0,25	-1/4
1	-1
5	-5

Properties	Dimension	Hangsterfer's Hardcut
Density at 15 °C	kg/m ³	1065
Viscosity at 40 °C	mm ² /s	21
Flash point (COC)	°C	196
Pour point	°C	-4



Walter Select – Thread forming

Blind and through hole machining

Solid carbide and HSS-E

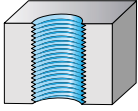
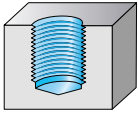

BH = Blind hole
TH = Through hole

i = only for synchronous machining

Thread depth	2,0 x D _N	3,0 x D _N	
Type	Protodyn® Eco LM	Protodyn®	
Cutting tool material	HSS-E	Solid carbide	
	Page	Page	
M	D 339	D 349	
MJ			
MF		D 358	
UNC	UNJC		
UNF	UNJF		
UNEF			
G			
RC	RP		
NPT	NPSM		
NPTF			
Pg	BSW		
TR			
EG M	EG MF		
EG UNC			
EG UNF			
Coating	CRN	TiCN	
Application	BH/TH	BH/TH	

Material group	Classification of the main material groups and code letters		Birmell hardness HB	Tensile strength R _m N/mm ²	Machining group			
	Workpiece material							
P	Unalloyed and low-alloyed steel	annealed (tempered)	210	700	P1, P2, P3, P4, P7	●●	●●	
		Free cutting steel	220	750	P6	●●	●●	
		tempered	300	1010	P5, P8		●●	
		tempered	380	1280	P9		●	
		tempered	430	1480	P10			
P	High-alloyed steel and high-alloyed tool steel	annealed	200	670	P11		●●	
		hardened and tempered	300	1010	P12		●●	
		hardened and tempered	400	1360	P13			
P	Stainless steel	ferritic / martensitic, annealed	200	670	P14			
		martensitic, tempered	330	1110	P15			
M	Stainless steel	austenitic, duplex	230	780	M1, M3			
		austenitic, precipitation hardened (PH)	300	1010	M2			
K	Grey cast iron		245	–	K3, K4			
	Cast iron with spheroidal graphite	ferritic, pearlitic	365	–	K1, K2, K5, K6			
	GGV (CGI)		200	–	K7			
N	Aluminium wrought alloys	cannot be hardened	30	–	N1	●●	●●	
		hardenable, hardened	100	340	N2	●●	●●	
	Cast aluminium alloys	≤ 12 % Si	90	310	N3, N4	●●	●●	
		> 12 % Si	130	450	N5			
	Magnesium alloys		70	250	N6			
	Copper and copper alloys (bronze / brass)	unalloyed, electrolytic copper	100	340	N7	●●	●	
		Brass, bronze, red brass	90	310	N8			
Cu-alloys, short-chipping		110	380	N9				
	high-strength, Ampco	300	1010	N10				
S	Heat-resistant alloys	Fe-based	280	940	S1, S2			
		Ni-based or Co-based	250	840	S3		●●	
		Ni-based or Co-based	350	1080	S4, S5			
	Titanium alloys	Pure titanium	200	670	S6	●●		
		α and β alloys, hardened	375	1260	S7	●●		
	β alloys	410	1400	S8	●●			
Tungsten alloys		300	1010	S9				
Molybdenum alloys		300	1010	S10				
H	Hardened steel		50 HRC	–	H1			
			55 HRC	–	H2, H4			
			60 HRC	–	H3			
O	Thermoplasts	without abrasive fillers			O1			
	Thermosetting plastics	without abrasive fillers			O2			
	Fibre-reinforced plastic	GFRP, AFRP			O3, O5			
		CFRP			O4			
Graphite (technical)			65	O6				

Machine thread former Protodyn® Eco Plus

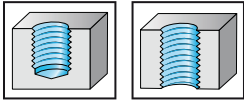

 $\leq 3 \times D_N$

- HSS-E
- chamfer form C = 2 - 3.5 thread
- materials from 200 to 1200 N/mm² or 36 HRC
- for long-chipping materials
- suitable for minimum quantity lubrication

M
DIN 13

	P	M	K	N	S	H	O
TiN	●	●	●	●	●		
TiCN	●	●	●	●	●		

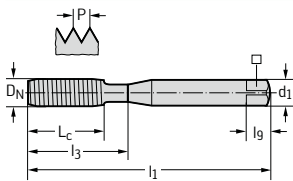
DIN 2174 6HX



D _N	P mm	l ₁ js16 mm	L _c mm	l ₃ ±1 mm	d ₁ h9 mm	□ h12 mm	l _g mm	TiN designation EP2061105	TiCN designation EP2061106
M 2	0,4	45	6	11	2,8	2,1	5	-M2	-M2
M 2,5	0,45	50	8	14	2,8	2,1	5	-M2.5	-M2.5
M 3	0,5	56	9	18	3,5	2,7	6	-M3	-M3
M 3,5	0,6	56	11	20	4	3	6	-M3.5	-M3.5
M 4	0,7	63	12	21	4,5	3,4	6	-M4	-M4
M 5	0,8	70	13	25	6	4,9	8	-M5	-M5
M 6	1	80	15	30	6	4,9	8	-M6	-M6
M 8	1,25	90	18	35	8	6,2	9	-M8	-M8
M 10	1,5	100	20	39	10	8	11	-M10	-M10

DIN 2174 6HX

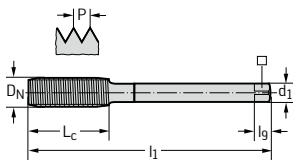

D _N	P mm	l ₁ js16 mm	L _c mm	l ₃ ±1 mm	d ₁ h9 mm	□ h12 mm	l _g mm	TiN designation EP2066105	TiCN designation EP2066106
M 12	1,75	110	23	-	9	7	10	-M12	-M12
M 14	2	110	25	-	11	9	12	-M14	-M14
M 16	2	110	25	-	12	9	12	-M16	-M16
M 20	2,5	140	30	-	16	12	15	-M20	-M20

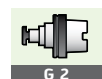

Machine thread former Protodyn® Eco Plus



$\leq 3 \times D_N$

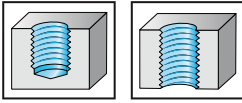

- HSS-E
- chamfer form C = 2 - 3.5 thread
- materials from 200 to 1200 N/mm² or 36 HRC
- for long-chipping materials
- suitable for minimum quantity lubrication
- with a lubrication groove

M

DIN 13

	P	M	K	N	S	H	O
TiN	●	●	●	●	●		
TiCN	●	●	●	●	●		

DIN 2174 6HX		D_N	P mm	l_1 js16 mm	L_c mm	l_3 ± 1 mm	d_1 h9 mm	\square h12 mm	l_g mm	TiN designation EP2061115	TiCN designation EP2061116
		M 5	0,8	70	13	25	6	4,9	8	-M5	-M5
		M 6	1	80	15	30	6	4,9	8	-M6	-M6
		M 8	1,25	90	18	35	8	6,2	9	-M8	-M8
		M 10	1,5	100	20	39	10	8	11	-M10	-M10

DIN 2174 6HX		D_N	P mm	l_1 js16 mm	L_c mm	l_3 ± 1 mm	d_1 h9 mm	\square h12 mm	l_g mm	TiN designation EP2066115	TiCN designation EP2066116
		M 12	1,75	110	23	-	9	7	10	-M12	-M12
		M 14	2	110	25	-	11	9	12	-M14	-M14
		M 16	2	110	25	-	12	9	12	-M16	-M16

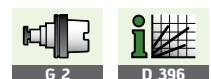

Machine thread former Protodyn® Eco Plus

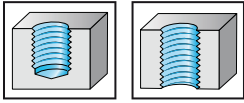

 $\leq 3 \times D_N$

- HSS-E
- chamfer form C = 2 - 3.5 thread
- materials from 200 to 1200 N/mm² or 36 HRC
- for long-chipping materials
- suitable for minimum quantity lubrication

M
DIN 13

	P	M	K	N	S	H	O
TiN	●	●	●	●	●		
TiCN	●	●	●	●	●		

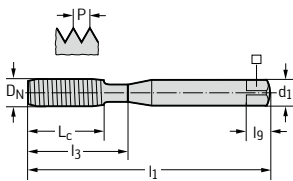
DIN 2174 6GX



D _N	P mm	l ₁ js16 mm	L _c mm	l ₃ ±1 mm	d ₁ h9 mm	□ h12 mm	l _g mm	TiN designation EP2063105	TiCN designation EP2063106
M 2	0,4	45	6	11	2,8	2,1	5	-M2	-M2
M 2,5	0,45	50	8	14	2,8	2,1	5	-M2.5	-M2.5
M 3	0,5	56	9	18	3,5	2,7	6	-M3	-M3
M 3,5	0,6	56	11	20	4	3	6	-M3.5	-M3.5
M 4	0,7	63	12	21	4,5	3,4	6	-M4	-M4
M 5	0,8	70	13	25	6	4,9	8	-M5	-M5
M 6	1	80	15	30	6	4,9	8	-M6	-M6
M 8	1,25	90	18	35	8	6,2	9	-M8	-M8
M 10	1,5	100	20	39	10	8	11	-M10	-M10

DIN 2174 6GX

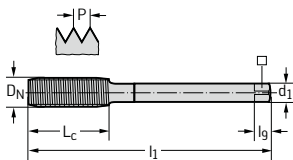

D _N	P mm	l ₁ js16 mm	L _c mm	l ₃ ±1 mm	d ₁ h9 mm	□ h12 mm	l _g mm	TiN designation EP2068105	TiCN designation EP2068106
M 12	1,75	110	23	-	9	7	10	-M12	-M12
M 14	2	110	25	-	11	9	12	-M14	-M14
M 16	2	110	25	-	12	9	12	-M16	-M16

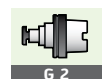

Machine thread former Protodyn® S Eco Plus



$\leq 3,5 \times D_N$

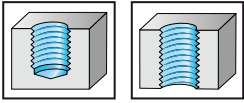

- HSS-E
- chamfer form C = 2 - 3.5 thread
- materials from 200 to 1200 N/mm² or 36 HRC
- for long-chipping materials
- suitable for minimum quantity lubrication

M

DIN 13

	P	M	K	N	S	H	O
TiN	●	●	●	●	●		
TiCN	●	●	●	●	●		

DIN 2174 6HX		D_N	P mm	l_1 js16 mm	L_c mm	l_3 ± 1 mm	d_1 h9 mm	\square h12 mm	l_g mm	TiN designation EP2061705	TiCN designation EP2061706
	M 2		0,4	45	6	11	2,8	2,1	5	-M2	-M2
	M 2,5		0,45	50	8	14	2,8	2,1	5	-M2.5	-M2.5
	M 3		0,5	56	9	18	3,5	2,7	6	-M3	-M3
	M 3,5		0,6	56	11	20	4	3	6	-M3.5	-M3.5
	M 4		0,7	63	12	21	4,5	3,4	6	-M4	-M4
	M 5		0,8	70	13	25	6	4,9	8	-M5	-M5
	M 6		1	80	15	30	6	4,9	8	-M6	-M6
	M 8		1,25	90	18	35	8	6,2	9	-M8	-M8
	M 10		1,5	100	20	39	10	8	11	-M10	-M10

DIN 2174 6HX		D_N	P mm	l_1 js16 mm	L_c mm	l_3 ± 1 mm	d_1 h9 mm	\square h12 mm	l_g mm	TiN designation EP2066705	TiCN designation EP2066706
	M 12		1,75	110	23	-	9	7	10	-M12	-M12
	M 14		2	110	25	-	11	9	12	-M14	-M14
	M 16		2	110	25	-	12	9	12	-M16	-M16
	M 20		2,5	140	30	-	16	12	15	-M20	-M20

Machine thread former Protodyn® S Eco Plus



$\leq 3 \times D_N$

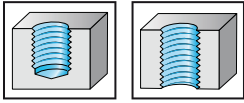

- HSS-E
- chamfer form E = 1.5 - 2 thread
- materials from 200 to 1200 N/mm² or 36 HRC
- for long-chipping materials

M
DIN 13

	P	M	K	N	S	H	O
TiN	●●	●	●	●●	●		
TiCN	●●	●	●	●●	●		

DIN 2174 6HX

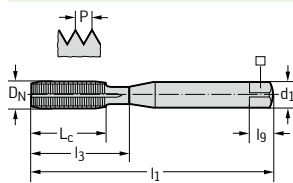

D _N	P mm	l ₁ js16 mm	L _c mm	l ₃ ±1 mm	d ₁ h9 mm	□ h12 mm	l _g mm	TiN designation EP2061805	TiCN designation EP2061806
M 2	0,4	45	6	11	2,8	2,1	5	-M2	-M2
M 2,5	0,45	50	8	14	2,8	2,1	5	-M2.5	-M2.5
M 3	0,5	56	9	18	3,5	2,7	6	-M3	-M3
M 3,5	0,6	56	11	20	4	3	6	-M3.5	-M3.5
M 4	0,7	63	12	21	4,5	3,4	6	-M4	-M4
M 5	0,8	70	13	25	6	4,9	8	-M5	-M5
M 6	1	80	15	30	6	4,9	8	-M6	-M6
M 8	1,25	90	18	35	8	6,2	9	-M8	-M8
M 10	1,5	100	20	39	10	8	11	-M10	-M10

DIN 2174 6HX

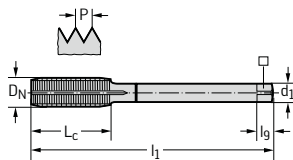

D _N	P mm	l ₁ js16 mm	L _c mm	l ₃ ±1 mm	d ₁ h9 mm	□ h12 mm	l _g mm	TiN designation EP2066805	TiCN designation EP2066806
M 12	1,75	110	23	-	9	7	10	-M12	-M12
M 14	2	110	25	-	11	9	12	-M14	-M14
M 16	2	110	25	-	12	9	12	-M16	-M16



G 2



D 396

Machine thread former Protodyn® S Eco Plus



$\leq 3,5 \times D_N$

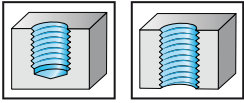

- HSS-E
- chamfer form C = 2 - 3.5 thread
- materials from 200 to 1200 N/mm² or 36 HRC
- for long-chipping materials
- suitable for minimum quantity lubrication

M

DIN 13

	P	M	K	N	S	H	O
TiN	●	●	●	●	●		
TiCN	●	●	●	●	●		

DIN 2174 6GX		D_N	P mm	l_1 js16 mm	L_c mm	l_3 ± 1 mm	d_1 h9 mm	\square h12 mm	l_g mm	TiN designation EP2063705	TiCN designation EP2063706
	M 2		0,4	45	6	11	2,8	2,1	5	-M2	-M2
	M 2,5		0,45	50	8	14	2,8	2,1	5	-M2.5	-M2.5
	M 3		0,5	56	9	18	3,5	2,7	6	-M3	-M3
	M 3,5		0,6	56	11	20	4	3	6	-M3.5	-M3.5
	M 4		0,7	63	12	21	4,5	3,4	6	-M4	-M4
	M 5		0,8	70	13	25	6	4,9	8	-M5	-M5
	M 6		1	80	15	30	6	4,9	8	-M6	-M6
	M 8		1,25	90	18	35	8	6,2	9	-M8	-M8
	M 10		1,5	100	20	39	10	8	11	-M10	-M10

DIN 2174 6GX		D_N	P mm	l_1 js16 mm	L_c mm	l_3 ± 1 mm	d_1 h9 mm	\square h12 mm	l_g mm	TiN designation EP2068705	TiCN designation EP2068706
	M 12		1,75	110	23	-	9	7	10	-M12	-M12
	M 14		2	110	25	-	11	9	12	-M14	-M14
	M 16		2	110	25	-	12	9	12	-M16	-M16

Machine thread former Protodyn® S Eco Plus

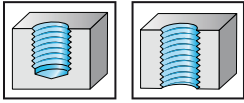

 $\leq 3 \times D_N$

- HSS-E
- chamfer form E = 1.5 - 2 thread
- materials from 200 to 1200 N/mm² or 36 HRC
- for long-chipping materials

M
DIN 13

	P	M	K	N	S	H	O
TiN	●	●	●	●	●		
TiCN	●	●	●	●	●		

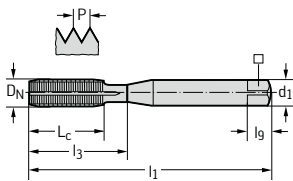
DIN 2174 6GX



D _N	P mm	l ₁ js16 mm	L _c mm	l ₃ ±1 mm	d ₁ h9 mm	□ h12 mm	l _g mm	TiN designation EP2063805	TiCN designation EP2063806
M 2	0,4	45	6	11	2,8	2,1	5	-M2	-M2
M 2,5	0,45	50	8	14	2,8	2,1	5	-M2.5	-M2.5
M 3	0,5	56	9	18	3,5	2,7	6	-M3	-M3
M 3,5	0,6	56	11	20	4	3	6	-M3.5	-M3.5
M 4	0,7	63	12	21	4,5	3,4	6	-M4	-M4
M 5	0,8	70	13	25	6	4,9	8	-M5	-M5
M 6	1	80	15	30	6	4,9	8	-M6	-M6
M 8	1,25	90	18	35	8	6,2	9	-M8	-M8
M 10	1,5	100	20	39	10	8	11	-M10	-M10

DIN 2174 6GX

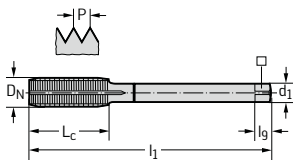

D _N	P mm	l ₁ js16 mm	L _c mm	l ₃ ±1 mm	d ₁ h9 mm	□ h12 mm	l _g mm	TiN designation EP2068805	TiCN designation EP2068806
M 12	1,75	110	23	-	9	7	10	-M12	-M12
M 14	2	110	25	-	11	9	12	-M14	-M14
M 16	2	110	25	-	12	9	12	-M16	-M16

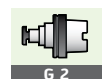

Machine thread former Protodyn® S Eco Plus



$\leq 4 \times D_N$

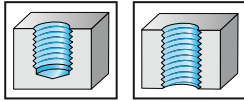

- HSS-E
- chamfer form C = 2 - 3,5 thread
- materials from 200 to 1200 N/mm² or 36 HRC
- for long-chipping materials

M

DIN 13

	P	M	K	N	S	H	O
TiN	●	●	●	●	●		
TiCN	●	●	●	●	●		

DIN 2174 6HX		D_N	P mm	l_1 js16 mm	L_c mm	l_3 ± 1 mm	d_1 h9 mm	\square h12 mm	l_g mm	TiN designation EP2061745	TiCN designation EP2061746
		M 5	0,8	70	13	25	6	4,9	8	-M5	-M5
		M 6	1	80	15	30	6	4,9	8	-M6	-M6
		M 8	1,25	90	18	35	8	6,2	9	-M8	-M8
		M 10	1,5	100	20	39	10	8	11	-M10	-M10

DIN 2174 6HX		D_N	P mm	l_1 js16 mm	L_c mm	l_3 ± 1 mm	d_1 h9 mm	\square h12 mm	l_g mm	TiN designation EP2066745	TiCN designation EP2066746
		M 12	1,75	110	23	-	9	7	10	-M12	-M12
		M 14	2	110	25	-	11	9	12	-M14	-M14
		M 16	2	110	25	-	12	9	12	-M16	-M16
		M 20	2,5	140	30	-	16	12	15	-M20	-M20

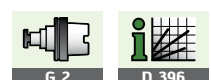

Machine thread former Protodyn® S Eco Inox



$\leq 3,5 \times D_N$

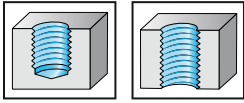

- HSS-E
- chamfer form C = 2 - 3.5 thread
- materials from 200 to 1000 N/mm² or 32 HRC
- for long-chipping materials
- for stainless steels when using emulsion

M

DIN 13

	P	M	K	N	S	H	O
TiN	●●	●●	●	●●	●		

DIN 2174 6HX		D_N	P mm	l_1 js16 mm	L_c mm	l_3 ± 1 mm	d_1 h9 mm	\square h12 mm	l_g mm	TiN designation E2061305
	M 2		0,4	45	6	-	2,8	2,1	5	-M2 ¹
	M 2,5		0,45	50	8	-	2,8	2,1	5	-M2.5 ¹
	M 3		0,5	56	9	18	3,5	2,7	6	-M3
	M 4		0,7	63	12	21	4,5	3,4	6	-M4
	M 5		0,8	70	13	25	6	4,9	8	-M5
	M 6		1	80	15	30	6	4,9	8	-M6
	M 8		1,25	90	18	35	8	6,2	9	-M8
	M 10		1,5	100	20	39	10	8	11	-M10

¹without neck

DIN 2174 6HX		D_N	P mm	l_1 js16 mm	L_c mm	l_3 ± 1 mm	d_1 h9 mm	\square h12 mm	l_g mm	TiN designation E2066305
	M 12		1,75	110	23	-	9	7	10	-M12



G 2

D 396

Machine thread former Protodyn® Eco LM



$\leq 2 \times D_N$

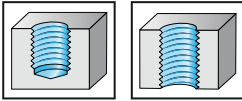

- HSS-E
- chamfer form C = 2 - 3,5 thread
- materials from 200 to 700 N/mm² or 14 HRC
- for long-chipping materials
- suitable for minimum quantity lubrication
- for soft antifriction materials

M

DIN 13

	P	M	K	N	S	H	O
CRN	●			●●	●●		

DIN 2174 6HX		D_N	P mm	l_1 js16 mm	L_c mm	l_3 ± 1 mm	d_1 h9 mm	\square h12 mm	l_g mm	CRN designation E2061604
	M 2		0,4	45	6	11	2,8	2,1	5	-M2
	M 2,5		0,45	50	8	14	2,8	2,1	5	-M2.5
	M 3		0,5	56	9	18	3,5	2,7	6	-M3
	M 4		0,7	63	12	21	4,5	3,4	6	-M4
	M 5		0,8	70	13	25	6	4,9	8	-M5
	M 6		1	80	15	30	6	4,9	8	-M6
	M 8		1,25	90	18	35	8	6,2	9	-M8
	M 10		1,5	100	20	39	10	8	11	-M10

DIN 2174 6HX		D_N	P mm	l_1 js16 mm	L_c mm	l_3 ± 1 mm	d_1 h9 mm	\square h12 mm	l_g mm	CRN designation E2066604
	M 12		1,75	110	23	-	9	7	10	-M12



Machine thread former Protodyn® S Synchrospeed



$\leq 3,5 \times D_N$

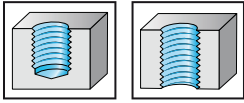

- HSS-E
- chamfer form C = 2 - 3.5 thread
- materials to 1200 N/mm² or 36 HRC
- for long-chipping materials
- only for synchronous machining (rigid tapping)
- suitable for minimum quantity lubrication

M
DIN 13

	P	M	K	N	S	H	O
TiN	●	●	●	●	●		
TiCN	●	●	●	●	●		

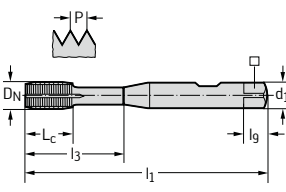
~DIN 2174 6HX		D_N	P mm	l_1 js16 mm	L_c mm	l_3 ± 1 mm	d_1 h6 mm	\square h12 mm	l_g mm	TiN designation S2061305	TiCN designation S2061306
Shank DIN 1835 B		M 3	0,5	70	3	18	6	4,9	8	-M3	-M3
		M 4	0,7	70	4,2	21	6	4,9	8	-M4	-M4
		M 5	0,8	70	4,8	25	6	4,9	8	-M5	-M5
		M 6	1	80	6	30	6	4,9	8	-M6	-M6
		M 8	1,25	90	7,5	35	8	6,2	9	-M8	-M8
		M 10	1,5	100	9	39	10	8	11	-M10	-M10

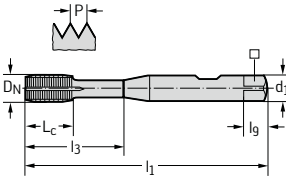
~DIN 2174 6HX		D_N	P mm	l_1 js16 mm	L_c mm	l_3 ± 1 mm	d_1 h6 mm	\square h12 mm	l_g mm	TiN designation S2066305	TiCN designation S2066306
Shank DIN 1835 B		M 12	1,75	110	10,5	42	12	9	12	-M12	-M12
											



Machine thread former Protodyn® S Synchrospeed



$\leq 4 \times D_N$

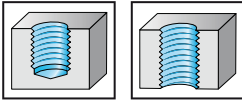

- HSS-E
- chamfer form C = 2 - 3,5 thread
- materials to 1200 N/mm² or 36 HRC
- for long-chipping materials
- only for synchronous machining (rigid tapping)
- suitable for minimum quantity lubrication

M

DIN 13

	P	M	K	N	S	H	O
TiN	●●	●●	●●	●●	●		

~DIN 2174 6HX		D_N	P mm	l_1 js16 mm	L_c mm	l_3 ± 1 mm	d_1 h6 mm	\square h12 mm	l_g mm	TiN designation S2061345
Shank DIN 1835 B		M 4	0,7	70	4,2	21	6	4,9	8	-M4
		M 5	0,8	70	4,8	25	6	4,9	8	-M5
		M 6	1	80	6	30	6	4,9	8	-M6
		M 8	1,25	90	7,5	35	8	6,2	9	-M8
		M 10	1,5	100	9	39	10	8	11	-M10

~DIN 2174 6HX		D_N	P mm	l_1 js16 mm	L_c mm	l_3 ± 1 mm	d_1 h6 mm	\square h12 mm	l_g mm	TiN designation S2066345
Shank DIN 1835 B		M 12	1,75	110	10,5	42	12	9	12	-M12

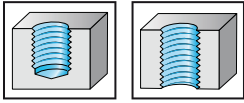

Machine thread former Protodyn® Plus

 $\leq 3 \times D_N$

- HSS-E
- chamfer form C = 2 - 3.5 thread
- materials from 200 to 1200 N/mm² or 36 HRC
- for long-chipping materials

M

DIN 13

	P	M	K	N	S	H	O
TiN	●●	●	●	●●	●		

DIN 2174 6HX

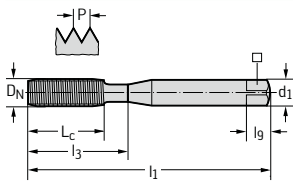

D _N	P mm	l ₁ js16 mm	L _c mm	l ₃ ±1 mm	d ₁ h9 mm	□ h12 mm	l _g mm	TiN designation DP2061105
M 1	0,25	40	5,5	-	2,5	2,1	5	-M1
M 1,1	0,25	40	5,5	-	2,5	2,1	5	-M1.1
M 1,2	0,25	40	5,5	-	2,5	2,1	5	-M1.2
M 1,4	0,3	40	7	-	2,5	2,1	5	-M1.4
M 1,6	0,35	40	8	-	2,5	2,1	5	-M1.6
M 1,7	0,35	40	8	-	2,5	2,1	5	-M1.7
M 1,8	0,35	40	8	-	2,5	2,1	5	-M1.8
M 2	0,4	45	6	11	2,8	2,1	5	-M2
M 2,2	0,45	45	7	12	2,8	2,1	5	-M2.2
M 2,3	0,4	45	7	12	2,8	2,1	5	-M2.3
M 2,5	0,45	50	8	14	2,8	2,1	5	-M2.5
M 2,6	0,45	50	8	14	2,8	2,1	5	-M2.6
M 3	0,5	56	9	18	3,5	2,7	6	-M3
M 3,5	0,6	56	11	20	4	3	6	-M3.5
M 4	0,7	63	12	21	4,5	3,4	6	-M4
M 5	0,8	70	13	25	6	4,9	8	-M5
M 6	1	80	15	30	6	4,9	8	-M6
M 7	1	80	15	30	7	5,5	8	-M7
M 8	1,25	90	18	35	8	6,2	9	-M8
M 10	1,5	100	20	39	10	8	11	-M10

DIN 2174 6HX

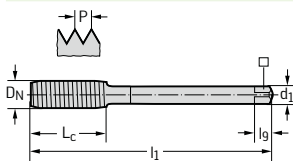

D _N	P mm	l ₁ js16 mm	L _c mm	l ₃ ±1 mm	d ₁ h9 mm	□ h12 mm	l _g mm	TiN designation DP2066105
M 12	1,75	110	23	-	9	7	10	-M12
M 14	2	110	25	-	11	9	12	-M14
M 16	2	110	25	-	12	9	12	-M16
M 18	2,5	125	30	-	14	11	14	-M18
M 20	2,5	140	30	-	16	12	15	-M20
M 24	3	160	36	-	18	14,5	17	-M24

 $\leq M 1.4: 5HX, \geq M 1.6: 6HX$

Machine thread former Protodyn® Plus



$\leq 3 \times D_N$

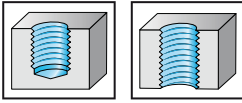

- HSS-E
- chamfer form C = 2 - 3,5 thread
- materials from 200 to 1200 N/mm² or 36 HRC
- for long-chipping materials

M

DIN 13

	P	M	K	N	S	H	O
TiN	●●	●	●	●●	●		

DIN 2174 6GX		D_N	P mm	l_1 js16 mm	L_c mm	l_3 ± 1 mm	d_1 h9 mm	\square h12 mm	l_g mm	TiN designation DP2063105
	M 2		0,4	45	6	11	2,8	2,1	5	-M2
	M 2,5		0,45	50	8	14	2,8	2,1	5	-M2.5
	M 3		0,5	56	9	18	3,5	2,7	6	-M3
	M 3,5		0,6	56	11	20	4	3	6	-M3.5
	M 4		0,7	63	12	21	4,5	3,4	6	-M4
	M 5		0,8	70	13	25	6	4,9	8	-M5
	M 6		1	80	15	30	6	4,9	8	-M6
	M 8		1,25	90	18	35	8	6,2	9	-M8
	M 10		1,5	100	20	39	10	8	11	-M10

DIN 2174 6GX		D_N	P mm	l_1 js16 mm	L_c mm	l_3 ± 1 mm	d_1 h9 mm	\square h12 mm	l_g mm	TiN designation DP2068105
	M 12		1,75	110	23	-	9	7	10	-M12

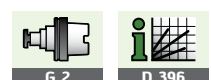

Machine thread former Protodyn® Plus



$\leq 3 \times D_N$

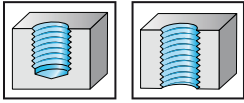

- HSS-E
- chamfer form C = 2 - 3.5 thread
- materials from 200 to 1200 N/mm² or 36 HRC
- for long-chipping materials

M

DIN 13

	P	M	K	N	S	H	O
TiN	●●	●	●	●●	●		

DIN 2174 7GX

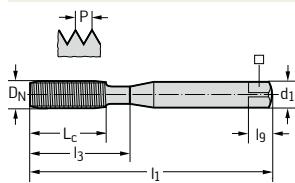

D _N	P mm	l ₁ js16 mm	L _c mm	l ₃ ±1 mm	d ₁ h9 mm	□ h12 mm	l _g mm	TiN designation DP2064105
M 2	0,4	45	6	11	2,8	2,1	5	-M2
M 2,5	0,45	50	8	14	2,8	2,1	5	-M2.5
M 3	0,5	56	9	18	3,5	2,7	6	-M3
M 3,5	0,6	56	11	20	4	3	6	-M3.5
M 4	0,7	63	12	21	4,5	3,4	6	-M4
M 5	0,8	70	13	25	6	4,9	8	-M5
M 6	1	80	15	30	6	4,9	8	-M6
M 8	1,25	90	18	35	8	6,2	9	-M8
M 10	1,5	100	20	39	10	8	11	-M10

DIN 2174 7GX

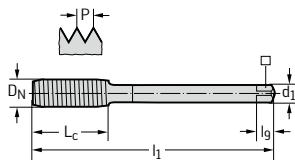

D _N	P mm	l ₁ js16 mm	L _c mm	l ₃ ±1 mm	d ₁ h9 mm	□ h12 mm	l _g mm	TiN designation DP2069105
M 12	1,75	110	23	-	9	7	10	-M12

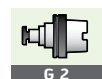

Machine thread former Protodyn® S Plus



$\leq 3,5 \times D_N$

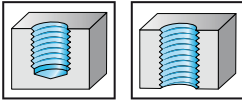

- HSS-E
- chamfer form C = 2 - 3,5 thread
- materials from 200 to 1200 N/mm² or 36 HRC
- for long-chipping materials

M

DIN 13

	P	M	K	N	S	H	O
TiN	●●	●●	●●	●●	●		

DIN 2174 6HX		D _N	P mm	l ₁ js16 mm	L _c mm	l ₃ ±1 mm	d ₁ h9 mm	□ h12 mm	l _g mm	TiN designation DP2061705
	M 2		0,4	45	6	11	2,8	2,1	5	-M2
	M 2,5		0,45	50	8	14	2,8	2,1	5	-M2.5
	M 3		0,5	56	9	18	3,5	2,7	6	-M3
	M 3,5		0,6	56	11	20	4	3	6	-M3.5
	M 4		0,7	63	12	21	4,5	3,4	6	-M4
	M 5		0,8	70	13	25	6	4,9	8	-M5
	M 6		1	80	15	30	6	4,9	8	-M6
	M 7		1	80	15	30	7	5,5	8	-M7
	M 8		1,25	90	18	35	8	6,2	9	-M8
	M 10		1,5	100	20	39	10	8	11	-M10

DIN 2174 6HX		D _N	P mm	l ₁ js16 mm	L _c mm	l ₃ ±1 mm	d ₁ h9 mm	□ h12 mm	l _g mm	TiN designation DP2066705
	M 12		1,75	110	23	-	9	7	10	-M12
	M 14		2	110	25	-	11	9	12	-M14
	M 16		2	110	25	-	12	9	12	-M16
	M 18		2,5	125	30	-	14	11	14	-M18
	M 20		2,5	140	30	-	16	12	15	-M20
	M 24		3	160	36	-	18	14,5	17	-M24

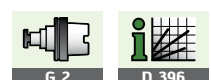

Machine thread former Protodyn® S Plus



$\leq 3,5 \times D_N$

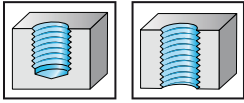

- HSS-E
- chamfer form C = 2 - 3.5 thread
- materials from 200 to 1200 N/mm² or 36 HRC
- for long-chipping materials

M

DIN 13

	P	M	K	N	S	H	O
TiN	●●	●●	●●	●●	●		

DIN 2174 6GX		D_N	P mm	l_1 js16 mm	L_c mm	l_3 ± 1 mm	d_1 h9 mm	\square h12 mm	l_g mm	TiN designation DP2063705
	M 2		0,4	45	6	11	2,8	2,1	5	-M2
	M 2,5		0,45	50	8	14	2,8	2,1	5	-M2.5
	M 3		0,5	56	9	18	3,5	2,7	6	-M3
	M 3,5		0,6	56	11	20	4	3	6	-M3.5
	M 4		0,7	63	12	21	4,5	3,4	6	-M4
	M 5		0,8	70	13	25	6	4,9	8	-M5
	M 6		1	80	15	30	6	4,9	8	-M6
	M 8		1,25	90	18	35	8	6,2	9	-M8
	M 10		1,5	100	20	39	10	8	11	-M10

DIN 2174 6GX		D_N	P mm	l_1 js16 mm	L_c mm	l_3 ± 1 mm	d_1 h9 mm	\square h12 mm	l_g mm	TiN designation DP2068705
	M 12		1,75	110	23	-	9	7	10	-M12



G 2

D 396

Machine thread former Protodyn® S Plus



$\leq 3,5 \times D_N$

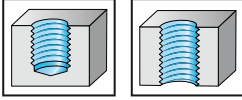

- HSS-E
- chamfer form C = 2 - 3,5 thread
- materials from 200 to 1200 N/mm² or 36 HRC
- for long-chipping materials

M

DIN 13

	P	M	K	N	S	H	O
TiN	●●	●●	●●	●●	●		

DIN 2174 7GX		D_N	P mm	l_1 js16 mm	L_c mm	l_3 ± 1 mm	d_1 h9 mm	\square h12 mm	l_g mm	TiN designation DP2064705
	M 2		0,4	45	6	11	2,8	2,1	5	-M2
	M 2,5		0,45	50	8	14	2,8	2,1	5	-M2.5
	M 3		0,5	56	9	18	3,5	2,7	6	-M3
	M 3,5		0,6	56	11	20	4	3	6	-M3.5
	M 4		0,7	63	12	21	4,5	3,4	6	-M4
	M 5		0,8	70	13	25	6	4,9	8	-M5
	M 6		1	80	15	30	6	4,9	8	-M6
	M 8		1,25	90	18	35	8	6,2	9	-M8
	M 10		1,5	100	20	39	10	8	11	-M10

DIN 2174 7GX		D_N	P mm	l_1 js16 mm	L_c mm	l_3 ± 1 mm	d_1 h9 mm	\square h12 mm	l_g mm	TiN designation DP2069705
	M 12		1,75	110	23	-	9	7	10	-M12

Machine thread former Protodyn®



$\leq 3 \times D_N$

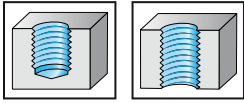

- HSS-E
- chamfer form C = 2 - 3.5 thread
- left-hand thread
- materials from 200 to 1200 N/mm² or 36 HRC
- for long-chipping materials

M
DIN 13

	P	M	K	N	S	H	O
TiN	●●	●	●	●●	●	●	●

DIN 2174 6HX		P	l ₁ js16	L _c	l ₃ ±1	d ₁ h9	□ h12	l _g	TiN designation D2061185
D _N	P	mm	mm	mm	mm	mm	mm	mm	
M 3 LH	0,5	56	9	18	3,5	2,7	6	-M3	
M 4 LH	0,7	63	12	21	4,5	3,4	6	-M4	
M 5 LH	0,8	70	13	25	6	4,9	8	-M5	
M 6 LH	1	80	15	30	6	4,9	8	-M6	
M 8 LH	1,25	90	18	35	8	6,2	9	-M8	
M 10 LH	1,5	100	20	39	10	8	11	-M10	

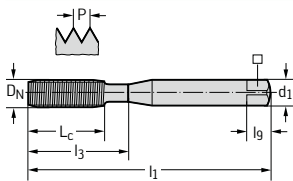

DIN 2174 6HX		P	l ₁ js16	L _c	l ₃ ±1	d ₁ h9	□ h12	l _g	TiN designation D2066185
D _N	P	mm	mm	mm	mm	mm	mm	mm	
M 12 LH	1,75	110	23	-	9	7	10	-M12	
M 16 LH	2	110	25	-	12	9	12	-M16	

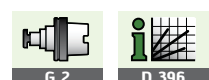
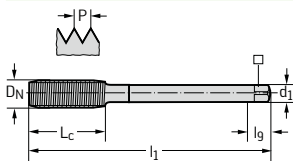

Machine thread former Protodyn®



$\leq 3 \times D_N$

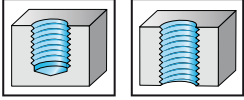

- solid carbide
- chamfer form C = 2 - 3,5 thread
- materials from 200 to 1200 N/mm² or 36 HRC
- for long-chipping materials

M

DIN 13

	P	M	K	N	S	H	O
TiCN	●●			●●	●		

DIN 2174 6HX		D_N	P mm	l_1 js16 mm	L_c mm	l_3 ± 1 mm	d_1 h6 mm	\square h12 mm	l_g mm	TiCN designation 8061106
		M 3	0,5	56	10	-	3,5	2,7	6	-M3 ¹
		M 4	0,7	63	13	-	4,5	3,4	6	-M4 ¹
		M 5	0,8	70	16	-	6	4,9	8	-M5 ¹
		M 6	1	80	19	30	6	4,9	8	-M6
		M 8	1,25	90	22	35	8	6,2	9	-M8
		M 10	1,5	100	24	39	10	8	11	-M10

¹without neck

Machine thread former Protodyn® S

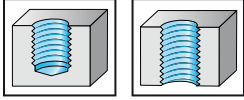
 $\leq 3,5 \times D_N$

- solid carbide
- chamfer form C = 2 - 3.5 thread
- materials from 200 to 1200 N/mm² or 36 HRC
- for long-chipping materials

M

DIN 13

	P	M	K	N	S	H	O
TiCN	●●	●	●	●●	●		

DIN 2174 6HX		D_N	P mm	l_1 js16 mm	L_c mm	l_3 ± 1 mm	d_1 h6 mm	\square h12 mm	l_g mm	TiCN designation 8061716
	M 5	0,8	70	16	-	6	4,9	8	-M5 ¹	
	M 6	1	80	19	30	6	4,9	8	-M6	
	M 8	1,25	90	22	35	8	6,2	9	-M8	
	M 10	1,5	100	24	39	10	8	11	-M10	

¹without neck

DIN 2174 6HX		D_N	P mm	l_1 js16 mm	L_c mm	l_3 ± 1 mm	d_1 h6 mm	\square h12 mm	l_g mm	TiCN designation 8066716
	M 12	1,75	110	23	-	9	7	10	-M12	

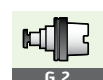

G 2



D 396

Machine thread former Protodyn® Eco Plus



$\leq 3 \times D_N$

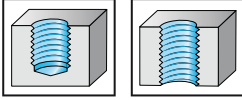

- HSS-E
- chamfer form E = 1.5 - 2 thread
- materials from 200 to 1200 N/mm² or 36 HRC
- for long-chipping materials
- with a lubrication groove

MF

DIN 13

	P	M	K	N	S	H	O
TiN	●	●	●	●	●		
TiCN	●	●	●	●	●		

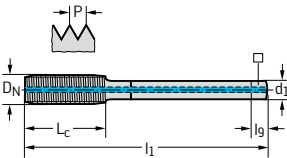
DIN 2174 6HX		D_N	P mm	l_1 js16 mm	L_c mm	d_1 h9 mm	\square h12 mm	l_g mm	TiN designation EP2166115	TiCN designation EP2166116
		M 8	1	90	18	6	4,9	8	-M8X1	-M8X1
		M 10	1	90	20	7	5,5	8	-M10X1	-M10X1
		M 12	1	100	21	9	7	10	-M12X1	-M12X1
		M 12	1,5	100	21	9	7	10	-M12X1.5	-M12X1.5
		M 14	1,5	100	21	11	9	12	-M14X1.5	-M14X1.5
		M 16	1,5	100	21	12	9	12	-M16X1.5	-M16X1.5

Machine thread former Protodyn® S Eco Plus



$\leq 3,5 \times D_N$

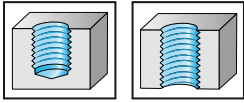

- HSS-E
- chamfer form C = 2 - 3.5 thread
- materials from 200 to 1200 N/mm² or 36 HRC
- for long-chipping materials

MF

DIN 13

	P	M	K	N	S	H	O
TiN	●	●	●	●	●		
TiCN	●	●	●	●	●		

DIN 2174 6HX

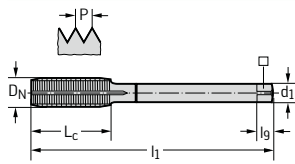

D _N	P mm	l ₁ js16 mm	L _c mm	d ₁ h9 mm	□ h12 mm	l ₉ mm	TiN designation EP2166705	TiCN designation EP2166706
M 8	1	90	18	6	4,9	8	-M8X1	-M8X1
M 10	1	90	20	7	5,5	8	-M10X1	-M10X1
M 12	1	100	21	9	7	10	-M12X1	-M12X1
M 12	1,5	100	21	9	7	10	-M12X1.5	-M12X1.5
M 14	1,5	100	21	11	9	12	-M14X1.5	-M14X1.5
M 16	1,5	100	21	12	9	12	-M16X1.5	-M16X1.5

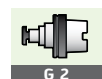

Machine thread former Protodyn® S Eco Plus



$\leq 3,5 \times D_N$

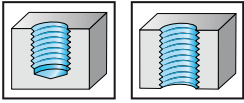

- HSS-E
- chamfer form C = 2 - 3,5 thread
- materials from 200 to 1200 N/mm² or 36 HRC
- for long-chipping materials

MF

DIN 13

	P	M	K	N	S	H	O
TiN	●	●	●	●	●		
TiCN	●	●	●	●	●		

DIN 2174 6GX		D_N	P mm	l_1 js16 mm	L_c mm	d_1 h9 mm	\square h12 mm	l_g mm	TiN designation EP2168705	TiCN designation EP2168706
	M 8	1	90	18	6	4,9	8	-M8X1	-M8X1	
	M 10	1	90	20	7	5,5	8	-M10X1	-M10X1	
	M 12	1	100	21	9	7	10	-M12X1	-M12X1	
	M 12	1,5	100	21	9	7	10	-M12X1.5	-M12X1.5	
	M 14	1,5	100	21	11	9	12	-M14X1.5	-M14X1.5	
	M 16	1,5	100	21	12	9	12	-M16X1.5	-M16X1.5	

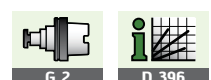

Machine thread former Protodyn® S Eco Plus

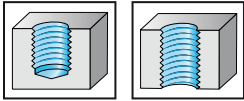

 $\leq 4 \times D_N$

- HSS-E
- chamfer form C = 2 - 3.5 thread
- materials from 200 to 1200 N/mm² or 36 HRC
- for long-chipping materials

MF

DIN 13

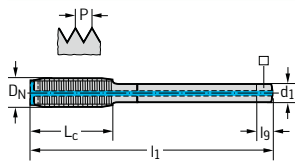
	P	M	K	N	S	H	O
TiN	●	●	●	●	●		
TiCN	●	●	●	●	●		

DIN 2174 6HX

D_N	P mm	l_1 js16 mm	L_c mm	d_1 h9 mm	□ h12 mm	l_9 mm	TiN designation EP2166745	TiCN designation EP2166746
M 8	1	90	18	6	4,9	8	-M8X1	-M8X1
M 10	1	90	20	7	5,5	8	-M10X1	-M10X1
M 12	1	100	21	9	7	10	-M12X1	-M12X1
M 12	1,5	100	21	9	7	10	-M12X1.5	-M12X1.5
M 14	1,5	100	21	11	9	12	-M14X1.5	-M14X1.5
M 16	1,5	100	21	12	9	12	-M16X1.5	-M16X1.5

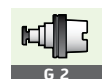

G 2



D 396

Machine thread former Protodyn® S Synchrospeed



$\leq 3,5 \times D_N$

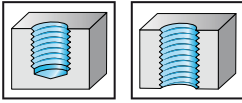

- HSS-E
- chamfer form C = 2 - 3.5 thread
- materials to 1200 N/mm² or 36 HRC
- for long-chipping materials
- only for synchronous machining (rigid tapping)
- suitable for minimum quantity lubrication

MF

DIN 13

	P	M	K	N	S	H	O
TiN	●	●	●	●	●		
TiCN	●	●	●	●	●		

~DIN 2174 6HX		D_N	P mm	l_1 js16 mm	L_c mm	l_3 ± 1 mm	d_1 h6 mm	h_{12} mm	l_9 mm	TiN designation S2166305	TiCN designation S2166306
Shank DIN 1835 B		M 8	1	90	6	35	8	6,2	9	-M8X1	-M8X1
		M 10	1	90	6	39	10	8	11	-M10X1	-M10X1
		M 12	1,5	100	9	42	12	9	12	-M12X1.5	-M12X1.5
		M 14	1,5	100	9	49	14	11	14	-M14X1.5	-M14X1.5
		M 16	1,5	100	9	50	16	12	15	-M16X1.5	-M16X1.5

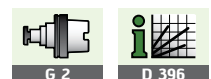

Machine thread former Protodyn® S Plus

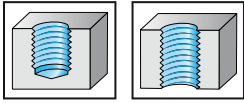
 $\leq 3,5 \times D_N$

- HSS-E
- chamfer form C = 2 - 3.5 thread
- materials from 200 to 1200 N/mm² or 36 HRC
- for long-chipping materials

MF

DIN 13

	P	M	K	N	S	H	O
TiN	●	●	●	●	●		

DIN 2174 6HX		P	l ₁ js16	L _c	l ₃ ±1	d ₁ h9	□ h12	l _g	TiN designation DP2161705
D _N	P	mm	mm	mm	mm	mm	mm	mm	
M 4	0,5	63	12	21	4,5	3,4	6	-M4X0.5	
M 5	0,5	70	13	25	6	4,9	8	-M5X0.5	
M 6	0,5	80	15	30	6	4,9	8	-M6X0.5	
M 6	0,75	80	15	30	6	4,9	8	-M6X0.75	
M 7	0,75	80	15	30	7	5,5	8	-M7X0.75	

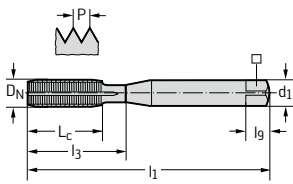

DIN 2174 6HX		P	l ₁ js16	L _c	l ₃ ±1	d ₁ h9	□ h12	l _g	TiN designation DP2166705
D _N	P	mm	mm	mm	mm	mm	mm	mm	
M 8	0,5	80	15	-	6	4,9	8	-M8X0.5	
M 8	0,75	80	15	-	6	4,9	8	-M8X0.75	
M 8	1	90	18	-	6	4,9	8	-M8X1	
M 10	1	90	20	-	7	5,5	8	-M10X1	
M 10	1,25	100	20	-	7	5,5	8	-M10X1.25	
M 12	1	100	21	-	9	7	10	-M12X1	
M 12	1,25	100	21	-	9	7	10	-M12X1.25	
M 12	1,5	100	21	-	9	7	10	-M12X1.5	
M 14	1,5	100	21	-	11	9	12	-M14X1.5	
M 16	1,5	100	21	-	12	9	12	-M16X1.5	
M 18	1,5	110	24	-	14	11	14	-M18X1.5	
M 20	1,5	125	24	-	16	12	15	-M20X1.5	
M 22	1,5	125	24	-	18	14,5	17	-M22X1.5	
M 24	1,5	140	26	-	18	14,5	17	-M24X1.5	

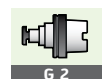
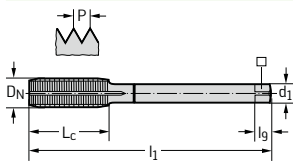

Machine thread former Protodyn® S



$\leq 3,5 \times D_N$

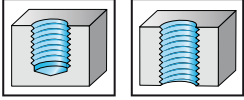

- HSS-E
- chamfer form E = 1.5 - 2 thread
- materials from 200 to 1200 N/mm² or 36 HRC
- for long-chipping materials

MF

DIN 13

	P	M	K	N	S	H	O
TiN	●●	●	●	●●	●		

DIN 2174 6GX		D_N	P mm	l_1 js16 mm	L_c mm	d_1 h9 mm	\square h12 mm	l_g mm	TiN designation D2168805
	M 10		1	90	20	7	5,5	8	-M10X1
	M 12		1,5	100	21	9	7	10	-M12X1.5
	M 14		1,5	100	21	11	9	12	-M14X1.5
	M 16		1,5	100	21	12	9	12	-M16X1.5



Machine thread former Protodyn®



$\leq 3 \times D_N$

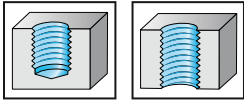

- solid carbide
- chamfer form C = 2 - 3.5 thread
- materials from 200 to 1200 N/mm² or 36 HRC
- for long-chipping materials

MF

DIN 13

	P	M	K	N	S	H	O
TiCN	●●			●●	●		

DIN 2174 6HX

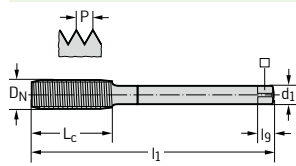

D _N	P mm	l ₁ js16 mm	L _c mm	d ₁ h6 mm	□ h12 mm	l _g mm	TiCN designation 8166106
M 8	1	90	12	6	4,9	8	-M8X1
M 10	1	90	14	7	5,5	8	-M10X1
M 12	1,5	100	20	9	7	10	-M12X1.5
M 14	1,5	100	21	11	9	12	-M14X1.5
M 16	1,5	100	21	12	9	12	-M16X1.5

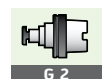

G 2



D 396

Machine thread former Protodyn® S Plus



$\leq 3,5 \times D_N$

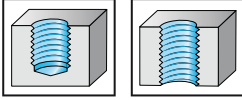

- HSS-E
- chamfer form C = 2 - 3,5 thread
- materials from 200 to 1200 N/mm² or 36 HRC
- for long-chipping materials

UNC

ASME B1.1

	P	M	K	N	S	H	O
TiN	●●	●●	●●	●●	●		

DIN 2184-1 2BX	D _N -P Nom	D _N mm	l ₁ js16 mm	L _c mm	l ₃ ±1 mm	d ₁ h9 mm	□ h12 mm	l _g mm	TIN designation DP2261705
	No. 2-56	2,184	45	7	12	2,8	2,1	5	-UNC2
	No. 4-40	2,845	56	9	18	3,5	2,7	6	-UNC4
	No. 6-32	3,505	56	11	20	4	3	6	-UNC6
	No. 8-32	4,166	63	12	21	4,5	3,4	6	-UNC8
	No. 10-24	4,826	70	13	25	6	4,9	8	-UNC10
	1/4-20	6,35	80	15	30	7	5,5	8	-UNC1/4
	5/16-18	7,938	90	18	35	8	6,2	9	-UNC5/16
	3/8-16	9,525	100	20	39	10	8	11	-UNC3/8

DIN 2184-1 2BX	D _N -P Nom	D _N mm	l ₁ js16 mm	L _c mm	l ₃ ±1 mm	d ₁ h9 mm	□ h12 mm	l _g mm	TIN designation DP2266705
	7/16-14	11,113	100	20	-	8	6,2	9	-UNC7/16
	1/2-13	12,7	110	23	-	9	7	10	-UNC1/2
	5/8-11	15,875	110	25	-	12	9	12	-UNC5/8



Machine thread former Protodyn® S Plus



$\leq 3,5 \times D_N$

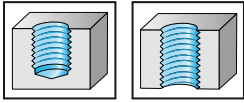

- HSS-E
- chamfer form C = 2 - 3.5 thread
- materials from 200 to 1200 N/mm² or 36 HRC
- for long-chipping materials

UNF

ASME B1.1

	P	M	K	N	S	H	O
TiN	●●	●●	●●	●●	●		

DIN 2184-1 2BX	D_N -P Nom	D_N mm	l_1 js16 mm	L_c mm	l_3 ± 1 mm	d_1 h9 mm	\square h12 mm	l_g mm	TiN designation DP2361705
	No. 2-64	2,184	45	7	12	2,8	2,1	5	-UNF2
	No. 4-48	2,845	56	9	18	3,5	2,7	6	-UNF4
	No. 6-40	3,505	56	11	20	4	3	6	-UNF6
	No. 8-36	4,166	63	12	21	4,5	3,4	6	-UNF8
	No. 10-32	4,826	70	13	25	6	4,9	8	-UNF10
	1/4-28	6,35	80	15	30	7	5,5	8	-UNF1/4
	5/16-24	7,938	90	18	35	8	6,2	9	-UNF5/16
	3/8-24	9,525	100	20	39	10	8	11	-UNF3/8

DIN 2184-1 2BX	D_N -P Nom	D_N mm	l_1 js16 mm	L_c mm	l_3 ± 1 mm	d_1 h9 mm	\square h12 mm	l_g mm	TiN designation DP2366705
	7/16-20	11,113	100	20	-	8	6,2	9	-UNF7/16
	1/2-20	12,7	100	21	-	9	7	10	-UNF1/2
	5/8-18	15,875	100	21	-	12	9	12	-UNF5/8



Machine thread former Protodyn® S Plus



$\leq 3,5 \times D_N$

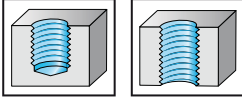

- HSS-E
- chamfer form C = 2 - 3,5 thread
- materials from 200 to 1200 N/mm² or 36 HRC
- for long-chipping materials

G

DIN EN ISO 228

	P	M	K	N	S	H	O
TiN	●●	●●	●●	●●	●		

DIN 2189 G-X		D_N Nom	D_N mm	Threads per inch	l_1 js16 mm	L_c mm	d_1 h9 mm	h_{12} mm	l_g mm	TiN designation DP2466705
	G 1/8		9,728	28	90	20	7	5,5	8	-G1/8
	G 1/4		13,157	19	100	21	11	9	12	-G1/4
	G 3/8		16,662	19	100	21	12	9	12	-G3/8
	G 1/2		20,955	14	125	24	16	12	15	-G1/2
	G 3/4		26,441	14	140	26	20	16	19	-G3/4
	G 1		33,249	11	160	28	25	20	23	-G1



Threading dies Protocut®



- HSS
- chamfer 1.75 x P
- materials from 200 to 1200 N/mm² or 36 HRC
- for long and short-chipping materials

M
DIN 13

	P	M	K	N	S	H	O
uncoated	●●			●●			

EN 22568 6g

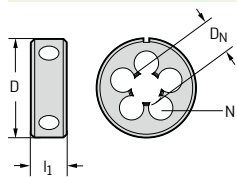

D _N	P mm	D f10 mm	l ₁ js12 mm	N	uncoated designation 60000
M 1	0,25	16	5	3	-M1
M 1,2	0,25	16	5	3	-M1.2
M 1,4	0,3	16	5	3	-M1.4
M 1,6	0,35	16	5	3	-M1.6
M 2	0,4	16	5	3	-M2
M 2,5	0,45	16	5	3	-M2.5
M 3	0,5	20	5	3	-M3
M 4	0,7	20	5	3	-M4
M 5	0,8	20	7	4	-M5
M 6	1	20	7	4	-M6
M 8	1,25	25	9	4	-M8
M 10	1,5	30	11	4	-M10
M 12	1,75	38	14	4	-M12
M 14	2	38	14	5	-M14
M 16	2	45	18	5	-M16
M 20	2,5	45	18	5	-M20
M 24	3	55	22	5	-M24
M 30	3,5	65	25	6	-M30

≤M 1.4: 6h, ≥ M1.6: 6g

Threading dies Protocut® Inox

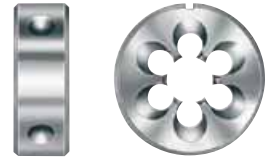

- HSS-E
- chamfer ~2.25 x P
- materials from 400 to 1200 N/mm² or 36 HRC
- for long-chipping materials

M

DIN 13

	P	M	K	N	S	H	O
uncoated	●●	●●	●●	●●	●●	●●	●●

EN 22568 6g		D _N	P mm	D f10 mm	l ₁ js12 mm	N	uncoated designation 60003
	M 2		0,4	16	5	4	-M2
	M 2,5		0,45	16	5	4	-M2.5
	M 3		0,5	20	5	4	-M3
	M 3,5		0,6	20	5	4	-M3.5
	M 4		0,7	20	5	5	-M4
	M 5		0,8	20	7	5	-M5
	M 6		1	20	7	5	-M6
	M 7		1	25	9	5	-M7
	M 8		1,25	25	9	6	-M8
	M 10		1,5	30	11	6	-M10
	M 12		1,75	38	14	6	-M12
	M 14		2	38	14	6	-M14
	M 16		2	45	18	6	-M16
	M 18		2,5	45	18	6	-M18
	M 20		2,5	45	18	6	-M20

Threading dies Protocut®



- HSS
- chamfer 1.75 x P
- materials from 200 to 1200 N/mm² or 36 HRC
- for long and short-chipping materials

MF

DIN 13

	P	M	K	N	S	H	O
uncoated	●●			●●			

EN 22568 6g

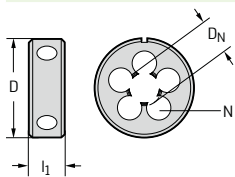

D _N	P mm	D f10 mm	l ₁ js12 mm	N	uncoated designation 61000
M 5	0,5	20	5	4	-M5X0.5
M 6	0,5	20	5	4	-M6X0.5
M 6	0,75	20	7	4	-M6X0.75
M 8	0,75	25	9	5	-M8X0.75
M 8	1	25	9	5	-M8X1
M 10	1	30	11	5	-M10X1
M 10	1,25	30	11	5	-M10X1.25
M 12	1	38	10	5	-M12X1
M 12	1,25	38	10	5	-M12X1.25
M 12	1,5	38	10	5	-M12X1.5
M 14	1,5	38	10	5	-M14X1.5
M 14	1	38	10	5	-M14X1
M 16	1,5	45	14	5	-M16X1.5
M 16	1	45	14	5	-M16X1
M 18	1	45	14	6	-M18X1
M 18	1,5	45	14	6	-M18X1.5
M 20	1	45	14	6	-M20X1
M 20	1,5	45	14	6	-M20X1.5
M 22	1,5	55	16	6	-M22X1.5
M 24	1,5	55	16	6	-M24X1.5
M 30	1,5	65	18	8	-M30X1.5

Threading dies Protocut®



- HSS
- chamfer 1.75 x P
- materials from 200 to 1200 N/mm² or 36 HRC
- for long and short-chipping materials

UNC

ASME B1.1

	P	M	K	N	S	H	O
uncoated	●●			●●			

EN 22568 2A	D _N -P Nom	D _N mm	D f10 mm	l ₁ js12 mm	N	uncoated designation 62000
	No. 2-56	2,184	16	5	4	-UNC2
	No. 3-48	2,515	16	5	4	-UNC3
	No. 4-40	2,845	16	5	4	-UNC4
	No. 5-40	3,175	20	5	4	-UNC5
	No. 8-32	4,166	20	7	3	-UNC8
	No. 10-24	4,826	20	7	4	-UNC10
	No. 12-24	5,486	20	7	4	-UNC12
	No. 6-32	3,505	20	7	4	-UNC6
	1/4-20	6,35	20	7	4	-UNC1/4
	5/16-18	7,938	25	9	4	-UNC5/16
	3/8-16	9,525	30	11	4	-UNC3/8
	7/16-14	11,113	30	11	4	-UNC7/16
	1/2-13	12,7	38	14	4	-UNC1/2
	9/16-12	14,288	38	14	5	-UNC9/16
	3/4-10	19,05	45	18	5	-UNC3/4
	5/8-11	15,875	45	18	5	-UNC5/8
	1-8	25,4	55	22	6	-UNC1X8

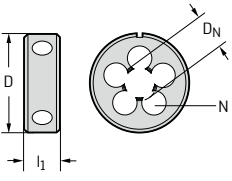

Threading dies Protocut®



- HSS
- chamfer 1.75 x P
- materials from 200 to 1200 N/mm² or 36 HRC
- for long and short-chipping materials

UNC

ASME B1.1

	P	M	K	N	S	H	O
uncoated	●●			●●			

EN 22568 2A	D _N -P Nom	D _N mm	D f10 mm	l ₁ js12 mm	N	uncoated designation 63000
	No. 6-40	3,505	20	5	4	-UNF6
	No. 10-32	4,826	20	7	4	-UNF10
	No. 12-28	5,486	20	7	4	-UNF12
	No. 8-36	4,166	20	7	4	-UNF8
	1/4-28	6,35	20	7	4	-UNF1/4
	5/16-24	7,938	25	9	4	-UNF5/16
	1/2-20	12,7	38	10	5	-UNF1/2
	9/16-18	14,288	38	10	5	-UNF9/16
	3/8-24	9,525	30	11	5	-UNF3/8
	7/16-20	11,113	30	11	5	-UNF7/16
	3/4-16	19,05	45	14	6	-UNF3/4
	5/8-18	15,875	45	14	5	-UNF5/8
7/8-14	22,225	55	16	6	-UNF7/8	

Threading dies Protocut®

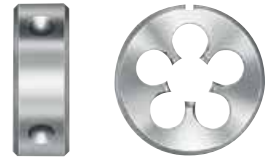

- HSS
- chamfer 1.75 x P
- materials from 200 to 1200 N/mm² or 36 HRC
- for long and short-chipping materials

G

DIN EN ISO 228

	P	M	K	N	S	H	O
uncoated	●●			●●			

EN 24231 Class A		D _N Nom	D _N mm	Threads per inch	D f10 mm	l ₁ js12 mm	N	uncoated designation 64000
	G 1		33,249	11	65	18	8	-G1
	G 1/2		20,955	14	45	14	6	-G1/2
	G 1/4		13,157	19	38	10	5	-G1/4
	G 1/8		9,728	28	30	11	5	-G1/8
	G 3/4		26,441	14	55	16	6	-G3/4
	G 3/8		16,662	19	45	14	5	-G3/8

Walter Select – Thread milling

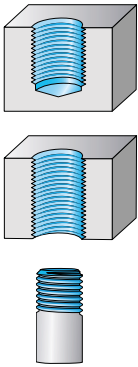

Blind and through hole machining

Solid carbide



BH = Blind hole
TH = Through hole

Thread depth		1,5 x D _N		
Type	Thread milling cutter hard 10	Thread milling cutter 27	Thread milling cutter Ni 27	
Helix angle	10°	27°	27°	
	Page	Page	Page	
M	D 370	D 371		
MJ			D 372	
MF	D 370	D 377		
UNC	UNJC			
UNF	UNJF		D 381	
UNEF				
G				
RC	RP			
NPT	NPSM			
NPTF				
Pg	BSW			
TR				
EG M	EG MF			
EG UNC				
EG UNF				
Coolant	MQL/air blast	Emulsion/MQL	Emulsion/MQL	
Coating	TAX	TiCN	TiCN	
Shank	HA/HB	HA	HA	

Material group	Classification of the main material groups and code letters		Brinell hardness HB	Tensile strength R _m N/mm ²	Machining group			
	Workpiece material							
P	Unalloyed and low-alloyed steel	annealed (tempered)	210	700	P1, P2, P3, P4, P7	●●	●	
		Free cutting steel	220	750	P6	●●	●	
		tempered	300	1010	P5, P8	●●	●	
		tempered	380	1280	P9	●●	●	
		tempered	430	1480	P10	●●	●	
	High-alloyed steel and high-alloyed tool steel	annealed	200	670	P11	●●	●	
hardened and tempered		300	1010	P12	●●	●		
hardened and tempered		400	1360	P13	●●	●		
Stainless steel	ferritic / martensitic, annealed	200	670	P14	●	●●	●	
	martensitic, tempered	330	1110	P15	●	●●	●	
M	Stainless steel	austenitic, duplex	230	780	M1, M3	●●	●	
		austenitic, precipitation hardened (PH)	300	1010	M2	●●	●	
K	Grey cast iron		245	–	K3, K4	●●	●	
	Cast iron with spheroidal graphite	ferritic, pearlitic	365	–	K1, K2, K5, K6	●●	●	
	GGV (CGI)		200	–	K7	●●	●	
N	Aluminium wrought alloys	cannot be hardened	30	–	N1	●●	●	
		hardenable, hardened	100	340	N2	●●	●	
	Cast aluminium alloys	≤ 12 % Si	90	310	N3, N4	●●	●	
		> 12 % Si	130	450	N5	●●	●	
	Magnesium alloys		70	250	N6	●●	●	
	Copper and copper alloys (bronze / brass)	unalloyed, electrolytic copper	100	340	N7	●●	●	
Brass, bronze, red brass		90	310	N8	●●	●		
Cu-alloys, short-chipping		110	380	N9	●●	●		
high-strength, Ampco		300	1010	N10	●●	●		
S	Heat-resistant alloys	Fe-based	280	940	S1, S2	●●	●●	
		Ni-based or Co-based	250	840	S3	●●	●●	
		Ni-based or Co-based	350	1080	S4, S5	●●	●●	
	Titanium alloys	Pure titanium	200	670	S6	●●	●●	
		α and β alloys, hardened	375	1260	S7	●●	●●	
		β alloys	410	1400	S8	●●	●●	
Tungsten alloys		300	1010	S9	●	●●	●	
Molybdenum alloys		300	1010	S10	●	●●	●	
H	Hardened steel		50 HRC	–	H1	●●		
			55 HRC	–	H2, H4	●●		
			60 HRC	–	H3	●●		
O	Thermoplasts	without abrasive fillers			O1	●●	●	
	Thermosetting plastics	without abrasive fillers			O2	●●	●	
	Fibre-reinforced plastic	GFRP, AFRP			O3, O5	●	●	●
		CFRP			O4	●	●	●
	Graphite (technical)			65	O6	●	●	●

Shank thread milling cutter 10



$\leq 1,5 \times D_N$

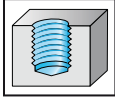

- solid carbide
- 4 to 6 cutting edges
- 10° helix angle
- materials from 48 to 63 HRC
- short version

M-MF

DIN 13

	P	M	K	N	S	H	O
TAX	●●	●	●	●	●	●●	●

Tool	P mm	D _c mm	L _c mm	l ₁ mm	l ₄ mm	d ₁ h6 mm	Z	TAX designation H5033008	
Shank DIN 6535 HA	M 6	1	4,5	10	57	21	6	4	-M6
	M 8	1,25	6	12,5	57	21	6	5	-M8
	M 10	1,5	8	16,5	63	27	8	5	-M10
	M 12	1,75	9	19,25	72	32	10	5	-M12
	M 16	2	12	26	83	38	12	5	-M16

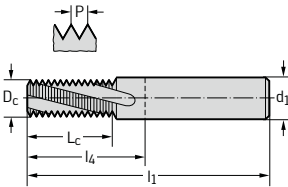

Tool	P mm	D _c mm	L _c mm	l ₁ mm	l ₄ mm	d ₁ h6 mm	Z	TAX designation H5133008	
Shank DIN 6535 HA	M 12x1	1	10	20	72	32	10	5	-M12x1
	M 14x1,5	1,5	12	27	83	38	12	6	-M14x1.5

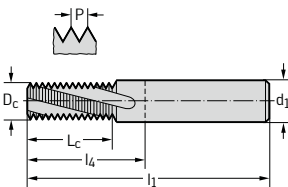

Shank thread milling cutter 27



$\leq 1,5 \times D_N$

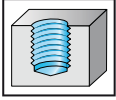

- solid carbide
- 4 to 5 cutting edges
- 27° helix angle
- materials to 48 HRC
- short version

M-MF

DIN 13

	P	M	K	N	S	H	O
TiCN	●●	●●	●●	●●	●●		●

Tool		P mm	D _c mm	L _c mm	l ₁ mm	l ₄ mm	d ₁ h6 mm	Z	TiCN designation H5035016
Shank DIN 6535 HA	M 6	1	4,5	9	51	15	6	4	-M6
	M 8	1,25	6	12,5	55	19	6	4	-M8
	M 10	1,5	7,5	15	59	23	8	4	-M10
	M 12	1,75	9,5	19,25	70	30	10	4	-M12
	M 14	2	10	22	72	32	10	5	-M14

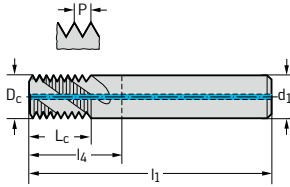

Shank thread milling cutter Ni 27



$\leq 1,5 \times D_N$

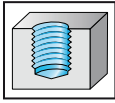

- solid carbide
- 3 to 4 cutting edges
- 27° helix angle
- materials to 48 HRC
- short version
- thread profile rounded on the outside diameter

MJ

DIN ISO 5855-1

	P	M	K	N	S	H	O
TiCN	●	●	●	●	●●		●

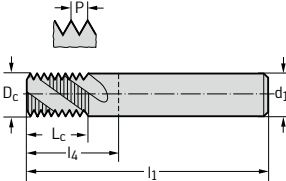
Tool		P mm	D _c mm	L _c mm	l ₁ mm	l ₄ mm	d ₁ h6 mm	Z	TiCN designation H5036006
Shank DIN 6535 HA 	MJ 4	0,7	3	6,3	54	18	6	3	-MJ4
	MJ 5	0,8	3,9	8	54	18	6	3	-MJ5
	MJ 6	1	4,8	9	54	20	6	3	-MJ6

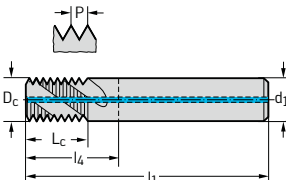
Tool		P mm	D _c mm	L _c mm	l ₁ mm	l ₄ mm	d ₁ h6 mm	Z	TiCN designation H5036016
Shank DIN 6535 HA 	MJ 8	1,25	6,3	12,5	58	22	8	4	-MJ8
	MJ 10	1,5	7,5	15	58	22	8	4	-MJ10
	MJ 12	1,75	9,5	19,25	72	26	10	4	-MJ12

Shank thread milling cutter 10



$\leq 2 \times D_N$

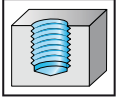

- solid carbide
- 4 to 5 cutting edges
- 10° helix angle
- materials to 48 HRC

M-MF

DIN 13

	P	M	K	N	S	H	O
TiCN	●●	●●	●●	●●	●●		●

Tool	P mm	D _c mm	L _c mm	l ₁ mm	l ₄ mm	d ₁ h6 mm	Z	TiCN designation H5041116
Shank DIN 6535 HB	1	4,5	13	57	21	6	4	-M6
	1,25	6	17,5	65	29	6	4	-M8
	1,5	7,5	21	72	36	8	4	-M10
	1,75	9,5	26,25	80	40	10	4	-M12
	2	10	30	83	43	10	5	-M14
	2	12	34	92	47	12	5	-M16

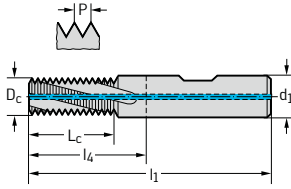

Shank thread milling cutter 10

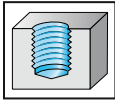
 $\leq 2 \times D_N$

- solid carbide
- 3 to 6 cutting edges
- 10° helix angle
- materials to 48 HRC

MF

DIN 13

	P	M	K	N	S	H	O
uncoated	●	●	●	●	●		●
TiCN	●	●	●	●	●		●

Tool	P mm	D _c mm	L _c mm	l ₁ mm	l ₄ mm	d ₁ h6 mm	Z	uncoated	TiCN	
								designation H515100	designation H5151006	
Shank DIN 6535 HA										
	M 6x0,5	0,5	4,8	10	57	21	6	3	-M6X0.5	-M6X0.5
	M 8x0,75	0,75	6	12	57	21	6	3	-M8X0.75	-M8X0.75
	M 8x1	1	6	12	57	21	6	3	-M8X1	-M8X1
	M 10x0,5	0,5	8	16	63	27	8	4	-M10X0.5	-M10X0.5
	M 10x1	1	8	16	63	27	8	4	-M10X1	-M10X1
	M 12x1	1	10	20	72	32	10	4	-M12X1	-M12X1
	M 12x1,25	1,25	10	20	72	32	10	4	-M12X1.25	-M12X1.25
	M 12x1,5	1,5	10	21	72	32	10	4	-M12X1.5	-M12X1.5
	M 14x1	1	12	22	83	38	12	4	-M14X1	-M14X1
	M 14x1,5	1,5	12	22,5	83	38	12	4	-M14X1.5	-M14X1.5
	M 16x1	1	14	26	83	38	14	5	-M16X1	-M16X1
	M 16x1,5	1,5	14	27	83	38	14	5	-M16X1.5	-M16X1.5
	M 18x1	1	16	30	92	44	16	5	-M18X1	-M18X1
	M 18x1,5	1,5	16	30	92	44	16	5	-M18X1.5	-M18X1.5
	M 20x2	2	16	30	92	44	16	5	-M20X2	-M20X2
	M 20x2,5	2,5	16	42,5	105	57	16	5	-M20X2.5	-M20X2.5
	M 24x2	2	20	36	104	54	20	5	-M24X2	-M24X2
	M 24x3	3	19	51	125	75	20	5	-M24X3	-M24X3
	M 28x2	2	25	46	121	65	25	6	-M28X2	-M28X2

Tool	P mm	D _c mm	L _c mm	l ₁ mm	l ₄ mm	d ₁ h6 mm	Z	TICN	
								designation H5151106	
Shank DIN 6535 HB									
	M 6x0,5	0,5	4,8	10	57	21	6	3	-M6X0.5
	M 8x0,75	0,75	6	12	57	21	6	3	-M8X0.75
	M 8x1	1	6	12	57	21	6	3	-M8X1
	M 10x0,5	0,5	8	16	63	27	8	4	-M10X0.5
	M 10x1	1	8	16	63	27	8	4	-M10X1
	M 12x1	1	10	20	72	32	10	4	-M12X1
	M 12x1,25	1,25	10	20	72	32	10	4	-M12X1.25
	M 12x1,5	1,5	10	21	72	32	10	4	-M12X1.5
	M 14x1	1	12	22	83	38	12	4	-M14X1
	M 14x1,5	1,5	12	22,5	83	38	12	4	-M14X1.5
	M 16x1	1	14	26	83	38	14	5	-M16X1
	M 16x1,5	1,5	14	27	83	38	14	5	-M16X1.5
	M 18x1	1	16	30	92	44	16	5	-M18X1
	M 18x1,5	1,5	16	30	92	44	16	5	-M18X1.5
	M 20x2	2	16	30	92	44	16	5	-M20X2
	M 20x2,5	2,5	16	42,5	105	57	16	5	-M20X2.5
	M 24x2	2	20	36	104	54	20	5	-M24X2
	M 24x3	3	19	51	125	75	20	5	-M24X3
	M 28x2	2	25	46	121	65	25	6	-M28X2

Shank thread milling cutter 10

 $\leq 2 \times D_N$

Continued

Tool	P mm	D _c mm	L _c mm	l ₁ mm	l ₄ mm	d ₁ h6 mm	Z	TICN designation H5151116	
Shank DIN 6535 HB	M 6x0,5	0,5	4,8	10	57	21	6	3	-M6X0.5
	M 8x0,75	0,75	6	12	57	21	6	3	-M8X0.75
	M 8x1	1	6	12	57	21	6	3	-M8X1
	M 10x0,5	0,5	8	16	63	27	8	4	-M10X0.5
	M 10x1	1	8	16	63	27	8	4	-M10X1
	M 12x1	1	10	20	72	32	10	4	-M12X1
	M 12x1,25	1,25	10	20	72	32	10	4	-M12X1.25
	M 12x1,5	1,5	10	21	72	32	10	4	-M12X1.5
	M 14x1	1	12	22	83	38	12	4	-M14X1
	M 14x1,5	1,5	12	22,5	83	38	12	4	-M14X1.5
	M 16x1	1	14	26	83	38	14	5	-M16X1
	M 16x1,5	1,5	14	27	83	38	14	5	-M16X1.5
	M 18x1	1	16	30	92	44	16	5	-M18X1
	M 18x1,5	1,5	16	30	92	44	16	5	-M18X1.5
	M 20x2	2	16	30	92	44	16	5	-M20X2
	M 20x2,5	2,5	16	42,5	105	57	16	5	-M20X2.5
	M 24x2	2	20	36	104	54	20	5	-M24X2
	M 24x3	3	19	51	125	75	20	5	-M24X3
	M 28x2	2	25	46	121	65	25	6	-M28X2

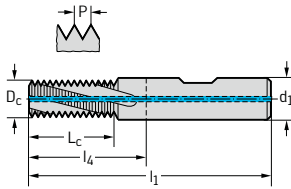

Shank thread milling cutter 20



$\leq 2 \times D_N$

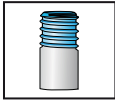

- solid carbide
- 4 to 6 cutting edges
- 20° helix angle
- materials to 48 HRC

M-MF

DIN 13

	P	M	K	N	S	H	O
TiCN	●	●	●	●	●		●

Tool	P mm	D _c mm	L _c mm	l ₁ mm	l ₄ mm	d ₁ h6 mm	Z	TiCN designation H5150106
Shank DIN 6535 HB	1	10	16	72	32	10	4	-M10X1
	1,5	12	22,5	83	38	12	5	-M12X1.5
	1	16	30	92	44	16	6	-M16X1
	1,25	16	30	92	44	16	6	-M16X1.25
	1,5	16	30	92	44	16	6	-M16X1.5
	1,75	16	29,75	92	44	16	6	-M16X1.75
	2	16	30	92	44	16	6	-M16X2
	3	20	42	104	54	20	6	-M20X3

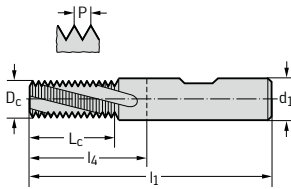

Shank thread milling cutter 27



$\leq 2 \times D_N$

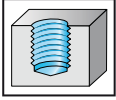

- solid carbide
- 3 to 4 cutting edges
- 27° helix angle
- materials to 48 HRC

MF

DIN 13

	P	M	K	N	S	H	O
uncoated	●	●	●	●	●		●
TiCN	●	●	●	●	●		●

Tool	P mm	D _c mm	L _c mm	l ₁ mm	l ₄ mm	d ₁ h6 mm	Z	uncoated	TiCN	
								designation H515501	designation H5155016	
Shank DIN 6535 HA										
	M 10x1	1	8	16	63	27	8	3	-M10X1	-M10X1
	M 12x1	1	10	20	72	32	10	3	-M12X1	-M12X1
	M 14x1	1	12	22	83	38	12	3	-M14X1	-M14X1
	M 16x1	1	14	26	83	38	14	4	-M16X1	-M16X1
	M 18x1	1	16	30	92	44	16	4	-M18X1	-M18X1
	M 12x1,5	1,5	10	21	72	32	10	3	-M12X1,5	-M12X1,5
	M 14x1,5	1,5	12	22,5	83	38	12	3	-M14X1,5	-M14X1,5
	M 16x1,5	1,5	14	27	83	38	14	4	-M16X1,5	-M16X1,5
	M 18x1,5	1,5	16	30	92	44	16	4	-M18X1,5	-M18X1,5
	M 20x2	2	16	30	92	44	16	4	-M20X2	-M20X2

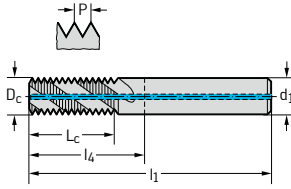

Shank thread milling cutter TMC



$\leq 2 \times D_N$

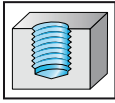

- solid carbide
- 3 to 4 cutting edges
- 27° helix angle
- materials to 48 HRC
- with countersink for chamfering the thread

M-MF

DIN 13

	P	M	K	N	S	H	O
uncoated	●	●	●	●	●		●
TiCN	●	●	●	●	●		●

Tool	P	D _c	L _c	l ₁	l ₄	d ₁ h6 mm	Z	uncoated designation H505500	TiCN designation H5055006	
Shank DIN 6535 HA	M 3	0,5	2,3	6	57	21	6	3	-M3	-M3

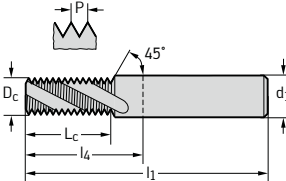

Tool	P	D _c	L _c	l ₁	l ₄	d ₁ h6 mm	Z	uncoated designation H505501	TiCN designation H5055106	
Shank DIN 6535 HB	M 3	0,5	2,3	6	57	21	6	3		-M3

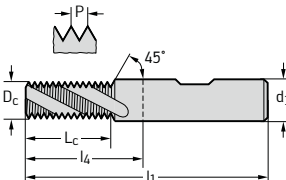

Tool	P	D _c	L _c	l ₁	l ₄	d ₁ h6 mm	Z	uncoated designation H505501	TiCN designation H5055016	
Shank DIN 6535 HA	M 4	0,7	3,2	8,4	57	21	6	3	-M4	-M4
	M 5	0,8	4,1	10,4	57	21	6	3	-M5	-M5
	M 6	1	4,8	12	63	27	8	3	-M6	-M6
	M 8	1,25	6,5	16,25	72	32	10	3	-M8	-M8
	M 10	1,5	8,2	21	83	38	12	3	-M10	-M10
	M 12	1,75	9,9	24,5	83	38	14	4	-M12	-M12
	M 14	2	11,6	30	92	44	16	4	-M14	-M14
	M 16	2	13,6	32	92	44	18	4	-M16	-M16

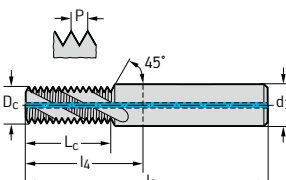

Shank thread milling cutter TMC

 $\leq 2 \times D_N$

Continued

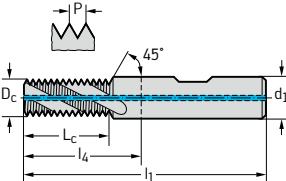
Tool		P mm	D _c mm	L _c mm	l ₁ mm	l ₄ mm	d ₁ h6 mm	Z		TICN designation H5055116
Shank DIN 6535 HB 	M 4	0,7	3,2	8,4	57	21	6	3		-M4
	M 5	0,8	4,1	10,4	57	21	6	3		-M5
	M 6	1	4,8	12	63	27	8	3		-M6
	M 8	1,25	6,5	16,25	72	32	10	3		-M8
	M 10	1,5	8,2	21	83	38	12	3		-M10
	M 12	1,75	9,9	24,5	83	38	14	4		-M12
	M 14	2	11,6	30	92	44	16	4		-M14
M 16	2	13,6	32	92	44	18	4		-M16	

Shank thread milling cutter 27



$\leq 2 \times D_N$

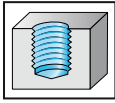

- solid carbide
- 3 to 4 cutting edges
- 27° helix angle
- materials to 48 HRC
- slim version

M-MF

DIN 13

	P	M	K	N	S	H	O
TiCN	●●	●●	●●	●●	●●		●

Tool	P mm	D _c mm	L _c mm	l ₁ mm	l ₄ mm	d ₁ h6 mm	Z	TiCN designation H5045016
Shank DIN 6535 HA								
M 6	1	4,5	13	57	21	6	3	-M6
M 8	1,25	6	17,5	65	29	6	3	-M8
M 10	1,5	7,5	21	72	36	8	3	-M10
M 12	1,75	9,5	26,25	80	40	10	3	-M12
M 14	2	10	30	83	43	10	4	-M14
M 16	2	12	34	92	47	12	4	-M16
M 20x2,5	2,5	16	32,5	92	44	16	4	-M20
M 24x3	3	19	39	104	54	20	4	-M24

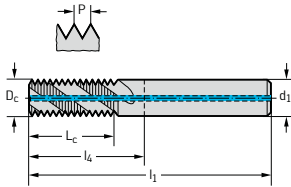

Shank thread milling cutter Ni 27



$\leq 1,5 \times D_N$

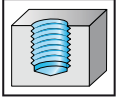

- solid carbide
- 3 to 4 cutting edges
- 27° helix angle
- materials to 48 HRC
- short version
- thread profile rounded on the outside diameter

UNJF

ISO 3161

	P	M	K	N	S	H	O
TiCN	●	●	●	●	●		●

Tool		Threads per inch	D _c mm	L _c mm	l ₁ mm	l ₄ mm	d ₁ h6 mm	Z	TiCN designation H5336006
Shank DIN 6535 HA	10-32 UNJF	32	3,6	7,94	54	18	6	3	-UNJF10
	1/4-UNJF	28	4,8	9,98	54	18	6	3	-UNJF1/4

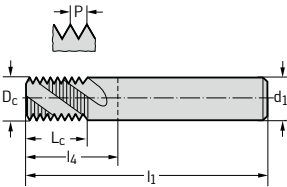

Tool		Threads per inch	D _c mm	L _c mm	l ₁ mm	l ₄ mm	d ₁ h6 mm	Z	TiCN designation H5336016
Shank DIN 6535 HA	5/16-UNJF	24	6,2	12,7	58	22	8	3	-UNJF5/16
	3/8-UNJF	24	8	14,82	58	22	8	3	-UNJF3/8
	7/16-UNJF	20	9,2	17,78	72	26	10	4	-UNJF7/16
	1/2-UNJF	20	10,5	19,05	73	28	12	4	-UNJF1/2

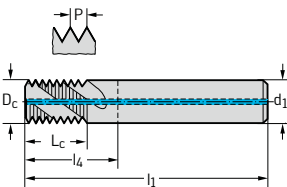

Shank thread milling cutter 10



$\leq 2 \times D_N$

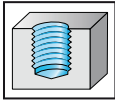

- solid carbide
- 3 to 5 cutting edges
- 10° helix angle
- materials to 48 HRC

UNC

ASME B1.1

	P	M	K	N	S	H	O
TiCN	●	●	●	●	●		●

Tool	Threads per inch	D _c mm	L _c mm	l ₁ mm	l ₄ mm	d ₁ h6 mm	Z	TiCN designation H5251116	
Shank DIN 6535 HB	1/4-UNC	20	4,8	13,97	57	21	6	3	-UNC1/4
	5/16-UNC	18	5,5	14,11	57	21	6	3	-UNC5/16
	3/8-UNC	16	7,5	19,05	63	27	8	4	-UNC3/8
	7/16-UNC	14	8	19,95	63	27	8	4	-UNC7/16
	9/16-UNC	12	10	21,16	72	32	10	4	-UNC9/16
	1/2-UNC	13	10	21,49	72	32	10	4	-UNC1/2
	5/8-UNC	11	12	25,4	83	38	12	4	-UNC5/8
	3/4-UNC	10	14	33,02	83	38	14	5	-UNC3/4
	7/8-UNC	9	16	36,69	92	44	16	5	-UNC7/8
	1-8-UNC	8	18	38,1	104	54	20	5	-UNC1
	8-UN	8	20	44,45	116	60	20	5	-UN1X8

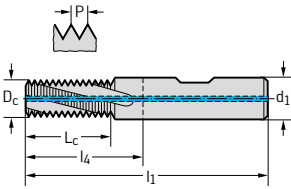

Shank thread milling cutter 10



$$\leq 2 \times D_N$$

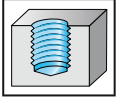

- solid carbide
- 3 to 5 cutting edges
- 10° helix angle
- materials to 48 HRC

UNF

ASME B1.1

	P	M	K	N	S	H	O
TiCN	●	●	●	●	●		●

Tool	Threads per inch	D _c mm	L _c mm	l ₁ mm	l ₄ mm	d ₁ h6 mm	Z	TiCN designation H5351116
Shank DIN 6535 HB	10-32 UNF	3,6	10,32	54	17	6	3	-UNF10
	1/4-UNF	4,8	13,61	57	21	6	3	-UNF1/4
	3/8-UNF	6	13,75	57	21	6	3	-UNF5/16
	1/2-UNF	8	19,05	63	27	8	4	-UNF7/16
	5/8-UNF	10	22,57	72	32	10	4	-UNF9/16
	3/4-UNF	14	31,75	83	38	14	5	-UNF3/4

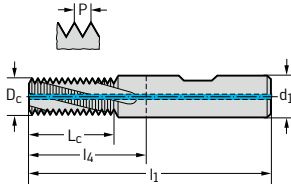

Shank thread milling cutter 10



$\leq 1,5 \times D_N$

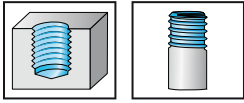

- solid carbide
- 3 to 6 cutting edges
- 10° helix angle
- materials to 48 HRC

G

DIN EN ISO 228

	P	M	K	N	S	H	O
uncoated	●	●	●	●	●		●
TiCN	●	●	●	●	●		●

Tool	Threads per inch	D _c mm	L _c mm	l ₁ mm	l ₄ mm	d ₁ h6 mm	Z	uncoated designation H545200	TiCN designation H5452006
Shank DIN 6535 HA	G1/8	6	15,42	57	21	6	3	-G1/8	-G1/8
	G1/4	10	20,05	72	32	10	4	-G1/4	-G1/4
	G3/8	14	26,72	83	38	14	5	-G3/8	-G3/8
	G1/2	16	30,8	92	44	16	5	-G1/2	-G1/2
	G3/4	20	36,28	104	54	20	5	-G5/8	-G5/8
	G1- G2	20	46,18	125	75	20	5	-G1X20	-G1X20
	G1- G2	25	46,18	121	65	25	6	-G1X25	-G1X25

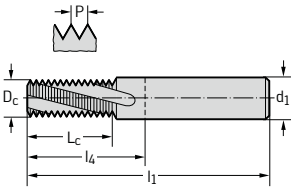

Tool	Threads per inch	D _c mm	L _c mm	l ₁ mm	l ₄ mm	d ₁ h6 mm	Z	TiCN designation H5452106
Shank DIN 6535 HB	G1/8	6	15,42	57	21	6	3	-G1/8
	G1/4	10	20,05	72	32	10	4	-G1/4
	G3/8	14	26,72	83	38	14	5	-G3/8
	G1/2	16	30,8	92	44	16	5	-G1/2
	G3/4	20	36,28	104	54	20	5	-G5/8
	G1- G2	25	46,18	121	65	25	6	-G1X25

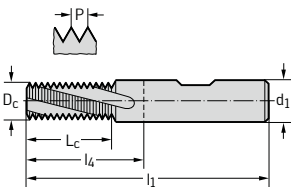

Tool	Threads per inch	D _c mm	L _c mm	l ₁ mm	l ₄ mm	d ₁ h6 mm	Z	TiCN designation H5452116
Shank DIN 6535 HB	G1/8	6	15,42	57	21	6	3	-G1/8
	G1/4	10	20,05	72	32	10	4	-G1/4
	G3/8	14	26,72	83	38	14	5	-G3/8
	G1/2	16	30,8	92	44	16	5	-G1/2
	G3/4	20	36,28	104	54	20	5	-G5/8
	G1- G2	25	46,18	121	65	25	6	-G1X25

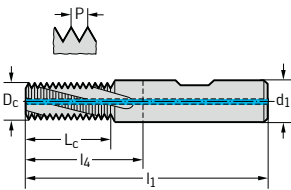

Shank thread milling cutter 10

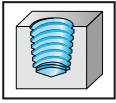

- solid carbide
- 3 to 5 cutting edges
- 10° helix angle
- materials to 48 HRC

NPT / NPFT

ASME B1.20.1 / ASME B1.20.3
1:16

	P	M	K	N	S	H	O
TiCN	●	●	●	●	●		●

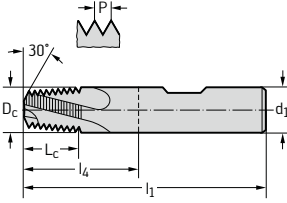
Tool	Threads per inch	D _c mm	L _c mm	l ₁ mm	l ₄ mm	d ₁ h6 mm	Z	TiCN designation H5651106	
Shank DIN 6535 HB 	1/16-NPT	27	5,5	11,5	57	21	6	3	-NPT1/16
	1/8-NPT	27	7,9	11,5	58	22	8	3	-NPT1/8
	1/4 - 3/8-NPT	18	9,9	15,92	66	26	10	3	-NPT1/4-3/8
	1/2 - 3/4-NPT	14	15,9	20,46	82	34	16	4	-NPT1/2-3/4
	1 - 2-NPT	11,5	19,9	27,12	92	42	20	5	-NPT1-2

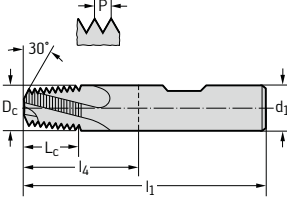
Tool	Threads per inch	D _c mm	L _c mm	l ₁ mm	l ₄ mm	d ₁ h6 mm	Z	TiCN designation H5651106	
Shank DIN 6535 HB 	1/16-NPTF	27	5,5	11,5	57	21	6	3	-NPTF1/16
	1/8-NPTF	27	7,9	11,5	58	22	8	3	-NPTF1/8
	1/4 - 3/8-NPTF	18	9,9	15,92	66	26	10	3	-NPTF1/4-3/8
	1/2 - 3/4-NPTF	14	15,9	20,46	82	34	16	4	-NPTF1/2-3/4
	1 - 2-NPTF	11,5	19,9	27,12	92	42	20	5	-NPTF1-2

Orbital thread mill TMO HRC

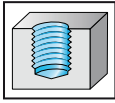
 $\leq 2 \times D_N$

- solid carbide
- 3 to 4 cutting edges
- 15° helix angle
- materials from 48 to 63 HRC

M-MF

DIN 13

	P	M	K	N	S	H	O
TAX	●●				●	●●	●

Tool	P mm	D _c mm	L _c mm	l ₃ ±1 mm	d ₂ mm	l ₁ mm	l ₄ mm	d ₁ h6 mm	Z	TAX	
										designation H5083008	
Shank DIN 6535 HA	M 2	0,4	1,55	0,8	4,6	0,98	57	21	6	3	-M2
	M 2,5	0,45	1,95	0,9	5,675	1,3	57	21	6	3	-M2.5
	M 3	0,5	2,3	1	6,75	1,6	57	21	6	3	-M3
	M 4	0,7	3,1	1,4	9,05	2,1	57	21	6	3	-M4
	M 5	0,8	4	1,6	11,2	2,9	57	21	6	4	-M5
	M 6	1	4,8	2	13,5	3,4	57	21	6	4	-M6

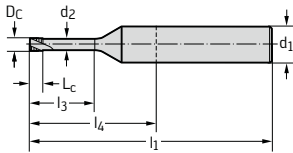

Orbital thread mill TMO



$$\leq 2 \times D_N$$

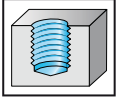

- solid carbide
- 3 to 5 cutting edges
- 15° helix angle
- materials to 48 HRC

M-MF

DIN 13

	P	M	K	N	S	H	O
TiCN	●●	●●	●●	●●	●●		●

Tool	P mm	D _c mm	L _c mm	l ₃ ±1 mm	d ₂ mm	l ₁ mm	l ₄ mm	d ₁ h6 mm	Z	TICN	
										designation H5087006	
Shank DIN 6535 HA 	M 1,6	0,35	1,2	0,7	3,725	0,74	38	10	3	-M1,6	
	M 2	0,4	1,55	1,2	4,6	0,98	57	21	6	3	-M2
	M 2,5	0,45	1,95	1,35	5,675	1,3	57	21	6	3	-M2,5
	M 3	0,5	2,3	1,5	6,75	1,6	57	21	6	3	-M3
	M 4	0,7	3,1	2,1	9,05	2,1	57	21	6	3	-M4
	M 5	0,8	4	2,4	11,2	2,9	57	21	6	3	-M5
	M 6	1	4,8	3	13,5	3,4	57	21	6	3	-M6
	M 8	1,25	6,4	3,75	17,9	4,7	63	27	8	3	-M8
	M 10	1,5	8,2	4,5	22,3	6,16	72	32	10	4	-M10
	M 12	1,75	9,5	5,25	26,7	7,13	72	27	10	5	-M12

Orbital thread mill TMO



$\leq 3 \times D_N$

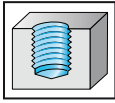

- solid carbide
- 3 cutting edges
- 15° helix angle
- materials to 48 HRC

M-MF

DIN 13

	P	M	K	N	S	H	O
uncoated	●	●	●	●	●		●
TiCN	●	●	●	●	●		●

Tool	P mm	D _c mm	L _c mm	l ₃ ±1 mm	d ₂ mm	l ₁ mm	l ₄ mm	d ₁ h6 mm	Z	uncoated designation H508800	TiCN designation H5088006
M 1,6	0,35	1,2	0,7	5,325	0,74	38	10	3	3	-M1,6	-M1,6
M 2	0,4	1,55	1,2	6,6	0,98	57	21	6	3	-M2	-M2
M 2,5	0,45	1,95	1,35	8,175	1,3	57	21	6	3	-M2,5	-M2,5
M 3	0,5	2,3	1,5	9,75	1,6	57	21	6	3	-M3	-M3
M 4	0,7	3,1	2,1	13,05	2,1	57	21	6	3	-M4	-M4
M 5	0,8	4	2,4	16,2	2,9	57	21	6	3	-M5	-M5
M 6	1	4,8	3	19,5	3,4	60	24	6	3	-M6	-M6
M 8	1,25	6,4	3,75	25,875	4,7	68	27	8	3	-M8	-M8

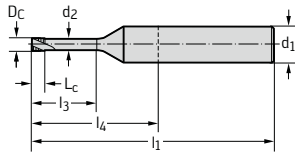

Orbital thread mill TMO



$\leq 3 \times D_N$

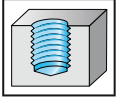

- solid carbide
- 3 cutting edges
- 15° helix angle
- materials to 48 HRC

UNC

ASME B1.1

	P	M	K	N	S	H	O
uncoated	●	●	●	●	●		●
TiCN	●	●	●	●	●		●

Tool	Threads per inch	D _c mm	L _c mm	l ₃ ±1 mm	d ₂ mm	l ₁ mm	l ₄ mm	d ₁ h6 mm	Z	uncoated designation	TiCN designation	
										H528800	H5288006	
<p>Shank DIN 6535 HA</p>	1-64 UNC	64	1,35	0,794	6,2	0,78	57	21	6	3	-UNC1	-UNC1
	2-56 UNC	56	1,6	0,908	7,25	0,95	57	21	6	3	-UNC2	-UNC2
	3-48 UNC	48	1,95	1,587	8,35	1,2	57	21	6	3	-UNC3	-UNC3
	4-40 UNC	40	2,1	1,905	9,5	1,21	57	21	6	3	-UNC4	-UNC4
	8-32 UNC	32	3,25	2,381	13,7	2,15	57	21	6	3	-UNC8	-UNC8
	6-32 UNC	32	2,6	2,382	11,75	1,5	57	21	6	3	-UNC6	-UNC6
	10-24 UNC	24	3,55	3,175	16,1	2,1	57	21	6	3	-UNC10	-UNC10
	1/4-UNC	20	4,85	3,81	21	3,11	57	21	6	3	-UNC1/4	-UNC1/4
	5/16-UNC	18	6,2	4,233	25,95	4,28	63	27	8	3	-UNC5/16	-UNC5/16

Orbital thread mill TMO



$\leq 3 \times D_N$

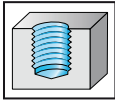

- solid carbide
- 3 cutting edges
- 15° helix angle
- materials to 48 HRC

UNF

ASME B1.1

	P	M	K	N	S	H	O
uncoated	●	●	●	●	●		●
TiCN	●	●	●	●	●		●

Tool	Threads per inch	D _c mm	L _c mm	l ₃ ±1 mm	d ₂ mm	l ₁ mm	l ₄ mm	d ₁ h6 mm	Z	uncoated designation	TiCN designation	
										H538800	H5388006	
<p>Shank DIN 6535 HA</p>	2-64 UNF	64	1,7	0,794	7,15	1,13	57	21	6	3	-UNF2	-UNF2
	3-56 UNF	56	1,95	0,908	8,25	1,3	57	21	6	3	-UNF3	-UNF3
	4-48 UNF	48	2,15	1,587	9,35	1,36	57	21	6	3	-UNF4	-UNF4
	6-40 UNF	40	2,75	1,905	11,5	1,86	57	21	6	3	-UNF6	-UNF6
	10-32 UNF	32	3,85	2,382	15,7	2,75	57	21	6	3	-UNF10	-UNF10
	1/4-UNF	28	5,25	2,721	20,45	4	57	21	6	3	-UNF1/4	-UNF1/4
	5/16-UNF	24	6,55	3,175	25,4	5,1	63	27	8	3	-UNF5/16	-UNF5/16

Thread milling cutter TMD



$$\leq 2 \times D_N$$

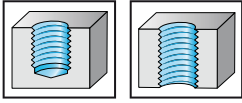

- solid carbide
- 3 cutting edges
- 27° helix angle
- drilling, countersinking and thread milling in one operation

M

DIN 13

	P	M	K	N	S	H	O
NHC				●●			
TAX			●●				

Tool	P mm	D _c mm	D _a mm	L _c mm	L _{c3} mm	d ₄ mm	L _{c1} mm	L _{c2} mm	l ₁ mm	l ₄ mm	d ₁ h6 mm	z	NHC	TAX	
													designation H5075011	designation H5075018	
Shank DIN 6535 HA	M6	1,00	5,00	4,75	11,00	14,70	6,30	13,80	1,00	62	26	8	3	-M6	-M6
	M8	1,25	6,75	6,42	13,75	18,40	8,30	17,17	1,25	74	34	10	3	-M8	-M8
	M10	1,50	8,50	8,08	18,00	23,70	10,30	22,15	1,50	80	35	12	3	-M10	-M10
	M12	1,75	10,25	9,74	21,00	27,10	12,30	25,23	1,50	90	45	14	3	-M12	-M12
	M16	2,00	14,00	13,30	30,00	37,60	16,30	35,05	1,50	102	54	14	3	-M16	-M16

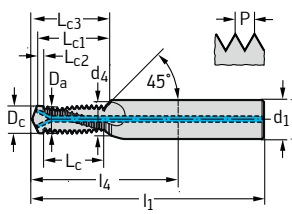

Toolholders for indexable inserts

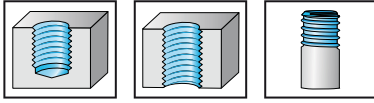

Tool

Cylindrical shank with flat acc. to DIN 1835 B

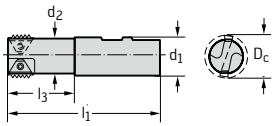
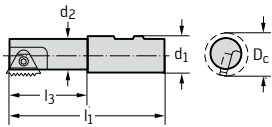

Designation	D _C mm	d ₁ mm	d ₂ mm	l ₁ mm	L ₃ mm	No. of inserts	Insert size
T9131000-16X3	15,5	16	12,2	91	20,5	1	3
T9131000-25X4	18	25	13,4	88	30	1	4
T9131000-25X5	25	25	19	98	40	1	5
T9111000-16X3	17	16	13,6	90	22	1	3
T9111000-20X3	20	20	16,6	95	43	1	3
T9111000-25X5	30	25	24	110	52	1	5
T9111000-32X5	37	32	31	120	58	1	5
T9141000-25X3	22	25	18,6	125	25	1	3
T9141000-32X5	37	32	31	160	98	1	5
T9161000-25X3	26	25	22,5	100	43	2	3

Assembly parts

Insert size	3	3	4	5
Specification	3	3M*	4	5
Clamping screw for insert	T9111030-3XT10 (Torx 10)	T9111030-3MXT10 (Torx 10)	T9111040-4XT20 (Torx 20)	T9111050-5XT25 (Torx 25)
Tightening torque	1.5 / 2.0 Nm	1.5 / 2.0 Nm	5.0 Nm	6.0 Nm

* For metric threads, toolholder T9131000-16X3.

Accessories

Insert size	3	4	5
Torx key designation	FS 1050	-	-
Screwdriver designation	-	FS 228	FS 2167
Key size	Torx 10	Torx 20	Torx 25

Thread cutting insert

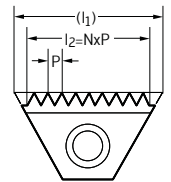

	P	M	K	N	S	H	O
TICN	●●	●●	●●	●●	●●	●	●

	Designation	Thread type	Number of cutting edges	P mm	l ₂ mm	l ₁ mm	N	Insert size
	T0192106-2.5X3	M	1	2,5	12,5	16	5	3
	T0192106-3.0X4	M	1	3	18	22	6	4
	T1192206-3.5X5	M-MF	2	3,5	24,5	27	7	5
	T1192206-4.0X5	M-MF	2	4	24	27	6	5
	T1192206-4.5X5	M-MF	2	4,5	22,5	27	5	5
	T1192206-5.0X5	M-MF	2	5	20	27	4	5
	T1291206-1.0X3	MF	2	1	15	16	15	3
	T1291206-1.5X3	MF	2	1,5	15	16	10	3
	T1291206-1.5X5	MF	2	1,5	25,5	27	17	5
	T1291206-2.0X3	MF	2	2	14	16	7	3
	T1291206-2.0X5	MF	2	2	24	27	12	5
	T1291206-3.0X5	MF	2	3	24	27	8	5
	T4691206-11X3	G, Rp	2	11	13,85	16	6	3
	T4691206-11X5	G, Rp	2	11	23,09	27	10	5
	T4691206-14X3	G, Rp	2	14	14,51	16	8	3

Selection table – Thread milling cutters with indexable inserts

Metric

P	Ø min.	max. thread depth L ₃	Toolholder	Insert	Insert size
1,0	18,0	20,5	T9131000-16x3	T1291206-1,0x3	3
	19,0	22,0	T9111000-16x3		
	22,0	43,0	T9111000-20x3		
	24,0	25,0	T9141000-25x3		
	28,0	43,0	T9161000-25x3		
1,5	18,5	20,5	T9131000-16x3	T1291206-1,5x3	3
	20,5	22,0	T9111000-16x3		
	23,5	43,0	T9111000-20x3		
	23,5	25,0	T9141000-25x3		
	29,5	43,0	T9161000-25x3	T1291206-1,5x5	5
	28,5	40,0	T9131000-25x5		
	33,5	52,0	T9111000-25x5		
	41,5	58,0	T9111000-32x5		
41,5	98,0	T9141000-32x5			
2,0	20,0	20,5	T9131000-16x3	T1291206-2,0x3	3
	21,0	22,0	T9111000-16x3		
	24,0	43,0	T9111000-20x3		
	26,0	25,0	T9141000-25x3		
	31,0	43,0	T9161000-25x3	T1291206-2,0x5	5
	20,0	20,5	T9131000-25x5		
	35,0	52,0	T9111000-25x5		
	42,0	58,0	T9111000-32x5		
42,0	98,0	T9141000-32x5			
2,5	17,5	20,5	T9111000-16x3	T0192106-2,5x3	
3,0	21,0	30,0	T9131000-25x4	T0192106-3,0x4	4
3,5	26,5	40,0	T9131000-25x5	T1192206-3,5x5	5
4,0	32,0	52,0	T9111000-25x5	T1192206-4,0x5	
4,5	37,5			T1192206-4,5x5	
5,0	43,0			T1192206-5,0x5	

Selection table – Thread milling cutters with indexable inserts

Pipe thread

P	Ø min.	max. thread depth L ₃	Toolholder	Insert	Insert size
14	18,5	20,5	T9131000-16x3	T4691206-14x3	3
	21,0	22,0	T9111000-16x3	T4691206-11x3	
	24,5	43,0	T9111000-20x3		
	28,3	25,0	T9141000-25x3		
11	30,3	20,5	T9131000-16x3		
		22,0	T9111000-16x3		
		43,0	T9111000-20x3		
		25,0	T9111000-25x3		
		25,0	T9141000-25x3		
		43,0	T9161000-25x3		
		40,0	T9131000-25x5	T4691206-11x5	
52,0	T9111000-25x5				
58,0	T9111000-32x5				

Cutting data for tapping, thread forming, and thread milling

Material group	Classification of the main material groups and code letters		Brinell hardness HB	Tensile strength R_m N/mm ²	Machining group ¹	Tapping				
						solid carbide coated	HSS-E (-PM) uncoated	HSS-E (-PM) coated		
Workpiece material						v_c [m/min]	v_c [m/min]	v_c [m/min]		
P	Unalloyed steel	C ≤ 0.25 %	annealed	125	428	P1		15	30	E
		C > 0.25... ≤ 0.55 %	annealed	190	639	P2		15	30	E
		C > 0.25... ≤ 0.55 %	tempered	210	708	P3		12,5	25	E
		C > 0.55 %	annealed	190	639	P4		15	30	E
		C > 0.55 %	tempered	300	1013	P5	45	7,5	15	E
		machining steel (short-chipping)	annealed	220	745	P6		15	30	E
	Low-alloyed steel		annealed	175	591	P7		15	30	E
			tempered	300	1013	P8	50	7,5	15	E
			tempered	380	1282	P9	35	4	7,5	E
			tempered	430	1477	P10	20	2	4	O
	High-alloyed steel and high-alloyed tool steel		annealed	200	675	P11		15	30	E
			hardened and tempered	300	1013	P12	50	7,5	15	E
			hardened and tempered	400	1361	P13	30	3	6	O
	Stainless steel		ferritic / martensitic, annealed	200	675	P14		5	10	E
			martensitic, tempered	330	1114	P15		2	4	E
M	Stainless steel	austenitic, quench hardened		200	675	M1		5	10	E
		austenitic, precipitation hardened (PH)		300	1013	M2		3	6	E
		austenitic / ferritic, duplex		230	778	M3		4	8	E
K	Malleable cast iron	ferritic		200	675	K1	40	15	30	E
		pearlitic		260	867	K2	30	10	20	E
	Grey cast iron	low tensile strength		180	602	K3	45	20	30	E
		high tensile strength / austenitic		245	825	K4	30	7,5	15	E
	Cast iron with spheroidal graphite	ferritic		155	518	K5	40	15	30	E
		pearlitic		265	885	K6	30	10	20	E
	GGV (CGI)		200	675	K7	30	10	20	E	
N	Aluminium wrought alloys	cannot be hardened		30	–	N1		10	15	E
		hardenable, hardened		100	343	N2		15	25	E
	Cast aluminium alloys	≤ 12 % Si, not hardenable		75	260	N3	50	15	20	E
		≤ 12 % Si, hardenable, hardened		90	314	N4	40	15	30	E
		> 12 % Si, not hardenable		130	447	N5	30	10	15	E
	Magnesium alloys		70	250	N6	55	20	30	O	
	Copper and copper alloys (bronze / brass)	unalloyed, electrolytic copper		100	343	N7		5	12,5	E
Brass, bronze, red brass			90	314	N8	50	25	40	E	
Cu-alloys, short-chipping			110	382	N9	40	20	35	E	
high-strength, Ampco			300	1013	N10	12,5	2,5	5	E	
S	Heat-resistant alloys	Fe-based	annealed	200	675	S1		5	7,5	E
			hardened	280	943	S2		2,5	5	E
		Ni or Co base	annealed	250	839	S3		2,5	4	E
			hardened	350	1177	S4		1,5	2	O
			cast	320	1076	S5		2	3	O
	Titanium alloys	Pure titanium		200	675	S6		7,5	7,5	E
		α and β alloys, hardened		375	1262	S7		5	7,5	O
		β alloys		410	1396	S8		2	3	O
	Tungsten alloys		300	1013	S9	7,5	2,5	5	O	
	Molybdenum alloys		300	1013	S10	15	5	7,5	O	
H	Hardened steel	hardened and tempered		50 HRC	–	H1	15			O
		hardened and tempered		55 HRC	–	H2	7,5			O
		hardened and tempered		60 HRC	–	H3	5			O
Hardened cast iron	hardened and tempered		55 HRC	–	H4	7,5			O	
O	Thermoplasts	without abrasive fillers				O1		20	20	E
	Thermosetting plastics	without abrasive fillers				O2	25	10	10	E
	Plastic, glass-fibre reinforced	GFRP				O3	15	2,5	5	E
	Plastic, carbon-fibre reinforced	CFRP				O4	15	2,5	5	E
	Plastic, aramid fibre reinforced	AFRP				O5	15	2,5	5	E
	Graphite (technical)		80 Shore				20	15	15	E

¹ The assignment of the machining groups can be found from page H 8 onwards.

Depending on application conditions, the optimum cutting data may differ from the table values by up to ± 25 %.

= Cutting data for wet machining.

E = Emulsion

O = Oil

v_c = Cutting speed

The specified cutting data are recommended values.
For special applications, adjustment is recommended.

	Thread formers				Thread milling cutters (TMD)			Drilling thread milling cutters
	solid carbide coated	HSS-E (-PM) uncoated	HSS-E (-PM) uncoated		uncoated	coated	tooth feed matrix	drilling feed
	v_c [m/min]	v_c [m/min]	v_c [m/min]		v_c [m/min]	v_c [m/min]	f_z [mm]	f [mm/rev]
		15	30	E		140	Table A	
		15	30	E		130	Table A	
		12,5	25	E		120	Table A	
		15	30	E		110	Table A	
	45	7,5	15	E		90	Table A	
		15	30	E		120	Table A	
		15	30	E		130	Table A	
	50	7,5	15	E		80	Table A	
						60	Table A	
						50	Table A	
		15	30	E		100	Table A	
	50	7,5	15	E		70	Table A	
						50	Table A	
		5	10	E O		45	Table A	
		2	4	O		30	Table A	
		5	10	E O		45	Table B	
		3	6	O		30	Table B	
		4	8	E O		35	Table B	
	40	15	30	E		100	Table A	Table D / row 3
						80	Table A	Table D / row 3
						120	Table A	Table D / row 3
						100	Table A	Table D / row 3
	40	15	30	E		100	Table A	Table D / row 3
						80	Table A	Table D / row 3
						70	Table A	Table D / row 1
		10	15	E	1000	1000	Table C	
		15	25	E	600	700	Table C	
	50	15	20	E	300	400	Table C	Table D / row 4
	40	15	30	E	200	250	Table C	Table D / row 4
					110	140	Table C	Table D / row 2
					250	400	Table C	
		5	12,5	E	180	280	Table C	Table D / row 4
	50	25	40	E	180	280	Table C	Table D / row 4
					180	280	Table C	Table D / row 4
					180	280	Table C	Table D / row 3
		5	7,5	E			Table B	
		2,5	5	E			Table B	
		2,5	4	O		40	Table B	
		1,5	2	O		20	Table B	
		2	3	O		30	Table B	
		7,5	7,5	E	70	90	Table A	
		5	7,5	O	40	50	Table A	
		2	3	O	30	35	Table A	
						40	Table B	
						40	Table B	
						50	Table B x 0.5	
						40	Table B x 0.5	
						30	Table B x 0.5	
						40	Table B x 0.5	
					120	220	Table C	Table D / row 4
					90	110	Table C	Table D / row 4
					30	45	Table C	Table D / row 3
					30	45	Table C	Table D / row 3
					30	45	Table C	Table D / row 3
						170	Table C	

Feed tables

A Material groups ISO P and ISO K, titanium alloys

Feed per tooth f_z [mm]										
a_e [mm]*	Ø 2 mm	Ø 3 mm	Ø 4 mm	Ø 6 mm	Ø 8 mm	Ø 10 mm	Ø 12 mm	Ø 14 mm	Ø 16 mm	Ø 18 mm
0,01	0,06	0,09	0,12	0,15	0,15	0,20				
0,05	0,04	0,07	0,10	0,12	0,15	0,20				
0,1	0,035	0,05	0,08	0,10	0,15	0,20	0,20	0,20	0,20	
0,2	0,03	0,04	0,06	0,08	0,15	0,18	0,20	0,20	0,20	0,20
0,5	0,025	0,03	0,05	0,07	0,12	0,15	0,15	0,15	0,15	0,20
1	0,025	0,03	0,04	0,06	0,09	0,12	0,12	0,12	0,12	0,15
2	0,020	0,030	0,030	0,050	0,080	0,110	0,120	0,12	0,12	0,15

B Material groups ISO M and ISO H, heat-resistant alloys, tungsten alloys and molybdenum alloys

Feed per tooth f_z [mm]										
a_e [mm]*	Ø 2 mm	Ø 3 mm	Ø 4 mm	Ø 6 mm	Ø 8 mm	Ø 10 mm	Ø 12 mm	Ø 14 mm	Ø 16 mm	Ø 18 mm
0,01	0,05	0,07	0,10	0,12	0,12	0,16				
0,05	0,03	0,06	0,08	0,10	0,12	0,16				
0,1	0,028	0,04	0,06	0,08	0,12	0,16	0,16	0,16	0,16	
0,2	0,02	0,03	0,05	0,06	0,12	0,14	0,16	0,16	0,16	0,16
0,5	0,020	0,02	0,04	0,06	0,10	0,12	0,12	0,12	0,12	0,16
1	0,020	0,02	0,03	0,05	0,07	0,10	0,10	0,10	0,10	0,12
2	0,016	0,024	0,024	0,040	0,064	0,088	0,096	0,10	0,10	0,12

C Material groups ISO N and ISO O

Feed per tooth f_z [mm]										
a_e [mm]*	Ø 2 mm	Ø 3 mm	Ø 4 mm	Ø 6 mm	Ø 8 mm	Ø 10 mm	Ø 12 mm	Ø 14 mm	Ø 16 mm	Ø 18 mm
0,01	0,13	0,20	0,26	0,33	0,33	0,44				
0,05	0,09	0,15	0,22	0,26	0,33	0,44				
0,1	0,077	0,11	0,18	0,22	0,33	0,44	0,44	0,44	0,44	
0,2	0,07	0,09	0,13	0,18	0,33	0,40	0,44	0,44	0,44	0,44
0,5	0,055	0,07	0,11	0,15	0,26	0,33	0,33	0,33	0,33	0,44
1	0,055	0,07	0,09	0,13	0,20	0,26	0,26	0,26	0,26	0,33
2	0,044	0,066	0,066	0,110	0,176	0,242	0,264	0,26	0,26	0,33

D f / rev table

Feed per revolution f [mm]					
Line	M6 Ø 5.0 mm	M8 Ø 6.75 mm	M10 Ø 8.5 mm	M12 Ø 10.25 mm	M16 Ø 14.0 mm
1	0,06	0,085	0,11	0,135	0,16
2	0,08	0,09	0,1	0,11	0,12
3	0,15	0,175	0,2	0,225	0,25
4	0,2	0,225	0,25	0,275	0,3

* Radial feed in mm.









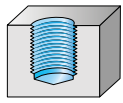

The specified feed rates are recommended values.

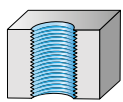
For specific applications, adjustment is recommended.

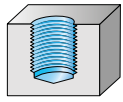
Coatings and surface treatments

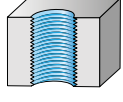

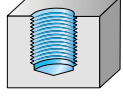
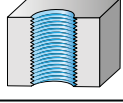

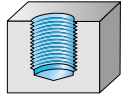





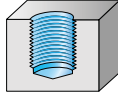

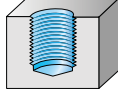
nit	<p>Nitriding improves wear resistance by increasing surface hardness.</p>
vap	<p>Vaporisation/steam treatment improves the adhesion of the cooling lubricant to prevent cold welding. Application especially in stainless steels.</p>
nid	<p>Nitriding + steam treatment extends tool life in the machining of grey cast iron.</p>
TiN	<p>Titanium nitride is currently the most widely used and its application is practically universal. By comparison with other thin layers, does not always deliver the longest tool life. Due to its chemical affinity, TiN usually offers no benefits in the machining of titanium.</p>
TiN/ vap	<p>Titanium nitride + vaporised flutes significantly improve chip formation in comparison with fully TiN-coated tools, which, particularly in conjunction with high-helix blind hole taps, is important in the production of relatively deep threads not only in steels, but also in aluminium. The TiN/vap combination is used for Paradur® Synchrospeed and Paradur® Short Chip products as standard as well as for a variety of special tools.</p>
TiCN	<p>Titanium carbon nitride is harder than TiN (approximately 3,000 HV to 2,300 HV), but slightly less thermally stable (approximately 400 to 600 °C). It is beneficial in the machining of abrasive materials. TiCN is particularly suitable for grey cast iron and AlSi alloys with an Si content higher than 5 %. Highly universal layer for thread milling.</p>
CRN	<p>Chromium nitride reduces weld formation in the case of Cu alloys and Al alloys in a similar way to hard chromium. However, it is approximately 650 HV harder and therefore has a higher wear resistance to more abrasive materials.</p>
TAFT	<p>Titanium aluminium nitride is used as part of a TAFT multilayer system on taps or, in the THL layer, as the base layer underneath the soft material layer of tungsten carbide/carbon (WC/C).</p>
ACN	<p>Aluminium chromium nitride is a titanium-free hard layer suitable not only for the machining of titanium alloys, but also for thread cutting and forming in cold extrusion steels.</p>
TAX	<p>Titanium aluminium nitride is used exclusively for thread milling. The TAX layer is used where a high degree of thermal stability is required, e.g. in the machining of hardened steels.</p>
THL	<p>Hardlube is a tried-and-tested solution for dry machining or minimum quantity lubrication. It also delivers outstanding performance in the machining of stainless steels with emulsion. THL is generally compatible with almost any kind of steel material. Chip formation is improved in comparison with TiN and TiCN, which is an important advantage particularly in the machining of relatively deep blind holes in long-chipping materials.</p>
NHC	<p>New Hard Carbon is a carbon coating having a hardness of over 5,000 HV, which makes it comparable to diamond. This coating is used primarily for composite materials and non-ferrous metals and reduces both adhesion and abrasion.</p>

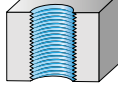
Type description

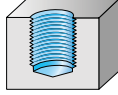
Tapping										
Type description	Blind and through hole machining	Workpiece material group						Helix angle	Thread depth	Page
		P	M	K	N	S	H			
		Steel	Stainless steel	Cast iron	NF metals	Difficult-to-machine materials	Hard materials	Other		
 <p>Paradur® Eco HT – For blind hole machining – Universal application – For particularly cost-effective wet or dry machining – Most suitable for MQL machining</p>		●●	●●	●●	●●	●	●	45°	3 x D _N	D 72
 <p>Prototex® Eco HT – For through hole machining – Universal application – For particularly cost-effective wet or dry machining – Most suitable for MQL machining</p>		●●	●●	●●	●●	●	●	0°	3,5 x D _N	D 36
 <p>Paradur® Synchrospeed – For blind hole machining – Synchronous machining at high cutting speed – Universal application – h6 shank tolerance suitable for shrink fit chucks – Weldon flat</p>		●●	●●	●●	●●		●	40°	2,5 x D _N	D 104
 <p>Prototex® Synchrospeed – For through hole machining – Synchronous machining at high cutting speed – Universal application – h6 shank tolerance suitable for shrink fit chucks – Weldon flat</p>		●●	●●	●●	●●	●●		0°	3,0 x D _N	D 55
 <p>Paradur® Eco CI – For short-chipping cast iron workpieces and aluminium alloys – Highly suited to dry or MQL machining</p>	 			●●	●●		●	0°	3,0 x D _N	D 106
 <p>Paradur® HT – For blind hole machining – For high-strength steels and short-chipping materials – Internal cooling necessary</p>		●●		●●	●		●	0°	3,5 x D _N	D 81

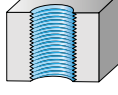

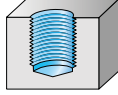

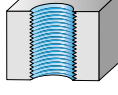



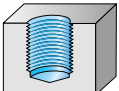
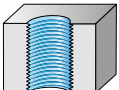

●● Primary application
 ● Additional application

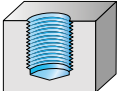
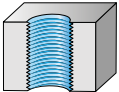
Type description

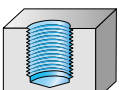
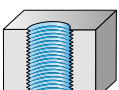
		Workpiece material group							Helix angle	Thread depth	Page
		P	M	K	N	S	H	O			
Type description	Blind and through hole machining	Steel	Stainless steel	Cast iron	NF metals	Difficult-to-machine materials	Hard materials	Other			
 <p>Paradur® WSH / WTH – For blind hole machining – In soft materials – For deep threads</p>		••		•	•				45°	3,0 x D _N (WSH) 3,5 x D _N (WTH)	D 87 D 94
 <p>Paradur® Ti – For blind hole machining – For titanium alloys and other similar types of material with emulsion – Particularly suitable for super-high-strength steels (up to 1,400 N/mm²)</p>		••			•	••			15°	2,0 x D _N	D 121
 <p>Prototex® TiNi – For through hole machining – For titanium alloys and nickel alloys and other similar types of material – With emulsion – Particularly suitable for super-high-strength steels (up to 1,400 N/mm²)</p>		••	••		•	••			0°	2,0 x D _N	D 56
 <p>Paradur® Inox® – For blind hole machining – For stainless and high-alloyed steels</p>		••	••	•					40°	2,5 x D _N	D 99
 <p>Prototex® Inox® – For through hole machining – For stainless and high-alloyed steels</p>		••	••						0°	3,0 x D _N	D 53
 <p>Paradur® HSC / solid carbide – For blind hole machining in steel materials up to 55 HRC</p>		••		••	••		••		15°	2,0 x D _N	D 125
 <p>Prototex® HSC / solid carbide – For through hole machining in steel materials</p>		••		••					0°	2,0 x D _N	D 71

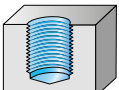
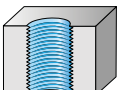

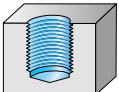
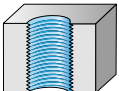

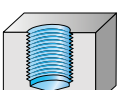





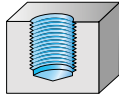
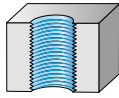

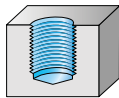
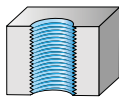
•• Primary application
 • Additional application

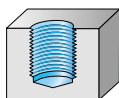
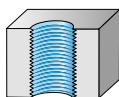
Type description

		Workpiece material group							Thread depth	Page	
		P	M	K	N	S	H	O			
Type description		Blind and through hole machining	Steel	Stainless steel	Cast iron	NF metals	Difficult-to-machine materials	Hard materials	Other		
 <p>Protodyn® S Eco plus – High-tech thread former for universal application – With lubrication grooves – Variants available with internal coolant supply and radial or axial exit – Suitable for MQL machining</p>	 	••	••		••	•				3,5 x D _N	D 333
 <p>Protodyn® S Plus – Thread formers for universal application – With lubrication grooves</p>	 	••	••		••	•				3,5 x D _N	D 345
 <p>Protodyn® S Synchro speed – High-tech thread formers for universal application – Specially developed for synchronous machining at high cutting speed – h6 shank tolerance suitable for shrink fit chucks – Weldon flat</p>	 	••	••		••	•				3,5 x D _N	D 340
 <p>Protodyn® S Eco Inox – Specially developed for stainless steels – With lubrication grooves – Compatible with oil and emulsion</p>	 	••	••		••	•				3,5 x D _N	D 338
 <p>Protodyn® Eco LM – For soft materials with tendency to act as lubricant – Without lubrication grooves</p>	 	•			••	••				2,0 x D _N	D 339
 <p>Protodyn® S / solid carbide – For universal application – With lubrication grooves and internal cooling – High cutting speed</p>		••	•		••	•				3,5 x D _N	D 350

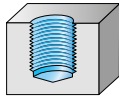
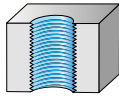
•• Primary application
 • Additional application

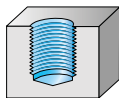
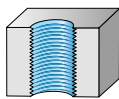
Type description

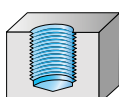
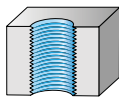
		Blind and through hole machining	Workpiece material group							Helix angle	Thread depth	Page	
			P	M	K	N	S	H	O				
Type description			Steel	Stainless steel	Cast iron	NF metals	Difficult-to-machine materials	Hard materials	Other				
	TMC thread mill – With countersink for universal application	 	••	••	••	••	••		•	27°	2,0 x D _N	D 378	
	Thread milling cutter – Without countersink – With 10° and 27° helix angles for universal application	 	••	••	••	••	••		•	10°/27°	2,0 x D _N	D 371	
	Thread milling cutter Ni 27 – Primary application on titanium alloys and nickel alloys	 	•	•	•	•	••		•	27°	1,5 x D _N	D 372	
	Thread milling cutter 20 – For external threads		••	••	••	••	••		•	20°	2,0 x D _N	D 373	
	TMD thread milling and drilling cutter – For aluminium and grey cast iron machining	 			••	••				27°	2,0 x D _N	D 391	
	TMO orbital thread mills – For universal application in machining of small and deep threads	 	••	••	••	••			•	15°	2,0 x D _N 3,0 x D _N	D 388	
	TMO HRC orbital thread mills – For small and deep threads in hard materials up to 65 HRC	 	••					•	••	•	15°	2,0 x D _N	D 386

•• Primary application
• Additional application

Application information

Basic types of taps

Blind hole

Blind hole – short-chipping materials

Straight-fluted taps do not transport chips out of the hole. For this reason, they are suitable only for short-chipping materials or for cutting short threads.

Used for blind hole and through hole threads with 2–3 pitch chamfer length.

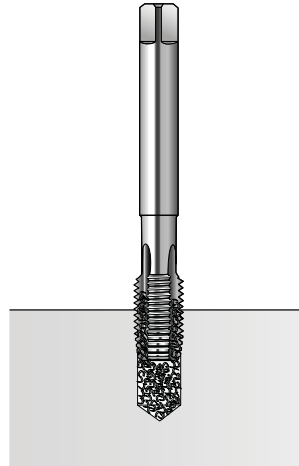

Blind hole – long-chipping materials

Right-handed-helix taps transport the chip in the direction of the shank. The tougher the workpiece material (producing longer chips) and the deeper the thread, the greater the helix angle required.

Used for blind hole machining in long-chipping materials.

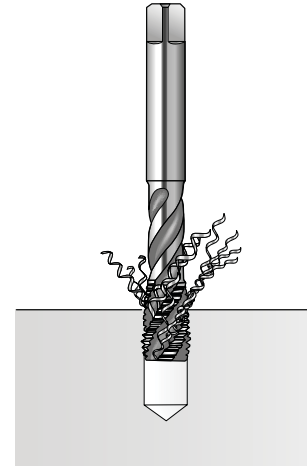

Through hole

Through hole – chip removal in feed direction

Taps with a spiral point (form B) or left-hand spiral convey the chips forward in the feed direction.

Used for through hole machining in long-chipping materials.

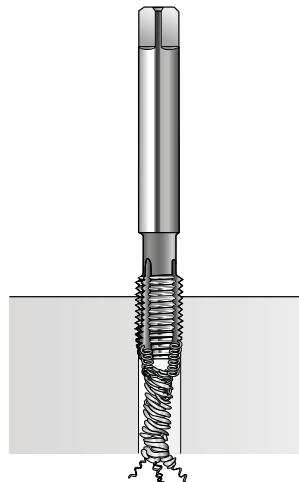

Through hole – long-chipping materials

Taps with a spiral point (form B) or left-hand spiral convey the chips forward in the feed direction.

Used for through hole machining in long-chipping materials.

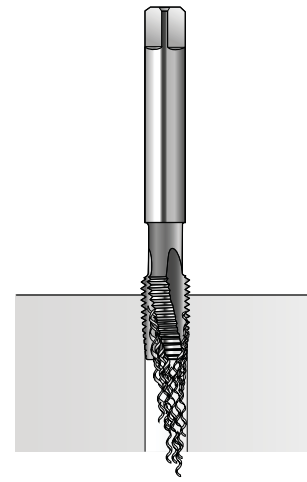

Application information

Thread cutting process

Blind hole

Blind hole shearing process



1. The tap has been cutting and now comes to a stop. At this very moment, all cutting edges in the chamfer are still in the process of forming a chip.

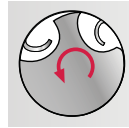

2. The tool begins to reverse. The chips remain where they are for the time being. The reverse torque at this point is virtually zero.



3. The chips come into contact with the back of the trailing land of the tap. The reverse torque now increases sharply. The chip has to be shorn off. As the chamfer of the tap has a clearance angle and the conical chamfer withdraws from the thread axially when it backs out of the hole, it is inevitable that the purchase point will no longer be directly at the root of the chip. For this reason, the chip would require a certain amount of stability (thickness) to be cut. As a result, taps having a long chamfer are not suitable for use in blind hole cutting because of their greater chamfer angle. If a tap such as this were used, there would be a risk of the too thin chip not being shorn off, but simply flattened and becoming trapped between the chamfer and the thread. This could lead to spalling in the chamfer and, in extreme cases, tap breakage.



4. The chip has been shorn off and reverse torque decreases to just the friction between the guidance portion and the cut thread.

Blind hole

Torque curve during the blind hole thread tapping process

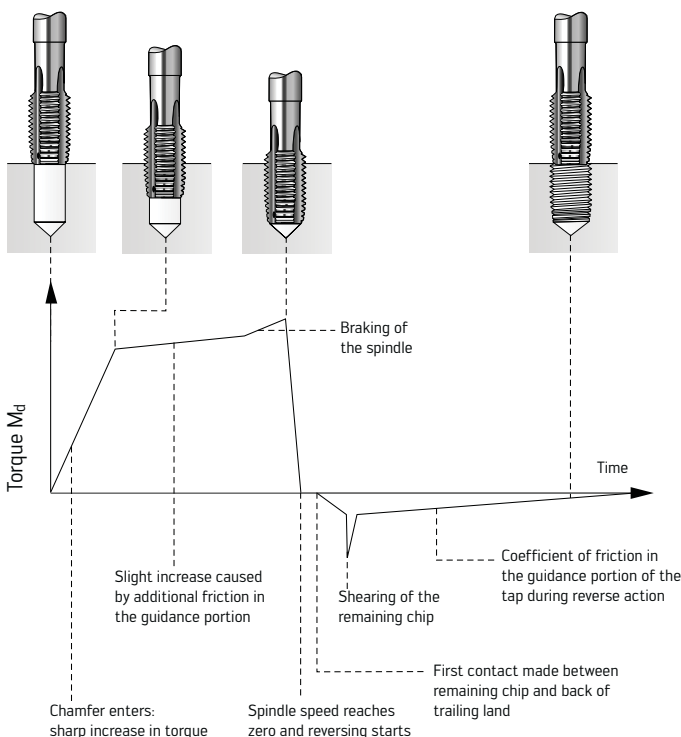

Please note:

The shearing of the chip in the blind hole thread presents a particular problem. If the chip becomes too thin, it simply flattens and can no longer be cut through. Instead, it becomes trapped between the component and chamfer flank face. Long chamfers (form A, D or B) and high chamfer clearance angles are therefore unsuitable for tapping blind hole threads.

Application information

Clearance angle

Chamfer clearance angle

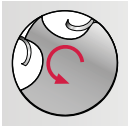

Blind hole taps have a small chamfer clearance angle because they need to shear off the chip root when they reverse.



Through-hole taps (spiral point) have a larger chamfer clearance angle than blind hole taps.

Due to its greater chamfer clearance angle, a spiral point tap should be able to cut straight through the through hole.

Example

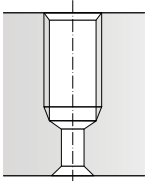

Blind hole tap required because chip has to be transported in opposite direction to feed direction.

No secondary operations required.

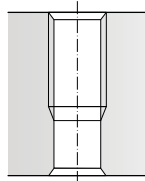

Through-hole taps possible, but only with reduced chamfer clearance angle because of need to shear off chip root.

Secondary operations required.

Thread clearance angle

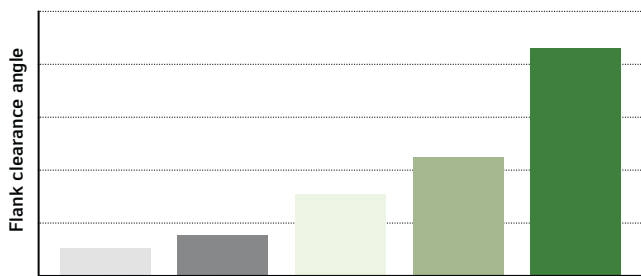

It should be possible for a tap to turn easily into the cut thread without it causing further abrasion.

If this is not possible, a tool with a greater clearance angle should be selected.

Paradur® WSH, Paradur® WTH

Prototex® H, Paradur® N

Prototex® Inox®, Paradur® Inox®

Prototex® Eco HT, Paradur® Eco HT

Prototex® Synchronspeed, Paradur® Synchronspeed

Application information chamfer forms

Form	Number of threads in the chamfer	Design of the flutes	Used predominantly for
A	6–8 threads 	straight flute	Through holes in medium- to long-chipping materials
B	3.5–5 threads 	straight flute with spiral point	Through holes in medium- to long-chipping materials
C	2–3 threads 	straight-fluted or spiral-fluted	Blind holes in long- and medium-chipping materials and through holes in short-chipping materials
D	3.5–5 threads 	straight-fluted or spiral-fluted (15°)	Blind holes with long thread runout and through holes
E	1.5–2 threads 	straight-fluted or spiral-fluted (15°)	Blind holes with short thread runout
F	1–1.5 threads 	straight-fluted or spiral-fluted	Blind holes with very short thread runout

Please note:

Shorter chamfers produce thread depths close to the bottom of the hole.

Longer chamfers reduce the strain on the cutting edge, which becomes more significant with increasing material strength.

Longer chamfers increase the torque required.

Application information

General notes on core holes

Depth of the core hole for thread cutting/thread forming

Drilling depth \geq effective thread depth + chamfer length + safety margin

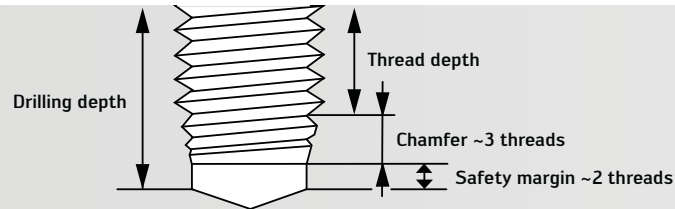

Please note:

For flat-bottomed core holes, take into consideration the type of point that the threading tool might have (external centre or external centre with reduced point).

Special notes on the core hole in thread forming

The core diameter of a thread is produced by the thread former and depends on the flow properties of the formed material. In the case of Walter Prototyp products, the guide value for the pilot hole is specified on each thread former.

The following tolerances, relative to this guide value, should be kept:

Lead	Diameter tolerance
≤ 0.3 mm	± 0.01 mm
> 0.3 mm to < 0.5 mm	± 0.02 mm
≥ 0.5 mm to < 1 mm	± 0.03 mm
≥ 1 mm	± 0.05 mm

After the forming process, it is essential to gauge the thread core diameter.

Rule of thumb: hole diameter = nominal diameter - 0.45 x lead

Example: M10 thread forming

Hole diameter = 10.0 mm - 0.45 x 1.5 mm
 = 10.0 mm - 0.675 mm
 = 9.325 mm
 = 9.3 mm

Application information

Key to colour rings

The correct use at first glance

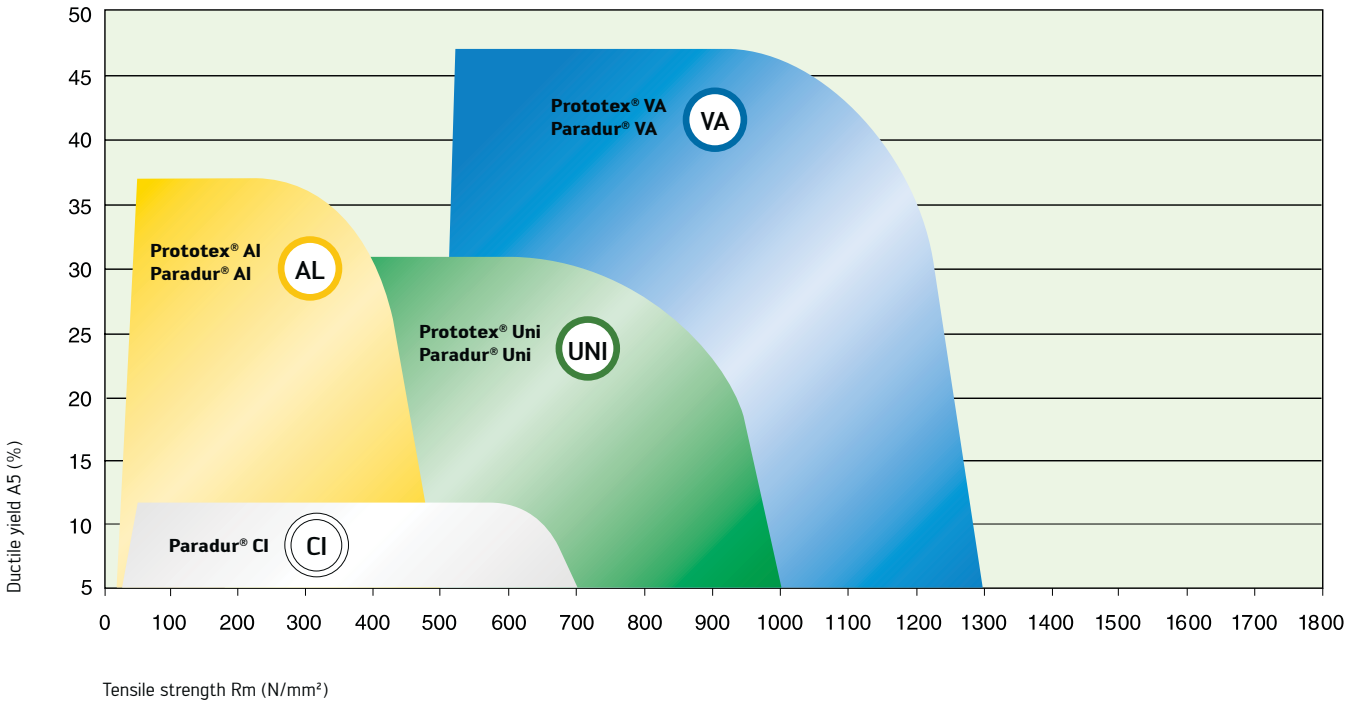

Grey cast iron (GG); brittle plastics, hard bronzes (e.g. AMPCO)



Broad material spectrum, preferably: steels to 1,000 N/mm², AlSi alloys



Al wrought alloys: electrical grade copper, soft structural steels, thermoplastics



Stainless steels, high-tensile steels up to 1,300 N/mm²; grey cast iron (GG and GGG), bronzes and brass (tough)

Application information

Cooling and lubrication

Material group	Material	Tapping	Thread forming	Thread milling
		Suitable coolant	Suitable coolant	Suitable coolant
P	Steel	Emulsion 5 %	Emulsion 5–10 %	Emulsion/MQL/air blast
	Steel 850–1,200 N/mm ²	Emulsion 5–10 %	Emulsion 10 %	Emulsion/MQL/air blast
			Oil (Protofluid)	Emulsion/MQL/air blast
	Steel 1,200–1,400 N/mm ²	Emulsion 10 %	Oil (Protofluid or Hardcut 525)	Emulsion/MQL/air blast
		Oil (Protofluid)	Emulsion 10 %	Emulsion/MQL/air blast
Steel 1,400–1,600 N/mm ² equivalent to 44–49 HRC	Oil (Protofluid or Hardcut 525)	Forming generally not possible	Emulsion/MQL/air blast	
M	Stainless steel	Emulsion 5–10 %	Oil (Protofluid)	Emulsion (main recommendation)
		Oil (Protofluid)	Emulsion 5–10 %. Only possible with relatively low leads up to 1.5 mm	Emulsion (secondary recommendation)
K	Grey cast iron GG	Emulsion 5 %	Forming not possible	Emulsion/MQL/air blast
	Ductile cast iron GGG	Emulsion 5 %	Emulsion 10 %	Emulsion/MQL/air blast
N	Aluminium up to max. 12 % Si	Emulsion 5–10 %	Emulsion 5–15 %	Emulsion/MQL/air blast
	Aluminium over 12 % Si	Emulsion 5–10 %	Emulsion 5–10 %. Forming practical only in exceptional cases	Emulsion/MQL/air blast
	Magnesium	Oil (Protofluid)	Forming not possible at room temperature	Dry
	Copper	Emulsion 5–10 %	Emulsion 5–10 %	Emulsion/MQL/air blast
S	Titanium alloys	Oil (Protofluid or Hardcut 525)	Oil (Hardcut 525)	Emulsion
		Emulsion 10 %		Emulsion
	Nickel alloys	Oil (Protofluid or Hardcut 525)	Oil (Protofluid or Hardcut 525)	Emulsion
		Emulsion 10 %		Emulsion
H	Steel >49 HRC	Oil (Hardcut 525) possible only with carbide tools	Forming not possible	Dry/MQL
O	Plastics	Emulsion 5 %	Forming does not produce dimensionally accurate threads	Emulsion/MQL

Minimum quantity lubrication (MQL)

- Most steel, aluminium and copper materials are machinable with MQL (cutting and forming).
- Use internal MQL for thread depths >1.5 x d.
- Flow rate 5 to 20 ml/h.
- MQL is not recommended for steel > 1,200 N/mm², stainless steels or titanium and nickel alloys.

Dry machining

- Thread forming: not recommended.
- Thread cutting: through hole machining in steel of low or medium tensile strength and in cast iron.

Thread milling

- MQL not recommended for aluminium wrought alloys below 4 % Si.

The thread forming method

Thread forming offers various advantages over thread cutting. For this reason, thread forming is gaining more and more importance.

Unlike thread cutting, thread forming does not produce any chips. As a result, there can be no chip-related disadvantages for the tool and its life.

In addition, no material is lost as part of the forming process. The fibre of the material is not cut through. Instead, it is compacted into the root of the thread. Consequently, formed threads have a higher pull-out strength and a very smooth surface. Compared with cutting, the higher rotational speed and feed rate deliver higher productivity.

Advantages

- Cold forming so no chips
- Deep thread down to $4 \times d$ possible as standard, no chip-removal problems
- Better thread surface, significantly less roughness in the flanks than with thread cutting
- Approximately 20 % greater pull-out strength under static load thanks to cold work hardening of the thread flanks and in the root of the thread
- More than double the fatigue strength under dynamic load thanks to cold work hardening and uninterrupted fibre flow
- Maximum possible machining reliability thanks to highly stable tools with large core cross section and no flutes
- Significantly longer tool life than with taps due to rounded thread profile with no cutting edges
- Universal use in a broad material spectrum.
Around 65 % of all machined materials in industry are formable

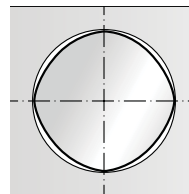

Thread forming

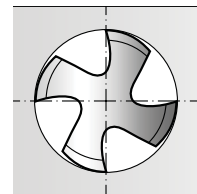

Thread cutting

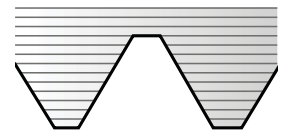
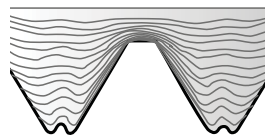

Please note:

- Discontinuity/incompleteness
An incompletely formed thread root or lead-in can cause problems during automatic screwing and in the cleaning of threads
- Higher torque, approximately 30 % higher in comparison to thread tapping

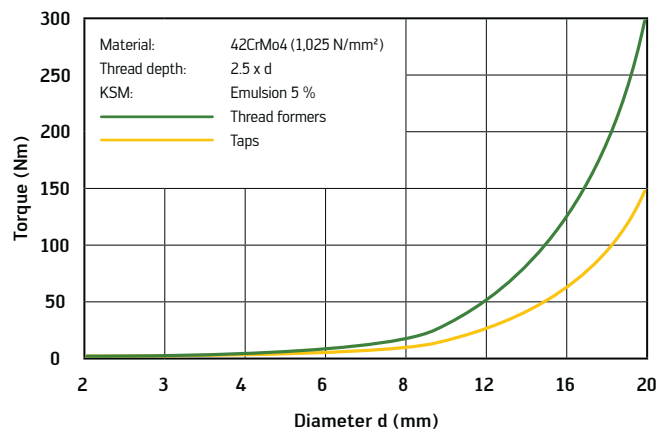

Synchronous machining

To reduce process times in threading operations, manufacturers are increasingly favouring higher rotation speeds and cutting speeds (HSC). For high cutting speeds especially, the synchronous machining approach is recommended.

The **Synchrospeed** tool range from Walter Prototyp has been optimised specifically for this particular process. The key characteristics of these tools are their extremely high clearance, their extra short threaded part and their sharp cutting edges.

While Synchrospeed threading tools have been developed exclusively for synchronous applications, ECO threading tools can be used for both rigid and conventional tapping.

Synchronous tapping requires a machine that can synchronise the rotary motion of the main spindle with the feed motion. This is usually a standard feature on today's machining centres. Synchronous taps are compatible with conventional

Weldon chucks as well as collet chucks (where possible with square drive). Both fixtures have the disadvantage of being unable to compensate for the axial forces that are generated.

A better alternative is the Protoflex C tapping chuck with minimum compensation. Protoflex C is a tapping chuck for machining centres with synchronous control logic. It guarantees a precisely defined minimum compensation and is matched to the geometry of Synchrospeed tools.



Protoflex C
synchronous tapping chuck

For order documentation, see page G 96.

The special features of Protoflex C

Unlike all other known tapping chucks, the Protoflex C design is based on a precision-machined flexor with high spring rate, which compensates both radially and axially for microscopic deflections. The patented microcompensator is made from a special alloy originally developed for NASA. The conventional synchro chucks on the market use plastic parts for this purpose, but these lose their flexibility over time, at which point they are no longer able to provide microcompensation.

The Protoflex C helps to reduce considerably the pressure forces that act on the flanks of the tap. This results in:

- improved surface quality on the flanks of the cut thread.
- greater process reliability thanks to the reduced risk of fracture, particularly where dimensions are small.
- a longer tool life due to less friction.
- maximum utilisation of machine power.



Flexor with
minimum compensation

Thread milling strategies

TM thread milling

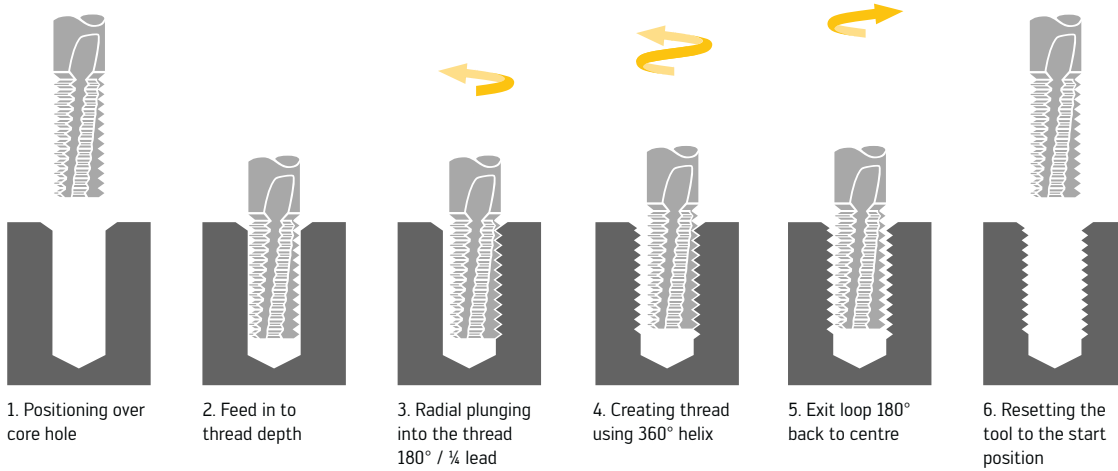

TMC thread milling

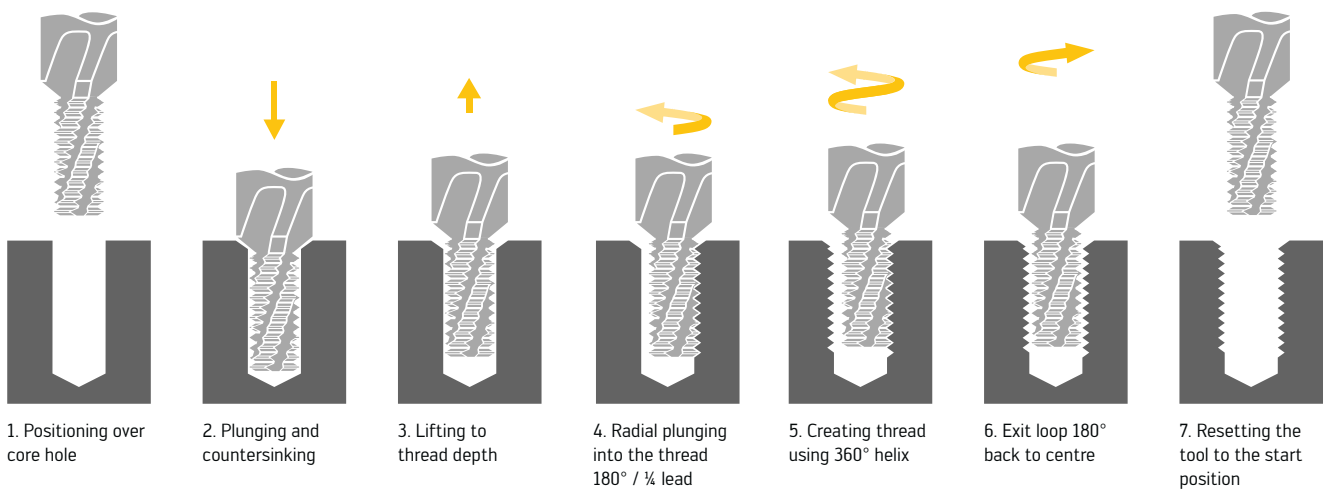

Milling of external threads

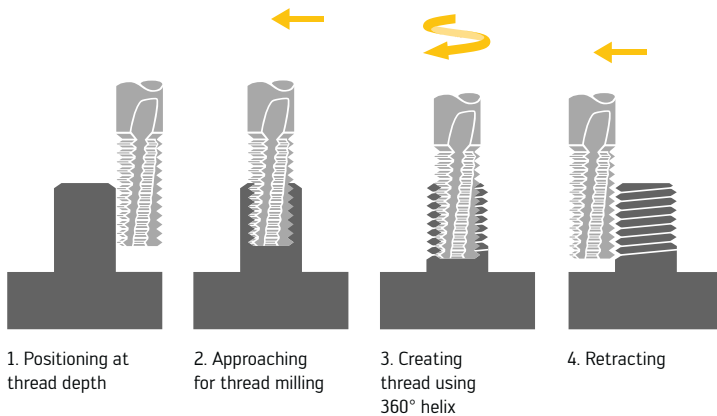

Thread milling strategies

TMD thread milling cutter with countersink

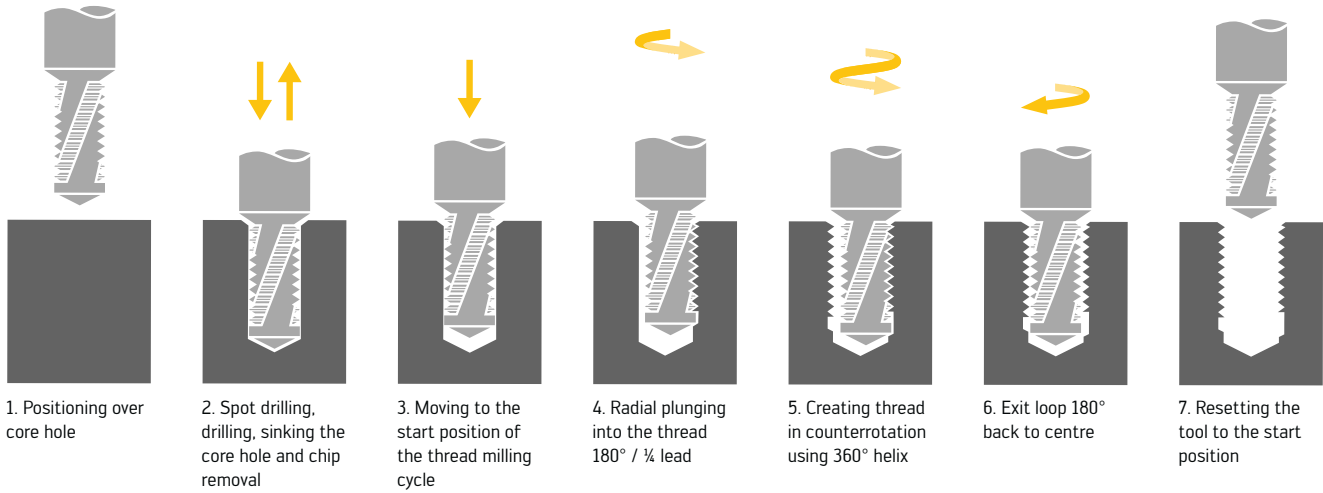

Tapered thread milling

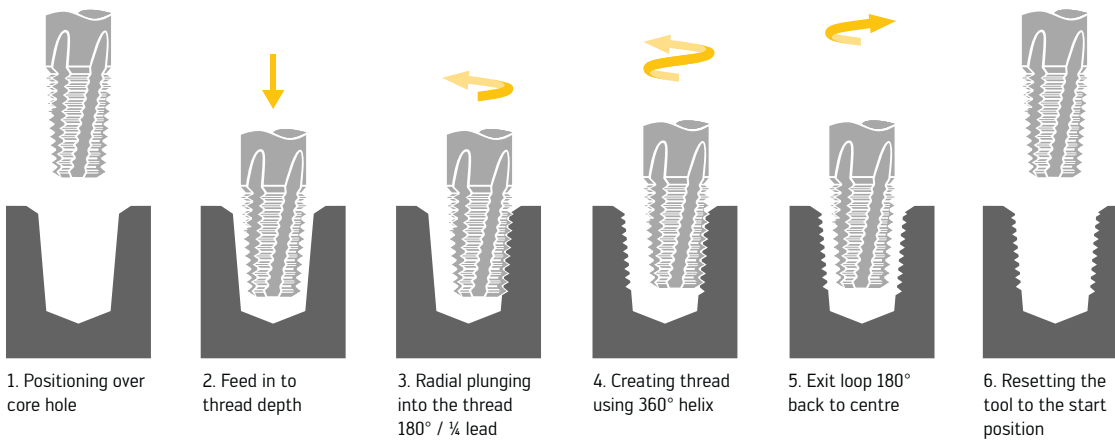

Thread milling with indexable inserts

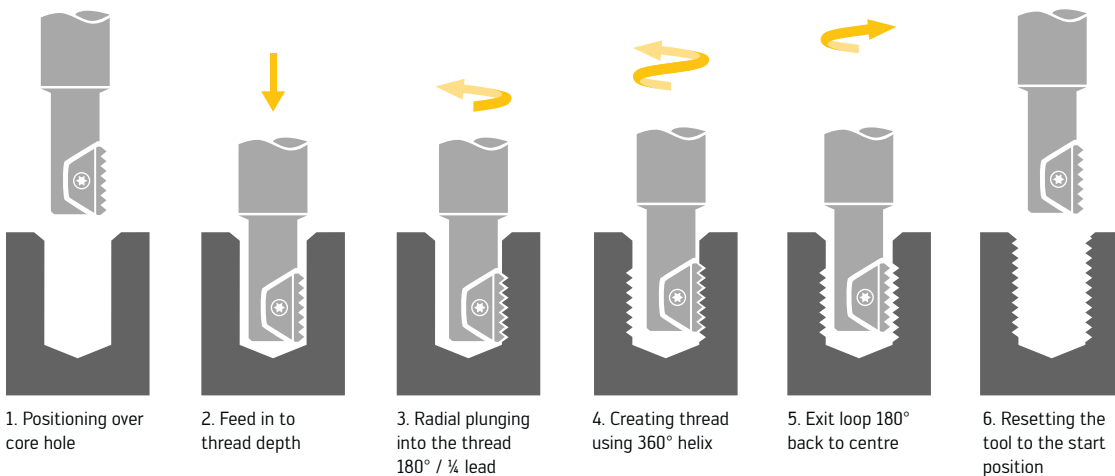

Operations 2 – 5 repeated until thread depth reached.

Thread milling strategies

TMO orbital thread milling

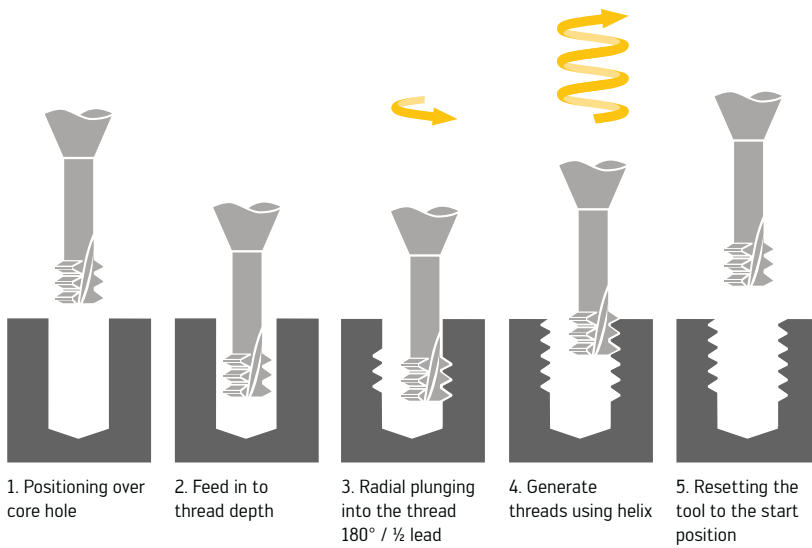

TMO HRC orbital thread milling

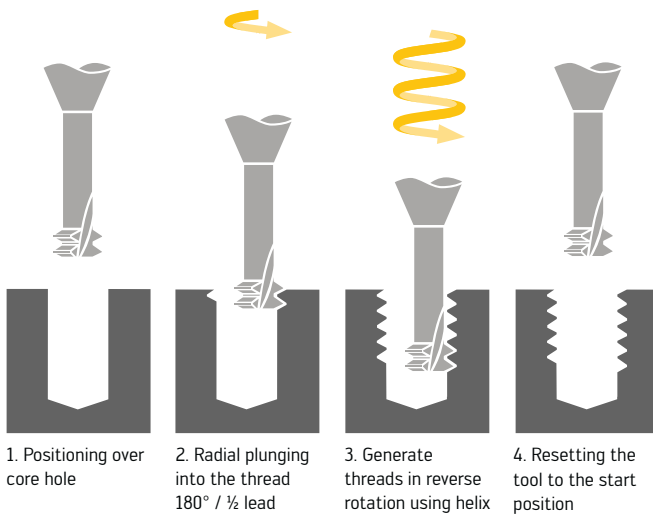

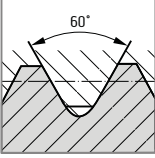
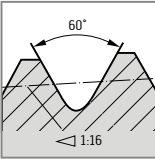
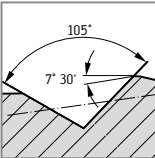

DIN thread types (excerpt from DIN 202)

Profile (diagram)	Type of thread	Symbol	Short designation ¹ Examples	Range of nominal sizes	As specified in	Application
	ISO metric screw thread (single-start or multi-start)	M	M0.8	0.3 mm to 0.9 mm	DIN 14-1 to DIN 14-4	Watches and precision engineering
			M0.8 ²⁾	1 mm to 68 mm	DIN 13-1	General purpose screw threads (coarse pitch threads)
			M24 x 4 P 2		DIN 13-52	
			M6 x 0.75 ²⁾ M8 x 1 – LH ²⁾	1 mm to 1000 mm	DIN 13-2 to DIN 13-11	To be used where pitch of coarse thread is too large (fine pitch thread)
			M24 x 4 P 2		DIN 13-52	
			M64 x 4	64 mm and 76 mm	DIN 6630	External barrel threads
			M30 x 2 – 4H5H	1.4 mm to 355 mm	LN 9163-1 to LN 9163-7 LN 9163-10 and LN 9163-11	Aerospace
ISO metric screw thread with transition tolerance (formerly interference thread)	M10 Sn 4 M10 Sk 6	3 mm to 150 mm	DIN 13-51	For screw-in ends on studs	Non-sealing	
					M10 Sn 4 sealing	Sealing
Metric screw thread with large clearance		M36	12 mm to 180 mm	DIN 2510-2	Bolted connections involving bolts with waisted shank	
ISO metric screw thread; helical coil thread for inserts		EG M	EG M20	2 mm to 52 mm	DIN 8140-2	Helical coil thread (coarse pitch and fine pitch thread) for wire thread inserts
ISO metric interference thread		MFS	MFS 12 x 1.5	5 mm to 16 mm	DIN 8141-1	For interference fit in aluminium cast alloys (coarse pitch and fine pitch thread)
	Metric tapered external screw thread	M	M30 x 2 keg	6 mm to 16 mm	DIN 158-1	Screw plugs and lubricating nipples
			M30 x 2 keg (short)			
	Tapping taper external screw thread	S	S 8 x 1	6 mm to 10 mm	DIN 71412	Taper lubricating nipples; screw threads similar to DIN 158-1 threads but with flank angle of 105°

¹ Full designations are given in the relevant standards.

² Designation in DIN ISO 965-1.

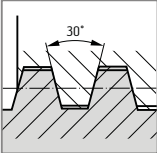
DIN thread types (excerpt from DIN 202)

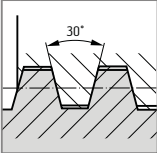
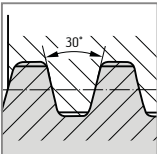
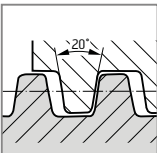
Profile (diagram)	Type of thread	Symbol	Short designation ¹ Examples	Range of nominal sizes	As specified in	Application
	ISO metric (single-start or multi-start thread) trapezoidal screw thread	TR	Tr 40 x 7	8 mm to 300 mm	DIN 103-1 to DIN 103-8	General
			Tr 40 x 14 P 7			
	Flat ISO metric (single-start or multi-start) trapezoidal screw thread		Tr 40 x 7	DIN 380-1 and DIN 380-2		
			Tr 40 x 14 P 7			
	Trapezoidal (single-start or two-start) screw thread with clearance	Tr 48 x 12	48 mm	DIN 263-1 and DIN 263-2	Rail vehicles	
		Tr 40 x 16 P 8	40 mm			
		Tr 32 x 1.5	10 mm to 56 mm	DIN 6341-2	Drawback collets	
	Rounded trapezoidal screw thread	Tr 40 x 5	26 mm to 80 mm	DIN 30295-1 and DIN 30295-2	Rail vehicles	
	Trapezoidal thread	KT	KT 22	10 mm to 50 mm	DIN 6063-2	Plastic containers

¹ Full designations are given in the relevant standards.

DIN thread types (excerpt from DIN 202)

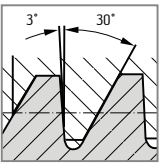
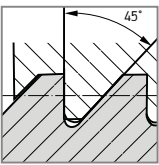
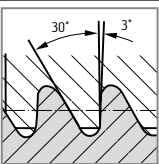
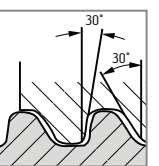
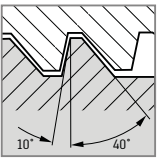
Profile (diagram)	Type of thread	Symbol	Short designation ¹ Examples	Range of nominal sizes	As specified in	Application
	Metric (single-start or multi-start) buttress thread	S	S 48 x 8	10 mm to 640 mm	DIN 513-1 to DIN 513-3	To absorb forces acting in one direction
			S 40 x 14 P 7			
	45° buttress thread		S 630 x 20	100 mm to 1250 mm	DIN 2781	Hydraulic presses
	Buttress thread		S 25 x 1.5	6 mm to 40 mm	DIN 20401-1 and DIN 20401-2	Mining
			S 22	10 mm to 50 mm	DIN 55525	Plastic and glass containers in packaging
		GS	GS 22			
		KS	KS 22			
			KS 22	10 mm to 50 mm	DIN 6063-1	Plastic containers in packaging

¹ Full designations are given in the relevant standards.

DIN thread types (excerpt from DIN 202)

Profile (diagram)	Type of thread	Symbol	Short designation ¹ Examples	Range of nominal sizes	As specified in	Application	
	Parallel (single-start or multi-start) knuckle thread	Rd	Rd 40 x 1/6 Rd 40 x 1/3 P 1/6	8 mm to 200 mm	DIN 405-1 and DIN 405-2	General	
	Parallel knuckle thread		Rd 40 x 5	10 mm to 300 mm	DIN 20400	Mining: with increased bearing depth	
	Parallel knuckle thread with clearance	Rd	Rd 59 x 7	34 mm to 79 mm	DIN 262-1 and DIN 262-2	Rail vehicles	
			Rd 59 x 7 left-hand				
	Parallel knuckle thread	Rd	Rd 50 x 7	50 mm	DIN 264-1 and DIN 264-2	Rail vehicles	
			Rd 50 x 7 left-hand				
	Parallel knuckle thread	Rd	Rd 40 x 1/7	40 mm 80 mm and 110 mm	DIN 3182-1	Respiratory equipment	
		BH	GL 25 x 3	8 mm to 40 mm	DIN 168-1	Glass containers	
	Edison thread	E	E 27	14 mm 16 mm 18 mm 27 mm 33 mm	DIN 40400	D-type fuses; E 14 and E 27 screw threads also for lamp caps and holders	
			E 5	5 mm			DIN EN 60061-1
			E 10	10 mm			
			E 40	40 mm			
		-	28 x 2	28 mm and 40 mm	DIN EN 60399	External screw threads for lamp holders and internal screw threads for lamp shade carrier rings	

¹ Full designations are given in the relevant standards.

DIN thread types (excerpt from DIN 202)

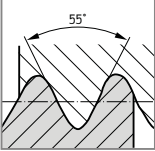
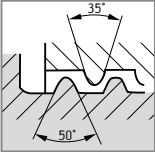
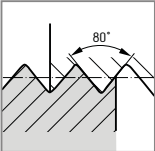
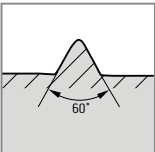
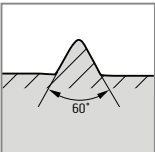
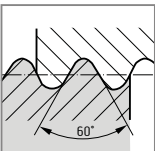
Profile (diagram)	Type of thread	Symbol	Short designation ¹ Examples	Range of nominal sizes	As specified in	Application
	Parallel Whitworth thread	W	W ³ / ₁₆	³ / ₁₆	DIN 49301	Electrical engineering: screw-in gauge rings D II and D III
	Glass screw thread	Glasg	Glasg 74.5	74.5 mm 84.5 mm 99 mm 123.5 mm 158 mm 188 mm	DIN 40450	Electrical engineering: cover glasses and caps
	Steel conduit screw thread	Pg ²⁾	Pg 21	7 mm to 48 mm	DIN 40430	Electrical engineering
	Tapping screw thread	ST	ST 3.5	1.5 mm to 9.5 mm	DIN EN ISO 1478	Tapping screws
	Wood screw thread	–	4	1.6 mm to 20 mm	DIN 7998	Wood screws
	Cycle thread	FG	FG 9.5	2 mm to 34.8 mm	DIN 79012	Bicycles and motorcycles
		–	1.375 - 24 6H/6g	1.375	DIN EN ISO 6698	Assembly of idler gears and hubs

¹ Full designations are given in the relevant standards.

² With DIN notice 04/99, it was announced that the DIN standards relating to steel conduit screw threads have been withdrawn and are superseded by metric cable glands in accordance with DIN EN 50262.

Screw threads specified in standards of other countries

Profile (diagram)	Type of thread	Code letters	Designation Examples	As specified in	Application
	Unified screw thread	UNC UNF UNEF } ²	No. 6 (0.138) - 32 UNC-2A	ASME B1.1	USA United Kingdom
		UN UNC UNF UNEF UNS	¼ - 20 UNC-2A or 0.250 - 20 UNC-2A	ASME B1.1 BS 1580	USA United Kingdom
		UNR UNRC UNRF UNREF UNRS } ¹	7/16 - 20 UNRF-2A or 0.4375 - 20 UNRF-2A	ASME B1.1	USA
		UNJ UNJC UNJF UNJEF	0.250 - 28 UNJF-3A	ASME B1.15 BS 4084	USA United Kingdom
	Whitworth thread	BSW BSF	¼ in. - 20 BSW	BS 84	United Kingdom
	B.A. thread	B.A.	11 B.A.	BS 93	

¹ External screw thread with radiused root.

² For nominal thread diameters less than below 1/4 inch.

Screw threads specified in standards of other countries

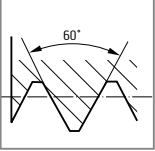
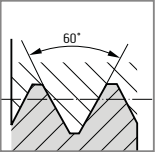
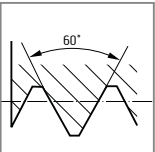
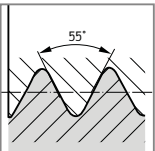
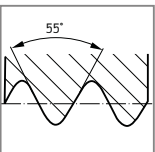
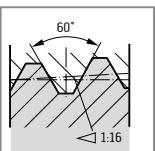
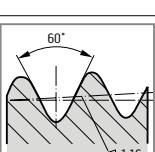
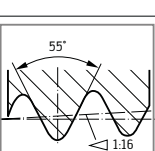
Profile (diagram)	Type of thread	Code letters	Designation Examples	As specified in	Application	
	Parallel pipe thread	NPSC	1/8 - 27 NPSC	ANSI / ASME B1.20.1	USA	
						
		NPSH NH	1/2 - 14 NPSH 3/4 - 11.5 NH	ASME B1.20.7		
		Dryseal NPSF Dryseal NPSI	1/8 - 28 NPSF	ASME B1.20.3		
		G ¹ ± PF	G 1 1/4	BS 2779		United Kingdom
		Rp ² ± PS	Rp 1/4	BS 21 ISO 7/1		
	⁴ Tapered pipe thread	NPT NPTR	3/8 - 18 NPT	ASME B1.20.1	USA	
		Dryseal NPTF Dryseal PTF-SAE- SHORT	1/8 - 27 NPTF-1 ⁵	ANSI B1.20.3		
		R ³	R 1/2	BS 21 ISO 7/1	United Kingdom	
	Rc ± PT	Rc 1/2				

¹ Substitutes symbol BSPF.

² Substitutes symbol BSPF.

³ Substitutes symbol BSPT.

⁴ Profile perpendicular to axis

⁵ -1 or -2 is thread class NPTF; -1 is gauging system **with no** gauging of bottom or point flat.

 -2 is gauging system **with** gauging of bottom or point flat (= new gauging system in accordance with ANSI B1.20.5).

Screw threads specified in standards of other countries

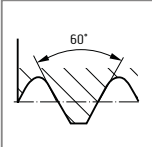
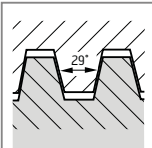
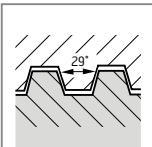
Profile (diagram)	Type of thread	Symbol	Designation Examples	As specified in	Application
	Wire thread insert	UNC-STI UNF-STI	1/4 - 20 UNC-2B-STI or 0.125 - 20 UNC-2B-STI	ASME B18.29.1	USA
	Trapezoidal thread	ACME	1 1/4 - 4 ACME-2G	ASME B1.5	USA
		Stub-ACME	0.500 - 20 STUB ACME	ANSI B1.8	USA
				BS 1104	United Kingdom

Tolerance units DIN 13 Part 15

Female thread 4H to 8H

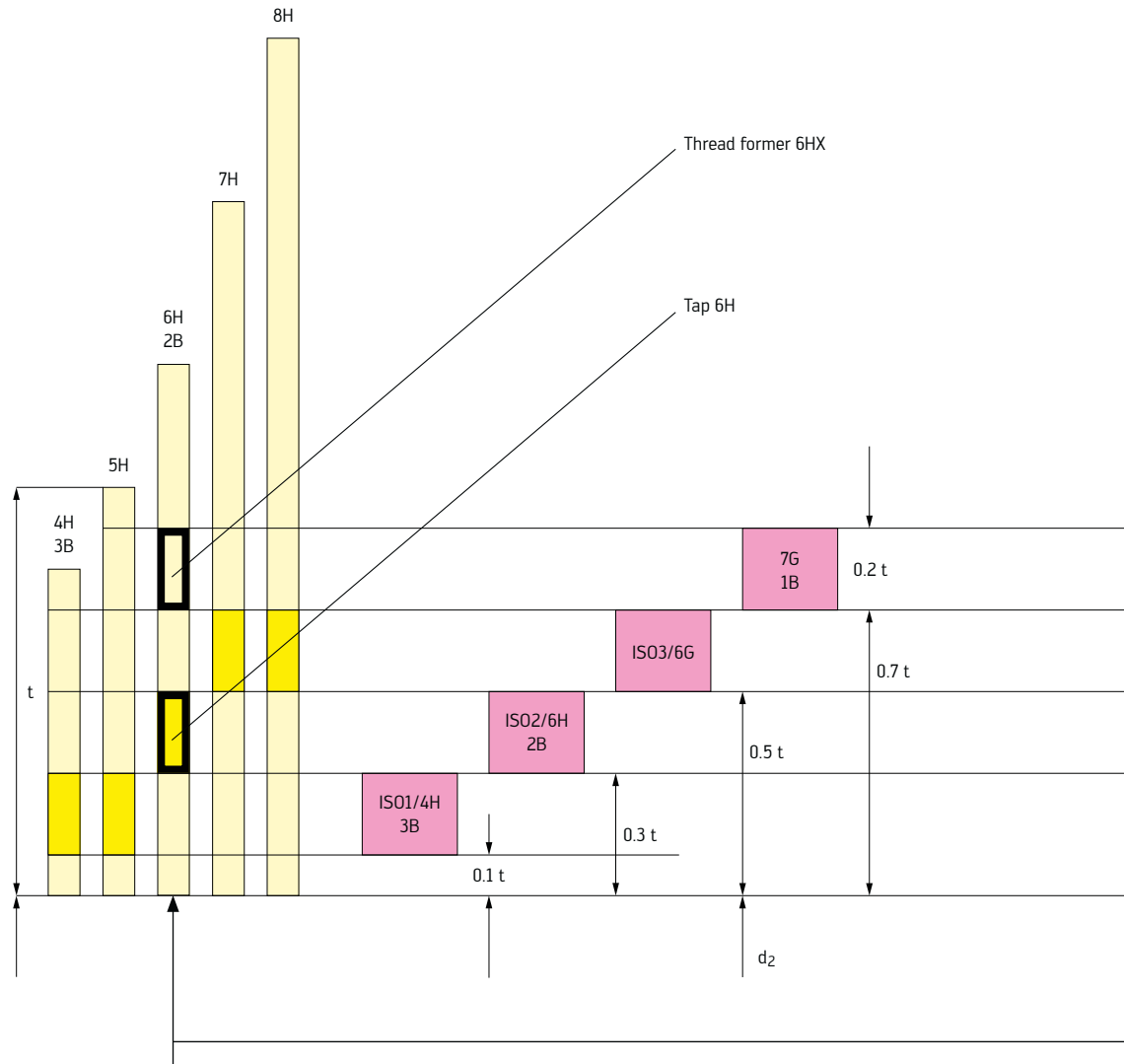

Example of thread former 6HX:

The pitch diameter of the thread former is significantly higher than that of the tap. It is also in X-position.

- Female thread
- Tap
- Oversize tap
- Thread former

Female threads 4G to 8G

d_2 = pitch diameter of the basic profile
 t = tolerance unit in accordance with DIN 13 Part 15 ANSI/ASME B1.1

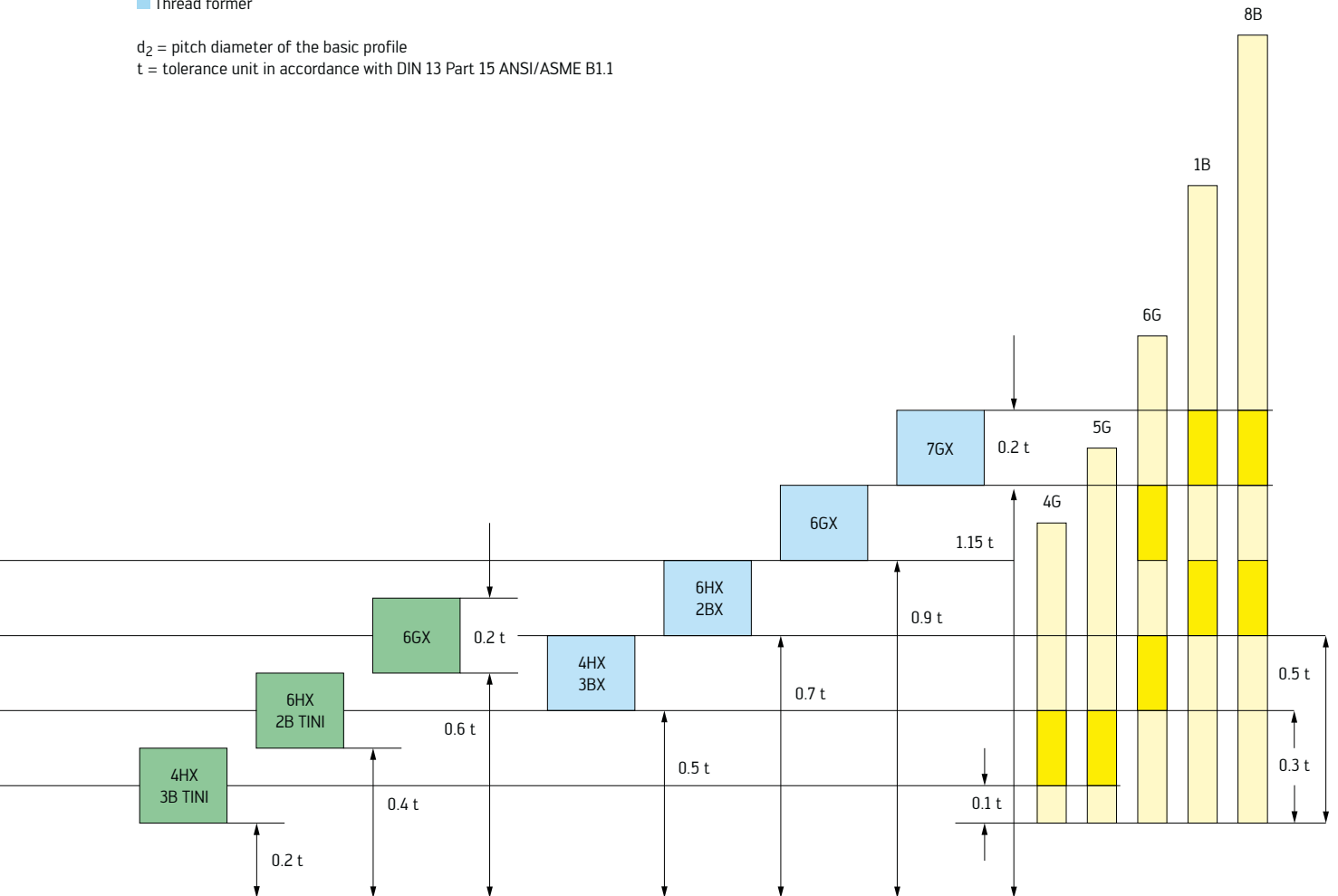

Example of tap 6H:
 The average pitch diameter for the tap is more or less in the bottom third of the tolerance range for the female thread.

Thread pilot hole diameters

Tapping

ISO metric screw thread

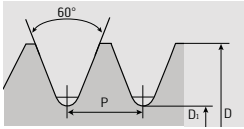

M ISO metric coarse pitch thread
DIN 13 and DIN ISO 965-1

D Ø	P mm	D ₁		 Ø mm
		min. mm	max. mm 5H/6H	
M1*	0,25	0,729	0,785	0,75
M1.1*	0,25	0,829	0,885	0,85
M1.2*	0,25	0,929	0,985	0,95
M1.4*	0,30	1,075	1,142	1,10
M1.6	0,35	1,221	1,321	1,25
M1.7	0,35	1,321	1,421	1,35
M1.8	0,35	1,421	1,521	1,45
M2	0,40	1,567	1,679	1,60
M2.2	0,45	1,713	1,838	1,75
M2.3	0,40	1,813	1,938	1,85
M2.5	0,45	2,013	2,138	2,05
M2.6	0,45	2,113	2,238	2,15
M3	0,50	2,459	2,599	2,50
M3.5	0,60	2,850	3,010	2,90
M4	0,70	3,242	3,422	3,30
M4.5	0,75	3,688	3,878	3,70
M5	0,80	4,134	4,334	4,20
M6	1,00	4,917	5,153	5,00
M7	1,00	5,917	6,153	6,00
M8	1,25	6,647	6,912	6,80
M9	1,25	7,647	7,912	7,80
M10	1,50	8,376	8,676	8,50
M11	1,50	9,376	9,676	9,50
M12	1,75	10,106	10,441	10,20
M14	2,00	11,835	12,210	12,00
M16	2,00	13,835	14,210	14,00
M18	2,50	15,294	15,744	15,50
M20	2,50	17,294	17,744	17,50
M22	2,50	19,294	19,744	19,50
M24	3,00	20,752	21,252	21,00
M27	3,00	23,752	24,252	24,00
M30	3,50	26,211	26,771	26,50
M33	3,50	29,211	29,771	29,50
M36	4,00	31,670	32,270	32,00
M39	4,00	34,670	35,270	35,00
M42	4,50	37,129	37,799	37,50
M45	4,50	40,129	40,799	40,50
M48	5,00	42,587	43,297	43,00
M52	5,00	46,587	47,297	47,00
M56	5,50	50,046	50,796	50,50
M60	5,50	54,046	54,796	54,50
M64	6,00	57,505	58,305	58,00
M68	6,00	62,505	62,305	62,00

*5H max.

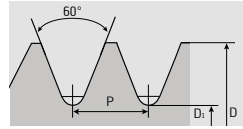

MF ISO metric fine pitch thread
DIN 13 and DIN ISO 965-1

D Ø	P mm	D ₁		 Ø mm
		min. mm	max. mm 6H	
M2 x 0.25	0,25	1,729	1,785	1,75
M2.2 x 0.25	0,25	1,929	1,985	1,95
M2.3 x 0.25	0,25	2,029	2,085	2,05
M2.5 x 0.35	0,35	2,121	2,221	2,15
M3 x 0.25	0,25	2,729	2,785	2,75
M3 x 0.35	0,35	2,621	2,721	2,65
M3.5 x 0.35	0,35	3,121	3,221	3,15
M4 x 0.35	0,35	3,621	3,721	3,65
M4 x 0.5	0,50	3,459	3,599	3,50
M4.5 x 0.5	0,50	3,959	4,099	4,00
M5 x 0.35	0,35	4,621	4,721	4,65
M5 x 0.5	0,50	4,459	4,599	4,50
M5 x 0.75	0,75	4,188	4,378	4,20
M6 x 0.5	0,50	5,459	5,599	5,50
M6 x 0.75	0,75	5,188	5,378	5,25
M7 x 0.5	0,50	6,459	6,599	6,50
M7 x 0.75	0,75	6,188	6,378	6,25
M8 x 0.5	0,50	7,459	7,599	7,50
M8 x 0.75	0,75	7,188	7,378	7,25
M8 x 1	1,00	6,917	7,153	7,00
M9 x 0.75	0,75	8,188	8,378	8,25
M9 x 1	1,00	7,917	8,153	8,00
M10 x 0.5	0,50	9,459	9,599	9,50
M10 x 0.75	0,75	9,188	9,378	9,25
M10 x 1	1,00	8,917	9,153	9,00
M10 x 1.25	1,25	8,647	8,912	8,75
M11 x 1	1,00	9,917	10,153	10,00
M12 x 0.5	0,50	11,459	11,599	11,50
M12 x 1	1,00	10,917	11,153	11,00
M12 x 1.25	1,25	10,647	10,912	10,75
M12 x 1.5	1,50	10,376	10,676	10,50
M13 x 1	1,00	11,917	12,153	12,00
M14 x 0.75	0,75	13,188	13,378	13,20
M14 x 1	1,00	12,917	13,153	13,00
M14 x 1.25	1,25	12,647	12,912	12,75
M14 x 1.5	1,50	12,376	12,676	12,50
M15 x 1	1,00	13,917	14,153	14,00
M15 x 1.5	1,50	13,376	13,676	13,50
M16 x 0.75	0,75	15,188	15,378	15,20
M16 x 1	1,00	14,917	15,153	15,00
M16 x 1.25	1,25	14,647	14,912	14,80
M16 x 1.5	1,50	14,376	14,676	14,50
M17 x 1	1,00	15,917	16,153	16,00
M18 x 1	1,00	16,917	17,153	17,00
M18 x 1.5	1,50	16,376	16,676	16,50
M18 x 2	2,00	15,835	16,210	16,00
M20 x 1	1,00	18,917	19,153	19,00
M20 x 1.5	1,50	18,376	18,676	18,50
M20 x 2	2,00	17,835	18,210	18,00
M22 x 1	1,00	20,917	21,153	21,00
M22 x 1.5	1,50	20,376	20,676	20,50
M22 x 2	2,00	19,835	20,210	20,00

Thread pilot hole diameters

Tapping

ISO metric screw thread

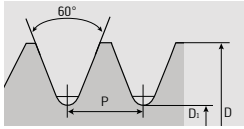

MF ISO metric fine pitch thread
DIN 13 and DIN ISO 965-1

D Ø	D ₁		 Ø mm
	min. mm	max. mm 6H	
M24 x 1.5	22,376	22,676	22,50
M24 x 2	21,835	22,210	22,00
M25 x 1	22,917	23,153	23,00
M25 x 1.5	23,376	23,676	23,50
M26 x 1.5	24,376	24,676	24,50
M27 x 1	25,917	26,153	26,00
M27 x 1.5	25,376	25,676	25,50
M27 x 2	24,835	25,210	25,00
M28 x 1.5	26,376	26,676	26,50
M28 x 2	25,835	26,210	26,00
M30 x 1	28,917	29,153	29,00
M30 x 1.5	28,376	28,676	28,50
M30 x 2	27,835	28,210	28,00
M32 x 1.5	30,376	30,676	30,50
M32 x 2	29,835	30,210	30,00
M33 x 1.5	31,376	31,676	31,50
M33 x 2	30,835	31,210	31,00
M34 x 1.5	32,376	32,676	32,50
M35 x 1.5	33,376	33,676	33,50
M36 x 1.5	34,376	34,676	34,50
M36 x 2	33,835	34,210	34,00
M36 x 3	32,752	33,252	33,00
M38 x 1.5	36,376	36,676	36,50
M39 x 1.5	37,376	37,676	37,50
M39 x 2	36,835	37,210	37,00
M39 x 3	35,752	36,252	36,00
M40 x 1.5	38,376	38,676	38,50
M40 x 2	37,835	38,210	38,00
M40 x 3	36,752	37,252	37,00
M42 x 1.5	40,376	40,676	40,50
M42 x 2	39,835	40,210	40,00
M42 x 3	38,752	39,252	39,00
M45 x 1.5	43,376	43,676	43,50
M45 x 2	42,835	43,210	43,00
M45 x 3	41,752	42,252	42,00
M48 x 1.5	46,376	46,676	46,50
M48 x 2	45,835	46,210	46,00
M48 x 3	44,752	45,252	45,00
M50 x 1.5	48,376	48,676	48,50
M50 x 2	47,835	48,210	48,00
M50 x 3	46,752	47,252	47,00
M52 x 1.5	50,376	50,676	50,50
M52 x 2	49,835	50,210	50,00
M52 x 3	48,752	49,252	49,00
M56 x 1.5	54,376	54,676	54,50
M56 x 2	53,835	54,210	54,00
M56 x 3	52,752	53,252	53,00
M58 x 1.5	56,376	56,676	56,50
M60 x 1.5	58,376	58,676	58,50
M60 x 2	57,835	58,210	58,00
M60 x 3	56,752	57,252	57,00

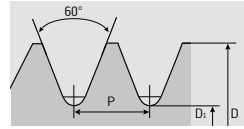

MJ Coarse pitch thread in accordance with
DIN ISO 5855

D Ø x P	D ₁		 Ø mm
	min. mm	max. mm	
MJ3 x 0.5	2,513	2,653	2,60
MJ4 x 0.7	3,318	3,498	3,40
MJ5 x 0.8	4,221	4,421	4,30
MJ6 x 1	5,026	5,215	5,10
MJ8 x 1.25	6,782	6,994	6,90
MJ10 x 1.5	8,539	8,779	8,70
MJ12 x 1.75	10,295	10,563	10,50
MJ16 x 2	14,051	14,351	14,30

Thread pilot hole diameters Tapping

ISO metric screw thread

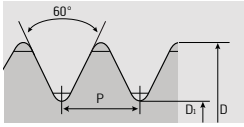

Thread insert

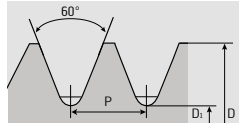

UNJC Coarse pitch thread in accordance with ASME B1.15 and ISO 3161

D Ø P threads per inch	D ₁		 Ø mm
	min. mm 3B	max. mm 3B	
No. 1-64 UNJC	1,467	1,570	1,50
No. 2-56 UNJC	1,742	1,860	1,80
No. 3-48 UNJC	1,999	2,137	2,05
No. 4-40 UNJC	2,226	2,391	2,30
No. 5-40 UNJC	2,556	2,721	2,65
No. 6-32 UNJC	2,732	2,938	2,80
No. 8-32 UNJC	3,393	3,599	3,50
No. 10-24 UNJC	3,795	4,064	3,90
No. 12-24 UNJC	4,455	4,704	4,60
1/4-20 UNJC	5,113	5,387	5,20
5/16-18 UNJC	6,563	6,833	6,70
3/8-16 UNJC	7,978	8,255	8,10
7/16-14 UNJC	9,344	9,637	9,50
1/2-13 UNJC	10,796	11,093	10,90
9/16-12 UNJC	12,226	12,480	12,30
5/8-11 UNJC	13,625	13,902	13,70
3/4-10 UNJC	16,575	16,880	16,75

EG M ISO metric coarse pitch thread in accordance with DIN 8140

D Ø	P mm	D ₁		 Ø mm
		min. mm	max. mm	
EG M 2,5	0,45	2,597	2,697	2,65
EG M 3	0,50	3,109	3,221	3,15
EG M 3,5	0,60	3,630	3,755	3,70
EG M 4	0,70	4,152	4,292	4,20
EG M 5	0,80	5,174	5,334	5,25
EG M 6	1,00	6,217	6,407	6,30
EG M 8	1,25	8,217	8,483	8,40
EG M 10	1,50	10,324	10,560	10,50
EG M 12	1,75	12,380	12,645	12,50
EG M 14	2,00	14,433	14,733	14,50
EG M 16	2,00	16,433	16,733	16,50
EG M 18	2,50	18,542	18,897	18,80
EG M 20	2,50	20,542	20,897	20,80
EG M 22	2,50	22,542	22,897	22,80
EG M 24	3,00	24,649	25,049	24,75

UNJF Fine thread in accordance with ASME B1.15 and ISO 3161

D Ø P threads per inch	D ₁		 Ø mm
	min. mm 3B	max. mm 3B	
No. 0-80 UNJF	1,215	1,297	1,25
No. 1-72 UNJF	1,510	1,602	1,55
No. 2-64 UNJF	1,797	1,900	1,85
No. 3-56 UNJF	2,073	2,191	2,10
No. 4-48 UNJF	2,329	2,467	2,40
No. 5-44 UNJF	2,613	2,763	2,70
No. 6-40 UNJF	2,886	3,051	2,95
No. 8-36 UNJF	3,479	3,662	3,60
No. 10-32 UNJF	4,053	4,253	4,15
No. 12-28 UNJF	4,602	4,815	4,70
1/4-28 UNJF	5,466	5,662	5,60
5/16-24 UNJF	6,907	7,110	7,00
3/8-24 UNJF	8,494	8,680	8,60
7/16-20 UNJF	9,875	10,083	10,00
1/2-20 UNJF	11,463	11,660	11,50
9/16-18 UNJF	12,913	13,123	13,00
5/8-18 UNJF	14,500	14,702	14,50

EG MF ISO metric fine pitch thread acc. to DIN 8140

D Ø x P	min. mm	D ₁		 Ø mm
		max. mm	Ø mm	
EG M 8 x 1	8,217	8,407	8,3	
EG M 10 x 1	10,217	10,407	10,3	
EG M 10 x 1,25	10,217	10,438	10,4	
EG M 12 x 1,25	12,217	12,438	12,4	
EG M 12 x 1,5	12,324	12,560	12,5	
EG M 14 x 1,5	14,324	14,560	14,5	
EG M 16 x 1,5	16,324	16,560	16,5	
EG M 18 x 1,5	18,324	18,560	18,5	
EG M 18 x 2	18,433	18,733	18,5	
EG M 20 x 1,5	20,324	20,560	20,5	

Thread pilot hole diameters Tapping

Thread insert

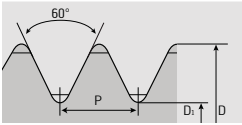

EG UNC Unified coarse threads for wire inserts

D Ø	D ₁		Ø mm
	min. mm	max. mm	
EG no. 2-56	2,282	2,441	2,35
EG no. 3-48	2,630	2,804	2,70
EG no. 4-40	2,982	3,180	3,05
EG no. 5-40	3,312	3,487	3,40
EG no. 6-32	3,677	3,879	3,70
EG no. 8-32	4,338	4,524	4,40
EG no. 10-24	5,055	5,283	5,10
EG no. 12-24	5,715	5,944	5,80
EG 1/4-20	6,625	6,868	6,70
EG 5/16-18	8,244	8,489	8,40
EG 3/8-16	9,869	10,127	10,00
EG 7/16-14	11,505	11,783	11,70
EG 1/2-13	13,123	13,393	13,30
EG 9/16-12	14,747	15,031	15,00
EG 5/8-11	16,376	16,673	16,50
EG 3/4-10	19,598	19,908	19,75

EG UNF Unified fine threads for wire inserts

Ø	D ₁		Ø mm
	min. mm	max. mm	
EG no. 2-64	2,270	2,405	2,30
EG no. 3-56	2,614	2,758	2,65
EG no. 4-48	2,962	3,122	3,00
EG no. 5-44	3,300	3,467	3,30
EG no. 6-40	3,644	3,818	3,70
EG no. 8-36	4,321	4,498	4,40
EG no. 10-32	4,999	5,184	5,10
EG 1/4-28	6,545	6,721	6,60
EG 5/16-24	8,166	8,351	8,20
EG 3/8-24	9,754	9,931	9,80
EG 7/16-20	11,387	11,585	11,40
EG 1/2-20	12,970	13,172	13,00

Miscellaneous

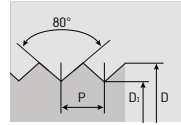

Pg Steel conduit screw thread in accordance with DIN 40 430

D Ø P threads per inch	D ₁		Ø mm
	min. mm	max. mm	
Pg 7 x 20	11,29	11,43	11,40
Pg 9 x 18	13,85	14,01	14,00
Pg 11 x 18	17,25	17,41	17,25
Pg 13,5 x 18	19,05	19,21	19,00
Pg 16 x 18	21,15	21,31	21,25
Pg 21 x 16	26,79	27,03	27,00
Pg 29 x 16	35,49	35,73	35,50
Pg 36 x 16	45,49	45,73	45,50
Pg 42 x 16	52,49	52,73	52,50
Pg 48 x 16	57,79	58,03	58,00

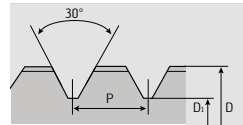

Tr ISO metric trapezoidal screw thread

D Ø x P	D ₁		Ø mm
	min. mm	max. mm	
8 x 1,5	6,5	6,69	6,60
9 x 2	7,0	7,236	7,20
10 x 2	8,0	8,236	8,20
11 x 3	8,0	8,315	8,25
12 x 3	9,0	9,315	9,25
14 x 3	11,0	11,315	11,25
16 x 4	12,0	12,375	12,25
18 x 4	14,0	14,375	14,25
20 x 4	16,0	16,375	16,25
22 x 5	17,0	17,45	17,25
24 x 5	19,0	19,45	19,25
26 x 5	21,0	21,45	21,25
28 x 5	23,0	23,45	23,25
30 x 6	24,0	24,5	24,25
32 x 6	26,0	26,5	26,25
34 x 6	28,0	28,5	28,25
36 x 6	30,0	30,5	30,25
38 x 7	31,0	31,56	31,50
40 x 7	33,0	33,56	33,50
42 x 7	35,0	35,56	35,50
44 x 7	37,0	37,56	37,50
46 x 8	38,0	38,63	38,50
48 x 8	40,0	40,63	40,50
50 x 8	42,0	42,63	42,50
52 x 8	44,0	44,63	44,50

Thread pilot hole diameters

Tapping

American screw thread

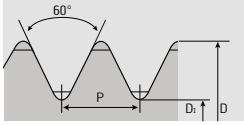

UNC Coarse thread in accordance with ASME B1.1

D Ø P threads per inch	D ₁		 Ø mm
	min. mm 2B/3B	max. mm 2B	
No. 1-64 UNC	1,425	1,582	1,55
No. 2-56 UNC	1,694	1,872	1,85
No. 3-48 UNC	1,941	2,146	2,10
No. 4-40 UNC	2,156	2,385	2,35
No. 5-40 UNC	2,487	2,697	2,65
No. 6-32 UNC	2,642	2,896	2,85
No. 8-32 UNC	3,302	3,531	3,50
No. 10-24 UNC	3,683	3,962	3,90
No. 12-24 UNC	4,343	4,597	4,50
1/4-20 UNC	4,976	5,268	5,10
5/16-18 UNC	6,411	6,734	6,60
3/8-16 UNC	7,805	8,164	8,00
7/16-14 UNC	9,149	9,550	9,40
1/2-13 UNC	10,584	11,013	10,80
9/16-12 UNC	11,996	12,456	12,20
5/8-11 UNC	13,376	13,868	13,50
3/4-10 UNC	16,299	16,833	16,50
7/8-9 UNC	19,169	19,748	19,50
1-8 UNC	21,963	22,598	22,25
1 1/8-7 UNC	24,648	25,348	25,00
1 1/4-7 UNC	27,823	28,524	28,00
1 1/2-6 UNC	33,518	34,295	34,00
1 3/4-5 UNC	38,951	39,814	39,50
2-4,5 UNC	44,689	45,598	45,00

UNF Fine thread in accordance with ASME B1.1

D Ø P threads per inch	D ₁		 Ø mm
	min. mm 2B/3B	max. mm 2B	
No. 0-80 UNF	1,181	1,306	1,25
No. 1-72 UNF	1,473	1,613	1,55
No. 2-64 UNF	1,755	1,913	1,85
No. 3-56 UNF	2,024	2,197	2,15
No. 4-48 UNF	2,271	2,459	2,40
No. 5-44 UNF	2,550	2,741	2,70
No. 6-40 UNF	2,819	3,023	2,95
No. 8-36 UNF	3,404	3,607	3,50
No. 10-32 UNF	3,962	4,166	4,10
No. 12-28 UNF	4,496	4,724	4,60
1/4-28 UNF	5,367	5,580	5,50
5/16-24 UNF	6,792	7,038	6,90
3/8-24 UNF	8,379	8,626	8,50
7/16-20 UNF	9,738	10,030	9,90
1/2-20 UNF	11,326	11,618	11,50
9/16-18 UNF	12,761	13,084	12,90
5/8-18 UNF	14,348	14,671	14,50
3/4-16 UNF	17,330	17,689	17,50
7/8-14 UNF	20,262	20,663	20,40
1-12 UNF	23,109	23,569	23,25
1 1/8-12 UNF	26,284	26,744	26,50
1 1/4-12 UNF	29,459	29,919	29,50
1 3/8-12 UNF	32,634	33,094	33,00
1 1/2-12 UNF	35,809	36,269	36,10

UNEF Extra fine thread in accordance with ASME B1.1

D Ø P threads per inch	D ₁		 Ø mm
	min. mm 2B/3B	max. mm 2B	
1/4-32 UNEF	5,491	5,679	5,55
5/16-32 UNEF	7,079	7,267	7,10
3/8-32 UNEF	8,666	8,854	8,80
7/16-28 UNEF	10,130	10,343	10,20
1/2-28 UNEF	11,718	11,931	11,80
9/16-24 UNEF	13,142	13,388	13,20
5/8-24 UNEF	14,729	14,976	14,80

UN 8-thread series in accordance with ASME B1.1

D Ø P threads per inch	D ₁		 Ø mm
	min. mm 2B/3B	max. mm 2B	
1 1/8-8 UN	25,138	25,962	25,40
1 1/4-8 UN	28,313	29,126	28,50
1 3/8-8 UN	31,488	32,123	32,00
1 1/2-8 UN	34,663	35,456	35,00
1 5/8-8 UN	37,838	38,623	38,10
1 3/4-8 UN	41,013	41,790	41,50
1 7/8-8 UN	44,188	44,957	44,45
2-8 UN	47,363	48,125	48,00
2 1/4-8 UN	53,713	54,462	54,00

Thread pilot hole diameters Tapping

American pipe thread

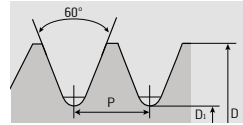
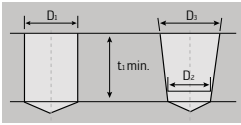

NPT American standard pipe thread in accordance with ASME B1.20.1, taper 1:16

Ø P threads per inch	D ₁ mm	D ₂ mm	D ₃	t ₁ mm
1/16-27 NPT	6,15	5,95	6,39	10,7
1/8-27 NPT	8,40	8,31	8,74	10,8
1/4-18 NPT	11,10	10,73	11,36	15,6
3/8-18 NPT	14,30	14,15	14,80	16,0
1/2-14 NPT	17,90	17,47	18,32	20,8
3/4-14 NPT	23,30	22,79	23,67	21,3
1-11 1/2 NPT	29,00	28,64	29,69	25,6
1 1/4-11 1/2 NPT	37,70	37,37	38,45	26,1
1 1/2-11 1/2 NPT	43,70	43,44	44,52	26,1
2-11 1/2 NPT	55,60	55,45	56,56	26,5
2 1/2-8 NPT	66,30	66,14	67,62	36,3
3-8 NPT	82,30	81,90	83,52	38,5

NPSM American parallel pipe thread in accordance with ASME B1.20.1

D	max. mm	Ø mm
1/8-27	9,246	9,1
1/4-18	12,217	12
3/8-18	15,545	15,5
1/2-14	19,279	19
3/4-14	24,639	24,5
1 - 11 1/2	30,759	30,5
1 1/4-11 1/2	39,497	39,5
1 1/2-11 1/2	45,568	45,5
2-11 1/2	57,607	57,5
2 1/2-8	69,266	69
3 - 8	85,166	85

NPTF American standard pipe thread in accordance with ASME B1.20.3, taper 1:16

Ø P threads per inch	D ₁ mm	D ₂ mm	D ₃	t ₁ mm
1/16-27 NPTF	6,1	5,97	6,41	10,3
1/8-27 NPTF	8,4	8,33	8,77	10,3
1/4-18 NPTF	11,0	10,77	11,40	15,0
3/8-18 NPTF	14,5	14,19	14,84	15,3
1/2-14 NPTF	17,5	17,48	18,33	19,9
3/4-14 NPTF	23,0	22,84	23,72	20,4
1-11 1/2 NPTF	29,0	28,62	29,76	24,5
1 1/4-11 1/2 NPTF	37,5	37,44	38,52	25,0
1 1/2-11 1/2 NPTF	43,5	43,50	44,59	25,0
2-11 1/2 NPTF	56,0	55,51	56,62	25,4
2 1/2-8 NPTF	66,0	66,03	67,71	38,0
3-8 NPTF	82,0	81,80	83,62	40,0

Thread pilot hole diameters

Tapping

Pipe thread

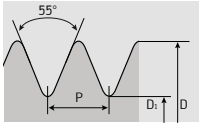

G Pipe thread in accordance with DIN EN ISO 228

D Ø P threads per inch	D ₁		 Ø mm DIN 336 / ISO 2306
	min. mm	max. mm	
G 1/16-28	6,561	6,843	6,80
G 1/8-28	8,566	8,848	8,80
G 1/4-19	11,445	11,890	11,80
G 3/8-19	14,950	15,395	15,25
G 1/2-14	18,632	19,173	19,00
G 5/8-14	20,588	21,129	21,00
G 3/4-14	24,118	24,659	24,50
G 7/8-14	27,878	28,419	28,25
G 1-11	30,292	30,932	30,75
G 1 1/8-11	34,940	35,580	35,50
G 1 1/4-11	38,953	39,593	39,50
G 1 3/8-11	41,366	42,006	41,90
G 1 1/2-11	44,846	45,486	45,25
G 1 3/4-11	50,789	51,429	51,00
G 2-11	56,657	57,297	57,00
G 2 1/4-11	62,753	63,393	63,00
G 2 1/2-11	72,227	72,867	72,60
G 3-11	84,927	85,567	85,00

BSF Whitworth fine thread in accordance with BS 84

D Ø P threads per inch	D ₁		 Ø mm
	Medium min. mm	Class max. mm	
3/16-32	3,745	4,006	4,00
7/32-28	4,394	4,677	4,60
1/4-26	5,099	5,396	5,30
5/16-22	6,459	6,817	6,70
3/8-20	7,900	8,331	8,20
7/16-18	9,306	9,766	9,60
1/2-16	10,667	11,162	11,00
9/16-16	12,255	12,750	12,60
5/8-14	13,553	14,093	14,00
3/4-12	16,340	16,941	16,80
7/8-12	19,269	19,909	19,80
1-10	22,148	22,834	22,70
1 1/8-9	24,962	25,704	25,50
1 1/4-9	28,137	28,879	28,50
1 3/8-8	30,860	31,673	31,50
1 1/2-8	34,035	34,848	34,50
1 5/8-8	37,211	38,024	37,50

Whitworth thread

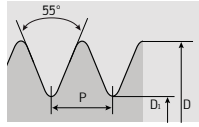

BSW Whitworth screw thread in accordance with BS 74

D Ø P threads per inch	D ₁		 Ø mm
	Medium min. mm	Class max. mm	
1/16-60	1,045	1,231	1,20
3/32-48	1,703	1,911	1,90
1/8-40	2,362	2,590	2,50
5/32-32	2,952	3,213	3,10
3/16-24	3,407	3,745	3,60
7/32-24	4,201	4,539	4,50
1/4-20	4,724	5,155	5,00
5/16-18	6,131	6,591	6,50
3/8-16	7,493	7,988	7,90
7/16-14	8,790	9,330	9,20
1/2-12	9,989	10,590	10,50
9/16-12	11,577	12,178	12,00
5/8-11	12,919	13,558	13,40
3/4-10	15,798	16,484	16,40
7/8-9	18,612	19,354	19,25
1-8	21,335	22,148	22,00
1 1/8-7	23,929	24,833	24,75
1 1/4-7	27,104	28,008	27,50
1 3/8-6	29,505	30,529	30,00
1 1/2-6	32,680	33,704	33,50
1 5/8-5	34,771	35,965	35,50
1 3/4-5	37,946	39,140	39,00
1 7/8-4 1/2	40,398	41,705	41,50
2-4 1/2	43,573	44,880	44,50
2 1/4-4	49,020	50,468	50,00
2 1/2-4	55,370	56,818	56,00

Rp Whitworth pipe thread in accordance with DIN EN 10226-1

D Ø P threads per inch	D ₁		 Ø mm DIN 336 / ISO 2306
	min. mm	max. mm	
Rp 1/16-28	6,490	6,632	6,55
Rp 1/8-28	8,495	8,637	8,60
Rp 1/4-19	11,341	11,549	11,50
Rp 3/8-19	14,846	15,054	15,00
Rp 1/2-14	18,490	18,774	18,50
Rp 5/8-14	20,446	20,730	20,50
Rp 3/4-14	23,976	24,260	24,00
Rp 1-11	30,112	30,472	30,25
Rp 1 1/4-11	38,773	39,133	39,00
Rp 1 1/2-11	44,629	45,063	45,00
Rp 2-11	56,440	56,874	56,50
Rp 2 1/2-11	72,010	72,444	72,20
Rp 3-11	84,710	85,144	85,00

Thread pilot hole diameters

Tapping

Whitworth thread

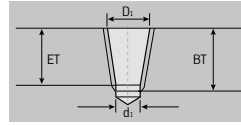
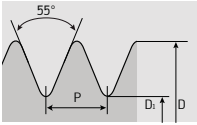

BA British Association standard thread in accordance with BS 949, Part 2

D Ø P threads per inch	P mm	D ₁		 Ø mm
		min. mm	max. mm	
BA0	1,000	4,800	5,175	5,10
BA1	0,900	4,220	4,560	4,50
BA2	0,810	3,728	4,033	4,00
BA3	0,730	3,224	3,499	3,40
BA4	0,660	2,808	3,058	3,00
BA5	0,590	2,492	2,712	2,60
BA6	0,530	2,164	2,364	2,30
BA7	0,480	1,924	2,104	2,00
BA8	0,430	1,684	1,844	1,80
BA9	0,390	1,432	1,577	1,50
BA10	0,350	1,280	1,410	1,30
BA11	0,310	1,128	1,243	1,20
BA12	0,280	0,964	1,069	1,00
BA13	0,250	0,900	0,995	0,95
BA14	0,230	0,724	0,809	0,75

Rc Tapered pipe thread, taper 1:16 in accordance with DIN EN 10226-2

Ø P threads per inch	d ₁ mm	D ₁ mm	ET mm	min. BT mm
Rc 1/16-28	6,3	6,49	8,31	10,0
Rc 1/8-28	8,3	8,50	8,31	10,1
Rc 1/4-19	11,0	11,35	12,37	15,0
Rc 3/8-19	14,5	14,85	12,77	15,4
Rc 1/2-14	18,1	18,49	16,83	20,5
Rc 3/4-14	23,5	23,98	18,13	21,8
Rc 1-11	29,6	30,11	21,42	26,0
Rc 1 1/4-11	38,1	38,78	23,72	28,3
Rc 1 1/2-11	44,0	44,67	23,72	28,3
Rc 2-11	55,6	56,48	28,02	32,6
Rc 2 1/2-11	71,1	72,00	31,32	37,1
Rc 3-11	83,6	84,71	34,42	40,2

Thread pilot hole diameters

Thread forming

M ISO metric coarse pitch thread DIN 13 and DIN ISO 965-1

Ø	P mm	 Ø mm
M1	0,25	0,88
M1.1	0,25	0,98
M1.2	0,25	1,08
M1.4	0,30	1,26
M1.6	0,35	1,45
M1.7	0,35	1,55
M1.8	0,35	1,65
M2	0,40	1,82
M2.2	0,45	2,00
M2.3	0,40	2,10
M2.5	0,45	2,30
M2.6	0,45	2,40
M3	0,50	2,80
M3.5	0,60	3,25
M4	0,70	3,70
M5	0,80	4,65
M6	1,00	5,55
M8	1,25	7,40
M10	1,50	9,30
M12	1,75	11,20
M14	2,00	13,10
M16	2,00	15,10
M18	2,50	16,90
M20	2,50	18,90
M22	2,50	20,90
M24	3,00	22,70

MF ISO metric fine pitch thread DIN 13 and DIN ISO 965-1

Ø x P	Ø mm
M4 x 0.5	3,80
M5 x 0.5	4,80
M6 x 0.5	5,80
M6 x 0.75	5,65
M7 x 0.75	6,65
M8 x 0.75	7,65
M8 x 1	7,55
M10 x 0.75	9,65
M10 x 1	9,55
M10 x 1.25	9,40
M12 x 1	11,55
M12 x 1.25	11,40
M12 x 1.5	11,30
M14 x 1	13,55
M14 x 1.5	13,30
M16 x 1	15,55
M16 x 1.5	15,30
M18 x 1	17,55
M18 x 1.5	17,30
M20 x 1.5	19,30
M20 x 2	19,10
M22 x 1.5	21,30

UNC Coarse thread in accordance with ASME B1.1

Ø P threads per inch	Ø mm
No. 2-56 UNC	1,97
No. 3-48 UNC	2,26
No. 4-40 UNC	2,55
No. 5-40 UNC	2,87
No. 6-32 UNC	3,15
No. 8-32 UNC	3,80
No. 10-24 UNC	4,30
No. 12-24 UNC	5,00
1/4-20 UNC	5,75
5/16-18 UNC	7,25
3/8-16 UNC	8,75
7/16-14 UNC	10,30
1/2-13 UNC	11,80
9/16-12 UNC	13,30
5/8-11 UNC	14,80
3/4-10 UNC	17,90

UNF Fine thread in accordance with ASME B1.1

Ø P threads per inch	Ø mm
No. 2-64 UNF	2,00
No. 3-56 UNF	2,30
No. 4-48 UNF	2,60
No. 5-44 UNF	2,90
No. 6-40 UNF	3,20
No. 8-36 UNF	3,85
No. 10-32 UNF	4,45
No. 12-28 UNF	5,05
1/4-28 UNF	5,90
5/16-24 UNF	7,45
3/8-24 UNF	9,00
7/16-20 UNF	10,50
1/2-20 UNF	12,10
9/16-18 UNF	13,70
5/8-18 UNF	15,25
3/4-16 UNF	18,40
7/8-14 UNF	21,40
1-12 UNF	24,45

Thread pilot hole diameters Thread forming

UNEF Extra fine pitch thread in accordance with ASME B1.1

Ø P threads per inch	Ø mm
1/4-32 UNEF	6,00
5/16-32 UNEF	7,60
3/8-32 UNEF	9,10
7/16-28 UNEF	10,70
1/2-28 UNEF	12,30
9/16-24 UNEF	13,80
5/8-24 UNEF	15,40
3/4-20 UNEF	18,50
7/8-20 UNEF	21,60
1-20 UNEF	24,80
3/8-24 UNF	9,00

G Pipe thread in accordance with DIN EN ISO 228

Ø P threads per inch	Ø mm
G 1/16	7,25
G 1/8-28	9,25
G 1/4-28	12,50
G 3/8-19	16,00
G 1/2-19	20,00
G 5/8-14	22,00
G 3/4-14	25,50
G 7/8-14	29,25
G 1-11	32,00

EG M ISO metric coarse pitch thread in accordance with DIN 8140

Ø	P mm	Ø mm
EG M 3	0,50	3,40
EG M 4	0,70	4,60
EG M 5	0,80	5,65
EG M 6	1,00	6,85
EG M 8	1,25	9,05
EG M 10	1,50	11,30
EG M 12	1,75	13,50

BSW Whitworth screw thread in accordance with BS 84

Ø P threads per inch	Ø mm
3/32-48	2,10
1/8-40	2,85
5/32-32	3,55
3/16-24	4,20
1/4-20	5,70
5/16-18	7,20
3/8-16	8,70
7/16-14	10,20
1/2-12	11,60
9/16-12	13,20
5/8-11	14,70
11/16-11	16,25
3/4-10	17,70
7/8-9	20,75
1-8	23,75



Milling

	Information	E 2
WALTER PROTOTYP MILLING CUTTERS MADE FROM SOLID CARBIDE, PCD AND HSS	Product range overview	E 4
	System overview for ConeFit™	E 24
	Designation key	E 25
	Walter Select – Milling	E 26
	Walter Select – Shoulder milling	E 30
	Walter Prototyp shoulder mills	E 36
	Walter Select – Shoulder/slot milling	E 58
	Walter Prototyp shoulder/slot mills	E 82
	Walter Select – Copy milling	E 186
	Walter Prototyp copy mills	E 192
	Walter Select – Profile milling	E 214
	Walter Prototyp profile mills	E 218
	Walter Prototyp ConeFit™-Set	E 229
TECHNICAL INFORMATION	Cutting data	E 230
	Feed matrices	E 274
	v_c -correction factors	E 280
	Cutting tool materials, surface treatments and coatings	E 281
	Walter Prototyp milling tool types	E 282
	Conefit™ assembly instructions	E 285
	Honeycomb tool assembly instructions	E 285
	Protostar® Flash	E 286
	Usage recommendation for copy finishing	E 287
Maximum feed angle	E 287	



Milling tools

The speciality brands Walter and Walter Prototyp have exactly the right milling cutter for you: from solid carbide mini milling cutters with a diameter of 0.3 mm to cartridge-type face mills with carbide indexable inserts and a diameter of 315 mm.

A variety of cutting tool materials, such as coated carbide, PCD, CBN or HSS, ensure coverage of a broad range of applications. Thanks to the large selection of tool types and geometries, you will always find the optimum solution to meet your different workpiece and material requirements.

1 Proto-max™_{ST}

- Solid carbide high-performance end mill, specially developed for machining steel
- Suitable for roughing with maximum metal removal rates and for finishing
- Slot milling down to $2 \times D_c$ possible

2 ConeFit™

- Modular solid carbide milling system for most accurate concentricity and providing flexibility through the widest available selection of geometries and shank variants
- Diameter range from 10 to 25 mm
- For universal use in roughing, finishing, 3D contour milling and profile milling applications

3 Xtra-tec® octagon cutters

F 4080 / F 4081

- Universal tools for face milling, circular interpolation milling, inclined ramping, pocketing and chamfering
- F 4081: special variant for circular interpolation milling with smooth bores
- Highly cost-effective thanks to 8-edge indexable insert

4 Xtra-tec® shoulder milling cutter F 4042

- Wide product selection with five insert sizes and corner radii from 0.2 to 6.0 mm
- Extremely wide range of geometries for ideal application of the tool to the respective machining assignment

5 Xtra-tec® side and face mills

F 4053 / F 4153 / F 4253

- Slitting cutters with cutting width of 4 mm; tangential side and face mills with cutting width up to 25 mm
- Tools can be equipped with just the one insert type thanks to right and left cutting edges on the same insert

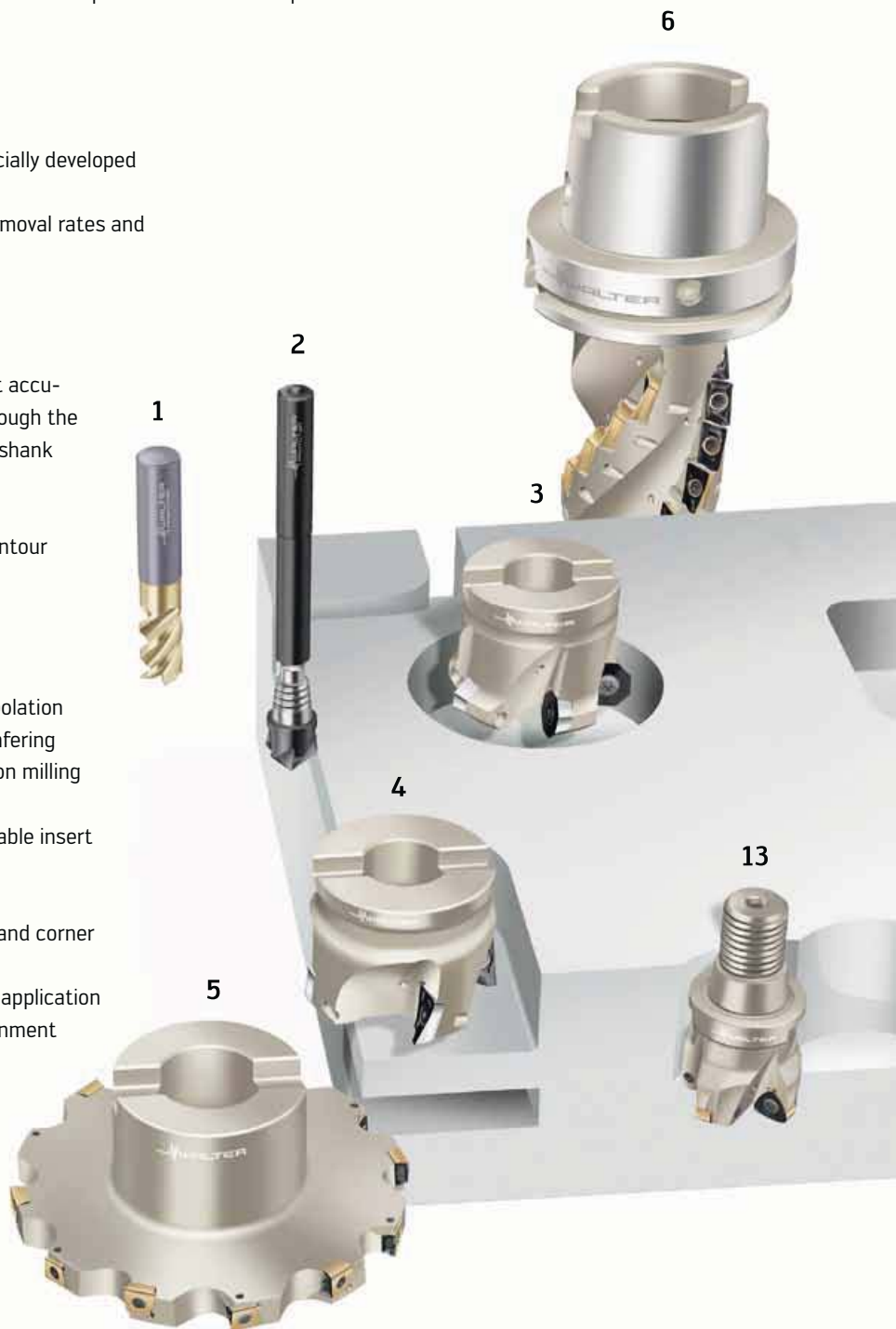

6 Xtra-tec® porcupine cutters

F 4038 / F 4138 / F 4238 / F 4338

- For use in shoulder milling and for trimming operations on an extremely wide range of materials
- Diameter range from 20 to 125 mm, cutting lengths up to 124 mm
- High machining volume, even from low-performance machines thanks to highly positive indexable inserts

7 Protostar® Tough Guys

- Highly universal and efficient solid carbide cutter for shoulder and slot milling, inclined ramping and circular interpolation milling
- Different chip clearance depths towards the end face make the tool suitable for slot and contour milling

8 Xtra-tec® face milling cutters

F 4033 / F 4047 / F 4048

- 8-edge system indexable inserts for extremely wide selection of approach angles
- Optimum productivity in face milling applications thanks to highly positive geometries combined with stable, negative indexable inserts

9 Protostar® N 40 ball-nose end mill

- Compatible with all forms in 5-axis machining applications, but also with machines with 3 axes and suitable for Z constant operations
- High-performance TAX coating

10 Protostar® N 50 multipurpose cutter

- Optimum productivity in trimming applications due to large number of teeth (6, 7 or 8)
- Optimum chip removal thanks to 50° helix angle

11 Xtra-tec® heptagon cutter F 4045

- For roughing on all cast iron workpieces
- With 14-edge indexable insert and highest pitch for maximum machined volume

12 Xtra-tec® shoulder milling cutter F 4041

- Unique indexable insert design with four cutting edges per insert and exact 90° corners on the machined shoulder
- Helical cutting edges on negative indexable inserts for soft, positive cut

13 Xtra-tec® high performance milling cutter F 4030

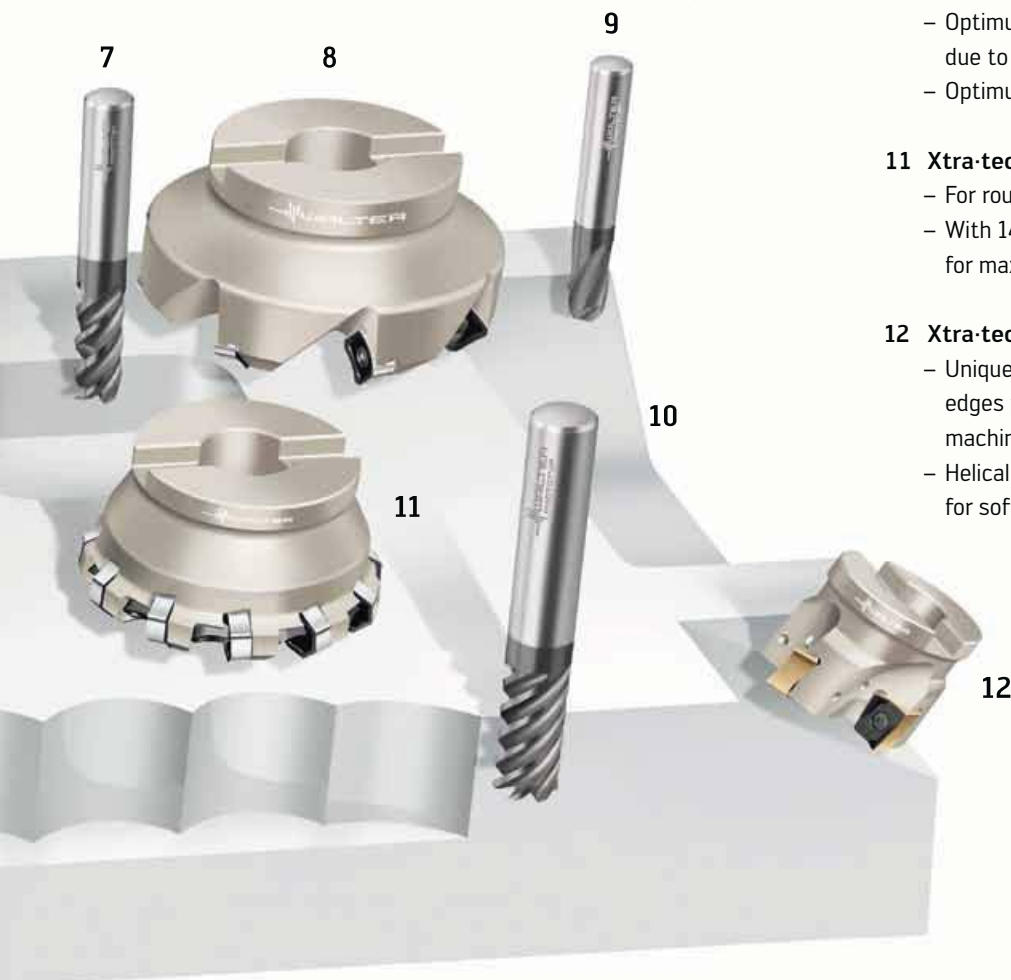

- Feeds of up to 3.5 mm/tooth possible
- Optimum productivity at the same time as optimum process reliability and a soft cut thanks to unique, negative indexable insert design





Product range overview of milling cutters for shoulder milling

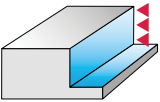
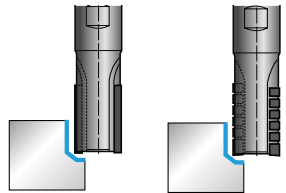



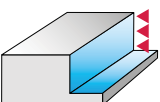
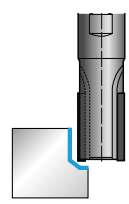

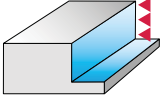
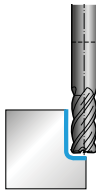
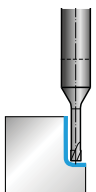

Application	Solid carbide end mills						
Helix angle	60°	50°			45°		
Designation	H3024148	H3E21138	H3021138	H8083128	H3023118	H3023418	H3023518
Shank DIN 6535 HA							
Shank DIN 6535 HB	-		-	-	H3123118	H3123418	H3123518
Type	Protostar® N 60	Protostar® N 50	Protostar® N 50	Protostar® Ultra H 50	Protostar® N 45 standard	Protostar® N 45 extra long	Protostar® N 45 extra long
Dia. range	6–20	10–25	3–25	3–25	2–25	6–20	4–25
Number of teeth	6	6+8	4–8	4–8	4+5	4+5	4–8
Standard	DIN 6527 L	ConeFit™	DIN 6527 L	DIN 6527 L; P standard L	DIN 6527 L	P standard L	P standard XL
Page	E 36	E 37	E 37	E 38	E 39	E 40	E 41

Application	Solid carbide end mills					
Helix angle	30°					
Designation	H3022018	H302211	H3022118	H3058917	H3093418	-
Shank DIN 6535 HA						
Shank DIN 6535 HB	H3122018	-	H3122118	-	-	H3178128
Type	Protostar® N 30	Protostar® N 30	Protostar® N 30	Protostar® N 30	Protostar® HSC 30	Protostar® Ultra H 30
Dia. range	2–20	2–20	2–25	8–25	6,3–16,5	5–16
Number of teeth	4	4	4	4–6	4	6–16
Standard	DIN 6527 K	DIN 6527 L	DIN 6527 L	P standard S	P standard XL	DIN 6527 L
Page	E 42	E 43	E 43	E 44	E 45	E 46









<p>Application</p> 	<p>End mills with brazed carbide cutting edges</p> 							
<p>Helix angle</p>		<p style="text-align: center;">0°</p>						
<p>Designation</p>	<p>F 1675 Shank DIN 138</p>	<p>F 1676 Shank: SK</p>	<p>F 1677 Shank DIN 228 A</p>	<p>F 1678 Shank DIN 1835 B</p>	<p>F 1682 Shank: NCT</p>	<p>F 1375 Shank DIN 138</p>	<p>F 1605 Shank DIN 228 A</p>	<p>F 1616 Shank DIN 1835 B</p>
<p>Type</p>	<p style="text-align: center;">Heli mill</p>				<p style="text-align: center;">Porcupine cutter</p>			
<p>Dia. range</p>	<p>16–100</p>	<p>16–100</p>	<p>16–100</p>	<p>16–100</p>	<p>16–100</p>	<p>16–100</p>	<p>16–100</p>	<p>16–100</p>
<p>Number of teeth</p>	<p>2–8</p>	<p>2–8</p>	<p>2–8</p>	<p>2–8</p>	<p>2–8</p>	<p>1–4</p>	<p>1–4</p>	<p>1–4</p>
<p>Page</p>	<p>E 53</p>	<p>E 55</p>	<p>E 54</p>	<p>E 54</p>	<p>E 54</p>	<p>E 53</p>	<p>E 53</p>	<p>E 53</p>
								

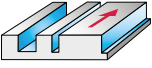
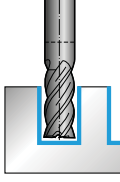





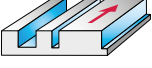
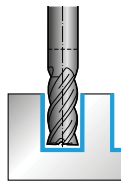

<p>Application</p> 	<p>End mills with brazed PCD cutting edges</p> 	
<p>Helix angle</p> <p style="text-align: center;">0°</p>		
<p>Designation</p>	<p>F 4722 ScrewFit / HSK / shank DIN 1835 A</p>	<p>F 4723 Shank DIN 138</p>
<p>Type</p>	<p>PCD shoulder mill</p>	<p>PCD face / shoulder mill</p>
<p>Dia. range</p>	<p>6–40</p>	<p>50–125</p>
<p>Number of teeth</p>	<p>2–5</p>	<p>5–8</p>
<p>Page</p>	<p>E 52</p>	<p>E 56</p>
		

Product range overview of milling cutters for shoulder milling









Application 	Solid carbide end mills with corner radius 				Solid carbide mini end mills with corner radius 	
Helix angle	50°		45°	30°	30°	
Designation	H3E23138	H8082228	H7073417	H8018718	H404491	H4044918
Shank DIN 6535 HB		-	-	-	-	-
Type	Protostar® N 50	Protostar® Ultra H 50	Protostar® Ti 45 extra long	Protostar® N 30	Protostar® Mini HSC 30	Protostar® Mini HSC 30
Dia. range	10–25	3–20	16–25	4–16	0,4–3	0,4–3
Number of teeth	6+8	4–8	4+5	4	2	2
Standard	ConeFit™	DIN 6527 L	P standard XL	P standard L	P standard mini	P standard mini
Page	E 47	E 48	E 49	E 50	E 51	E 51
	 					

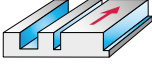
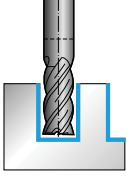







Product range overview of milling cutters for shoulder / slot milling

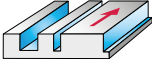
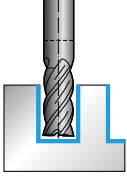





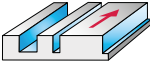
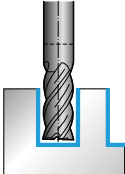

Application 	Solid carbide end mills							
	50°							
Designation	H4034217	H3021117	H3E21317	H3021317	H4021017	H4021117	H4021217	
Shank DIN 6535 HA				H3121317	H4121017	H4121117	H4121217	
Shank DIN 6535 HB	–	–						
Type	Proto-max™ _{ST}	Tough Guys N 50 long	Tough Guys N 50	Tough Guys N 50	Tough Guys N 50	Tough Guys N 50 long	Tough Guys N 50	
Dia. range	3–20	2–20	10–25	6–25	6–20	4–20	6–16	
Number of teeth	4	3+4	4+5	4+5	4	3+4	4	
Standard	P standard	P standard L	ConeFit™	DIN 6527 L	DIN 6527 L	P standard L	DIN 6527 L	
Page	E 82	E 84	E 85	E 86	E 87	E 88	E 89	
			 					

Application 	Solid carbide end mills							
	50°			45°				
Designation	H3071118	H3071318	H4033217	H3013018	H3013118	H3014018	H3014118	
Shank DIN 6535 HA								
Shank DIN 6535 HB	–	H3171318	–	–	–	–	–	
Type	Tough Guys H 50	Tough Guys H 50	Proto-max™ _{ST}	Compact N 45	Compact N 45	Compact N 45	Compact N 45	
Dia. range	2–20	6–20	2–20	2–12	2–12	2–12	2–12	
Number of teeth	3+4	4	3	3	3	4	4	
Standard	P standard L	DIN 6527 L	P standard	P standard S	DIN 6527 K	P standard S	DIN 6527 K	
Page	E 90	E 90	E 83	E 91	E 91	E 92	E 92	
								









Product range overview of milling cutters for shoulder / slot milling

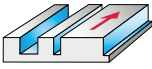
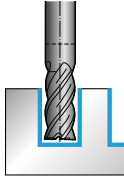







Application 	Solid carbide end mills 						
Helix angle	45°						
Designation	H3023018	H3E29148	H302914	H3029148	H6E2511	H602511	H602411
Shank DIN 6535 HA							
Shank DIN 6535 HB	–		H312914	H3129148		–	–
Type	Protostar® N 45 extra short	Protostar® 45	Protostar® 45	Protostar® 45	Protostar® Al 45	Protostar® Al 45	Protostar® Al 45
Dia. range	6–20	10–25	1–20	1–20	10–25	1–20	1–20
Number of teeth	4+5	3	3	3	2	2	2
Standard	DIN 6527 K	ConeFit™	DIN 6527 L	DIN 6527 L	ConeFit™	DIN 6527 L	DIN 6527 L
Page	E 93	E 94	E 94	E 95	E 96	E 97	E 97
							

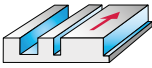
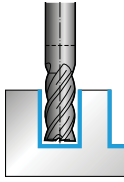





Application 	Solid carbide end mills 							
Helix angle	45°				30°			
Designation	H6E2211	H602551	H302611	H3026118	H302711	H3027118	H302731	H3027318
Shank DIN 6535 HA								
Shank DIN 6535 HB		–	–	–	–	–	–	–
Type	Protostar® Al 45	Protostar® Al 45 long	Protostar® 30	Protostar® 30	Protostar® N 30	Protostar® N 30	Protostar® N 30	Protostar® N 30
Dia. range	10–25	6–20	2–20	2–20	2–20	2–20	1–3	1–3
Number of teeth	3	2	2	2	3	3	3	3
Standard	ConeFit™	P standard L	DIN 6527 L	DIN 6527 L	DIN 6527 L	DIN 6527 L	DIN 6527 L	DIN 6527 L
Page	E 98	E 99	E 100	E 100	E 101	E 101	E 102	E 102
								



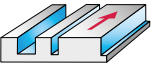
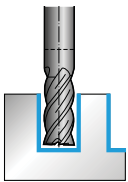



<p>Application</p> 	<p>Solid carbide end mills</p> 						
<p>Helix angle</p>	<p>30°</p>					<p>25°</p>	
<p>Designation</p>	<p>H3027418</p>	<p>H3027419</p>	<p>H3090418</p>	<p>H901411</p>	<p>H901451</p>	<p>H602641</p>	<p>H602681</p>
<p>Shank DIN 6535 HA</p>	<p>–</p>	<p>–</p>	<p>–</p>	<p>–</p>	<p>–</p>	<p>–</p>	<p>–</p>
<p>Shank DIN 6535 HB</p>	<p>–</p>	<p>–</p>	<p>–</p>	<p>–</p>	<p>–</p>	<p>–</p>	<p>–</p>
<p>Type</p>	<p>Protostar® 30 extra long</p>	<p>Protostar® 30 extra long</p>	<p>Protostar® HSC 30 long</p>	<p>AL 30</p>	<p>AL 30</p>	<p>Protostar® AL 25</p>	<p>Protostar® AL 25</p>
<p>Dia. range</p>	<p>1–20</p>	<p>1–16</p>	<p>6,3–16,5</p>	<p>2–12</p>	<p>3–10</p>	<p>2–20</p>	<p>2–20</p>
<p>Number of teeth</p>	<p>3</p>	<p>3</p>	<p>2</p>	<p>2</p>	<p>1</p>	<p>2</p>	<p>2</p>
<p>Standard</p>	<p>P standard L</p>	<p>P standard L</p>	<p>P standard XL</p>	<p>DIN 6527 L</p>	<p>DIN 6527 L</p>	<p>P standard L</p>	<p>P standard L</p>
<p>Page</p>	<p>E 103</p>	<p>E 104</p>	<p>E 105</p>	<p>E 106</p>	<p>E 106</p>	<p>E 107</p>	<p>E 107</p>
							

Product range overview of milling cutters for shoulder / slot milling

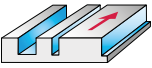
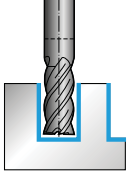



Application	HSS end mills							
								
Helix angle	45°			40°				
Designation	-	-	-	-	-	-	P602602	P602612
Shank DIN 6535 HA	-	-	-	-	-	-	P612602	P612612
Shank DIN 6535 HB	P312301	P3123017	P3123117	P312401	P312411	P4117027	P612602	P612612
Type	Protostar® N 45	Protostar® N 45	Protostar® N 45 long	Protostar® W 40	Protostar® W 40 long	Protostar® Inox V 40	Protostar® AL 40	Protostar® AL 40
Dia. range	3-30	5-30	6-20	2-25	2-25	2-20	2-22	6-20
Number of teeth	3-6	3-6	3+4	3	3	3	2	2
Standard	DIN 844 B	DIN 844 B	DIN 844 B	DIN 845	DIN 844 B	DIN 327 D	DIN 844 A + B	DIN 844 A + B
Page	E 108	E 108	E 108	E 109	E 109	E 110	E 111	E 112
								



Application	HSS end mills						
							
Helix angle	30°						
Designation	P300611	-	-	P301612	-	-	P302201
Shank DIN 6535 HA	P300611	-	-	P301612	-	-	P302201
Shank DIN 6535 HB	-	P310611	P3106117	-	P311612	P3116127	P312201
Type	Protostar® 30	Protostar® 30	Protostar® 30	Protostar® 30	Protostar® 30	Protostar® 30	Protostar® N 30
Dia. range	1.8-22	1-40	1-22	2-20	2-30	2-20	1-50
Number of teeth	2	2	2	2	2	2	4-8
Standard	DIN 327	DIN 327	DIN 327	DIN 844 A	DIN 844 A	DIN 844 A	DIN 844 A + B
Page	E 113	E 113	E 113	E 114	E 115	E 115	E 116
							

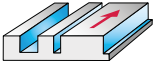
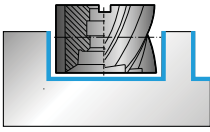
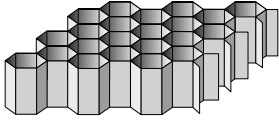





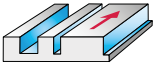
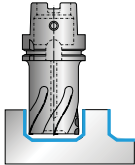

Application 	HSS end mills 					
	30°					
Designation						
Shank DIN 6535 HA	-	P302211	-	-	-	P302621
Shank DIN 6535 HB	P3122017	P312211	P3122117	P312221	P3122317	-
Type	Protostar® N 30	Protostar® N 30 long	Protostar® N 30 long	Protostar® N 30 long	Protostar® N 30 long	Protostar® 30 long
Dia. range	2-32	2-50	3-25	16-32	10-25	6-16
Number of teeth	4-8	4-8	4+5	4-6	4+5	2
Standard	DIN 844 B	DIN 844 A+B	DIN 844 B	P standard	P standard	P standard
Page	E 116	E 116	E 118	E 120	E 120	E 121
						

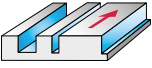
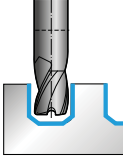





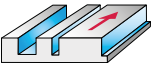
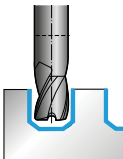

Application 	HSS end mills 					
	30°					25°
Designation						
Shank DIN 6535 HA	-	-	-	-	-	P632612 Shank HE
Shank DIN 6535 HB	P311712	P3117127	P311722	P312673	P312771	
Type	Protostar® 30	Protostar® 30	Protostar® 30 long	Protostar® 30	Protostar® 30	Protostar® AL 25 long
Dia. range	1,5-32	2-20	3-20	4-30	1-6	16-32
Number of teeth	3	3	3	2	3	2
Standard	DIN 844 B	DIN 844 B	DIN 844 B	P standard	P standard	P standard L
Page	E 122	E 122	E 123	E 124	E 124	E 125
						

Product range overview of milling cutters for shoulder / slot milling









Application	HSS shell end mill	HSS high-performance cutting tool	
			
Helix angle	30°	~	
Designation DIN 138	P020401	P950004	P955054
Type	Protostar® N 30	Honeycomb	Honeycomb
Dia. range	40–100	45+63	44+61,5
Number of teeth	8–12	~	30-40
Standard	DIN 1880	P standard	P standard
Page	E 126	E 127	E 127
			

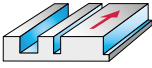
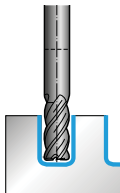







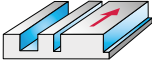
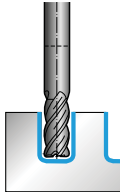

Application	PCD porcupine cutter
	
Helix angle	10°
Designation	F4726 HSK shank
Type	PCD porcupine cutter
Dia. range	32–63
Number of teeth	2+2
Standard	—
Page	E 184
	









Application	Solid carbide slot drills						
							
Helix angle	50°	30°					
Designation	H3021217	-	-	-	-	-	-
Shank DIN 6535 HA	H3021217	-	-	-	-	-	-
Shank DIN 6535 HB	H3121217	H311501	H3115018	H3116018	H3117018	H311801	H3118018
Type	Tough Guys N 50	Protostar® 30	Protostar® 30	Protostar® 30	Protostar® 30	Protostar® 30	Protostar® 30
Dia. range	2,8–16	2–20	2–20	2,8–19,7	1,8–19,7	2–20	2–20
Number of teeth	3+4	2	2	2	3	3	3
Standard	DIN 6527 K	DIN 6527 K	DIN 6527 K	DIN 6527 K	DIN 6527 K	DIN 6527 K	DIN 6527 K
Page	E 128	E 129	E 129	E 129	E 130	E 130	E 130
							

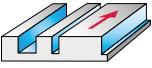
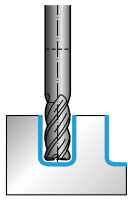





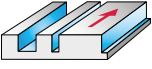
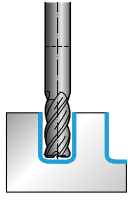

Application	HSS slot drills							
								
Helix angle	30°							
Designation	P301702	-	-	-	-	-	-	-
Shank DIN 6535 HA	P301702	-	-	-	-	-	-	-
Shank DIN 6535 HB	P311702	P3117027	P311701	P3117017	P311602	P3116027	P311601	P3116017
Type	Protostar® 30	Protostar® 30	Protostar® 30	Protostar® 30	Protostar® V 30	Protostar® V 30	Protostar® U 30	Protostar® U 30
Dia. range	3–40	3–20	2,8–31,7	2,8–17,7	2–30	2–30	1,8–27,7	1,8–15,7
Number of teeth	3	3	3	3	2	2	2	2
Standard	DIN 327 B/D	DIN 327 D	DIN 327 D	DIN 327 D	DIN 327 D	DIN 327 D	DIN 327 D	DIN 327 D
Page	E 131	E 131	E 132	E 132	E 133	E 133	E 134	E 134
								

Product range overview of milling cutters for shoulder / slot milling





Application 	Solid carbide end mills with corner radius 							
Helix angle	50°							
Designation	H4038217	H3E93718	H3E94718	H3094718	H3094728	H3020117	H3E20317	H3020317
Shank DIN 6535 HA								
Shank DIN 6535 HB	–			–	–	–		H3120317
Type	Proto-max TM _{ST}	Protostar [®] Flash	Protostar [®] Flash	Protostar [®] Flash	Protostar [®] Flash	Tough Guys N 50 long	Tough Guys N 50	Tough Guys N 50
Dia. range	3–20	10–20	10–25	4–20	4–20	4–20	10–25	6–20
Number of teeth	4	3	4	4	4	3 + 4	4 + 5	4
Standard	P-Norm	ConeFit [™]	ConeFit [™]	DIN 6527 L P standard L	DIN 6527 L	P standard L	ConeFit [™]	DIN 6527 L
Page	E 135	E 137	E 137	E 138	E 139	E 140	E 141	E 142
								





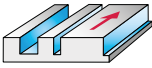
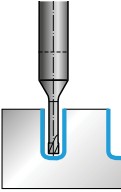



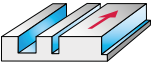
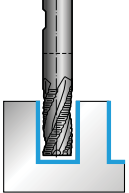

Application 	Solid carbide end mills with corner radius 								
Helix angle	50°				45°				
Designation	H4020017	H4020117	H3070118	H3070318	H4036217	–	H6E2311	H602311	H6023114
Shank DIN 6535 HA									
Shank DIN 6535 HB	H4120017	H4120117	–	H3170318	–	H4129318		–	–
Type	Tough Guys N 50	Tough Guys N 50 long	Tough Guys H 50	Tough Guys H 50	Proto-max TM _{ST}	Protostar [®] 45	Protostar [®] Al 45	Protostar [®] Al 45	Protostar [®] Al 45
Dia. range	2–20	4–20	2–20	6–20	2–20	2–20	10–25	1–25	1–25
Number of teeth	3 + 4	4	3 + 4	4	3	3	3	3	3
Standard	DIN 6527 L	P standard L	P standard L	DIN 6527 L	P standard	DIN 6527 L	ConeFit [™]	DIN 6527 L	DIN 6527 L
Page	E 143	E 145	E 147	E 147	E 136	E 149	E 150	E 150	E 150
									









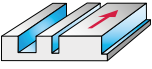
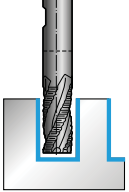

Application	Solid carbide end mills with corner radius						
							
Helix angle	40°	30°					
Designation	H7073717	H8005728	H8005928	H800881	H8008818	H800891	H8008918
Shank DIN 6535 HA							
Shank DIN 6535 HB	-	-	-	-	-	-	-
Type	Ti 40	Ultra HSC 30	Ultra HSC 30	Protostar® HSC 30 long	Protostar® HSC 30 long	Protostar® HSC 30 long	Protostar® HSC 30 long
Dia. range	12-25	5-12	2-6	0,6-12	0,6-12	0,6-2	0,6-2
Number of teeth	4	2	2	2	2	2	2
Standard	DIN 6527 L	DIN 6527 L	P standard L	P standard L	P standard L	P standard L	P standard L
Page	E 151	E 152	E 152	E 153	E 153	E 154	E 154
							

Application	Solid carbide end mills with corner radius							
								
Helix angle	30°					25°		
Designation	H8015728	H8015828	H8095918	H8095919	H602091	H602691	H602881	H6028818
Shank DIN 6535 HA								
Shank DIN 6535 HB	-	-	-	-	-	-	-	-
Type	Ultra HSC 30	Ultra HSC 30	Protostar® HSC 30	Protostar® HSC 30	Sky-tec™ AL 30	Sky-tec™ AL 25	Protostar® AI 25	Protostar® AI 25
Dia. range	6-20	4-16	4-12	4-12	12-25	12-25	6-20	6-20
Number of teeth	4	4	2 + 4	2 + 4	3	2	2	2
Standard	P standard L	P standard L	P standard XL	P standard XL	P standard XL	P standard XL	P standard L	P standard L
Page	E 155	E 155	E 156	E 157	E 158	E 159	E 160	E 160
								









Product range overview of milling cutters for shoulder / slot milling

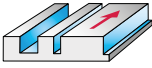
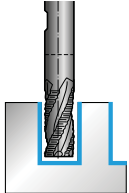





	Solid carbide mini end mills with corner radius 		
Helix angle	30°		
Designation			
Shank DIN 6535 HA	H4044919	H4044928	H8005828
Shank DIN 6535 HB	–	–	–
Type	Protostar® HSC 30	Ultra HSC 30	Ultra HSC 30
Dia. range	0,4–3	0,4–3	0,6–3
Number of teeth	2	2	2
Standard	P standard mini	P standard mini	P standard mini
Page	E 162	E 163	E 163
			



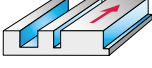
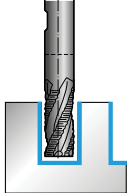

Application 	Solid carbide end mills with roughing profile 								
	Helix angle 45°		Helix angle 40°						
Designation Shank DIN 6535 HA	H3E85378	–	H3E82378	–	–	–	H608411	H608771	
Shank DIN 6535 HB		H3185378		H3182378	H4189278	H4189378	–	–	
Type	Qmax HR Kordel F 45	Qmax HR Kordel F 45	Qmax HR Kordel F 40	Qmax HR Kordel F 40	Qmax HR Kordel F 40	Qmax HR Kordel F 40	Protostar® AL Kordel G 40	Protostar® AL Kordel G 40	
Dia. range	10–25	12–25	10–25	5–20	6–25	5–20	6–20	6–25	
Number of teeth	5–8	5–8	4	4	4	4	3	3	
Standard	ConeFit™	DIN 6527 L	ConeFit™	DIN 6527 L	DIN 6527 K	DIN 6527 L	DIN 6527 L	P-Norm L	
Page	E 164	E 165	E 166	E 167	E 167	E 167	E 168	E 168	
									
									

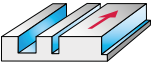
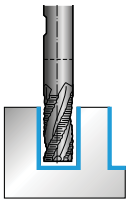

Application 	Solid carbide end mills with roughing profile 								
	Helix angle 40°		Helix angle 30°						
Designation Shank DIN 6535 HA	H608871	–	–	–	–	H3083017	–	H608391	H6083914
Shank DIN 6535 HB	–	H618911	H3180278	H4180378	H3187278	–	H3183017	–	–
Type	Protostar® AL Kordel G 40	Protostar® AL Kordel G 40	Qmax HNR Kordel F 30	Qmax HNR Kordel F 30	Qmax HR Kordel F 30	Protostar® Ti NS 30	Protostar® Ti NS 30	Sky-tec™ AL RAPAX G30	Sky-tec™ AL RAPAX G30
Dia. range	6–25	6–20	6–25	6–25	6–25	6–25	6–25	16–25	16–25
Number of teeth	3	3	4	4	3	4	4	3	3
Standard	P standard L	DIN 6527 L	DIN 6527 K	DIN 6527 L	DIN 6527 K	DIN 6527 L	DIN 6527 L	P standard XL	P standard XL
Page	E 169	E 169	E 170	E 170	E 171	E 172	E 172	E 173	E 173
									

Product range overview of milling cutters for shoulder / slot milling





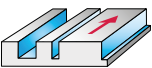
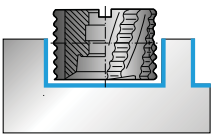



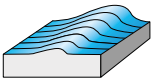
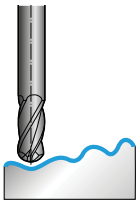

Application 	HSS end mills with roughing profile 							
Helix angle	45°			35°				
Designation	-	-	-	-	-	-	-	-
Shank DIN 6535 HA	-	-	-	-	-	-	-	-
Shank DIN 6535 HB	P3123087	P312021	P3120217	P312028	P3120287	P4110217	P312001	P3120017
Type	Protostar® FS 45	Protostar® HRA Kordel F 35	Protostar® HRA Kordel F 35	Protostar® HRA Kordel F 35	Protostar® HRA Kordel F 35	Protostar® HRA Kordel F 35	Protostar® NRA Kordel G 35	Protostar® NRA Kordel G 35
Dia. range	6–25	5–40	6–32	5–30	6–25	8–30	6–40	6–30
Number of teeth	3 + 4	4 + 6	4 + 6	3 + 4	3 + 4	3	4 + 6	4 + 6
Standard	DIN 844 B	DIN 844 B	DIN 844 B	DIN 844 B	DIN 844 B	DIN 327 H	DIN 844 B	DIN 844 B
Page	E 174	E 175	E 175	E 175	E 175	E 176	E 177	E 177
								







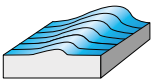
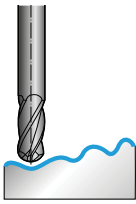

Application 	HSS end mills with roughing profile 					
Helix angle	35°			30°		
Designation	-	-	-	-	-	-
Shank DIN 6535 HA	-	-	-	-	-	-
Shank DIN 6535 HB	P312011	P3120117	P3120537	P3120937	P3120387	P3128417
Type	Protostar® NRA Kordel G 35	Protostar® NRA Kordel G 35	Protostar® HNR Kordel F 30	Protostar® HNR Kordel F 30	Protostar® HR Kordel F 30	Protostar® HR Kordel F 30
Dia. range	6–50	6–25	6–32	6–32	6–20	6–32
Number of teeth	4–6	4 + 5	4–6	4–6	3	4–6
Standard	DIN 844 B	DIN 844 B	DIN 844 B	DIN 844 B	DIN 844 B	P-Norm
Page	E 177	E 177	E 178	E 178	E 179	E 179
						

<p>Application</p> 	<p>HSS end mills with roughing profile</p> 			
<p>Helix angle</p>	<p>30°</p>			
<p>Designation Shank DIN 6535 HA</p>	-	-	-	P352011 MK shank
<p>Shank DIN 6535 HB</p>	P3121017	P312111	P3120717	
<p>Type</p>	Protostar® NF RAPAX G 30	Protostar® NF RAPAX G 30	Protostar® NR Kordel G 30	Protostar® NR Kordel G 30
<p>Dia. range</p>	6–30	10–40	6–30	16–40
<p>Number of teeth</p>	4 + 5	4–6	4 + 5	4 + 6
<p>Standard</p>	DIN 844 B	DIN 844 B	P-Norm	DIN 845 B
<p>Page</p>	E 180	E 180	E 181	E 182
				

<p>Application</p> 	<p>HSS shell end mills with roughing profile</p> 	
<p>Helix angle</p>	<p>25°</p>	
<p>Designation DIN 1880</p>	P020101	P0201016
<p>Type</p>	Protostar® HR Kordel F 25	Protostar® HR Kordel F 25
<p>Dia. range</p>	40–100	40–100
<p>Number of teeth</p>	8–12	8–12
<p>Standard</p>	DIN 1880	DIN 1880
<p>Page</p>	E 183	E 183
		

Product range overview of milling cutters for copy milling

Application 	Solid carbide ball-nose end mills 							
Helix angle	40°		30°					
Designation	H8E01118	H8E11118	H8011118	H800111	H8001118	H8001119	H8001918	H8006418
Shank DIN 6535 HA				H8111118	–	–	–	–
Shank DIN 6535 HB								
Type	Protostar® N 40	Protostar® N 40	Protostar® 30	Protostar® 30	Protostar® 30	Protostar® 30	Protostar® HSC 30	Protostar® HSC 30
Dia. range	10–25	10–25	3–20	1–20	1–20	1–12	4–12	1–10
Number of teeth	2	4	4	2	2	2	2 + 4	2
Standard	ConeFit™	ConeFit™	P standard L	DIN 6527 L	DIN 6527 L	DIN 6527 L	P standard XL	P standard L
Page	E 192	E 192	E 193	E 194	E 194	E 195	E 196	E 197
	 	 						

Application 	Solid carbide ball-nose end mills 							
Helix angle	30°							
Designation	H8016418	H8001919	H8006419	H8016419	H8004028	H8004128	H8004728	H8006428
Shank DIN 6535 HA								
Shank DIN 6535 HB	–	–	–	–	–	–	–	–
Type	Protostar® HSC 30	Protostar® HSC 30	Protostar® HSC 30	Protostar® HSC 30	Ultra HSC 30	Ultra HSC 30	Ultra HSC 30	Ultra HSC 30
Dia. range	5–16	4–12	1–10	5–12	5–16	6–16	1–5	1–16
Number of teeth	4	2 + 4	2	4	2	2	2	2
Standard	P standard L	P standard XL	P standard L	P standard L	DIN 6527 L	P standard L	P standard XL	P standard L
Page	E 197	E 198	E 199	E 199	E 200	E 200	E 201	E 202
								







Application 	Solid carbide ball-nose end mills 					Solid carbide mini ball-nose end mills 			
	Helix angle 30°								
Designation	H8016428	H8014028	H8074128	H8014128	H602111	H404691	H4046918	H4046919	H4046928
Shank DIN 6535 HA									
Shank DIN 6535 HB	-	-	-	-	-	-	-	-	-
Type	Ultra HSC 30	Ultra HSC 30	Ultra HSC 30	Ultra HSC 30	Protostar® AL 30	Protostar® HSC 30	Protostar® HSC 30	Protostar® HSC 30	Ultra HSC 30
Dia. range	5-16	6-16	3-10	6-16	2-16	0,3-3	0,3-3	0,3-3	0,3-3
Number of teeth	4	4	2	4	2	2	2	2	2
Standard	P standard L	DIN 6527 L	P standard L	P standard L	P standard L	P standard mini	P standard mini	P standard mini	P standard mini
Page	E 202	E 203	E 203	E 204	E 205	E 206	E 206	E 207	E 208



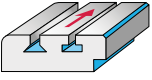
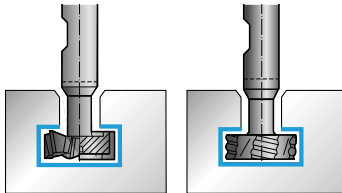
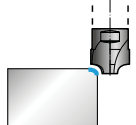

Application 							
	Helix angle 30°						
Designation	-	-	-	-	-	-	-
Shank DIN 6535 HA							
Shank DIN 6535 HB	P312674	P316601	P3166017	P316611	P3166117	P8112017	P811211
Type	Protostar® 30	Protostar® 30	Protostar® 30	Protostar® 30	Protostar® 30	Protostar® 30	Protostar® 30
Dia. range	3-12	2-20	2-20	3-30	3-20	6-20	10-25
Number of teeth	2	2	2	2	2	4	4 + 6
Standard	P standard	DIN 327	DIN 327	DIN 844 B	DIN 844 B	DIN 1889 BB	DIN 1889 BB
Page	E 209	E 210	E 210	E 211	E 211	E 212	E 212

Product range overview of milling cutters for profile milling

Application 	Solid carbide chamfering and deburring cutters 					
Helix angle	0°					
Designation	H3E58118	H305811	H3058118	H3E58318	H305831	H3058318
Shank DIN 6535 HA						
Shank DIN 6535 HB		–	–		–	H3158318
Type	Protostar® chamfer milling cutter 120°	Protostar® chamfer milling cutter 120°	Protostar® chamfer milling cutter 120°	Protostar® chamfer milling cutter 90°	Protostar® chamfer milling cutter 90°	Protostar® chamfer milling cutter 90°
Dia. range	12	10	10	10–16	6–12	6–12
Number of teeth	6	4	4	4–8	4–6	4–6
Standard	ConeFit™	P standard L	P standard L	ConeFit™	P standard L	P standard L
Page	E 218	E 218	E 218	E 219	E 219	E 219

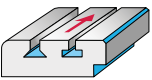
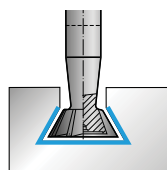
Application 	Solid carbide chamfering and deburring cutters 				Solid carbide quarter-round profile milling cutters 	
Helix angle	0°				0°	
Designation	H3E58518	H305851	H3058518	H3053918	H3E68118	H3068118
Shank DIN 6535 HA						
Shank DIN 6535 HB		–	H3158518	–		–
Type	Protostar® chamfer milling cutter 60°	Protostar® chamfer milling cutter 60°	Protostar® chamfer milling cutter 60°	Forwards and reverse deburrer	Protostar®	Protostar®
Dia. range	10+12	6+10	6+10	6–12	R1–R6	R0,5–6
Number of teeth	4 + 6	4	4	4 + 6	4	3 + 4
Standard	ConeFit™	P standard L	P standard L	P standard L	ConeFit™	DIN 6527 L
Page	E 220	E 220	E 220	E 221	E 222	E 222

<p>Application</p> 	<p>HSS T-slot milling cutters</p> 					<p>HSS quarter-round mills</p> 
Helix angle	12°			10°		0°
Designation	-			-		-
Shank DIN 6535 HA	-			-		-
Shank DIN 6535 HB	P314801	P3148016	P314101	P313211	P313231	P316881
Type	Protostar® N 12	Protostar® N 12	Protostar® Kordel F 12	Protostar® N 10	Protostar® N 10	Protostar®
Dia. range	11–50	11–40	16–50	4,5–28,5	13,5–45,5	R1–R20
Number of teeth	6–10	6–10	6–10	6–12	8–14	4–6
Standard	DIN 851 AB	DIN 851 AB	DIN 851 AB	DIN 850 D	DIN 850 D	DIN 6518 B
Page	E 223	E 223	E 224	E 225	E 225	E 226
						

<p>Application</p> 	<p>HSS dovetail profile milling cutters</p> 			
Helix angle	0°			
Designation	-			
Shank DIN 6535 HA	-			
Shank DIN 6535 HB	P315801	P315821	P315831	P315851
Type	Protostar® 45°	Protostar® 60°	Protostar® 45°	Protostar® 60°
Dia. range	12–32	12–32	12–32	12–32
Number of teeth	10 + 12	10 + 12	10 + 12	10 + 12
Standard	DIN 1833 C	DIN 1833 C	DIN 1833 D	DIN 1833 D
Page	E 227	E 227	E 228	E 228
				

ConeFit™ system overview

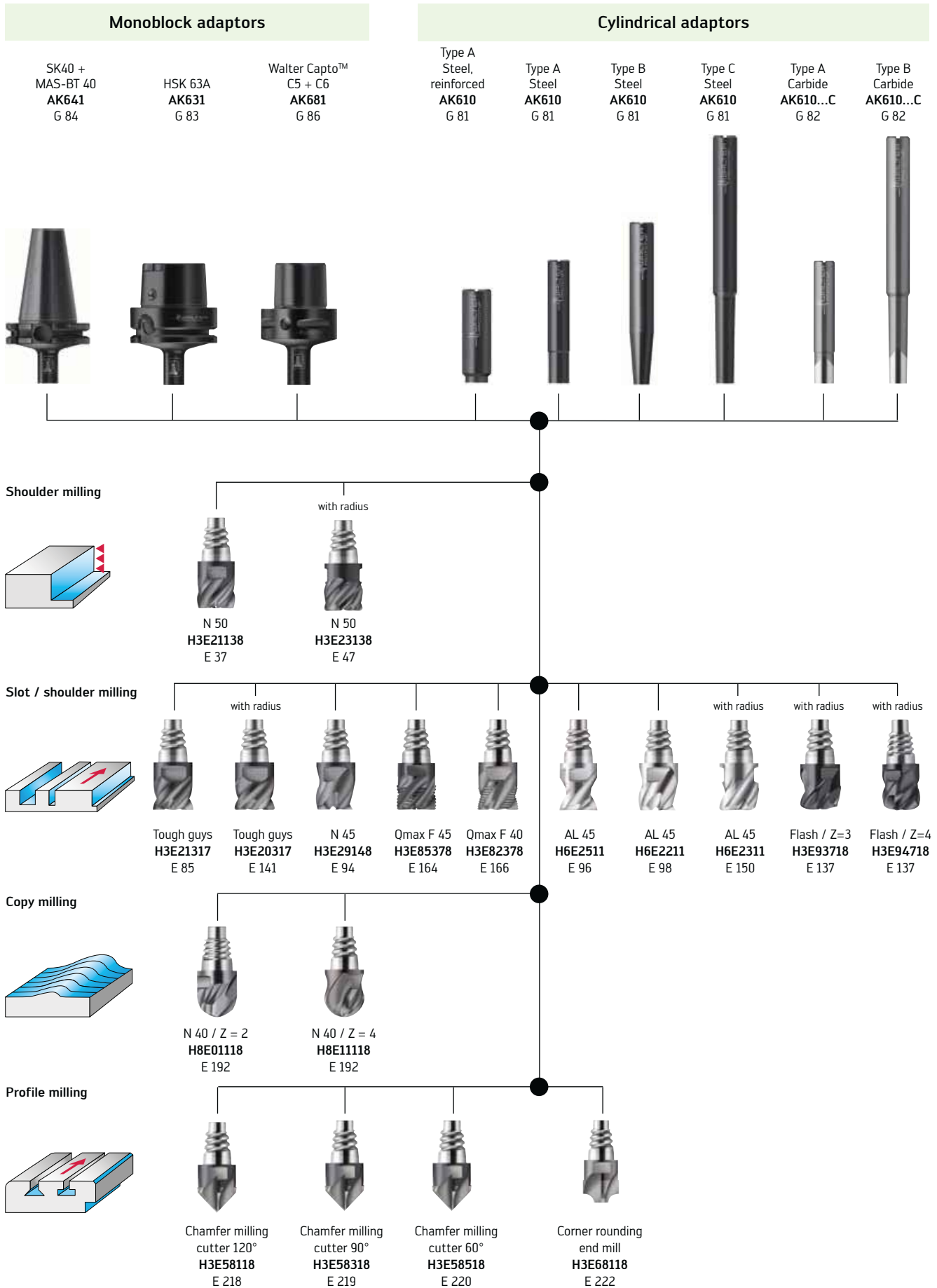

Designation key for Walter PCD milling cutters

Example

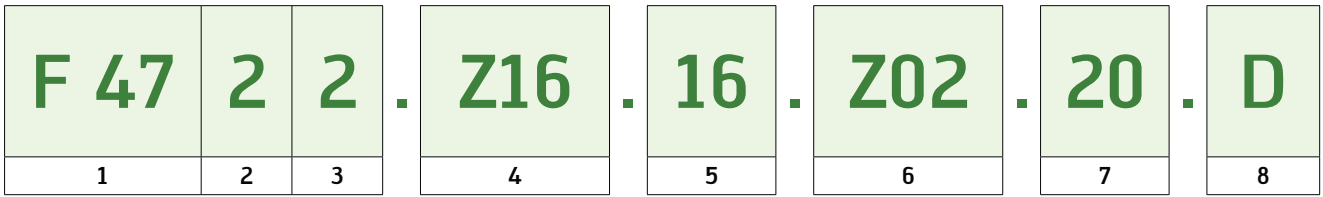

1
Tool range
F 47 PCD milling cutter, brazed

2
Corner
<ol style="list-style-type: none"> 1 Radius 2 Facet 3 Wiper cutting edge 4 Cutting edge shape for sealing surfaces 5 Acc. to Walter standard

3
Machining method
<ol style="list-style-type: none"> 1 Slot drill 2 Shoulder milling cutter 3 Face mill 4 Radius mill 5 Torus cutter 6 Porcupine cutter

4
Adaptor:
Z Cylindrical shank H63A HSK 63, Form A T ScrewFit B Bore

5
Cutting diameter
06 6 mm 16 16 mm

6
Number of teeth

7
Cutting length

8
Cutting tool material
D WCD 10

Walter Select for milling applications

Step by step to the correct tool

STEP 1

Define the **material** to be machined, see page H 8 onwards.

Note down the **machining group** that corresponds to your material, e.g.: P10.

Code letter	Machining group	Groups of the materials to be machined	
P	P1–P15	Steel	All types of steel and cast steel, with the exception of steel with an austenitic structure
M	M1–M3	Stainless steel	Stainless austenitic steel and austenitic-ferritic steel and cast steel
K	K1–K7	Cast iron	Grey cast iron, cast iron with spheroidal graphite, malleable cast iron, cast iron with vermicular graphite
N	N1–N10	NF metals	Aluminium and other non-ferrous metals, non-ferrous materials
S	S1–S10	High temperature alloys and titanium alloys	Heat resisting special alloys based on iron, nickel and cobalt, titanium and titanium alloys
H	H1–H4	Hard materials	Hardened steel, hardened cast iron materials, chilled cast iron
O	O1–O6	Other	Plastics, glass and carbon fibre reinforced plastics, graphite

STEP 2

Select the **machining conditions**:

Machine stability, clamping system and workpiece		
excellent	good	Moderate

STEP 3

Select your **machining method** based on the main categories and subcategories and then go to the relevant tool overview page.

Shoulder milling	
Shoulder milling without corner radius	Shoulder milling with corner radius
 E 4	 E 6

STEP 3
(continued)

Shoulder / slot milling

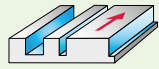

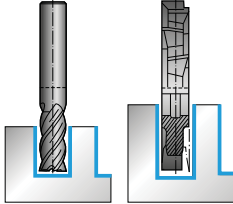
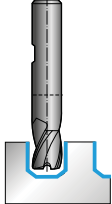
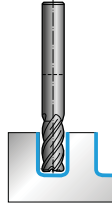
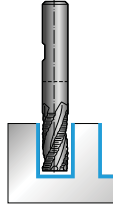
Shoulder / slot milling without corner radius	Shoulder / slot milling with facet	Shoulder / slot milling with corner radius	Shoulder / slot milling with roughing profile
			
E 7	E 13	E 14	E 17

Copy milling

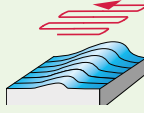

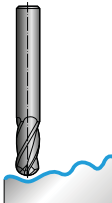

E 20

Profile milling

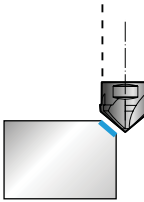
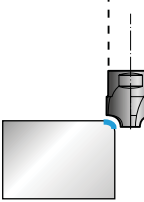
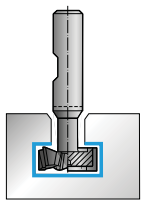
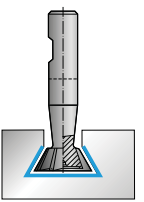

Chamfering and deburring	Corner rounding	T-slot milling	Dovetail milling
			
E 22	E 22	E 23	E 23

Walter Select for milling applications

Step by step to the correct tool

STEP 4

Select the appropriate tool for your **machining conditions** and then go to the ordering page.

Machining conditions		Dia. range		Number of teeth		Coating			
4 - 25		4 - 8		TAX					
Material group	Classification of the main material groups and code letters	Workpiece material	Brinell hardness HB	Tensile strength R _m N/mm ²	Machining group	Family	Designation	λ	Page
						ConeFit™ N 50	H3E21138	50°	E 37
						N 45 long	H3023418	45°	E 40
							H3123418	45°	E 40
							H3023518	45°	E 41
							H3123518	45°	E 41

Material group	Classification of the main material groups and code letters	Workpiece material	Brinell hardness HB	Tensile strength R _m N/mm ²	Machining group	Machining conditions	
						Family	Designation
Unalloyed and low-alloyed steel	annealed (tempered)		210	700	P1, P2, P3, P4, P7		••
	Free cutting steel		220	750	PG		••
	tempered		300	750			••
	tempered						••

STEP 5

Based on the **material group** to be machined, find the appropriate **cutting speed** by referring to **a_e** to **D_c** from page E 230 onwards and also the **feed group**.

Solid carbide						PCD-brazed (tipped)						Carbide-brazed (tipped)					
Family	Des.	λ	Page	Family	Des.	λ	Page	Family	Des.	λ	Page	Family	Des.	λ	Page		
N 30	H302211	30°	E 43	N 30	H8018718	30°	E 50	PCD mill	F4722	0°	E 52	Brazed heel milling cutters	F1675		E 53		
	H3022018		E 43	HSC 30	H3093418	30°	E 45		F4723	0°	E 53		F1676		E 55		
	H3122018		E 42	Mm	H404491	30°	E 51						F1677		E 54		
	H3058917		E 44	HSC 30	H4044918		E 51						F1678		E 54		
HSC 30	H3022118	30°	E 43										F1682		E 54		
	H3122118		E 43														

Dia. 2 - 20				Dia. 0.4 - 16				Dia. 6 - 125				Dia. 16 - 100				
Z = 4 - 6				Z = 2 + 4				Z = 2 - 8				Z = 3 - 8				
uncoated + TAX				uncoated + TAX				PCD				uncoated				
a _e / D _c		VT		a _e / D _c		VT		a _e / D _c		VT		a _e / D _c		VT		
1/2	1/4	1/10		1/2	1/4	1/10		1/2	1/4	1/10		1/2	1/4	1/10		
230	280	330	A	240	280	350	A					200	325	375	J	
230	270	320	A	230	270	330	A					140	225	265	J	
190	230	280	A	200	230	290	A					120	200	230	J	
190	230	280	A	200	230	290	A					140	225	265	J	
140	160	200	A	150	170	200	A					110	180	215	J	
190	230	280	A	200	230	290	A					130	220	280	J	
190	230	280	A	200	230	290	A					195	250	290	L	
140	160	200	A	150	170	200	A					120	190	225	L	
110	130	160	A	130	140	170	A					100	170	195	L	
100	110	140	A	110	120	140	A					90	160	170	L	
190	230	280	A	200	230	290	A					115	190	220	L	
140	160	200	A	150	170	200	A					100	160	180	L	
100	110	140	A	110	120	140	A					90	150	170	L	
70	80	90	A	70	80	100	A					75	125	145	L	
50	60	70	A	50	60	70	A					70	115	135	L	
80	90	120	B													
50	60	70	B													
70	80	90	B													
													180	275	320	J
													135	215	250	J
													150	250	290	K
													125	205	240	K
													180	300	320	J

STEP 6

Based on the feed group, determine the correct **feed value** (page E 274) for your **machining conditions**.

D Protostar® Flash ISO-P, M, K, N, S, O												
a _e [mm]*	Feed per tooth f _z [mm]											
	Dia. 3 mm	Dia. 4 mm	Dia. 6 mm	Dia. 8 mm	Dia. 10 mm	Dia. 12 mm	Dia. 14 mm	Dia. 16 mm	Dia. 18 mm	Dia. 20 mm	Dia. 25 mm	
0.8	0.07											
1.5	0.07	0.10	0.16	0.25								
3	0.07	0.10	0.16	0.25	0.30							
5		0.10	0.16	0.25	0.30	0.35						
6			0.16	0.25	0.30	0.35	0.40	0.50	0.60			
8			0.16	0.25	0.30	0.35	0.40	0.50	0.60	0.70		
10					0.30	0.35	0.40	0.50	0.60	0.70	0.70	
12							0.40	0.50	0.60	0.70	0.70	
14							0.40	0.50	0.60	0.70	0.70	
16								0.50	0.60	0.70	0.70	
18									0.60	0.70	0.70	
20										0.70	0.70	
25											0.70	

E Protostar® Flash ISO-H												
a _e [mm]*	Feed per tooth f _z [mm]											
	Dia. 3 mm	Dia. 4 mm	Dia. 6 mm	Dia. 8 mm	Dia. 10 mm	Dia. 12 mm	Dia. 14 mm	Dia. 16 mm	Dia. 18 mm	Dia. 20 mm	Dia. 25 mm	
0.8	0.06	0.08										
1.5	0.06	0.08	0.13	0.20								
	0.06	0.08	0.13	0.20								



Walter Select – Shoulder milling without corner radius

Solid carbide end mills

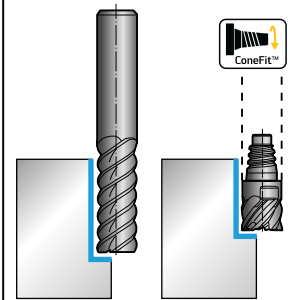
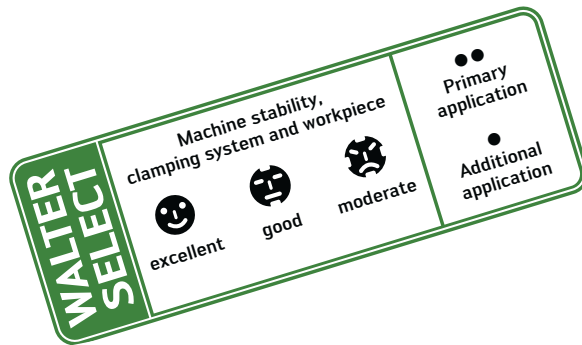
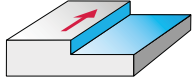

Solid carbide end mills

Material group		Classification of the main material groups and code letters		Workpiece material		Brinell hardness HB	Tensile strength R_m N/mm ²	Machining group	Machining conditions			
									Family	Designation	λ	Page
Machining conditions									☹			
Dia. range									4 – 25			
Number of teeth									4 – 8			
Coating									TAX			
									ConeFit™	H3E21138	50°	E 37
									N 50			
									N 45 long	H3023418	45°	E 40
										H3123418	45°	E 40
										H3023518	45°	E 41
										H3123518	45°	E 41
P	Unalloyed and low-alloyed steel	annealed (tempered)	210	700	P1, P2, P3, P4, P7	●●						
		Free cutting steel	220	750	P6	●●						
		tempered	300	1010	P5, P8	●●						
		tempered	380	1280	P9	●●						
		tempered	430	1480	P10	●●						
P	High-alloyed steel and high-alloyed tool steel	annealed	200	670	P11	●●						
		hardened and tempered	300	1010	P12	●●						
		hardened and tempered	400	1360	P13	●●						
P	Stainless steel	ferritic / martensitic, annealed	200	670	P14	●●						
		martensitic, tempered	330	1110	P15	●●						
		austenitic, duplex	230	780	M1, M3	●						
M	Stainless steel	austenitic, precipitation hardened (PH)	300	1010	M2	●						
K	Grey cast iron		245	–	K3, K4							
	Cast iron with spheroidal graphite	ferritic, pearlitic	365	–	K1, K2, K5, K6							
	GGV (CGI)		200	–	K7							
N	Aluminium wrought alloys	cannot be hardened	30	–	N1							
		hardenable, hardened	100	340	N2							
	Cast aluminium alloys	≤ 12 % Si	90	310	N3, N4							
		> 12 % Si	130	450	N5							
	Magnesium alloys		70	250	N6							
N	Copper and copper alloys (bronze / brass)	unalloyed, electrolytic copper	100	340	N7							
		Brass, bronze, red brass	90	310	N8							
		Cu-alloys, short-chipping	110	380	N9							
		high-strength, Ampco	300	1010	N10							
S	Heat-resistant alloys	Fe-based	280	940	S1, S2							
		Ni or Co base	250	840	S3							
		Ni or Co base	350	1080	S4, S5							
	Titanium alloys	Pure titanium	200	670	S6							
		α and β alloys, hardened	375	1260	S7							
		β alloys	410	1400	S8							
Tungsten alloys		300	1010	S9								
Molybdenum alloys		300	1010	S10								
H	Hardened steel		50 HRC	–	H1							
			55 HRC	–	H2, H4							
			60 HRC	–	H3							
O	Thermoplasts	without abrasive fillers			O1							
	Thermosetting plastics	without abrasive fillers			O2							
	Fibre-reinforced plastic	GFRP, AFRP			O3, O5							
		CFRP			O4							
Graphite (technical)			65	O6								

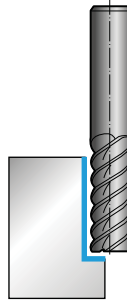

Solid carbide end mills

3 - 25					3 - 25				2 - 25				2 - 20			
4 - 6					4 - 16				4 - 6				4			
TAX					TAX				TAX				uncoated			
Family	Designation	λ	Page		Family	Designation	λ	Page	Family	Designation	λ	Page	Family	Designation	λ	Page
N 50 short	H3021138	50°	E 37		Ultra H 50	H8083128	50°	E 38	N 60	H3024148	60°	E 36	N 30	H302211	30°	E 43
					Ultra H 30 (48-63 HRC)	H3178128	30°	E 46	N 45	H3023118 H3123118	45° 45°	E 39 E 39				
									HSC 30	H3093418	30°	E 45				
									N 30	H3022018 H3122018 H3022118 H3122118 H3058917	30° 30° 30° 30° 30°	E 42 E 42 E 43 E 43 E 44				
	••								••							
	••								••							
	••								••							
	••					••			••							
	••								••							
	••								••							
	••								••							
	••								••							
	••								••							
	•								•					••		
	•								•					••		
	•															
	•															
	•															
	•															
	•															
	•															
	•															
						••										
						••										
						••										

Walter Select – shoulder milling without corner radius PCD end mill

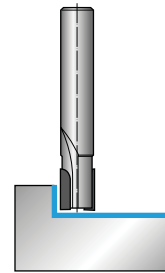
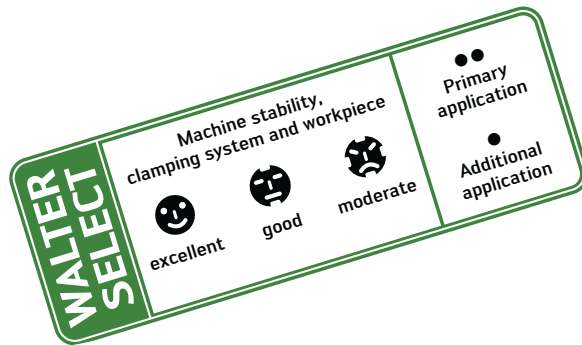
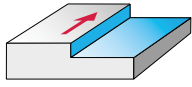

PCD end mill

Material group		Classification of the main material groups and code letters	Workpiece material	Brinell hardness HB	Tensile strength R _m N/mm ²	Machining group	Machining conditions			
							Family	Designation	λ	Page
							Dia. range 6 – 20			
							Number of teeth 2			
							Coating PKD			
							PCD shoulder mills	F4722	0°	E 52
P	Unalloyed and low-alloyed steel	annealed (tempered)		210	700	P1, P2, P3, P4, P7				
		Free cutting steel		220	750	P6				
		tempered		300	1010	P5, P8				
		tempered		380	1280	P9				
		tempered		430	1480	P10				
	High-alloyed steel and high-alloyed tool steel	annealed		200	670	P11				
		hardened and tempered		300	1010	P12				
		hardened and tempered		400	1360	P13				
	Stainless steel	ferritic / martensitic, annealed		200	670	P14				
		martensitic, tempered		330	1110	P15				
M	Stainless steel	austenitic, duplex		230	780	M1, M3				
		austenitic, precipitation hardened (PH)		300	1010	M2				
	Grey cast iron			245	–	K3, K4				
K	Cast iron with spheroidal graphite GGV (CGI)	ferritic, pearlitic		365	–	K1, K2, K5, K6				
				200	–	K7				
	Aluminium wrought alloys	cannot be hardened		30	–	N1	●●			
		hardenable, hardened		100	340	N2	●●			
	Cast aluminium alloys	≤ 12 % Si		90	310	N3, N4	●●			
		> 12 % Si		130	450	N5	●●			
N	Magnesium alloys			70	250	N6	●●			
	Copper and copper alloys (bronze / brass)	unalloyed, electrolytic copper		100	340	N7	●●			
		Brass, bronze, red brass		90	310	N8	●●			
		Cu-alloys, short-chipping		110	380	N9	●●			
		high-strength, Ampco		300	1010	N10	●●			
	Heat-resistant alloys	Fe-based		280	940	S1, S2				
		Ni or Co base		250	840	S3				
		Ni or Co base		350	1080	S4, S5				
	Titanium alloys	Pure titanium		200	670	S6				
		α and β alloys, hardened		375	1260	S7				
		β alloys		410	1400	S8				
	Tungsten alloys			300	1010	S9				
	Molybdenum alloys			300	1010	S10				
H	Hardened steel			50 HRC	–	H1				
				55 HRC	–	H2, H4				
				60 HRC	–	H3				
	Thermoplasts	without abrasive fillers				O1				
	Thermosetting plastics	without abrasive fillers				O2				
	Fibre-reinforced plastic	GFRP, AFRP				O3, O5				
		CFRP				O4				
	Graphite (technical)				65	O6				

Walter Select – Shoulder milling with corner radius

Solid carbide end mills

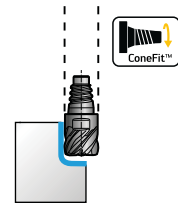
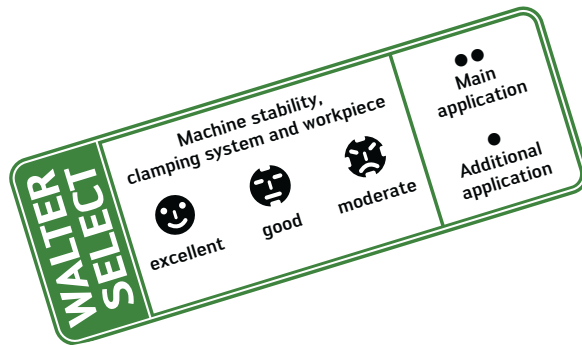
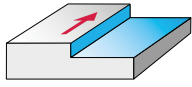

Solid carbide end mills

Material group		Classification of the main material groups and code letters	Workpiece material	Brinell hardness HB	Tensile strength R_m N/mm ²	Machining group	Machining conditions			
							Family	Designation	λ	Page
							Dia. range 10 – 25			
							Number of teeth 6 – 8			
							Coating TAX			
							ConeFit™ N 50	H3E23138	50°	E 47
P	Unalloyed and low-alloyed steel	annealed (tempered)		210	700	P1, P2, P3, P4, P7	●●			
		Free cutting steel		220	750	P6	●●			
		tempered		300	1010	P5, P8	●●			
		tempered		380	1280	P9	●●			
		tempered		430	1480	P10	●●			
	High-alloyed steel and high-alloyed tool steel	annealed		200	670	P11	●●			
		hardened and tempered		300	1010	P12	●●			
		hardened and tempered		400	1360	P13	●●			
	Stainless steel	ferritic / martensitic, annealed		200	670	P14	●●			
		martensitic, tempered		330	1110	P15	●●			
M	Stainless steel	austenitic, duplex		230	780	M1, M3	●			
		austenitic, precipitation hardened (PH)		300	1010	M2	●			
K	Grey cast iron		245	–	K3, K4					
	Cast iron with spheroidal graphite	ferritic, pearlitic		365	–	K1, K2, K5, K6				
	GGV (CGI)		200	–	K7					
N	Aluminium wrought alloys	cannot be hardened		30	–	N1				
		hardenable, hardened		100	340	N2				
	Cast aluminium alloys	≤ 12 % Si		90	310	N3, N4				
		> 12 % Si		130	450	N5				
	Magnesium alloys		70	250	N6					
	Copper and copper alloys (bronze / brass)	unalloyed, electrolytic copper		100	340	N7				
		Brass, bronze, red brass		90	310	N8				
Cu-alloys, short-chipping			110	380	N9					
	high-strength, Ampco		300	1010	N10					
S	Heat-resistant alloys	Fe-based		280	940	S1, S2				
		Ni or Co base		250	840	S3				
		Ni or Co base		350	1080	S4, S5				
	Titanium alloys	Pure titanium		200	670	S6				
		α and β alloys, hardened		375	1260	S7				
		β alloys		410	1400	S8				
	Tungsten alloys		300	1010	S9					
Molybdenum alloys		300	1010	S10						
H	Hardened steel			50 HRC	–	H1				
				55 HRC	–	H2, H4				
				60 HRC	–	H3				
O	Thermoplasts	without abrasive fillers				O1				
	Thermosetting plastics	without abrasive fillers				O2				
	Fibre-reinforced plastic	GFRP, AFRP					O3, O5			
		CFRP					O4			
	Graphite (technical)				65	O6				

End mill Protostar® N 60



Materials to 48 HRC

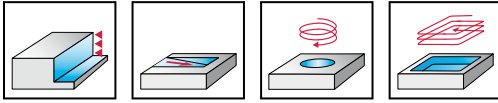

- solid carbide
- 6 cutting edges
- without centre cut
- 60° helix angle

Special features:

Slot milling: $a_p \leq 0.1 \times D_c$

Shoulder milling: $a_e \leq 0.1 \times D_c$

	P	M	K	N	S	H	O
TAX	●●	●	●	●	●	●	●

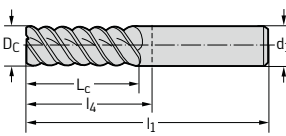
DIN 6527 L	D_c h10 mm	L_c mm	l_1 mm	l_4 mm	d_1 h6 mm	Z	TAX designation H3024148
Shank DIN 6535 HA 	6	13	57	21	6	6	-6
	8	19	63	27	8	6	-8
	10	22	72	32	10	6	-10
	12	26	83	38	12	6	-12
	14	26	83	38	14	6	-14
	16	32	92	44	16	6	-16
	18	32	92	44	18	6	-18
	20	38	104	54	20	6	-20

End mill Protostar® N 50



Materials to 48 HRC

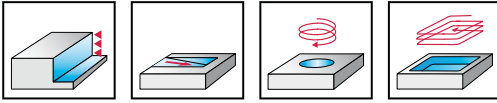

- solid carbide
- 4 to 8 cutting edges
- without centre cut
- 50° helix angle

Special features:

Slot milling: $a_p \leq 0.1 \times D_c$

Shoulder milling: $a_e \leq 0.1 \times D_c$

	P	M	K	N	S	H	O
TAX	●●	●	●	●	●	●	●

P standard	D_c h10 mm	L_c mm	d_2 mm	l_1 mm	l_4 mm	SW mm	d_1	Z	TAX
									designation H3E21138
ConeFit™	10	5,5	9,7	23,6	12,4	8	E 10	6	-E10-10
	12	6,5	11,7	28,3	14,5	10	E 12	6	-E12-12
	16	8,5	15,5	35,7	18,7	12	E 16	6	-E16-16
	20	11	19,3	40,8	21,3	16	E 20	8	-E20-20
	25	13,5	24,2	49,6	25,6	20	E 25	8	-E25-25

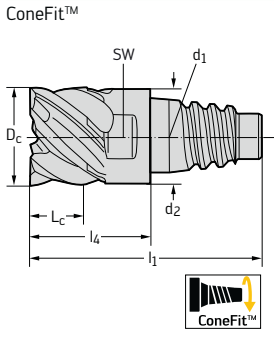

DIN 6527 L	D_c h10 mm	L_c mm	l_1 mm	l_4 mm	d_1 h6 mm	Z	TAX
							designation H3021138
Shank DIN 6535 HA	3	8	57	21	6	4	-3
	4	11	57	21	6	4	-4
	5	13	57	21	6	5	-5
	6	13	57	21	6	6	-6
	8	19	63	27	8	6	-8
	10	22	72	32	10	6	-10
	12	26	83	38	12	6	-12
	16	32	92	44	16	6	-16
	20	38	104	54	20	8	-20
	25	45	121	65	25	8	-25

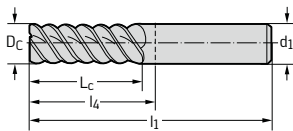

End mill Protostar® H 50 Ultra



Materials from 48 to 63 HRC

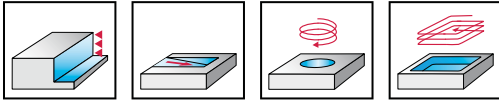

- solid carbide
- 4 to 8 cutting edges
- without centre cut
- 50° helix angle

Special features:

Slot milling: $a_p \leq 0.1 \times D_c$

Shoulder milling: $a_e \leq 0.1 \times D_c$

	P	M	K	N	S	H	O
TAX						●●	

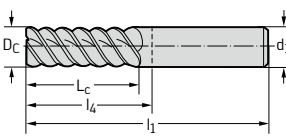
P standard L	D_c h10 mm	L_c mm	l_1 mm	l_4 mm	d_1 h5 mm	Z	TAX designation H8083128
Shank DIN 6535 HA 	3	8	57	21	6	4	-3X8
	4	11	57	21	6	4	-4X11
	5	13	57	21	6	4	-5X13
	6	13	57	21	6	6	-6X13
	6	26	70	34	6	6	-6X26
	8	19	63	27	8	6	-8X19
	8	36	80	44	8	6	-8X36
	10	22	72	32	10	6	-10X22
	10	46	100	60	10	6	-10X46
	12	26	83	38	12	6	-12X26
	12	55	110	65	12	6	-12X55
	16	32	92	44	16	6	-16X32
	16	66	130	82	16	6	-16X66
	20	38	104	54	20	8	-20X38
	20	80	145	95	20	8	-20X80
	25	45	121	65	25	8	-25X45
25	90	153	97	25	8	-25X90	

End mill Protostar® N 45



Materials to 48 HRC

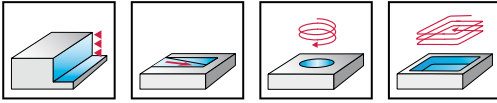

- solid carbide
- 4 to 5 cutting edges
- with centre cut
- 45° helix angle

Special features:

Slot milling: $a_p \leq 0.5 \times D_c$

Shoulder milling: $a_e \leq 0.5 \times D_c$

	P	M	K	N	S	H	O
TAX	●●	●	●	●	●	●	●

DIN 6527 L	D_c h10 mm	L_c mm	l_1 mm	l_4 mm	d_1 h6 mm	Z	TAX designation H3023118
Shank DIN 6535 HA	2	7	57	21	6	4	-2
	3	8	57	21	6	4	-3
	4	11	57	21	6	4	-4
	5	13	57	21	6	4	-5
	6	13	57	21	6	4	-6
	8	19	63	27	8	4	-8
	10	22	72	32	10	4	-10
	12	26	83	38	12	4	-12
	14	26	83	38	14	4	-14
	16	32	92	44	16	4	-16
	18	32	92	44	18	5	-18
	20	38	104	54	20	5	-20

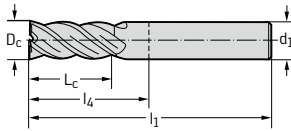

DIN 6527 L	D_c h10 mm	L_c mm	l_1 mm	l_4 mm	d_1 h6 mm	Z	TAX designation H3123118
Shank DIN 6535 HB	2	7	57	21	6	4	-2
	3	8	57	21	6	4	-3
	4	11	57	21	6	4	-4
	5	13	57	21	6	4	-5
	6	13	57	21	6	4	-6
	8	19	63	27	8	4	-8
	10	22	72	32	10	4	-10
	12	26	83	38	12	4	-12
	14	26	83	38	14	4	-14
	16	32	92	44	16	4	-16
	20	38	104	54	20	5	-20
	25	45	121	65	25	5	-25

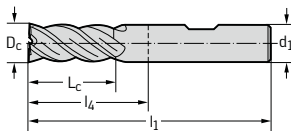

End mill Protostar® N 45



Materials to 48 HRC

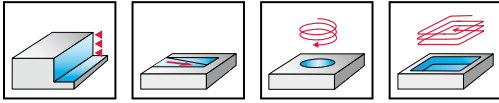

- solid carbide
- 4 to 5 cutting edges
- with centre cut
- 45° helix angle

Special features:

Slot milling: $a_p \leq 0.1 \times D_c$

Shoulder milling: $a_e \leq 0.05 \times D_c$

	P	M	K	N	S	H	O
TAX	●●	●	●	●	●	●	●

P standard L	D_c h10 mm	L_c mm	l_1 mm	l_4 mm	d_1 h6 mm	Z	TAX designation H3023418
Shank DIN 6535 HA	6	22	65	29	6	4	-6
	8	28	80	44	8	4	-8
	10	32	100	60	10	4	-10
	12	40	100	55	12	4	-12
	14	50	104	59	14	4	-14
	16	50	115	67	16	5	-16
	20	55	125	75	20	5	-20

P standard L	D_c h10 mm	L_c mm	l_1 mm	l_4 mm	d_1 h6 mm	Z	TAX designation H3123418
Shank DIN 6535 HB	6	22	65	29	6	4	-6
	8	28	80	44	8	4	-8
	10	32	100	60	10	4	-10
	12	40	100	55	12	4	-12
	14	50	104	59	14	4	-14
	16	50	115	67	16	5	-16
	20	55	125	75	20	5	-20

End mill Protostar® N 45



Materials to 48 HRC

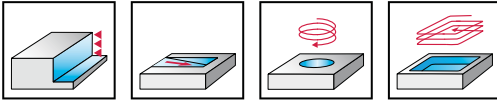

- solid carbide
- 4 to 8 cutting edges
- with centre cut
- 45° helix angle

Special features:

Slot milling: $a_p \leq 0.1 \times D_c$

Shoulder milling: $a_e \leq 0.05 \times D_c$

	P	M	K	N	S	H	O
TAX	●●	●					

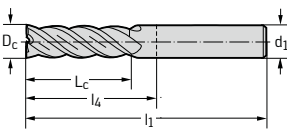
P standard XL		D_c h10 mm	L_c mm	l_1 mm	l_4 mm	d_1 h6 mm	Z	TAX designation H3023518
Shank DIN 6535 HA		6	35	80	44	6	4	-6X35
		8	45	97	61	8	4	-8X45
		10	50	118	78	10	4	-10X50
		12	60	120	75	12	4	-12X60
		16	65	130	82	16	5	-16X65
		16	80	145	97	16	5	-16X80
		20	75	145	95	20	6	-20X75
		20	100	170	120	20	6	-20X100
		25	90	153	97	25	8	-25X90
		25	125	188	132	25	8	-25X125

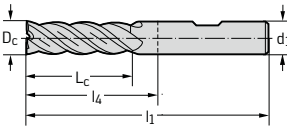
P standard XL		D_c h10 mm	L_c mm	l_1 mm	l_4 mm	d_1 h6 mm	Z	TAX designation H3123518
Shank DIN 6535 HB		4	20	65	29	6	4	-4X20
		5	25	65	29	6	4	-5X25
		6	35	80	44	6	4	-6X35
		8	45	97	61	8	4	-8X45
		10	50	118	78	10	4	-10X50
		12	60	120	75	12	4	-12X60
		14	70	124	79	14	4	-14X70
		16	65	130	82	16	5	-16X65
		16	80	145	97	16	5	-16X80
		18	90	155	107	18	5	-18X90
		20	75	145	95	20	6	-20X75
		20	100	170	120	20	6	-20X100
		25	90	153	97	25	8	-25X90
		25	125	188	132	25	8	-25X125

End mill Protostar® N 30



Materials to 48 HRC

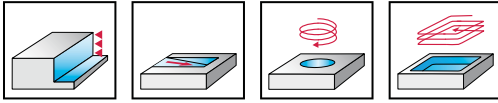

- solid carbide
- 4 cutting edges
- with centre cut
- 30° helix angle

Special features:

Slot milling: $a_p \leq 0.3 \times D_c$

Shoulder milling: $a_e \leq 0.3 \times D_c$

	P	M	K	N	S	H	O
TAX	●●	●	●	●	●	●	●

DIN 6527 K	D_c h10 mm	L_c mm	l_1 mm	l_4 mm	d_1 h6 mm	Z	TAX designation H3022018
Shank DIN 6535 HA	2	4	50	14	6	4	-2
	3	5	50	14	6	4	-3
	4	8	54	18	6	4	-4
	5	9	54	18	6	4	-5
	6	10	54	18	6	4	-6
	7	11	58	22	8	4	-7
	8	12	58	22	8	4	-8
	10	14	66	26	10	4	-10
	12	16	73	28	12	4	-12
	14	18	75	30	14	4	-14
	16	22	82	34	16	4	-16
	18	24	84	36	18	4	-18
	20	26	92	42	20	4	-20

DIN 6527 K	D_c h10 mm	L_c mm	l_1 mm	l_4 mm	d_1 h6 mm	Z	TAX designation H3122018
Shank DIN 6535 HB	2	4	50	14	6	4	-2
	3	5	50	14	6	4	-3
	4	8	54	18	6	4	-4
	5	9	54	18	6	4	-5
	6	10	54	18	6	4	-6
	7	11	58	22	8	4	-7
	8	12	58	22	8	4	-8
	10	14	66	26	10	4	-10
	12	16	73	28	12	4	-12
	14	18	75	30	14	4	-14
	16	22	82	34	16	4	-16
	18	24	84	36	18	4	-18
	20	26	92	42	20	4	-20

End mill Protostar® N 30



Materials to 48 HRC

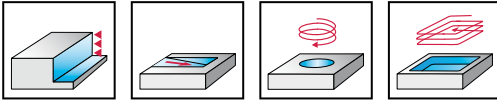

- solid carbide
- 4 cutting edges
- with centre cut
- 30° helix angle

Special features:

Slot milling: $a_p \leq 0.3 \times D_c$

Shoulder milling: $a_e \leq 0.1 \times D_c$

	P	M	K	N	S	H	O
uncoated	●	●●	■	■	■	■	■
TAX	●●	●	■	■	■	■	■

DIN 6527 L	D_c h10 mm	L_c mm	l_1 mm	l_4 mm	d_1 h6 mm	Z	uncoated designation H302211	TAX designation H3022118
Shank DIN 6535 HA	2	7	57	21	6	4	-2	-2
	2,5	8	57	21	6	4	-2.5	-2.5
	3	8	57	21	6	4	-3	-3
	3,5	10	57	21	6	4	-3.5	-3.5
	4	11	57	21	6	4	-4	-4
	4,5	11	57	21	6	4	-4.5	-4.5
	5	13	57	21	6	4	-5	-5
	5,5	13	57	21	6	4	-5.5	-5.5
	6	13	57	21	6	4	-6	-6
	6,5	16	63	27	8	4	-6.5	-6.5
	7	16	63	27	8	4	-7	-7
	8	19	63	27	8	4	-8	-8
	9	19	72	32	10	4	-9	-9
	10	22	72	32	10	4	-10	-10
	12	26	83	38	12	4	-12	-12
	14	26	83	38	14	4	-14	-14
	16	32	92	44	16	4	-16	-16
	18	32	92	44	18	4	-18	-18
	20	38	104	54	20	4	-20	-20

DIN 6527 L	D_c h10 mm	L_c mm	l_1 mm	l_4 mm	d_1 h6 mm	Z	TAX designation H3122118
Shank DIN 6535 HB	2	7	57	21	6	4	-2
	2,5	8	57	21	6	4	-2.5
	3	8	57	21	6	4	-3
	4	11	57	21	6	4	-4
	5	13	57	21	6	4	-5
	6	13	57	21	6	4	-6
	7	16	63	27	8	4	-7
	8	19	63	27	8	4	-8
	9	19	72	32	10	4	-9
	10	22	72	32	10	4	-10
	12	26	83	38	12	4	-12
	14	26	83	38	14	4	-14
	16	32	92	44	16	4	-16
	18	32	92	44	18	4	-18
	20	38	104	54	20	4	-20
	25	45	121	65	25	4	-25

End mill Protostar® N 30



Materials to 48 HRC

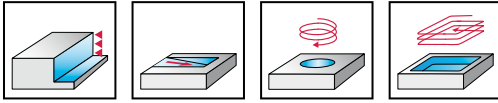

- solid carbide
- 4 to 6 cutting edges
- with centre cut
- 30° helix angle

Special features:

Slot milling: $a_p \leq 0.3 \times D_c$

Shoulder milling: $a_e \leq 0.3 \times D_c$

	P	M	K	N	S	H	O
TAX	●●	●					

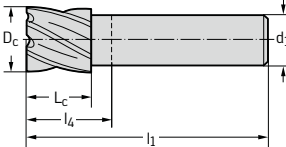
P standard S	D_c h10 mm	L_c mm	l_1 mm	l_4 mm	d_1 h6 mm	Z	TAX designation H3058917
Shank DIN 6535 HA	8	10	50	14	6	4	-8
	10	12	50	14	8	4	-10
	12	15	60	20	10	4	-12
	14	15	60	20	10	4	-14
	16	15	60	20	10	4	-16
	20	18	65	20	12	5	-20
	25	20	75	27	16	6	-25

with reduced clamping diameter
for CNC automatic lathes

End mill Protostar® HSC 30



Materials to 55 HRC

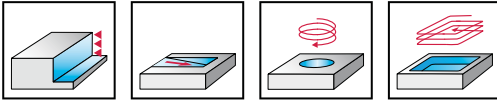

- solid carbide
- long reach
- 4 cutting edges
- with centre cut
- 30° helix angle

Special features:

Slot milling: $a_p \leq 0.1 \times D_c$

Shoulder milling: $a_e \leq 0.1 \times D_c$

	P	M	K	N	S	H	O
TAX	●●	●					

P-Norm XL	D_c	L_c	l_1	l_4	d_1	Z	TAX designation H3093418
	h10 mm				h5 mm		
Shank DIN 6535 HA	6,3	6	100	64	6	4	-6.3
	8,3	8	100	64	8	4	-8.3
	10,3	10	150	110	10	4	-10.3
	12,5	12	150	105	12	4	-12.5 ¹
	14,5	14	150	105	14	4	-14.5 ¹
	16,5	16	150	102	16	4	-16.5 ¹

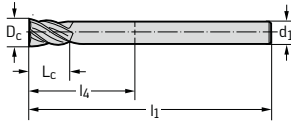

¹Shank tolerance h6

**End mill
Protostar® H 30
Ultra**



Materials from 55 to 65 HRC

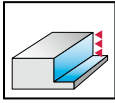

Special features:

Slot milling: $a_p \leq 0.1 \times D_c$

Shoulder milling: $a_e \leq 0.05 \times D_c$

- solid carbide
- 6 to 16 cutting edges
- without centre cut
- 30° helix angle

	P	M	K	N	S	H	O
TAX						●●	

DIN 6527 L	D_c h10 mm	L_c mm	l_1 mm	l_4 mm	d_1 h5 mm	Z	TAX designation H3178128
Shank DIN 6535 HB	5	13	57	21	6	6	-5
	6	13	57	21	6	6	-6
	8	19	63	27	8	8	-8
	10	22	72	32	10	10	-10
	12	26	83	38	12	12	-12
	16	32	92	44	16	16	-16

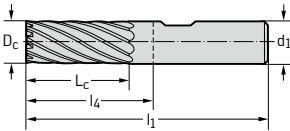

End mill with corner radius Protostar® N 50



Materials to 48 HRC

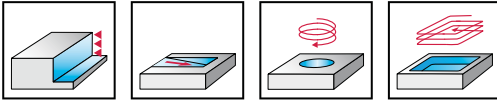

- solid carbide
- 6 to 8 cutting edges
- without centre cut
- 50° helix angle

Special features:

Slot milling: $a_p \leq 0.1 \times D_c$

Shoulder milling: $a_e \leq 0.1 \times D_c$

	P	M	K	N	S	H	O
TAX	●●	●	●	●	●	●	●

P standard	D_c h9 mm	R mm	L_c mm	d_2 mm	l_1 mm	l_4 mm	SW mm	d_1	Z	TAX
										designation H3E23138
	10	0,5	5,5	9,7	23,6	12,4	8	E 10	6	-E10-10-0.5
	10	1	5,5	9,7	23,6	12,4	8	E 10	6	-E10-10-1
	12	0,5	6,5	11,7	28,3	14,5	10	E 12	6	-E12-12-0.5
	12	1	6,5	11,7	28,3	14,5	10	E 12	6	-E12-12-1
	12	1,5	6,5	11,7	28,3	14,5	10	E 12	6	-E12-12-1.5
	16	0,5	8,5	15,5	35,7	18,7	12	E 16	6	-E16-16-0.5
	16	1	8,5	15,5	35,7	18,7	12	E 16	6	-E16-16-1
	16	1,5	8,5	15,5	35,7	18,7	12	E 16	6	-E16-16-1.5
	16	2	8,5	15,5	35,7	18,7	12	E 16	6	-E16-16-2
	20	1	11	19,3	40,8	21,3	16	E 20	8	-E20-20-1
	20	1,5	11	19,3	40,8	21,3	16	E 20	8	-E20-20-1.5
	20	2	11	19,3	40,8	21,3	16	E 20	8	-E20-20-2
	20	4	11	19,3	40,8	21,3	16	E 20	8	-E20-20-4
	25	1	13,5	24,2	49,6	25,6	20	E 25	8	-E25-25-1
	25	2	13,5	24,2	49,6	25,6	20	E 25	8	-E25-25-2
	25	4	13,5	24,2	49,6	25,6	20	E 25	8	-E25-25-4

End mill with corner radius

Protostar® H 50

Ultra



Materials from 48 to 63 HRC

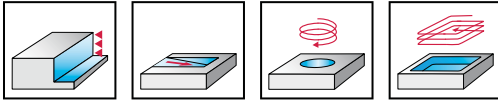

- solid carbide
- 4 to 8 cutting edges
- without centre cut
- 50° helix angle

Special features:

Slot milling: $a_p \leq 0.1 \times D_c$

Shoulder milling: $a_e \leq 0.1 \times D_c$

	P	M	K	N	S	H	O
TAX						●●	

DIN 6527 L	D_c h9 mm	R mm	L_c mm	l_1 mm	l_4 mm	d_1 h5 mm	Z	TAX designation H8082228
Shank DIN 6535 HA	3	0,5	8	57	21	6	4	-3-0.5
	4	0,5	11	57	21	6	4	-4-0.5
	4	1	11	57	21	6	4	-4-1
	5	0,5	13	57	21	6	6	-5-0.5
	5	1	13	57	21	6	6	-5-1
	6	0,5	13	57	21	6	6	-6-0.5
	6	1	13	57	21	6	6	-6-1
	8	0,5	19	63	27	8	6	-8-0.5
	8	1	19	63	27	8	6	-8-1
	8	2	19	63	27	8	6	-8-2
	10	0,5	22	72	32	10	6	-10-0.5
	10	1	22	72	32	10	6	-10-1
	10	1,5	22	72	32	10	6	-10-1.5
	10	2	22	72	32	10	6	-10-2
	12	1	26	83	38	12	6	-12-1
	12	1,5	26	83	38	12	6	-12-1.5
	12	3	26	83	38	12	6	-12-3
	16	1,5	32	92	44	16	6	-16-1.5
	16	2	32	92	44	16	6	-16-2
	16	4	32	92	44	16	6	-16-4
20	1,5	38	104	54	20	8	-20-1.5	
20	2	38	104	54	20	8	-20-2	
20	4	38	104	54	20	8	-20-4	

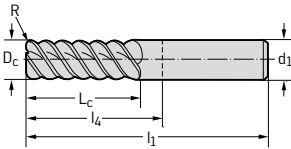

End mill with corner radius Protostar® Ti 45

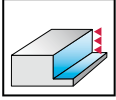

Special features:

Shoulder milling: $a_e \leq 0.3 \times D_c$

- solid carbide
- 4 to 5 cutting edges
- with centre cut
- 45° helix angle

	P	M	K	N	S	H	O
ACN			●		●●		

P standard XL	D_c	R	L_c	l_1	l_4	d_1	Z	ACN designation H7073417
	h9 mm					h6 mm		
Shank DIN 6535 HA	16	3	50	115	67	16	4	-16X50-3
	16	3	90	145	97	16	4	-16X90-3
	16	4	50	115	67	16	4	-16X50
	16	4	90	145	97	16	4	-16X90
	20	3	55	125	75	20	4	-20X55-3
	20	3	100	170	120	20	4	-20X100-3
	20	4	55	125	75	20	4	-20X55
	20	4	100	170	120	20	4	-20X100
	25	3	90	153	97	25	5	-25X90-3
	25	3	125	188	132	25	5	-25X125-3
	25	4	90	153	97	25	5	-25X90
	25	4	125	188	132	25	5	-25X125

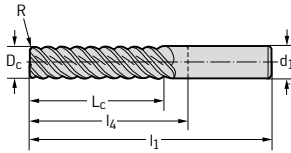

End mill with corner radius Protostar® HSC 30



Materials to 52 HRC

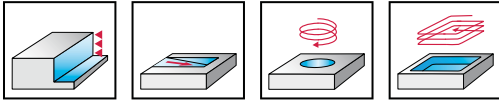

- solid carbide
- long reach
- 4 cutting edges
- with centre cut
- 30° helix angle

Special features:

Slot milling: $a_p \leq 0.5 \times D_c$

Shoulder milling: $a_e \leq 0.3 \times D_c$

	P	M	K	N	S	H	O
TAX	●●			●			

P standard L	D_c h9 mm	R mm	L_c mm	l_3 mm	d_2 mm	l_1 mm	l_4 mm	d_1 h5 mm	Z	TAX designation H8018718
Shank DIN 6535 HA	4	0,5	4	20	3,8	57	21	6	4	-4
	5	0,5	5	20	4,75	57	21	6	4	-5
	6	1	6	24	5,7	63	27	8	4	-6
	8	1	8	29	7,6	72	32	10	4	-8
	10	1,5	10	35	9,5	83	38	12	4	-10 ¹
	12	1,5	12	36	11,4	83	38	12	4	-12 ¹
	16	2	16	42	15,2	92	44	16	4	-16 ¹

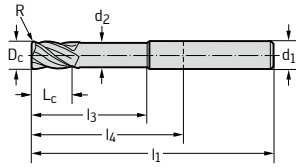

¹Shank tolerance h6

Mini end mill Protostar® HSC 30



Materials to 48 HRC

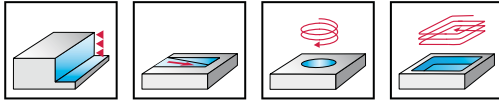

- solid carbide
- long reach
- 2 cutting edges
- with centre cut
- 30° helix angle

Special features:

Slot milling: $a_p \leq 0.1 \times D_c$

Shoulder milling: $a_e \leq 0.05 \times D_c$

	P	M	K	N	S	H	O
uncoated				●●			
TAX	●●			●			

P standard mini	D _c h7 mm	R mm	L _c mm	l ₃ mm	d ₂ mm	l ₁ mm	l ₄ mm	d ₁ h5 mm	Z	uncoated designation H404491	TAX designation H4044918
Shank DIN 6535 HA 	0,4	0,05	0,4	1	0,37	38	10	3	2	-0.4-1	-0.4-1
	0,4	0,05	0,4	2	0,37	38	10	3	2	-0.4-2	-0.4-2
	0,4	0,05	0,4	4	0,37	38	10	3	2	-0.4-4	-0.4-4
	0,5	0,05	0,5	1,25	0,47	38	10	3	2	-0.5-1.25	-0.5-1.25
	0,5	0,05	0,5	2,5	0,47	38	10	3	2	-0.5-2.5	-0.5-2.5
	0,5	0,05	0,5	5	0,47	38	10	3	2	-0.5-5	-0.5-5
	0,6	0,05	0,6	1,5	0,57	38	10	3	2	-0.6-1.5	-0.6-1.5
	0,6	0,05	0,6	3	0,57	38	10	3	2	-0.6-3	-0.6-3
	0,6	0,05	0,6	4,5	0,57	38	10	3	2	-0.6-4.5	-0.6-4.5
	0,6	0,05	0,6	6	0,57	38	10	3	2	-0.6-6	-0.6-6
	0,6	0,05	0,6	9	0,57	38	10	3	2	-0.6-9	-0.6-9
	0,8	0,05	0,8	2	0,77	38	10	3	2	-0.8-2	-0.8-2
	0,8	0,05	0,8	4	0,77	38	10	3	2	-0.8-4	-0.8-4
	0,8	0,05	0,8	6	0,77	38	10	3	2	-0.8-6	-0.8-6
	0,8	0,05	0,8	8	0,77	38	10	3	2	-0.8-8	-0.8-8
	0,8	0,05	0,8	12	0,77	60	32	3	2	-0.8-12	-0.8-12
	1	0,1	1	2,5	0,97	38	10	3	2	-1-2.5	-1-2.5
	1	0,1	1	5	0,97	60	32	3	2	-1-5	-1-5
	1	0,1	1	7,5	0,97	60	32	3	2	-1-7.5	-1-7.5
	1	0,1	1	10	0,97	60	32	3	2	-1-10	-1-10
	1	0,1	1	15	0,97	60	32	3	2	-1-15	-1-15
	1	0,1	1	20	0,97	60	32	3	2	-1-20	-1-20
	1,5	0,15	1,5	7,5	1,47	60	32	3	2	-1.5-7.5	-1.5-7.5
	1,5	0,15	1,5	15	1,47	60	32	3	2	-1.5-15	-1.5-15
	2	0,2	2	10	1,97	60	32	3	2	-2-10	-2-10
	2	0,2	2	15	1,97	60	32	3	2	-2-15	-2-15
	2	0,2	2	20	1,97	60	32	3	2	-2-20	-2-20
	2	0,2	2	30	1,97	60	32	3	2	-2-30	-2-30
	2,5	0,25	2,5	12,5	2,47	60	32	3	2	-2.5-12.5	-2.5-12.5
	2,5	0,25	2,5	25	2,47	60	32	3	2	-2.5-25	-2.5-25
3	0,3	3	15	2,97	60	32	3	2	-3-15	-3-15	
3	0,3	3	22,5	2,97	60	32	3	2	-3-22.5	-3-22.5	
3	0,3	3	30	2,97	60	32	3	2	-3-30	-3-30	

**PCD shoulder mill
F 4722**

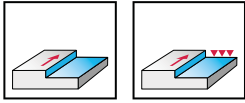

- κ = 90°
- WCD 10

	P	M	K	N	S	H	O
.D				●●			●

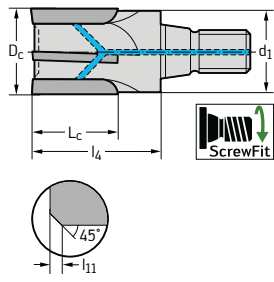
Tool	D _c mm	l ₁₁ mm	L _c mm	l ₁ mm	l ₄ mm	d ₁	Z	kg	designation
	20	0,2	18	-	30	T18	4	0,1	F4722.T18.020.Z04.20.D
	25	0,2	20	-	35	T22	4	0,2	F4722.T22.025.Z04.20.D
	32	0,2	20	-	40	T28	4	0,3	F4722.T28.032.Z04.20.D
	40	0,2	20	-	40	T36	4	0,5	F4722.T36.040.Z04.20.D

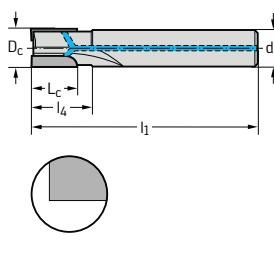
Tool	D _c mm	l ₁₁ mm	L _c mm	l ₁ mm	l ₄ mm	d ₁ mm	Z	kg	designation
	6	-	8	50	13	6	2	0,1	F4722.Z06.06.Z02.08.D
	8	-	10	70	15	8	2	0,1	F4722.Z08.08.Z02.10.D
	10	-	12	80	17	10	2	0,1	F4722.Z10.10.Z02.12.D
	12	-	16	80	21	12	2	0,1	F4722.Z12.12.Z02.16.D
	16	-	20	90	25	16	2	0,1	F4722.Z16.16.Z02.20.D
	20	-	20	100	25	20	2	0,1	F4722.Z20.20.Z02.20.D

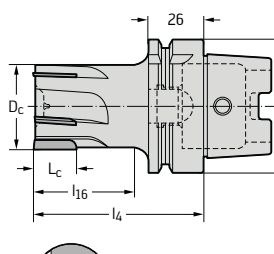
Tool	D _c mm	l ₁₁ mm	L _c mm	l ₁ mm	l ₄ mm	d ₁	Z	kg	designation
	25	0,2	20	110	56	HSK-A63	4	1,0	F4722.H63A.025.Z04.20.D
	32	0,2	20	110	62	HSK-A63	4	1,2	F4722.H63A.032.Z04.20.D
	40	0,2	20	80	54	HSK-A63	5	1,2	F4722.H63A.040.Z05.20.D

Pre-balanced to G 6.3 where n = 16000 rpm
Order example: F4722.T18.020.Z04.20 . . with WCD 10 = F4722.T18.020.Z04.20.D
For flat wrenches for screw heads, see page G 106.

.D = WCD 10

Porcupine cutter F 1375 / F 16 . . with brazed cutting edges

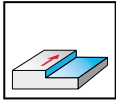

	P	M	K	N	S	H	O
.K			●●				

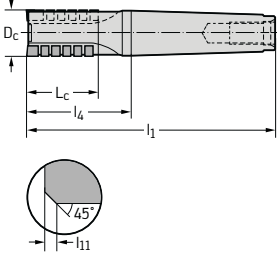
Tool	D_c js16 mm	l_{11} mm	L_c mm	l_1 mm	l_4 mm	d_1	Z	Helical pitch	kg	designation
Shank DIN 228, Form A 	20	0,5	40	124,0	60	MK 2	2	163	0,2	F1605.M.020.Z02.40.K
	25	0,5	50	151,0	70	MK 3	2	204	0,4	F1605.M.025.Z02.50.K
	28	0,5	50	156,0	75	MK 3	2	230	0,5	F1605.M.028.Z02.50.K
	32	0,5	50	177,5	75	MK 4	2	262	0,7	F1605.M.032.Z02.50.K
	40	0,8	63	197,5	95	MK 4	2	327	1,2	F1605.M.040.Z02.63.K

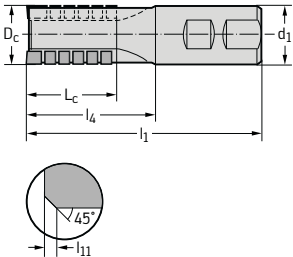
Tool	D_c js16 mm	l_{11} mm	L_c mm	l_1 mm	l_4 mm	d_1 mm	Z	Helical pitch	kg	designation
Shank DIN 1835, form B 	20	0,5	40	105,0	54	20	2	163	0,2	F1616.W.020.Z02.40.K
	25	0,5	50	125,0	68	25	2	204	0,4	F1616.W.025.Z02.50.K
	28	0,5	50	125,0	68	25	2	230	0,5	F1616.W.028.Z02.50.K
	32	0,5	50	130,0	69	32	2	262	0,7	F1616.W.032.Z02.50.K
	40	0,8	63	145,0	84	32	2	327	1,0	F1616.W.040.Z02.63.K

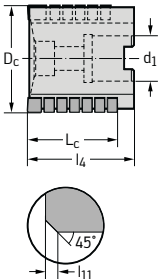
Tool	D_c js16 mm	l_{11} mm	L_c mm	l_1 mm	l_4 mm	d_1 mm	Z	Helical pitch	kg	designation
Cylindrical bore DIN 138 longitudinal key way 	50	0,8	40	-	50	22	3	409	0,5	F1375.B.050.Z03.40.K
	63	0,8	50	-	63	27	3	515	0,9	F1375.B.063.Z03.50.K
	80	1,0	50	-	63	32	4	654	1,5	F1375.B.080.Z04.50.K
	100	1,0	63	-	80	40	4	818	2,9	F1375.B.100.Z04.63.K

.K = Cast iron machining

Heli milling cutters

F 16 . .

with brazed cutting edges

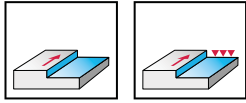

	P	M	K	N	S	H	O
.K			●●				
.P	●●						

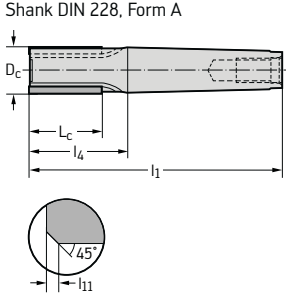
Tool	D _c js16 mm	l ₁₁ mm	L _c mm	l ₁ mm	l ₄ mm	d ₁	Z	Helical pitch	kg	designation
Shank DIN 228, Form A 	20	0,5	40	124,0	60	MK 2	3	140	0,2	F1677.M.020.Z03.40.K F1677.M.020.Z03.40.P
	25	0,5	50	151,0	70	MK 3	4	160	0,4	F1677.M.025.Z04.50.K F1677.M.025.Z04.50.P
	32	0,5	50	177,5	75	MK 4	4	224	0,7	F1677.M.032.Z04.50.K F1677.M.032.Z04.50.P
	40	0,8	63	197,5	95	MK 4	6	270	1,2	F1677.M.040.Z06.63.K F1677.M.040.Z06.63.P

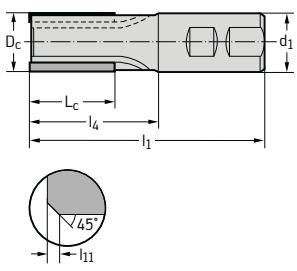
Tool	D _c js16 mm	l ₁₁ mm	L _c mm	l ₁ mm	l ₄ mm	d ₁ mm	Z	Helical pitch	kg	designation
Shank DIN 1835, form B 	16	0,5	32	95,0	46	16	2	100	0,1	F1678.W.016.Z02.32.K F1678.W.016.Z02.32.P
	20	0,5	40	105,0	54	20	3	140	0,2	F1678.W.020.Z03.40.K F1678.W.020.Z03.40.P
	25	0,5	50	125,0	68	25	4	160	0,4	F1678.W.025.Z04.50.K F1678.W.025.Z04.50.P
	32	0,5	50	130,0	69	32	4	224	0,7	F1678.W.032.Z04.50.K F1678.W.032.Z04.50.P
40	0,8	63	145,0	84	32	6	270	1,0	F1678.W.040.Z06.63.K F1678.W.040.Z06.63.P	

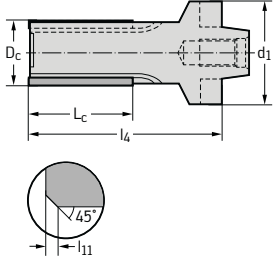
Tool	D _c js16 mm	l ₁₁ mm	L _c mm	l ₁ mm	l ₄ mm	d ₁	Z	Helical pitch	kg	designation
Modular adaptor NCT 	32	0,5	50	-	110	NCT 63	4	224	1,0	F1682.N6.032.Z04.50.K F1682.N6.032.Z04.50.P
	40	0,8	63	-	120	NCT 63	6	270	1,3	F1682.N6.040.Z06.63.K F1682.N6.040.Z06.63.P
	50	0,8	80	-	135	NCT 80	6	320	2,3	F1682.N8.050.Z06.80.K F1682.N6.040.Z06.63.P
	63	0,8	100	-	150	NCT 80	6	420	3,3	F1682.N8.063.Z06.100.K F1682.N8.063.Z06.100.P

.K = Cast iron machining
.P = Steel machining

Heli milling cutters F 16 . . with brazed cutting edges

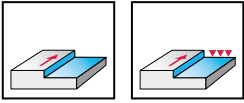

	P	M	K	N	S	H	O
.K			●●				
.P	●●						

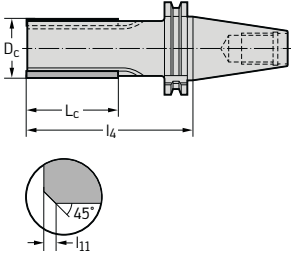
Tool	D_c js16 mm	l_{11} mm	L_c mm	l_1 mm	l_4 mm	d_1	Z	Helical pitch	kg	designation
Combi-shank DIN 69871 + 2080 	40	0,8	63	-	115	SK 40	6	270	1,5	F1676.S4.040.Z06.63.K F1676.S4.040.Z06.63.P
	50	0,8	80	-	135	SK 50	6	320	4,3	F1676.S5.050.Z06.80.K F1676.S5.050.Z06.80.P
	63	0,8	100	-	155	SK 50	6	420	5,3	F1676.S5.063.Z06.100.K F1676.S5.063.Z06.100.P

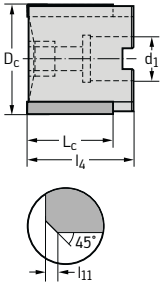
Tool	D_c js16 mm	l_{11} mm	L_c mm	l_1 mm	l_4 mm	d_1 mm	Z	Helical pitch	kg	designation
Cylindrical bore DIN 138 longitudinal key way 	50	0,8	40	-	50	22	6	320	0,5	F1675.B.050.Z06.40.K F1675.B.050.Z06.40.P
	63	0,8	50	-	63	27	6	420	0,9	F1675.B.063.Z06.50.K F1675.B.063.Z06.50.P
	80	1,0	50	-	63	32	8	540	1,5	F1675.B.080.Z06.50.K F1675.B.080.Z06.50.P
	100	1,0	63	-	80	40	8	675	2,9	F1675.B.100.Z06.63.K F1675.B.100.Z06.63.P

.K = Cast iron machining

.P = Steel machining

PCD face milling cutters

F 4723

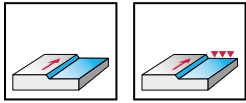

- $\kappa = 75^\circ / 90^\circ$
- WCD 10

	P	M	K	N	S	H	O
.D				●●			●

Tool	D_c mm	l_{11} mm	L_c mm	l_4 mm	d_1 mm	Z	kg	designation
$\kappa = 75^\circ$ to $L_c = 1.1$	50	0,1	5	40	22	5	0,5	F4723.B22.050.Z05.05.D
	63	0,1	5	40	22	5	0,6	F4723.B22.063.Z05.05.D
	80	0,1	5	50	27	6	1,0	F4723.B27.080.Z06.05.D
	100	0,1	5	50	32	8	1,4	F4723.B32.100.Z08.05.D
	125	0,1	5	63	40	8	2,8	F4723.B40.125.Z08.05.D

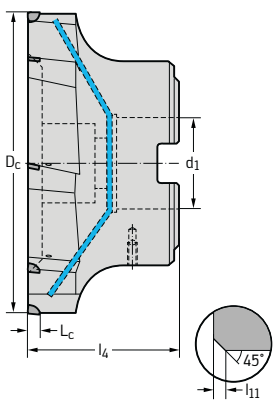

Pre-balanced to G 6.3 where $n = 16000$ rpm
 Order example: F4723.B22.050.Z05.05 . . with WCD 10 = F4723.B22.050.Z05.05.D
 Bodies and assembly parts are included in the scope of delivery.

Assembly parts

	Balancing screw DIN 913	M 4 x 6		
--	----------------------------	---------	--	--

Accessories

	DIN 911 Allen key for balancing screw	SW 2		
--	--	------	--	--

.D = WCD 10

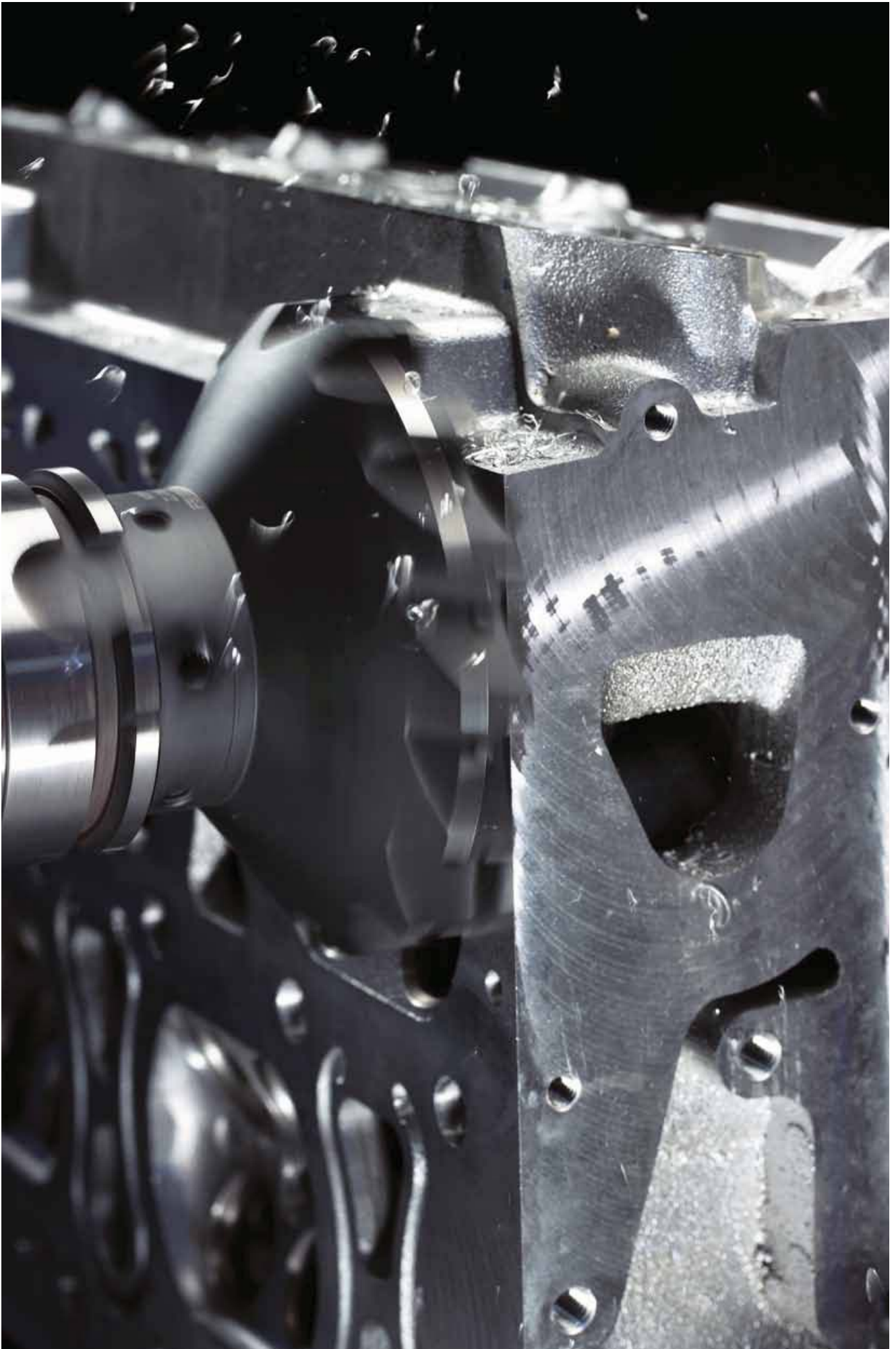

Walter Select – Shoulder / slot milling without corner radius

Solid carbide end mills

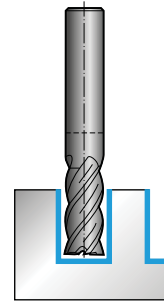
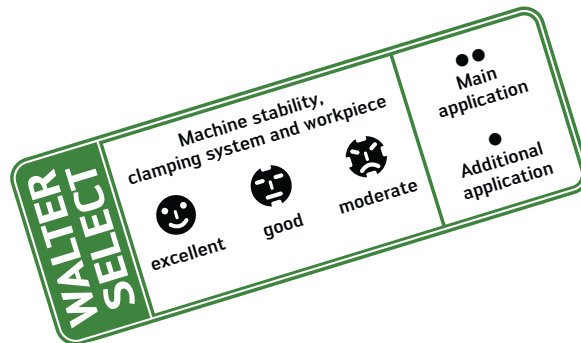
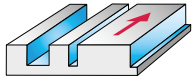

Solid carbide end mills

Machining conditions	☺			
Dia. range	2 – 20			
Number of teeth	3 + 4			
Coating	TAZ			
	Family	Designation	λ	Page

Material group	Classification of the main material groups and code letters		Brinell hardness HB	Tensile strength R_m N/mm ²	Machining group	Machining conditions			
	Workpiece material					Family	Designation	λ	Page
P	Unalloyed and low-alloyed steel	annealed (tempered)	210	700	P1, P2, P3, P4, P7	Proto-max™ _{ST}	H4034217	50°	E 82
		Free cutting steel	220	750	P6		H4033217	45°	E 83
		tempered	300	1010	P5, P8				
		tempered	380	1280	P9				
		tempered	430	1480	P10				
	High-alloyed steel and high-alloyed tool steel	annealed	200	670	P11				
		hardened and tempered	300	1010	P12				
		hardened and tempered	400	1360	P13				
	Stainless steel	ferritic / martensitic, annealed	200	670	P14				
		martensitic, tempered	330	1110	P15				
M	Stainless steel	austenitic, duplex	230	780	M1, M3				
		austenitic, precipitation hardened (PH)	300	1010	M2				
K	Grey cast iron		245	–	K3, K4				
	Cast iron with spheroidal graphite	ferritic, pearlitic	365	–	K1, K2, K5, K6				
	GGV (CGI)		200	–	K7				
N	Aluminium wrought alloys	cannot be hardened	30	–	N1				
		hardenable, hardened	100	340	N2				
	Cast aluminium alloys	≤ 12 % Si	90	310	N3, N4				
		> 12 % Si	130	450	N5				
	Magnesium alloys		70	250	N6				
	Copper and copper alloys (bronze / brass)	unalloyed, electrolytic copper		100	340	N7			
Brass, bronze, red brass			90	310	N8				
Cu-alloys, short-chipping			110	380	N9				
high-strength, Ampco			300	1010	N10				
S	Heat-resistant alloys	Fe-based	280	940	S1, S2				
		Ni or Co base	250	840	S3				
		Ni or Co base	350	1080	S4, S5				
	Titanium alloys	Pure titanium	200	670	S6				
		α and β alloys, hardened	375	1260	S7				
		β alloys	410	1400	S8				
	Tungsten alloys		300	1010	S9				
Molybdenum alloys		300	1010	S10					
H	Hardened steel		50 HRC	–	H1				
			55 HRC	–	H2, H4				
			60 HRC	–	H3				
O	Thermoplasts	without abrasive fillers			O1				
	Thermosetting plastics	without abrasive fillers			O2				
	Fibre-reinforced plastic	GFRP, AFRP			O3, O5				
		CFRP			O4				
Graphite (technical)			65	O6					

Walter Select – Shoulder / slot milling without corner radius Solid carbide end mills

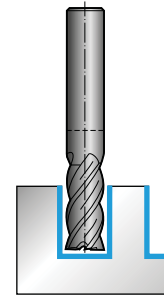
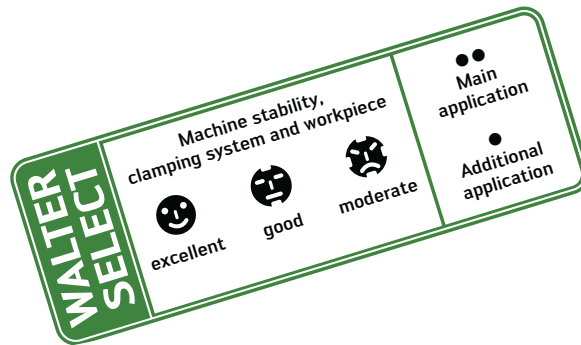
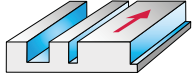

Solid carbide end mills

Material group	Classification of the main material groups and code letters	Workpiece material	Brinell hardness HB	Tensile strength R_m N/mm ²	Machining group	Machining conditions			
						Family	Designation	λ	Page
						Machining conditions: Dia. range: 6,3 – 16,5 Number of teeth: 2 Coating: TAX			
						HSC 30	H3090418	30°	E 105
P	Unalloyed and low-alloyed steel	annealed (tempered)	210	700	P1, P2, P3, P4, P7		●●		
		Free cutting steel	220	750	P6		●●		
		tempered	300	1010	P5, P8		●●		
		tempered	380	1280	P9		●●		
		tempered	430	1480	P10		●●		
	High-alloyed steel and high-alloyed tool steel	annealed	200	670	P11		●●		
		hardened and tempered	300	1010	P12		●●		
		hardened and tempered	400	1360	P13		●●		
	Stainless steel	ferritic / martensitic, annealed	200	670	P14		●●		
		martensitic, tempered	330	1110	P15		●●		
M	Stainless steel	austenitic, duplex	230	780	M1, M3				
		austenitic, precipitation hardened (PH)	300	1010	M2				
K	Grey cast iron		245	–	K3, K4				
	Cast iron with spheroidal graphite	ferritic, pearlitic	365	–	K1, K2, K5, K6				
	GGV (CGI)		200	–	K7				
N	Aluminium wrought alloys	cannot be hardened	30	–	N1		●		
		hardenable, hardened	100	340	N2		●		
	Cast aluminium alloys	≤ 12 % Si	90	310	N3, N4		●		
		> 12 % Si	130	450	N5		●		
	Magnesium alloys		70	250	N6		●		
	Copper and copper alloys (bronze / brass)	unalloyed, electrolytic copper	100	340	N7		●		
		Brass, bronze, red brass	90	310	N8		●		
		Cu-alloys, short-chipping	110	380	N9		●		
		high-strength, Ampco	300	1010	N10		●		
S	Heat-resistant alloys	Fe-based	280	940	S1, S2				
		Ni or Co base	250	840	S3				
		Ni or Co base	350	1080	S4, S5				
	Titanium alloys	Pure titanium	200	670	S6				
		α and β alloys, hardened	375	1260	S7				
		β alloys	410	1400	S8				
	Tungsten alloys		300	1010	S9				
	Molybdenum alloys		300	1010	S10				
H	Hardened steel		50 HRC	–	H1				
			55 HRC	–	H2, H4				
			60 HRC	–	H3				
O	Thermoplasts	without abrasive fillers			O1		●		
	Thermosetting plastics	without abrasive fillers			O2		●		
	Fibre-reinforced plastic	GFRP, AFRP			O3, O5				
		CFRP			O4				
	Graphite (technical)			65	O6				

Walter Select – Shoulder / slot milling without corner radius HSS end mills

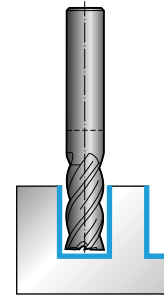
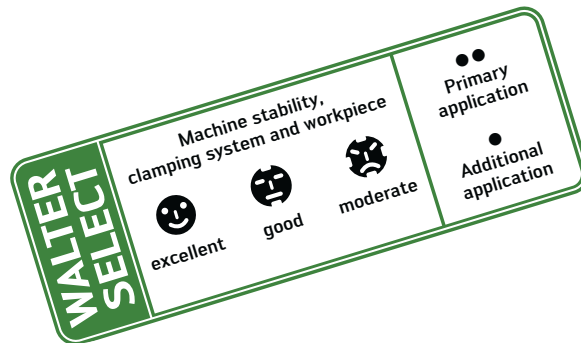
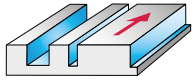

HSS end mills

Material group		Classification of the main material groups and code letters	Workpiece material	Brinell hardness HB	Tensile strength R_m N/mm ²	Machining group	Machining conditions			
							Family	Designation	λ	Page
Machining conditions							☹			
Dia. range							3 – 25			
Number of teeth							3 – 8			
Coating							ACN			
							N 45	P3123117	45°	E 108
							N 30	P3122117 P3122317	30° 30°	E 118 E 120
P	Unalloyed and low-alloyed steel	annealed (tempered)		210	700	P1, P2, P3, P4, P7	••			
		Free cutting steel		220	750	P6	••			
		tempered		300	1010	P5, P8	••			
		tempered		380	1280	P9	••			
		tempered		430	1480	P10	••			
	High-alloyed steel and high-alloyed tool steel	annealed		200	670	P11	••			
		hardened and tempered		300	1010	P12	••			
		hardened and tempered		400	1360	P13	••			
	Stainless steel	ferritic / martensitic, annealed		200	670	P14	••			
		martensitic, tempered		330	1110	P15	••			
M	Stainless steel	austenitic, duplex		230	780	M1, M3	•			
		austenitic, precipitation hardened (PH)		300	1010	M2	•			
K	Grey cast iron			245	–	K3, K4				
	Cast iron with spheroidal graphite	ferritic, pearlitic		365	–	K1, K2, K5, K6				
	GGV (CGI)			200	–	K7				
N	Aluminium wrought alloys	cannot be hardened		30	–	N1	•			
		hardenable, hardened		100	340	N2	•			
	Cast aluminium alloys	≤ 12 % Si		90	310	N3, N4	•			
		> 12 % Si		130	450	N5	•			
	Magnesium alloys			70	250	N6	•			
S	Copper and copper alloys (bronze / brass)	unalloyed, electrolytic copper		100	340	N7	•			
		Brass, bronze, red brass		90	310	N8	•			
		Cu-alloys, short-chipping		110	380	N9	•			
		high-strength, Ampco		300	1010	N10	•			
S	Heat-resistant alloys	Fe-based		280	940	S1, S2				
		Ni or Co base		250	840	S3				
		Ni or Co base		350	1080	S4, S5				
	Titanium alloys	Pure titanium		200	670	S6				
		α and β alloys, hardened		375	1260	S7				
Tungsten alloys			410	1400	S8					
Molybdenum alloys			300	1010	S9					
H	Hardened steel			50 HRC	–	H1				
				55 HRC	–	H2, H4				
				60 HRC	–	H3				
O	Thermoplasts	without abrasive fillers				O1				
	Thermosetting plastics	without abrasive fillers				O2				
	Fibre-reinforced plastic	GFRP, AFRP					O3, O5			
		CFRP					O4			
Graphite (technical)				65	O6					

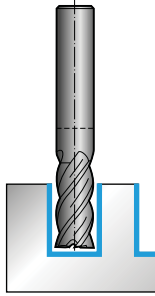

HSS end mills

1					2				3				4			
2 - 50					1 - 32				1 - 50				2 - 20			
2 - 8					2 - 8				2 - 8				3			
uncoated					ACN				uncoated				ACN			
Family	Designation	λ	Page		Family	Designation	λ	Page	Family	Designation	λ	Page	Family	Designation	λ	Page
W 40	P312411	40°	E 109		N 45	P3123017	45°	E 108	N 45	P312301	45°	E 108	Inox V 40	P4117027	40°	E 110
	P312401	40°	E 109						N 30	P302211	30°	E 118				
AL 40	P602612	40°	E 112		30	P3122017	30°	E 116	30	P312211	30°	E 118				
	P612612	40°	E 112			P3106117	30°	E 113		P312221	30°	E 120				
	P602602	40°	E 111			P3116127	30°	E 115		P302201	30°	E 116				
	P612602	40°	E 111			P3117127	30°	E 122		P312201	30°	E 116				
AL 25	P632612	25°	E 125						30	P302621	30°	E 121				
										P311722	30°	E 123				
										P300611	30°	E 113				
										P310611	30°	E 113				
										P301612	30°	E 114				
										P311712	30°	E 122				
										P312673	30°	E 124				
										P312771	30°	E 124				

Walter Select – Shoulder / slot milling without corner radius HSS shell end mill

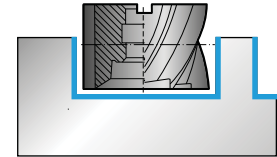
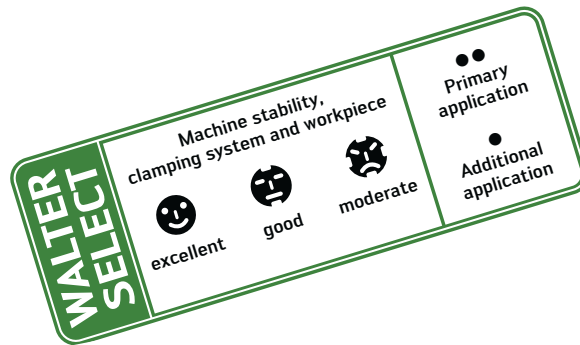
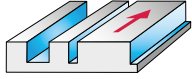

Shell end mills

Material group		Classification of the main material groups and code letters	Workpiece material	Brinell hardness HB	Tensile strength R _m N/mm ²	Machining group	Machining conditions			
							Family	Designation	λ	Page
							Dia. range 40 – 100			
							Number of teeth 8 – 12			
							Coating uncoated			
							N 30	P020401	30°	E 126
P	Unalloyed and low-alloyed steel	annealed (tempered)		210	700	P1, P2, P3, P4, P7	●●			
		Free cutting steel		220	750	P6	●●			
		tempered		300	1010	P5, P8	●●			
		tempered		380	1280	P9	●●			
		tempered		430	1480	P10	●●			
	High-alloyed steel and high-alloyed tool steel	annealed		200	670	P11	●●			
		hardened and tempered		300	1010	P12	●●			
		hardened and tempered		400	1360	P13	●●			
	Stainless steel	ferritic / martensitic, annealed		200	670	P14	●●			
		martensitic, tempered		330	1110	P15	●●			
M	Stainless steel	austenitic, duplex		230	780	M1, M3	●			
		austenitic, precipitation hardened (PH)		300	1010	M2	●			
K	Grey cast iron		245	–	K3, K4	●				
	Cast iron with spheroidal graphite	ferritic, pearlitic		365	–	K1, K2, K5, K6	●			
	GGV (CGI)		200	–	K7	●				
N	Aluminium wrought alloys	cannot be hardened		30	–	N1				
		hardenable, hardened		100	340	N2				
	Cast aluminium alloys	≤ 12 % Si		90	310	N3, N4				
		> 12 % Si		130	450	N5				
	Magnesium alloys		70	250	N6					
	Copper and copper alloys (bronze / brass)	unalloyed, electrolytic copper		100	340	N7				
		Brass, bronze, red brass		90	310	N8				
Cu-alloys, short-chipping			110	380	N9					
high-strength, Ampco			300	1010	N10					
S	Heat-resistant alloys	Fe-based		280	940	S1, S2	●			
		Ni or Co base		250	840	S3	●			
		Ni or Co base		350	1080	S4, S5	●			
	Titanium alloys	Pure titanium		200	670	S6				
		α and β alloys, hardened		375	1260	S7	●			
		β alloys		410	1400	S8	●			
	Tungsten alloys		300	1010	S9					
	Molybdenum alloys		300	1010	S10					
	H	Hardened steel			50 HRC	–	H1			
					55 HRC	–	H2, H4			
				60 HRC	–	H3				
O	Thermoplasts	without abrasive fillers				O1				
	Thermosetting plastics	without abrasive fillers				O2				
	Fibre-reinforced plastic	GFRP, AFRP					O3, O5			
		CFRP					O4			
	Graphite (technical)			65		O6				

Walter Select – Shoulder / slot milling with facet Solid carbide slot drills

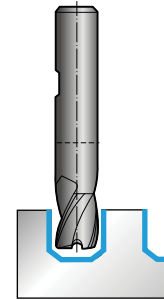
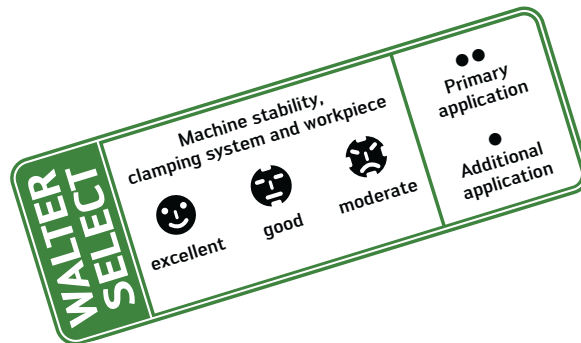
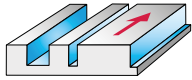

Solid carbide slot drills

Material group		Classification of the main material groups and code letters		Workpiece material		Brinell hardness HB	Tensile strength R_m N/mm ²	Machining group	Machining conditions			
									Family	Designation	λ	Page
Machining conditions									☹			
Dia. range									2,8 – 16			
Number of teeth									3 – 4			
Coating									TAX			
									Tough Guys N 50	H3021217 H3121217	50° 50°	E 128 E 128
P	Unalloyed and low-alloyed steel	annealed (tempered)	210	700	P1, P2, P3, P4, P7	••						
		Free cutting steel	220	750	P6	••						
		tempered	300	1010	P5, P8	••						
		tempered	380	1280	P9	••						
		tempered	430	1480	P10	••						
	High-alloyed steel and high-alloyed tool steel	annealed	200	670	P11	••						
		hardened and tempered	300	1010	P12	••						
		hardened and tempered	400	1360	P13	••						
	Stainless steel	ferritic / martensitic, annealed	200	670	P14	••						
		martensitic, tempered	330	1110	P15	••						
M	Stainless steel	austenitic, duplex	230	780	M1, M3	•						
		austenitic, precipitation hardened (PH)	300	1010	M2	•						
K	Grey cast iron		245	–	K3, K4	•						
	Cast iron with spheroidal graphite	ferritic, pearlitic	365	–	K1, K2, K5, K6	•						
	GGV (CGI)		200	–	K7	•						
	Aluminium wrought alloys	cannot be hardened	30	–	N1							
		hardenable, hardened	100	340	N2							
	Cast aluminium alloys	≤ 12 % Si	90	310	N3, N4							
		> 12 % Si	130	450	N5							
N	Magnesium alloys		70	250	N6							
	Copper and copper alloys (bronze / brass)	unalloyed, electrolytic copper	100	340	N7							
		Brass, bronze, red brass	90	310	N8							
		Cu-alloys, short-chipping	110	380	N9							
		high-strength, Ampco	300	1010	N10							
	Heat-resistant alloys	Fe-based	280	940	S1, S2							
		Ni or Co base	250	840	S3							
		Ni or Co base	350	1080	S4, S5							
S	Titanium alloys	Pure titanium	200	670	S6	•						
		α and β alloys, hardened	375	1260	S7	•						
		β alloys	410	1400	S8	•						
	Tungsten alloys		300	1010	S9							
	Molybdenum alloys		300	1010	S10							
H	Hardened steel		50 HRC	–	H1							
			55 HRC	–	H2, H4							
			60 HRC	–	H3							
	Thermoplasts	without abrasive fillers			O1							
	Thermosetting plastics	without abrasive fillers			O2							
O	Fibre-reinforced plastic	GFRP, AFRP			O3, O5							
		CFRP			O4							
	Graphite (technical)			65	O6							

Walter Select – Shoulder / slot milling with facet PCD milling cutter

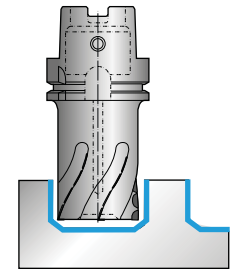
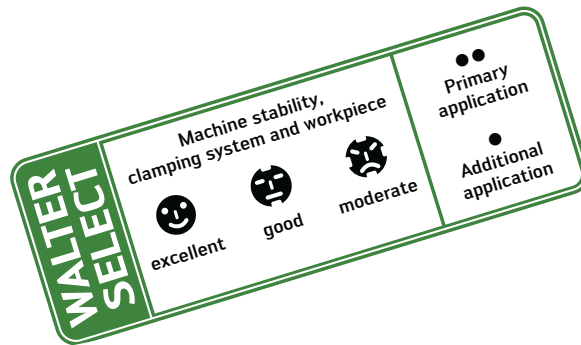
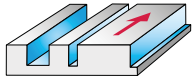

PCD milling cutter

Machining conditions	😊			
Dia. range	32 – 63			
Number of teeth	2 + 2			
Coating	PKD			
	Family	Designation	λ	Page

Material group	Classification of the main material groups and code letters		Brinell hardness HB	Tensile strength R_m N/mm ²	Machining group	PCD porcupine cutters	Designation	λ	Page
	Workpiece material								
P	Unalloyed and low-alloyed steel	annealed (tempered)	210	700	P1, P2, P3, P4, P7		F4726	10°	E 184
		Free cutting steel	220	750	P6				
		tempered	300	1010	P5, P8				
		tempered	380	1280	P9				
		tempered	430	1480	P10				
	High-alloyed steel and high-alloyed tool steel	annealed	200	670	P11				
hardened and tempered		300	1010	P12					
hardened and tempered		400	1360	P13					
Stainless steel	ferritic / martensitic, annealed	200	670	P14					
	martensitic, tempered	330	1110	P15					
M	Stainless steel	austenitic, duplex	230	780	M1, M3				
		austenitic, precipitation hardened (PH)	300	1010	M2				
K	Grey cast iron		245	–	K3, K4				
	Cast iron with spheroidal graphite	ferritic, pearlitic	365	–	K1, K2, K5, K6				
	GGV (CGI)		200	–	K7				
N	Aluminium wrought alloys	cannot be hardened	30	–	N1	●●			
		hardenable, hardened	100	340	N2	●●			
	Cast aluminium alloys	≤ 12 % Si	90	310	N3, N4	●●			
		> 12 % Si	130	450	N5	●●			
	Magnesium alloys		70	250	N6	●●			
	Copper and copper alloys (bronze / brass)	unalloyed, electrolytic copper	100	340	N7	●●			
Brass, bronze, red brass		90	310	N8	●●				
Cu-alloys, short-chipping		110	380	N9	●●				
high-strength, Ampco		300	1010	N10	●●				
S	Heat-resistant alloys	Fe-based	280	940	S1, S2				
		Ni or Co base	250	840	S3				
		Ni or Co base	350	1080	S4, S5				
	Titanium alloys	Pure titanium	200	670	S6				
		α and β alloys, hardened	375	1260	S7				
		β alloys	410	1400	S8				
Tungsten alloys		300	1010	S9					
Molybdenum alloys		300	1010	S10					
H	Hardened steel		50 HRC	–	H1				
			55 HRC	–	H2, H4				
			60 HRC	–	H3				
O	Thermoplasts	without abrasive fillers			O1				
	Thermosetting plastics	without abrasive fillers			O2				
	Fibre-reinforced plastic	GFRP, AFRP			O3, O5				
		CFRP			O4				
Graphite (technical)			65	O6					

Walter Select – Shoulder / slot milling with corner radius Solid carbide end mills

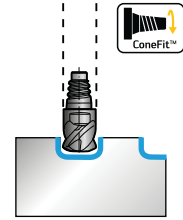
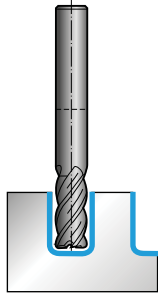

Solid carbide end mills

☺					☺				☹				☺			
2 – 20					4 – 20				10 – 25				4 – 20			
3 + 4					3 + 4				3 + 4				4			
TAZ					TAX				TAX				TAX			
Family	Designation	λ	Page		Family	Designation	λ	Page	Family	Designation	λ	Page	Family	Designation	λ	Page
Proto-max™ _{ST}	H4038217	50°	E 135		Flash	H3094718	50°	E 138	ConeFit™ Flash	H3E93718	50°	E 137	Flash (48–63 HRC)	H3094728	50°	E 139
	H4036217	45°	E 136													
	••				••				••							
	••				••				••							
	••				••				••							
	••				••				••							
	••				••				••							
	••				••				••							
	••				••				••							
	••				••				••							
	••				••				••							
	••				••				••							
	•				•				•							
	•				•				•							
	•				•				•							
	•				•				•							
	•				•				•							
	•				•				•					••		
					•				•					••		

Walter Select – Shoulder / slot milling with corner radius

Solid carbide end mills

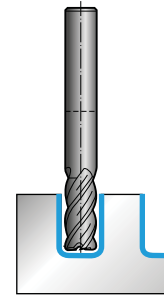
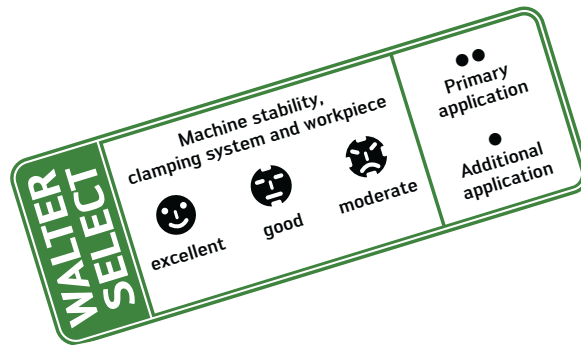
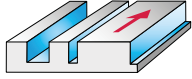

Solid carbide end mills

Material group		Classification of the main material groups and code letters	Workpiece material	Brinell hardness HB	Tensile strength R_m N/mm ²	Machining group	Machining conditions			
							Family	Designation	λ	Page
							☺			
							Dia. range 6 – 25			
							Number of teeth 2 + 3			
							Coating uncoated			
							Sky-tec™ AL 30	H602091	30°	E 158
							Sky-tec™ AL 25	H602691	25°	E 159
							AL 25	H6028818	25°	E 160
P	Unalloyed and low-alloyed steel	annealed (tempered)		210	700	P1, P2, P3, P4, P7				
		Free cutting steel		220	750	P6				
		tempered		300	1010	P5, P8				
		tempered		380	1280	P9				
		tempered		430	1480	P10				
	High-alloyed steel and high-alloyed tool steel	annealed		200	670	P11				
		hardened and tempered		300	1010	P12				
		hardened and tempered		400	1360	P13				
	Stainless steel	ferritic / martensitic, annealed		200	670	P14				
		martensitic, tempered		330	1110	P15				
M	Stainless steel	austenitic, duplex		230	780	M1, M3				
		austenitic, precipitation hardened (PH)		300	1010	M2				
K	Grey cast iron			245	–	K3, K4				
	Cast iron with spheroidal graphite	ferritic, pearlitic		365	–	K1, K2, K5, K6				
	GGV (CGI)			200	–	K7				
N	Aluminium wrought alloys	cannot be hardened		30	–	N1	●●			
		hardenable, hardened		100	340	N2	●●			
	Cast aluminium alloys	≤ 12 % Si		90	310	N3, N4	●●			
		> 12 % Si		130	450	N5	●●			
	Magnesium alloys			70	250	N6	●●			
S	Copper and copper alloys (bronze / brass)	unalloyed, electrolytic copper		100	340	N7	●●			
		Brass, bronze, red brass		90	310	N8	●●			
		Cu-alloys, short-chipping		110	380	N9	●●			
		high-strength, Ampco		300	1010	N10	●●			
	Heat-resistant alloys	Fe-based		280	940	S1, S2				
		Ni or Co base		250	840	S3				
		Ni or Co base		350	1080	S4, S5				
	Titanium alloys	Pure titanium		200	670	S6				
		α and β alloys, hardened		375	1260	S7				
		β alloys		410	1400	S8				
	Tungsten alloys			300	1010	S9				
	Molybdenum alloys			300	1010	S10				
H	Hardened steel			50 HRC	–	H1				
				55 HRC	–	H2, H4				
				60 HRC	–	H3				
O	Thermoplasts	without abrasive fillers				O1	●			
	Thermosetting plastics	without abrasive fillers				O2	●			
	Fibre-reinforced plastic	GFRP, AFRP				O3, O5				
		CFRP				O4				
	Graphite (technical)				65	O6				

Walter Select – Shoulder / slot milling with corner radius

Solid carbide end mills

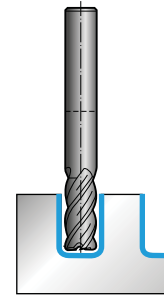
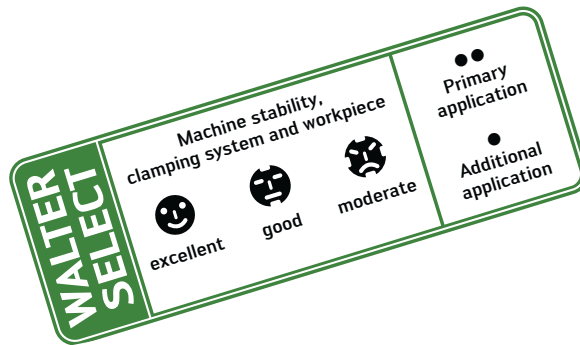
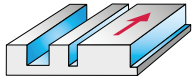

Solid carbide end mills

Material group		Classification of the main material groups and code letters	Workpiece material	Brinell hardness HB	Tensile strength R_m N/mm ²	Machining group	Machining conditions			
							Family	Designation	λ	Page
Machining conditions							☹			
Dia. range							1 – 25			
Number of teeth							2 + 3			
Coating							uncoated + CRN			
							AL 45	H6E2311	45°	E 150
							AL 45	H602311 H6023114	45°	E 150 E 150
							AL 25	H602881	25°	E 160
P	Unalloyed and low-alloyed steel	annealed (tempered)		210	700	P1, P2, P3, P4, P7				
		Free cutting steel		220	750	P6				
		tempered		300	1010	P5, P8				
		tempered		380	1280	P9				
		tempered		430	1480	P10				
	High-alloyed steel and high-alloyed tool steel	annealed		200	670	P11				
		hardened and tempered		300	1010	P12				
		hardened and tempered		400	1360	P13				
	Stainless steel	ferritic / martensitic, annealed		200	670	P14				
		martensitic, tempered		330	1110	P15				
M	Stainless steel	austenitic, duplex		230	780	M1, M3				
		austenitic, precipitation hardened (PH)		300	1010	M2				
K	Grey cast iron		245	–	K3, K4					
	Cast iron with spheroidal graphite	ferritic, pearlitic		365	–	K1, K2, K5, K6				
	GGV (CGI)		200	–	K7					
N	Aluminium wrought alloys	cannot be hardened		30	–	N1	●●			
		hardenable, hardened		100	340	N2	●●			
	Cast aluminium alloys	≤ 12 % Si		90	310	N3, N4	●●			
		> 12 % Si		130	450	N5	●●			
	Magnesium alloys		70	250	N6	●●				
	Copper and copper alloys (bronze / brass)	unalloyed, electrolytic copper		100	340	N7	●●			
		Brass, bronze, red brass		90	310	N8	●●			
		Cu-alloys, short-chipping		110	380	N9	●●			
high-strength, Ampco			300	1010	N10	●●				
S	Heat-resistant alloys	Fe-based		280	940	S1, S2				
		Ni or Co base		250	840	S3				
		Ni or Co base		350	1080	S4, S5				
	Titanium alloys	Pure titanium		200	670	S6				
		α and β alloys, hardened		375	1260	S7				
		β alloys		410	1400	S8				
	Tungsten alloys		300	1010	S9					
Molybdenum alloys		300	1010	S10						
H	Hardened steel			50 HRC	–	H1				
				55 HRC	–	H2, H4				
				60 HRC	–	H3				
O	Thermoplasts	without abrasive fillers				O1	●			
	Thermosetting plastics	without abrasive fillers				O2	●			
	Fibre-reinforced plastic	GFRP, AFRP				O3, O5				
		CFRP				O4				
Graphite (technical)				65	O6					

Walter Select – Shoulder / slot milling with corner radius

Solid carbide end mills

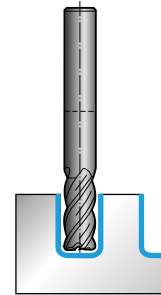
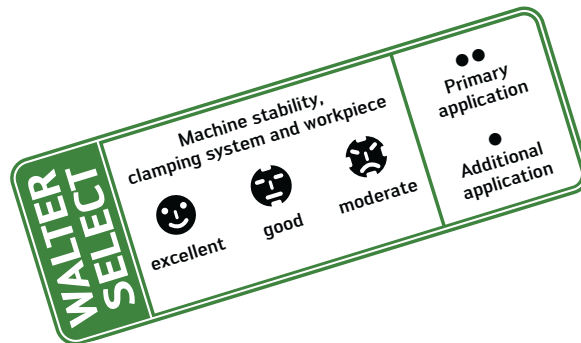
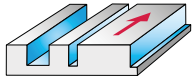

Solid carbide end mills

Material group		Classification of the main material groups and code letters	Workpiece material	Brinell hardness HB	Tensile strength R_m N/mm ²	Machining group	Machining conditions			
							Family	Designation	λ	Page
							Dia. range 2 – 16			
							Number of teeth 2 – 4			
							Coating TAX			
							HSC 30 (48–63 HRC)	H8005728 H8005928 H8015728 H8015828	30°	E 152 E 152 E 155 E 155
P	Unalloyed and low-alloyed steel	annealed (tempered)		210	700	P1, P2, P3, P4, P7				
		Free cutting steel		220	750	P6				
		tempered		300	1010	P5, P8				
		tempered		380	1280	P9				
		tempered		430	1480	P10	••			
	High-alloyed steel and high-alloyed tool steel	annealed		200	670	P11				
		hardened and tempered		300	1010	P12				
		hardened and tempered		400	1360	P13				
	Stainless steel	ferritic / martensitic, annealed		200	670	P14				
		martensitic, tempered		330	1110	P15				
M	Stainless steel	austenitic, duplex		230	780	M1, M3				
		austenitic, precipitation hardened (PH)		300	1010	M2				
K	Grey cast iron			245	–	K3, K4				
	Cast iron with spheroidal graphite	ferritic, pearlitic		365	–	K1, K2, K5, K6				
	GGV (CGI)			200	–	K7				
	Aluminium wrought alloys	cannot be hardened		30	–	N1				
		hardenable, hardened		100	340	N2				
	Cast aluminium alloys	≤ 12 % Si		90	310	N3, N4				
		> 12 % Si		130	450	N5				
N	Magnesium alloys			70	250	N6				
	Copper and copper alloys (bronze / brass)	unalloyed, electrolytic copper		100	340	N7				
		Brass, bronze, red brass		90	310	N8				
		Cu-alloys, short-chipping		110	380	N9				
		high-strength, Ampco		300	1010	N10				
	Heat-resistant alloys	Fe-based		280	940	S1, S2				
		Ni or Co base		250	840	S3				
		Ni or Co base		350	1080	S4, S5				
	Titanium alloys	Pure titanium		200	670	S6				
		α and β alloys, hardened		375	1260	S7				
		β alloys		410	1400	S8				
	Tungsten alloys			300	1010	S9				
	Molybdenum alloys			300	1010	S10				
H	Hardened steel			50 HRC	–	H1	••			
				55 HRC	–	H2, H4	••			
				60 HRC	–	H3	••			
	Thermoplasts	without abrasive fillers				O1				
	Thermosetting plastics	without abrasive fillers				O2				
	Fibre-reinforced plastic	GFRP, AFRP				O3, O5				
		CFRP				O4				
	Graphite (technical)				65	O6				

Walter Select – Shoulder / slot milling with roughing profile

Solid carbide roughing milling cutters

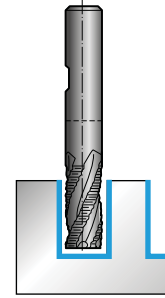
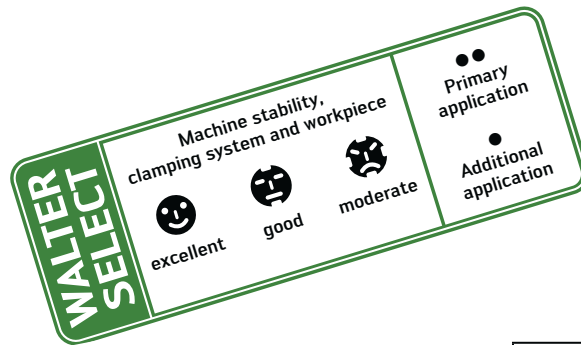
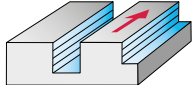

Solid carbide roughing milling cutters

Material group		Classification of the main material groups and code letters		Workpiece material		Brinell hardness HB		Tensile strength R_m N/mm ²		Machining group		Machining conditions						
												Family	Designation	λ	Page			
												6 – 25						
												4						
												ACN						
												Ti NS 30	H3083017 H3183017	30° 30°	E 172 E 172			
P	Unalloyed and low-alloyed steel	annealed (tempered)		210	700	P1, P2, P3, P4, P7												
		Free cutting steel		220	750	P6												
		tempered		300	1010	P5, P8												
		tempered		380	1280	P9												
		tempered		430	1480	P10												
	High-alloyed steel and high-alloyed tool steel	annealed		200	670	P11												
		hardened and tempered		300	1010	P12												
		hardened and tempered		400	1360	P13												
	Stainless steel	ferritic / martensitic, annealed		200	670	P14												
		martensitic, tempered		330	1110	P15												
M	Stainless steel	austenitic, duplex		230	780	M1, M3		●										
		austenitic, precipitation hardened (PH)		300	1010	M2		●										
K	Grey cast iron		245	–	K3, K4		●											
	Cast iron with spheroidal graphite		365	–	K1, K2, K5, K6		●											
	GGV (CGI)		200	–	K7		●											
N	Aluminium wrought alloys	cannot be hardened		30	–	N1												
		hardenable, hardened		100	340	N2												
	Cast aluminium alloys	≤ 12 % Si		90	310	N3, N4												
		> 12 % Si		130	450	N5												
	Magnesium alloys				70	250	N6											
	Copper and copper alloys (bronze / brass)	unalloyed, electrolytic copper		100	340	N7												
		Brass, bronze, red brass		90	310	N8												
Cu-alloys, short-chipping		110	380	N9														
high-strength, Ampco		300	1010	N10														
S	Heat-resistant alloys	Fe-based		280	940	S1, S2		●●										
		Ni or Co base		250	840	S3		●●										
		Ni or Co base		350	1080	S4, S5		●●										
	Titanium alloys	Pure titanium		200	670	S6		●●										
		α and β alloys, hardened		375	1260	S7		●●										
		β alloys		410	1400	S8		●●										
								●●										
	Tungsten alloys				300	1010	S9		●									
	Molybdenum alloys				300	1010	S10		●									
	H	Hardened steel		50 HRC		–	H1											
55 HRC				–	H2, H4													
60 HRC				–	H3													
O	Thermoplasts		without abrasive fillers				O1											
	Thermosetting plastics		without abrasive fillers				O2											
	Fibre-reinforced plastic	GFRP, AFRP						O3, O5										
		CFRP						O4										
	Graphite (technical)				65		O6											

Walter Select – Shoulder / slot milling with roughing profile

HSS roughing milling cutters

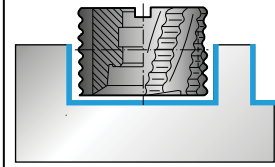
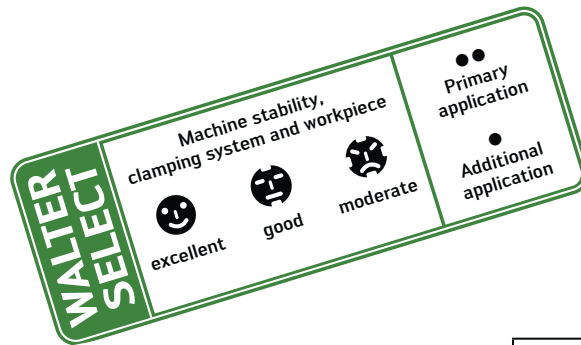
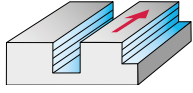
HSS shell end mill

Machining conditions				
Dia. range	40 – 100			
Number of teeth	6 – 12			
Coating	TiCN			
	Family	Designation	λ	Page

Material group	Classification of the main material groups and code letters		Brinell hardness HB	Tensile strength R_m N/mm ²	Machining group	Machining conditions				
	Workpiece material					Family	Designation	λ	Page	
P	Unalloyed and low-alloyed steel	annealed (tempered)	210	700	P1, P2, P3, P4, P7	●●				
		Free cutting steel	220	750	P6	●●				
		tempered	300	1010	P5, P8	●●				
		tempered	380	1280	P9	●●				
		tempered	430	1480	P10	●●				
	High-alloyed steel and high-alloyed tool steel	annealed	200	670	P11	●●				
		hardened and tempered	300	1010	P12	●●				
		hardened and tempered	400	1360	P13	●●				
	Stainless steel	ferritic / martensitic, annealed	200	670	P14	●●				
martensitic, tempered		330	1110	P15	●●					
M	Stainless steel	austenitic, duplex	230	780	M1, M3	●				
		austenitic, precipitation hardened (PH)	300	1010	M2	●				
K	Grey cast iron		245	–	K3, K4	●				
	Cast iron with spheroidal graphite	ferritic, pearlitic	365	–	K1, K2, K5, K6	●				
	GGV (CGI)		200	–	K7	●				
N	Aluminium wrought alloys	cannot be hardened	30	–	N1	●				
		hardenable, hardened	100	340	N2	●				
	Cast aluminium alloys	$\leq 12\%$ Si	90	310	N3, N4	●				
		$> 12\%$ Si	130	450	N5	●				
	Magnesium alloys		70	250	N6	●				
	Copper and copper alloys (bronze / brass)	unalloyed, electrolytic copper		100	340	N7	●			
		Brass, bronze, red brass		90	310	N8	●			
Cu-alloys, short-chipping			110	380	N9	●				
high-strength, Ampco			300	1010	N10	●				
S	Heat-resistant alloys	Fe-based	280	940	S1, S2					
		Ni or Co base	250	840	S3					
		Ni or Co base	350	1080	S4, S5					
	Titanium alloys	Pure titanium	200	670	S6					
		α and β alloys, hardened	375	1260	S7					
		β alloys	410	1400	S8					
	Tungsten alloys		300	1010	S9					
Molybdenum alloys		300	1010	S10						
H	Hardened steel		50 HRC	–	H1					
			55 HRC	–	H2, H4					
			60 HRC	–	H3					
O	Thermoplasts	without abrasive fillers			O1					
	Thermosetting plastics	without abrasive fillers			O2					
	Fibre-reinforced plastic	GFRP, AFRP			O3, O5					
		CFRP			O4					
Graphite (technical)			65	O6						

Walter Select – Shoulder / slot milling with roughing profile HSS shell end mill

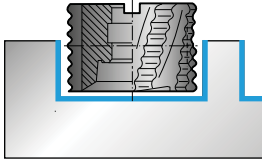

HSS shell end mill

40 – 100				
6 – 12				
uncoated				
Family	Designation	λ	Page	
HR Kordel F 25	P020101	25°	E 183	
	•			
	•			
	•			
	•			
	•			
	••			
	••			
	••			
	••			
	••			
	••			
	••			
	••			
	••			
	••			
	••			
	•			
	•			

End mill Proto-max™_{ST}



Materials to 52 HRC

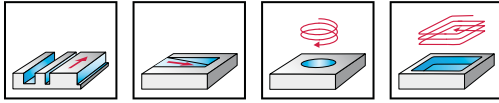

- Solid carbide
- long reach
- 4 cutting edges
- with centre cut
- 50° helix angle

Special features:

Slot milling: $a_p \leq 1.5 \times D_c$

Shoulder milling: $a_e \leq 0.5 \times D_c$

	P	M	K	N	S	H	O
TAZ	●●	●	●	●	●	●	●

P standard	D_c h9 mm	L_c mm	l_3 mm	d_2 mm	l_1 mm	l_4 mm	d_1 h6 mm	Z	TAZ designation H4034217
Shank DIN 6535 HA	3	5	8,5	2,9	57	21	6	4	-3
	4	7	11	3,8	57	21	6	4	-4
	5	8	14	4,75	57	21	6	4	-5
	6	10	16	5,7	57	21	6	4	-6
	8	13	22	7,6	63	27	8	4	-8
	10	16	28	9,5	72	32	10	4	-10
	12	19	33	11,4	83	38	12	4	-12
	14	22	36	13,3	83	38	14	4	-14
	16	26	42	15,2	92	44	16	4	-16
	18	29	42	17,1	92	44	18	4	-18
	20	32	52	19	104	54	20	4	-20

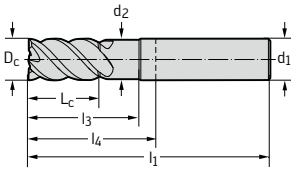

End mill Proto-max™_{ST}



Materials to 52 HRC

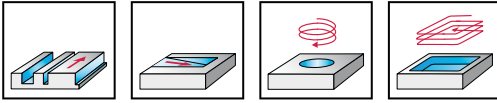

- Solid carbide
- long reach
- 3 cutting edges
- with centre cut
- 45° helix angle

Special features:

Slot milling: $a_p \leq 2.0 \times D_c$

Shoulder milling: $a_e \leq 0.3 \times D_c$

	P	M	K	N	S	H	O
TAZ	●●	●	●	●	●	●	●

P standard	D_c h9 mm	L_c mm	l_3 mm	d_2 mm	l_1 mm	l_4 mm	d_1 h6 mm	Z	TAZ designation H4033217
Shank DIN 6535 HA	2	5	7,5	1,92	57	21	6	3	-2
	3	7	10,5	2,9	57	21	6	3	-3
	4	9	15	3,8	57	21	6	3	-4
	5	11	16	4,75	57	21	6	3	-5
	6	13	19	5,7	57	21	6	3	-6
	8	18	25	7,6	63	27	8	3	-8
	10	22	30	9,5	72	32	10	3	-10
	12	26	36	11,4	83	38	12	3	-12
	16	34	42	15,2	92	44	16	3	-16
	20	42	52	19	104	54	20	3	-20

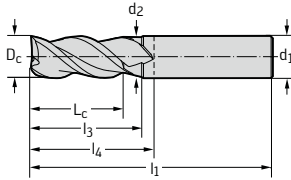

End mill Protostar® N 50 Tough Guys



Materials to 48 HRC

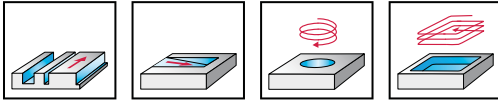

- Solid carbide
- 3 to 4 cutting edges
- with centre cut
- 50° helix angle

Special features:

Slot milling: $a_p \leq 0.9 \times D_c$

Shoulder milling: $a_e \leq 0.3 \times D_c$

	P	M	K	N	S	H	O
TAX	●●	●	●				

P standard L	D_c h10 mm	L_c mm	l_1 mm	l_4 mm	d_1 h6 mm	Z	TAX designation H3021117
Shank DIN 6535 HA 	2	7	57	21	6	3	-2
	2,5	8	57	21	6	3	-2.5
	3	8	57	21	6	3	-3
	3,5	10	57	21	6	3	-3.5
	4	11	57	21	6	3	-4
	4,5	11	57	21	6	3	-4.5
	5	13	57	21	6	3	-5
	6	13	65	29	6	4	-6
	7	16	80	44	8	4	-7
	8	19	80	44	8	4	-8
	9	19	100	60	10	4	-9
	10	22	100	60	10	4	-10
	11	26	100	55	12	4	-11
	12	26	100	55	12	4	-12
	14	26	104	59	14	4	-14
	16	32	115	67	16	4	-16
20	38	125	75	20	4	-20	

End mill Protostar® N 50 Tough Guys



Materials to 48 HRC

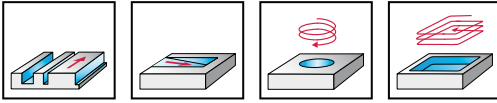

- Solid carbide
- 4 to 5 cutting edges
- with centre cut
- 50° helix angle

Special features:

Slot milling: $a_p \leq 0.5 \times D_c$

Shoulder milling: $a_e \leq 0.5 \times D_c$

	P	M	K	N	S	H	O
TAX	●●	●	●	●	●	●	●

P standard	D_c	L_c	d_2	l_1	l_4	SW	d_1	Z	TAX designation
	h10 mm	mm	mm	mm	mm	mm			H3E21317
ConeFit™	10	5,5	9,7	23,6	12,4	8	E 10	4	-E10-10
	12	6,5	11,7	28,3	14,5	10	E 12	4	-E12-12
	16	8,5	15,5	35,7	18,7	12	E 16	4	-E16-16
	20	11	19,3	40,8	21,3	16	E 20	4	-E20-20
	25	13,5	24,2	49,6	25,6	20	E 25	5	-E25-25

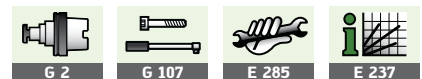

End mill Protostar® N 50 Tough Guys



Materials to 48 HRC

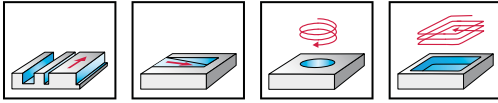

- Solid carbide
- 4 to 5 cutting edges
- with centre cut
- 50° helix angle

Special features:

Slot milling: $a_p \leq 0.9 \times D_c$

Shoulder milling: $a_e \leq 0.3 \times D_c$

	P	M	K	N	S	H	O
TAX	●●	●	●				

DIN 6527 L	D_c h10 mm	L_c mm	l_1 mm	l_4 mm	d_1 h6 mm	Z	TAX designation H3021317
Shank DIN 6535 HA	6	13	57	21	6	4	-6
	8	19	63	27	8	4	-8
	10	22	72	32	10	4	-10
	12	26	83	38	12	4	-12
	14	26	83	38	14	4	-14
	16	32	92	44	16	4	-16
	18	32	92	44	18	4	-18
	20	38	104	54	20	4	-20
	25	45	121	65	25	5	-25

DIN 6527 L	D_c h10 mm	L_c mm	l_1 mm	l_4 mm	d_1 h6 mm	Z	TAX designation H3121317
Shank DIN 6535 HB	6	13	57	21	6	4	-6
	8	19	63	27	8	4	-8
	10	22	72	32	10	4	-10
	12	26	83	38	12	4	-12
	14	26	83	38	14	4	-14
	16	32	92	44	16	4	-16
	18	32	92	44	18	4	-18
	20	38	104	54	20	4	-20
	25	45	121	65	25	5	-25

End mill

Protostar® N 50

Tough Guys



Materials to 48 HRC

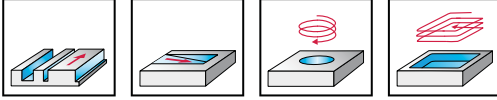

Special features:

Slot milling: $a_p \leq 0.9 \times D_c$

Shoulder milling: $a_e \leq 0.3 \times D_c$

- Solid carbide
- long reach
- 4 cutting edges
- with centre cut
- 50° helix angle

	P	M	K	N	S	H	O
TAX	●●	●	●	●	●	●	●

DIN 6527 L	D_c h10 mm	L_c mm	l_3 mm	d_2 mm	l_1 mm	l_4 mm	d_1 h6 mm	Z	TAX designation H4021017
Shank DIN 6535 HA	6	13	19	5,7	57	21	6	4	-6
	8	19	25	7,6	63	27	8	4	-8
	10	22	30	9,5	72	32	10	4	-10
	12	26	36	11,4	83	38	12	4	-12
	14	26	36	13,3	83	38	14	4	-14
	16	32	42	15,2	92	44	16	4	-16
	20	38	52	19	104	54	20	4	-20

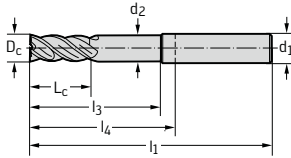

DIN 6527 L	D_c h10 mm	L_c mm	l_3 mm	d_2 mm	l_1 mm	l_4 mm	d_1 h6 mm	Z	TAX designation H4121017
Shank DIN 6535 HB	6	13	19	5,7	57	21	6	4	-6
	8	19	25	7,6	63	27	8	4	-8
	10	22	30	9,5	72	32	10	4	-10
	12	26	36	11,4	83	38	12	4	-12
	14	26	36	13,3	83	38	14	4	-14
	16	32	42	15,2	92	44	16	4	-16
	20	38	52	19	104	54	20	4	-20

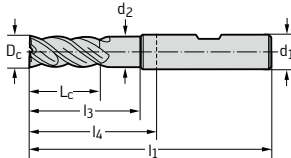

End mill Protostar® N 50 Tough Guys



Materials to 48 HRC

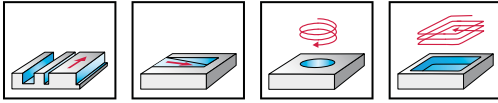

Special features:

Slot milling: $a_p \leq 0.9 \times D_c$

Shoulder milling: $a_e \leq 0.3 \times D_c$

- Solid carbide
- long reach
- 3 to 4 cutting edges
- with centre cut
- 50° helix angle

	P	M	K	N	S	H	O
TAX	●●	●	●				

P standard L	D_c h10 mm	L_c mm	l_3 mm	d_2 mm	l_1 mm	l_4 mm	d_1 h6 mm	Z	TAX designation H4021117
Shank DIN 6535 HA	4	11	15	3,8	57	21	6	3	-4
	5	13	16	4,75	57	21	6	3	-5
	6	13	27	5,7	65	29	6	4	-6
	8	19	42	7,6	80	44	8	4	-8
	10	22	58	9,5	100	60	10	4	-10
	12	26	53	11,4	100	55	12	4	-12
	14	26	57	13,3	104	59	14	4	-14
	16	32	65	15,2	115	67	16	4	-16
	20	38	73	19	125	75	20	4	-20

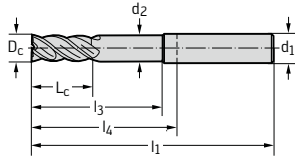

P standard L	D_c h10 mm	L_c mm	l_3 mm	d_2 mm	l_1 mm	l_4 mm	d_1 h6 mm	Z	TAX designation H4121117
Shank DIN 6535 HB	4	11	15	3,8	57	21	6	3	-4
	5	13	16	4,75	57	21	6	3	-5
	6	13	27	5,7	65	29	6	4	-6
	8	19	42	7,6	80	44	8	4	-8
	10	22	58	9,5	100	60	10	4	-10
	12	26	53	11,4	100	55	12	4	-12
	14	26	57	13,3	104	59	14	4	-14
	16	32	65	15,2	115	67	16	4	-16
	20	38	73	19	125	75	20	4	-20

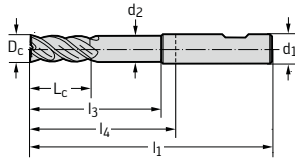

End mill

Protostar® N 50

Tough Guys



Materials to 48 HRC

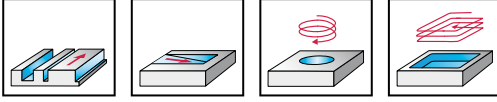

- Solid carbide
- long reach
- 4 cutting edges
- with centre cut
- 50° helix angle

Special features:

Slot milling: $a_p \leq 0.9 \times D_c$

Shoulder milling: $a_e \leq 0.3 \times D_c$

	P	M	K	N	S	H	O
TAX	●●	●	●	●	●	●	●

DIN 6527 L	D_c h10 mm	L_c mm	l_3 mm	d_2 mm	l_1 mm	l_4 mm	d_1 h6 mm	Z	TAX designation H4021217
Shank DIN 6535 HA	6	6	19	5,7	57	21	6	4	-6
	8	8	25	7,6	63	27	8	4	-8
	10	10	30	9,5	72	32	10	4	-10
	12	12	36	11,4	83	38	12	4	-12
	14	14	36	13,3	83	38	14	4	-14
	16	16	42	15,2	92	44	16	4	-16

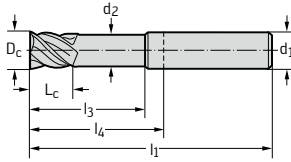

DIN 6527 L	D_c h10 mm	L_c mm	l_3 mm	d_2 mm	l_1 mm	l_4 mm	d_1 h6 mm	Z	TAX designation H4121217
Shank DIN 6535 HB	6	6	19	5,7	57	21	6	4	-6
	8	8	25	7,6	63	27	8	4	-8
	10	10	30	9,5	72	32	10	4	-10
	12	12	36	11,4	83	38	12	4	-12
	14	14	36	13,3	83	38	14	4	-14
	16	16	42	15,2	92	44	16	4	-16

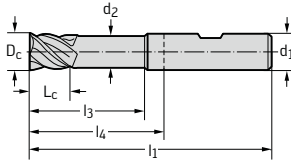

End mill Protostar® H 50 Tough Guys



Materials from 48 to 63 HRC

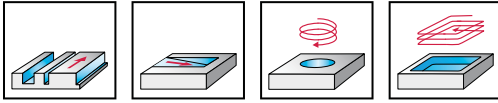

- Solid carbide
- 3 to 4 cutting edges
- with centre cut
- 50° helix angle

Special features:

Slot milling: $a_p \leq 0.9 \times D_c$

Shoulder milling: $a_e \leq 0.3 \times D_c$

	P	M	K	N	S	H	O
TAX	●					●●	

P standard L	D_c h10 mm	L_c mm	l_1 mm	l_4 mm	d_1 h6 mm	Z	TAX designation H3071118
Shank DIN 6535 HA 	2	7	57	21	6	3	-2
	3	8	57	21	6	3	-3
	4	11	57	21	6	3	-4
	5	13	57	21	6	3	-5
	6	13	65	29	6	4	-6
	8	19	80	44	8	4	-8
	10	22	100	60	10	4	-10
	12	26	100	55	12	4	-12
	14	26	104	59	14	4	-14
	16	32	115	67	16	4	-16
20	38	125	75	20	4	-20	

DIN 6527 L	D_c h10 mm	L_c mm	l_1 mm	l_4 mm	d_1 h6 mm	Z	TAX designation H3071318
Shank DIN 6535 HA 	6	13	57	21	6	4	-6
	8	19	63	27	8	4	-8
	10	22	72	32	10	4	-10
	12	26	83	38	12	4	-12
	14	26	83	38	14	4	-14
	16	32	92	44	16	4	-16
	20	38	104	54	20	4	-20

DIN 6527 L	D_c h10 mm	L_c mm	l_1 mm	l_4 mm	d_1 h6 mm	Z	TAX designation H3171318
Shank DIN 6535 HB 	6	13	57	21	6	4	-6
	8	19	63	27	8	4	-8
	10	22	72	32	10	4	-10
	12	26	83	38	12	4	-12
	14	26	83	38	14	4	-14
	16	32	92	44	16	4	-16
	20	38	104	54	20	4	-20

End mill

Protostar® N 45

Compact



Materials to 48 HRC

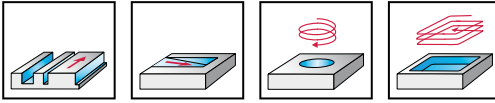

- Solid carbide
- 3 cutting edges
- with centre cut
- 45° helix angle

Special features:

Slot milling: $a_p \leq 0.5 \times D_c$

Shoulder milling: $a_e \leq 0.6 \times D_c$

	P	M	K	N	S	H	O
TAX	●●	●	●				

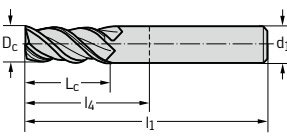
P standard S	D_c	L_c	l_1	l_4	d_1	Z	TAX designation
	h11				h6		
mm	mm	mm	mm	mm	mm		H3013018
Shank DIN 6535 HA	2	3	39	12	6	3	-2
	3	4	39	12	6	3	-3
	4	5	39	12	6	3	-4
	5	6	39	12	6	3	-5
	6	7	39	12	6	3	-6
	8	9	44	17	8	3	-8
	10	11	51	20	10	3	-10
	12	13	56	22	12	3	-12

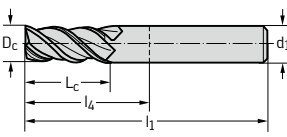
DIN 6527 K	D_c	L_c	l_1	l_4	d_1	Z	TAX designation
	h11				h6		
mm	mm	mm	mm	mm	mm		H3013118
Shank DIN 6535 HA	2	6	50	14	6	3	-2
	3	7	50	14	6	3	-3
	4	8	54	18	6	3	-4
	5	10	54	18	6	3	-5
	6	10	54	18	6	3	-6
	8	16	58	22	8	3	-8
	10	19	66	26	10	3	-10
	12	22	73	28	12	3	-12

End mill Protostar® N 45 Compact



Materials to 48 HRC

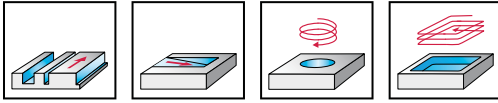

- Solid carbide
- 4 cutting edges
- with centre cut
- 45° helix angle

Special features:

Slot milling: $a_p \leq 0.5 \times D_c$

Shoulder milling: $a_e \leq 0.6 \times D_c$

	P	M	K	N	S	H	O
TAX	●●	●	●	●	●	●	●

P standard S	D_c h11 mm	L_c mm	l_1 mm	l_4 mm	d_1 h6 mm	Z	TAX designation H3014018
Shank DIN 6535 HA	2	3	39	12	6	4	-2
	3	4	39	12	6	4	-3
	4	5	39	12	6	4	-4
	5	6	39	12	6	4	-5
	6	7	39	12	6	4	-6
	8	9	44	17	8	4	-8
	10	11	51	20	10	4	-10
	12	13	56	22	12	4	-12

DIN 6527 K	D_c h11 mm	L_c mm	l_1 mm	l_4 mm	d_1 h6 mm	Z	TAX designation H3014118
Shank DIN 6535 HA	2	6	50	14	6	4	-2
	3	7	50	14	6	4	-3
	4	8	54	18	6	4	-4
	5	10	54	18	6	4	-5
	6	10	54	18	6	4	-6
	8	16	58	22	8	4	-8
	10	19	66	26	10	4	-10
	12	22	73	28	12	4	-12

End mill Protostar® N 45



Materials to 48 HRC

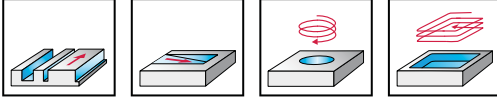

- Solid carbide
- 4 to 5 cutting edges
- with centre cut
- 45° helix angle

Special features:

Slot milling: $a_p \leq 0.5 \times D_c$

Shoulder milling: $a_e \leq 0.5 \times D_c$

	P	M	K	N	S	H	O
TAX	●●	●	●				

DIN 6527 K	D_c h10 mm	L_c mm	l_1 mm	l_4 mm	d_1 h6 mm	Z	TAX designation H3023018
Shank DIN 6535 HA	6	10	54	18	6	4	-6
	8	12	58	22	8	4	-8
	10	14	66	26	10	4	-10
	12	16	73	28	12	4	-12
	16	22	82	34	16	4	-16
	20	26	92	42	20	5	-20

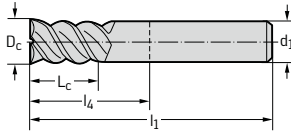

End mill Protostar® N 45



Materials to 48 HRC

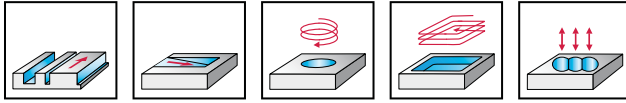

- Solid carbide
- 3 cutting edges
- with centre cut
- 45° helix angle

Special features:

Slot milling: $a_p \leq 0.5 \times D_c$

Shoulder milling: $a_e \leq 0.6 \times D_c$

	P	M	K	N	S	H	O
TAX	●●		●				
uncoated				●●			

P standard	D_c h10 mm	L_c mm	d_2 mm	l_1 mm	l_4 mm	SW mm	d_1	Z	TAX designation H3E29148
ConeFit™	10	5,5	9,7	23,6	12,4	8	E 10	3	-E10-10
	12	6,5	11,7	28,3	14,5	10	E 12	3	-E12-12
	16	8,5	15,5	35,7	18,7	12	E 16	3	-E16-16
	20	11	19,3	40,8	21,3	16	E 20	3	-E20-20
	25	13,5	24,2	49,6	25,6	20	E 25	3	-E25-25

DIN 6527 L	D_c h10 mm	L_c mm	d_2 mm	l_1 mm	l_4 mm	SW mm	d_1 h6 mm	Z	uncoated designation H302914	TAX designation H3029148
Shank DIN 6535 HA	1	3	-	57	21	-	6	3	-1	-1
	1,5	3	-	57	21	-	6	3	-1.5	-1.5
	2	6	-	57	21	-	6	3	-2	-2
	2,5	7	-	57	21	-	6	3	-2.5	-2.5
	3	7	-	57	21	-	6	3	-3	-3
	3,5	7	-	57	21	-	6	3	-3.5	-3.5
	4	8	-	57	21	-	6	3	-4	-4
	4,5	8	-	57	21	-	6	3	-4.5	-4.5
	5	10	-	57	21	-	6	3	-5	-5
	5,5	10	-	57	21	-	6	3	-5.5	-5.5
	6	10	-	57	21	-	6	3	-6	-6
	7	13	-	63	27	-	8	3	-7	-7
	8	16	-	63	27	-	8	3	-8	-8
	9	16	-	72	32	-	10	3	-9	-9
	10	19	-	72	32	-	10	3	-10	-10
	12	22	-	83	38	-	12	3	-12	-12
	14	22	-	83	38	-	14	3	-14	-14
	16	26	-	92	44	-	16	3	-16	-16
	18	26	-	92	44	-	18	3	-18	-18
	20	32	-	104	54	-	20	3	-20	-20

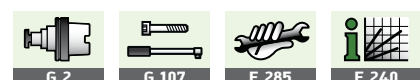

End mill Protostar® 45



Materials to 48 HRC

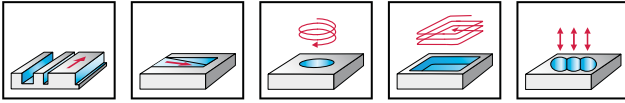

- Solid carbide
- 3 cutting edges
- with centre cut
- 45° helix angle

Special features:

Slot milling: $a_p \leq 0.5 \times D_c$

Shoulder milling: $a_e \leq 0.6 \times D_c$

	P	M	K	N	S	H	O
uncoated				●●			
TAX	●●						

DIN 6527 L	D_c	L_c	l_1	l_4	d_1	Z	uncoated designation H312914	TAX designation H3129148
	h10 mm				h6 mm			
Shank DIN 6535 HB	1	3	57	21	6	3		-1
	1,5	3	57	21	6	3		-1.5
	2	6	57	21	6	3	-2	-2
	2,5	7	57	21	6	3		-2.5
	3	7	57	21	6	3	-3	-3
	3,5	7	57	21	6	3		-3.5
	4	8	57	21	6	3	-4	-4
	4,5	8	57	21	6	3		-4.5
	5	10	57	21	6	3	-5	-5
	5,5	10	57	21	6	3		-5.5
	6	10	57	21	6	3	-6	-6
	8	16	63	27	8	3	-8	-8
	9	16	72	32	10	3	-9	-9
	10	19	72	32	10	3	-10	-10
	12	22	83	38	12	3	-12	-12
	14	22	83	38	14	3	-14	-14
	16	26	92	44	16	3	-16	-16
	18	26	92	44	18	3	-18	-18
	20	32	104	54	20	3	-20	-20

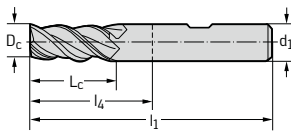

End mill Protostar® AL 45

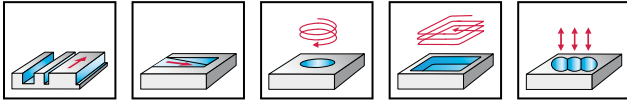

- Solid carbide
- 2 cutting edges
- with centre cut
- 45° helix angle

Special features:

 Slot milling: $a_p \leq 0.5 \times D_c$

 Shoulder milling: $a_e \leq 0.5 \times D_c$

	P	M	K	N	S	H	O
uncoated				●●			

P standard

ConeFit™

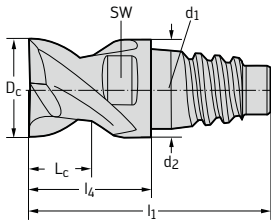

D _c h10 mm	L _c mm	d ₂ mm	l ₁ mm	l ₄ mm	SW mm	d ₁	Z	uncoated designation H6E2511
10	5,5	9,7	23,6	12,4	8	E 10	2	-E10-10
12	6,5	11,7	28,3	14,5	10	E 12	2	-E12-12
16	8,5	15,5	35,7	18,7	12	E 16	2	-E16-16
20	11	19,3	40,8	21,3	16	E 20	2	-E20-20
25	13,5	24,2	49,6	25,6	20	E 25	2	-E25-25



End mill

Protostar® AL 45

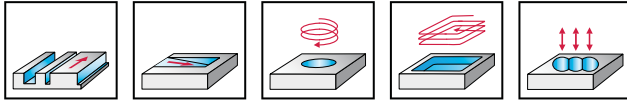

- Solid carbide
- 2 cutting edges
- with centre cut
- 45° helix angle

Special features:

Slot milling: $a_p \leq 1.0 \times D_c$

Shoulder milling: $a_e \leq 0.5 \times D_c$

	P	M	K	N	S	H	O
uncoated				●●			

DIN 6527 L	D_c h10 mm	L_c mm	l_3 mm	d_2 mm	l_1 mm	l_4 mm	Z	d_1 h6 mm	uncoated designation H602511
Shank DIN 6535 HA	1	3	-	-	57	21	2	6	-1
	1,5	3	-	-	57	21	2	6	-1.5
	2	6	-	-	57	21	2	6	-2
	2,5	7	-	-	57	21	2	6	-2.5
	3	7	-	-	57	21	2	6	-3
	3,5	7	-	-	57	21	2	6	-3.5
	4	8	-	-	57	21	2	6	-4
	4,5	8	-	-	57	21	2	6	-4.5
	5	10	-	-	57	21	2	6	-5
	5,5	10	-	-	57	21	2	6	-5.5
	6	10	-	-	57	21	2	6	-6
	8	16	-	-	63	27	2	8	-8
	10	19	-	-	72	32	2	10	-10
	12	22	-	-	83	38	2	12	-12
	14	22	-	-	83	38	2	14	-14
	16	26	-	-	92	44	2	16	-16
	18	26	-	-	92	44	2	18	-18
	20	32	-	-	104	54	2	20	-20

DIN 6527 L	D_c h10 mm	L_c mm	l_3 mm	d_2 mm	l_1 mm	l_4 mm	Z	d_1 h6 mm	uncoated designation H602411
Shank DIN 6535 HA	1	3	6,5	0,96	57	21	2	6	-1
	1,5	3	6,5	1,44	57	21	2	6	-1.5
	2	6	9,5	1,92	57	21	2	6	-2
	3	7	10	2,9	57	21	2	6	-3
	4	8	15	3,8	57	21	2	6	-4
	5	10	16	4,75	57	21	2	6	-5
	6	10	19	5,7	57	21	2	6	-6
	8	16	25	7,6	63	27	2	8	-8
	10	19	30	9,5	72	32	2	10	-10
	12	22	36	11,4	83	38	2	12	-12
	16	26	42	15,2	92	44	2	16	-16
	20	32	52	19	104	54	2	20	-20

End mill Protostar® AL 45

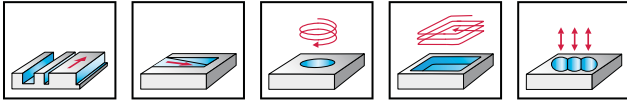

- Solid carbide
- 3 cutting edges
- with centre cut
- 45° helix angle

Special features:

Slot milling: $a_p \leq 0.5 \times D_c$

Shoulder milling: $a_e \leq 0.3 \times D_c$

	P	M	K	N	S	H	O
uncoated				●●			

P standard

ConeFit™

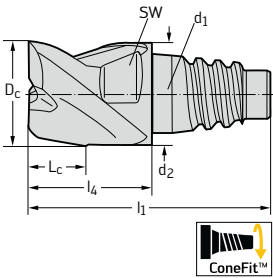

D _c h9 mm	L _c mm	d ₂ mm	l ₁ mm	l ₄ mm	SW mm	d ₁ mm	Z	uncoated designation H6E2211
10	5,5	9,7	23,6	12,4	8	E 10	3	-E10-10
12	6,5	11,7	28,3	14,5	10	E 12	3	-E12-12
16	8,5	15,5	35,7	18,7	12	E 16	3	-E16-16
20	11	19,3	40,8	21,3	16	E 20	3	-E20-20
25	13,5	24,2	49,6	25,6	20	E 25	3	-E25-25

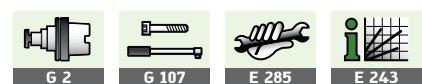

End mill

Protostar® AL 45

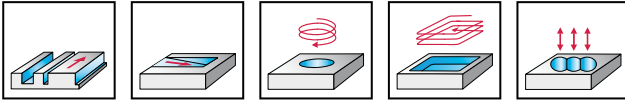

- Solid carbide
- 2 cutting edges
- with centre cut
- 45° helix angle

Special features:

Slot milling: $a_p \leq 1.0 \times D_c$

Shoulder milling: $a_e \leq 0.5 \times D_c$

	P	M	K	N	S	H	O
uncoated				●●			

P standard L

Shank DIN 6535 HA

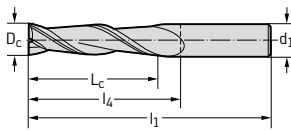

D_c h10 mm	L_c mm	l_1 mm	l_4 mm	d_1 h6 mm	Z	uncoated designation H602551
6	35	80	44	6	2	-6
8	45	97	61	8	2	-8
10	50	118	78	10	2	-10
12	60	120	75	12	2	-12
16	65	130	82	16	2	-16
20	75	145	95	20	2	-20

End mill Protostar® 30



Materials to 48 HRC

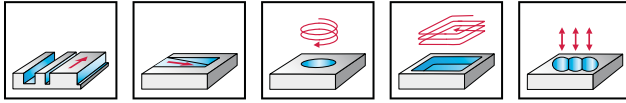

- Solid carbide
- 2 cutting edges
- with centre cut
- 30° helix angle

Special features:

Slot milling: $a_p \leq 0.5 \times D_c$

Shoulder milling: $a_e \leq 0.6 \times D_c$

	P	M	K	N	S	H	O
uncoated				●●			
TAX	●●						

DIN 6527 L	D_c	L_c	l_1	l_4	d_1	Z	uncoated designation H302611	TAX designation H3026118
	h10 mm				h6 mm			
Shank DIN 6535 HA	2	6	57	21	6	2	-2	-2
	2,5	7	57	21	6	2	-2.5	-2.5
	3	7	57	21	6	2	-3	-3
	3,5	7	57	21	6	2	-3.5	-3.5
	4	8	57	21	6	2	-4	-4
	4,5	8	57	21	6	2	-4.5	-4.5
	5	10	57	21	6	2	-5	-5
	6	10	57	21	6	2	-6	-6
	7	13	63	27	8	2	-7	-7
	8	16	63	27	8	2	-8	-8
	9	16	72	32	10	2	-9	-9
	10	19	72	32	10	2	-10	-10
	11	22	83	38	12	2	-11	-11
	12	22	83	38	12	2	-12	-12
	14	22	83	38	14	2	-14	-14
	16	26	92	44	16	2	-16	-16
	18	26	92	44	18	2	-18	-18
	20	32	104	54	20	2	-20	-20

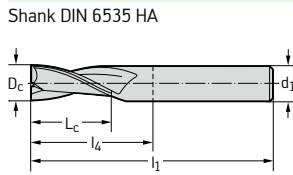

End mill Protostar® 30



Materials to 48 HRC

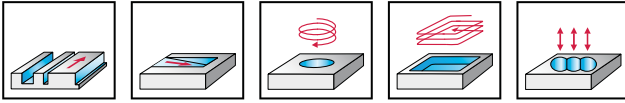

- Solid carbide
- 3 cutting edges
- with centre cut
- 30° helix angle

Special features:

Slot milling: $a_p \leq 0.5 \times D_c$

Shoulder milling: $a_e \leq 0.6 \times D_c$

	P	M	K	N	S	H	O
uncoated				●●			
TAX	●●						

DIN 6527 L	D_c h10 mm	L_c mm	l_1 mm	l_4 mm	d_1 h6 mm	Z	uncoated designation H302711	TAX designation H3027118
Shank DIN 6535 HA	2	6	57	21	6	3	-2	-2
	2,5	7	57	21	6	3	-2.5	-2.5
	3	7	57	21	6	3	-3	-3
	3,5	7	57	21	6	3	-3.5	-3.5
	4	8	57	21	6	3	-4	-4
	4,5	8	57	21	6	3	-4.5	-4.5
	5	10	57	21	6	3	-5	-5
	5,5	10	57	21	6	3	-5.5	-5.5
	6	10	57	21	6	3	-6	-6
	6,5	13	63	27	8	3	-6.5	-6.5
	7	13	63	27	8	3	-7	-7
	7,5	16	63	27	8	3	-7.5	-7.5
	8	16	63	27	8	3	-8	-8
	9	16	72	32	10	3	-9	-9
	10	19	72	32	10	3	-10	-10
	11	22	83	38	12	3	-11	-11
	12	22	83	38	12	3	-12	-12
	13	22	83	38	14	3	-13	-13
	14	22	83	38	14	3	-14	-14
	15	26	92	44	16	3	-15	-15
	16	26	92	44	16	3	-16	-16
	18	26	92	44	18	3	-18	-18
	20	32	104	54	20	3	-20	-20

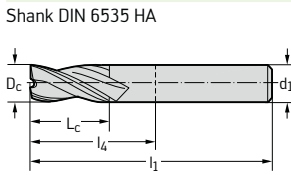

End mill Protostar® 30

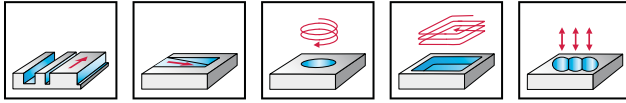

- Solid carbide
- 3 cutting edges
- with centre cut
- 30° helix angle

Special features:

 Slot milling: $a_p \leq 0.5 \times D_c$

 Shoulder milling: $a_e \leq 0.6 \times D_c$

	P	M	K	N	S	H	O
uncoated				●●			
TAX	●●						

DIN 6527 L	D_c h10 mm	L_c mm	l_1 mm	l_4 mm	d_1 h6 mm	Z	uncoated designation H302731	TAX designation H3027318	
Shank DIN 6535 HA 	1	3	38	10	3	3	-1	-1	
	1.1	3	38	10	3	3	-1.1	-1.1	
	1.2	3	38	10	3	3	-1.2	-1.2	
	1.3	3	38	10	3	3	-1.3	-1.3	
	1.4	3	38	10	3	3	-1.4	-1.4	
	1.5	3	38	10	3	3	-1.5	-1.5	
	1.6	3	38	10	3	3	-1.6	-1.6	
	1.7	3	38	10	3	3	-1.7	-1.7	
	1.8	3	38	10	3	3	-1.8	-1.8	
	1.9	3	38	10	3	3	-1.9	-1.9	
	2	3	38	10	3	3	3	-2X3	-2X3
	2	6	38	10	3	3	3	-2X6	-2X6
	2.1	3	38	10	3	3	3	-2.1	-2.1
	2.2	3	38	10	3	3	3	-2.2	-2.2
	2.3	3	38	10	3	3	3	-2.3	-2.3
	2.4	3	38	10	3	3	3	-2.4	-2.4
	2.5	3	38	10	3	3	3	-2.5X3	-2.5X3
	2.5	7	38	10	3	3	3	-2.5X7	-2.5X7
	2.6	3	38	10	3	3	3	-2.6	-2.6
	2.7	3	38	10	3	3	3	-2.7	-2.7
	2.8	3	38	10	3	3	3	-2.8	-2.8
	2.9	3	38	10	3	3	3	-2.9	-2.9
	3	3	38	10	3	3	3	-3X3	-3X3
	3	7	38	10	3	3	3	-3X7	-3X7

End mill Protostar® 30



Materials to 48 HRC

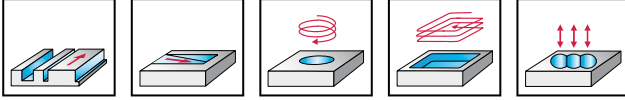

- Solid carbide
- 3 cutting edges
- with centre cut
- 30° helix angle

Special features:

Slot milling: $a_p \leq 0.3 \times D_c$

Shoulder milling: $a_e \leq 0.3 \times D_c$

	P	M	K	N	S	H	O
TAX	●●						

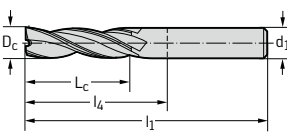
P standard L		D_c h10 mm	L_c mm	l_1 mm	l_4 mm	d_1 h6 mm	Z	TAX designation H3027418
Shank DIN 6535 HA		1	4	38	10	3	3	-1
		1,5	6	38	10	3	3	-1,5
		2	8	38	10	3	3	-2
		3	12	38	12	3	3	-3
		4	14	50	22	4	3	-4
		5	16	57	21	6	3	-5
		6	22	65	29	6	3	-6
		8	28	80	44	8	3	-8
		10	32	100	60	10	3	-10
		12	38	100	55	12	3	-12
		16	50	115	67	16	3	-16
		20	50	125	75	20	3	-20

End mill Protostar® 30



specially for graphite

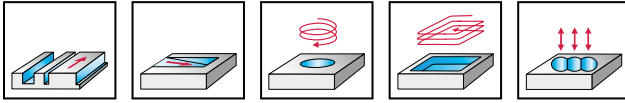

- Solid carbide
- 3 cutting edges
- with centre cut
- 30° helix angle

Special features:

Slot milling: $a_p \leq 0.3 \times D_c$

Shoulder milling: $a_e \leq 0.3 \times D_c$

	P	M	K	N	S	H	O
DIA							●●

P standard L	D_c	L_c	l_1	l_4	d_1	Z	DIA designation H3027419
	h10 mm						
Shank DIN 6535 HA	1	4	38	10	3	3	-1
	1,5	6	38	10	3	3	-1.5
	2	8	38	10	3	3	-2
	3	12	38	12	3	3	-3
	4	14	50	22	4	3	-4
	5	16	57	21	6	3	-5
	6	22	65	29	6	3	-6
	8	28	80	44	8	3	-8
	10	32	100	60	10	3	-10
	12	38	100	55	12	3	-12
	16	50	115	67	16	3	-16

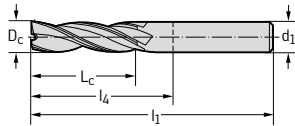

End mill Protostar® HSC 30



Materials to 55 HRC

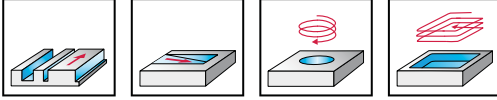

- Solid carbide
- long reach
- 2 cutting edges
- with centre cut
- 30° helix angle

Special features:

Slot milling: $a_p \leq 0.1 \times D_c$

Shoulder milling: $a_e \leq 0.1 \times D_c$

	P	M	K	N	S	H	O
TAX	●●						

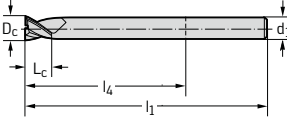
P standard XL	D_c h10 mm	L_c mm	l_1 mm	l_4 mm	d_1 h5 mm	Z	TAX designation H3090418
Shank DIN 6535 HA	6,3	6	100	64	6	2	-6.3
	8,3	8	100	64	8	2	-8.3
	10,3	10	150	110	10	2	-10.3
	12,5	12	150	105	12	2	-12.5 ¹
	14,5	14	150	105	14	2	-14.5 ¹
	16,5	16	150	102	16	2	-16.5 ¹

¹Shank tolerance h6

End mill Protostar® AL 30

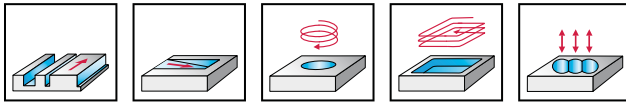

- Solid carbide
- 1 to 2 cutting edges
- with centre cut
- 30° helix angle

Special features:

 Slot milling: $a_p \leq 1.0 \times D_c$

 Shoulder milling: $a_e \leq 0.6 \times D_c$

	P	M	K	N	S	H	O
uncoated				●●			

DIN 6527 L	D_c h10 mm	L_c mm	l_1 mm	l_4 mm	d_1 h6 mm	Z	uncoated designation H901411
Shank DIN 6535 HA	2	6	57	21	6	2	-2
	3	7	57	21	6	2	-3
	4	8	57	21	6	2	-4
	5	10	57	21	6	2	-5
	6	10	57	21	6	2	-6
	8	16	63	27	8	2	-8
	10	19	72	32	10	2	-10
	12	22	83	38	12	2	-12

DIN 6527 L	D_c h10 mm	L_c mm	l_1 mm	l_4 mm	d_1 h6 mm	Z	uncoated designation H901451
Shank DIN 6535 HA	3	7	57	21	6	1	-3 ²
	4	8	57	21	6	1	-4 ²
	5	10	57	21	6	1	-5 ²
	6	10	57	21	6	1	-6 ²
	8	16	63	27	8	1	-8 ²
	10	19	72	32	10	1	-10 ²

²Nominal tool diameter

End mill

Protostar® AL 25

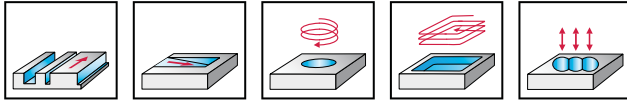

- Solid carbide
- 2 cutting edges
- with centre cut
- 25° helix angle

Special features:

Slot milling: $a_p \leq 0.5 \times D_c$

Shoulder milling: $a_e \leq 0.3 \times D_c$

	P	M	K	N	S	H	O
uncoated				●●			

P standard L	D_c h10 mm	L_c mm	l_3 mm	d_2 mm	l_1 mm	l_4 mm	d_1 h6 mm	Z	uncoated designation H602641
Shank DIN 6535 HA	2	8	-	-	38	10	3	2	-2
	3	12	-	-	38	10	3	2	-3
	4	14	-	-	50	22	4	2	-4
	5	16	-	-	57	21	6	2	-5
	6	22	-	-	65	29	6	2	-6
	8	28	-	-	80	44	8	2	-8
	10	32	-	-	90	50	10	2	-10
	12	38	-	-	100	55	12	2	-12
	16	50	-	-	115	67	16	2	-16
	20	50	-	-	125	75	20	2	-20

P standard L	D_c h10 mm	L_c mm	l_3 mm	d_2 mm	l_1 mm	l_4 mm	d_1 h5 mm	Z	uncoated designation H602681
Shank DIN 6535 HA	2	3	9	1,92	38	10	3	2	-2 ¹
	3	4	12	2,9	38	10	3	2	-3 ¹
	4	6	14	3,8	50	22	4	2	-4 ¹
	5	8	16	4,75	57	21	6	2	-5
	6	10	28	5,7	65	29	6	2	-6
	8	12	35	7,6	80	44	8	2	-8
	10	14	45	9,5	90	50	10	2	-10
	12	16	50	11,4	100	55	12	2	-12 ¹
	16	20	63	15,2	115	67	16	2	-16 ¹
	20	20	70	19	125	75	20	2	-20 ¹

¹Shank tolerance h6

End mill Protostar® N 45

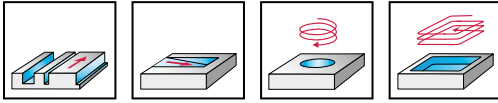

- HSS-E-PM
- 3 to 6 cutting edges
- with centre cut
- 45° helix angle

Special features:

 Slot milling: $a_p \leq 0.5 \times D_c$

 Shoulder milling: $a_e \leq 0.3 \times D_c$

	P	M	K	N	S	H	O
uncoated	●			●●			
ACN	●●	●		●			

DIN 844 B	D_c k10 mm	L_c mm	l_1 mm	l_4 mm	d_1 h6 mm	Z	uncoated designation P312301	ACN designation P3123017
Shank DIN 1835 B	3	8	52	16	6	3	-3	
	4	11	55	19	6	3	-4	
	5	13	57	21	6	3	-5	-5
	6	13	57	21	6	3	-6	-6
	8	19	69	29	10	4	-8	-8
	10	22	72	32	10	4	-10	-10
	12	26	83	38	12	4	-12	-12
	14	26	83	38	12	4	-14	-14
	16	32	92	44	16	4	-16	-16
	20	38	104	54	20	4	-20	-20
	22	38	104	54	20	5	-22	-22
	25	45	121	65	25	5	-25	-25
	30	45	121	65	25	6	-30	-30

DIN 844 B	D_c k10 mm	L_c mm	l_1 mm	l_4 mm	d_1 h6 mm	Z	ACN designation P3123117
Shank DIN 1835 B	6	24	68	32	6	3	-6
	8	38	88	48	10	4	-8
	10	45	95	55	10	4	-10
	12	53	110	65	12	4	-12
	14	53	110	65	12	4	-14
	16	63	123	75	16	4	-16
	18	63	123	75	16	4	-18
	20	75	141	91	20	4	-20

End mill

Protostar® W 40

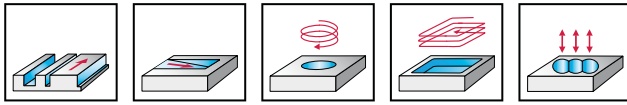

- HSS-E-PM
- 3 cutting edges
- with centre cut
- 40° helix angle

Special features:

Slot milling: $a_p \leq 1.0 \times D_c$

Shoulder milling: $a_e \leq 0.6 \times D_c$

	P	M	K	N	S	H	O
uncoated	●			●●			

DIN 845	D_c k10 mm	L_c mm	l_1 mm	l_4 mm	d_1 h6 mm	Z	uncoated designation P312401
Shank DIN 1835 B	2	7	51	15	6	3	-2
	2,5	8	52	16	6	3	-2.5
	3	8	52	16	6	3	-3
	3,5	10	54	18	6	3	-3.5
	4	11	55	19	6	3	-4
	4,5	11	55	19	6	3	-4.5
	5	13	57	21	6	3	-5
	5,5	13	57	21	6	3	-5.5
	6	13	57	21	6	3	-6
	6,5	16	66	26	10	3	-6.5
	7	16	66	26	10	3	-7
	8	19	69	29	10	3	-8
	9	19	69	29	10	3	-9
	10	22	72	32	10	3	-10
	12	26	83	38	12	3	-12
	14	26	83	38	12	3	-14
	16	32	92	44	16	3	-16
	18	32	92	44	16	3	-18
	20	38	104	54	20	3	-20
	22	38	104	54	20	3	-22
	25	45	121	65	25	3	-25

DIN 844 B	D_c k10 mm	L_c mm	l_1 mm	l_4 mm	d_1 h6 mm	Z	uncoated designation P312411
Shank DIN 1835 B	2	10	54	18	6	3	-2
	2,5	12	56	20	6	3	-2.5
	3	12	56	20	6	3	-3
	3,5	15	59	23	6	3	-3.5
	4	19	63	27	6	3	-4
	4,5	19	63	27	6	3	-4.5
	5	24	68	32	6	3	-5
	5,5	24	68	32	6	3	-5.5
	6	24	68	32	6	3	-6
	7	30	80	40	10	3	-7
	8	38	88	48	10	3	-8
	9	38	88	48	10	3	-9
	10	45	95	55	10	3	-10
	12	53	110	65	12	3	-12
	16	63	123	75	16	3	-16
	18	63	123	75	16	3	-18
	20	75	141	91	20	3	-20
	25	90	166	110	25	3	-25

End mill

Protostar® Inox V 40

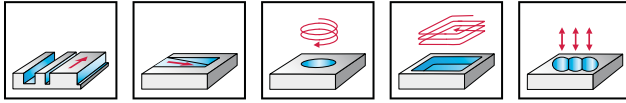

- HSS-E-PM
- 3 cutting edges
- with centre cut
- 40° helix angle

Special features:

 Slot milling: $a_p \leq 1.0 \times D_c$

 Shoulder milling: $a_e \leq 0.6 \times D_c$

	P	M	K	N	S	H	O
ACN		●●					

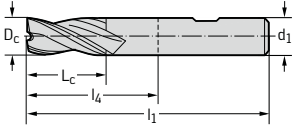
DIN 327 D	D_c e8 mm	L_c mm	l_1 mm	l_4 mm	d_1 h6 mm	Z	ACN designation P4117027
Shank DIN 1835 B 	2	4	48	12	6	3	-2
	3	5	49	13	6	3	-3
	4	7	51	15	6	3	-4
	5	8	52	16	6	3	-5
	6	8	52	16	6	3	-6
	7	10	60	20	10	3	-7
	8	11	61	21	10	3	-8
	10	13	63	23	10	3	-10
	12	16	73	28	12	3	-12
	14	16	73	28	12	3	-14
	15	16	73	28	12	3	-15
	16	19	79	31	16	3	-16
	18	19	79	31	16	3	-18
	20	22	88	38	20	3	-20

Full size

End mill

Protostar® AL 40

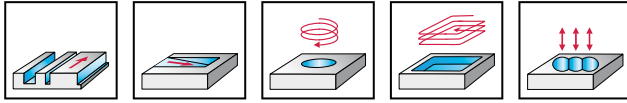

- HSS-E Co8
- 2 cutting edges
- with centre cut
- 40° helix angle

Special features:

Slot milling: $a_p \leq 1.0 \times D_c$

Shoulder milling: $a_e \leq 0.6 \times D_c$

	P	M	K	N	S	H	O
uncoated	●			●●			

DIN 844 A	D_c e8 mm	L_c mm	l_1 mm	l_4 mm	d_1 h6 mm	Z	uncoated designation P602602
Shank DIN 1835 A	2	7	51	15	6	2	-2
	3	8	52	16	6	2	-3
	4	11	55	19	6	2	-4
	5	13	57	21	6	2	-5
	6	13	57	21	6	2	-6
	7	16	66	26	10	2	-7
	8	19	69	29	10	2	-8
	9	19	69	29	10	2	-9
	10	22	72	32	10	2	-10
	11	22	79	34	12	2	-11
	12	26	83	38	12	2	-12
	14	26	83	38	12	2	-14
	15	26	83	38	12	2	-15
	16	32	92	44	16	2	-16
	18	32	92	44	16	2	-18
	20	38	104	54	20	2	-20

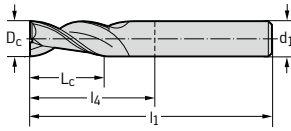

DIN 844 B	D_c e8 mm	L_c mm	l_1 mm	l_4 mm	d_1 h6 mm	Z	uncoated designation P612602
Shank DIN 1835 B	2	7	51	15	6	2	-2
	3	8	52	16	6	2	-3
	4	11	55	19	6	2	-4
	5	13	57	21	6	2	-5
	6	13	57	21	6	2	-6
	7	16	66	26	10	2	-7
	8	19	69	29	10	2	-8
	9	19	69	29	10	2	-9
	10	22	72	32	10	2	-10
	12	26	83	38	12	2	-12
	14	26	83	38	12	2	-14
	15	26	83	38	12	2	-15
	16	32	92	44	16	2	-16
	20	38	104	54	20	2	-20
	22	38	104	54	20	2	-22

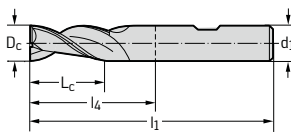

End mill Protostar® AL 40

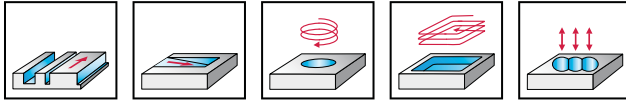

- HSS-E Co8
- 2 cutting edges
- with centre cut
- 40° helix angle

Special features:

 Slot milling: $a_p \leq 1.0 \times D_c$

 Shoulder milling: $a_e \leq 0.6 \times D_c$

	P	M	K	N	S	H	O
uncoated	●			●●			

DIN 844 A	D_c e8 mm	L_c mm	l_1 mm	l_4 mm	d_1 h6 mm	Z	uncoated designation P602612
Shank DIN 1835 A	6	24	68	32	6	2	-6
	8	38	88	48	10	2	-8
	10	45	95	55	10	2	-10
	12	53	110	65	12	2	-12
	14	53	110	65	12	2	-14
	16	63	123	75	16	2	-16
	18	63	123	75	16	2	-18
	20	75	141	91	20	2	-20

DIN 844 B	D_c e8 mm	L_c mm	l_1 mm	l_4 mm	d_1 h6 mm	Z	uncoated designation P612612
Shank DIN 1835 B	6	24	68	32	6	2	-6
	7	30	80	40	10	2	-7
	8	38	88	48	10	2	-8
	9	38	88	48	10	2	-9
	10	45	95	55	10	2	-10
	12	53	110	65	12	2	-12
	14	53	110	65	12	2	-14
	16	63	123	75	16	2	-16

End mill Protostar® 30

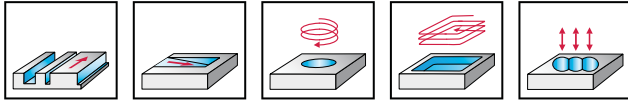

- HSS-E-PM
- 2 cutting edges
- with centre cut
- 30° helix angle

Special features:

Slot milling: $a_p \leq 1.0 \times D_c$

Shoulder milling: $a_e \leq 0.6 \times D_c$

	P	M	K	N	S	H	O
uncoated	●			●●			
ACN	●●	●	●				

DIN 327	D_c e8 mm	L_c mm	l_1 mm	l_4 mm	d_1 h6 mm	Z	uncoated designation P300611
Shank DIN 1835 A	1.8	4	48	12	6	2	-1.8
	2	4	48	12	6	2	-2
	2.5	5	49	13	6	2	-2.5
	2.8	5	49	13	6	2	-2.8
	3	5	49	13	6	2	-3
	3.5	6	50	14	6	2	-3.5
	3.8	7	51	15	6	2	-3.8
	4	7	51	15	6	2	-4
	4.5	7	51	15	6	2	-4.5
	4.8	8	52	16	6	2	-4.8
	5	8	52	16	6	2	-5
	5.5	8	52	16	6	2	-5.5
	5.75	8	52	16	6	2	-5.75
	6	8	52	16	6	2	-6
	6.5	10	60	20	10	2	-6.5
	7	10	60	20	10	2	-7
	7.5	10	60	20	10	2	-7.5
	7.75	11	61	21	10	2	-7.75
	8	11	61	21	10	2	-8
	8.5	11	61	21	10	2	-8.5
	9	11	61	21	10	2	-9
	9.5	11	61	21	10	2	-9.5
10	13	63	23	10	2	-10	
10.5	13	70	25	12	2	-10.5	
11	13	70	25	12	2	-11	
12	16	73	28	12	2	-12	
12.5	16	73	28	12	2	-12.5	
13	16	73	28	12	2	-13	
14	16	73	28	12	2	-14	
15	16	73	28	12	2	-15	
16	19	79	31	16	2	-16	
17	19	79	31	16	2	-17	
18	19	79	31	16	2	-18	
19	19	79	31	16	2	-19	
20	22	88	38	20	2	-20	
22	22	88	38	20	2	-22	

DIN 327	D_c e8 mm	L_c mm	l_1 mm	l_4 mm	d_1 h6 mm	Z	uncoated designation P310611	ACN designation P3106117
Shank DIN 1835 B	1	2.5	48	12	6	2	-1	-1
	1.5	3	48	12	6	2	-1.5	-1.5
	2	4	48	12	6	2	-2	-2
	2.5	5	49	13	6	2	-2.5	-2.5
	3	5	49	13	6	2	-3	-3
	3.5	6	50	14	6	2	-3.5	-3.5
	4	7	51	15	6	2	-4	-4
	4.5	7	51	15	6	2	-4.5	-4.5

Continued



End mill Protostar® 30



	P	M	K	N	S	H	O
uncoated	●	●	●	●	●	●	●
ACN	●	●	●	●	●	●	●

Continued

DIN 327	D _c e8 mm	L _c mm	l ₁ mm	l ₄ mm	d ₁ h6 mm	Z	uncoated designation P310611	ACN designation P3106117
Shank DIN 1835 B	5	8	52	16	6	2	-5	-5
	5,5	8	52	16	6	2	-5,5	-5,5
	6	8	52	16	6	2	-6	-6
	6,5	10	60	20	10	2	-6,5	-6,5
	7	10	60	20	10	2	-7	-7
	7,5	10	60	20	10	2	-7,5	
	8	11	61	21	10	2	-8	-8
	8,5	11	61	21	10	2	-8,5	
	9	11	61	21	10	2	-9	-9
	9,5	11	61	21	10	2	-9,5	
	10	13	63	23	10	2	-10	-10
	10,5	13	70	25	12	2	-10,5	
	11	13	70	25	12	2	-11	-11
	12	16	73	28	12	2	-12	-12
	12,5	16	73	28	12	2	-12,5	
	13	16	73	28	12	2	-13	-13
	14	16	73	28	12	2	-14	-14
	15	16	73	28	12	2	-15	-15
	16	19	79	31	16	2	-16	-16
	17	19	79	31	16	2	-17	
	18	19	79	31	16	2	-18	-18
	19	19	79	31	16	2	-19	
	20	22	88	38	20	2	-20	-20
	22	22	88	38	20	2	-22	-22
	24	26	102	46	25	2	-24	
	25	26	102	46	25	2	-25	
	26	26	102	46	25	2	-26	
	28	26	102	46	25	2	-28	
	30	26	102	46	25	2	-30	
	36	32	112	52	32	2	-36	
	40	38	130	60	40	2	-40	

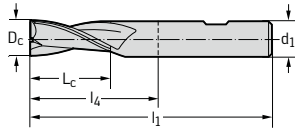

DIN 844 A	D _c e8 mm	L _c mm	l ₁ mm	l ₄ mm	d ₁ h6 mm	Z	uncoated designation P301612	
Shank DIN 1835 A	2	7	51	15	6	2	-2	
	3	8	52	16	6	2	-3	
	4	11	55	19	6	2	-4	
	5	13	57	21	6	2	-5	
	6	13	57	21	6	2	-6	
	7	16	66	26	10	2	-7	
	8	19	69	29	10	2	-8	
	9	19	69	29	10	2	-9	
	10	22	72	32	10	2	-10	
	11	22	79	34	12	2	-11	
	12	26	83	38	12	2	-12	
	13	26	83	38	12	2	-13	
	14	26	83	38	12	2	-14	
	15	26	83	38	12	2	-15	
	16	32	92	44	16	2	-16	
	18	32	92	44	16	2	-18	
	20	38	104	54	20	2	-20	

Full size

End mill Protostar® 30

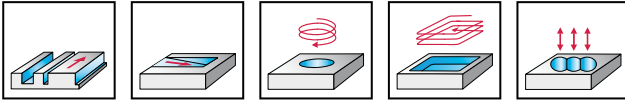

- HSS-E-PM
- 2 cutting edges
- with centre cut
- 30° helix angle

Special features:

Slot milling: $a_p \leq 1.0 \times D_c$

Shoulder milling: $a_e \leq 0.6 \times D_c$

	P	M	K	N	S	H	O
uncoated	●			●●			
ACN	●●	●	●				

DIN 844 A

Shank DIN 1835 B

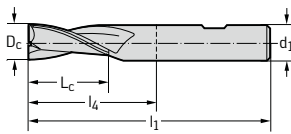

D_c e8 mm	L_c mm	l_1 mm	l_4 mm	d_1 h6 mm	Z	uncoated designation P311612	ACN designation P3116127
2	7	51	15	6	2	-2	-2
2,5	8	52	16	6	2	-2,5	-2,5
3	8	52	16	6	2	-3	-3
3,5	10	54	18	6	2	-3,5	-3,5
4	11	55	19	6	2	-4	-4
4,5	11	55	19	6	2	-4,5	-4,5
5	13	57	21	6	2	-5	-5
5,5	13	57	21	6	2	-5,5	-5,5
6	13	57	21	6	2	-6	-6
7	16	66	26	10	2	-7	-7
8	19	69	29	10	2	-8	-8
9	19	69	29	10	2	-9	-9
10	22	72	32	10	2	-10	-10
11	22	79	34	12	2	-11	-11
12	26	83	38	12	2	-12	-12
13	26	83	38	12	2	-13	-13
14	26	83	38	12	2	-14	-14
15	26	83	38	12	2	-15	-15
16	32	92	44	16	2	-16	-16
18	32	92	44	16	2	-18	-18
20	38	104	54	20	2	-20	-20
22	38	104	54	20	2	-22	-22
25	45	121	65	25	2	-25	-25
30	45	121	65	25	2	-30	-30

End mill Protostar® N 30

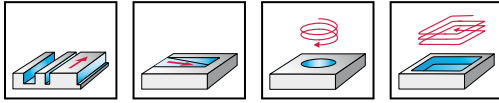
Special features:

 Slot milling: $a_p \leq 0.3 \times D_c$

 Shoulder milling: $a_e \leq 0.1 \times D_c$

- HSS-E-PM
- 4 to 8 cutting edges
- with centre cut
- 30° helix angle

	P	M	K	N	S	H	O
uncoated	●			●●			
ACN	●●	●		●			

DIN 844 A

Shank DIN 1835 A

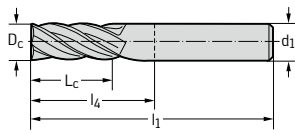

D_c k10 mm	L_c mm	l_1 mm	l_4 mm	d_1 h6 mm	Z	uncoated designation P302201
2	7	51	15	6	4	-2
3	8	52	16	6	4	-3
4	11	55	19	6	4	-4
5	13	57	21	6	4	-5
6	13	57	21	6	4	-6
7	16	66	26	10	4	-7
8	19	69	29	10	4	-8
9	19	69	29	10	4	-9
10	22	72	32	10	4	-10
12	26	83	38	12	4	-12
14	26	83	38	12	4	-14
16	32	92	44	16	4	-16
18	32	92	44	16	4	-18
20	38	104	54	20	4	-20
22	38	104	54	20	5	-22
25	45	121	65	25	5	-25

DIN 844 B

Shank DIN 1835 B

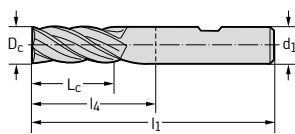

D_c k10 mm	L_c mm	l_1 mm	l_4 mm	d_1 h6 mm	Z	uncoated designation P312201	ACN designation P3122017
1	4	51	15	6	4	-1	
1.5	5	51	15	6	4	-1.5	
2	7	51	15	6	4	-2	-2
2.5	8	52	16	6	4	-2.5	
3	8	52	16	6	4	-3	-3
3.5	10	54	18	6	4	-3.5	
4	11	55	19	6	4	-4	-4
4.5	11	55	19	6	4	-4.5	
5	13	57	21	6	4	-5	-5
5.5	13	57	21	6	4	-5.5	
6	13	57	21	6	4	-6	-6
6.5	16	66	26	10	4	-6.5	
7	16	66	26	10	4	-7	-7
7.5	16	66	26	10	4	-7.5	
8	19	69	29	10	4	-8	-8
8.5	19	69	29	10	4	-8.5	
9	19	69	29	10	4	-9	-9
9.5	19	69	29	10	4	-9.5	
10	22	72	32	10	4	-10	-10
11	22	79	34	12	4	-11	-11
12	26	83	38	12	4	-12	-12
13	26	83	38	12	4	-13	-13
14	26	83	38	12	4	-14	-14
15	26	83	38	12	4	-15	-15

Continued

End mill Protostar® N 30

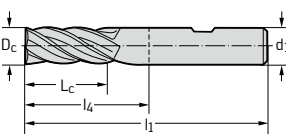

Continued

DIN 844 B		D_c k10 mm	L_c mm	l₁ mm	l₄ mm	d₁ h6 mm	Z	uncoated designation P312201	ACN designation P3122017
Shank DIN 1835 B		16	32	92	44	16	4	-16	-16
		18	32	92	44	16	4	-18	-18
		20	38	104	54	20	4	-20	-20
		22	38	104	54	20	5	-22	-22
		25	45	121	65	25	5	-25	-25
		28	45	121	65	25	6	-28	-28
		30	45	121	65	25	6	-30	-30
		32	53	133	73	32	6	-32	-32
		36	53	133	73	32	6	-36 ¹	
		40	63	155	85	40	6	-40 ¹	
		50	75	177	117	50	8	-50 ¹	

¹ without centre cut

End mill Protostar® N 30

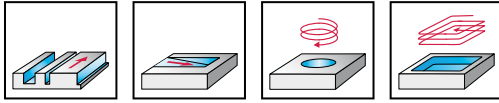
Special features:

 Slot milling: $a_p \leq 0.3 \times D_c$

 Shoulder milling: $a_e \leq 0.1 \times D_c$

- HSS-E-PM
- 4 to 8 cutting edges
- with centre cut
- 30° helix angle

	P	M	K	N	S	H	O
uncoated	●			●●			
ACN	●●	●		●			

DIN 844 A	D_c k10 mm	L_c mm	l_1 mm	l_4 mm	d_1 h6 mm	Z	uncoated designation P302211
Shank DIN 1835 A	2	10	54	18	6	4	-2
	3	12	56	20	6	4	-3
	4	19	63	27	6	4	-4
	5	24	68	32	6	4	-5
	6	24	68	32	6	4	-6
	7	30	80	40	10	4	-7
	8	38	88	48	10	4	-8
	9	38	88	48	10	4	-9
	10	45	95	55	10	4	-10
	11	45	102	57	12	4	-11
	12	53	110	65	12	4	-12
	13	53	110	65	12	4	-13
	14	53	110	65	12	4	-14
	15	53	110	65	12	4	-15
	16	63	123	75	16	4	-16
	18	63	123	75	16	4	-18
	20	75	141	91	20	4	-20
	22	75	141	91	20	5	-22
	25	90	166	110	25	5	-25

DIN 844 B	D_c k10 mm	L_c mm	l_1 mm	l_4 mm	d_1 h6 mm	Z	uncoated designation P312211	ACN designation P3122117
Shank DIN 1835 B	2	10	56	20	6	4	-2	
	2,5	12	56	20	6	4	-2.5	
	3	12	56	20	6	4	-3	-3
	3,5	15	59	23	6	4	-3.5	
	4	19	63	27	6	4	-4	-4
	4,5	19	63	27	6	4	-4.5	
	5	24	68	32	6	4	-5	-5
	5,5	24	68	32	6	4	-5.5	
	6	24	68	32	6	4	-6	-6
	6,5	30	80	40	10	4	-6.5	
	7	30	80	40	10	4	-7	-7
	8	38	88	48	10	4	-8	-8
	9	38	88	48	10	4	-9	-9
	10	45	95	55	10	4	-10	-10
	11	45	102	57	12	4	-11	
	12	53	110	65	12	4	-12	-12
	13	53	110	65	12	4	-13	
	14	53	110	65	12	4	-14	-14
	15	53	110	65	12	4	-15	-15
	16	63	123	75	16	4	-16	-16
	18	63	123	75	16	4	-18	-18

Continued

End mill Protostar® N 30



Continued

DIN 844 B	D _c k10 mm	L _c mm	l ₁ mm	l ₄ mm	d ₁ h6 mm	Z	uncoated designation P312211	ACN designation P312217
Shank DIN 1835 B	20	75	141	91	20	4	-20	-20
	22	75	141	91	20	5	-22	
	25	90	166	110	25	5	-25	-25
	28	90	166	110	25	6	-28	
	30	90	166	110	25	6	-30	
	32	106	186	126	32	6	-32	
	36 ¹	106	186	126	32	6	-36	
	40 ¹	125	217	147	40	6	-40	
	50 ¹	150	252	192	50	8	-50	

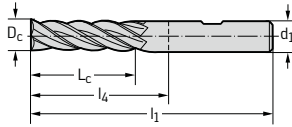
¹ without centre cut

End mill Protostar® N 30

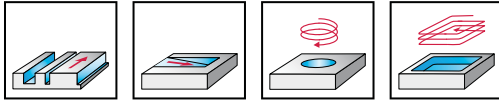

- HSS-E-PM
- 4 to 6 cutting edges
- without centre cut
- 30° helix angle

Special features:

 Slot milling: $a_p \leq 0.3 \times D_c$

 Shoulder milling: $a_e \leq 0.1 \times D_c$

	P	M	K	N	S	H	O
uncoated	●	●	●	●	●	●	●
ACN	●	●	●	●	●	●	●

P standard

Shank DIN 1835 B

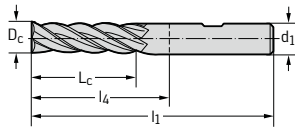

D_c k10 mm	L_c mm	l_1 mm	l_4 mm	d_1 h6 mm	Z	uncoated designation P312221
16	80	137	89	16	4	-16X80
16	100	157	109	16	4	-16X100
18	100	157	109	16	4	-18X100
20	100	165	109	25	4	-20X100
20	125	190	134	25	4	-20X125
25	125	192	136	25	5	-25X125
25	140	207	151	25	5	-25X140
25	160	227	171	25	5	-25X160
32	140	214	154	32	6	-32X140
32	160	234	174	32	6	-32X160
32	180	254	194	32	6	-32X180

P standard

Shank DIN 1835 B

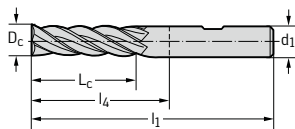

D_c k10 mm	L_c mm	l_1 mm	l_4 mm	d_1 h6 mm	Z	ACN designation P3122317
10	34	84	44	10	4	-10
12	40	97	52	12	4	-12
14	40	97	52	12	4	-14
16	45	105	57	16	4	-16
18	45	105	57	16	4	-18
20	55	121	71	20	4	-20
22	63	129	79	20	5	-22
25	68	144	88	25	5	-25

End mill Protostar® 30

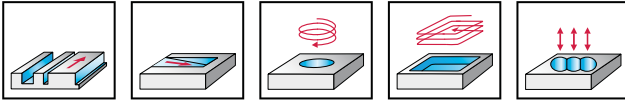

- HSS-E-PM
- long reach
- 2 cutting edges
- with centre cut
- 30° helix angle

Special features:
 Slot milling: $a_p \leq 1.0 \times D_c$
 Shoulder milling: $a_e \leq 0.6 \times D_c$

	P	M	K	N	S	H	O
uncoated	●			●●			
ACN	●●	●		●			

P standard	D_c	L_c	l_1	l_4	d_1	Z	uncoated designation P302621
	js14 mm				mm		
Shank DIN 1835 A	6	13	180	144	6	2	-6
	8	19	180	144	8	2	-8
	10	22	200	160	10	2	-10
	12	26	200	155	12	2	-12
	16	32	200	152	16	2	-16

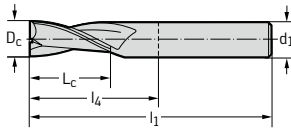

End mill Protostar® 30

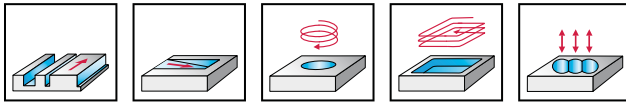

- HSS-E-PM
- 3 cutting edges
- with centre cut
- 30° helix angle

Special features:

 Slot milling: $a_p \leq 1.0 \times D_c$

 Shoulder milling: $a_e \leq 0.6 \times D_c$

	P	M	K	N	S	H	O
uncoated	●			●●			
ACN	●●	●		●			

DIN 844 B	D_c e8 mm	L_c mm	l_1 mm	l_4 mm	d_1 h6 mm	Z	uncoated designation P311712	ACN designation P3117127
Shank DIN 1835 B	1.5	5	51	15	6	3	-1.5	
	2	7	51	15	6	3	-2	-2
	2.5	8	52	16	6	3	-2.5	
	3	8	52	16	6	3	-3	-3
	3.5	10	54	18	6	3	-3.5	
	4	11	55	19	6	3	-4	-4
	4.5	11	55	19	6	3	-4.5	
	5	13	57	21	6	3	-5	-5
	5.5	13	57	21	6	3	-5.5	
	6	13	57	21	6	3	-6	-6
	6.5	16	66	26	10	3	-6.5	
	7	16	66	26	10	3	-7	
	7.5	16	66	26	10	3	-7.5	
	8	19	69	29	10	3	-8	-8
	8.5	19	69	29	10	3	-8.5	
	9	19	69	29	10	3	-9	
	9.5	19	69	29	10	3	-9.5	
	10	22	72	32	10	3	-10	-10
	11	22	79	34	12	3	-11	
	12	26	83	38	12	3	-12	-12
	13	26	83	38	12	3	-13	
	14	26	83	38	12	3	-14	-14
	15	26	83	38	12	3	-15	
	16	32	92	44	16	3	-16	-16
	17	32	92	44	16	3	-17	
	18	32	92	44	16	3	-18	-18
	19	32	92	44	16	3	-19	
	20	38	104	54	20	3	-20	-20
	22	38	104	54	20	3	-22	
	25	45	121	65	25	3	-25	
	28	45	121	65	25	3	-28	
	30	45	121	65	25	3	-30	
	32	53	133	73	32	3	-32	

Shank DIN 1835 B

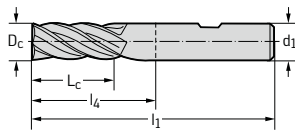

End mill Protostar® 30

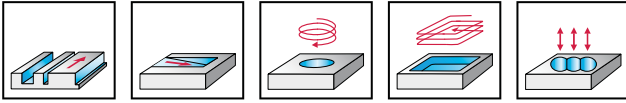

- HSS-E Co8
- 3 cutting edges
- with centre cut
- 30° helix angle

Special features:

Slot milling: $a_p \leq 1.0 \times D_c$

Shoulder milling: $a_e \leq 0.6 \times D_c$

	P	M	K	N	S	H	O
uncoated	●			●●			

DIN 844 B	D_c e8 mm	L_c mm	l_1 mm	l_4 mm	d_1 h6 mm	Z	uncoated designation P311722
Shank DIN 1835 B	3	12	56	20	6	3	-3
	4	19	63	27	6	3	-4
	5	24	68	32	6	3	-5
	6	24	68	32	6	3	-6
	8	38	88	48	10	3	-8
	10	45	95	55	10	3	-10
	12	53	110	65	12	3	-12
	14	53	110	65	12	3	-14
	15	53	110	65	12	3	-15
	16	63	123	75	16	3	-16
	18	63	123	75	16	3	-18
	20	75	141	91	20	3	-20

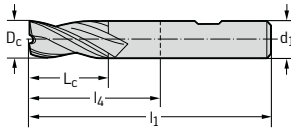

End mill Protostar® 30

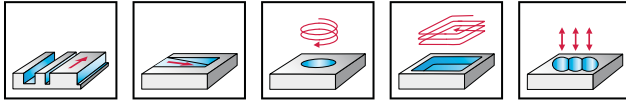

- HSS-E Co8
- long reach
- 2 to 3 cutting edges
- with centre cut
- 30° helix angle

Special features:

 Slot milling: $a_p \leq 1.0 \times D_c$

 Shoulder milling: $a_e \leq 0.6 \times D_c$

	P	M	K	N	S	H	O
uncoated	●			●●			

P standard	D_c e8 mm	L_c mm	l_1 mm	l_4 mm	d_1 h6 mm	Z	uncoated designation P312673
Shank DIN 1835 B 	4	11	63	27	6	2	-4
	5	13	68	32	6	2	-5
	6	13	68	32	6	2	-6
	7	16	80	40	10	2	-7
	8	19	88	48	10	2	-8
	9	19	88	48	10	2	-9
	10	22	95	55	10	2	-10
	11	22	110	65	12	2	-11
	12	26	110	65	12	2	-12
	13	26	110	65	12	2	-13
	14	26	110	65	12	2	-14
	15	26	110	65	12	2	-15
	16	32	123	75	16	2	-16
	17	32	123	75	16	2	-17
	18	32	123	75	16	2	-18
	19	32	123	75	16	2	-19
	20	38	141	91	20	2	-20
	25	45	166	110	25	2	-25
	30	45	166	110	25	2	-30

P-Norm	D_c e8 mm	L_c mm	l_1 mm	l_4 mm	d_1 h6 mm	Z	uncoated designation P312771
Shank DIN 1835 B 	1	2	40	-	6	3	-1
	1,5	2,5	40	-	6	3	-1.5
	2	3	40	-	6	3	-2
	2,5	4	40	-	6	3	-2.5
	3	4,5	40	-	6	3	-3
	3,5	5,5	40	-	6	3	-3.5
	4	6	40	-	6	3	-4
	4,5	7	40	-	6	3	-4.5
	5	7,5	40	-	6	3	-5
	6	9	40	-	6	3	-6

End mill Protostar® AL 25

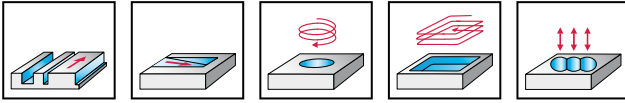

- HSS-E Co8
- 2 cutting edges
- with centre cut
- 25° helix angle

Special features:
 Slot milling: $a_p \leq 0.5 \times D_c$
 Shoulder milling: $a_e \leq 0.3 \times D_c$

	P	M	K	N	S	H	O
uncoated	●			●●			

P standard L	D_c	L_c	l_1	l_4	d_1	Z	uncoated designation P632612
	k10 mm						
Shank DIN 1835 E	16	50	100	52	16	2	-16
	20	50	100	50	20	2	-20
	25	50	120	64	25	2	-25
	32	50	120	64	25	2	-32

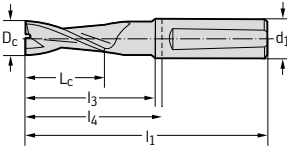

Shell end mills
Protostar® N 30

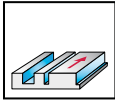
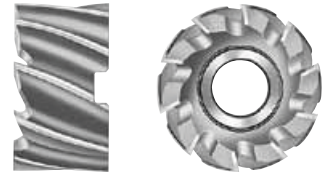

- HSS-E Co8
- 8 to 12 cutting edges
- 30° helix angle

	P	M	K	N	S	H	O
uncoated		●		●●			

DIN 1880

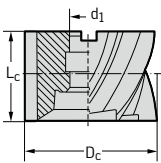

D _c js14 mm	L _c mm	d ₁ H7 mm	Z	uncoated designation P020401
40	32	16	8	-40
50	36	22	8	-50
63	40	27	8	-63
80	45	27	10	-80
100	50	32	12	-100

High-performance cutting tool Protostar® Honeycomb

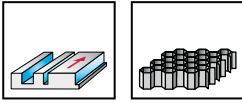

- HSS-E-PM
- multipurpose cutters
- without centre cut

	P	M	K	N	S	H	O
uncoated							●●

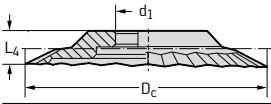
P standard	D _c mm	L _c mm	L ₄	d ₁ H6 mm	Z	uncoated designation P950004
	45	-	9	13	20	-45
	63	-	9	16	22	-63

Cutting knife

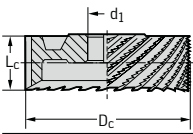
P standard	D _c mm	L _c mm	L ₄	d ₁ H6 mm	Z	uncoated designation P955054
	44	17	-	13	30	-44
	61,5	17	-	16	40	-61.5

Chopper

Adaptors for Protostar® Honeycomb

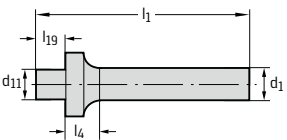

Tool	designation	d ₁ mm	d ₁₁ mm	d ₁₄ mm	l ₄ mm	l ₁₉ mm	
	A159.Z16.013.13	16	13	72	10,5	13,5	0,15
	A159.Z16.016.13	16	16	72	11	13	0,15

Slot drill Protostar® N 50 Tough Guys



Materials to 48 HRC

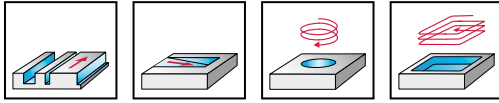

- solid carbide
- 3 to 4 cutting edges
- with centre cut
- 50° helix angle

Special features:

Slot milling: $a_p \leq 0.9 \times D_c$

Shoulder milling: $a_e \leq 0.3 \times D_c$

	P	M	K	N	S	H	O
TAX	●●	●	●	●	●	●	●

DIN 6527 K	D_c e8 mm	R mm	L_c mm	l_1 mm	l_4 mm	d_1 h6 mm	Z	TAX designation H3021217
Shank DIN 6535 HA	2,8	0,08	3	50	14	6	3	-2.8
	3	0,08	3	50	14	6	3	-3
	3,8	0,08	4	54	18	6	3	-3.8
	4	0,08	4	54	18	6	3	-4
	4,8	0,16	5	54	18	6	3	-4.8
	5	0,16	5	54	18	6	3	-5
	5,75	0,16	6	54	18	6	4	-5.75
	6	0,16	6	54	18	6	4	-6
	7,75	0,16	8	58	22	8	4	-7.75
	8	0,16	8	58	22	8	4	-8
	9,7	0,25	10	66	26	10	4	-9.7
	10	0,25	10	66	26	10	4	-10
	12	0,25	12	73	28	12	4	-12
	14	0,25	14	75	30	14	4	-14
	16	0,25	16	82	34	16	4	-16

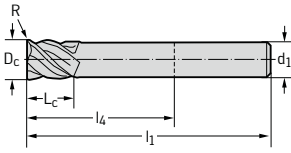

DIN 6527 K	D_c e8 mm	R mm	L_c mm	l_1 mm	l_4 mm	d_1 h6 mm	Z	TAX designation H3121217
Shank DIN 6535 HB	2,8	0,08	3	50	14	6	3	-2.8
	3	0,08	3	50	14	6	3	-3
	3,8	0,08	4	54	18	6	3	-3.8
	4	0,08	4	54	18	6	3	-4
	4,8	0,16	5	54	18	6	3	-4.8
	5	0,16	5	54	18	6	3	-5
	5,75	0,16	6	54	18	6	4	-5.75
	6	0,16	6	54	18	6	4	-6
	7,75	0,16	8	58	22	8	4	-7.75
	8	0,16	8	58	22	8	4	-8
	9,7	0,25	10	66	26	10	4	-9.7
	10	0,25	10	66	26	10	4	-10
	12	0,25	12	73	28	12	4	-12
	14	0,25	14	75	30	14	4	-14
	16	0,25	16	82	34	16	4	-16

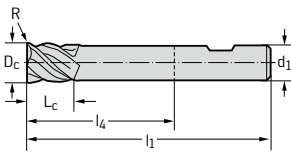

Slot drill Protostar® 30



Materials to 55 HRC

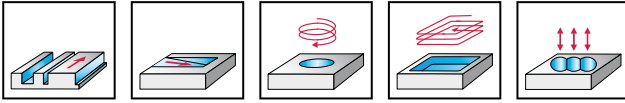

- solid carbide
- 2 cutting edges
- with centre cut
- 30° helix angle

Special features:

Slot milling: $a_p \leq 0.5 \times D_c$

Shoulder milling: $a_e \leq 0.6 \times D_c$

	P	M	K	N	S	H	O
uncoated				●●			
TAX	●●		●				

DIN 6527 K	D_c e8 mm	l_{11} mm	L_c mm	l_1 mm	l_4 mm	d_1 h6 mm	Z	uncoated designation H311501	TAX designation H3115018
Shank DIN 6535 HB	2	0,05-0,10	3	50	14	6	2	-2	-2
	2,5	0,05-0,10	3	50	14	6	2	-2.5	-2.5
	3	0,05-0,10	4	50	14	6	2	-3	-3
	3,5	0,05-0,10	4	50	14	6	2	-3.5	-3.5
	4	0,05-0,10	5	54	18	6	2	-4	-4
	5	0,10-0,15	6	54	18	6	2	-5	-5
	6	0,10-0,15	7	54	18	6	2	-6	-6
	7	0,10-0,15	8	58	22	8	2	-7	-7
	8	0,10-0,15	9	58	22	8	2	-8	-8
	9	0,15-0,25	10	66	26	10	2	-9	-9
	10	0,15-0,25	11	66	26	10	2	-10	-10
	12	0,15-0,25	12	73	28	12	2	-12	-12
	14	0,15-0,25	14	75	30	14	2	-14	-14
	16	0,15-0,25	16	82	34	16	2	-16	-16
	18	0,15-0,25	18	84	36	18	2	-18	-18
	20	0,25-0,35	20	92	42	20	2	-20	-20

Full size

DIN 6527 K	D_c h10 mm	l_{11} mm	L_c mm	l_1 mm	l_4 mm	d_1 h6 mm	Z	TAX designation H3116018
Shank DIN 6535 HB	2,8	0,05-0,10	4	50	14	6	2	-2.8
	3,8	0,05-0,10	5	54	18	6	2	-3.8
	4,8	0,10-0,15	6	54	18	6	2	-4.8
	5,75	0,10-0,15	7	54	18	6	2	-5.75
	6,75	0,10-0,15	8	58	22	8	2	-6.75
	7,75	0,10-0,15	9	58	22	8	2	-7.75
	9,7	0,15-0,25	11	66	26	10	2	-9.7
	11,7	0,15-0,25	12	73	28	12	2	-11.7
	13,7	0,15-0,25	14	75	30	14	2	-13.7
	15,7	0,15-0,25	16	82	34	16	2	-15.7
	17,7	0,15-0,25	18	84	36	18	2	-17.7
	19,7	0,25-0,35	20	92	42	20	2	-19.7

Undersize

Slot drill Protostar® 30



Materials to 55 HRC

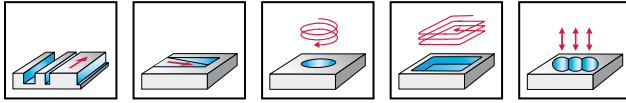

- solid carbide
- 3 cutting edges
- with centre cut
- 30° helix angle

Special features:

Slot milling: $a_p \leq 0.5 \times D_c$

Shoulder milling: $a_e \leq 0.6 \times D_c$

	P	M	K	N	S	H	O
uncoated				●●			
TAX	●●		●				

DIN 6527 K	D_c e8 mm	l_{11} mm	L_c mm	l_1 mm	l_4 mm	d_1 h6 mm	Z	uncoated designation H311801	TAX designation H3118018
Shank DIN 6535 HB	2	0,05-0,10	3	50	14	6	3	-2	-2
	2,5	0,05-0,10	3	50	14	6	3	-2.5	-2.5
	3	0,05-0,10	4	50	14	6	3	-3	-3
	3,5	0,05-0,10	4	50	14	6	3	-3.5	-3.5
	4	0,05-0,10	5	54	18	6	3	-4	-4
	5	0,10-0,15	6	54	18	6	3	-5	-5
	6	0,10-0,15	7	54	18	6	3	-6	-6
	7	0,10-0,15	8	58	22	8	3	-7	-7
	8	0,10-0,15	9	58	22	8	3	-8	-8
	9	0,15-0,25	10	66	26	10	3	-9	-9
	10	0,15-0,25	11	66	26	10	3	-10	-10
	12	0,15-0,25	12	73	28	12	3	-12	-12
	14	0,15-0,25	14	75	30	14	3	-14	-14
	16	0,15-0,25	16	82	34	16	3	-16	-16
	18	0,15-0,25	18	84	36	18	3	-18	-18
	20	0,25-0,35	20	92	42	20	3	-20	-20

Full size

DIN 6527 K	D_c h10 mm	l_{11} mm	L_c mm	l_1 mm	l_4 mm	d_1 h6 mm	Z	TAX designation H3117018
Shank DIN 6535 HB	1,8	0,05-0,10	3	50	14	6	3	-1.8
	2,8	0,05-0,10	4	50	14	6	3	-2.8
	3,8	0,05-0,10	5	54	18	6	3	-3.8
	4,8	0,10-0,15	6	54	18	6	3	-4.8
	5,75	0,10-0,15	7	54	18	6	3	-5.75
	6,75	0,10-0,15	8	58	22	8	3	-6.75
	7,75	0,10-0,15	9	58	22	8	3	-7.75
	9,7	0,15-0,25	11	66	26	10	3	-9.7
	11,7	0,15-0,25	12	73	28	12	3	-11.7
	13,7	0,15-0,25	14	75	30	14	3	-13.7
	15,7	0,15-0,25	16	82	34	16	3	-15.7
	17,7	0,15-0,25	18	84	36	18	3	-17.7
	19,7	0,25-0,35	20	92	42	20	3	-19.7

Undersize

Slot drill Protostar® 30

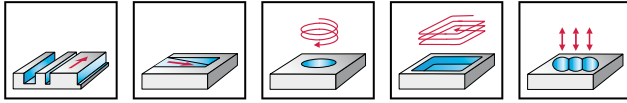

- HSS-E-PM
- 3 cutting edges
- with centre cut
- 30° helix angle

Special features:

Slot milling: $a_p \leq 1.0 \times D_c$

Shoulder milling: $a_e \leq 0.6 \times D_c$

	P	M	K	N	S	H	O
uncoated				●●			
ACN	●●		●				

DIN 327 B	D_c e8 mm	l_{11} mm	L_c mm	l_1 mm	l_4 mm	d_1 h6 mm	Z	uncoated designation P301702
Shank DIN 1835 A	3	0,05-0,10	5	49	13	6	3	-3
	3,5	0,05-0,10	6	50	14	6	3	-3.5
	4	0,05-0,10	7	51	15	6	3	-4
	4,5	0,05-0,10	7	51	15	6	3	-4.5
	5	0,10-0,15	8	52	16	6	3	-5
	5,5	0,10-0,15	8	52	16	6	3	-5.5
	6	0,10-0,15	8	52	16	6	3	-6
	6,5	0,10-0,15	10	60	20	10	3	-6.5
	7	0,10-0,15	10	60	20	10	3	-7
	7,5	0,10-0,15	10	60	20	10	3	-7.5
	8	0,10-0,15	11	61	21	10	3	-8
	8,5	0,10-0,15	11	61	21	10	3	-8.5
	9	0,15-0,25	11	61	21	10	3	-9
	9,5	0,15-0,25	11	61	21	10	3	-9.5
	10	0,15-0,25	13	63	23	10	3	-10
	11	0,15-0,25	13	70	25	12	3	-11
	12	0,15-0,25	16	73	28	12	3	-12
	13	0,15-0,25	16	73	28	12	3	-13
	14	0,15-0,25	16	73	28	12	3	-14
	15	0,15-0,25	16	73	28	12	3	-15
	16	0,15-0,25	19	79	31	16	3	-16
	17	0,15-0,25	19	79	31	16	3	-17
	18	0,15-0,25	19	79	31	16	3	-18
	19	0,15-0,25	19	79	31	16	3	-19
	20	0,25-0,35	22	88	38	20	3	-20

Full size

DIN 327 D	D_c e8 mm	l_{11} mm	L_c mm	l_1 mm	l_4 mm	d_1 h6 mm	Z	uncoated designation P311702	ACN designation P3117027
Shank DIN 1835 B	3	0,05-0,10	5	49	13	6	3	-3	-3
	3,5	0,05-0,10	6	50	14	6	3	-3.5	
	4	0,05-0,10	7	51	15	6	3	-4	-4
	4,5	0,05-0,10	7	51	15	6	3	-4.5	
	5	0,10-0,15	8	52	16	6	3	-5	-5
	5,5	0,10-0,15	8	52	16	6	3	-5.5	
	6	0,10-0,15	8	52	16	6	3	-6	-6
	6,5	0,10-0,15	10	60	20	10	3	-6.5	
	7	0,10-0,15	10	60	20	10	3	-7	
	7,5	0,10-0,15	10	60	20	10	3	-7.5	
	8	0,10-0,15	11	61	21	10	3	-8	-8
	8,5	0,10-0,15	11	61	21	10	3	-8.5	
	9	0,15-0,25	11	61	21	10	3	-9	
	9,5	0,15-0,25	11	61	21	10	3	-9.5	
	10	0,15-0,25	13	63	23	10	3	-10	-10

Continued



Slot drill Protostar® 30



DIN 327 D	D _c e8 mm	l ₁₁ mm	L _c mm	l ₁ mm	l ₄ mm	d ₁ h6 mm	Z	uncoated designation P311702	ACN designation P3117027
Shank DIN 1835 B	11	0,15-0,25	13	70	25	12	3	-11	
	12	0,15-0,25	16	73	28	12	3	-12	-12
	13	0,15-0,25	16	73	28	12	3	-13	
	14	0,15-0,25	16	73	28	12	3	-14	-14
	15	0,15-0,25	16	73	28	12	3	-15	
	16	0,15-0,25	19	79	31	16	3	-16	-16
	17	0,15-0,25	19	79	31	16	3	-17	
	18	0,15-0,25	19	79	31	16	3	-18	-18
	19	0,15-0,25	19	79	31	16	3	-19	
	20	0,25-0,35	22	88	38	20	3	-20	-20
	22	0,25-0,35	22	88	38	20	3	-22	
	25	0,25-0,35	26	102	46	25	3	-25	
	28	0,25-0,35	26	102	46	25	3	-28	
	30	0,25-0,35	26	102	46	25	3	-30	
	32	0,25-0,35	32	112	52	32	3	-32	
	36	0,4-0,5	32	112	52	32	3	-36	
	40	0,4-0,5	38	130	60	40	3	-40	

Full size

DIN 327 D	D _c h10 mm	l ₁₁ mm	L _c mm	l ₁ mm	l ₄ mm	d ₁ h6 mm	Z	uncoated designation P311701	ACN designation P3117017
Shank DIN 1835 B	2,8	0,05-0,10	5	49	13	6	3	-2,8	-2,8
	3,8	0,05-0,10	7	51	15	6	3	-3,8	-3,8
	4,8	0,10-0,15	8	52	16	6	3	-4,8	-4,8
	5,75	0,10-0,15	8	52	16	6	3	-5,75	-5,75
	6,75	0,10-0,15	10	60	20	10	3	-6,75	
	7,75	0,10-0,15	11	61	21	10	3	-7,75	-7,75
	9,7	0,15-0,25	13	63	23	10	3	-9,7	-9,7
	11,7	0,15-0,25	16	73	28	12	3	-11,7	-11,7
	13,7	0,15-0,25	16	73	28	12	3	-13,7	-13,7
	15,7	0,15-0,25	19	79	31	16	3	-15,7	
	16,7	0,15-0,25	19	79	31	16	3	-16,7	
	17,7	0,15-0,25	19	79	31	16	3	-17,7	-17,7
	19,7	0,25-0,35	22	88	38	20	3	-19,7	
	21,7	0,25-0,35	22	88	38	20	3	-21,7	
	24,7	0,25-0,35	26	102	46	25	3	-24,7	
	27,7	0,25-0,35	26	102	46	25	3	-27,7	
	29,7	0,25-0,35	26	102	46	25	3	-29,7	
	31,7	0,25-0,35	32	112	52	32	3	-31,7	

Undersize

Slot drill Protostar® V 30

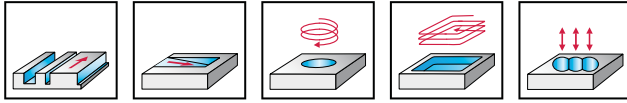

- HSS-E-PM
- 2 cutting edges
- with centre cut
- 30° helix angle

Special features:

Slot milling: $a_p \leq 1.0 \times D_c$

Shoulder milling: $a_e \leq 0.6 \times D_c$

	P	M	K	N	S	H	O
uncoated				●●			
ACN	●●		●				

DIN 327 D

Shank DIN 1835 B

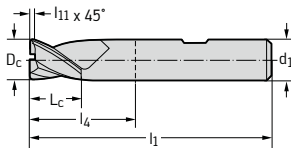

D_c e8 mm	l_{11} mm	L_c mm	l_1 mm	l_4 mm	d_1 h6 mm	Z	uncoated designation P311602	ACN designation P3116027
2	0,05-0,10	4	48	12	6	2	-2	-2
2,5	0,05-0,10	5	49	13	6	2	-2,5	-2,5
3	0,05-0,10	5	49	13	6	2	-3	-3
3,5	0,05-0,10	6	50	14	6	2	-3,5	-3,5
4	0,05-0,10	7	51	15	6	2	-4	-4
4,5	0,05-0,10	7	51	15	6	2	-4,5	-4,5
5	0,10-0,15	8	52	16	6	2	-5	-5
5,5	0,10-0,15	8	52	16	6	2	-5,5	-5,5
6	0,10-0,15	8	52	16	6	2	-6	-6
6,5	0,10-0,15	10	60	20	10	2	-6,5	-6,5
7	0,10-0,15	10	60	20	10	2	-7	-7
7,5	0,10-0,15	10	60	20	10	2	-7,5	-7,5
8	0,10-0,15	11	61	21	10	2	-8	-8
8,5	0,10-0,15	11	61	21	10	2	-8,5	-8,5
9	0,15-0,25	11	61	21	10	2	-9	-9
9,5	0,15-0,25	11	61	21	10	2	-9,5	-9,5
10	0,15-0,25	13	63	23	10	2	-10	-10
11	0,15-0,25	13	70	25	12	2	-11	-11
12	0,15-0,25	16	73	28	12	2	-12	-12
13	0,15-0,25	16	73	28	12	2	-13	-13
14	0,15-0,25	16	73	28	12	2	-14	-14
15	0,15-0,25	16	73	28	12	2	-15	-15
16	0,15-0,25	19	79	31	16	2	-16	-16
17	0,15-0,25	19	79	31	16	2	-17	-17
18	0,15-0,25	19	79	31	16	2	-18	-18
19	0,15-0,25	19	79	31	16	2	-19	-19
20	0,25-0,35	22	88	38	20	2	-20	-20
22	0,25-0,35	22	88	38	20	2	-22	-22
24	0,25-0,35	26	102	46	25	2	-24	-24
25	0,25-0,35	26	102	46	25	2	-25	-25
28	0,25-0,35	26	102	46	25	2	-28	-28
30	0,25-0,35	26	102	46	25	2	-30	-30

Full size

Slot drill Protostar® U 30

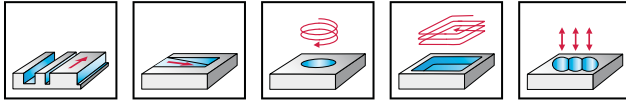

- HSS-E-PM
- 2 cutting edges
- with centre cut
- 30° helix angle

Special features:

 Slot milling: $a_p \leq 1.0 \times D_c$

 Shoulder milling: $a_e \leq 0.6 \times D_c$

	P	M	K	N	S	H	O
uncoated				●●			
ACN	●●		●				

DIN 327 D	D_c h10 mm	l_{11} mm	L_c mm	l_1 mm	l_4 mm	d_1 h6 mm	Z	uncoated designation P311601	ACN designation P3116017
Shank DIN 1835 B	1,8	0,05-0,10	4	48	12	6	2	-1.8	-1.8
	2,8	0,05-0,10	5	49	13	6	2	-2.8	-2.8
	3,8	0,05-0,10	7	51	15	6	2	-3.8	-3.8
	4,8	0,10-0,15	8	52	16	6	2	-4.8	-4.8
	5,75	0,10-0,15	8	52	16	6	2	-5.75	-5.75
	6,75	0,10-0,15	10	60	20	10	2	-6.75	
	7,75	0,10-0,15	11	61	21	10	2	-7.75	-7.75
	8,7	0,15-0,25	11	61	21	10	2	-8.7	
	9,7	0,15-0,25	13	63	23	10	2	-9.7	-9.7
	10,7	0,15-0,25	13	70	25	12	2	-10.7	
	11,7	0,15-0,25	16	73	28	12	2	-11.7	-11.7
	13,7	0,15-0,25	16	73	28	12	2	-13.7	-13.7
	14,7	0,15-0,25	16	73	28	12	2	-14.7	
	15,7	0,15-0,25	19	79	31	16	2	-15.7	-15.7
	16,7	0,15-0,25	19	79	31	16	2	-16.7	
	17,7	0,15-0,25	19	79	31	16	2	-17.7	
	19,7	0,25-0,35	22	88	38	20	2	-19.7	
	21,7	0,25-0,35	22	88	38	20	2	-21.7	
	24,7	0,25-0,35	26	102	46	25	2	-24.7	
	27,7	0,25-0,35	26	102	46	25	2	-27.7	

Undersize

End mill with corner radius Proto-max™_{ST}



Materials to 52 HRC

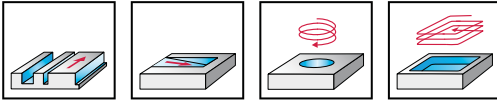

- solid carbide
- long reach
- 4 cutting edges
- with centre cut
- 50° helix angle

Special features:

Slot milling: $a_p \leq 1.5 \times D_c$

Shoulder milling: $a_e \leq 0.5 \times D_c$

	P	M	K	N	S	H	O
TAZ	●●	●					

P standard	D_c	R	L_c	l_3	d_2	l_1	l_4	d_1	Z	TAZ designation H4038217
	h9 mm							mm		
Shank DIN 6535 HA	3	0,2	5	8,5	2,9	57	21	6	4	-3-0.2
	3	0,5	5	8,5	2,9	57	21	6	4	-3-0.5
	4	0,2	7	11	3,8	57	21	6	4	-4-0.2
	4	0,5	7	11	3,8	57	21	6	4	-4-0.5
	5	0,5	8	14	4,75	57	21	6	4	-5-0.5
	5	1	8	14	4,75	57	21	6	4	-5-1
	6	0,5	10	16	5,7	57	21	6	4	-6-0.5
	6	1	10	16	5,7	57	21	6	4	-6-1
	8	0,5	13	22	7,6	63	27	8	4	-8-0.5
	8	1	13	22	7,6	63	27	8	4	-8-1
	8	2	13	22	7,6	63	27	8	4	-8-2
	10	0,5	16	28	9,5	72	32	10	4	-10-0.5
	10	1	16	28	9,5	72	32	10	4	-10-1
	10	2	16	28	9,5	72	32	10	4	-10-2
	12	0,5	19	33	11,4	83	38	12	4	-12-0.5
	12	1	19	33	11,4	83	38	12	4	-12-1
	12	2	19	33	11,4	83	38	12	4	-12-2
	16	0,5	26	42	15,2	92	44	16	4	-16-0.5
	16	1	26	42	15,2	92	44	16	4	-16-1
	16	2	26	42	15,2	92	44	16	4	-16-2
	20	1	32	52	19	104	54	20	4	-20-1
	20	2	32	52	19	104	54	20	4	-20-2
	20	4	32	52	19	104	54	20	4	-20-4

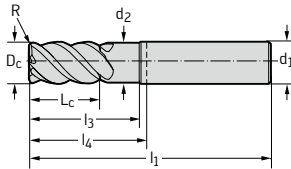

End mill with corner radius Proto-max™_{ST}



Materials to 52 HRC

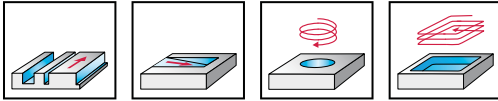

- solid carbide
- long reach
- 3 cutting edges
- with centre cut
- 45° helix angle

Special features:

Slot milling: $a_p \leq 2,0 \times D_c$

Shoulder milling: $a_e \leq 0,3 \times D_c$

	P	M	K	N	S	H	O
TAZ	●●	●	●	●	●	●	●

P standard	D_c h9 mm	R mm	L_c mm	l_3 mm	d_2 mm	l_1 mm	l_4 mm	d_1 h6 mm	Z	TAZ designation H4036217
Shank DIN 6535 HA	2	0,08	5	7,5	1,92	57	21	6	3	-2
	3	0,08	7	10,5	2,9	57	21	6	3	-3
	4	0,08	9	15	3,8	57	21	6	3	-4
	5	0,16	11	16	4,75	57	21	6	3	-5
	6	0,16	13	19	5,7	57	21	6	3	-6
	8	0,16	18	25	7,6	63	27	8	3	-8
	10	0,25	22	30	9,5	72	32	10	3	-10
	12	0,25	26	36	11,4	83	38	12	3	-12
	16	0,25	34	42	15,2	92	44	16	3	-16
	20	0,4	42	52	19	104	54	20	3	-20

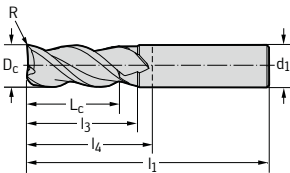

End mill with corner radius Protostar® Flash



Materials to 55 HRC

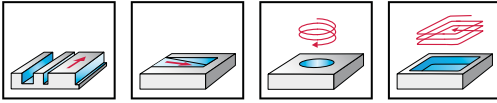

- solid carbide
- 3 to 4 cutting edges
- without centre cut
- 50° helix angle

Special features:

Shoulder milling: $a_e \leq 0.5 \times D_c$

	P	M	K	N	S	H	O
TAX	●●	●	●	●	●	●	●

P standard	D _c h9 mm	a _{pf}	x _f mm	R _f	R _{ers}	R mm	L _c mm	d ₂ mm	l ₁ mm	l ₄ mm	SW mm	d ₁	Z	TAX
														designation H3E93718
ConeFit™	10	0,3	1,7	5	1,99	1,5	5,5	9,7	23,6	12,4	8	E 10	3	-E10-10
	12	0,8	2,25	6	2,1	1,5	6,5	11,7	28,3	14,5	10	E 12	3	-E12-12
	16	1	3,1	8	2,747	2	8,5	15,5	35,7	18,7	12	E 16	3	-E16-16
	20	1,3	4	10	3,072	2	11	19,3	40,8	21,3	16	E 20	3	-E20-20

P standard	D _c h9 mm	a _{pf}	x _f mm	R _f	R _{ers}	R mm	L _c mm	d ₂ mm	l ₁ mm	l ₄ mm	SW mm	d ₁	Z	TAX
														designation H3E94718
ConeFit™	10	0,3	1,7	5	1,99	1,5	5,5	9,7	23,6	12,4	8	E 10	4	-E10-10
	12	0,8	2,25	6	2,1	1,5	6,5	11,7	28,3	14,5	10	E 12	4	-E12-12
	16	1	3,1	8	2,747	2	8,5	15,5	35,7	18,7	12	E 16	4	-E16-16
	20	1,3	4	10	3,072	2	11	19,3	40,8	21,3	16	E 20	4	-E20-20
	25	1,6	5	12	4,206	3	13,5	24,2	49,6	25,6	20	E 25	4	-E25-25

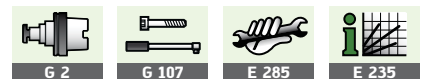

End mill with corner radius

Protostar®

Flash



Materials to 55 HRC

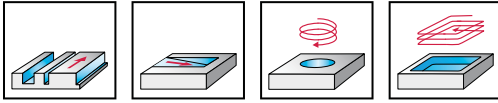

- solid carbide
- 3 to 4 cutting edges
- without centre cut
- 50° helix angle

Special features:

Shoulder milling: $a_e \leq 0.5 \times D_c$

	P	M	K	N	S	H	O
TAX	●●	●	●				

DIN; P standard L

Shank DIN 6535 HA

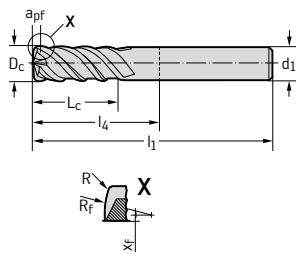

D _c h9 mm	a _{pf}	x _f mm	R _f	R _{ers}	R mm	L _c mm	l ₁ mm	l ₄ mm	d ₁ mm	Z	TAX designation H3094718
4	0,2	0,8	2	0,673	0,5	11	57	21	6	4	-4
5	0,25	1,1	2,5	0,714	0,5	13	57	21	6	4	-5
6	0,3	1,4	3	0,755	0,5	15	57	21	6	4	-6
6	0,2	1,4	3	0,755	0,5	15	100	64	6	4	-6-100
8	0,5	1,54	4	1,38	1	20	63	27	8	4	-8
8	0,25	1,54	4	1,38	1	20	120	84	8	4	-8-120
10	0,7	1,7	5	1,99	1,5	26	72	32	10	4	-10
10	0,3	1,7	5	1,99	1,5	26	150	110	10	4	-10-150
12	0,8	2,25	6	2,1	1,5	30	83	38	12	4	-12
16	1	3,1	8	2,747	2	36	92	44	16	4	-16
20	1,3	4	10	3,072	2	49	104	54	20	4	-20

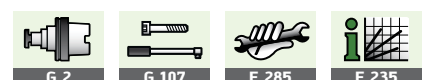

End mill with corner radius

Protostar®

Flash



Materials from 55 to 65 HRC

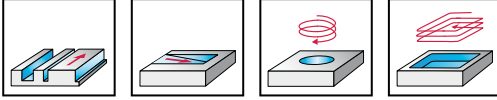

- solid carbide
- long reach
- 4 cutting edges
- without centre cut
- 50° helix angle

Special features:

Shoulder milling: $a_e \leq 0.5 \times D_c$

	P	M	K	N	S	H	O
TAX						●●	

DIN 6527 L	D _c h9 mm	a _{pf}	x _f mm	R _f	R _{ers}	R mm	L _c mm	l ₁ mm	l ₄ mm	d ₁ h5 mm	Z	TAX
												designation H3094728
Shank DIN 6535 HA	4	0,12	0,6	4	0,618	0,5	11	57	21	6	4	-4
	5	0,15	0,7	6	0,656	0,5	13	57	21	6	4	-5
	6	0,2	0,7	9	0,693	0,5	15	57	21	6	4	-6
	8	0,25	0,78	12	1,226	1	20	63	27	8	4	-8
	10	0,3	0,8	15	1,773	1,5	26	72	32	10	4	-10
	12	0,4	1	18	1,875	1,5	30	83	38	12	4	-12
	16	0,5	1,5	24	2,465	2	36	92	44	16	4	-16
	20	0,65	2,2	30	2,607	2	45	104	54	20	4	-20

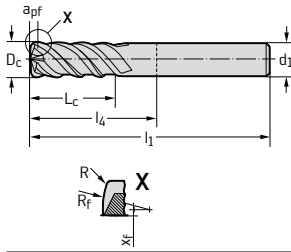

End mill with corner radius

Protostar® N 50

Tough Guys



Materials to 48 HRC

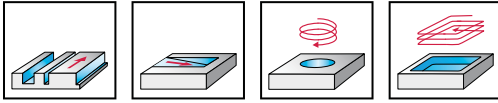

- solid carbide
- 3 to 4 cutting edges
- with centre cut
- 50° helix angle

Special features:

Slot milling: $a_p \leq 0.9 \times D_c$

Shoulder milling: $a_e \leq 0.3 \times D_c$

	P	M	K	N	S	H	O
TAX	●●	●	●				

P standard L	D_c h9 mm	R mm	L_c mm	l_1 mm	l_4 mm	d_1 h6 mm	Z	TAX designation H3020117
Shank DIN 6535 HA	4	1	11	57	21	6	3	-4
	5	1	13	57	21	6	3	-5
	6	1	13	65	29	6	4	-6
	8	2	19	80	44	8	4	-8
	10	2	22	100	60	10	4	-10
	12	3	26	100	55	12	4	-12
	14	3	26	104	59	14	4	-14
	16	3	32	115	67	16	4	-16-3
	16	4	32	115	67	16	4	-16
	20	3	38	125	75	20	4	-20-3
	20	4	38	125	75	20	4	-20

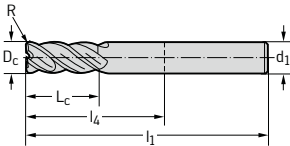

End mill with corner radius

Protostar® N 50

Tough Guys



Materials to 48 HRC

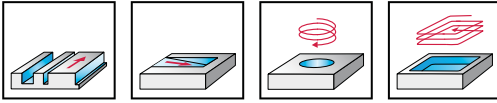

- solid carbide
- 4 to 5 cutting edges
- with centre cut
- 50° helix angle

Special features:

Slot milling: $a_p \leq 0.5 \times D_c$

Shoulder milling: $a_e \leq 0.5 \times D_c$

	P	M	K	N	S	H	O
TAX	●●						

P standard	D_c h9 mm	R mm	L_c mm	d_2 mm	l_1 mm	l_4 mm	SW mm	d_1	Z	TAX designation H3E20317
	10	0,5	5,5	9,7	23,6	12,4	8	E 10	4	-E10-10-0.5
	10	1	5,5	9,7	23,6	12,4	8	E 10	4	-E10-10-1
	10	1,5	5,5	9,7	23,6	12,4	8	E 10	4	-E10-10-1.5
	10	2	5,5	9,7	23,6	12,4	8	E 10	4	-E10-10-2
	10	3	5,5	9,7	23,6	12,4	8	E 10	4	-E10-10-3
	12	0,5	6,5	11,7	28,3	14,5	10	E 12	4	-E12-12-0.5
	12	1	6,5	11,7	28,3	14,5	10	E 12	4	-E12-12-1
	12	1,5	6,5	11,7	28,3	14,5	10	E 12	4	-E12-12-1.5
	12	2	6,5	11,7	28,3	14,5	10	E 12	4	-E12-12-2
	12	3	6,5	11,7	28,3	14,5	10	E 12	4	-E12-12-3
	12	4	6,5	11,7	28,3	14,5	10	E 12	4	-E12-12-4
	16	0,5	8,5	15,5	35,7	18,7	12	E 16	4	-E16-16-0.5
	16	1	8,5	15,5	35,7	18,7	12	E 16	4	-E16-16-1
	16	1,5	8,5	15,5	35,7	18,7	12	E 16	4	-E16-16-1.5
	16	2	8,5	15,5	35,7	18,7	12	E 16	4	-E16-16-2
	16	3	8,5	15,5	35,7	18,7	12	E 16	4	-E16-16-3
	16	4	8,5	15,5	35,7	18,7	12	E 16	4	-E16-16-4
	20	0,5	11	19,3	40,8	21,3	16	E 20	4	-E20-20-0.5
	20	1	11	19,3	40,8	21,3	16	E 20	4	-E20-20-1
	20	1,5	11	19,3	40,8	21,3	16	E 20	4	-E20-20-1.5
	20	2	11	19,3	40,8	21,3	16	E 20	4	-E20-20-2
	20	3	11	19,3	40,8	21,3	16	E 20	4	-E20-20-3
	20	4	11	19,3	40,8	21,3	16	E 20	4	-E20-20-4
	25	1	13,5	24,2	49,6	25,6	20	E 25	5	-E25-25-1
	25	1,5	13,5	24,2	49,6	25,6	20	E 25	5	-E25-25-1.5
25	2	13,5	24,2	49,6	25,6	20	E 25	5	-E25-25-2	
25	3	13,5	24,2	49,6	25,6	20	E 25	5	-E25-25-3	
25	4	13,5	24,2	49,6	25,6	20	E 25	5	-E25-25-4	



End mill with corner radius

Protostar® N 50

Tough Guys



Materials to 48 HRC

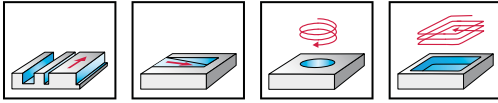

- solid carbide
- 4 cutting edges
- with centre cut
- 50° helix angle

Special features:

Slot milling: $a_p \leq 0.9 \times D_c$

Shoulder milling: $a_e \leq 0.3 \times D_c$

	P	M	K	N	S	H	O
TAX	●●	●	●				

DIN 6527 L	D_c h9 mm	R mm	L_c mm	l_1 mm	l_4 mm	d_1 h6 mm	Z	TAX designation H3020317
Shank DIN 6535 HA	6	1	13	57	21	6	4	-6
	8	2	19	63	27	8	4	-8
	10	2	22	72	32	10	4	-10
	12	3	26	83	38	12	4	-12
	14	3	26	83	38	14	4	-14
	16	3	32	92	44	16	4	-16-3
	16	4	32	92	44	16	4	-16
	20	3	38	104	54	20	4	-20-3
	20	4	38	104	54	20	4	-20

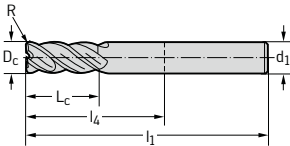

DIN 6527 L	D_c h9 mm	R mm	L_c mm	l_1 mm	l_4 mm	d_1 h6 mm	Z	TAX designation H3120317
Shank DIN 6535 HB	6	1	13	57	21	6	4	-6
	8	2	19	63	27	8	4	-8
	10	2	22	72	32	10	4	-10
	12	3	26	83	38	12	4	-12
	14	3	26	83	38	14	4	-14
	16	3	32	92	44	16	4	-16-3
	16	4	32	92	44	16	4	-16
	20	3	38	104	54	20	4	-20-3
	20	4	38	104	54	20	4	-20

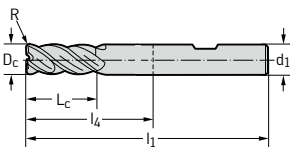

End mill with corner radius

Protostar® N 50

Tough Guys



Materials to 48 HRC

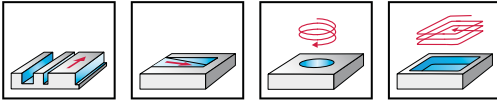

- solid carbide
- long reach
- 3 to 4 cutting edges
- with centre cut
- 50° helix angle

Special features:

Slot milling: $a_p \leq 0.9 \times D_c$

Shoulder milling: $a_e \leq 0.3 \times D_c$

	P	M	K	N	S	H	O
TAX	●	●	●				

DIN 6527 L	D_c h9 mm	R mm	L_c mm	l_3 mm	d_2 mm	l_1 mm	l_4 mm	d_1 h6 mm	Z	TAX designation H4020017
Shank DIN 6535 HA	2	0,2	7	9,5	1,92	57	21	6	3	-2-0.2
	3	0,3	8	10	2,9	57	21	6	3	-3-0.3
	4	0,5	11	15	3,8	57	21	6	3	-4-0.5
	5	0,5	13	16	4,75	57	21	6	3	-5-0.5
	6	0,5	13	19	5,7	57	21	6	4	-6-0.5
	6	1	13	19	5,7	57	21	6	4	-6-1
	8	0,5	19	25	7,6	63	27	8	4	-8-0.5
	8	1	19	25	7,6	63	27	8	4	-8-1
	8	1,5	19	25	7,6	63	27	8	4	-8-1.5
	8	2	19	25	7,6	63	27	8	4	-8-2
	10	0,5	22	30	9,5	72	32	10	4	-10-0.5
	10	1	22	30	9,5	72	32	10	4	-10-1
	10	1,5	22	30	9,5	72	32	10	4	-10-1.5
	10	2	22	30	9,5	72	32	10	4	-10-2
	12	0,5	26	36	11,4	83	38	12	4	-12-0.5
	12	1	26	36	11,4	83	38	12	4	-12-1
	12	1,5	26	36	11,4	83	38	12	4	-12-1.5
	12	2	26	36	11,4	83	38	12	4	-12-2
	12	2,5	26	36	11,4	83	38	12	4	-12-2.5
	12	3	26	36	11,4	83	38	12	4	-12-3
14	1	26	36	13,3	83	38	14	4	-14-1	
14	1,5	26	36	13,3	83	38	14	4	-14-1.5	
14	2	26	36	13,3	83	38	14	4	-14-2	
14	3	26	36	13,3	83	38	14	4	-14-3	
16	0,5	32	42	15,2	92	44	16	4	-16-0.5	
16	1	32	42	15,2	92	44	16	4	-16-1	
16	2	32	42	15,2	92	44	16	4	-16-2	
16	2,5	32	42	15,2	92	44	16	4	-16-2.5	
16	3	32	42	15,2	92	44	16	4	-16-3	
16	4	32	42	15,2	92	44	16	4	-16-4	
20	0,5	38	52	19	104	54	20	4	-20-0.5	
20	1	38	52	19	104	54	20	4	-20-1	
20	2	38	52	19	104	54	20	4	-20-2	
20	2,5	38	52	19	104	54	20	4	-20-2.5	
20	3	38	52	19	104	54	20	4	-20-3	
20	4	38	52	19	104	54	20	4	-20-4	

Shank DIN 6535 HA

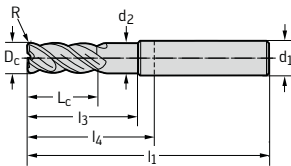

End mill with corner radius

Protostar® N 50

Tough Guys



Materials to 48 HRC

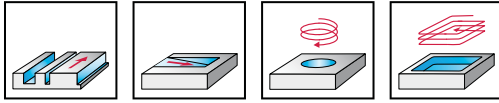

- solid carbide
- long reach
- 3 to 4 cutting edges
- with centre cut
- 50° helix angle

Special features:

Slot milling: $a_p \leq 0.9 \times D_c$

Shoulder milling: $a_e \leq 0.3 \times D_c$

	P	M	K	N	S	H	O
TAX	●●	●	●				

DIN 6527 L	D_c h9 mm	R mm	L_c mm	l_3 mm	d_2 mm	l_1 mm	l_4 mm	d_1 h6 mm	Z	TAX designation H4120017
Shank DIN 6535 HB	2	0,2	7	9,5	1,92	57	21	6	3	-2-0.2
	3	0,3	8	10	2,9	57	21	6	3	-3-0.3
	4	0,5	11	15	3,8	57	21	6	3	-4-0.5
	5	0,5	13	16	4,75	57	21	6	3	-5-0.5
	6	0,5	13	19	5,7	57	21	6	4	-6-0.5
	6	1	13	19	5,7	57	21	6	4	-6-1
	8	0,5	19	25	7,6	63	27	8	4	-8-0.5
	8	1	19	25	7,6	63	27	8	4	-8-1
	8	1,5	19	25	7,6	63	27	8	4	-8-1.5
	8	2	19	25	7,6	63	27	8	4	-8-2
	10	0,5	22	30	9,5	72	32	10	4	-10-0.5
	10	1	22	30	9,5	72	32	10	4	-10-1
	10	1,5	22	30	9,5	72	32	10	4	-10-1.5
	10	2	22	30	9,5	72	32	10	4	-10-2
	12	0,5	26	36	11,4	83	38	12	4	-12-0.5
	12	1	26	36	11,4	83	38	12	4	-12-1
	12	1,5	26	36	11,4	83	38	12	4	-12-1.5
	12	2	26	36	11,4	83	38	12	4	-12-2
	12	2,5	26	36	11,4	83	38	12	4	-12-2.5
	12	3	26	36	11,4	83	38	12	4	-12-3
	14	1	26	36	13,3	83	38	14	4	-14-1
	14	1,5	26	36	13,3	83	38	14	4	-14-1.5
	14	2	26	36	13,3	83	38	14	4	-14-2
	14	3	26	36	13,3	83	38	14	4	-14-3
	16	0,5	32	42	15,2	92	44	16	4	-16-0.5
	16	1	32	42	15,2	92	44	16	4	-16-1
	16	2	32	42	15,2	92	44	16	4	-16-2
	16	2,5	32	42	15,2	92	44	16	4	-16-2.5
	16	3	32	42	15,2	92	44	16	4	-16-3
	16	4	32	42	15,2	92	44	16	4	-16-4
	20	0,5	38	52	19	104	54	20	4	-20-0.5
	20	1	38	52	19	104	54	20	4	-20-1
	20	2	38	52	19	104	54	20	4	-20-2
	20	2,5	38	52	19	104	54	20	4	-20-2.5
	20	3	38	52	19	104	54	20	4	-20-3
	20	4	38	52	19	104	54	20	4	-20-4

Shank DIN 6535 HB

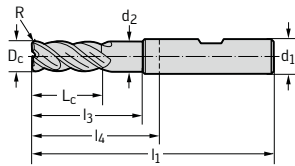

End mill with corner radius

Protostar® N 50

Tough Guys



Materials to 48 HRC

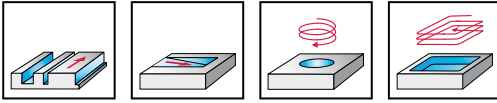

- solid carbide
- long reach
- 4 cutting edges
- with centre cut
- 50° helix angle

Special features:

Slot milling: $a_p \leq 0.9 \times D_c$

Shoulder milling: $a_e \leq 0.3 \times D_c$

	P	M	K	N	S	H	O
TAX	●●	●	●	●	●	●	●

P standard L	D_c h9 mm	R mm	L_c mm	l_3 mm	d_2 mm	l_1 mm	l_4 mm	d_1 h6 mm	Z	TAX designation H4020117
Shank DIN 6535 HA	4	0,5	11	15	3,8	57	21	6	3	-4-0.5
	4	1	11	15	3,8	57	21	6	3	-4
	5	0,5	13	16	4,75	57	21	6	3	-5-0.5
	5	1	13	16	4,75	57	21	6	3	-5
	6	0,5	13	27	5,7	65	29	6	4	-6-0.5
	6	1	13	27	5,7	65	29	6	4	-6
	8	0,5	19	42	7,6	80	44	8	4	-8-0.5
	8	1	19	42	7,6	80	44	8	4	-8-1
	8	2	19	42	7,6	80	44	8	4	-8
	10	0,5	22	58	9,5	100	60	10	4	-10-0.5
	10	1	22	58	9,5	100	60	10	4	-10-1
	10	2	22	58	9,5	100	60	10	4	-10
	12	0,5	26	53	11,4	100	55	12	4	-12-0.5
	12	1	26	53	11,4	100	55	12	4	-12-1
	12	3	26	53	11,4	100	55	12	4	-12
	14	0,5	26	57	13,3	104	59	14	4	-14-0.5
	14	1	26	57	13,3	104	59	14	4	-14-1
	14	3	26	57	13,3	104	59	14	4	-14
	16	0,5	32	65	15,2	115	67	16	4	-16-0.5
	16	1	32	65	15,2	115	67	16	4	-16-1
16	2	32	65	15,2	115	67	16	4	-16-2	
16	3	32	65	15,2	115	67	16	4	-16-3	
16	4	32	65	15,2	115	67	16	4	-16	
20	1	38	73	19	125	75	20	4	-20-1	
20	2	38	73	19	125	75	20	4	-20-2	
20	3	38	73	19	125	75	20	4	-20-3	
20	4	38	73	19	125	75	20	4	-20	

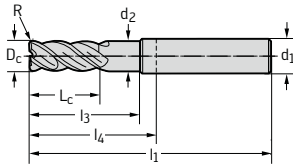

End mill with corner radius

Protostar® N 50

Tough Guys



Materials to 48 HRC

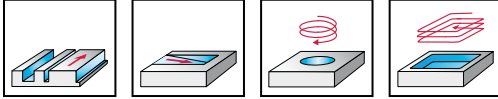

- solid carbide
- long reach
- 4 cutting edges
- with centre cut
- 50° helix angle

Special features:

Slot milling: $a_p \leq 0.9 \times D_c$

Shoulder milling: $a_e \leq 0.3 \times D_c$

P standard L	D_c h9 mm	R mm	L_c mm	l_3 mm	d_2 mm	l_1 mm	l_4 mm	d_1 h6 mm	Z	TAX designation H4120117
Shank DIN 6535 HB 	4	0,5	11	15	3,8	57	21	6	3	-4-0.5
	4	1	11	15	3,8	57	21	6	3	-4-1
	5	0,5	13	16	4,75	57	21	6	3	-5-0.5
	5	1	13	16	4,75	57	21	6	3	-5-1
	6	0,5	13	27	5,7	65	29	6	4	-6-0.5
	6	1	13	27	5,7	65	29	6	4	-6-1
	8	0,5	19	42	7,6	80	44	8	4	-8-0.5
	8	1	19	42	7,6	80	44	8	4	-8-1
	8	2	19	42	7,6	80	44	8	4	-8-2
	10	0,5	22	58	9,5	100	60	10	4	-10-0.5
	10	1	22	58	9,5	100	60	10	4	-10-1
	10	2	22	58	9,5	100	60	10	4	-10-2
	12	0,5	26	53	11,4	100	55	12	4	-12-0.5
	12	1	26	53	11,4	100	55	12	4	-12-1
	12	3	26	53	11,4	100	55	12	4	-12-3
	14	0,5	26	57	13,3	104	59	14	4	-14-0.5
	14	1	26	57	13,3	104	59	14	4	-14-1
	14	3	26	57	13,3	104	59	14	4	-14-3
	16	0,5	32	65	15,2	115	67	16	4	-16-0.5
	16	1	32	65	15,2	115	67	16	4	-16-1
16	2	32	65	15,2	115	67	16	4	-16-2	
16	3	32	65	15,2	115	67	16	4	-16-3	
16	4	32	65	15,2	115	67	16	4	-16-4	
20	1	38	73	19	125	75	20	4	-20-1	
20	2	38	73	19	125	75	20	4	-20-2	
20	3	38	73	19	125	75	20	4	-20-3	
20	4	38	73	19	125	75	20	4	-20-4	

End mill with corner radius

Protostar® H 50

Tough Guys



Materials from 48 to 63 HRC

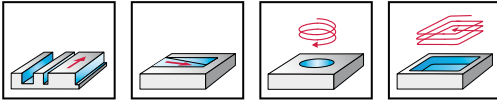

- solid carbide
- 3 to 4 cutting edges
- with centre cut
- 50° helix angle

Special features:

Slot milling: $a_p \leq 0.9 \times D_c$

Shoulder milling: $a_e \leq 0.3 \times D_c$

	P	M	K	N	S	H	O
TAX	●					●●	

P standard L	D_c	R	L_c	l_1	l_4	d_1	Z	TAX designation H3070118
	h9					h6		
mm	mm	mm	mm	mm	mm	mm		
Shank DIN 6535 HA								
	2	0,5	7	57	21	6	3	-2
	3	0,5	8	57	21	6	3	-3
	4	0,5	11	57	21	6	3	-4-0.5
	4	1	11	57	21	6	3	-4
	5	0,5	13	57	21	6	3	-5-0.5
	5	1	13	57	21	6	3	-5
	6	0,5	13	65	29	6	4	-6-0.5
	6	1	13	65	29	6	4	-6
	8	0,5	19	80	44	8	4	-8-0.5
	8	1	19	80	44	8	4	-8-1
	8	2	19	80	44	8	4	-8
	10	0,5	22	100	60	10	4	-10-0.5
	10	1	22	100	60	10	4	-10-1
	10	2	22	100	60	10	4	-10
	12	0,5	26	100	55	12	4	-12-0.5
	12	1	26	100	55	12	4	-12-1
	12	2	26	100	55	12	4	-12-2
	12	3	26	100	55	12	4	-12
	14	0,5	26	104	59	14	4	-14-0.5
	14	1	26	104	59	14	4	-14-1
	14	2	26	104	59	14	4	-14-2
	14	3	26	104	59	14	4	-14
	16	0,5	32	115	67	16	4	-16-0.5
	16	1	32	115	67	16	4	-16-1
	16	2	32	115	67	16	4	-16-2
	16	4	32	115	67	16	4	-16
	20	0,5	38	125	75	20	4	-20-0.5
	20	1	38	125	75	20	4	-20-1
	20	2	38	125	75	20	4	-20-2
	20	4	38	125	75	20	4	-20

DIN 6527 L	D_c	R	L_c	l_1	l_4	d_1	Z	TAX designation H3070318
	h9					h6		
mm	mm	mm	mm	mm	mm	mm		
Shank DIN 6535 HA								
	6	0,5	13	57	21	6	4	-6-0.5
	6	1	13	57	21	6	4	-6-1
	8	0,5	19	63	27	8	4	-8-0.5
	8	1	19	63	27	8	4	-8-1
	8	2	19	63	27	8	4	-8-2
	10	0,5	22	72	32	10	4	-10-0.5
	10	1	22	72	32	10	4	-10-1
	10	2	22	72	32	10	4	-10-2
	12	0,5	26	83	38	12	4	-12-0.5
	12	1	26	83	38	12	4	-12-1

Continued



End mill with corner radius

Protostar® H 50

Tough Guys



Materials from 48 to 63 HRC

Continued

DIN 6527 L	D _c h9 mm	R mm	L _c mm	l ₁ mm	l ₄ mm	d ₁ h6 mm	Z	TAX designation H3070318
Shank DIN 6535 HA	12	2	26	83	38	12	4	-12-2
	12	3	26	83	38	12	4	-12-3
	14	0,5	26	83	38	14	4	-14-0,5
	14	1	26	83	38	14	4	-14-1
	14	2	26	83	38	14	4	-14-2
	14	3	26	83	38	14	4	-14-3
	16	0,5	32	92	44	16	4	-16-0,5
	16	1	32	92	44	16	4	-16-1
	16	2	32	92	44	16	4	-16-2
	16	4	32	92	44	16	4	-16-4
	20	0,5	38	104	54	20	4	-20-0,5
	20	1	38	104	54	20	4	-20-1
	20	2	38	104	54	20	4	-20-2
	20	4	38	104	54	20	4	-20-4

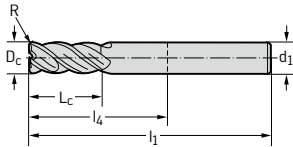

DIN 6527 L	D _c h9 mm	R mm	L _c mm	l ₁ mm	l ₄ mm	d ₁ h6 mm	Z	TAX designation H3170318
Shank DIN 6535 HB	6	0,5	13	57	21	6	4	-6-0,5
	6	1	13	57	21	6	4	-6
	8	0,5	19	63	27	8	4	-8-0,5
	8	1	19	63	27	8	4	-8-1
	8	2	19	63	27	8	4	-8
	10	0,5	22	72	32	10	4	-10-0,5
	10	1	22	72	32	10	4	-10-1
	10	2	22	72	32	10	4	-10
	12	0,5	26	83	38	12	4	-12-0,5
	12	1	26	83	38	12	4	-12-1
	12	2	26	83	38	12	4	-12-2
	12	3	26	83	38	12	4	-12
	14	0,5	26	83	38	14	4	-14-0,5
	14	1	26	83	38	14	4	-14-1
	14	2	26	83	38	14	4	-14-2
	14	3	26	83	38	14	4	-14
	16	0,5	32	92	44	16	4	-16-0,5
	16	1	32	92	44	16	4	-16-1
	16	2	32	92	44	16	4	-16-2
	16	4	32	92	44	16	4	-16
	20	0,5	38	104	54	20	4	-20-0,5
	20	1	38	104	54	20	4	-20-1
	20	2	38	104	54	20	4	-20-2
	20	4	38	104	54	20	4	-20

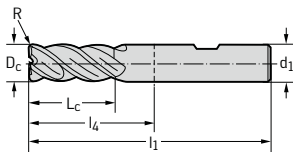

End mill with corner radius Protostar® 45



Materials to 48 HRC

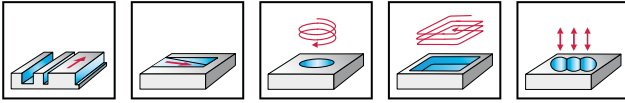

- solid carbide
- long reach
- 3 cutting edges
- with centre cut
- 45° helix angle

Special features:

Slot milling: $a_p \leq 0.5 \times D_c$

Shoulder milling: $a_e \leq 0.6 \times D_c$

	P	M	K	N	S	H	O
TAX	●●	●	●	●	●	●	●

DIN 6527 L	D_c h9 mm	R mm	L_c mm	l_3 mm	d_2 mm	l_1 mm	l_4 mm	d_1 h6 mm	Z	TAX designation H4129318
Shank DIN 6535 HB	2	0,5	6	9,5	1,92	57	21	6	3	-2
	3	0,5	7	10	2,9	57	21	6	3	-3
	4	0,5	8	15	3,8	57	21	6	3	-4
	5	0,5	10	16	4,75	57	21	6	3	-5
	6	1	10	19	5,7	57	21	6	3	-6
	8	1	16	25	7,6	63	27	8	3	-8
	9	1	16	31	8,55	72	32	10	3	-9
	10	1,5	19	30	9,5	72	32	10	3	-10
	12	1,5	22	36	11,4	83	38	12	3	-12
	14	1,5	22	36	13,3	83	38	14	3	-14
	16	2	26	42	15,2	92	44	16	3	-16
	18	2	26	42	17,1	92	44	18	3	-18
	20	2	32	52	19	104	54	20	3	-20

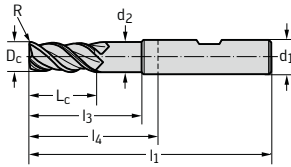

End mill with corner radius

Protostar® AL 45

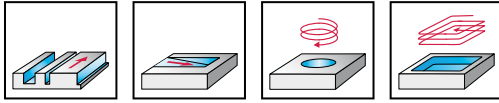

- solid carbide
- 3 cutting edges
- with centre cut
- 45° helix angle

Special features:

 Slot milling: $a_p \leq 0.5 \times D_c$

 Shoulder milling: $a_e \leq 0.3 \times D_c$

	P	M	K	N	S	H	O
uncoated				●●			
CRN				●●			

P standard

ConeFit™

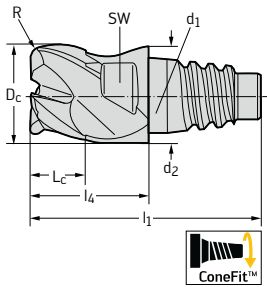

D _c h9 mm	R mm	L _c mm	l ₃ mm	d ₂ mm	l ₁ mm	l ₄ mm	SW mm	d ₁	Z	uncoated designation H6E2311
10	1	5,5	-	9,7	23,6	12,4	8	E 10	3	-E10-10-1
10	2,5	5,5	-	9,7	23,6	12,4	8	E 10	3	-E10-10-2,5
12	1	6,5	-	11,7	28,3	14,5	10	E 12	3	-E12-12-1
12	2,5	6,5	-	11,7	28,3	14,5	10	E 12	3	-E12-12-2,5
12	4	6,5	-	11,7	28,3	14,5	10	E 12	3	-E12-12-4
16	2,5	8,5	-	15,5	35,7	18,7	12	E 16	3	-E16-16-2,5
16	4	8,5	-	15,5	35,7	18,7	12	E 16	3	-E16-16-4
20	2,5	11	-	19,3	40,8	21,3	16	E 20	3	-E20-20-2,5
20	4	11	-	19,3	40,8	21,3	16	E 20	3	-E20-20-4
25	4	13,5	-	24,2	49,6	25,6	20	E 25	3	-E25-25-4

DIN 6527 L

Shank DIN 6535 HA

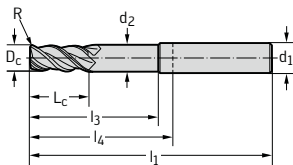

D _c h9 mm	R mm	L _c mm	l ₃ mm	d ₂ mm	l ₁ mm	l ₄ mm	SW mm	d ₁ h6 mm	Z	uncoated designation H602311	CRN designation H6023114
1	0,2	3	6,5	0,96	57	21	-	6	3	-1	-1
2	0,2	6	9,5	1,92	57	21	-	6	3	-2	-2
3	0,3	7	10	2,9	57	21	-	6	3	-3	-3
4	0,5	8	15	3,8	57	21	-	6	3	-4	-4
5	0,5	10	16	4,75	57	21	-	6	3	-5	-5
6	0,5	10	19	5,7	57	21	-	6	3	-6	-6
8	0,5	16	25	7,6	63	27	-	8	3	-8	-8
10	0,5	19	30	9,5	72	32	-	10	3	-10	-10
12	0,5	22	36	11,4	83	38	-	12	3	-12	-12
14	0,5	22	36	13,3	83	38	-	14	3	-14	-14
16	0,5	26	42	15,2	92	44	-	16	3	-16	-16
18	0,5	26	42	17,1	92	44	-	18	3	-18	-18
20	0,5	32	52	19	104	54	-	20	3	-20	-20
25	0,5	45	63	23,75	121	65	-	25	3	-25	-25

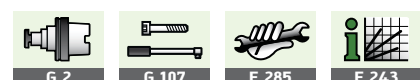

End mill with corner radius Protostar® Ti 40

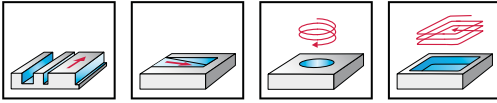

- solid carbide
- long reach
- 4 cutting edges
- without centre cut
- 40° helix angle

Special features:

Slot milling: $a_p \leq 1.5 \times D_c$

Shoulder milling: $a_e \leq 0.6 \times D_c$

	P	M	K	N	S	H	O
ACN	●	●	●	●	●●		

DIN 6527 L	D_c h9 mm	R mm	L_c mm	l_3 mm	d_2 mm	l_1 mm	l_4 mm	d_1 h6 mm	Z	ACN designation H7073717
Shank DIN 6535 HA	12	0,2	19	36	11,4	83	38	12	4	-12-0.2
	12	2	19	36	11,4	83	38	12	4	-12-2
	12	2,5	19	36	11,4	83	38	12	4	-12-2.5
	16	0,2	26	42	15,2	92	44	16	4	-16-0.2
	16	2	26	42	15,2	92	44	16	4	-16-2
	16	2,5	26	42	15,2	92	44	16	4	-16-2.5
	16	3	26	42	15,2	92	44	16	4	-16-3
	16	4	26	42	15,2	92	44	16	4	-16-4
	20	0,2	32	52	19	104	54	20	4	-20-0.2
	20	2	32	52	19	104	54	20	4	-20-2
	20	2,5	32	52	19	104	54	20	4	-20-2.5
	20	3	32	52	19	104	54	20	4	-20-3
	20	4	32	52	19	104	54	20	4	-20-4
	25	0,2	40	63	23,75	121	65	25	4	-25-0.2
	25	2	40	63	23,75	121	65	25	4	-25-2
	25	2,5	40	63	23,75	121	65	25	4	-25-2.5
	25	3	40	63	23,75	121	65	25	4	-25-3
	25	4	40	63	23,75	121	65	25	4	-25-4

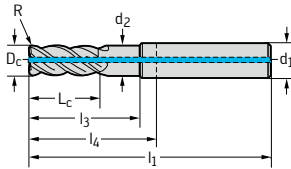

End mill with corner radius

Protostar® HSC 30

Ultra



Materials from 48 to 63 HRC

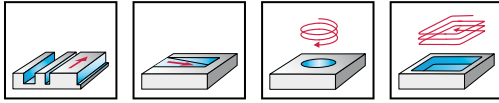

- solid carbide
- long reach
- 2 cutting edges
- with centre cut
- 30° helix angle

Special features:

Slot milling: $a_p \leq 0.1 \times D_c$

Shoulder milling: $a_e \leq 0.1 \times D_c$

	P	M	K	N	S	H	O
TAX						●●	

DIN 6527 L	D_c h7 mm	R mm	L_c mm	l_3 mm	d_2 mm	l_1 mm	l_4 mm	d_1 h5 mm	Z	TAX designation H8005728
Shank DIN 6535 HA	5	0,5	5	20	4,9	57	21	6	2	-5
	6	1	6	24	5,9	63	27	8	2	-6
	8	1	8	29	7,85	72	32	10	2	-8
	10	1,5	10	35	9,85	83	38	12	2	-10
	12	1,5	12	36	11,8	83	38	12	2	-12

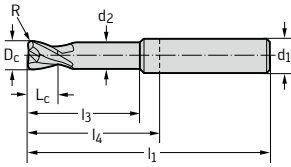

P standard L	D_c h7 mm	R mm	L_c mm	l_3 mm	α	l_1 mm	l_4 mm	d_1 h5 mm	Z	TAX designation H8005928
Shank DIN 6535 HA	2	0,5	2	18	4	57	21	6	2	-2-0.5
	3	0,5	3	19	4	57	21	6	2	-3-0.5-19
	3	0,5	3	37	1	80	44	6	2	-3-0.5-37
	4	0,5	4	20	4	57	21	6	2	-4-0.5-20
	4	0,5	4	50	1	90	54	6	2	-4-0.5-50
	6	0,5	6	52	1	100	64	8	2	-6-0.5
	6	1	6	52	1	100	64	8	2	-6-1

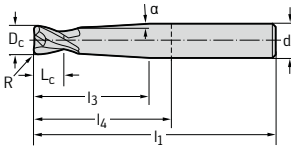

End mill with corner radius Protostar® HSC 30



Materials to 52 HRC

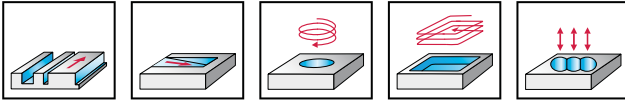

- solid carbide
- long reach
- 2 cutting edges
- with centre cut
- 30° helix angle

Special features:

Slot milling: $a_p \leq 0.5 \times D_c$

Shoulder milling: $a_e \leq 0.6 \times D_c$

	P	M	K	N	S	H	O
uncoated	●			●●			
TAX	●●			●			

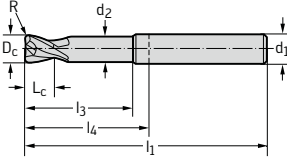
P standard L	D_c h9 mm	R mm	L_c mm	l_3 mm	d_2 mm	l_1 mm	l_4 mm	d_1 h5 mm	Z	uncoated	TAX
										designation H800881	designation H8008818
Shank DIN 6535 HA 	0,6	0,06	0,6	2,4	0,56	54	18	6	2	-0.6-0.06	-0.6-0.06
	0,8	0,08	0,8	3,2	0,76	54	18	6	2	-0.8-0.08	-0.8-0.08
	1	0,1	1	4	0,96	65	29	6	2	-1-0.1	-1-0.1
	1,5	0,15	1,5	6	1,44	65	29	6	2	-1.5-0.15	-1.5-0.15
	2	0,2	2	8	1,92	72	36	6	2	-2-0.2	-2-0.2
	2	0,5	2	8	1,92	72	36	6	2	-2-0.5	-2-0.5
	3	0,2	3	12	2,9	72	36	6	2	-3-0.2	-3-0.2
	3	0,3	3	12	2,9	72	36	6	2	-3-0.3	-3-0.3
	4	0,4	4	16	3,8	72	36	6	2	-4-0.4	-4-0.4
	5	0,5	5	20	4,75	72	36	6	2	-5-0.5	-5-0.5
	6	0,2	6	24	5,7	72	36	6	2	-6-0.2	-6-0.2
	6	0,5	6	24	5,7	72	36	6	2	-6-0.5	-6-0.5
	8	0,3	8	29	7,6	80	44	8	2	-8-0.3	-8-0.3
	8	0,5	8	29	7,6	80	44	8	2	-8-0.5	-8-0.5
	8	1	8	29	7,6	80	44	8	2	-8-1	-8-1
	8	1,5	8	29	7,6	80	44	8	2	-8-1.5	-8-1.5
	10	0,3	10	35	9,5	100	60	10	2	-10-0.3	-10-0.3
	10	0,5	10	35	9,5	100	60	10	2	-10-0.5	-10-0.5
	10	1	10	35	9,5	100	60	10	2	-10-1	-10-1
	10	1,5	10	35	9,5	100	60	10	2	-10-1.5	-10-1.5
12	0,5	12	36	11,4	100	55	12	2	-12-0.5 ¹	-12-0.5 ¹	
12	1	12	36	11,4	100	55	12	2	-12-1 ¹	-12-1 ¹	
12	1,5	12	36	11,4	100	55	12	2	-12-1.5 ¹	-12-1.5 ¹	

¹Shank tolerance h6

End mill with corner radius Protostar® HSC 30



Materials to 52 HRC

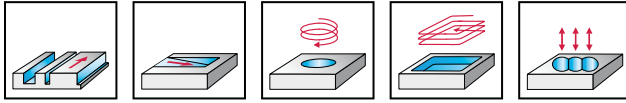

- solid carbide
- long reach
- 2 cutting edges
- with centre cut
- 30° helix angle

Special features:

Slot milling: $a_p \leq 0.3 \times D_c$

Shoulder milling: $a_e \leq 0.3 \times D_c$

	P	M	K	N	S	H	O
uncoated	●			●●			
TAX	●●			●			

P standard L	D_c	R	L_c	l_3	d_2	l_1	l_4	d_1	Z	uncoated designation	TAX designation
	h9 mm	mm	mm	mm	mm	mm	mm	h5 mm		H800891	H8008918
Shank DIN 6535 HA	0,6	0,06	0,6	4,8	0,56	54	18	6	2	-0,6	-0,6
	0,8	0,08	0,8	6,4	0,76	54	18	6	2	-0,8	-0,8
	1	0,1	1	8	0,96	65	29	6	2	-1	-1
	1,5	0,15	1,5	12	1,44	65	29	6	2	-1,5	-1,5
	2	0,2	2	16	1,92	72	36	6	2	-2	-2

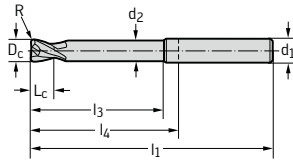

End mill with corner radius

Protostar® HSC 30

Ultra



Materials from 48 to 63 HRC

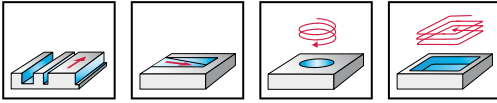

- solid carbide
- long reach
- 4 cutting edges
- with centre cut
- 30° helix angle

Special features:

Slot milling: $a_p \leq 0.1 \times D_c$

Shoulder milling: $a_e \leq 0.1 \times D_c$

	P	M	K	N	S	H	O
TAX						●●	

P standard L	D_c h7 mm	R mm	L_c mm	l_3 mm	d_2 mm	l_1 mm	l_4 mm	d_1 h5 mm	Z	TAX designation H8015728
Shank DIN 6535 HA	6	1	6	24	5,9	63	27	8	4	-6
	8	1	8	29	7,85	72	32	10	4	-8
	10	1,5	10	35	9,85	83	38	12	4	-10
	12	1,5	12	36	11,8	83	38	12	4	-12
	16	2	16	42	15,8	92	44	16	4	-16
	20	2	20	52	19,75	104	54	20	4	-20

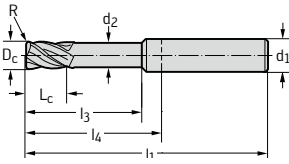

P standard L	D_c h7 mm	R mm	L_c mm	l_3 mm	d_2 mm	l_1 mm	l_4 mm	d_1 h5 mm	Z	TAX designation H8015828
Shank DIN 6535 HA	4	0,4	4	16	3,9	75	39	6	4	-4-0.4-16
	4	0,4	4	24	3,9	75	39	6	4	-4-0.4-24
	5	0,5	5	20	4,9	75	39	6	4	-5-0.5-20
	5	0,5	5	30	4,9	75	39	6	4	-5-0.5-30
	6	0,2	6	24	5,9	75	39	6	4	-6-0.2-24
	6	0,2	6	35	5,9	75	39	6	4	-6-0.2-35
	6	0,5	6	24	5,9	75	39	6	4	-6-0.5-24
	6	0,5	6	35	5,9	75	39	6	4	-6-0.5-35
	8	0,5	8	29	7,85	80	44	8	4	-8-0.5-29
	8	0,5	8	43	7,85	80	44	8	4	-8-0.5-43
	8	1	8	29	7,85	80	44	8	4	-8-1.0-29
	8	1	8	43	7,85	80	44	8	4	-8-1.0-43
	8	1,5	8	29	7,85	80	44	8	4	-8-1.5-29
	10	0,3	10	35	9,85	100	60	10	4	-10-0.3-35
	10	0,5	10	35	9,85	100	60	10	4	-10-0.5-35
	10	0,5	10	59	9,85	100	60	10	4	-10-0.5-59
	10	1	10	35	9,85	100	60	10	4	-10-1.0-35
	10	1	10	59	9,85	100	60	10	4	-10-1.0-59
	10	1,5	10	35	9,85	100	60	10	4	-10-1.5-35
	10	1,5	10	59	9,85	100	60	10	4	-10-1.5-59
	12	0,5	12	36	11,8	100	55	12	4	-12-0.5-36
	12	0,5	12	54	11,8	100	55	12	4	-12-0.5-54
	12	1	12	36	11,8	100	55	12	4	-12-1.0-36
	12	1	12	54	11,8	100	55	12	4	-12-1.0-54
	12	1,5	12	36	11,8	100	55	12	4	-12-1.5-36
	12	1,5	12	54	11,8	100	55	12	4	-12-1.5-54
	12	2	12	36	11,8	100	55	12	4	-12-2.0-36
	12	2	12	54	11,8	100	55	12	4	-12-2.0-54
	16	2	16	42	15,8	115	67	16	4	-16-2.0-42

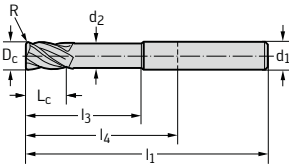

End mill with corner radius Protostar® HSC 30



Materials to 55 HRC

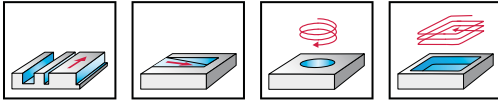

- solid carbide
- long reach
- 2 to 4 cutting edges
- with centre cut
- 30° helix angle

Special features:

Slot milling: $a_p \leq 0.3 \times D_c$

Shoulder milling: $a_e \leq 0.3 \times D_c$

	P	M	K	N	S	H	O
TAX	●●			●			

P standard XL	D_c h9 mm	R mm	L_c mm	l_3 mm	d_2 mm	l_1 mm	l_4 mm	d_1 h5 mm	Z	TAX designation H8095918
Shank DIN 6535 HA 	4	0,5	4	20	3,9	100	64	6	2	-4-20
	4	0,5	4	30	3,9	100	64	6	2	-4-30
	4	0,5	4	40	3,9	100	64	6	2	-4-40
	5	0,5	5	25	4,9	100	64	6	2	-5-25
	5	0,5	5	50	4,9	100	64	6	2	-5-50
	6	0,5	6	30	5,9	100	64	6	4	-6-30
	6	0,5	6	45	5,9	100	64	6	4	-6-45
	6	0,5	6	60	5,9	100	64	6	4	-6-60
	8	0,5	8	40	7,85	120	84	8	4	-8-40
	8	0,5	8	60	7,85	120	84	8	4	-8-60
	8	0,5	8	80	7,85	120	84	8	4	-8-80
	10	1	10	50	9,85	150	110	10	4	-10-50
10	1	10	75	9,85	150	110	10	4	-10-75	
12	1	12	60	11,8	150	105	12	4	-12-60	

End mill with corner radius Protostar® HSC 30



specially for graphite

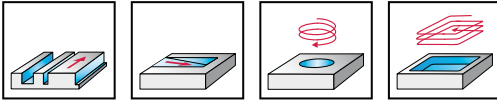

Special features:

Slot milling: $a_p \leq 0.3 \times D_c$

Shoulder milling: $a_e \leq 0.3 \times D_c$

- solid carbide
- long reach
- 2 to 4 cutting edges
- with centre cut
- 30° helix angle

	P	M	K	N	S	H	O
DIA							●●

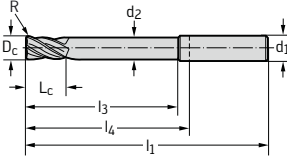
P standard XL	D_c h9 mm	R mm	L_c mm	l_3 mm	d_2 mm	l_1 mm	l_4 mm	d_1 h5 mm	Z	DIA designation H8095919
Shank DIN 6535 HA 	4	0,5	4	20	3,9	100	64	6	2	-4-20
	4	0,5	4	30	3,9	100	64	6	2	-4-30
	4	0,5	4	40	3,9	100	64	6	2	-4-40
	5	0,5	5	25	4,9	100	64	6	2	-5-25
	5	0,5	5	50	4,9	100	64	6	2	-5-50
	6	0,5	6	30	5,9	100	64	6	4	-6-30
	6	0,5	6	45	5,9	100	64	6	4	-6-45
	6	0,5	6	60	5,9	100	64	6	4	-6-60
	8	0,5	8	40	7,85	120	84	8	4	-8-40
	8	0,5	8	60	7,85	120	84	8	4	-8-60
	8	0,5	8	80	7,85	120	84	8	4	-8-80
	10	1	10	50	9,85	150	110	10	4	-10-50
10	1	10	75	9,85	150	110	10	4	-10-75	
12	1	12	60	11,8	150	105	12	4	-12-60	
12	1	12	90	11,8	150	105	12	4	-12-90	

End mill with corner radius

Protostar® AL 30

Sky-tec™

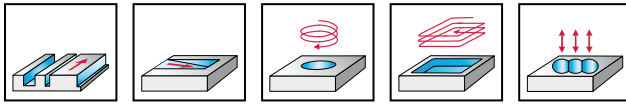

- solid carbide
- long reach
- 3 cutting edges
- with centre cut
- 30° helix angle

Special features:

 Slot milling: $a_p \leq 0.9 \times D_c$

 Shoulder milling: $a_e \leq 0.6 \times D_c$

	P	M	K	N	S	H	O
uncoated				●●			

P standard XL

Shank DIN 6535 HA

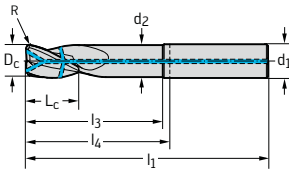

D_c h9 mm	R mm	L_c mm	l_3 mm	d_2 mm	l_1 mm	l_4 mm	d_1 h5 mm	Z	uncoated designation H602091
12	0,5	12	68	11,5	115	70	12	3	-12-12-0,5
12	0,5	18	53	11,5	100	55	12	3	-12-18-0,5
12	0,5	24	36	11,5	83	38	12	3	-12-24-0,5
12	2	12	68	11,5	115	70	12	3	-12-12-2
12	2	18	53	11,5	100	55	12	3	-12-18-2
12	2	24	36	11,5	83	38	12	3	-12-24-2
16	0,5	16	80	15,2	130	82	16	3	-16-16-0,5
16	0,5	24	65	15,2	115	67	16	3	-16-24-0,5
16	0,5	32	42	15,2	92	44	16	3	-16-32-0,5
16	2	16	80	15,2	130	82	16	3	-16-16-2
16	2	24	65	15,2	115	67	16	3	-16-24-2
16	2	32	42	15,2	92	44	16	3	-16-32-2
16	3	16	80	15,2	130	82	16	3	-16-16-3
16	3	24	65	15,2	115	67	16	3	-16-24-3
20	0,5	20	88	19	140	90	20	3	-20-20-0,5
20	0,5	30	73	19	125	75	20	3	-20-30-0,5
20	2	20	88	19	140	90	20	3	-20-20-2
20	2	30	73	19	125	75	20	3	-20-30-2
20	3	20	88	19	140	90	20	3	-20-20-3
20	3	30	73	19	125	75	20	3	-20-30-3
20	4	20	88	19	140	90	20	3	-20-20-4
20	4	30	73	19	125	75	20	3	-20-30-4
25	0,5	25	92	23,75	150	94	25	3	-25-25-0,5
25	0,5	37	72	23,75	130	74	25	3	-25-37-0,5
25	2	25	92	23,75	150	94	25	3	-25-25-2
25	2	37	72	23,75	130	74	25	3	-25-37-2
25	3	25	92	23,75	150	94	25	3	-25-25-3
25	3	37	72	23,75	130	74	25	3	-25-37-3
25	4	25	92	23,75	150	94	25	3	-25-25-4
25	4	37	72	23,75	130	74	25	3	-25-37-4

End mill with corner radius

Protostar® AL 25

Sky-tec™

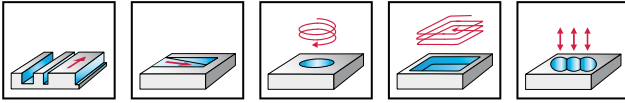

- solid carbide
- long reach
- 2 cutting edges
- with centre cut
- 25° helix angle

Special features:

Slot milling: $a_p \leq 0.9 \times D_c$

Shoulder milling: $a_e \leq 0.3 \times D_c$

	P	M	K	N	S	H	O
uncoated				●●			

P standard XL	D_c h9 mm	R mm	L_c mm	l_3 mm	d_2 mm	l_1 mm	l_4 mm	d_1 h5 mm	Z	uncoated designation H602691
Shank DIN 6535 HA 	12	0,5	12	68	11,5	115	70	12	2	-12-12-0.5
	12	2	12	68	11,5	115	70	12	2	-12-12-2
	16	0,5	16	80	15,2	130	82	16	2	-16-16-0.5
	16	2	16	80	15,2	130	82	16	2	-16-16-2
	16	3	16	80	15,2	130	82	16	2	-16-16-3
	20	0,5	20	88	19	140	90	20	2	-20-20-0.5
	20	2	20	88	19	140	90	20	2	-20-20-2
	20	3	20	88	19	140	90	20	2	-20-20-3
	20	4	20	88	19	140	90	20	2	-20-20-4
	25	0,5	25	92	23,75	150	94	25	2	-25-25-0.5
	25	2	25	92	23,75	150	94	25	2	-25-25-2
	25	3	25	92	23,75	150	94	25	2	-25-25-3
	25	4	25	92	23,75	150	94	25	2	-25-25-4

End mill with corner radius

Protostar® AL 25

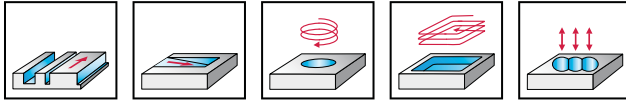

- solid carbide
- long reach
- 2 cutting edges
- with centre cut
- 25° helix angle

Special features:

 Slot milling: $a_p \leq 0.5 \times D_c$

 Shoulder milling: $a_e \leq 0.6 \times D_c$

	P	M	K	N	S	H	O
uncoated				●●			
TAX				●●			

P standard L	D_c h9 mm	R mm	L_c mm	l_3 mm	d_2 mm	l_1 mm	l_4 mm	d_1 h5 mm	Z	uncoated	TAX
										designation H602881	designation H6028818
Shank DIN 6535 HA 	6	0,5	10	28	5,7	65	29	6	2	-6-0.5	-6-0.5
	6	1	10	28	5,7	65	29	6	2	-6-1	-6-1
	8	1	12	35	7,6	80	44	8	2	-8-1	-8-1
	8	2	12	35	7,6	80	44	8	2	-8-2	-8-2
	10	1	14	45	9,5	90	50	10	2	-10-1	-10-1
	10	2	14	45	9,5	90	50	10	2	-10-2	-10-2
	12	1,5	16	50	11,4	100	55	12	2	-12-1.5 ¹	-12-1.5 ¹
	12	3	16	50	11,4	100	55	12	2	-12-3 ¹	-12-3 ¹
	16	2	20	63	15,2	115	67	16	2	-16-2 ¹	-16-2 ¹
	16	4	20	63	15,2	115	67	16	2	-16-4 ¹	-16-4 ¹
	20	2	20	70	19	125	75	20	2	-20-2 ¹	-20-2 ¹
	20	4	20	70	19	125	75	20	2	-20-4 ¹	-20-4 ¹

¹Shank tolerance h6



Mini end mill Protostar® HSC 30



Specially for graphite

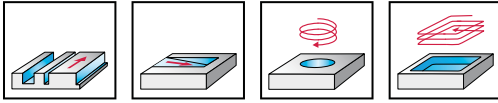

- solid carbide
- long reach
- 2 cutting edges
- with centre cut
- 30° helix angle

Special features:

Slot milling: $a_p \leq 0.1 \times D_c$

Shoulder milling: $a_e \leq 0.05 \times D_c$

	P	M	K	N	S	H	O
DIA							●●

P standard mini	D_c h9 mm	R mm	L_c mm	l_3 mm	d_2 mm	l_1 mm	l_4 mm	d_1 h5 mm	Z	DIA designation H4044919
Shank DIN 6535 HA 	0,4	0,05	0,4	1	0,37	38	10	3	2	-0.4-1
	0,4	0,05	0,4	2	0,37	38	10	3	2	-0.4-2
	0,4	0,05	0,4	4	0,37	38	10	3	2	-0.4-4
	0,5	0,05	0,5	1,25	0,47	38	10	3	2	-0.5-1.25
	0,5	0,05	0,5	2,5	0,47	38	10	3	2	-0.5-2.5
	0,5	0,05	0,5	5	0,47	38	10	3	2	-0.5-5
	0,6	0,05	0,6	1,5	0,57	38	10	3	2	-0.6-1.5
	0,6	0,05	0,6	3	0,57	38	10	3	2	-0.6-3
	0,6	0,05	0,6	4,5	0,57	38	10	3	2	-0.6-4.5
	0,6	0,05	0,6	6	0,57	38	10	3	2	-0.6-6
	0,6	0,05	0,6	9	0,57	38	10	3	2	-0.6-9
	0,8	0,05	0,8	2	0,77	38	10	3	2	-0.8-2
	0,8	0,05	0,8	4	0,77	38	10	3	2	-0.8-4
	0,8	0,05	0,8	6	0,77	38	10	3	2	-0.8-6
	0,8	0,05	0,8	8	0,77	38	10	3	2	-0.8-8
	0,8	0,05	0,8	12	0,77	60	32	3	2	-0.8-12
	1	0,1	1	2,5	0,97	38	10	3	2	-1-2.5
	1	0,1	1	5	0,97	60	32	3	2	-1-5
	1	0,1	1	7,5	0,97	60	32	3	2	-1-7.5
	1	0,1	1	10	0,97	60	32	3	2	-1-10
	1	0,1	1	15	0,97	60	32	3	2	-1-15
	1	0,1	1	20	0,97	60	32	3	2	-1-20
	1,5	0,15	1,5	7,5	1,47	60	32	3	2	-1.5-7.5
	1,5	0,15	1,5	15	1,47	60	32	3	2	-1.5-15
	2	0,2	2	10	1,97	60	32	3	2	-2-10
	2	0,2	2	15	1,97	60	32	3	2	-2-15
	2	0,2	2	20	1,97	60	32	3	2	-2-20
	2	0,2	2	30	1,97	60	32	3	2	-2-30
	2,5	0,25	2,5	12,5	2,47	60	32	3	2	-2.5-12.5
	2,5	0,25	2,5	25	2,47	60	32	3	2	-2.5-25
3	0,3	3	15	2,97	60	32	3	2	-3-15	
3	0,3	3	22,5	2,97	60	32	3	2	-3-22.5	
3	0,3	3	30	2,97	60	32	3	2	-3-30	

Mini end mill

Protostar® HSC 30

Ultra



Materials from 48 to 63 HRC

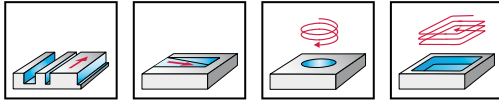

- solid carbide
- long reach
- 2 cutting edges
- with centre cut
- 30° helix angle

Special features:

Slot milling: $a_p \leq 0.1 \times D_c$

Shoulder milling: $a_e \leq 0.1 \times D_c$

	P	M	K	N	S	H	O
TAX						●●	

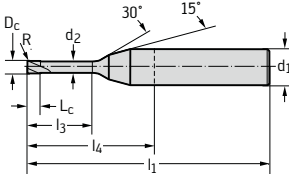
P standard mini	D_c h7 mm	R mm	L_c mm	l_3 mm	d_2 mm	l_1 mm	l_4 mm	d_1 h5 mm	Z	TAX designation H4044928
Shank DIN 6535 HA 	0,4	0,05	0,4	1	0,37	38	10	3	2	-0,4-1
	0,4	0,05	0,4	2	0,37	38	10	3	2	-0,4-2
	0,5	0,05	0,5	1,25	0,47	38	10	3	2	-0,5-1,25
	0,5	0,05	0,5	2,5	0,47	38	10	3	2	-0,5-2,5
	0,5	0,05	0,5	3,75	0,47	38	10	3	2	-0,5-3,75
	0,6	0,05	0,6	1,5	0,57	38	10	3	2	-0,6-1,5
	0,6	0,05	0,6	3	0,57	38	10	3	2	-0,6-3
	0,6	0,05	0,6	4,5	0,57	38	10	3	2	-0,6-4,5
	0,8	0,05	0,8	2	0,77	38	10	3	2	-0,8-2
	0,8	0,05	0,8	4	0,77	38	10	3	2	-0,8-4
	0,8	0,05	0,8	6	0,77	38	10	3	2	-0,8-6
	1	0,1	1	2,5	0,97	38	10	3	2	-1-2,5
	1	0,1	1	5	0,97	60	32	3	2	-1-5
	1	0,1	1	7,5	0,97	60	32	3	2	-1-7,5
	1,5	0,15	1,5	4	1,47	38	10	3	2	-1,5-4
	1,5	0,15	1,5	7,5	1,47	60	32	3	2	-1,5-7,5
	1,5	0,15	1,5	12	1,47	60	32	3	2	-1,5-12
	2	0,2	2	5	1,97	38	10	3	2	-2-5
	2	0,2	2	10	1,97	60	32	3	2	-2-10
	2	0,2	2	15	1,97	60	32	3	2	-2-15
	2,5	0,25	2	6	2,47	38	10	3	2	-2,5-6
	2,5	0,25	2	12,5	2,47	60	32	3	2	-2,5-12,5
	2,5	0,25	2	20	2,47	60	32	3	2	-2,5-20
	3	0,3	2	7,5	2,97	38	10	3	2	-3-7,5
	3	0,3	2	15	2,97	60	32	3	2	-3-15
	3	0,3	2	22,5	2,97	60	32	3	2	-3-22,5

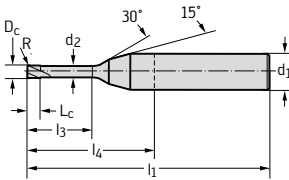
P standard mini	D_c h7 mm	R mm	L_c mm	l_3 mm	d_2 mm	l_1 mm	l_4 mm	d_1 h5 mm	Z	TAX designation H8005828
Shank DIN 6535 HA 	0,6	0,06	0,6	2,4	0,57	54	18	6	2	-0,6
	0,8	0,08	0,8	3,2	0,77	54	18	6	2	-0,8
	1	0,1	1	4	0,97	65	29	6	2	-1
	1,2	0,12	1,2	4,8	1,17	65	29	6	2	-1,2
	1,5	0,15	1,5	6	1,47	65	29	6	2	-1,5
	2	0,2	2	8	1,97	75	39	6	2	-2-0,2
	2	0,5	2	8	1,97	75	39	6	2	-2-0,5
	3	0,2	3	12	2,97	75	39	6	2	-3-0,2
	3	0,3	3	12	2,97	75	39	6	2	-3-0,3

Roughing milling cutters

Protostar® HR Kordel F 45

Qmax



Materials to 48 HRC

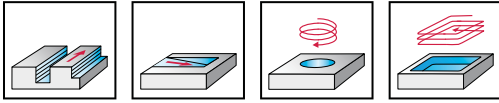

- solid carbide
- 5 to 8 cutting edges
- with centre cut
- 45° helix angle

Special features:

Slot milling: $a_p \leq 0.5 \times D_c$

Shoulder milling: $a_e \leq 0.5 \times D_c$

	P	M	K	N	S	H	O
TAX	●●	●	●	●	●	●	●

P standard	D_c	L_c	d_2	l_1	l_4	SW	d_1	Z	TAX designation
	h12 mm	mm	mm	mm	mm	mm			H3E85378
ConeFit™	10	5,5	9,7	23,6	12,4	8	E 10	5	-E10-10
	12	6,5	11,7	28,3	14,5	10	E 12	5	-E12-12
	16	8,5	15,5	35,7	18,7	12	E 16	6	-E16-16
	20	11	19,3	40,8	21,3	16	E 20	6	-E20-20
	25	13,5	24,2	49,6	25,6	20	E 25	8	-E25-25

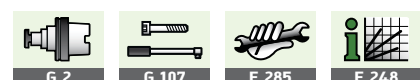
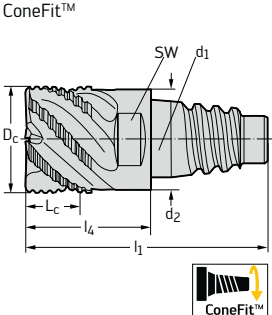

Roughing milling cutters

Protostar® HR Kordel F 45

Qmax



Materials to 48 HRC

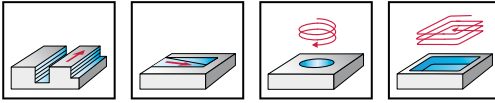

- solid carbide
- 5 to 8 cutting edges
- with centre cut
- 45° helix angle

Special features:

Slot milling: $a_p \leq 1.5 \times D_c$

Shoulder milling: $a_e \leq 0.6 \times D_c$

	P	M	K	N	S	H	O
TAX	●●	●	●				

DIN 6527 L	D_c h12 mm	L_c mm	l_1 mm	l_4 mm	d_1 h6 mm	Z	TAX designation H3185378
Shank DIN 6535 HB	12	26	83	38	12	5	-12
	14	26	83	38	14	6	-14
	16	32	92	44	16	6	-16
	18	32	92	44	18	6	-18
	20	38	104	54	20	6	-20
	25	45	121	65	25	8	-25

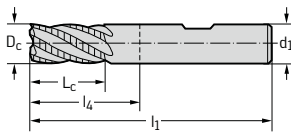

Roughing milling cutters

Protostar® HR Kordel F 40

Qmax



Materials to 48 HRC

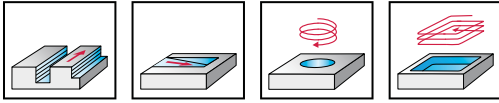

- solid carbide
- 4 cutting edges
- with centre cut
- 40° helix angle

Special features:

Slot milling: $a_p \leq 0.5 \times D_c$

Shoulder milling: $a_e \leq 0.5 \times D_c$

	P	M	K	N	S	H	O
TAX	●	●●	■	■	■	■	■

P standard	D_c	L_c	d_2	l_1	l_4	SW	d_1	Z	TAX designation
	h12 mm	mm	mm	mm	mm	mm			H3E82378
ConeFit™	10	5,5	9,7	23,6	12,4	8	E 10	4	-E10-10
	12	6,5	11,7	28,3	14,5	10	E 12	4	-E12-12
	16	8,5	15,5	35,7	18,7	12	E 16	4	-E16-16

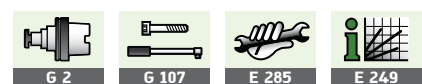
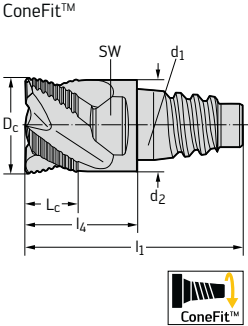

Roughing milling cutters

Protostar® HR Kordel F 40

Qmax



Materials to 48 HRC

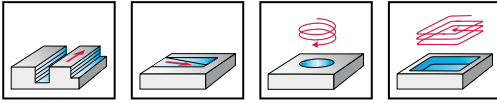

- solid carbide
- 4 cutting edges
- with centre cut
- 40° helix angle

Special features:

Slot milling: $a_p \leq 1.5 \times D_c$

Shoulder milling: $a_e \leq 0.6 \times D_c$

	P	M	K	N	S	H	O
TAX	●	●●	■	■	■	■	■

DIN 6527 L	D_c h12 mm	L_c mm	l_3 mm	d_2 mm	l_1 mm	l_4 mm	d_1 h6 mm	Z	TAX designation H3182378
Shank DIN 6535 HB	5	13	-	-	57	21	6	4	-5
	6	13	-	-	57	21	6	4	-6
	8	19	-	-	63	27	8	4	-8
	10	22	-	-	72	32	10	4	-10
	12	26	-	-	83	38	12	4	-12
	14	26	-	-	83	38	14	4	-14
	16	32	-	-	92	44	16	4	-16
	18	32	-	-	92	44	18	4	-18
	20	38	-	-	104	54	20	4	-20

DIN 6527 K	D_c h12 mm	L_c mm	l_3 mm	d_2 mm	l_1 mm	l_4 mm	d_1 h6 mm	Z	TAX designation H4189278
Shank DIN 6535 HB	6	7	16	5,5	54	18	6	4	-6
	8	9	20	7,5	58	22	8	4	-8
	10	11	24	9,5	66	26	10	4	-10
	12	12	26	11,4	73	28	12	4	-12
	14	14	28	13,3	75	30	14	4	-14
	16	16	32	15,2	82	34	16	4	-16
	18	18	34	17,1	84	36	18	4	-18
	20	20	40	19	92	42	20	4	-20
	25	26	63	23,75	121	65	25	4	-25

DIN 6527 L	D_c h12 mm	L_c mm	l_3 mm	d_2 mm	l_1 mm	l_4 mm	d_1 h6 mm	Z	TAX designation H4189378
Shank DIN 6535 HB	5	13	16	4,75	57	21	6	4	-5
	6	13	19	5,5	57	21	6	4	-6
	7	16	26	6,5	63	27	8	4	-7
	8	19	25	7,5	63	27	8	4	-8
	9	19	31	8,5	72	32	10	4	-9
	10	22	30	9,5	72	32	10	4	-10
	11	26	35	10,45	83	38	12	4	-11
	12	26	36	11,4	83	38	12	4	-12
	13	26	35	12,35	83	38	14	4	-13
	14	26	36	13,3	83	38	14	4	-14
	15	32	41	14,25	92	44	16	4	-15
	16	32	42	15,2	92	44	16	4	-16
	18	32	42	17,1	92	44	18	4	-18
	20	38	52	19	104	54	20	4	-20

Tools with internal cooling without centre cut

Roughing milling cutters

Protostar® AL Kordel G 40

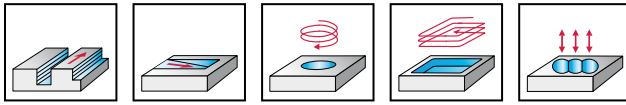

- solid carbide
- 3 cutting edges
- with centre cut
- with V cutting edge
- 40° helix angle

Special features:

 Slot milling: $a_p \leq 1.0 \times D_c$

 Shoulder milling: $a_e \leq 0.6 \times D_c$

	P	M	K	N	S	H	O
uncoated				●●			

DIN 6527 L	D_c h12 mm	L_c mm	d_2 mm	l_1 mm	l_3 mm	l_4 mm	d_1 h5 mm	Z	uncoated designation H608411
Shank DIN 6535 HA	6	13	-	57	-	21	6	3	-6
	8	19	-	63	-	27	8	3	-8
	10	22	-	72	-	32	10	3	-10
	12	26	-	83	-	38	12	3	-12 ¹
	14	26	-	83	-	38	14	3	-14 ¹
	16	32	-	92	-	44	16	3	-16 ¹
	20	38	-	104	-	54	20	3	-20 ¹

P standard L	D_c h12 mm	L_c mm	d_2 mm	l_1 mm	l_3 mm	l_4 mm	d_1 h5 mm	Z	uncoated designation H608771
Shank DIN 6535 HA	6	10	5,5	63	24	27	8	3	-6
	8	12	7,5	72	29	32	10	3	-8
	10	14	9,5	83	35	38	12	3	-10 ¹
	12	16	11,4	100	50	55	12	3	-12 ¹
	16	20	15,2	115	63	67	16	3	-16 ¹
	20	20	19	125	70	75	20	3	-20 ¹
	25	25	23,75	135	75	79	25	3	-25 ¹

¹Shank tolerance h6

Roughing milling cutters Protostar® AL Kordel G 40

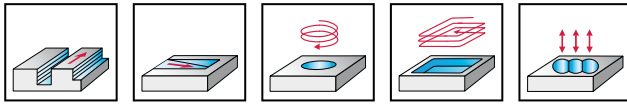

- solid carbide
- long reach
- 3 cutting edges
- with V cutting edge
- 40° helix angle

Special features:

Slot milling: $a_p \leq 1.0 \times D_c$

Shoulder milling: $a_e \leq 0.6 \times D_c$

	P	M	K	N	S	H	O
uncoated				●●			

P standard L	D_c	L_c	d_2	l_1	l_3	l_4	d_1	Z	uncoated designation H608871
	h12 mm	mm	mm	mm	mm	mm	h5 mm		
Shank DIN 6535 HA	6	10	5,5	63	24	27	8	3	-6
	8	12	7,5	72	29	32	10	3	-8
	10	14	9,5	83	35	38	12	3	-10 ¹
	12	16	11,4	100	50	55	12	3	-12 ¹
	16	20	15,2	115	63	67	16	3	-16 ¹
	20	20	19	125	70	75	20	3	-20 ¹
	25	25	23,75	135	75	79	25	3	-25 ¹

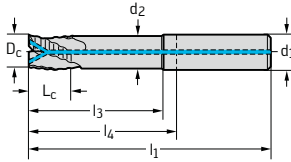

¹Shank tolerance h6

DIN 6527 L	D_c	L_c	d_2	l_1	l_3	l_4	d_1	Z	uncoated designation H618911
	h12 mm	mm	mm	mm	mm	mm	h6 mm		
Shank DIN 6535 HB	6	13	-	57	-	21	6	3	-6
	8	19	-	63	-	27	8	3	-8
	10	22	-	72	-	32	10	3	-10
	12	26	-	83	-	38	12	3	-12
	14	26	-	83	-	38	14	3	-14
	16	32	-	92	-	44	16	3	-16
	20	38	-	104	-	54	20	3	-20

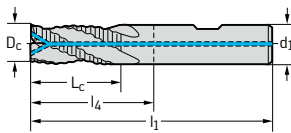

Roughing milling cutters

Protostar® HNR Kordel F 30

Qmax



Materials to 48 HRC

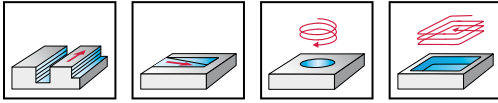

- solid carbide
- 4 cutting edges
- with centre cut
- 30° helix angle

Special features:

Slot milling: $a_p \leq 1.0 \times D_c$

Shoulder milling: $a_e \leq 0.6 \times D_c$

	P	M	K	N	S	H	O
TAX	●	●	●	●			

DIN 6527 K	D_c h12 mm	L_c mm	d_2 mm	l_1 mm	l_3 mm	l_4 mm	d_1 h6 mm	Z	TAX designation H3180278
Shank DIN 6535 HB	6	7	-	54	-	18	6	4	-6
	8	9	-	58	-	22	8	4	-8
	10	11	-	66	-	26	10	4	-10
	12	12	-	73	-	28	12	4	-12
	14	14	-	75	-	30	14	4	-14
	16	16	-	82	-	34	16	4	-16
	18	18	-	84	-	36	18	4	-18
	20	20	-	92	-	42	20	4	-20
	25	26	-	121	-	65	25	4	-25

DIN 6527 L	D_c h12 mm	L_c mm	d_2 mm	l_1 mm	l_3 mm	l_4 mm	d_1 h6 mm	Z	TAX designation H4180378
Shank DIN 6535 HB	6	13	5,5	57	19	21	6	4	-6
	8	19	7,5	63	25	27	8	4	-8
	10	22	9,5	72	30	32	10	4	-10
	12	26	11,4	83	36	38	12	4	-12
	14	26	13,3	83	36	38	14	4	-14
	16	32	15,2	92	42	44	16	4	-16
	20	38	19	104	52	54	20	4	-20
	25	45	23,75	121	63	65	25	4	-25

Roughing milling cutters

Protostar® HR Kordel F 30

Qmax



Materials to 48 HRC

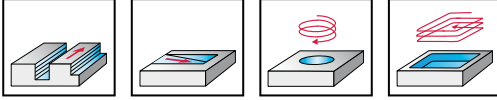

- solid carbide
- 3 cutting edges
- with centre cut
- 30° helix angle

Special features:

Slot milling: $a_p \leq 1.0 \times D_c$

Shoulder milling: $a_e \leq 0.6 \times D_c$

	P	M	K	N	S	H	O
TAX	●	●●	●	●			

DIN 6527 K	D_c h12 mm	L_c mm	l_1 mm	l_4 mm	d_1 h6 mm	Z	TAX designation H3187278
Shank DIN 6535 HB	6	7	54	18	6	3	-6
	8	9	58	22	8	3	-8
	10	11	66	26	10	3	-10
	12	12	73	28	12	3	-12
	14	14	75	30	14	3	-14
	16	16	82	34	16	3	-16
	18	18	84	36	18	3	-18
	20	20	92	42	20	3	-20
	25	26	121	65	25	3	-25

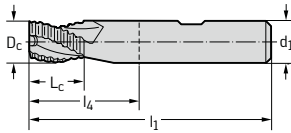

Roughing milling cutters

Protostar® Ti NS 30

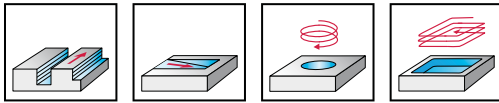

- solid carbide
- 4 to 5 cutting edges
- with centre cut
- 30° helix angle

Special features:

 Slot milling: $a_p \leq 1.0 \times D_c$

 Shoulder milling: $a_e \leq 0.6 \times D_c$

	P	M	K	N	S	H	O
ACN		●			●●		

DIN 6527 L	D_c h10 mm	L_c mm	l_1 mm	l_4 mm	d_1 h6 mm	Z	ACN designation H3083017
Shank DIN 6535 HA	6	13	57	21	6	4	-6
	8	19	63	27	8	4	-8
	10	22	72	32	10	4	-10
	12	26	83	38	12	4	-12
	14	26	83	38	14	4	-14
	16	32	92	44	16	4	-16
	18	32	92	44	18	4	-18
	20	38	104	54	20	4	-20
	25	45	121	65	25	5	-25

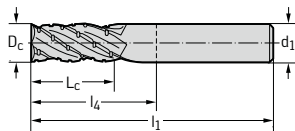

DIN 6527 L	D_c h10 mm	L_c mm	l_1 mm	l_4 mm	d_1 h6 mm	Z	ACN designation H3183017
Shank DIN 6535 HB	6	13	57	21	6	4	-6
	8	19	63	27	8	4	-8
	10	22	72	32	10	4	-10
	12	26	83	38	12	4	-12
	14	26	83	38	14	4	-14
	16	32	92	44	16	4	-16
	18	32	92	44	18	4	-18
	20	38	104	54	20	4	-20
	25	45	121	65	25	5	-25

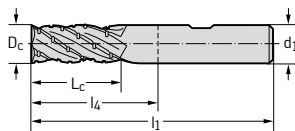

Roughing milling cutters

Protostar® AL Rapax G 30

Sky-tec™

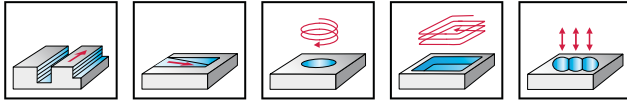

- solid carbide
- long reach
- 3 cutting edges
- with centre cut
- 30° helix angle

Special features:

Slot milling: $a_p \leq 1.5 \times D_c$

Shoulder milling: $a_e \leq 0.6 \times D_c$

	P	M	K	N	S	H	O
uncoated				●●			
CRN				●●			

P standard XL	D_c h10 mm	R mm	L_c mm	l_3 mm	d_2 mm	l_1 mm	l_4 mm	d_1 h5 mm	Z	uncoated	CRN
										designation H608391	designation H6083914
Shank DIN 6535 HA 	16	2	20	65	15,2	115	67	16	3	-16-20-2	-16-20-2
	16	2	24	42	15,2	92	44	16	3	-16-24-2	-16-24-2
	16	3	20	65	15,2	115	67	16	3	-16-20-3	-16-20-3
	16	3	24	42	15,2	92	44	16	3	-16-24-3	-16-24-3
	16	4	20	65	15,2	115	67	16	3	-16-20-4	-16-20-4
	16	4	24	42	15,2	92	44	16	3	-16-24-4	-16-24-4
	20	2	20	88	19	140	90	20	3	-20-20-2	-20-20-2
	20	2	25	73	19	125	75	20	3	-20-25-2	-20-25-2
	20	3	20	88	19	140	90	20	3	-20-20-3	-20-20-3
	20	3	25	73	19	125	75	20	3	-20-25-3	-20-25-3
	20	4	20	88	19	140	90	20	3	-20-20-4	-20-20-4
	20	4	25	73	19	125	75	20	3	-20-25-4	-20-25-4
	25	2	25	92	23,75	150	94	25	3	-25-25-2	-25-25-2
	25	2	30	72	23,75	130	74	25	3	-25-30-2	-25-30-2
	25	2	37	52	23,75	110	54	25	3	-25-37-2	-25-37-2
	25	3	25	92	23,75	150	94	25	3	-25-25-3	-25-25-3
	25	3	30	72	23,75	130	74	25	3	-25-30-3	-25-30-3
	25	3	37	52	23,75	110	54	25	3	-25-37-3	-25-37-3
	25	4	25	92	23,75	150	94	25	3	-25-25-4	-25-25-4
	25	4	30	72	23,75	130	74	25	3	-25-30-4	-25-30-4
25	4	37	52	23,75	110	54	25	3	-25-37-4	-25-37-4	

Roughing milling cutters

Protostar® FS 45

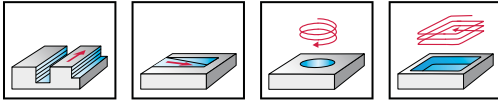

- HSS-E-PM
- 3 to 4 cutting edges
- with centre cut
- 45° helix angle

Special features:

Slot milling: $a_p \leq 1.0 \times D_c$

Shoulder milling: $a_e \leq 0.6 \times D_c$

	P	M	K	N	S	H	O
ACN	●●		●	●			

DIN 844 B	D_c k10 mm	L_c mm	l_1 mm	l_4 mm	d_1 h6 mm	Z	ACN designation P3123087
Shank DIN 1835 B	6	13	57	21	6	3	-6
	8	19	69	29	10	4	-8
	10	22	72	32	10	4	-10
	12	26	83	38	12	4	-12
	14	26	83	38	12	4	-14
	16	32	92	44	16	4	-16
	18	32	92	44	16	4	-18
	20	38	104	54	20	4	-20
	22	38	104	54	20	4	-22
	25	45	121	65	25	4	-25

Finishing end mill with chip breaker

Roughing milling cutters

Protostar® HRA Kordel F 35

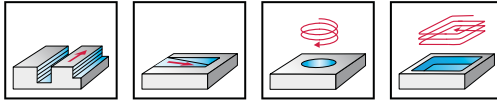

- HSS-E-PM
- 3 to 6 cutting edges
- with centre cut
- 35° helix angle

Special features:

Slot milling: $a_p \leq 1.5 \times D_c$

Shoulder milling: $a_e \leq 0.6 \times D_c$

	P	M	K	N	S	H	O
uncoated				●●			
ACN	●●		●	●			

DIN 844 B	D_c k12 mm	L_c mm	l_3 mm	l_1 mm	d_2 mm	l_4 mm	d_1 h6 mm	Z	uncoated designation P312021	ACN designation P3120217
Shank DIN 1835 B	5	13	-	57	-	21	6	4	-5	
	6	13	-	57	-	21	6	4	-6	-6
	8	19	-	69	-	29	10	4	-8	-8
	10	22	32	72	9,5	32	10	4	-10	-10
	12	26	38	83	11,5	38	12	4	-12	-12
	14	26	38	83	11,5	38	12	4	-14	-14
	16	32	44	92	15,5	44	16	4	-16	-16
	18	32	44	92	15,5	44	16	4	-18	-18
	20	38	54	104	19,5	54	20	4	-20	-20
	22	38	54	104	19,5	54	20	4	-22	-22
	25	45	65	121	24,5	65	25	6	-25	-25
	30	45	65	121	24,5	65	25	6	-30	-30
	32	53	73	133	31,5	73	32	6	-32	-32
	36	53	73	133	31,5	73	32	6	-36	
	40	63	85	155	39,5	85	40	6	-40	

DIN 844 B	D_c k12 mm	L_c mm	l_3 mm	l_1 mm	d_2 mm	l_4 mm	d_1 h6 mm	Z	uncoated designation P312028	ACN designation P3120287
Shank DIN 1835 B	5	13	-	57	-	21	6	3	-5	
	6	13	-	57	-	21	6	3	-6	-6
	7	16	-	66	-	26	10	3	-7	-7
	8	19	-	69	-	29	10	3	-8	-8
	9	19	-	69	-	29	10	3	-9	-9
	10	22	32	72	9,5	32	10	3	-10	-10
	11	22	-	79	-	34	12	3	-11	-11
	12	26	38	83	11,5	38	12	3	-12	-12
	13	26	38	83	11,5	38	12	3	-13	-13
	14	26	38	83	11,5	38	12	3	-14	-14
	15	26	38	83	11,5	38	12	3	-15	-15
	16	32	44	92	15,5	44	16	3	-16	-16
	18	32	44	92	15,5	44	16	3	-18	-18
	20	38	54	104	19,5	54	20	3	-20	-20
	22	38	54	104	19,5	54	20	3	-22	
	25	45	65	121	24,5	65	25	4	-25	-25
	30	45	-	121	-	65	25	4	-30	

Roughing milling cutters

Protostar® HRA Kordel F 35

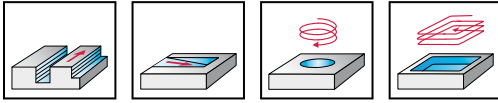

- HSS-E-PM
- 3 cutting edges
- with centre cut
- 35° helix angle

Special features:

 Slot milling: $a_p \leq 1.0 \times D_c$

 Shoulder milling: $a_e \leq 0.6 \times D_c$

	P	M	K	N	S	H	O
ACN	●●	●	●	●			

DIN 327 H	D_c k12 mm	L_c mm	l_3 mm	d_2 mm	l_1 mm	l_4 mm	d_1 h6 mm	Z	ACN designation P4110217
Shank DIN 1835 B	8	11	-	-	61	21	10	3	-8
	10	13	25	9,5	63	23	10	3	-10
	12	16	28	11,5	73	28	12	3	-12
	14	16	31	13,5	73	28	12	3	-14
	16	19	31	15,5	79	31	16	3	-16
	20	22	38	19,5	88	38	20	3	-20
	22	22	37	19,5	88	38	20	3	-22
	25	26	45	24,5	102	46	25	3	-25
	28	26	45	24,5	102	46	25	3	-28
	30	26	45	24,5	102	46	25	3	-30

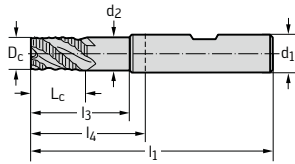

Roughing milling cutters

Protostar® NRA Kordel G 35

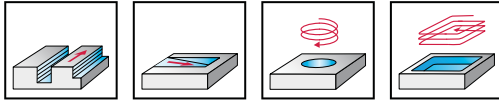

- HSS-E-PM
- 4 to 6 cutting edges
- with centre cut
- 35° helix angle

Special features:

Slot milling: $a_p \leq 1.5 \times D_c$

Shoulder milling: $a_e \leq 0.6 \times D_c$

	P	M	K	N	S	H	O
uncoated				●●			
ACN	●●		●	●			

DIN 844 B	D_c k12 mm	L_c mm	l_3 mm	d_2 mm	l_1 mm	l_4 mm	d_1 h6 mm	Z	uncoated designation P312001	ACN designation P3120017
Shank DIN 1835 B	6	13	-	-	57	21	6	4	-6	-6
	7	16	-	-	66	26	10	4	-7	-7
	8	19	-	-	69	29	10	4	-8	-8
	9	19	-	-	69	29	10	4	-9	-9
	10	22	-	-	72	32	10	4	-10	-10
	11	22	-	-	79	34	12	4	-11	-11
	12	26	-	-	83	38	12	4	-12	-12
	13	26	38	11,5	83	38	12	4	-13	
	14	26	38	11,5	83	38	12	4	-14	-14
	15	26	38	11,5	83	38	12	4	-15	-15
	16	32	44	15,5	92	44	16	4	-16	-16
	18	32	44	15,5	92	44	16	4	-18	-18
	20	38	54	19,5	104	54	20	4	-20	-20
	22	38	54	19,5	104	54	20	4	-22	-22
	25	45	65	24,5	121	65	25	6	-25	-25
	28	45	65	24,5	121	65	25	6	-28	
	30	45	65	24,5	121	65	25	6	-30	-30
	32	53	73	31,5	133	73	32	6	-32	
	40	63	85	39,5	155	85	40	6	-40	

DIN 844 B	D_c k12 mm	L_c mm	l_3 mm	d_2 mm	l_1 mm	l_4 mm	d_1 h6 mm	Z	uncoated designation P312011	ACN designation P3120117
Shank DIN 1835 B	6	24	-	-	68	32	6	4	-6	-6
	8	38	-	-	88	48	10	4	-8	-8
	10	45	55	9,5	95	55	10	4	-10	-10
	12	53	65	11,5	110	65	12	4	-12	-12
	14	53	65	11,5	110	65	12	4	-14	
	16	63	75	15,5	123	75	16	4	-16	-16
	18	63	75	15,5	123	75	16	4	-18	-18
	20	75	91	19,5	141	91	20	4	-20	-20
	22	75	91	19,5	141	91	20	4	-22	
	25	90	110	24,5	166	110	25	5	-25	-25
	30	90	110	24,5	166	110	25	5	-30	
	32	106	126	31,5	186	126	32	6	-32	
	40	125	147	39,5	217	147	40	6	-40	
	50	150	192	49,5	252	192	50	6	-50	

Roughing milling cutters

Protostar® HNR Kordel F 30

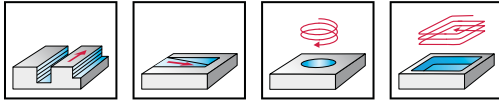

- HSS-E-PM
- 4 to 6 cutting edges
- with centre cut
- 30° helix angle

Special features:

Slot milling: $a_p \leq 1.5 \times D_c$

Shoulder milling: $a_e \leq 0.6 \times D_c$

	P	M	K	N	S	H	O
ACN	●●		●	●			

DIN 844 B	D_c k12 mm	L_c mm	l_3 mm	d_2 mm	l_1 mm	l_4 mm	d_1 h6 mm	Z	ACN designation P3120537
Shank DIN 1835 B	6	24	-	-	68	32	6	4	-6
	8	38	-	-	88	48	10	4	-8
	10	45	-	-	95	55	10	4	-10
	12	53	-	-	110	65	12	4	-12
	14	53	-	-	110	65	12	4	-14
	16	63	73	15,5	123	75	16	4	-16
	18	63	73	15,5	123	75	16	4	-18
	20	75	89	19,5	141	91	20	4	-20
	25	90	108	24,5	166	110	25	5	-25
	32	106	124	31,5	186	126	32	6	-32

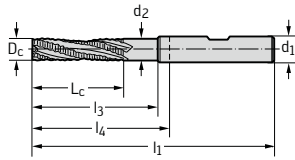

DIN 844 B	D_c k12 mm	L_c mm	l_3 mm	d_2 mm	l_1 mm	l_4 mm	d_1 h6 mm	Z	ACN designation P3120937
Shank DIN 1835 B	6	13	-	-	57	21	6	4	-6
	8	19	-	-	69	29	10	4	-8
	10	22	-	-	72	32	10	4	-10
	12	26	-	-	83	38	12	4	-12
	14	26	-	-	83	38	12	4	-14
	16	32	42	15,5	92	44	16	4	-16
	18	32	42	15,5	92	44	16	4	-18
	20	38	52	19,5	104	54	20	4	-20
	22	38	52	19,5	104	54	20	4	-22
	25	45	63	24,5	121	65	25	5	-25
	30	45	63	24,5	121	65	25	5	-30
	32	53	71	31,5	133	73	32	6	-32

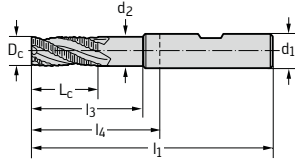

Roughing milling cutters Protostar® HR Kordel F 30

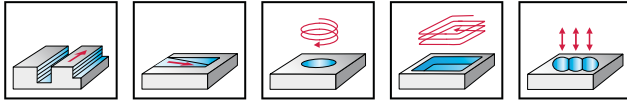

- HSS-E-PM
- 3 to 6 cutting edges
- with centre cut
- 30° helix angle

Special features:

Slot milling: $a_p \leq 1.0 \times D_c$

Shoulder milling: $a_e \leq 0.6 \times D_c$

	P	M	K	N	S	H	O
ACN	●●		●	●			

DIN 844 B	D_c k12 mm	L_c mm	l_3 mm	d_2 mm	l_1 mm	l_4 mm	d_1 h6 mm	Z	ACN designation P3120387
Shank DIN 1835 B	6	24	-	-	68	32	6	3	-6
	8	38	-	-	88	48	10	3	-8
	10	45	55	9,5	95	55	10	3	-10
	12	53	57	11,5	110	65	12	3	-12
	16	63	75	15,5	123	75	16	3	-16
	20	75	91	19,5	141	91	20	3	-20

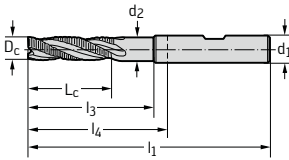

P standard	D_c k12 mm	L_c mm	l_3 mm	d_2 mm	l_1 mm	l_4 mm	d_1 h6 mm	Z	ACN designation P3128417
Shank DIN 1835 B	6	8	-	-	52	16	6	4	-6
	8	11	-	-	61	21	10	4	-8
	10	13	25	9,5	63	23	10	4	-10
	12	16	28	11,5	73	28	12	4	-12
	14	16	31	13,5	79	31	16	4	-14
	16	19	31	15,5	79	31	16	4	-16
	18	19	38	17,5	88	38	20	4	-18
	20	22	38	19,5	88	38	20	4	-20
	25	26	46	24,5	102	46	25	5	-25
	30	26	48	29,5	108	48	32	5	-30
	32	32	52	31,5	112	52	32	6	-32

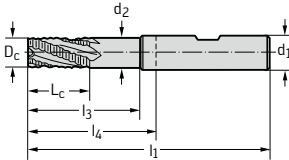

Roughing milling cutters

Protostar® NF Rapax G 30

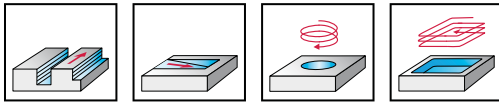

- HSS-E Co8
- 4 to 6 cutting edges
- without centre cut
- 30° helix angle

Special features:

 Slot milling: $a_p \leq 1.5 \times D_c$

 Shoulder milling: $a_e \leq 0.6 \times D_c$

	P	M	K	N	S	H	O
ACN	●●		●	●			
uncoated			●●				

DIN 844 B	D_c k12 mm	L_c mm	l_3 mm	d_2 mm	l_1 mm	l_4 mm	d_1 h6 mm	Z	ACN designation P3121017
Shank DIN 1835 B	6	13	-	-	57	21	6	4	-6
	8	19	-	-	69	29	10	4	-8
	10	22	-	-	72	32	10	4	-10
	12	26	-	-	83	38	12	4	-12
	14	26	-	-	83	38	12	4	-14
	16	32	-	-	92	44	16	4	-16
	18	32	-	-	92	44	16	4	-18
	20	38	-	-	104	54	20	4	-20
	22	38	-	-	104	54	20	4	-22
	25	45	-	-	121	65	25	5	-25
	30	45	-	-	121	65	25	5	-30

DIN 844 B	D_c k12 mm	L_c mm	l_3 mm	d_2 mm	l_1 mm	l_4 mm	d_1 h6 mm	Z	uncoated designation P312111
Shank DIN 1835 B	10	45	-	-	95	55	10	4	-10
	12	53	-	-	110	65	12	4	-12
	14	53	-	-	110	65	12	4	-14
	16	63	-	-	123	75	16	4	-16
	20	75	-	-	141	91	20	4	-20
	22	75	-	-	141	91	20	4	-22
	25	90	-	-	166	110	25	5	-25
	28	90	-	-	166	110	25	5	-28
	30	90	-	-	166	110	25	5	-30
	32	106	-	-	186	126	32	6	-32
	40	125	147	39,5	217	147	40	6	-40

Roughing milling cutters Protostar® NR Kordel G 30

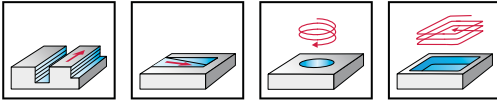

Special features:

Slot milling: $a_p \leq 1.0 \times D_c$

Shoulder milling: $a_e \leq 0.5 \times D_c$

- HSS-E-PM
- 4 to 5 cutting edges
- with centre cut
- 30° helix angle

	P	M	K	N	S	H	O
ACN	●●		●	●			

P standard	D_c	L_c	l_3	d_2	l_1	l_4	d_1	Z	ACN designation P3120717
	k12 mm	mm	mm	mm	mm	h6 mm			
Shank DIN 1835 B	6	19	-	-	63	27	6	4	-6
	8	29	-	-	79	43	8	4	-8
	10	34	45	9,5	84	44	10	4	-10
	12	40	52	11,5	97	52	12	4	-12
	14	43	52	11,5	100	55	12	4	-14
	16	45	57	15,5	105	57	16	4	-16
	18	45	57	15,5	105	57	16	4	-18
	20	55	71	19,5	121	71	20	4	-20
	22	63	71	19,5	129	79	20	4	-22
	25	68	91	24,5	144	88	25	5	-25
	30	71	91	24,5	147	91	25	5	-30

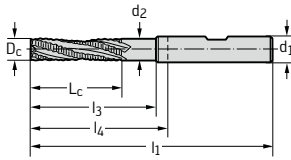

Roughing milling cutters Protostar® NR Kordel G 30

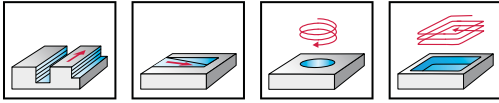

- HSS-E Co8
- 4 to 6 cutting edges
- with centre cut
- 30° helix angle

Special features:

Slot milling: $a_p \leq 0.5 \times D_c$

Shoulder milling: $a_e \leq 0.3 \times D_c$

	P	M	K	N	S	H	O
uncoated				●●			

DIN 845 B	D_c k12 mm	L_c mm	l_3 mm	d_2 mm	l_1 mm	d_1	Z	uncoated designation P352011
Shank DIN 228 A	16	63	79	15,5	148	MK1 A	4	-16
	20	75	91	17,5	160	MK1 A	4	-20
	25	90	106	23,5	192	MK1 A	4	-25
	30	90	106	23,5	192	MK1 A	6	-30
	40	125	141	31	250	MK1 A	6	-40

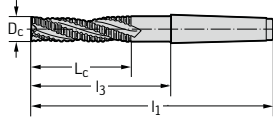

coarse roughing teeth

Shell end mills

Protostar® HR Kordel F 25

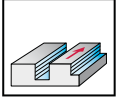
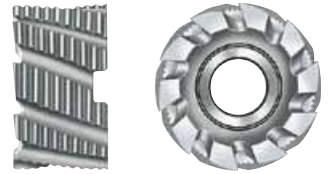

- HSS-E-PM
- 8 to 12 cutting edges
- 25° helix angle

	P	M	K	N	S	H	O
uncoated		●		●●			
TiCN	●●			●			

DIN 1880	D _c js14 mm	L _c mm	d ₁ mm	Z	uncoated designation P020101	TiCN designation P0201016
Slot according to DIN 138	40	32	16	8	-40	-40
	50	36	22	8	-50	-50
	63	40	27	10	-63	-63
	80	45	27	10	-80	-80
	100	50	32	12	-100	-100

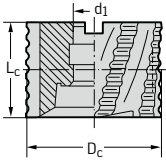

fine roughing teeth

**PCD porcupine cutter
F 4726**

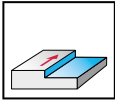

- κ = 90°
- WCD 10

	P	M	K	N	S	H	O
.D				●●			●

Tool

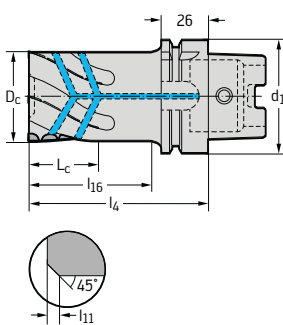

D _c mm	l ₁₁ mm	L _c mm	l ₁ mm	l ₄ mm	d ₁	Z	kg	designation
32	0,2	30	100	72	HSK-A63	2+2	1,1	F4726.H63A.032.Z04.30.D
40	0,2	40	100	72	HSK-A63	2+2	1,4	F4726.H63A.040.Z04.40.D
50	0,2	40	100	72	HSK-A63	2+2	1,8	F4726.H63A.050.Z04.40.D
63	0,2	40	100	72	HSK-A63	2+2	2,1	F4726.H63A.063.Z04.40.D

Pre-balanced to G 6.3 where n = 16000 rpm
Order example: F4726.H63A.032.Z04.30 . . with WCD 10 = F4726.H63A.032.Z04.30.D

Accessories

	Transfer unit for HSK	FS 1065	
	Socket wrench for HSK	FS 953	

.D = WCD 10

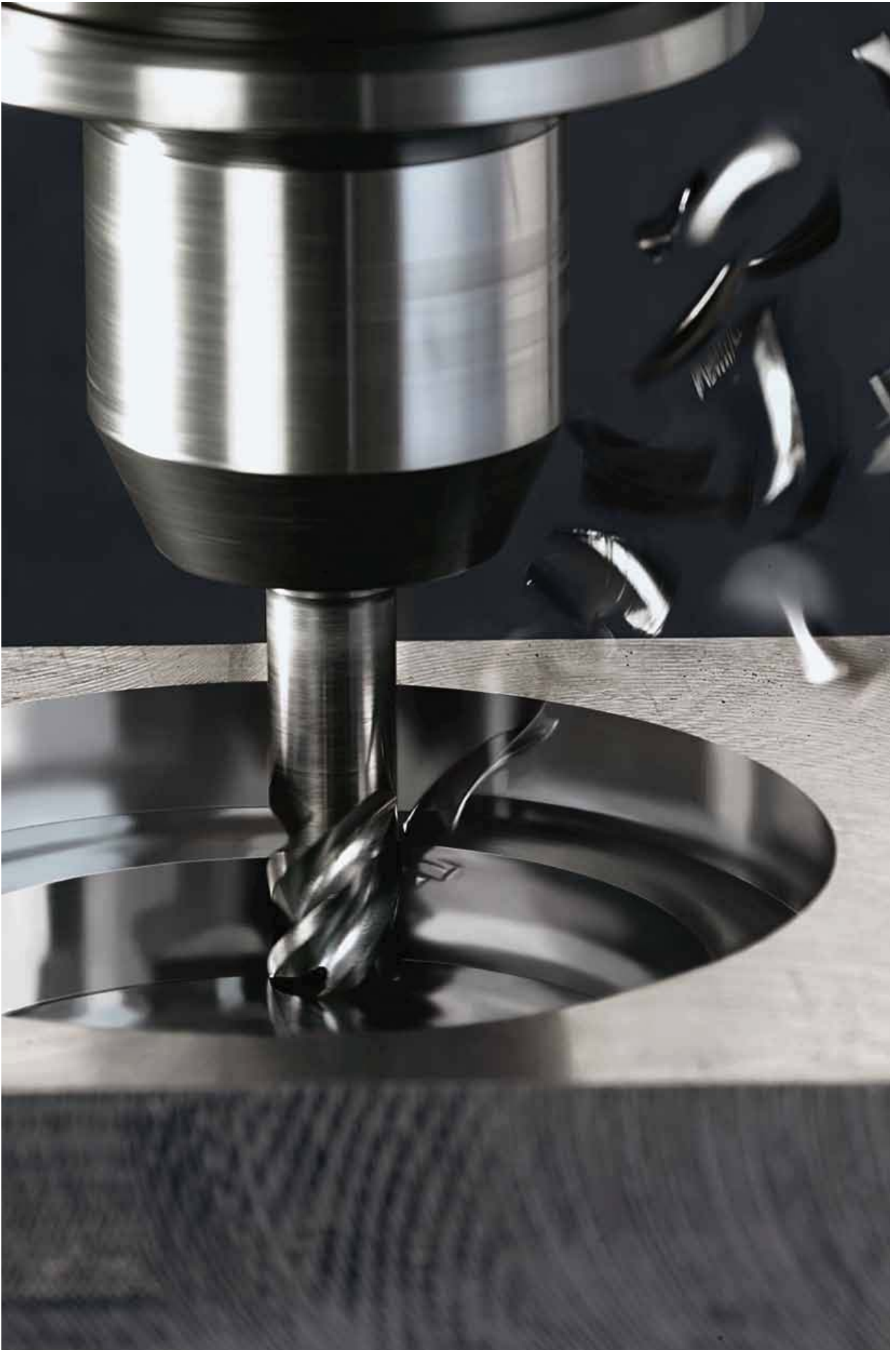

Walter Select – Copy milling

Solid carbide end mills

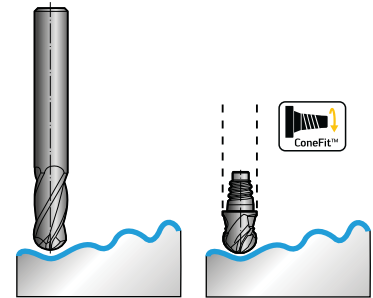
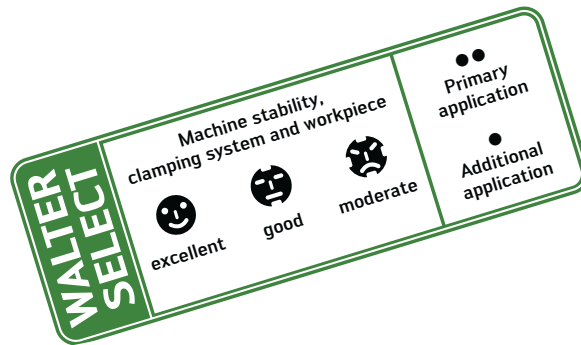
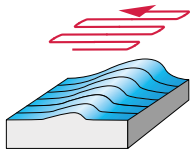

Solid carbide end mills

Material group	Classification of the main material groups and code letters		Workpiece material	Brinell hardness HB	Tensile strength R_m N/mm ²	Machining group	Machining conditions			
							Dia. range 1 – 25 Number of teeth 2 + 4 Coating TAX			
							Family	Designation	λ	Page
							ConeFit™ N 40	H8E11118 H8E01118	40° 40°	E 192 E 192
							30	H8001118 H8011118 H8111118	30° 30° 30°	E 194 E 193 E 193
P	Unalloyed and low-alloyed steel	annealed (tempered)	210	700	P1, P2, P3, P4, P7	●●				
		Free cutting steel	220	750	P6	●●				
		tempered	300	1010	P5, P8	●●				
		tempered	380	1280	P9	●●				
		tempered	430	1480	P10	●●				
	High-alloyed steel and high-alloyed tool steel	annealed	200	670	P11	●●				
		hardened and tempered	300	1010	P12	●●				
		hardened and tempered	400	1360	P13	●●				
	Stainless steel	ferritic / martensitic, annealed	200	670	P14	●●				
		martensitic, tempered	330	1110	P15	●●				
M	Stainless steel	austenitic, duplex	230	780	M1, M3	●				
		austenitic, precipitation hardened (PH)	300	1010	M2	●				
K	Grey cast iron		245	–	K3, K4	●				
	Cast iron with spheroidal graphite	ferritic, pearlitic	365	–	K1, K2, K5, K6	●				
	GGV (CGI)		200	–	K7	●				
N	Aluminium wrought alloys	cannot be hardened	30	–	N1	●				
		hardenable, hardened	100	340	N2	●				
	Cast aluminium alloys	≤ 12 % Si	90	310	N3, N4	●				
		> 12 % Si	130	450	N5	●				
	Magnesium alloys		70	250	N6	●				
	Copper and copper alloys (bronze / brass)	unalloyed, electrolytic copper	100	340	N7	●				
		Brass, bronze, red brass	90	310	N8	●				
		Cu-alloys, short-chipping	110	380	N9	●				
		high-strength, Ampco	300	1010	N10	●				
S	Heat-resistant alloys	Fe-based	280	940	S1, S2	●				
		Ni or Co base	250	840	S3	●				
		Ni or Co base	350	1080	S4, S5	●				
	Titanium alloys	Pure titanium	200	670	S6	●				
		α and β alloys, hardened	375	1260	S7	●				
		β alloys	410	1400	S8	●				
	Tungsten alloys		300	1010	S9	●				
	Molybdenum alloys		300	1010	S10	●				
H	Hardened steel		50 HRC	–	H1	●				
			55 HRC	–	H2, H4					
			60 HRC	–	H3					
O	Thermoplasts	without abrasive fillers			O1	●				
	Thermosetting plastics	without abrasive fillers			O2	●				
	Fibre-reinforced plastic	GFRP, AFRP			O3, O5					
		CFRP			O4					
	Graphite (technical)			65	O6					

Walter Select – Copy milling

Solid carbide end mills

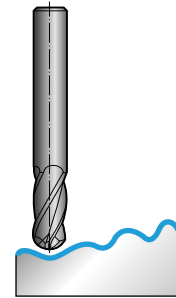
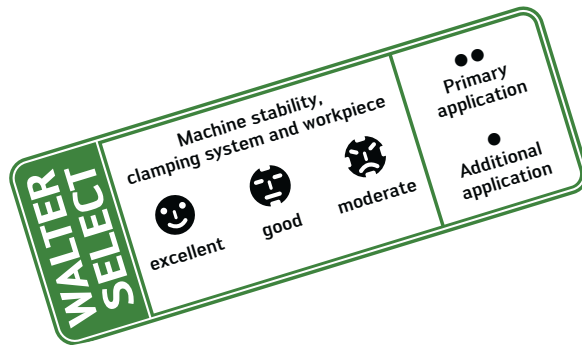
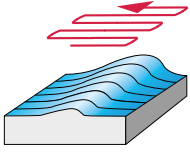

Solid carbide end mills

Material group		Classification of the main material groups and code letters	Workpiece material	Brinell hardness HB	Tensile strength R_m N/mm ²	Machining group	Machining conditions			
							Family	Designation	λ	Page
							Dia. range 1 – 20			
							Number of teeth 2			
							Coating uncoated			
							AL 30	H602111	30°	E 205
							30	H800111	30°	E 194
P	Unalloyed and low-alloyed steel	annealed (tempered)		210	700	P1, P2, P3, P4, P7				
		Free cutting steel		220	750	P6				
		tempered		300	1010	P5, P8				
		tempered		380	1280	P9				
		tempered		430	1480	P10				
	High-alloyed steel and high-alloyed tool steel	annealed		200	670	P11				
		hardened and tempered		300	1010	P12				
		hardened and tempered		400	1360	P13				
	Stainless steel	ferritic / martensitic, annealed		200	670	P14				
		martensitic, tempered		330	1110	P15				
M	Stainless steel	austenitic, duplex		230	780	M1, M3				
		austenitic, precipitation hardened (PH)		300	1010	M2				
K	Grey cast iron		245	–	K3, K4					
	Cast iron with spheroidal graphite	ferritic, pearlitic		365	–	K1, K2, K5, K6				
	GGV (CGI)		200	–	K7					
N	Aluminium wrought alloys	cannot be hardened		30	–	N1	••			
		hardenable, hardened		100	340	N2	••			
	Cast aluminium alloys	≤ 12 % Si		90	310	N3, N4	••			
		> 12 % Si		130	450	N5	••			
	Magnesium alloys		70	250	N6	••				
	Copper and copper alloys (bronze / brass)	unalloyed, electrolytic copper		100	340	N7	••			
Brass, bronze, red brass			90	310	N8	••				
Cu-alloys, short-chipping			110	380	N9	••				
high-strength, Ampco			300	1010	N10	••				
S	Heat-resistant alloys	Fe-based		280	940	S1, S2				
		Ni or Co base		250	840	S3				
		Ni or Co base		350	1080	S4, S5				
	Titanium alloys	Pure titanium		200	670	S6				
		α and β alloys, hardened		375	1260	S7				
		β alloys		410	1400	S8				
	Tungsten alloys		300	1010	S9					
Molybdenum alloys		300	1010	S10						
H	Hardened steel			50 HRC	–	H1				
				55 HRC	–	H2, H4				
				60 HRC	–	H3				
O	Thermoplasts	without abrasive fillers				O1	•			
	Thermosetting plastics	without abrasive fillers				O2	•			
	Fibre-reinforced plastic	GFRP, AFRP					O3, O5			
		CFRP					O4			
Graphite (technical)				65	O6					

Walter Select – Copy milling

Solid carbide end mills

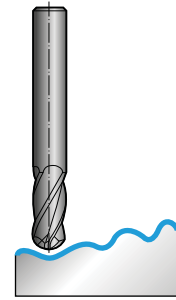
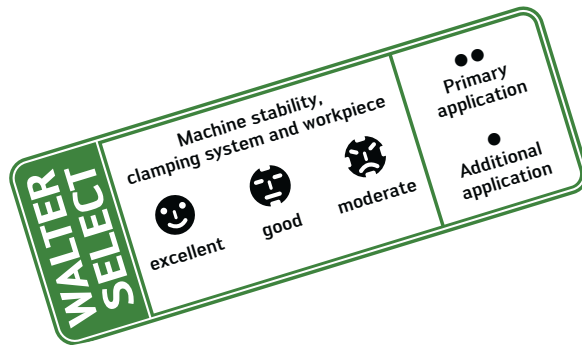
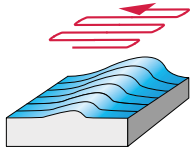
Solid carbide end mills

Machining conditions	☺			
Dia. range	0,3 – 3			
Number of teeth	2			
Coating	uncoated			
	Family	Designation	λ	Page

Material group	Classification of the main material groups and code letters		Brinell hardness HB	Tensile strength R_m N/mm ²	Machining group	Mini	Designation	λ	Page
	Workpiece material					HSC 30	H404691	30°	E 207
P	Unalloyed and low-alloyed steel	annealed (tempered)	210	700	P1, P2, P3, P4, P7				
		Free cutting steel	220	750	P6				
		tempered	300	1010	P5, P8				
		tempered	380	1280	P9				
		tempered	430	1480	P10				
	High-alloyed steel and high-alloyed tool steel	annealed	200	670	P11				
hardened and tempered		300	1010	P12					
hardened and tempered		400	1360	P13					
Stainless steel	ferritic / martensitic, annealed	200	670	P14					
	martensitic, tempered	330	1110	P15					
M	Stainless steel	austenitic, duplex	230	780	M1, M3				
		austenitic, precipitation hardened (PH)	300	1010	M2				
K	Grey cast iron		245	–	K3, K4				
	Cast iron with spheroidal graphite	ferritic, pearlitic	365	–	K1, K2, K5, K6				
	GGV (CGI)		200	–	K7				
N	Aluminium wrought alloys	cannot be hardened	30	–	N1		●●		
		hardenable, hardened	100	340	N2		●●		
	Cast aluminium alloys	≤ 12 % Si	90	310	N3, N4		●●		
		> 12 % Si	130	450	N5		●●		
	Magnesium alloys		70	250	N6		●●		
	Copper and copper alloys (bronze / brass)	unalloyed, electrolytic copper		100	340	N7		●●	
Brass, bronze, red brass			90	310	N8		●●		
Cu-alloys, short-chipping			110	380	N9		●●		
high-strength, Ampco			300	1010	N10		●●		
S	Heat-resistant alloys	Fe-based	280	940	S1, S2				
		Ni or Co base	250	840	S3				
		Ni or Co base	350	1080	S4, S5				
	Titanium alloys	Pure titanium	200	670	S6				
		α and β alloys, hardened	375	1260	S7				
		β alloys	410	1400	S8				
Tungsten alloys		300	1010	S9					
Molybdenum alloys		300	1010	S10					
H	Hardened steel		50 HRC	–	H1				
			55 HRC	–	H2, H4				
			60 HRC	–	H3				
O	Thermoplasts	without abrasive fillers			O1		●		
	Thermosetting plastics	without abrasive fillers			O2		●		
	Fibre-reinforced plastic	GFRP, AFRP			O3, O5				
		CFRP			O4				
Graphite (technical)			65	O6					

Ball-nose end mill Protostar® N 40



Materials to 48 HRC

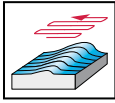

- solid carbide
- 2 to 4 cutting edges
- with centre cut
- 40° helix angle

	P	M	K	N	S	H	O
TAX	●	●	●	●			

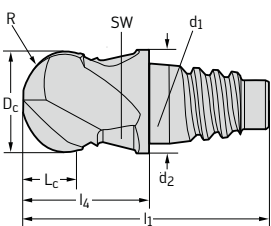
P standard	D _c h9 mm	R mm	L _c mm	d ₂ mm	l ₁ mm	l ₄ mm	SW mm	d ₁	Z	TAX designation H8E01118
ConeFit™ 	10	5	5,5	9,7	23,6	12,4	8	E 10	2	-E10-10
	12	6	6,5	11,7	28,3	14,5	10	E 12	2	-E12-12
	16	8	8,5	15,5	35,7	18,7	12	E 16	2	-E16-16
	20	10	11	19,3	40,8	21,3	16	E 20	2	-E20-20
	25	12,5	13,5	24,2	49,6	25,6	20	E 25	2	-E25-25

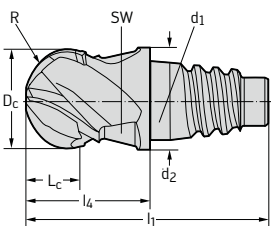
P standard	D _c h9 mm	R mm	L _c mm	d ₂ mm	l ₁ mm	l ₄ mm	SW mm	d ₁	Z	TAX designation H8E11118
ConeFit™ 	10	5	5,5	9,7	23,6	12,4	8	E 10	4	-E10-10
	12	6	6,5	11,7	28,3	14,5	10	E 12	4	-E12-12
	16	8	8,5	15,5	35,7	18,7	12	E 16	4	-E16-16
	20	10	11	19,3	40,8	21,3	16	E 20	4	-E20-20
	25	12,5	13,5	24,2	49,6	25,6	20	E 25	4	-E25-25

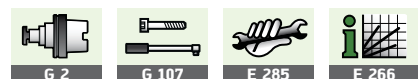

Ball-nose end mill Protostar® 30



Materials to 48 HRC

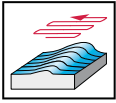

- solid carbide
- 4 cutting edges
- with centre cut
- 30° helix angle

	P	M	K	N	S	H	O
TAX	●●	●	●	●			

P standard L	D _c h7 mm	R mm	L _c mm	l ₁ mm	l ₄ mm	d ₁ h5 mm	Z	TAX designation H8011118
Shank DIN 6535 HA	3	1,5	8	80	44	6	4	-3
	4	2	11	80	44	6	4	-4
	5	2,5	13	80	44	6	4	-5
	6	3	13	80	44	6	4	-6
	7	3,5	16	100	64	8	4	-7
	8	4	19	100	64	8	4	-8
	9	4,5	19	100	60	10	4	-9
	10	5	22	100	60	10	4	-10
	12	6	26	100	55	12	4	-12
	16	8	32	100	52	16	4	-16
	20	10	38	125	75	20	4	-20

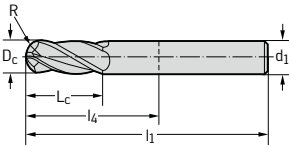

P standard L	D _c h7 mm	R mm	L _c mm	l ₁ mm	l ₄ mm	d ₁ h5 mm	Z	TAX designation H8111118
Shank DIN 6535 HB	3	1,5	8	80	44	6	4	-3
	4	2	11	80	44	6	4	-4
	5	2,5	13	80	44	6	4	-5
	6	3	13	80	44	6	4	-6
	8	4	19	100	64	8	4	-8
	10	5	22	100	60	10	4	-10
	12	6	26	100	55	12	4	-12
	16	8	32	100	52	16	4	-16
	20	10	38	125	75	20	4	-20

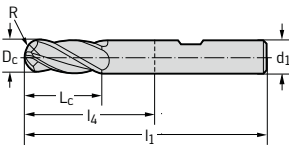

Ball-nose end mill Protostar® 30



Materials to 48 HRC

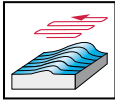

- solid carbide
- 2 cutting edges
- with centre cut
- 30° helix angle

	P	M	K	N	S	H	O
uncoated				●●			
TAX	●●	●		●			

DIN 6527 L

Shank DIN 6535 HA

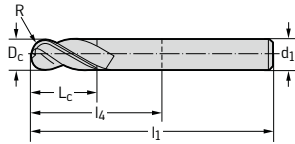

	D _c h7 mm	R mm	L _c mm	l ₁ mm	l ₄ mm	d ₁ h5 mm	Z	uncoated designation H800111	TAX designation H800118
	1	0,5	3	38	10	3	2	-1	-1
	1,5	0,75	3	38	10	3	2	-1.5	-1.5
	2	1	6	38	10	3	2	-2	-2
	2,5	1,25	7	38	10	3	2	-2.5	-2.5
	3	1,5	7	38	10	3	2	-3	-3
	4	2	8	57	21	6	2	-4	-4
	5	2,5	10	57	21	6	2	-5	-5
	6	3	10	57	21	6	2	-6	-6
	7	3,5	13	63	27	8	2	-7	-7
	8	4	16	63	27	8	2	-8	-8
	9	4,5	16	72	32	10	2	-9	-9
	10	5	19	72	32	10	2	-10	-10
	12	6	22	83	38	12	2	-12	-12
	14	7	22	83	38	14	2	-14	-14
	16	8	26	92	44	16	2	-16	-16
	18	9	26	92	44	18	2	-18	-18
	20	10	32	104	54	20	2	-20	-20

Ball-nose end mill Protostar® 30



Specially for graphite

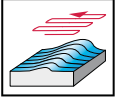

- solid carbide
- 2 cutting edges
- with centre cut
- 30° helix angle

	P	M	K	N	S	H	O
DIA							●●

DIN 6527 L	D _c h8 mm	R mm	L _c mm	l ₁ mm	l ₄ mm	d ₁ h5 mm	Z	DIA designation H8001119
Shank DIN 6535 HA	1	0,5	3	38	10	3	2	-1
	1,5	0,75	3	38	10	3	2	-1.5
	2	1	6	38	10	3	2	-2
	2,5	1,25	7	38	10	3	2	-2.5
	3	1,5	7	38	10	3	2	-3
	4	2	8	57	21	6	2	-4
	5	2,5	10	57	21	6	2	-5
	6	3	10	57	21	6	2	-6
	8	4	16	63	27	8	2	-8
	10	5	19	72	32	10	2	-10
	12	6	22	83	38	12	2	-12

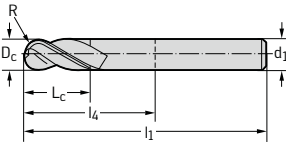

Ball-nose end mill Protostar® HSC 30



Materials to 55 HRC

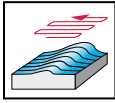

- solid carbide
- long reach
- 2 to 4 cutting edges
- with centre cut
- 30° helix angle

	P	M	K	N	S	H	O
TAX	●●			●			

P standard XL

Shank DIN 6535 HA

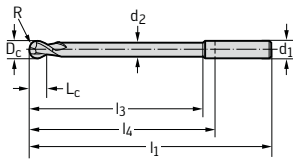

D_c h7 mm	R mm	L_c mm	l_3 mm	d_2 mm	l_1 mm	l_4 mm	d_1 h5 mm	Z	TAX designation H8001918
4	2	4	20	3,9	100	64	6	2	-4-20
4	2	4	30	3,9	100	64	6	2	-4-30
4	2	4	40	3,9	100	64	6	2	-4-40
5	2,5	5	25	4,9	100	64	6	2	-5-25
5	2,5	5	50	4,9	100	64	6	2	-5-50
6	3	6	30	5,9	100	64	6	4	-6-30
6	3	6	45	5,9	100	64	6	4	-6-45
6	3	6	60	5,9	100	64	6	4	-6-60
8	4	8	40	7,85	120	84	8	4	-8-40
8	4	8	60	7,85	120	84	8	4	-8-60
8	4	8	80	7,85	120	84	8	4	-8-80
10	5	10	50	9,85	150	110	10	4	-10-50
10	5	10	75	9,85	150	110	10	4	-10-75
12	6	12	60	11,8	150	105	12	4	-12-60

Ball-nose end mill Protostar® HSC 30



Materials to 55 HRC

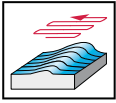

- solid carbide
- long reach
- 2 to 4 cutting edges
- with centre cut
- 30° helix angle

	P	M	K	N	S	H	O
TAX	●●			●			

P standard L	D _c h7 mm	R mm	L _c mm	L _{c2} mm	l ₃ mm	d ₂ mm	l ₁ mm	l ₄ mm	d ₁ h5 mm	Z	TAX designation H8006418
Shank DIN 6535 HA	1	0,5	2	-	20	-	75	39	6	2	-1
	2	1	3	1,5	20	1,7	75	39	6	2	-2
	3	1,5	4	1,5	30	2,5	80	44	6	2	-3
	4	2	5	1,5	30	3,3	80	44	6	2	-4
	5	2,5	7	2	43	4,1	80	44	6	2	-5
	6	3	7	2	30	4,7	100	64	6	2	-6
	8	4	9	3	36	6,5	100	64	8	2	-8
	10	5	11	3	43	8,2	100	60	10	2	-10

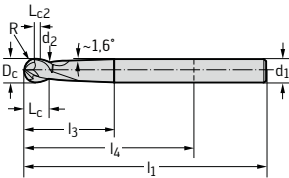

P standard L	D _c h7 mm	R mm	L _c mm	L _{c2} mm	l ₃ mm	d ₂ mm	l ₁ mm	l ₄ mm	d ₁ h5 mm	Z	TAX designation H8016418
Shank DIN 6535 HA	5	2,5	7	2	43	4,1	80	44	6	4	-5
	6	3	7	2	30	4,7	100	64	6	4	-6
	8	4	9	3	36	6,5	100	64	8	4	-8
	10	5	11	3	43	8,2	100	60	10	4	-10
	12	6	13	3	52	9,8	100	55	12	4	-12
	16	8	15	3	61	13,4	150	102	16	4	-16 ¹

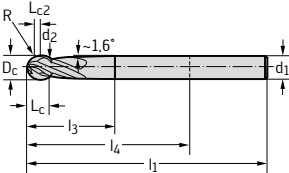

with back cutting
¹Shank tolerance h6

Ball-nose end mill Protostar® HSC 30



Specially for graphite

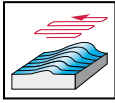

- solid carbide
- long reach
- 2 to 4 cutting edges
- with centre cut
- 30° helix angle

	P	M	K	N	S	H	O
DIA							●●

P standard XL

Shank DIN 6535 HA

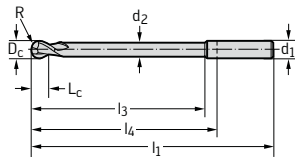

D_c h8 mm	R mm	L_c mm	l_3 mm	d_2 mm	l_1 mm	l_4 mm	d_1 h5 mm	Z	DIA designation H8001919
4	2	4	20	3,9	100	64	6	2	-4-20
4	2	4	30	3,9	100	64	6	2	-4-30
4	2	4	40	3,9	100	64	6	2	-4-40
5	2,5	5	25	4,9	100	64	6	2	-5-25
5	2,5	5	50	4,9	100	64	6	2	-5-50
6	3	6	30	5,9	100	64	6	4	-6-30
6	3	6	45	5,9	100	64	6	4	-6-45
6	3	6	60	5,9	100	64	6	4	-6-60
8	4	8	40	7,85	120	84	8	4	-8-40
8	4	8	60	7,85	120	84	8	4	-8-60
8	4	8	80	7,85	120	84	8	4	-8-80
10	5	10	50	9,85	150	110	10	4	-10-50
10	5	10	75	9,85	150	110	10	4	-10-75
12	6	12	60	11,8	150	105	12	4	-12-60
12	6	12	90	11,8	150	105	12	4	-12-90

Ball-nose end mill Protostar® HSC 30



Specially for graphite

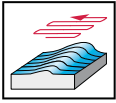

- solid carbide
- long reach
- 2 to 4 cutting edges
- with centre cut
- 30° helix angle

	P	M	K	N	S	H	O
DIA							●●

P standard L	D _c h8 mm	R mm	L _c mm	L _{c2} mm	l ₃ mm	d ₂ mm	l ₁ mm	l ₄ mm	d ₁ h5 mm	Z	DIA designation H8006419
Shank DIN 6535 HA	1	0,5	2	-	20	-	75	39	6	2	-1
	2	1	3	1,5	20	1,7	75	39	6	2	-2
	3	1,5	4	1,5	30	2,5	80	44	6	2	-3
	4	2	5	1,5	30	3,3	80	44	6	2	-4
	5	2,5	7	2	43	4,1	80	44	6	2	-5
	6	3	7	2	30	4,7	100	64	6	2	-6
	8	4	9	3	36	6,5	100	64	8	2	-8
	10	5	11	3	43	8,2	100	60	10	2	-10

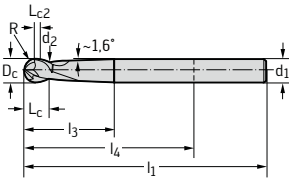

P standard L	D _c h8 mm	R mm	L _c mm	L _{c2} mm	l ₃ mm	d ₂ mm	l ₁ mm	l ₄ mm	d ₁ h5 mm	Z	DIA designation H8016419
Shank DIN 6535 HA	5	2,5	7	2	43	4,1	80	44	6	4	-5-43
	6	3	7	2	30	4,7	100	64	6	4	-6-30
	8	4	9	3	36	6,5	100	64	8	4	-8-36
	10	5	11	3	43	8,2	100	60	10	4	-10-43
	12	6	13	3	52	9,8	100	55	12	4	-12-52

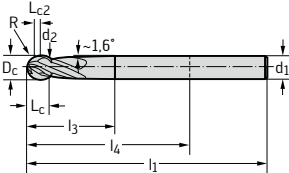

with back cutting

Ball-nose end mill Protostar® HSC 30 Ultra



Materials from 48 to 63 HRC

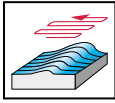

- solid carbide
- long reach
- 2 cutting edges
- with centre cut
- 30° helix angle

	P	M	K	N	S	H	O
TAX						●●	

DIN 6527 L	D _c h7 mm	R mm	L _c mm	l ₃ mm	d ₂ mm	l ₁ mm	l ₄ mm	d ₁ h5 mm	Z	TAX designation H8004028
Shank DIN 6535 HA	5	2,5	5	20	4,9	57	21	6	2	-5
	6	3	6	24	5,9	63	27	8	2	-6
	8	4	8	29	7,85	72	32	10	2	-8
	10	5	10	35	9,85	83	38	12	2	-10
	12	6	12	36	11,8	83	38	12	2	-12
	16	8	16	42	15,8	92	44	16	2	-16

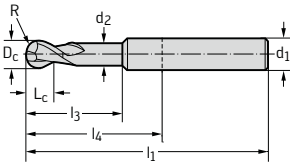

P standard L	D _c h7 mm	R mm	L _c mm	l ₃ mm	d ₂ mm	l ₁ mm	l ₄ mm	d ₁ h5 mm	Z	TAX designation H8004128
Shank DIN 6535 HA	6	3	6	-	-	57	21	6	2	-6-57
	6	3	6	-	-	80	44	6	2	-6-80
	8	4	8	-	-	63	27	8	2	-8-63
	8	4	8	-	-	100	64	8	2	-8-100
	10	5	10	-	-	72	32	10	2	-10-72
	10	5	10	-	-	100	60	10	2	-10-100
	12	6	12	-	-	83	38	12	2	-12-83
	12	6	12	-	-	100	55	12	2	-12-100
	16	8	16	-	-	125	77	16	2	-16-125

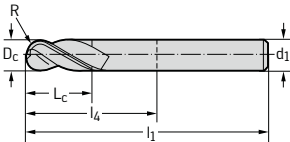

Ball-nose end mill Protostar® HSC 30 Ultra



Materials from 48 to 63 HRC

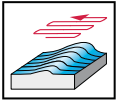

- solid carbide
- long reach
- 2 cutting edges
- with centre cut
- 30° helix angle

	P	M	K	N	S	H	O
TAX						●●	

P standard XL	D _c h7 mm	R mm	L _c mm	l ₃ mm	α	l ₁ mm	l ₄ mm	d ₁ h5 mm	Z	TAX designation H8004728
Shank DIN 6535 HA 	1	0,5	1	17,55	2,5	57	21	6	2	-1-2.5-57
	1	0,5	1	17,55	2,5	57	21	6	2	-1-4-57
	1	0,5	1	36,4	4	80	44	6	2	-1-2.5-80
	1,5	0,75	1,5	17,55	2,5	57	21	6	2	-1.5-2.5-57
	1,5	0,75	1,5	17,55	4	57	21	6	2	-1.5-4-57
	2	1	2	18,25	2,5	57	21	6	2	-2-4-57
	2	1	2	18,25	2,5	57	21	6	2	-2-2.5-57
	2	1	2	39,75	4	80	44	6	2	-2-2.5-80
	2,5	1,25	2,5	18,75	2,5	57	21	6	2	-2.5-2.5-57
	2,5	1,25	2,5	18,75	4	57	21	6	2	-2.5-4-57
	3	1,5	3	19	2,5	57	21	6	2	-3-2.5-57
	3	1,5	3	19	2,5	57	21	6	2	-3-4-57
	3	1,5	3	38,4	4	80	44	6	2	-3-2.5-80
	4	2	4	20	2,5	57	21	6	2	-4-2.5-57
	4	2	4	20	2,5	57	21	6	2	-4-4-57
	4	2	4	30	4	80	44	6	2	-4-10-80
4	2	4	27,9	10	80	44	6	2	-4-2.5-80	
5	2,5	4	34,8	10	80	44	6	2	-5-10-80	

Ball-nose end mill Protostar® HSC 30 Ultra



Materials from 48 to 63 HRC

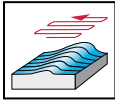

- solid carbide
- long reach
- 2 to 4 cutting edges
- with centre cut
- 30° helix angle

	P	M	K	N	S	H	O
TAX						●●	

P standard L	D _c h7 mm	R mm	L _c mm	L _{c2} mm	l ₃ mm	d ₂ mm	l ₁ mm	l ₄ mm	d ₁ h5 mm	Z	TAX designation H8006428
Shank DIN 6535 HA	1	0,5	2	-	20	-	75	39	6	2	-1
	2	1	3	1,5	20	1,7	75	39	6	2	-2
	3	1,5	4	1,5	30	2,5	80	44	6	2	-3
	4	2	5	1,5	30	3,3	80	44	6	2	-4
	5	2,5	7	2	43	4,1	80	44	6	2	-5
	6	3	7	2	30	4,7	100	64	6	2	-6
	8	4	9	3	36	6,5	100	64	8	2	-8
	10	5	11	3	43	8,2	100	60	10	2	-10
	12	6	13	3	52	9,8	100	55	12	2	-12
	16	8	15	3	61	13,4	150	102	16	2	-16

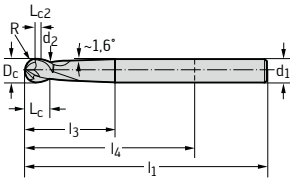

P standard L	D _c h7 mm	R mm	L _c mm	L _{c2} mm	l ₃ mm	d ₂ mm	l ₁ mm	l ₄ mm	d ₁ h5 mm	Z	TAX designation H8016428
Shank DIN 6535 HA	5	2,5	7	2	43	4,1	80	44	6	4	-5
	6	3	7	2	30	4,7	100	64	6	4	-6
	8	4	9	3	36	6,5	100	64	8	4	-8
	10	5	11	3	43	8,2	100	60	10	4	-10
	12	6	13	3	52	9,8	100	55	12	4	-12
	16	8	15	3	61	13,4	150	102	16	4	-16

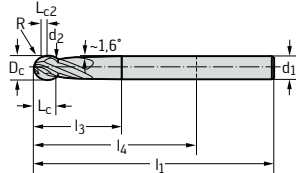

with back cutting

Ball-nose end mill Protostar® HSC 30 Ultra



Materials from 48 to 63 HRC

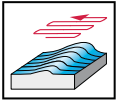

- solid carbide
- long reach
- 2 to 4 cutting edges
- with centre cut
- 30° helix angle

	P	M	K	N	S	H	O
TAX						●●	

DIN 6527 L	D _c h7 mm	R mm	L _c mm	l ₃ mm	d ₂ mm	l ₁ mm	l ₄ mm	d ₁ h5 mm	Z	TAX designation H8014028
Shank DIN 6535 HA	6	3	6	24	5,9	63	27	8	4	-6
	8	4	8	29	7,85	72	32	10	4	-8
	10	5	10	35	9,85	83	38	12	4	-10
	12	6	12	36	11,8	83	38	12	4	-12
	16	8	16	42	15,8	92	44	16	4	-16

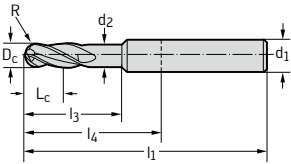

P standard L	D _c h7 mm	R mm	L _c mm	l ₃ mm	α	l ₁ mm	l ₄ mm	d ₁ h5 mm	Z	TAX designation H8074128
Shank DIN 6535 HA	3	1,5	3	5	10°	57	21	6	2	-3
	4	2	4	6	10°	80	44	6	2	-4
	6	3	6	-	-	80	44	6	2	-6
	8	4	8	-	-	100	64	8	2	-8
	10	5	10	-	-	100	60	10	2	-10

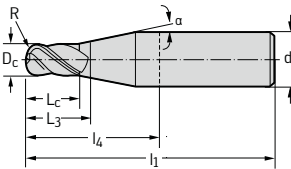

particularly suitable for finishing

Ball-nose end mill Protostar® HSC 30 Ultra



Materials from 48 to 63 HRC

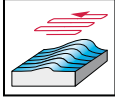

- solid carbide
- 4 cutting edges
- with centre cut
- 30° helix angle

	P	M	K	N	S	H	O
TAX						●●	

P standard L	D _c h7 mm	R mm	L _c mm	l ₁ mm	l ₄ mm	d ₁ h5 mm	Z	TAX designation H8014128
Shank DIN 6535 HA	6	3	6	57	21	6	4	-6-57
	6	3	6	80	44	6	4	-6-80
	8	4	8	63	27	8	4	-8-63
	8	4	8	100	64	8	4	-8-100
	10	5	10	72	32	10	4	-10-72
	10	5	10	100	60	10	4	-10-100
	12	6	12	83	38	12	4	-12-83
	12	6	12	100	55	12	4	-12-100
	16	8	16	125	77	16	4	-16-125

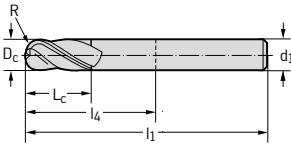

Ball-nose end mill Protostar® AL 30

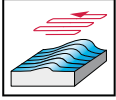

- solid carbide
- 2 cutting edges
- with centre cut
- 30° helix angle

	P	M	K	N	S	H	O
uncoated				●●			

P standard L	D _c h9 mm	R mm	L _c mm	l ₁ mm	l ₄ mm	d ₁ h5 mm	Z	uncoated designation H602111
Shank DIN 6535 HA	2	1	6	60	32	3	2	-2
	3	1,5	7	80	44	6	2	-3
	4	2	8	80	44	6	2	-4
	5	2,5	10	80	44	6	2	-5
	6	3	10	80	44	6	2	-6
	8	4	16	100	64	8	2	-8
	10	5	19	100	60	10	2	-10
	12	6	22	100	55	12	2	-12 ¹
	16	8	26	100	52	16	2	-16 ¹

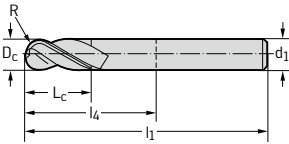

¹Shank tolerance h6

Mini ball-nose end mill Protostar® HSC 30



Materials to 48 HRC

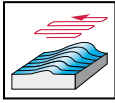

- solid carbide
- long reach
- 2 cutting edges
- with centre cut
- 30° helix angle

	P	M	K	N	S	H	O
uncoated				●●			
TAX	●●			●			

P standard mini

Shank DIN 6535 HA

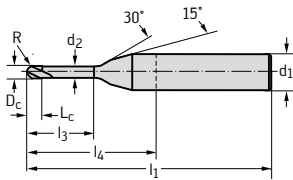

D _c h7 mm	R mm	L _c mm	l ₃ mm	d ₂ mm	l ₁ mm	l ₄ mm	d ₁ h5 mm	Z	uncoated designation H404691	TAX designation H4046918
0,3	0,15	0,3	0,75	0,27	38	10	3	2	-0.3-0.75	-0.3-0.75
0,3	0,15	0,3	1,5	0,27	38	10	3	2	-0.3-1.5	-0.3-1.5
0,3	0,15	0,3	3	0,27	38	10	3	2	-0.3-3	-0.3-3
0,4	0,2	0,4	1	0,37	38	10	3	2	-0.4-1	-0.4-1
0,4	0,2	0,4	2	0,37	38	10	3	2	-0.4-2	-0.4-2
0,4	0,2	0,4	4	0,37	38	10	3	2	-0.4-4	-0.4-4
0,5	0,25	0,5	1,25	0,47	38	10	3	2	-0.5-1.25	-0.5-1.25
0,5	0,25	0,5	2,5	0,47	38	10	3	2	-0.5-2.5	-0.5-2.5
0,5	0,25	0,5	5	0,47	38	10	3	2	-0.5-5	-0.5-5
0,6	0,3	0,6	1,5	0,57	38	10	3	2	-0.6-1.5	-0.6-1.5
0,6	0,3	0,6	3	0,57	38	10	3	2	-0.6-3	-0.6-3
0,6	0,3	0,6	6	0,57	38	10	3	2	-0.6-6	-0.6-6
0,6	0,3	0,6	9	0,57	38	10	3	2	-0.6-9	-0.6-9
0,8	0,4	0,8	2	0,77	38	10	3	2	-0.8-2	-0.8-2
0,8	0,4	0,8	4	0,77	38	10	3	2	-0.8-4	-0.8-4
0,8	0,4	0,8	6	0,77	38	10	3	2	-0.8-6	-0.8-6
0,8	0,4	0,8	8	0,77	38	10	3	2	-0.8-8	-0.8-8
0,8	0,4	0,8	12	0,77	60	32	3	2	-0.8-12	-0.8-12
1	0,5	1	2,5	0,97	38	10	3	2	-1-2.5	-1-2.5
1	0,5	1	5	0,97	60	32	3	2	-1-5	-1-5
1	0,5	1	7,5	0,97	60	32	3	2	-1-7.5	-1-7.5
1	0,5	1	10	0,97	60	32	3	2	-1-10	-1-10
1	0,5	1	15	0,97	60	32	3	2	-1-15	-1-15
1	0,5	1	20	0,97	60	32	3	2	-1-20	-1-20
1,5	0,75	1,5	7,5	1,47	60	32	3	2	-1.5-7.5	-1.5-7.5
1,5	0,75	1,5	15	1,47	60	32	3	2	-1.5-15	-1.5-15
2	1	2	10	1,97	60	32	3	2	-2-10	-2-10
2	1	2	15	1,97	60	32	3	2	-2-15	-2-15
2	1	2	20	1,97	60	32	3	2	-2-20	-2-20
2	1	2	30	1,97	60	32	3	2	-2-30	-2-30
2,5	1,25	2,5	12,5	2,47	60	32	3	2	-2.5-12.5	-2.5-12.5
2,5	1,25	2,5	25	2,47	60	32	3	2	-2.5-25	-2.5-25
3	1,5	3	15	2,97	60	32	3	2	-3-15	-3-15
3	1,5	3	22,5	2,97	60	32	3	2	-3-22.5	-3-22.5
3	1,5	3	30	2,97	60	32	3	2	-3-30	-3-30

Mini ball-nose end mill Protostar® HSC 30



Specially for graphite

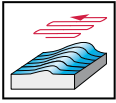

- solid carbide
- long reach
- 2 cutting edges
- with centre cut
- 30° helix angle

	P	M	K	N	S	H	O
DIA							●●

P standard mini	D _c h8 mm	R mm	L _c mm	l ₃ mm	d ₂ mm	l ₁ mm	l ₄ mm	d ₁ h5 mm	Z	DIA designation H4046919
Shank DIN 6535 HA	0,3	0,15	0,3	0,75	0,27	38	10	3	2	-0.3-0.75
	0,3	0,15	0,3	1,5	0,27	38	10	3	2	-0.3-1.5
	0,3	0,15	0,3	3	0,27	38	10	3	2	-0.3-3
	0,4	0,2	0,4	1	0,37	38	10	3	2	-0.4-1
	0,4	0,2	0,4	2	0,37	38	10	3	2	-0.4-2
	0,4	0,2	0,4	4	0,37	38	10	3	2	-0.4-4
	0,5	0,25	0,5	1,25	0,47	38	10	3	2	-0.5-1.25
	0,5	0,25	0,5	2,5	0,47	38	10	3	2	-0.5-2.5
	0,5	0,25	0,5	5	0,47	38	10	3	2	-0.5-5
	0,6	0,3	0,6	1,5	0,57	38	10	3	2	-0.6-1.5
	0,6	0,3	0,6	3	0,57	38	10	3	2	-0.6-3
	0,6	0,3	0,6	6	0,57	38	10	3	2	-0.6-6
	0,6	0,3	0,6	9	0,57	38	10	3	2	-0.6-9
	0,8	0,4	0,8	2	0,77	38	10	3	2	-0.8-2
	0,8	0,4	0,8	4	0,77	38	10	3	2	-0.8-4
	0,8	0,4	0,8	6	0,77	38	10	3	2	-0.8-6
	0,8	0,4	0,8	8	0,77	38	10	3	2	-0.8-8
	0,8	0,4	0,8	12	0,77	60	32	3	2	-0.8-12
	1	0,5	1	2,5	0,97	38	10	3	2	-1-2.5
	1	0,5	1	5	0,97	60	32	3	2	-1-5
	1	0,5	1	7,5	0,97	60	32	3	2	-1-7.5
	1	0,5	1	10	0,97	60	32	3	2	-1-10
	1	0,5	1	15	0,97	60	32	3	2	-1-15
	1	0,5	1	20	0,97	60	32	3	2	-1-20
	1,5	0,75	1,5	7,5	1,47	60	32	3	2	-1.5-7.5
	1,5	0,75	1,5	15	1,47	60	32	3	2	-1.5-15
	2	1	2	10	1,97	60	32	3	2	-2-10
	2	1	2	15	1,97	60	32	3	2	-2-15
	2	1	2	20	1,97	60	32	3	2	-2-20
	2	1	2	30	1,97	60	32	3	2	-2-30
	2,5	1,25	2,5	12,5	2,47	60	32	3	2	-2.5-12.5
	2,5	1,25	2,5	25	2,47	60	32	3	2	-2.5-25
	3	1,5	3	15	2,97	60	32	3	2	-3-15
	3	1,5	3	22,5	2,97	60	32	3	2	-3-22.5
	3	1,5	3	30	2,97	60	32	3	2	-3-30

Shank DIN 6535 HA

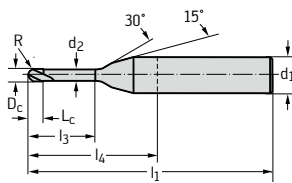

Mini ball-nose end mill Protostar® HSC 30 Ultra



Materials from 48 to 63 HRC

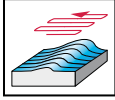

- solid carbide
- long reach
- 2 cutting edges
- with centre cut
- 30° helix angle

	P	M	K	N	S	H	O
TAX						●●	

P standard mini

Shank DIN 6535 HA

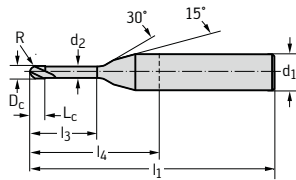

D_c h7 mm	R mm	L_c mm	l_3 mm	d_2 mm	l_1 mm	l_4 mm	d_1 h5 mm	Z	TAX designation H4046928
0,3	0,15	0,3	0,75	0,27	38	10	3	2	-0.3-0.75
0,4	0,2	0,4	1	0,37	38	10	3	2	-0.4-1
0,4	0,2	0,4	2	0,37	38	10	3	2	-0.4-2
0,5	0,25	0,5	1,25	0,47	38	10	3	2	-0.5-1.25
0,5	0,25	0,5	2,5	0,47	38	10	3	2	-0.5-2.5
0,5	0,25	0,5	3,75	0,47	38	10	3	2	-0.5-3.75
0,6	0,3	0,6	1,5	0,57	38	10	3	2	-0.6-1.5
0,6	0,3	0,6	3	0,57	38	10	3	2	-0.6-3
0,6	0,3	0,6	4,5	0,57	38	10	3	2	-0.6-4.5
0,8	0,4	0,8	2	0,77	38	10	3	2	-0.8-2
0,8	0,4	0,8	4	0,77	38	10	3	2	-0.8-4
0,8	0,4	0,8	6	0,77	38	10	3	2	-0.8-6
1	0,5	1	2,5	0,97	38	10	3	2	-1-2.5
1	0,5	1	5	0,97	60	32	3	2	-1-5
1	0,5	1	7,5	0,97	60	32	3	2	-1-7.5
1,5	0,75	1,5	4	1,47	38	10	3	2	-1.5-4
1,5	0,75	1,5	7,5	1,47	60	32	3	2	-1.5-7.5
1,5	0,75	1,5	12	1,47	60	32	3	2	-1.5-12
2	1	2	5	1,97	38	10	3	2	-2-5
2	1	2	10	1,97	60	32	3	2	-2-10
2	1	2	15	1,97	60	32	3	2	-2-15
2,5	1,25	2,5	6	2,47	38	10	3	2	-2.5-6
2,5	1,25	2,5	12,5	2,47	60	32	3	2	-2.5-12.5
2,5	1,25	2,5	20	2,47	60	32	3	2	-2.5-20
3	1,5	3	7,5	2,97	38	10	3	2	-3-7.5
3	1,5	3	15	2,97	60	32	3	2	-3-15
3	1,5	3	22,5	2,97	60	32	3	2	-3-22.5

Ball-nose end mill Protostar® 30

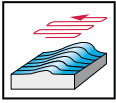

- HSS-E Co8
- 2 cutting edges
- with centre cut
- 30° helix angle

	P	M	K	N	S	H	O
uncoated	●	●	●	●●	●		

P standard	D _c e8 mm	R mm	L _c mm	l ₁ mm	l ₄ mm	d ₁ h6 mm	Z	uncoated designation P312674
Shank DIN 1835 B	3	1,5	8	56	20	6	2	-3
	4	2	11	63	27	6	2	-4
	5	2,5	13	68	32	6	2	-5
	6	3	13	68	32	6	2	-6
	8	4	19	88	48	10	2	-8
	10	5	22	95	55	10	2	-10
	12	6	26	110	65	12	2	-12

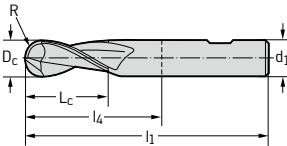

Ball-nose end mill Protostar® 30

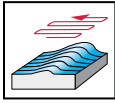

- HSS-E Co8
- 2 cutting edges
- with centre cut
- 30° helix angle

	P	M	K	N	S	H	O
uncoated	●	●	●	●●	●		
ACN	●●	●●	●	●	●●		

DIN 327

Shank DIN 1835 B

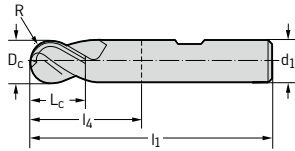

D _c e8 mm	R mm	L _c mm	l ₁ mm	l ₄ mm	d ₁ h6 mm	Z	uncoated designation P316601	ACN designation P3166017
2	1	4	48	12	6	2	-2	-2
3	1,5	5	49	13	6	2	-3	-3
4	2	7	51	15	6	2	-4	-4
5	2,5	8	52	16	6	2	-5	-5
6	3	8	52	16	6	2	-6	-6
8	4	11	61	21	10	2	-8	-8
10	5	13	63	23	10	2	-10	-10
11	5,5	13	70	25	12	2		-11
12	6	16	73	28	12	2	-12	-12
13	6,5	16	73	28	12	2	-13	-13
14	7	16	73	28	12	2	-14	-14
15	7,5	16	73	28	12	2	-15	-15
16	8	19	79	31	16	2	-16	-16
18	9	19	79	31	16	2	-18	-18
20	10	22	88	38	20	2	-20	-20

Ball-nose end mill Protostar® 30

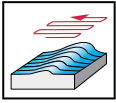

- HSS-E Co8
- 2 cutting edges
- with centre cut
- 30° helix angle

	P	M	K	N	S	H	O
uncoated	●	●	●	●	●		
ACN	●●	●●	●●	●	●●		

DIN 844 B	D _c e8 mm	R mm	L _c mm	l ₁ mm	l ₄ mm	d ₁ h6 mm	Z	uncoated designation P316611	ACN designation P316617
Shank DIN 1835 B	3	1,5	8	52	16	6	2	-3	-3
	4	2	11	55	19	6	2	-4	-4
	5	2,5	13	57	21	6	2	-5	-5
	6	3	13	57	21	6	2	-6	-6
	7	3,5	16	66	26	10	2	-7	-7
	8	4	19	69	29	10	2	-8	-8
	10	5	22	72	32	10	2	-10	-10
	12	6	26	83	38	12	2	-12	-12
	16	8	32	92	44	16	2	-16	-16
	18	9	32	92	44	16	2	-18	
	20	10	38	104	54	20	2	-20	-20
	22	11	38	104	54	20	2	-22	
	25	12,5	45	121	65	25	2	-25	
	28	14	45	121	65	25	2	-28	
	30	15	45	121	65	25	2	-30	

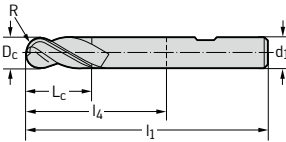

Die sinking cutters Protostar® 30

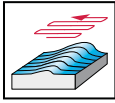

- HSS-E Co8
- 4 cutting edges
- with centre cut
- 30° helix angle

	P	M	K	N	S	H	O
ACN	●●		●	●			
uncoated			●●				

DIN 1889 BB

Shank DIN 1835 B

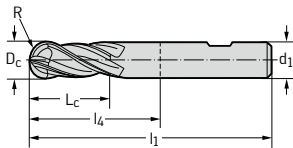

D_c k12 mm	R mm	L_c mm	l_1 mm	l_4 mm	d_1 h mm	Z	ACN designation P8112017
6	3	13	57	21	6	4	-6
8	4	19	69	29	10	4	-8
10	5	22	72	32	10	4	-10
12	6	26	83	38	12	4	-12
16	8	32	92	44	16	4	-16
20	10	38	104	54	20	4	-20

DIN 1889 BB

Shank DIN 1835 B

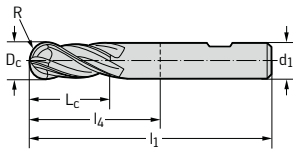

D_c k12 mm	R mm	L_c mm	l_1 mm	l_4 mm	d_1 h6 mm	Z	uncoated designation P811211
10	5	45	95	55	10	4	-10
12	6	53	110	38	12	4	-12
16	8	63	123	44	16	4	-16
20	10	75	141	54	20	4	-20
25	12,5	90	166	110	25	6	-25



Walter Select – Profile milling

Solid carbide end mills

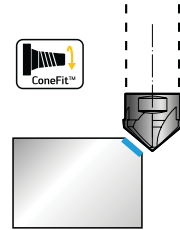
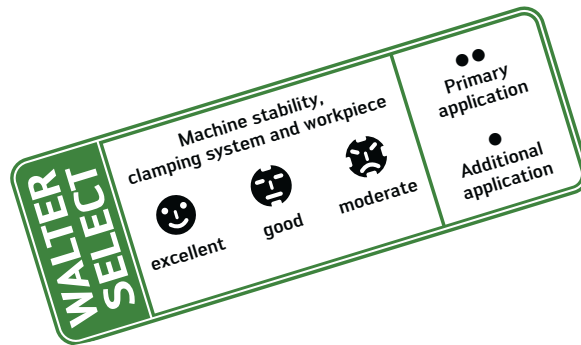
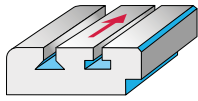

Solid carbide end mills

Material group		Classification of the main material groups and code letters		Workpiece material		Brinell hardness HB		Tensile strength R_m N/mm ²		Machining group		Machining conditions							
												Family	Designation	λ	Page				
												Dia. range		10 – 16					
												Number of teeth		4 – 8					
												Coating		TAX					
												ConeFit™		H3E58518		0°		E 220	
												Chamfer milling cutter 60°		H3E58318		0°		E 219	
												90°		H3E58118		0°		E 218	
												120°							
P	Unalloyed and low-alloyed steel	annealed (tempered)	210	700	P1, P2, P3, P4, P7	●●													
		Free cutting steel	220	750	P6	●●													
		tempered	300	1010	P5, P8	●●													
		tempered	380	1280	P9	●●													
		tempered	430	1480	P10	●●													
	High-alloyed steel and high-alloyed tool steel	annealed	200	670	P11	●●													
		hardened and tempered	300	1010	P12	●●													
		hardened and tempered	400	1360	P13	●●													
	Stainless steel	ferritic / martensitic, annealed	200	670	P14	●●													
		martensitic, tempered	330	1110	P15	●●													
M	Stainless steel	austenitic, duplex	230	780	M1, M3	●●													
		austenitic, precipitation hardened (PH)	300	1010	M2	●●													
K	Grey cast iron		245	–	K3, K4	●													
	Cast iron with spheroidal graphite	ferritic, pearlitic	365	–	K1, K2, K5, K6	●													
	GGV (CGI)		200	–	K7	●													
N	Aluminium wrought alloys	cannot be hardened	30	–	N1	●													
		hardenable, hardened	100	340	N2	●													
	Cast aluminium alloys	≤ 12 % Si	90	310	N3, N4	●													
		> 12 % Si	130	450	N5	●													
	Magnesium alloys		70	250	N6	●													
	Copper and copper alloys (bronze / brass)	unalloyed, electrolytic copper	100	340	N7	●													
		Brass, bronze, red brass	90	310	N8	●													
Cu-alloys, short-chipping		110	380	N9	●														
high-strength, Ampco		300	1010	N10	●														
S	Heat-resistant alloys	Fe-based	280	940	S1, S2	●													
		Ni or Co base	250	840	S3	●													
		Ni or Co base	350	1080	S4, S5	●													
	Titanium alloys	Pure titanium	200	670	S6	●													
		α and β alloys, hardened	375	1260	S7	●													
		β alloys	410	1400	S8	●													
	Tungsten alloys		300	1010	S9	●													
Molybdenum alloys		300	1010	S10	●														
H	Hardened steel		50 HRC	–	H1	●													
			55 HRC	–	H2, H4														
			60 HRC	–	H3														
O	Thermoplasts	without abrasive fillers			O1	●													
	Thermosetting plastics	without abrasive fillers			O2	●													
	Fibre-reinforced plastic	GFRP, AFRP			O3, O5														
		CFRP			O4														
Graphite (technical)			65	O6															

Walter Select – Profile milling

HSS T-slot milling cutters

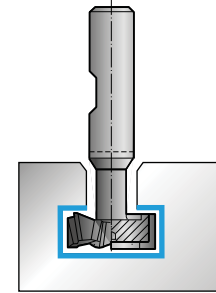
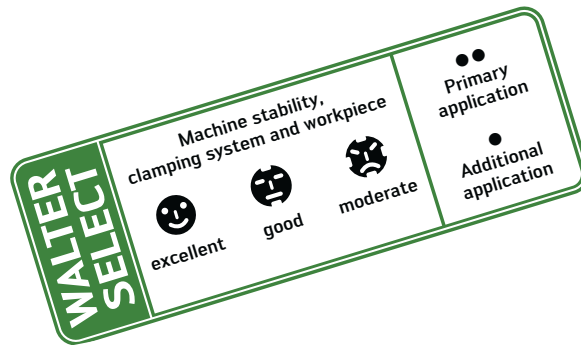
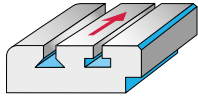

T-slot milling cutter

Machining conditions	☹️			
Dia. range	11 – 40			
Number of teeth	6 – 10			
Coating	TiCN			
	Family	Designation	λ	Page

Material group	Classification of the main material groups and code letters		Brinell hardness HB	Tensile strength R_m N/mm ²	Machining group	Machining conditions			
	Workpiece material					Family	Designation	λ	Page
						N 12	P3148016	12°	E 223
P	Unalloyed and low-alloyed steel	annealed (tempered)	210	700	P1, P2, P3, P4, P7	●●			
		Free cutting steel	220	750	P6	●●			
		tempered	300	1010	P5, P8	●●			
		tempered	380	1280	P9	●●			
		tempered	430	1480	P10	●●			
	High-alloyed steel and high-alloyed tool steel	annealed	200	670	P11	●●			
hardened and tempered		300	1010	P12	●●				
hardened and tempered		400	1360	P13	●●				
Stainless steel	ferritic / martensitic, annealed	200	670	P14	●●				
	martensitic, tempered	330	1110	P15	●●				
M	Stainless steel	austenitic, duplex	230	780	M1, M3	●			
		austenitic, precipitation hardened (PH)	300	1010	M2	●			
K	Grey cast iron		245	–	K3, K4	●●			
	Cast iron with spheroidal graphite	ferritic, pearlitic	365	–	K1, K2, K5, K6	●●			
	GGV (CGI)		200	–	K7	●●			
N	Aluminium wrought alloys	cannot be hardened	30	–	N1	●			
		hardenable, hardened	100	340	N2	●			
	Cast aluminium alloys	≤ 12 % Si	90	310	N3, N4	●			
		> 12 % Si	130	450	N5	●			
	Magnesium alloys		70	250	N6	●			
	Copper and copper alloys (bronze / brass)	unalloyed, electrolytic copper		100	340	N7	●		
Brass, bronze, red brass			90	310	N8	●			
Cu-alloys, short-chipping			110	380	N9	●			
high-strength, Ampco			300	1010	N10	●			
S	Heat-resistant alloys	Fe-based	280	940	S1, S2				
		Ni or Co base	250	840	S3				
		Ni or Co base	350	1080	S4, S5				
	Titanium alloys	Pure titanium	200	670	S6				
		α and β alloys, hardened	375	1260	S7				
		β alloys	410	1400	S8				
Tungsten alloys		300	1010	S9					
Molybdenum alloys		300	1010	S10					
H	Hardened steel		50 HRC	–	H1				
			55 HRC	–	H2, H4				
			60 HRC	–	H3				
O	Thermoplasts	without abrasive fillers			O1				
	Thermosetting plastics	without abrasive fillers			O2				
	Fibre-reinforced plastic	GFRP, AFRP			O3, O5				
		CFRP			O4				
Graphite (technical)			65	O6					

Chamfer milling cutter 120° Protostar®



Materials to 48 HRC

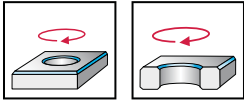

- solid carbide
- 4 to 6 cutting edges
- without centre cut
- 0° helix angle

Special features:

Shoulder milling: $a_e \leq 0.3 \times D_c$

	P	M	K	N	S	H	O
TAX	●	●	●	●	●		
uncoated	●	●	●	●	●		

P standard

ConeFit™

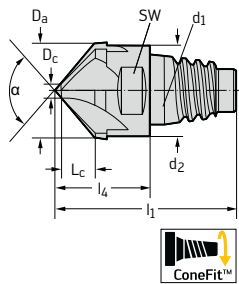

D _c mm	α	D _a mm	L _c mm	d ₂ mm	l ₁ mm	l ₄ mm	SW mm	d ₁	Z	TAX designation H3E58118
3	120	12	2,6	11,7	28,3	14,5	10	E 12	6	-E12-12

P standard L

Shank DIN 6535 HA

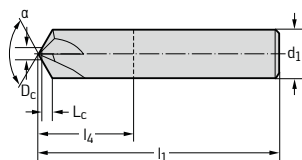

D _c mm	α	D _a mm	L _c mm	d ₂ mm	l ₁ mm	l ₄ mm	SW mm	d ₁ h6 mm	Z	uncoated designation H305811	TAX designation H3058118
1,5	120	-	2,45	-	100	60	-	10	4	-10	-10

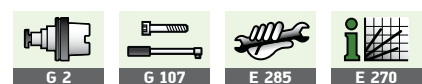

Chamfer milling cutter 90° Protostar®



Materials to 48 HRC

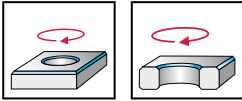

- solid carbide
- 4 to 8 cutting edges
- without centre cut
- 0° helix angle

Special features:

Shoulder milling: $a_e \leq 0.3 \times D_c$

	P	M	K	N	S	H	O
TAX	●●	●	●	●	●		
uncoated	●	●	●	●●	●		

P standard											TAX designation H3E58318
D_c mm	α	D_a mm	L_c mm	d_2 mm	l_1 mm	l_4 mm	SW mm	d_1	Z		
ConeFit™											
1,5	90	10	4,25	9,7	23,6	12,4	8	E 10	4		-E10-10
3	90	12	4,5	11,7	28,3	14,5	10	E 12	6		-E12-12
3	90	16	6,5	15,5	35,7	18,7	12	E 16	8		-E16-16

P standard L											uncoated designation H305831	TAX designation H3058318
D_c mm	α	D_a mm	L_c mm	d_2 mm	l_1 mm	l_4 mm	SW mm	d_1 h6 mm	Z			
Shank DIN 6535 HA												
1	90	-	2,5	-	57	21	-	6	4	-6	-6	
2	90	-	3	-	80	44	-	8	5	-8	-8	
1,5	90	-	4,25	-	100	60	-	10	4	-10	-10	
3	90	-	4,5	-	83	38	-	12	6	-12	-12	

P standard L											TAX designation H3158318
D_c mm	α	D_a mm	L_c mm	d_2 mm	l_1 mm	l_4 mm	SW mm	d_1 h6 mm	Z		
Shank DIN 6535 HB											
1	90	-	2,5	-	57	21	-	6	4		-6
2	90	-	3	-	80	44	-	8	5		-8
1,5	90	-	4,25	-	100	60	-	10	4		-10
3	90	-	4,5	-	83	38	-	12	6		-12

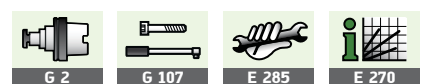

Chamfer milling cutter 60° Protostar®



Materials to 48 HRC

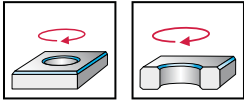

- solid carbide
- 4 to 6 cutting edges
- without centre cut
- 0° helix angle

Special features:

Shoulder milling: $a_e \leq 0.3 \times D_c$

	P	M	K	N	S	H	O
TAX	●	●	●	●	●		
uncoated	●	●	●	●	●		

P standard

ConeFit™

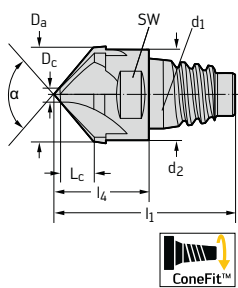

D_c mm	α	D_a mm	L_c mm	d_2 mm	l_1 mm	l_4 mm	SW mm	d_1	Z	TAX designation H3E58518
3,5	60	10	5,6	9,7	23,6	12,4	8	E 10	4	-E10-10
4,5	60	12	6,5	11,7	28,3	14,5	10	E 12	6	-E12-12

P standard L

Shank DIN 6535 HA

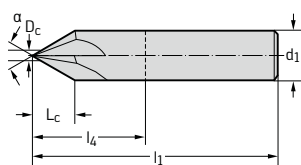

D_c mm	α	D_a mm	L_c mm	d_2 mm	l_1 mm	l_4 mm	SW mm	d_1 h6 mm	Z	uncoated designation H305851	TAX designation H3058518
1	60	-	4,3	-	57	21	-	6	4	-6	-6
1,5	60	-	7,35	-	100	60	-	10	4	-10	-10

P standard L

Shank DIN 6535 HB

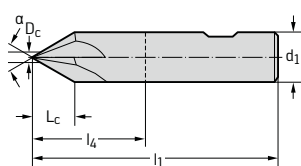

D_c mm	α	D_a mm	L_c mm	d_2 mm	l_1 mm	l_4 mm	SW mm	d_1 h6 mm	Z	TAX designation H3158518
1,5	60	-	7,35	-	100	60	-	10	4	-10

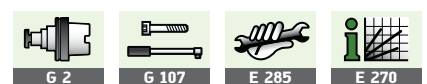

Top and bottom deburrer Protostar®

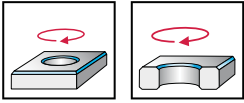

- solid carbide
- long reach
- 4 to 6 cutting edges
- without centre cut
- 0° helix angle

	P	M	K	N	S	H	O
TAX	●●	●	●	●	●		

P standard L	D _a -0,3 mm	α	L _c mm	l ₃ mm	d ₂ mm	l ₁ mm	l ₄ mm	d ₁ h6 mm	Z	TAX designation H3053918
Shank DIN 6535 HA	6	90	4,25	19	3,9	100	64	6	4	-6
	8	90	2	-	-	100	64	6	4	-8
	10	90	4	-	-	100	64	6	6	-10
	12	90	6	-	-	100	64	6	6	-12

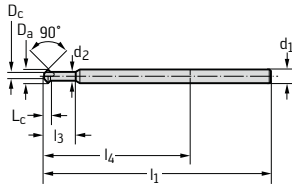

for 45° chamfer

T-slot milling cutter Protostar® N 12

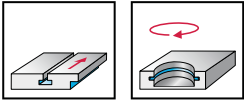

- HSS-E Co
- 6 to 10 cutting edges
- without centre cut
- 12° helix angle

	P	M	K	N	S	H	O
uncoated		●		●●			
TiCN	●●			●			

DIN 851 AB	D _c d11 mm	SB d11 mm	l ₃ mm	d ₂ h12 mm	l ₁ mm	l ₄ mm	d ₁ h6 mm	Z	uncoated designation P314801	TiCN designation P3148016
Shank DIN 1835 B	11	3,5	10,5	4	53,5	13,5	10	6	-11X3.5	
	11	4	10,5	4	53,5	13,5	10	6	-11	-11
	12,5	6	13	5	57	17	10	6	-12.5	-12.5
	16	8	18	7	62	22	10	6	-16	-16
	18	8	21	8	70	25	12	6	-18	-18
	21	9	25	10	74	29	12	8	-21	
	22	10	26	10	74	29	12	8	-22	-22
	25	11	28	12	82	34	16	8	-25	-25
	28	12	34	13	85	37	16	8	-28	-28
	32	14	36	15	90	42	16	8	-32	-32
	36	16	43	17	108	52	25	8	-36	-36
	40	18	45	19	108	52	25	8	-40	-40
	50	22	56	25	124	64	32	10	-50	

cross-toothed

T-slot milling cutter Protostar® Kordel F 12

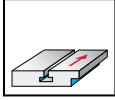

- HSS-E Co8
- 6 to 10 cutting edges
- without centre cut
- 12° helix angle

	P	M	K	N	S	H	O
uncoated	●●	●	●	●●			

DIN 851 AB

Shank DIN 1835 B

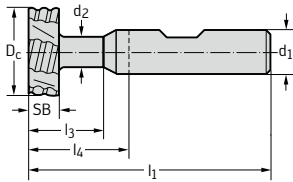

D _c +0,05 mm	SB d11 mm	l ₃ mm	d ₂ mm	l ₁ mm	l ₄ mm	d ₁ h6 mm	Z	uncoated designation P314101
16	8	18	7	62	22	10	6	-16
18	8	21	8	70	25	12	6	-18
21	9	25	10	74	29	12	6	-21
25	11	28	12	82	34	16	8	-25
32	14	36	15	90	42	16	8	-32
40	18	45	19	108	52	25	8	-40
50	22	56	25	124	64	32	10	-50

fine roughing teeth
cross-toothed

Keyway cutters Protostar® N 10

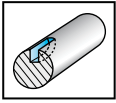

- HSS-E Co
- 6 to 12 cutting edges
- without centre cut
- 10° helix angle

	P	M	K	N	S	H	O
uncoated				●●			

DIN 850 D	D _c h12 mm	SB mm	d ₂ ±0,02 mm	l ₁ mm	l ₄ mm	d ₁ h6 mm	Z	uncoated designation P313211
Shank DIN 1835 B	4,5	1	1,8	50	14	6	6	-4.5X1
	7,5	1,5	2,8	50	14	6	6	-7.5X1.5
	7,5	2	3,2	50	14	6	6	-7.5X2
	10,5	2	4	50	14	6	8	-10.5X2
	10,5	2,5	4	50	14	6	8	-10.5X2.5
	10,5	3	4,2	50	14	6	8	-10.5X3
	13,5	2	4,6	56	16	10	8	-13.5X2
	13,5	3	4,6	56	16	10	8	-13.5X3
	16,5	2,5	4,6	56	16	10	8	-16.5X2.5
	19,5	3	5,6	63	23	10	10	-19.5X3
	19,5	4	5,6	63	23	10	10	-19.5X4
	19,5	5	6	63	23	10	10	-19.5X5
	22,5	6	6,5	63	23	10	10	-22.5X6
	28,5	6	8,5	63	23	10	12	-28.5X6

for woodruff keys
cross-toothed, radial cutting only

DIN 850 D	D _c h12 mm	SB mm	d ₂ ±0,02 mm	l ₁ mm	l ₄ mm	d ₁ h6 mm	Z	uncoated designation P313231
Shank DIN 1835 B	13,5	4	4,6	56	16	10	8	-13.5X4
	16,5	4	4,6	56	16	10	8	-16.5X4
	16,5	5	5	56	16	10	8	-16.5X5
	19,5	4	5,6	63	23	10	10	-19.5X4
	19,5	5	6	63	23	10	10	-19.5X5
	19,5	6	6,5	63	23	10	10	-19.5X6
	22,5	4	6	63	23	10	10	-22.5X4
	22,5	5	6	63	23	10	10	-22.5X5
	22,5	6	6,5	63	23	10	10	-22.5X6
	22,5	8	6,5	63	23	10	10	-22.5X8
	25,5	5	7,5	63	23	10	10	-25.5X5
	25,5	6	7,5	63	23	10	10	-25.5X6
	25,5	7	7,5	63	23	10	10	-25.5X7
	25,5	8	7,5	63	23	10	10	-25.5X8
	28,5	5	8,5	63	23	10	12	-28.5X5
	28,5	6	8,5	63	23	10	12	-28.5X6
	28,5	8	8,5	63	23	10	12	-28.5X8
	28,5	10	9,3	71	26	12	12	-28.5X10
	32,5	5	8,5	71	26	12	12	-32.5X5
	32,5	6	8,5	71	26	12	12	-32.5X6
	32,5	7	8,5	71	26	12	12	-32.5X7
	32,5	8	8,5	71	26	12	12	-32.5X8
	32,5	10	9,3	71	26	12	12	-32.5X10
	35,5	6	11,8	71	26	12	12	-35.5X6
	35,5	8	11,8	71	26	12	12	-35.5X8
	35,5	10	11,8	71	26	12	12	-35.5X10
	38,5	8	11,8	71	26	12	14	-38.5X8
	38,5	10	11,8	71	26	12	14	-38.5X10
	45,5	10	11,8	71	26	12	14	-45.5X10

for woodruff keys
cross-toothed, radial cutting only

Quarter-round profile milling cutters Protostar®

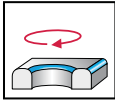

- HSS-E Co
- 4 to 6 cutting edges
- without centre cut
- 0° helix angle

	P	M	K	N	S	H	O
uncoated	●●	●	●	●	●		

DIN 6518 B

Shank DIN 1835 B

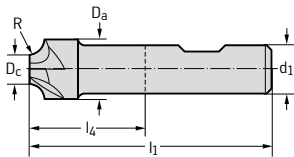

R H11 mm	D _c js14 mm	D _a mm	l ₁ mm	l ₄ mm	d ₁ h6 mm	Z	uncoated designation P316881
1	8	10	60	20	10	4	-1
1,5	7	10	60	20	10	4	-1,5
2	6	10	60	20	10	4	-2
2,5	5	10	60	20	10	4	-2,5
3	6	12	60	15	12	4	-3
4	6	15	60	15	12	4	-4
5	8	18	70	22	16	4	-5
6	9	21	70	22	16	4	-6
7	10	24	70	22	16	4	-7
8	8	24	70	22	16	4	-8
9	10	28	85	35	20	4	-9
10	8	28	85	35	20	4	-10
12	11	35	100	50	20	4	-12
12,5	10	35	100	50	20	4	-12,5
14	14	42	100	44	25	4	-14
15	18	48	105	49	25	5	-15
16	16	48	105	49	25	5	-16
18	16	52	115	55	32	5	-18
20	20	60	115	55	32	6	-20

relieved radially and axially

Dovetail milling cutters Protostar®

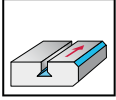

- HSS-E Co
- 10 to 12 cutting edges
- without centre cut
- 0° helix angle

Special features:
Shoulder milling: $a_e \leq 0.3 \times D_c$

	P	M	K	N	S	H	O
uncoated	●			●●			

DIN 1833 C	D_c js16 mm	α $\pm 30'$	L_c js14 mm	l_1 mm	l_4 mm	d_1 h6 mm	Z	uncoated designation P315801
Shank DIN 1835 B	12	45	3,5	54	14	10	10	-12-45
	16	45	4	60	15	12	10	-16-45
	20	45	5	63	18	12	10	-20-45
	25	45	6,3	67	22	12	10	-25-45
	32	45	8	71	23	16	12	-32-45

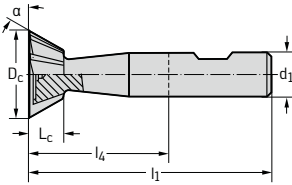

DIN 1833 C	D_c js16 mm	α $\pm 30'$	L_c js14 mm	l_1 mm	l_4 mm	d_1 h6 mm	Z	uncoated designation P315821
Shank DIN 1835 B	12	60	5	54	14	10	10	-12-60
	16	60	6,3	60	15	12	10	-16-60
	20	60	8	63	18	12	10	-20-60
	25	60	10	67	22	12	10	-25-60
	32	60	12,5	71	23	16	12	-32-60

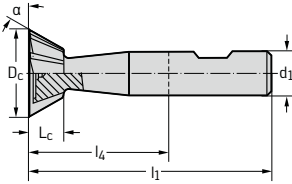

radial and axial cut

Dovetail milling cutters Protostar®

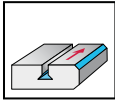

- HSS-E Co
- 10 to 12 cutting edges
- without centre cut
- 0° helix angle

Special features:
Shoulder milling: $a_e \leq 0.3 \times D_c$

	P	M	K	N	S	H	O
uncoated	●			●●			

DIN 1833 D	D_c js16 mm	α $\pm 30'$	L_c js14 mm	l_1 mm	l_4 mm	d_1 h6 mm	Z	uncoated designation P315831
Shank DIN 1835 B	12	45	3,5	54	14	10	10	-12-45
	16	45	4	60	15	12	10	-16-45
	20	45	5	63	18	12	10	-20-45
	25	45	6,3	67	22	12	10	-25-45
	32	45	8	71	23	16	12	-32-45

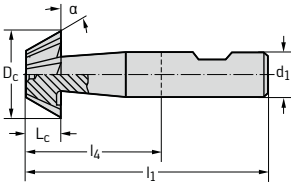

DIN 1833 D	D_c js16 mm	α $\pm 30'$	L_c js14 mm	l_1 mm	l_4 mm	d_1 h6 mm	Z	uncoated designation P315851
Shank DIN 1835 B	12	60	5	54	14	10	10	-12-60
	16	60	6,3	60	15	12	10	-16-60
	20	60	8	63	18	12	10	-20-60
	25	60	10	67	22	12	10	-25-60
	32	60	12,5	71	23	16	12	-32-60

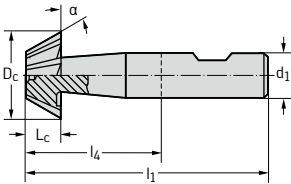







radial cutting only

ConeFit™ tool set

ConeFit™ SET-E12-MULTI

- with E12 interface
- cutter heads with 12 mm nominal diameter
- includes 2 steel shanks and matching wrench
- virtually universal use due to choice of cutter heads
- roughing, finishing and subsequent deburring possible



E	designation	Quantity	Contents	Remarks		Additional information
12	CONEFIT-SET-E12-MULTI	1	H3E82378-E12-12	Qmax - Roughing end mill		Page E 166
		1	H3E21138-E12-12	N50 - finishing end mill		Page E 37
		1	H3E21317-E12-12	Tough guys N50		Page E 85
		1	H3E58318-E12-12	Chamfer milling cutter 90°		Page E 219
		1	AK610.Z12.E12.022	Toolholder type A		Page G 81
		1	AK610.Z16.E12.025	Toolholder type C		Page G 81
		1	FS2125-E12	Flat wrench		Page G 107

Cutting data for shoulder milling

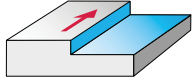

Cutting tool material	Solid carbide			
	Family	Des.	λ	Page
	N60	H3024148	60°	E 36

Material group	Classification of the main material groups and code letters		Brinell hardness HB	Tensile strength R _m N/mm ²	Machining group ¹	Dia. 6 – 20				
	Workpiece material					Z = 6				
						TAX			VT	
		1/2	a _e / D _c 1/4	1/10						
P	Unalloyed steel	C ≤ 0,25 %	annealed	125	428	P1		240	290	A
		C > 0,25... ≤ 0,55 %	annealed	190	639	P2		230	280	A
		C > 0,25... ≤ 0,55 %	tempered	210	708	P3		200	240	A
		C > 0,55 %	annealed	190	639	P4		200	240	A
		C > 0,55 %	tempered	300	1013	P5		140	170	A
		Free cutting steel (short-chipping)	annealed	220	745	P6		200	240	A
	Low-alloyed steel	annealed		175	591	P7		200	240	A
		tempered		300	1013	P8		140	170	A
		tempered		380	1282	P9		120	140	A
		tempered		430	1477	P10		100	120	A
	High-alloyed steel and high-alloyed tool steel	annealed		200	675	P11		200	240	A
		hardened and tempered		300	1013	P12		140	170	A
		hardened and tempered		400	1361	P13		100	120	A
	Stainless steel	ferritic / martensitic, annealed		200	675	P14		70	80	A
		martensitic, tempered		330	1114	P15		50	60	A
M	Stainless steel	austenitic, quench hardened		200	675	M1		80	100	B
		austenitic, precipitation hardened (PH)		300	1013	M2		50	60	B
		austenitic / ferritic, duplex		230	778	M3		70	80	B
K	Malleable cast iron	ferritic		200	675	K1				
		pearlitic		260	867	K2				
	Grey cast iron	low tensile strength		180	602	K3				
		high tensile strength / austenitic		245	825	K4				
	Cast iron with spheroidal graphite	ferritic		155	518	K5				
		pearlitic		265	885	K6				
	GGV (CGI)			200	675	K7				
N	Aluminium wrought alloys	cannot be hardened		30	–	N1				
		hardenable, hardened		100	343	N2				
	Cast aluminium alloys	≤ 12 % Si, not hardenable		75	260	N3				
		≤ 12 % Si, hardenable, hardened		90	314	N4				
		> 12 % Si, not hardenable		130	447	N5				
		Magnesium alloys			70	250	N6			
Copper and copper alloys (bronze / brass)	unalloyed, electrolytic copper		100	343	N7					
	Brass, bronze, red brass		90	314	N8					
	Cu-alloys, short-chipping		110	382	N9					
	high-strength, Ampco		300	1013	N10					
S	Heat-resistant alloys	Fe-based	annealed	200	675	S1				
			hardened	280	943	S2				
		Ni or Co base	annealed	250	839	S3				
			hardened	350	1177	S4				
			cast	320	1076	S5				
	Titanium alloys	Pure titanium		200	675	S6				
		α and β alloys, hardened		375	1262	S7				
		β alloys		410	1396	S8				
		Tungsten alloys			300	1013	S9			
		Molybdenum alloys			300	1013	S10			
H	Hardened steel	hardened and tempered		50 HRC	–	H1				
		hardened and tempered		55 HRC	–	H2				
		hardened and tempered		60 HRC	–	H3				
	Hardened cast iron	hardened and tempered		55 HRC	–	H4				
O	Thermoplasts	without abrasive fillers				O1				
	Thermosetting plastics	without abrasive fillers				O2				
	Plastic, glass-fibre reinforced	GFRP				O3				
	Plastic, carbon-fibre reinforced	CFRP				O4				
	Plastic, aramid-fibre reinforced	AFRP				O5				
	Graphite (technical)			80 Shore		O6				

¹ The machining groups are assigned from page H 8.

Cutting data for shoulder milling

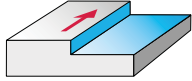

Cutting tool material		Solid carbide			
Family	Des.	λ	Page		
Ti 45 extra long	H7073417	45°	E 49		

Material group	Classification of the main material groups and code letters		Brinell hardness HB	Tensile strength R _m N/mm ²	Machining group ¹	Dia. 16 – 25				
	Workpiece material					Z = 4 – 5				
						ACN			VT	
					1/10	a _a / D _c 1/20	1/50			
P	Unalloyed steel	C ≤ 0,25 %	annealed	125	428	P1				
		C > 0,25... ≤ 0,55 %	annealed	190	639	P2				
		C > 0,25... ≤ 0,55 %	tempered	210	708	P3				
		C > 0,55 %	annealed	190	639	P4				
		C > 0,55 %	tempered	300	1013	P5				
		Free cutting steel (short-chipping)	annealed	220	745	P6				
	Low-alloyed steel	annealed		175	591	P7				
		tempered		300	1013	P8				
		tempered		380	1282	P9				
		tempered		430	1477	P10				
	High-alloyed steel and high-alloyed tool steel	annealed		200	675	P11				
		hardened and tempered		300	1013	P12				
		hardened and tempered		400	1361	P13				
	Stainless steel	ferritic / martensitic, annealed		200	675	P14				
		martensitic, tempered		330	1114	P15				
M	Stainless steel	austenitic, quench hardened		200	675	M1				
		austenitic, precipitation hardened (PH)		300	1013	M2				
		austenitic / ferritic, duplex		230	778	M3				
K	Malleable cast iron	ferritic		200	675	K1	220	260	300	A
		pearlitic		260	867	K2	170	210	240	A
	Grey cast iron	low tensile strength		180	602	K3	220	260	300	A
		high tensile strength / austenitic		245	825	K4	180	220	250	A
	Cast iron with spheroidal graphite	ferritic		155	518	K5	220	260	300	A
		pearlitic		265	885	K6	170	210	240	A
GGV (CGI)			200	675	K7	150	180	200	A	
N	Aluminium wrought alloys	cannot be hardened		30	–	N1				
		hardenable, hardened		100	343	N2				
	Cast aluminium alloys	≤ 12 % Si, not hardenable		75	260	N3				
		≤ 12 % Si, hardenable, hardened		90	314	N4				
		> 12 % Si, not hardenable		130	447	N5				
	Magnesium alloys			70	250	N6				
	Copper and copper alloys (bronze / brass)	unalloyed, electrolytic copper		100	343	N7				
Brass, bronze, red brass		90	314	N8						
Cu-alloys, short-chipping		110	382	N9						
high-strength, Ampco		300	1013	N10						
S	Heat-resistant alloys	Fe-based	annealed	200	675	S1				
			hardened	280	943	S2				
		Ni or Co base	annealed	250	839	S3				
			hardened	350	1177	S4				
			cast	320	1076	S5				
	Titanium alloys	Pure titanium		200	675	S6	320	400	480	B
		α and β alloys, hardened		375	1262	S7	120	160	200	B
		β alloys		410	1396	S8	120	160	200	B
	Tungsten alloys			300	1013	S9				
	Molybdenum alloys			300	1013	S10				
H	Hardened steel	hardened and tempered		50 HRC	–	H1				
		hardened and tempered		55 HRC	–	H2				
		hardened and tempered		60 HRC	–	H3				
	Hardened cast iron	hardened and tempered		55 HRC	–	H4				
O	Thermoplasts	without abrasive fillers				O1				
	Thermosetting plastics	without abrasive fillers				O2				
	Plastic, glass-fibre reinforced	GFRP				O3				
	Plastic, carbon-fibre reinforced	CFRP				O4				
	Plastic, aramid-fibre reinforced	AFRP				O5				
	Graphite (technical)			80 Shore		O6				

¹ The machining groups are assigned from page H 8.

The specified cutting data are average recommended values.
For special applications, adjustment is recommended.

Solid carbide				PCD-brazed (tipped)				Carbide-brazed (tipped)								
Family	Des.	λ	Page	Family	Des.	λ	Page	Family	Des.	λ	Page					
N 30	H302211	30°	E 43	N 30	H8018718	30°	E 50	PCD mill	F4722	0°	E 52	Brazed heli milling cutters	F1675	E 53		
	H3022018	E 43	HSC 30		H3093418	30°	E 45		F4723	0°	E 53		F1676	E 55		
	H3122018	E 42	Mini		H404491	30°	E 51	F1677	E 54	F1678	E 54					
	H3058917	E 44	HSC 30		H4044918	E 51	F1682	E 54								
HSC 30	H3022118	30°	E 43													
	H3122118	E 43														
Dia. 2 – 20				Dia. 0.4 – 16				Dia. 6 – 125					Dia. 16 – 100			
Z = 4 – 6				Z = 2 + 4				Z = 2 – 8					Z = 3 – 8			
uncoated + TAX				uncoated + TAX				PCD				uncoated				
	a_e / D_c		VT		a_e / D_c		VT		a_e / D_c		VT		a_e / D_c		VT	
	1/2	1/4	1/10		1/2	1/4	1/10		1/2	1/4	1/10		1/2	1/4	1/10	
	230	280	330	A	240	280	350	A					200	325	375	J
	230	270	320	A	230	270	330	A					140	225	265	J
	190	230	280	A	200	230	290	A					120	200	230	J
	190	230	280	A	200	230	290	A					140	225	265	J
	140	160	200	A	150	170	200	A					110	180	215	J
	190	230	280	A	200	230	290	A					130	220	280	J
	190	230	280	A	200	230	290	A					155	250	290	L
	140	160	200	A	150	170	200	A					120	190	225	L
	110	130	160	A	130	140	170	A					100	170	195	L
	100	110	140	A	110	120	140	A					90	160	170	L
	190	230	280	A	200	230	290	A					115	190	220	L
	140	160	200	A	150	170	200	A					100	160	180	L
	100	110	140	A	110	120	140	A					90	150	170	L
	70	80	90	A	70	80	100	A					75	125	145	L
	50	60	70	A	50	60	70	A					70	115	135	L
	80	90	120	B												
	50	60	70	B												
	70	80	90	B												
													180	275	320	J
													135	215	250	J
													150	250	290	K
													125	205	240	K
													180	280	320	J
													130	205	240	J
													110	180	210	J
					1810	1810	2580	C	3000	4000	4000	G				
					1820	1810	2580	C	2000	2000	2000	G				
					720	850	1030	C	1500	1500	1500	H				
					720	850	1030	C	1000	1000	1000	H				
					250	300	360	C	500	500	500	H				
					830	980	1190	C								
					520	610	740	C								
					520	610	740	C								
					520	610	740	C								
					80	90	100	C								
									600	800	800	I				
									500	600	600	I				
									600	800	800	I				

Cutting data for shoulder / slot milling

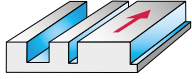

Cutting tool material	Carbide-brazed (tipped)			
	Family	Des.	λ	Page
Brazed porcupine cutters	F1375	0°	E 53	
	F1605		E 53	
	F1616		E 530	

Material group	Classification of the main material groups and code letters		Brinell hardness HB	Tensile strength R_m N/mm ²	Machining group ¹	Dia. 16 – 100				
	Workpiece material					Z = 4 – 5				
						ACN				
				a_e / D_c		VT				
				1/2	1/4	1/10				
P	Unalloyed steel	$C \leq 0,25\%$	annealed	125	428	P1	200	325	375	J
		$C > 0,25\% \leq 0,55\%$	annealed	190	639	P2	140	225	265	J
		$C > 0,25\% \leq 0,55\%$	tempered	210	708	P3	120	200	230	J
		$C > 0,55\%$	annealed	190	639	P4	140	225	265	J
		$C > 0,55\%$	tempered	300	1013	P5	110	180	215	J
	Low-alloyed steel	Free cutting steel (short-chipping)	annealed	220	745	P6	130	220	280	J
		annealed		175	591	P7	155	250	290	L
		tempered		300	1013	P8	120	190	225	L
		tempered		380	1282	P9	100	170	195	L
		tempered		430	1477	P10	90	160	170	L
	High-alloyed steel and high-alloyed tool steel	annealed		200	675	P11	115	190	220	L
		hardened and tempered		300	1013	P12	100	160	180	L
		hardened and tempered		400	1361	P13	90	150	170	L
	Stainless steel	ferritic / martensitic, annealed		200	675	P14	75	125	145	L
		martensitic, tempered		330	1114	P15	70	115	135	L
M	Stainless steel	austenitic, quench hardened		200	675	M1				
		austenitic, precipitation hardened (PH)		300	1013	M2				
		austenitic / ferritic, duplex		230	778	M3				
K	Malleable cast iron	ferritic		200	675	K1	180	275	320	J
		pearlitic		260	867	K2	135	215	250	J
	Grey cast iron	low tensile strength		180	602	K3	150	250	290	K
		high tensile strength / austenitic		245	825	K4	125	205	240	K
	Cast iron with spheroidal graphite	ferritic		155	518	K5	180	280	320	J
		pearlitic		265	885	K6	130	205	240	J
GGV (CGI)			200	675	K7	110	180	210	J	
N	Aluminium wrought alloys	cannot be hardened		30	–	N1				
		hardenable, hardened		100	343	N2				
	Cast aluminium alloys	$\leq 12\%$ Si, not hardenable		75	260	N3				
		$\leq 12\%$ Si, hardenable, hardened		90	314	N4				
	Magnesium alloys	$> 12\%$ Si, not hardenable		130	447	N5				
				70	250	N6				
Copper and copper alloys (bronze / brass)	unalloyed, electrolytic copper		100	343	N7					
	Brass, bronze, red brass		90	314	N8					
	Cu-alloys, short-chipping		110	382	N9					
	high-strength, Ampco		300	1013	N10					
S	Heat-resistant alloys	Fe-based	annealed		200	675	S1			
			hardened		280	943	S2			
		Ni or Co base	annealed		250	839	S3			
			hardened		350	1177	S4			
			cast		320	1076	S5			
	Titanium alloys	Pure titanium		200	675	S6				
		α and β alloys, hardened		375	1262	S7				
		β alloys		410	1396	S8				
Tungsten alloys			300	1013	S9					
Molybdenum alloys			300	1013	S10					
H	Hardened steel	hardened and tempered		50 HRC	–	H1				
		hardened and tempered		55 HRC	–	H2				
		hardened and tempered		60 HRC	–	H3				
Hardened cast iron			55 HRC	–	H4					
O	Thermoplasts	without abrasive fillers				O1				
	Thermosetting plastics	without abrasive fillers				O2				
	Plastic, glass-fibre reinforced	GFRP				O3				
	Plastic, carbon-fibre reinforced	CFRP				O4				
	Plastic, aramid-fibre reinforced	AFRP				O5				
	Graphite (technical)			80 Shore			O6			

¹ The machining groups are assigned from page H 8.

Cutting data for shoulder / slot milling

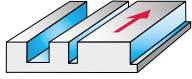

Cutting tool material	Solid carbide			
	Family	Des.	λ	Page
	Flash	H3094728	50°	E 139
	(48–63 HRC)			

Material group	Classification of the main material groups and code letters		Brinell hardness HB	Tensile strength R _m N/mm ²	Machining group ¹	Dia. 4 – 20				
	Workpiece material					Z = 4				
						TAX			VT	
						1/1	a _e / D _c 1/2	1/4		
P	Unalloyed steel	C ≤ 0,25 %	annealed	125	428	P1				
		C > 0,25... ≤ 0,55 %	annealed	190	639	P2				
		C > 0,25... ≤ 0,55 %	tempered	210	708	P3				
		C > 0,55 %	annealed	190	639	P4				
		C > 0,55 %	tempered	300	1013	P5				
		Free cutting steel (short-chipping)	annealed	220	745	P6				
	Low-alloyed steel		annealed	175	591	P7				
			tempered	300	1013	P8				
			tempered	380	1282	P9				
			tempered	430	1477	P10				
	High-alloyed steel and high-alloyed tool steel		annealed	200	675	P11				
			hardened and tempered	300	1013	P12				
			hardened and tempered	400	1361	P13				
	Stainless steel		ferritic / martensitic, annealed	200	675	P14				
			martensitic, tempered	330	1114	P15				
M	Stainless steel		austenitic, quench hardened	200	675	M1				
			austenitic, precipitation hardened (PH)	300	1013	M2				
			austenitic / ferritic, duplex	230	778	M3				
K	Malleable cast iron		ferritic	200	675	K1				
			pearlitic	260	867	K2				
	Grey cast iron		low tensile strength	180	602	K3				
			high tensile strength / austenitic	245	825	K4				
	Cast iron with spheroidal graphite		ferritic	155	518	K5				
			pearlitic	265	885	K6				
GGV (CGI)			200	675	K7					
N	Aluminium wrought alloys		cannot be hardened	30	–	N1				
			hardenable, hardened	100	343	N2				
	Cast aluminium alloys		≤ 12 % Si, not hardenable	75	260	N3				
			≤ 12 % Si, hardenable, hardened	90	314	N4				
			> 12 % Si, not hardenable	130	447	N5				
	Magnesium alloys			70	250	N6				
	Copper and copper alloys (bronze / brass)		unalloyed, electrolytic copper	100	343	N7				
		Brass, bronze, red brass	90	314	N8					
		Cu-alloys, short-chipping	110	382	N9					
		high-strength, Ampco	300	1013	N10					
S	Heat-resistant alloys	Fe-based	annealed	200	675	S1				
			hardened	280	943	S2				
		Ni or Co base	annealed	250	839	S3				
			hardened	350	1177	S4				
			cast	320	1076	S5				
	Titanium alloys		Pure titanium	200	675	S6				
			α and β alloys, hardened	375	1262	S7				
			β alloys	410	1396	S8				
	Tungsten alloys			300	1013	S9				
	Molybdenum alloys			300	1013	S10				
H	Hardened steel		hardened and tempered	50 HRC	–	H1				
			hardened and tempered	55 HRC	–	H2	90	110	130	E
			hardened and tempered	60 HRC	–	H3	50	60	70	E
	Hardened cast iron		hardened and tempered	55 HRC	–	H4	90	110	130	E
O	Thermoplasts		without abrasive fillers			O1				
	Thermosetting plastics		without abrasive fillers			O2				
	Plastic, glass-fibre reinforced		GFRP			O3				
	Plastic, carbon-fibre reinforced		CFRP			O4				
	Plastic, aramid-fibre reinforced		AFRP			O5				
	Graphite (technical)			80 Shore		O6				

¹ The machining groups are assigned from page H 8.

Cutting data for shoulder / slot milling

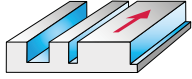

Cutting tool material	Solid carbide			
	Family	Des.	λ	Page
	Tough	H3020117	50°	E 140
	Guys	H3021117		E 84
	N 50	H4020117		E 145
	long	H4120117		E 145
		H4021117		E 88
		H4121117		E 88

Material group	Classification of the main material groups and code letters		Brinell hardness HB	Tensile strength R _m N/mm ²	Machining group ¹	Dia. 4 – 20				
						Z = 3 + 4				
	Workpiece material					TAX			VT	
1/1			a _e / D _c		1/10					
P	Unalloyed steel	C ≤ 0,25 %	annealed	125	428	P1	150	190	270	A
		C > 0,25... ≤ 0,55 %	annealed	190	639	P2	150	190	260	A
		C > 0,25... ≤ 0,55 %	tempered	210	708	P3	120	160	220	A
		C > 0,55 %	annealed	190	639	P4	120	160	220	A
		C > 0,55 %	tempered	300	1013	P5	90	120	150	A
		Free cutting steel (short-chipping)	annealed	220	745	P6	120	160	220	A
	Low-alloyed steel		annealed	175	591	P7	120	160	220	A
			tempered	300	1013	P8	90	120	150	A
			tempered	380	1282	P9	80	100	130	A
			tempered	430	1477	P10	60	80	110	A
	High-alloyed steel and high-alloyed tool steel		annealed	200	675	P11	120	160	220	A
			hardened and tempered	300	1013	P12	90	120	150	A
			hardened and tempered	400	1361	P13	60	80	110	A
	Stainless steel		ferritic / martensitic, annealed	200	675	P14	40	60	70	A
			martensitic, tempered	330	1114	P15	30	40	50	A
M	Stainless steel		austenitic, quench hardened	200	675	M1	50	70	90	B
			austenitic, precipitation hardened (PH)	300	1013	M2	30	40	50	B
			austenitic / ferritic, duplex	230	778	M3	40	60	70	B
K	Malleable cast iron		ferritic	200	675	K1	120	150	200	A
			pearlitic	260	867	K2	90	120	160	A
	Grey cast iron		low tensile strength	180	602	K3	120	140	200	A
			high tensile strength / austenitic	245	825	K4	100	130	170	A
	Cast iron with spheroidal graphite		ferritic	155	518	K5	120	150	200	A
			pearlitic	265	885	K6	90	120	160	A
	GGV (CGI)		200	675	K7	80	100	140	A	
N	Aluminium wrought alloys		cannot be hardened	30	–	N1				
			hardenable, hardened	100	343	N2				
	Cast aluminium alloys		≤ 12 % Si, not hardenable	75	260	N3				
			≤ 12 % Si, hardenable, hardened	90	314	N4				
			> 12 % Si, not hardenable	130	447	N5				
	Magnesium alloys			70	250	N6				
Copper and copper alloys (bronze / brass)		unalloyed, electrolytic copper	100	343	N7					
		Brass, bronze, red brass	90	314	N8					
		Cu-alloys, short-chipping	110	382	N9					
		high-strength, Ampco	300	1013	N10					
S	Heat-resistant alloys	Fe-based		annealed	200	675	S1			
				hardened	280	943	S2			
		Ni or Co base		annealed	250	839	S3			
				hardened	350	1177	S4			
				cast	320	1076	S5			
	Titanium alloys		Pure titanium	200	675	S6			250	B
		α and β alloys, hardened	375	1262	S7	40	50	80	B	
		β alloys	410	1396	S8	40	50	80	B	
Tungsten alloys			300	1013	S9					
Molybdenum alloys			300	1013	S10					
H	Hardened steel		hardened and tempered	50 HRC	–	H1				
			hardened and tempered	55 HRC	–	H2				
			hardened and tempered	60 HRC	–	H3				
	Hardened cast iron		hardened and tempered	55 HRC	–	H4				
O	Thermoplasts		without abrasive fillers			O1				
	Thermosetting plastics		without abrasive fillers			O2				
	Plastic, glass-fibre reinforced		GFRP			O3				
	Plastic, carbon-fibre reinforced		CFRP			O4				
	Plastic, aramid-fibre reinforced		AFRP			O5				
	Graphite (technical)			80 Shore			O6			

¹ The machining groups are assigned from page H 8.

Cutting data for shoulder / slot milling

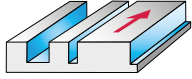

Cutting tool material	Solid carbide			
	Family	Des.	λ	Page
	ConeFit™ N 45	H3E29148	45°	E 94
	Compact N 45	H3013018 H3013118	45°	E 91 E 91

Material group	Classification of the main material groups and code letters		Brinell hardness HB	Tensile strength R _m N/mm ²	Machining group ¹	Ø 2 – 25					
						Z = 3					
	Workpiece material					TAX					
a _g / D _c			VT								
					1/1	1/2	1/10				
P	Unalloyed steel	C ≤ 0,25 %	annealed	125	428	P1	180	240	340	A	
		C > 0,25... ≤ 0,55 %	annealed	190	639	P2	170	230	320	A	
		C > 0,25... ≤ 0,55 %	tempered	210	708	P3	160	190	280	A	
		C > 0,55 %	annealed	190	639	P4	160	190	280	A	
		C > 0,55 %	tempered	300	1013	P5	110	140	200	A	
		Free cutting steel (short-chipping)	annealed	220	745	P6	160	190	280	A	
	Low-alloyed steel			annealed	175	591	P7	160	190	280	A
				tempered	300	1013	P8	110	140	200	A
				tempered	380	1282	P9	90	110	160	A
				tempered	430	1477	P10	80	100	140	A
	High-alloyed steel and high-alloyed tool steel			annealed	200	675	P11	160	190	280	A
				hardened and tempered	300	1013	P12	110	140	200	A
				hardened and tempered	400	1361	P13	80	100	140	A
	Stainless steel			ferritic / martensitic, annealed	200	675	P14	50	70	90	A
				martensitic, tempered	330	1114	P15	40	50	70	A
M	Stainless steel	austenitic, quench hardened		200	675	M1	60	80	120	B	
		austenitic, precipitation hardened (PH)		300	1013	M2	40	50	70	B	
		austenitic / ferritic, duplex		230	778	M3	50	70	90	B	
K	Malleable cast iron	ferritic		200	675	K1	150	180		A	
		pearlitic		260	867	K2	120	140		A	
	Grey cast iron	low tensile strength		180	602	K3	140	180		A	
		high tensile strength / austenitic		245	825	K4	120	150		A	
	Cast iron with spheroidal graphite	ferritic		155	518	K5	150	180		A	
		pearlitic		265	885	K6	120	140		A	
	GGV (CGI)			200	675	K7	100	120		A	
N	Aluminium wrought alloys	cannot be hardened		30	–	N1					
		hardenable, hardened		100	343	N2					
	Cast aluminium alloys	≤ 12 % Si, not hardenable		75	260	N3					
		≤ 12 % Si, hardenable, hardened		90	314	N4					
		> 12 % Si, not hardenable		130	447	N5					
	Magnesium alloys				70	250	N6				
	Copper and copper alloys (bronze / brass)	unalloyed, electrolytic copper		100	343	N7					
Brass, bronze, red brass		90	314	N8							
Cu-alloys, short-chipping		110	382	N9							
high-strength, Ampco		300	1013	N10							
S	Heat-resistant alloys	Fe-based	annealed	200	675	S1					
			hardened	280	943	S2					
		Ni or Co base	annealed	250	839	S3					
			hardened	350	1177	S4					
			cast	320	1076	S5					
	Titanium alloys	Pure titanium		200	675	S6					
		α and β alloys, hardened		375	1262	S7					
		β alloys		410	1396	S8					
	Tungsten alloys				300	1013	S9				
	Molybdenum alloys				300	1013	S10				
H	Hardened steel	hardened and tempered		50 HRC	–	H1					
		hardened and tempered		55 HRC	–	H2					
		hardened and tempered		60 HRC	–	H3					
	Hardened cast iron		hardened and tempered		55 HRC	–	H4				
O	Thermoplasts		without abrasive fillers							O1	
	Thermosetting plastics		without abrasive fillers							O2	
	Plastic, glass-fibre reinforced		GFRP							O3	
	Plastic, carbon-fibre reinforced		CFRP							O4	
	Plastic, aramid-fibre reinforced		AFRP							O5	
	Graphite (technical)				80 Shore						O6

¹ The machining groups are assigned from page H 8.

Cutting data for shoulder / slot milling

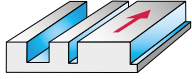

Cutting tool material	Solid carbide			
	Family	Des.	λ	Page
	30	H302611 H3026118	30°	E 100 E 100

Material group	Classification of the main material groups and code letters		Brinell hardness HB	Tensile strength R _m N/mm ²	Machining group ¹	Dia. 2 – 20					
	Workpiece material					Z = 2					
						uncoated + TAX					
				a _g / D _c		VT					
				1/1	1/2	1/10					
P	Unalloyed steel	C ≤ 0,25 %	annealed	125	428	P1	160	210		A	
		C > 0,25... ≤ 0,55 %	annealed	190	639	P2	150	200		A	
		C > 0,25... ≤ 0,55 %	tempered	210	708	P3	130	170		A	
		C > 0,55 %	annealed	190	639	P4	130	170		A	
		C > 0,55 %	tempered	300	1013	P5	90	120		A	
		Free cutting steel (short-chipping)	annealed	220	745	P6	130	170		A	
	Low-alloyed steel			annealed	175	591	P7	130	170		A
				tempered	300	1013	P8	90	120		A
				tempered	380	1282	P9	80	100		A
				tempered	430	1477	P10	70	80		A
	High-alloyed steel and high-alloyed tool steel			annealed	200	675	P11	130	170		A
				hardened and tempered	300	1013	P12	90	120		A
				hardened and tempered	400	1361	P13	70	80		A
	Stainless steel			ferritic / martensitic, annealed	200	675	P14		60		A
				martensitic, tempered	330	1114	P15		40		A
M	Stainless steel	austenitic, quench hardened		200	675	M1					
		austenitic, precipitation hardened (PH)		300	1013	M2					
		austenitic / ferritic, duplex		230	778	M3					
K	Malleable cast iron	ferritic		200	675	K1	120			A	
		pearlitic		260	867	K2	100			A	
	Grey cast iron	low tensile strength		180	602	K3	120			A	
		high tensile strength / austenitic		245	825	K4	100			A	
	Cast iron with spheroidal graphite	ferritic		155	518	K5	120			A	
		pearlitic		265	885	K6	100			A	
GGV (CGI)			200	675	K7	90			A		
N	Aluminium wrought alloys	cannot be hardened		30	–	N1					
		hardenable, hardened		100	343	N2					
	Cast aluminium alloys	≤ 12 % Si, not hardenable		75	260	N3					
		≤ 12 % Si, hardenable, hardened		90	314	N4					
		> 12 % Si, not hardenable		130	447	N5					
	Magnesium alloys			70	250	N6					
Copper and copper alloys (bronze / brass)	unalloyed, electrolytic copper		100	343	N7						
	Brass, bronze, red brass		90	314	N8						
	Cu-alloys, short-chipping		110	382	N9						
	high-strength, Ampco		300	1013	N10						
S	Heat-resistant alloys	Fe-based	annealed	200	675	S1					
			hardened	280	943	S2					
		Ni or Co base	annealed	250	839	S3					
			hardened	350	1177	S4					
			cast	320	1076	S5					
	Titanium alloys	Pure titanium		200	675	S6					
		α and β alloys, hardened		375	1262	S7					
		β alloys		410	1396	S8					
	Tungsten alloys			300	1013	S9					
	Molybdenum alloys			300	1013	S10					
H	Hardened steel	hardened and tempered		50 HRC	–	H1					
		hardened and tempered		55 HRC	–	H2					
		hardened and tempered		60 HRC	–	H3					
	Hardened cast iron	hardened and tempered		55 HRC	–	H4					
O	Thermoplasts	without abrasive fillers				O1					
	Thermosetting plastics	without abrasive fillers				O2					
	Plastic, glass-fibre reinforced	GFRP				O3					
	Plastic, carbon-fibre reinforced	CFRP				O4					
	Plastic, aramid-fibre reinforced	AFRP				O5					
	Graphite (technical)			80 Shore		O6					

¹ The machining groups are assigned from page H 8.

Cutting data for shoulder / slot milling

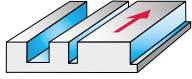

Cutting tool material	Solid carbide			
	Family	Des.	λ	Page
	AL 30	H901411	30°	E 106
	AL 25	H602881	25°	E 160
	short	H6028818		E 160

Material group	Classification of the main material groups and code letters		Brinell hardness HB	Tensile strength R_m N/mm ²	Machining group ¹	Dia. 2 – 20					
	Workpiece material					Z = 2					
						uncoated + TAX					
						1/1	a_g / D_c 1/2	1/10	VT		
P	Unalloyed steel	C ≤ 0,25 %	annealed	125	428	P1					
		C > 0,25... ≤ 0,55 %	annealed	190	639	P2					
		C > 0,25... ≤ 0,55 %	tempered	210	708	P3					
		C > 0,55 %	annealed	190	639	P4					
		C > 0,55 %	tempered	300	1013	P5					
		Free cutting steel (short-chipping)	annealed	220	745	P6					
	Low-alloyed steel			annealed	175	591	P7				
				tempered	300	1013	P8				
				tempered	380	1282	P9				
				tempered	430	1477	P10				
	High-alloyed steel and high-alloyed tool steel			annealed	200	675	P11				
				hardened and tempered	300	1013	P12				
				hardened and tempered	400	1361	P13				
	Stainless steel			ferritic / martensitic, annealed	200	675	P14				
				martensitic, tempered	330	1114	P15				
M	Stainless steel	austenitic, quench hardened		200	675	M1					
		austenitic, precipitation hardened (PH)		300	1013	M2					
		austenitic / ferritic, duplex		230	778	M3					
K	Malleable cast iron	ferritic		200	675	K1					
		pearlitic		260	867	K2					
	Grey cast iron	low tensile strength		180	602	K3					
		high tensile strength / austenitic		245	825	K4					
	Cast iron with spheroidal graphite	ferritic		155	518	K5					
		pearlitic		265	885	K6					
	GGV (CGI)			200	675	K7					
N	Aluminium wrought alloys	cannot be hardened		30	–	N1	1120	1480	2090	C	
		hardenable, hardened		100	343	N2	1250	1590	2090	C	
	Cast aluminium alloys	≤ 12 % Si, not hardenable		75	260	N3	480	630	850	C	
		≤ 12 % Si, hardenable, hardened		90	314	N4	480	630	850	C	
		> 12 % Si, not hardenable		130	447	N5	160	210	300	C	
	Magnesium alloys			70	250	N6	550	680	970	C	
		Copper and copper alloys (bronze / brass)	unalloyed, electrolytic copper		100	343	N7	320	430	610	C
Brass, bronze, red brass			90	314	N8	320	430	610	C		
Cu-alloys, short-chipping			110	382	N9	350	430	610	C		
high-strength, Ampco			300	1013	N10	50	70	90	C		
S	Heat-resistant alloys	Fe-based	annealed	200	675	S1					
			hardened	280	943	S2					
		Ni or Co base	annealed	250	839	S3					
			hardened	350	1177	S4					
			cast	320	1076	S5					
	Titanium alloys	Pure titanium		200	675	S6					
		α and β alloys, hardened		375	1262	S7					
		β alloys		410	1396	S8					
	Tungsten alloys			300	1013	S9					
	Molybdenum alloys			300	1013	S10					
H	Hardened steel	hardened and tempered		50 HRC	–	H1					
		hardened and tempered		55 HRC	–	H2					
		hardened and tempered		60 HRC	–	H3					
	Hardened cast iron	hardened and tempered		55 HRC	–	H4					
O	Thermoplasts	without abrasive fillers				O1	280	340	490	C	
	Thermosetting plastics	without abrasive fillers				O2	130	170	240	C	
	Plastic, glass-fibre reinforced	GFRP				O3					
	Plastic, carbon-fibre reinforced	CFRP				O4					
	Plastic, aramid-fibre reinforced	AFRP				O5					
	Graphite (technical)			80 Shore		O6					

¹ The machining groups are assigned from page H 8.

The specified cutting data are average recommended values.
For special applications, adjustment is recommended.

Solid carbide									
Family	Des.	λ	Page	Family	Des.	λ	Page		
Sky-tec™ AL 25	H602691	25°	E 159	AL 30	H901451	30°	E 106		
	AL 45	H602551	45°					E 99	
	AL 25 long	H602641	25°					E 107	
		H602681						E 107	
Dia. 2 - 25				Dia. 3 - 10					
Z = 2				Z = 1					
uncoated				uncoated					
a_e / D_c		VT		a_e / D_c		VT			
1/1	1/2	1/10		1/1	1/2	1/10			
1020	1350	1920	C	1160	1540	2190	C		
1140	1440	1920	C	1160	1540	2190	C		
270	360	480	C	290	380	550	C		
270	360	480	C	290	380	550	C		
100	130	190	C	120	150	220	C		
260	340	480	C	290	380	550	C		
150	200	290	C	180	230	330	C		
150	200	290	C	180	230	330	C		
160	200	290	C	180	230	330	C		
110	130	190	C						

Cutting data for shoulder / slot milling

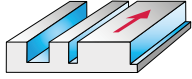

Cutting tool material		Solid carbide			
Family	Des.	λ	Page		
Tough guys N 50	H3021217	50°	E 128		
	H3121217		E 128		

Material group	Classification of the main material groups and code letters		Brinell hardness HB	Tensile strength R _m N/mm ²	Machining group ¹	Dia. 2.8 – 16				
	Workpiece material					Z = 3 + 4				
						TAX			VT	
				a _a / D _c		1/1	1/2	1/10		
P	Unalloyed steel	C ≤ 0,25 %	annealed	125	428	P1	220	290	410	A
		C > 0,25... ≤ 0,55 %	annealed	190	639	P2	210	280	390	A
		C > 0,25... ≤ 0,55 %	tempered	210	708	P3	180	230	330	A
		C > 0,55 %	annealed	190	639	P4	180	230	330	A
		C > 0,55 %	tempered	300	1013	P5	130	170	240	A
		Free cutting steel (short-chipping)	annealed	220	745	P6	180	230	330	A
	Low-alloyed steel	annealed		175	591	P7	180	230	330	A
		tempered		300	1013	P8	130	170	240	A
		tempered		380	1282	P9	100	140	200	A
		tempered		430	1477	P10	90	120	170	A
	High-alloyed steel and high-alloyed tool steel	annealed		200	675	P11	180	230	330	A
		hardened and tempered		300	1013	P12	130	170	240	A
		hardened and tempered		400	1361	P13	90	120	170	A
	Stainless steel	ferritic / martensitic, annealed		200	675	P14	60	80	110	A
		martensitic, tempered		330	1114	P15	40	60	80	A
M	Stainless steel	austenitic, quench hardened		200	675	M1	70	100	140	B
		austenitic, precipitation hardened (PH)		300	1013	M2	40	60	80	B
		austenitic / ferritic, duplex		230	778	M3	60	80	110	B
K	Malleable cast iron	ferritic		200	675	K1	170	220	310	A
		pearlitic		260	867	K2	130	170	240	A
	Grey cast iron	low tensile strength		180	602	K3	170	220	310	A
		high tensile strength / austenitic		245	825	K4	140	180	260	A
	Cast iron with spheroidal graphite	ferritic		155	518	K5	170	220	310	A
		pearlitic		265	885	K6	130	170	240	A
GGV (CGI)			200	675	K7	110	150	210	A	
N	Aluminium wrought alloys	cannot be hardened		30	–	N1				
		hardenable, hardened		100	343	N2				
	Cast aluminium alloys	≤ 12 % Si, not hardenable		75	260	N3				
		≤ 12 % Si, hardenable, hardened		90	314	N4				
		> 12 % Si, not hardenable		130	447	N5				
	Magnesium alloys			70	250	N6				
Copper and copper alloys (bronze / brass)	unalloyed, electrolytic copper		100	343	N7					
	Brass, bronze, red brass		90	314	N8					
	Cu-alloys, short-chipping		110	382	N9					
	high-strength, Ampco		300	1013	N10					
S	Heat-resistant alloys	Fe-based	annealed	200	675	S1				
			hardened	280	943	S2				
		Ni or Co base	annealed	250	839	S3				
			hardened	350	1177	S4				
			cast	320	1076	S5				
	Titanium alloys	Pure titanium		200	675	S6	170	250	380	B
α and β alloys, hardened		375	1262	S7	50	80	130	B		
β alloys		410	1396	S8	50	80	130	B		
Tungsten alloys			300	1013	S9					
Molybdenum alloys			300	1013	S10					
H	Hardened steel	hardened and tempered		50 HRC	–	H1				
		hardened and tempered		55 HRC	–	H2				
		hardened and tempered		60 HRC	–	H3				
	Hardened cast iron	hardened and tempered		55 HRC	–	H4				
O	Thermoplasts	without abrasive fillers				O1				
	Thermosetting plastics	without abrasive fillers				O2				
	Plastic, glass-fibre reinforced	GFRP				O3				
	Plastic, carbon-fibre reinforced	CFRP				O4				
	Plastic, aramid-fibre reinforced	AFRP				O5				
	Graphite (technical)			80 Shore		O6				

¹ The machining groups are assigned from page H 8.

The specified cutting data are average recommended values.
For special applications, adjustment is recommended.

Solid carbide												PCD-brazed (tipped)			
Family	Des.	λ	Page	Family	Des.	λ	Page	Family	Des.	λ	Page				
N 30	H3117018	30°	E 130	N 30	H311501	30°	E 129	PCD porcupine cutters	F4726	10°	E 184				
	H311801	E 130	H3115018		E 129										
	H3118018	E 130	H3116018		E 129										
Dia. 1.8 – 20				Dia. 2 – 20				Dia. 32 – 63							
Z = 3				Z = 2				Z = 2 + 2							
TAX				uncoated				PKD							
		a_e / D_c		VT			a_e / D_c		VT			a_e / D_c		VT	
	1/1	1/2	1/10			1/1	1/2	1/10				1/1	1/2	1/10	
	180	240	350	A											
	180	230	340	A											
	150	200	290	A											
	150	200	290	A											
	120	140	200	A											
	150	200	290	A											
	150	200	290	A											
	120	140	200	A											
	100	120	170	A											
	80	100	140	A											
	150	200	290	A											
	120	140	200	A											
	80	100	140	A											
	50	70	100	A											
	40	50	70	A											
	140	190	270	A											
	120	150	210	A											
	140	190	270	A											
	120	160	220	A											
	140	190	270	A											
	120	150	210	A											
	100	130	180	A											
					1471	1811	2588	C	2000	3200	3200	G			
					1372	1811	2588	C	1400	1400	1400	G			
					549	724	1035	C	1000	1000	1000	H			
					549	724	1035	C	700	700	700	H			
					192	254	362	C	400	400	400	H			
					631	833	1190	C							
					395	521	744	C							
					395	521	744	C							
					395	521	744	C							
					60	73	105	C							
	150	210	330	B											
	40	60	100	B											
	40	60	100	B											
	60	80	110	B											
					338	417	595	C	600	800	800	J			
					158	208	298	C	500	600	600	J			
									600	800	800	J			

Cutting data for shoulder / slot milling

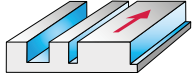

Cutting tool material	Solid carbide			
	Family	Des.	λ	Page
Kordel F 45	ConeFit™	H3E85378	45°	E 164
	HR Kordel F 45	H3185378	45°	E 165

Material group	Classification of the main material groups and code letters		Brinell hardness HB	Tensile strength R _m N/mm ²	Machining group ¹	Dia. 12 – 25				
						Z = 5 – 8				
	Workpiece material					TAX			a _g / D _c	
		1/1	1/2	1/10						
P	Unalloyed steel	C ≤ 0,25 %	annealed	125	428	P1	160	210	310	A
		C > 0,25... ≤ 0,55 %	annealed	190	639	P2	160	210	290	A
		C > 0,25... ≤ 0,55 %	tempered	210	708	P3	130	180	250	A
		C > 0,55 %	annealed	190	639	P4	130	180	250	A
		C > 0,55 %	tempered	300	1013	P5	90	120	180	A
		Free cutting steel (short-chipping)	annealed	220	745	P6	130	180	250	A
	Low-alloyed steel	annealed		175	591	P7	130	180	250	A
		tempered		300	1013	P8	90	120	180	A
		tempered		380	1282	P9				
		tempered		430	1477	P10				
	High-alloyed steel and high-alloyed tool steel	annealed		200	675	P11	130	180	250	A
		hardened and tempered		300	1013	P12	90	120	180	A
		hardened and tempered		400	1361	P13				
	Stainless steel	ferritic / martensitic, annealed		200	675	P14	50	60	90	A
		martensitic, tempered		330	1114	P15				
M	Stainless steel	austenitic, quench hardened		200	675	M1	60	70	110	B
		austenitic, precipitation hardened (PH)		300	1013	M2				
		austenitic / ferritic, duplex		230	778	M3	50	60	90	B
K	Malleable cast iron	ferritic		200	675	K1	120	160	230	A
		pearlitic		260	867	K2	100	130	180	A
	Grey cast iron	low tensile strength		180	602	K3	120	160	230	A
		high tensile strength / austenitic		245	825	K4	100	140	200	A
	Cast iron with spheroidal graphite	ferritic		155	518	K5	120	160	230	A
		pearlitic		265	885	K6	100	130	180	A
GGV (CGI)			200	675	K7	80	110	160	A	
N	Aluminium wrought alloys	cannot be hardened		30	–	N1				
		hardenable, hardened		100	343	N2				
	Cast aluminium alloys	≤ 12 % Si, not hardenable		75	260	N3				
		≤ 12 % Si, hardenable, hardened		90	314	N4				
		> 12 % Si, not hardenable		130	447	N5				
	Magnesium alloys			70	250	N6				
	Copper and copper alloys (bronze / brass)	unalloyed, electrolytic copper		100	343	N7				
		Brass, bronze, red brass		90	314	N8				
		Cu-alloys, short-chipping		110	382	N9				
		high-strength, Ampco		300	1013	N10				
S	Heat-resistant alloys	Fe-based	annealed	200	675	S1				
			hardened	280	943	S2				
		Ni or Co base	annealed	250	839	S3				
			hardened	350	1177	S4				
			cast	320	1076	S5				
	Titanium alloys	Pure titanium		200	675	S6				
		α and β alloys, hardened		375	1262	S7				
		β alloys		410	1396	S8				
	Tungsten alloys			300	1013	S9				
	Molybdenum alloys			300	1013	S10				
H	Hardened steel	hardened and tempered		50 HRC	–	H1				
		hardened and tempered		55 HRC	–	H2				
		hardened and tempered		60 HRC	–	H3				
	Hardened cast iron	hardened and tempered		55 HRC	–	H4				
O	Thermoplasts	without abrasive fillers				O1				
	Thermosetting plastics	without abrasive fillers				O2				
	Plastic, glass-fibre reinforced	GFRP				O3				
	Plastic, carbon-fibre reinforced	CFRP				O4				
	Plastic, aramid-fibre reinforced	AFRP				O5				
	Graphite (technical)			80 Shore		O6				

¹ The machining groups are assigned from page H 8.

The specified cutting data are average recommended values.
For special applications, adjustment is recommended.

Solid carbide															
Family Des. λ Page				Family Des. λ Page				Family Des. λ Page				Family Des. λ Page			
HR Kordel F 40 H4189278 40° E 167				ConeFit™ H3E82378 40° E 166				HNR Kordel F 30 H3180278 H4180378 30° E 170 E 170				HR Kordel F 30 H3187278 30° E 171			
				Kordel F 40 H3182378 H4189378 40° E 167 E 167											
Dia. 6 – 25				Dia. 5 – 20				Dia. 6 – 25				Dia. 6 – 25			
Z = 4				Z = 4				Z = 4				Z = 3			
TAX				TAX				TAX				TAX			
a _e / D _c			VT	a _e / D _c			VT	a _e / D _c			VT	a _e / D _c			VT
1/1	1/2	1/10		1/1	1/2	1/10		1/1	1/2	1/10		1/1	1/2	1/10	
180	240	350	A	160	210	300	A	150	200	290	A	180	240	350	A
180	230	340	A	160	200	290	A	150	190	280	A	180	230	340	A
150	200	290	A	130	170	250	A	130	170	240	A	150	200	290	A
150	200	290	A	130	170	250	A	130	170	240	A	150	200	290	A
110	140	200	A	90	120	180	A	90	120	170	A	110	140	200	A
150	200	290	A	130	170	250	A	130	170	240	A	150	200	290	A
150	200	290	A	130	170	250	A	130	170	240	A	150	200	290	A
110	140	200	A	90	120	180	A	90	120	170	A	110	140	200	A
90	120	170	A					70	100	140	A	90	120	170	A
80	100	140	A									80	100	140	A
150	200	290	A	130	170	250	A	130	170	240	A	150	200	290	A
110	140	200	A	90	120	180	A	90	120	170	A	110	140	200	A
80	100	140	A									80	100	140	A
50	70	100	A	50	60	90	A	40	60	80	A	50	70	100	A
40	50	70	A					30	40	60	A	40	50	70	A
60	80	120	B	60	70	100	B	50	70	100	B	60	80	120	B
40	50	70	B					30	40	60	B	40	50	70	B
50	70	100	B	50	60	90	B	40	60	80	B	50	70	100	B
140	190	270	A	120	160	230	A	120	160	220	A	140	190	270	A
110	150	210	A	100	130	180	A	90	120	170	A	110	150	210	A
140	190	270	A	120	160	230	A	120	160	220	A	140	190	270	A
120	160	220	A	100	140	200	A	100	130	190	A	120	160	220	A
140	190	270	A	120	160	230	A	120	160	220	A	140	190	270	A
110	150	210	A	100	130	180	A	90	120	170	A	110	150	210	A
100	130	180	A	90	110	160	A	80	100	150	A	100	130	180	A

Cutting data for shoulder / slot milling

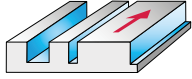

Cutting tool material	Solid carbide			
	Family	Des.	λ	Page
	Ti NS 30	H3083017 H3183017	30°	E 172 E 172

Material group	Classification of the main material groups and code letters		Brinell hardness HB	Tensile strength R _m N/mm ²	Machining group ¹	Dia. 6 – 25				
	Workpiece material					Z = 4+5				
						ACN			VT	
						1/1	a _e / D _c 1/2	1/10		
P	Unalloyed steel	C ≤ 0,25 %	annealed	125	428	P1				
		C > 0,25... ≤ 0,55 %	annealed	190	639	P2				
		C > 0,25... ≤ 0,55 %	tempered	210	708	P3				
		C > 0,55 %	annealed	190	639	P4				
		C > 0,55 %	tempered	300	1013	P5				
		Free cutting steel (short-chipping)	annealed	220	745	P6				
	Low-alloyed steel		annealed	175	591	P7				
			tempered	300	1013	P8				
			tempered	380	1282	P9				
			tempered	430	1477	P10				
	High-alloyed steel and high-alloyed tool steel		annealed	200	675	P11				
			hardened and tempered	300	1013	P12				
			hardened and tempered	400	1361	P13				
	Stainless steel		ferritic / martensitic, annealed	200	675	P14				
			martensitic, tempered	330	1114	P15				
M	Stainless steel		austenitic, quench hardened	200	675	M1				
			austenitic, precipitation hardened (PH)	300	1013	M2				
			austenitic / ferritic, duplex	230	778	M3				
K	Malleable cast iron		ferritic	200	675	K1	120	160	230	A
			pearlitic	260	867	K2	100	130	180	A
	Grey cast iron		low tensile strength	180	602	K3	120	160	230	A
			high tensile strength / austenitic	245	825	K4	100	140	200	A
	Cast iron with spheroidal graphite		ferritic	155	518	K5	120	160	230	A
			pearlitic	265	885	K6	100	130	180	A
GGV (CGI)			200	675	K7	90	110	160	A	
N	Aluminium wrought alloys		cannot be hardened	30	–	N1				
			hardenable, hardened	100	343	N2				
	Cast aluminium alloys		≤ 12 % Si, not hardenable	75	260	N3				
			≤ 12 % Si, hardenable, hardened	90	314	N4				
			> 12 % Si, not hardenable	130	447	N5				
	Magnesium alloys			70	250	N6				
Copper and copper alloys (bronze / brass)		unalloyed, electrolytic copper	100	343	N7					
		Brass, bronze, red brass	90	314	N8					
		Cu-alloys, short-chipping	110	382	N9					
		high-strength, Ampco	300	1013	N10					
S	Heat-resistant alloys	Fe-based	annealed	200	675	S1	40	50	80	B
			hardened	280	943	S2	20	30	50	B
		Ni or Co base	annealed	250	839	S3	40	50	80	B
			hardened	350	1177	S4	20	30	50	B
			cast	320	1076	S5	20	30	50	B
	Titanium alloys		Pure titanium	200	675	S6				
			α and β alloys, hardened	375	1262	S7	50	80	130	B
			β alloys	410	1396	S8	50	80	130	B
	Tungsten alloys			300	1013	S9	50	70	90	B
	Molybdenum alloys			300	1013	S10	50	60	90	B
H	Hardened steel		hardened and tempered	50 HRC	–	H1				
			hardened and tempered	55 HRC	–	H2				
			hardened and tempered	60 HRC	–	H3				
	Hardened cast iron		hardened and tempered	55 HRC	–	H4				
O	Thermoplasts		without abrasive fillers			O1				
	Thermosetting plastics		without abrasive fillers			O2				
	Plastic, glass-fibre reinforced		GFRP			O3				
	Plastic, carbon-fibre reinforced		CFRP			O4				
	Plastic, aramid-fibre reinforced		AFRP			O5				
	Graphite (technical)			80 Shore			O6			

¹ The machining groups are assigned from page H 8.

Cutting data for shoulder / slot milling

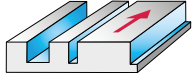

Cutting tool material		HSS			
Family	Des.	λ	Page		
N 45	P3123017	45°	E 129		
N 30	P3122017	30°	E 116		
Standard					

Material group	Classification of the main material groups and code letters		Brinell hardness HB	Tensile strength R _m N/mm ²	Machining group ¹	Dia. 2 – 32					
	Workpiece material					Z = 3 – 6					
						ACN			VT		
		1/1	a _e / D _c 1/2	1/10							
P	Unalloyed steel	C ≤ 0,25 %	annealed	125	428	P1		70	100	A	
		C > 0,25... ≤ 0,55 %	annealed	190	639	P2		70	100	A	
		C > 0,25... ≤ 0,55 %	tempered	210	708	P3		30	50	A	
		C > 0,55 %	annealed	190	639	P4		30	50	A	
		C > 0,55 %	tempered	300	1013	P5		30	50	A	
		Free cutting steel (short-chipping)	annealed	220	745	P6		30	50	A	
	Low-alloyed steel		annealed		175	591	P7		30	50	A
			tempered		300	1013	P8		30	40	A
			tempered		380	1282	P9		30	40	A
			tempered		430	1477	P10		30	40	A
	High-alloyed steel and high-alloyed tool steel		annealed		200	675	P11		30	40	A
			hardened and tempered		300	1013	P12		20	30	A
			hardened and tempered		400	1361	P13		20	30	A
	Stainless steel		ferritic / martensitic, annealed		200	675	P14		20	20	A
			martensitic, tempered		330	1114	P15		20	20	A
M	Stainless steel		austenitic, quench hardened	200	675	M1		40	50	B	
			austenitic, precipitation hardened (PH)	300	1013	M2		30	50	B	
			austenitic / ferritic, duplex	230	778	M3		30	50	B	
K	Malleable cast iron		ferritic	200	675	K1		30	50	A	
			pearlitic	260	867	K2		30	30	A	
	Grey cast iron		low tensile strength	180	602	K3		30	30	A	
			high tensile strength / austenitic	245	825	K4		30	40	A	
	Cast iron with spheroidal graphite		ferritic	155	518	K5					
			pearlitic	265	885	K6		30	40	A	
	GGV (CGI)		200	675	K7		30	40	A		
N	Aluminium wrought alloys		cannot be hardened	30	–	N1		20	30	C	
			hardenable, hardened	100	343	N2		20	30	C	
	Cast aluminium alloys		≤ 12 % Si, not hardenable	75	260	N3		20	20	C	
			≤ 12 % Si, hardenable, hardened	90	314	N4		20	20	C	
			> 12 % Si, not hardenable	130	447	N5		20	20	C	
	Magnesium alloys			70	250	N6		150	220	C	
Copper and copper alloys (bronze / brass)		unalloyed, electrolytic copper		100	343	N7		150	220	C	
		Brass, bronze, red brass		90	314	N8		150	220	C	
		Cu-alloys, short-chipping		110	382	N9	20	20	30	C	
		high-strength, Ampco		300	1013	N10			310	C	
S	Heat-resistant alloys	Fe-based	annealed	200	675	S1			310	B	
			hardened	280	943	S2		60	80	B	
		Ni or Co base	annealed	250	839	S3			320	B	
			hardened	350	1177	S4		60	90	B	
			cast	320	1076	S5		20	30	B	
	Titanium alloys		Pure titanium		200	675	S6		20	30	B
			α and β alloys, hardened		375	1262	S7		20	30	B
			β alloys		410	1396	S8				
	Tungsten alloys			300	1013	S9					
	Molybdenum alloys			300	1013	S10		90	140	B	
H	Hardened steel		hardened and tempered	50 HRC	–	H1		30	30	B	
			hardened and tempered	55 HRC	–	H2		20	30	B	
			hardened and tempered	60 HRC	–	H3		20	30	B	
Hardened cast iron		hardened and tempered	55 HRC	–	H4						
O	Thermoplasts		without abrasive fillers			O1					
	Thermosetting plastics		without abrasive fillers			O2					
	Plastic, glass-fibre reinforced		GFRP			O3					
	Plastic, carbon-fibre reinforced		CFRP			O4			110	C	
	Plastic, aramid-fibre reinforced		AFRP			O5			110	C	
	Graphite (technical)			80 Shore		O6			190	C	

¹ The machining groups are assigned from page H 8.

The specified cutting data are average recommended values.
For special applications, adjustment is recommended.

HSS															
Family	Des.	λ	Page	Family	Des.	λ	Page	Family	Des.	λ	Page	Family	Des.	λ	Page
N 45	P312301	45°	E 108	N 45	P3123117	45°	E 108	N 30	P302211	30°	E 118	30	P3117127	30°	E 122
N 30	P302201	30°	E 116	N 30	P3122117	30°	E 118	long	P312211		E 118				
Standard	P312201		E 116	long	P3122317		E 120		P312221		E 120				
Dia. 1 – 50				Dia. 3 – 25				Dia. 2 – 50				Dia. 2 – 20			
Z = 3 – 8				Z = 3 – 4				Z = 4 – 8				Z = 3			
uncoated				ACN				uncoated				ACN			
	a_e / D_c		VT		a_e / D_c		VT		a_e / D_c		VT		a_e / D_c		VT
1/1	1/2	1/10		1/1	1/2	1/10		1/1	1/2	1/10		1/1	1/2	1/10	
		20	A	60	50	40	A		20	30	A	50	60	90	A
		20	A	60	50	40	A		20	30	A	50	60	90	A
		20	A	30	30	20	A		20	20	A	30	30	40	A
		20	A	30	30	20	A		20	20	A	30	30	40	A
		20	A	30	30	20	A		20	20	A	30	30	40	A
		20	A	30	30	20	A		20	20	A	30	30	40	A
		20	A	30	30	20	A		20	20	A	30	30	40	A
		20	A	30	20	20	A		20	20	A	20	30	30	A
		20	A	30	20	20	A		20	20	A	20	30	30	A
		10	A	30	20	20	A		10	10	A	20	30	30	A
		10	A	20	20	10	A		10	10	A	20	20	20	A
		10	A	20	20	10	A		10	10	A	20	20	20	A
		10	A	10	10	10	A		10	10	A	10	10	20	A
		10	A	10	10	10	A		10	10	A	10	10	20	A
		20	B	30	30	20	B		20	20	B	30	30	50	B
		20	B	30	30	20	B		20	20	B	30	30	40	B
		20	B	30	30	20	B		20	20	B	30	30	40	B
		20	A	30	30	20	A		20	20	A	30	30	40	A
		10	A	30	20	20	A		10	20	A	20	30	30	A
		10	A	30	20	20	A		10	20	A	20	30	30	A
		10	A	30	20	20	A		10	20	A	20	30	30	A
		20	A											50	A
		20	A	30	20		A		20	20	A		30	30	A
		20	A	30	20		A		20	20	A		30	30	A
		10	C	30	20	10	C		10	10	C	20	20	30	C
		10	C	20	20	10	C		10	10	C	20	20	30	C
		10	C	20	10	10	C		10	10	C	10	20	20	C
		10	C	20	10	10	C		10	10	C	10	20	20	C
		10	C	20	10	10	C		10	10	C	10	20	20	C
		60	C	130	90		C		50	80	C	100	130	180	C
		60	C	130	100		C		60	80	C	100	130	180	C
		60	C	130	100		C		60	80	C	100	130	180	C
		10	C					10	10	20	C	20	20		C
		150	C	190	140		C			190	C	150	200	260	C
		150	B	190	150		B			190	B	150	180	260	B
		20	B						20	30	B	40	50	70	B
		60	B	200	150		B			80	B	160	200	270	B
		20	B						20	30	B	40	50	70	B
		10	B						10	10	B	20	20	20	B
		10	B						10	10	B	20	20	20	B
		10	B						10	10	B	20	20	20	B
		30	B					20	30	30	B	60			B
		10	B	20	20	20	B		10	20	B	20	20	30	B
		10	B	20	20	20	B		10	10	B	20	20	30	B
		10	B	20	20	20	B		10	10	B	20	20	30	B
		30	C	60	50		C			30	C	50	60	90	C
		30	C	60	50		C			30	C	50	60	90	C
		40	C	120	90		C			50	C	90	110	160	C

Cutting data for shoulder / slot milling

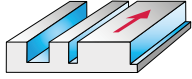

Cutting tool material	HSS			
	Family	Des.	λ	Page
	30	P311712	30°	E 122
		P311722		E 123
		P312771		E 124

Material group	Classification of the main material groups and code letters		Brinell hardness HB	Tensile strength R_m N/mm ²	Machining group ¹	Dia. 1 – 32				
						Z = 3				
	Workpiece material					uncoated			a_g / D_c	
				1/1	1/2	1/10				
P	Unalloyed steel	C ≤ 0,25 %	annealed	125	428	P1	20	30	30	A
		C > 0,25... ≤ 0,55 %	annealed	190	639	P2	20	30	30	A
		C > 0,25... ≤ 0,55 %	tempered	210	708	P3	20	20	30	A
		C > 0,55 %	annealed	190	639	P4	20	20	30	A
		C > 0,55 %	tempered	300	1013	P5	20	20	30	A
		Free cutting steel (short-chipping)	annealed	220	745	P6	20	20	30	A
	Low-alloyed steel	annealed		175	591	P7	20	20	30	A
		tempered		300	1013	P8	20	20	20	A
		tempered		380	1282	P9	20	20	20	A
		tempered		430	1477	P10	20	20	20	A
	High-alloyed steel and high-alloyed tool steel	annealed		200	675	P11	10	10	20	A
		hardened and tempered		300	1013	P12	10	10	20	A
		hardened and tempered		400	1361	P13	10	10	20	A
	Stainless steel	ferritic / martensitic, annealed		200	675	P14	10	10	10	A
		martensitic, tempered		330	1114	P15	10	10	10	A
M	Stainless steel	austenitic, quench hardened		200	675	M1	20	20	30	B
		austenitic, precipitation hardened (PH)		300	1013	M2	20	20	20	B
		austenitic / ferritic, duplex		230	778	M3	20	20	30	B
K	Malleable cast iron	ferritic		200	675	K1	20	20	30	A
		pearlitic		260	867	K2	10	20	20	A
	Grey cast iron	low tensile strength		180	602	K3	10	20	20	A
		high tensile strength / austenitic		245	825	K4	10	20	20	A
	Cast iron with spheroidal graphite	ferritic		155	518	K5	20	30	30	A
		pearlitic		265	885	K6	20	20	20	A
GGV (CGI)			200	675	K7	20	20	20	A	
N	Aluminium wrought alloys	cannot be hardened		30	–	N1	10	10	20	C
		hardenable, hardened		100	343	N2	10	10	20	C
	Cast aluminium alloys	≤ 12 % Si, not hardenable		75	260	N3	10	10	10	C
		≤ 12 % Si, hardenable, hardened		90	314	N4	10	10	10	C
		> 12 % Si, not hardenable		130	447	N5	10	10	10	C
	Magnesium alloys			70	250	N6	60	70	110	C
Copper and copper alloys (bronze / brass)	unalloyed, electrolytic copper		100	343	N7	60	70	110	C	
	Brass, bronze, red brass		90	314	N8	60	70	110	C	
	Cu-alloys, short-chipping		110	382	N9	10	20		C	
	high-strength, Ampco		300	1013	N10	150	200	260	C	
S	Heat-resistant alloys	Fe-based	annealed	200	675	S1	150	180	260	B
			hardened	280	943	S2	20	30	30	B
		Ni or Co base	annealed	250	839	S3	60	80	110	B
			hardened	350	1177	S4	20	30	30	B
			cast	320	1076	S5	10	10	10	B
	Titanium alloys	Pure titanium		200	675	S6	10	10	10	B
		α and β alloys, hardened		375	1262	S7	10	10	10	B
		β alloys		410	1396	S8				
	Tungsten alloys			300	1013	S9				
	Molybdenum alloys			300	1013	S10	30			B
H	Hardened steel	hardened and tempered		50 HRC	–	H1	10	20	20	B
		hardened and tempered		55 HRC	–	H2	10	10	20	B
		hardened and tempered		60 HRC	–	H3	10	10	20	B
	Hardened cast iron	hardened and tempered		55 HRC	–	H4				
O	Thermoplasts	without abrasive fillers				O1				
	Thermosetting plastics	without abrasive fillers				O2				
	Plastic, glass-fibre reinforced	GFRP				O3				
	Plastic, carbon-fibre reinforced	CFRP				O4	30	30	40	C
	Plastic, aramid-fibre reinforced	AFRP				O5	30	30	40	C
	Graphite (technical)			80 Shore		O6	40	50	70	C

¹ The machining groups are assigned from page H 8.

The specified cutting data are average recommended values.
For special applications, adjustment is recommended.

HSS															
Family	Des.	λ	Page	Family	Des.	λ	Page	Family	Des.	λ	Page	Family	Des.	λ	Page
W 40	P312401	40°	E 109	W 40	P312411	40°	E 109	Inox V 40	P4117027	40°	E 110	30	P3116127	30°	E 115
Standard				long								Standard	P3106117		E 113
Dia. 2 – 25				Dia. 2 – 25				Dia. 2 – 20				Dia. 1 – 22			
Z = 3				Z = 3				Z = 3				Z = 2			
uncoated				uncoated				ACN				ACN			
a_e / D_c		VT		a_e / D_c		VT		a_e / D_c		VT		a_e / D_c		VT	
1/1	1/2	1/10		1/1	1/2	1/10		1/1	1/2	1/10		1/1	1/2	1/10	
						20	A					50	60		A
												50	60		A
												30	30		A
												30	30		A
												30	30		A
												30	30		A
												30	30		A
												20	30		A
												20	30		A
												20	30		A
												20	30		A
												20	20		A
												20	20		A
												10	10		A
												10	10		A
								20	30	40	B	30			B
								10	10	15	B	30			B
								10	20	25	B	30			B
												30			A
												20			A
												20			A
												20			A
												30	40		A
													30		A
													30		A
	150	180	260	C	110	140	190	C				20			C
	160	200	260	C	120	150	190	C				20			C
	40	50	70	C	30	40	50	C				10			C
	40	50	70	C	30	40	50	C				10			C
												10			C
	40	50	70	C	30	40	50	C					130		C
	60	70	110	C	40	50	80	C					130		C
	60	70	110	C	50	60	80	C					130		C
												150	180		C
												140	180		B
												40	50		B
												150	190		B
	20	20	30	B	10	20	20	B							
												20	20		B
												20	20		B
												20	20		B
												50	60		C
												50	60		C
												90	110		C

Cutting data for shoulder / slot milling

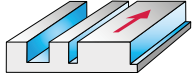

Cutting tool material	HSS			
	Family	Des.	λ	Page
Standard	30	P301612	30°	E 114
		P311612		E 115
		P312673		E 124
		P300611		E 113
		P310611		E 113

Material group	Classification of the main material groups and code letters		Brinell hardness HB	Tensile strength R _m N/mm ²	Machining group ¹	Dia. 1 – 40					
						Z = 2					
	Workpiece material					uncoated			a _e / D _c		VT
		1/1	1/2	1/10							
P	Unalloyed steel	C ≤ 0,25 %	annealed	125	428	P1	20	30		A	
		C > 0,25... ≤ 0,55 %	annealed	190	639	P2	20	30		A	
		C > 0,25... ≤ 0,55 %	tempered	210	708	P3	20	20		A	
		C > 0,55 %	annealed	190	639	P4	20	20		A	
		C > 0,55 %	tempered	300	1013	P5	20	20		A	
		Free cutting steel (short-chipping)	annealed	220	745	P6	20	20		A	
	Low-alloyed steel	annealed		175	591	P7	20	20		A	
		tempered		300	1013	P8	20	20		A	
		tempered		380	1282	P9	20	20		A	
		tempered		430	1477	P10	20	20		A	
	High-alloyed steel and high-alloyed tool steel	annealed		200	675	P11	10	10		A	
		hardened and tempered		300	1013	P12	10	10		A	
		hardened and tempered		400	1361	P13	10	10		A	
	Stainless steel	ferritic / martensitic, annealed		200	675	P14	10	10		A	
		martensitic, tempered		330	1114	P15	10	10		A	
M	Stainless steel	austenitic, quench hardened		200	675	M1	20			B	
		austenitic, precipitation hardened (PH)		300	1013	M2	20			B	
		austenitic / ferritic, duplex		230	778	M3	20			B	
K	Malleable cast iron	ferritic		200	675	K1	20			A	
		pearlitic		260	867	K2	10			A	
	Grey cast iron	low tensile strength		180	602	K3	10			A	
		high tensile strength / austenitic		245	825	K4	10			A	
	Cast iron with spheroidal graphite	ferritic		155	518	K5	20	30		A	
		pearlitic		265	885	K6	20	20		A	
	GGV (CGI)			200	675	K7	20	20		A	
N	Aluminium wrought alloys	cannot be hardened		30	–	N1	10			C	
		hardenable, hardened		100	343	N2	10			C	
	Cast aluminium alloys	≤ 12 % Si, not hardenable		75	260	N3	10			C	
		≤ 12 % Si, hardenable, hardened		90	314	N4	10			C	
		> 12 % Si, not hardenable		130	447	N5	10			C	
		Magnesium alloys			70	250	N6	70			C
Copper and copper alloys (bronze / brass)	unalloyed, electrolytic copper		100	343	N7		70			C	
	Brass, bronze, red brass		90	314	N8		70			C	
	Cu-alloys, short-chipping		110	382	N9					C	
	high-strength, Ampco		300	1013	N10	150	180			C	
S	Heat-resistant alloys	Fe-based	annealed	200	675	S1	140	180		B	
			hardened	280	943	S2	20	30		B	
		Ni or Co base	annealed	250	839	S3	60	70		B	
			hardened	350	1177	S4					
			cast	320	1076	S5					
	Titanium alloys	Pure titanium		200	675	S6					
		α and β alloys, hardened		375	1262	S7					
		β alloys		410	1396	S8					
		Tungsten alloys			300	1013	S9				
		Molybdenum alloys			300	1013	S10				
H	Hardened steel	hardened and tempered		50 HRC	–	H1	10	20		B	
		hardened and tempered		55 HRC	–	H2	10	10		B	
		hardened and tempered		60 HRC	–	H3	10	10		B	
		Hardened cast iron	hardened and tempered		55 HRC	–	H4				
O	Thermoplasts	without abrasive fillers				O1					
	Thermosetting plastics	without abrasive fillers				O2					
	Plastic, glass-fibre reinforced	GFRP				O3					
	Plastic, carbon-fibre reinforced	CFRP				O4	30	30		C	
	Plastic, aramid-fibre reinforced	AFRP				O5	30	30		C	
		Graphite (technical)			80 Shore		O6	40	50		C

¹ The machining groups are assigned from page H 8.

Cutting data for shoulder / slot milling

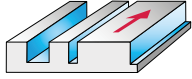

Cutting tool material	HSS			
	Family	Des.	λ	Page
	NRA Kordel G 35	P312001 P3120017	35°	E 177 E 177

Material group	Classification of the main material groups and code letters		Brinell hardness HB	Tensile strength R _m N/mm ²	Machining group ¹	Dia. 6 – 40					
	Workpiece material					Z = 4 + 6					
						uncoated + ACN			VT		
		a _g / D _c									
		1/1	1/2	1/10							
P	Unalloyed steel	C ≤ 0,25 %	annealed	125	428	P1	50	60	90	A	
		C > 0,25... ≤ 0,55 %	annealed	190	639	P2	50	60	90	A	
		C > 0,25... ≤ 0,55 %	tempered	210	708	P3	20	30	40	A	
		C > 0,55 %	annealed	190	639	P4	20	30	40	A	
		C > 0,55 %	tempered	300	1013	P5	20	20	30	A	
		Free cutting steel (short-chipping)	annealed	220	745	P6	20	30	40	A	
	Low-alloyed steel			annealed	175	591	P7	20	30	40	A
				tempered	300	1013	P8	20	20	30	A
				tempered	380	1282	P9				
				tempered	430	1477	P10				
	High-alloyed steel and high-alloyed tool steel			annealed	200	675	P11	20	30	40	A
				hardened and tempered	300	1013	P12	20	20	30	A
				hardened and tempered	400	1361	P13				
	Stainless steel			ferritic / martensitic, annealed	200	675	P14	10	10	20	A
				martensitic, tempered	330	1114	P15	10	10	10	A
M	Stainless steel			austenitic, quench hardened	200	675	M1	20	20	30	B
				austenitic, precipitation hardened (PH)	300	1013	M2	10	10	10	B
				austenitic / ferritic, duplex	230	778	M3	10	10	20	B
K	Malleable cast iron			ferritic	200	675	K1	20	30	40	A
				pearlitic	260	867	K2	20	20	30	A
	Grey cast iron			low tensile strength	180	602	K3	20	30	50	A
				high tensile strength / austenitic	245	825	K4	20	30	40	A
	Cast iron with spheroidal graphite			ferritic	155	518	K5	20	30	40	A
				pearlitic	265	885	K6	20	20	30	A
GGV (CGI)				200	675	K7	20	20	30	A	
N	Aluminium wrought alloys			cannot be hardened	30	–	N1	110	140	180	C
				hardenable, hardened	100	343	N2	110	140	180	C
	Cast aluminium alloys			≤ 12 % Si, not hardenable	75	260	N3	60	80	110	C
				≤ 12 % Si, hardenable, hardened	90	314	N4	60	80	110	C
				> 12 % Si, not hardenable	130	447	N5	30	40	60	C
	Magnesium alloys				70	250	N6	60	80	110	C
	Copper and copper alloys (bronze / brass)			unalloyed, electrolytic copper	100	343	N7	70	90	130	C
		Brass, bronze, red brass	90	314	N8	70	90	130	C		
		Cu-alloys, short-chipping	110	382	N9	70	90	130	C		
		high-strength, Ampco	300	1013	N10	10	20	20	C		
S	Heat-resistant alloys	Fe-based	annealed	200	675	S1					
			hardened	280	943	S2					
		Ni or Co base	annealed	250	839	S3					
			hardened	350	1177	S4					
			cast	320	1076	S5					
	Titanium alloys			Pure titanium	200	675	S6				
				α and β alloys, hardened	375	1262	S7				
				β alloys	410	1396	S8				
	Tungsten alloys				300	1013	S9				
	Molybdenum alloys				300	1013	S10				
H	Hardened steel			hardened and tempered	50 HRC	–	H1				
				hardened and tempered	55 HRC	–	H2				
				hardened and tempered	60 HRC	–	H3				
	Hardened cast iron			hardened and tempered	55 HRC	–	H4				
O	Thermoplasts			without abrasive fillers			O1				
	Thermosetting plastics			without abrasive fillers			O2				
	Plastic, glass-fibre reinforced			GFRP			O3				
	Plastic, carbon-fibre reinforced			CFRP			O4				
	Plastic, aramid-fibre reinforced			AFRP			O5				
	Graphite (technical)				80 Shore		O6				

¹ The machining groups are assigned from page H 8.

The specified cutting data are average recommended values.
For special applications, adjustment is recommended.

HSS																	
Family	Des.	λ	Page	Family	Des.	λ	Page	Family	Des.	λ	Page	Family	Des.	λ	Page		
NRA Kordel	P312011	35°	E 177	NR Kordel	P3120717	30°	E 181	HRA Kordel	P312021	35°	E 175	HNR Kordel	P3120937	30°	E 178		
G 35	P3120117		E 177	G 30	P352011		E 182	F 35	P3120217		E 175	F 30					
long				long					P312028		E 175	HR Kordel	P3128417	30°	E 179		
									P3120287		E 175	F 30					
									P4110217		E 176						
Dia. 6 – 50				Dia. 6 – 40				Dia. 5 – 40				Dia. 6 – 32					
Z = 4 – 6				Z = 4 – 6				Z = 3 – 6				Z = 4 – 6					
uncoated + ACN				uncoated + ACN				uncoated + ACN				ACN					
		a_e / D_c				a_e / D_c				a_e / D_c				a_e / D_c			
1/1	1/2	1/10	VT	1/1	1/2	1/10	VT	1/1	1/2	1/10	VT	1/1	1/2	1/10	VT		
40	40	60	A	40	50	70	A	50	60	90	A	50	60	90	A		
40	50	60	A	40	50	70	A	50	60	90	A	50	60	90	A		
20	20	30	A	20	20	30	A	20	30	40	A	20	30	40	A		
20	20	30	A	20	20	30	A	20	30	40	A	20	30	40	A		
10	20	20	A	20	20	30	A	20	20	30	A	20	20	30	A		
20	20	30	A	20	20	30	A	20	30	40	A	20	30	40	A		
20	20	30	A	20	20	30	A	20	30	40	A	20	30	40	A		
10	20	20	A	20	20	30	A	20	20	30	A	20	20	30	A		
								10	20	30	A	20	20	30	A		
								10	20	20	A	10	20	20	A		
20	20	30	A	20	20	30	A	20	30	40	A	20	30	40	A		
10	20	20	A	20	20	30	A	20	20	30	A	20	20	30	A		
								10	20	20	A	10	20	20	A		
10	10	10	A	10	10	20	A	10	10	20	A	10	10	20	A		
10	10	10	A	10	10	10	A	10	10	10	A	10	10	10	A		
10	20	20	B	10	20	30	B	20	20	30	B	20	20	30	B		
10	10	10	B	10	10	10	B	10	10	10	B	10	10	10	B		
10	10	10	B	10	10	20	B	10	10	20	B	10	10	20	B		
20	20	30	A	20	20	30	A	20	30	40	A	20	30	40	A		
10	20	20	A	10	20	20	A	20	20	30	A	20	20	30	A		
20	20	30	A	20	30	40	A	20	30	50	A	20	30	50	A		
20	20	30	A	20	20	30	A	20	30	40	A	20	30	40	A		
20	20	30	A	20	20	30	A	20	30	40	A	20	30	40	A		
10	20	20	A	10	20	20	A	20	20	30	A	20	20	30	A		
10	20	20	A	20	20	30	A	20	20	30	A	20	20	30	A		
80	100	130	C	100	120	150	C					120	140	180	C		
80	100	130	C	90	110	150	C					110	140	180	C		
50	60	80	C	50	70	90	C	60	80	110	C	60	80	110	C		
50	60	80	C	50	70	90	C	60	80	110	C	60	80	110	C		
30	30	50	C	30	40	50	C	30	40	60	C	30	40	60	C		
50	60	80	C	60	70	90	C	60	80	110	C	70	90	110	C		
50	60	90	C	60	70	100	C					70	90	130	C		
50	60	90	C	60	70	100	C	70	90	130	C	70	90	130	C		
50	70	90	C	60	70	100	C	70	90	130	C	70	90	130	C		
10	10	20	C	10	10	20	C	10	20	20	C	10	20	20	C		

Cutting data for shoulder / slot milling

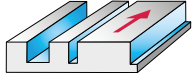

Cutting tool material		HSS			
Family	Des.	λ	Page		
HR Kordel F 30	P3120387	30°	E 179		
HNR Kordel F 30	P3120537	30°	E 178		

Material group	Classification of the main material groups and code letters		Brinell hardness HB	Tensile strength R _m N/mm ²	Machining group ¹	Dia. 6 – 32				
	Workpiece material					Z = 3 – 6				
						uncoated + ACN			VT	
						1/1	a _{ap} / D _c 1/2	1/10		
P	Unalloyed steel	C ≤ 0,25 %	annealed	125	428	P1	40	40	60	A
		C > 0,25... ≤ 0,55 %	annealed	190	639	P2	40	50	60	A
		C > 0,25... ≤ 0,55 %	tempered	210	708	P3	20	20	30	A
		C > 0,55 %	annealed	190	639	P4	20	20	30	A
		C > 0,55 %	tempered	300	1013	P5	10	20	20	A
		Free cutting steel (short-chipping)	annealed	220	745	P6	20	20	30	A
	Low-alloyed steel	annealed		175	591	P7	20	20	30	A
		tempered		300	1013	P8	10	20	20	A
		tempered		380	1282	P9	10	20	20	A
		tempered		430	1477	P10	10	10	20	A
	High-alloyed steel and high-alloyed tool steel	annealed		200	675	P11	20	20	30	A
		hardened and tempered		300	1013	P12	10	20	20	A
		hardened and tempered		400	1361	P13	10	10	20	A
	Stainless steel	ferritic / martensitic, annealed		200	675	P14	10	10	10	A
		martensitic, tempered		330	1114	P15	10	10	10	A
M	Stainless steel	austenitic, quench hardened		200	675	M1	10	20	20	B
		austenitic, precipitation hardened (PH)		300	1013	M2	10	10	10	B
		austenitic / ferritic, duplex		230	778	M3	10	10	10	B
K	Malleable cast iron	ferritic		200	675	K1	20	20	30	A
		pearlitic		260	867	K2	10	20	20	A
	Grey cast iron	low tensile strength		180	602	K3	20	20	30	A
		high tensile strength / austenitic		245	825	K4	20	20	30	A
	Cast iron with spheroidal graphite	ferritic		155	518	K5	20	20	30	A
		pearlitic		265	885	K6	10	20	20	A
GGV (CGI)			200	675	K7	10	20	20	A	
N	Aluminium wrought alloys	cannot be hardened		30	–	N1	80	100	130	C
		hardenable, hardened		100	343	N2	80	100	130	C
	Cast aluminium alloys	≤ 12 % Si, not hardenable		75	260	N3	50	60	80	C
		≤ 12 % Si, hardenable, hardened		90	314	N4	50	60	80	C
		> 12 % Si, not hardenable		130	447	N5	30	30	50	C
	Magnesium alloys			70	250	N6	50	60	80	C
Copper and copper alloys (bronze / brass)	unalloyed, electrolytic copper		100	343	N7	50	60	90	C	
	Brass, bronze, red brass		90	314	N8	50	70	90	C	
	Cu-alloys, short-chipping		110	382	N9	50	70	90	C	
	high-strength, Ampco		300	1013	N10	10	10	20	C	
S	Heat-resistant alloys	Fe-based	annealed	200	675	S1				
			hardened	280	943	S2				
		Ni or Co base	annealed	250	839	S3				
			hardened	350	1177	S4				
			cast	320	1076	S5				
	Titanium alloys	Pure titanium		200	675	S6				
		α and β alloys, hardened		375	1262	S7				
		β alloys		410	1396	S8				
	Tungsten alloys			300	1013	S9				
	Molybdenum alloys			300	1013	S10				
H	Hardened steel	hardened and tempered		50 HRC	–	H1				
		hardened and tempered		55 HRC	–	H2				
		hardened and tempered		60 HRC	–	H3				
	Hardened cast iron	hardened and tempered		55 HRC	–	H4				
O	Thermoplasts	without abrasive fillers				O1				
	Thermosetting plastics	without abrasive fillers				O2				
	Plastic, glass-fibre reinforced	GFRP				O3				
	Plastic, carbon-fibre reinforced	CFRP				O4				
	Plastic, aramid-fibre reinforced	AFRP				O5				
	Graphite (technical)			80 Shore		O6				

¹ The machining groups are assigned from page H 8.

Cutting data for shoulder / slot milling

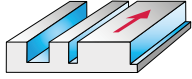

Cutting tool material	HSS			
	Family	Des.	λ	Page
	N 30	P020401	30°	E 126

Material group	Classification of the main material groups and code letters		Brinell hardness HB	Tensile strength R_m N/mm ²	Machining group ¹	Dia. 40 – 100					
	Workpiece material					Z = 8 – 12					
						uncoated + TiCN					
						a_g / D_c			VT		
						1/1	1/2	1/10			
P	Unalloyed steel	C ≤ 0,25 %	annealed	125	428	P1	46	60	86	A	
		C > 0,25... ≤ 0,55 %	annealed	190	639	P2	46	60	86	A	
		C > 0,25... ≤ 0,55 %	tempered	210	708	P3	22	29	41	A	
		C > 0,55 %	annealed	190	639	P4	22	29	41	A	
		C > 0,55 %	tempered	300	1013	P5	18	24	34	A	
		Free cutting steel (short-chipping)	annealed	220	745	P6	22	29	41	A	
	Low-alloyed steel			annealed	175	591	P7	22	29	41	A
				tempered	300	1013	P8	18	24	34	A
				tempered	380	1282	P9	14	19	27	A
				tempered	430	1477	P10	13	17	25	A
	High-alloyed steel and high-alloyed tool steel			annealed	200	675	P11	22	29	41	A
				hardened and tempered	300	1013	P12	18	24	34	A
				hardened and tempered	400	1361	P13	13	17	25	A
	Stainless steel			ferritic / martensitic, annealed	200	675	P14	11	14	20	A
				martensitic, tempered	330	1114	P15	7	9	12	A
M	Stainless steel	austenitic, quench hardened		200	675	M1	15	20	29	B	
		austenitic, precipitation hardened (PH)		300	1013	M2	7	9	12	B	
		austenitic / ferritic, duplex		230	778	M3	11	14	20	B	
K	Malleable cast iron	ferritic		200	675	K1	25	32	46	A	
		pearlitic		260	867	K2	15	20	29	A	
	Grey cast iron	low tensile strength		180	602	K3	25	33	48	A	
		high tensile strength / austenitic		245	825	K4	20	27	38	A	
	Cast iron with spheroidal graphite	ferritic		155	518	K5	25	32	46	A	
		pearlitic		265	885	K6	15	20	29	A	
GGV (CGI)			200	675	K7	16	21	30	A		
N	Aluminium wrought alloys	cannot be hardened		30	–	N1					
		hardenable, hardened		100	343	N2					
	Cast aluminium alloys	≤ 12 % Si, not hardenable		75	260	N3					
		≤ 12 % Si, hardenable, hardened		90	314	N4					
		> 12 % Si, not hardenable		130	447	N5					
	Magnesium alloys			70	250	N6					
		Copper and copper alloys (bronze / brass)	unalloyed, electrolytic copper		100	343	N7				
Brass, bronze, red brass			90	314	N8						
Cu-alloys, short-chipping			110	382	N9						
high-strength, Ampco			300	1013	N10						
S	Heat-resistant alloys	Fe-based	annealed	200	675	S1	13	17	25	B	
			hardened	280	943	S2	8	10	15	B	
		Ni or Co base	annealed	250	839	S3	13	17	25	B	
			hardened	350	1177	S4	8	10	15	B	
			cast	320	1076	S5	8	10	15	B	
	Titanium alloys	Pure titanium		200	675	S6					
		α and β alloys, hardened		375	1262	S7	14	18	26	B	
		β alloys		410	1396	S8	14	18	26	B	
	Tungsten alloys			300	1013	S9					
	Molybdenum alloys			300	1013	S10					
H	Hardened steel	hardened and tempered		50 HRC	–	H1					
		hardened and tempered		55 HRC	–	H2					
		hardened and tempered		60 HRC	–	H3					
	Hardened cast iron	hardened and tempered		55 HRC	–	H4					
O	Thermoplasts	without abrasive fillers				O1					
	Thermosetting plastics	without abrasive fillers				O2					
	Plastic, glass-fibre reinforced	GFRP				O3					
	Plastic, carbon-fibre reinforced	CFRP				O4					
	Plastic, aramid-fibre reinforced	AFRP				O5					
	Graphite (technical)			80 Shore		O6					

¹ The machining groups are assigned from page H 8.

The specified cutting data are average recommended values.
For special applications, adjustment is recommended.

HSS				
Family	Des.	λ	Page	
HR Kordel F 25	P020101	25°	E 183	
	P0201016		E 183	
Dia. 40 – 100				
Z = 8 – 12				
uncoated + TiCN				
	a _e / D _c			VT
	1/1	1/2	1/10	
50	60	90	A	
50	60	90	A	
20	30	40	A	
20	30	40	A	
20	20	30	A	
20	30	40	A	
20	30	40	A	
20	20	30	A	
10	20	30	A	
10	20	30	A	
20	30	40	A	
20	20	30	A	
10	20	30	A	
10	10	20	A	
10	10	10	A	
20	20	30	B	
10	10	10	B	
10	10	20	B	
30	30	50	A	
20	20	30	A	
30	30	50	A	
20	30	40	A	
30	30	50	A	
20	20	30	A	
20	20	30	A	
50	70	100	C	
90	120	170	C	
10	20	30	C	

Cutting data for shoulder / slot milling

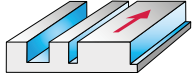

Cutting tool material	HSS			
	Family	Des.	λ	Page
	30	P311701	30°	E 132
		P301702		E 131
		P311702		E 131
		P3117017		E 132
		P3117027		E 131

Material group	Classification of the main material groups and code letters		Brinell hardness HB	Tensile strength R _m N/mm ²	Machining group ¹	Dia. 2.8 – 40					
						Z = 3					
	Workpiece material					uncoated + ACN					
						a _e / D _c		VT			
1/1	1/2	1/10									
P	Unalloyed steel	C ≤ 0,25 %	annealed	125	428	P1	50	70	100	A	
		C > 0,25... ≤ 0,55 %	annealed	190	639	P2	50	70	100	A	
		C > 0,25... ≤ 0,55 %	tempered	210	708	P3	20	30	50	A	
		C > 0,55 %	annealed	190	639	P4	20	30	50	A	
		C > 0,55 %	tempered	300	1013	P5	20	30	40	A	
		Free cutting steel (short-chipping)	annealed	220	745	P6	20	30	50	A	
	Low-alloyed steel			annealed	175	591	P7	20	30	50	A
				tempered	300	1013	P8	20	30	40	A
				tempered	380	1282	P9	20	20	30	A
				tempered	430	1477	P10	10	20	30	A
	High-alloyed steel and high-alloyed tool steel			annealed	200	675	P11	20	30	50	A
				hardened and tempered	300	1013	P12	20	30	40	A
				hardened and tempered	400	1361	P13	10	20	30	A
	Stainless steel			ferritic / martensitic, annealed	200	675	P14	10	20	20	A
				martensitic, tempered	330	1114	P15	10	10	20	A
M	Stainless steel	austenitic, quench hardened		200	675	M1	20	30	40	B	
		austenitic, precipitation hardened (PH)		300	1013	M2	10	10	20	B	
		austenitic / ferritic, duplex		230	778	M3	10	20	20	B	
K	Malleable cast iron	ferritic		200	675	K1	20	30	50	A	
		pearlitic		260	867	K2	20	20	30	A	
	Grey cast iron	low tensile strength		180	602	K3	30	40	50	A	
		high tensile strength / austenitic		245	825	K4	20	30	50	A	
	Cast iron with spheroidal graphite	ferritic		155	518	K5	20	30	50	A	
		pearlitic		265	885	K6	20	20	30	A	
	GGV (CGI)			200	675	K7	20	30	40	A	
N	Aluminium wrought alloys	cannot be hardened		30	–	N1					
		hardenable, hardened		100	343	N2					
	Cast aluminium alloys	≤ 12 % Si, not hardenable		75	260	N3					
		≤ 12 % Si, hardenable, hardened		90	314	N4					
		> 12 % Si, not hardenable		130	447	N5					
		Magnesium alloys			70	250	N6				
Copper and copper alloys (bronze / brass)	unalloyed, electrolytic copper		100	343	N7						
	Brass, bronze, red brass		90	314	N8						
	Cu-alloys, short-chipping		110	382	N9						
	high-strength, Ampco		300	1013	N10						
S	Heat-resistant alloys	Fe-based	annealed	200	675	S1					
			hardened	280	943	S2					
		Ni or Co base	annealed	250	839	S3					
			hardened	350	1177	S4					
			cast	320	1076	S5					
	Titanium alloys	Pure titanium		200	675	S6					
		α and β alloys, hardened		375	1262	S7					
		β alloys		410	1396	S8					
		Tungsten alloys			300	1013	S9				
		Molybdenum alloys			300	1013	S10				
H	Hardened steel	hardened and tempered		50 HRC	–	H1					
		hardened and tempered		55 HRC	–	H2					
		hardened and tempered		60 HRC	–	H3					
		Hardened cast iron	hardened and tempered		55 HRC	–	H4				
O	Thermoplasts		without abrasive fillers						01		
	Thermosetting plastics		without abrasive fillers						02		
	Plastic, glass-fibre reinforced		GFRP						03		
	Plastic, carbon-fibre reinforced		CFRP						04		
	Plastic, aramid-fibre reinforced		AFRP						05		
	Graphite (technical)				80 Shore				06		

¹ The machining groups are assigned from page H 8.

The specified cutting data are average recommended values.
For special applications, adjustment is recommended.

HSS				
Family	Des.	λ	Page	
U 30	P311601	30°	E 134	
	P3116017		E 134	
V 30	P311602	30°	E 134	
	P3116027		E 133	
Dia. 1.8 – 30				
Z = 2				
uncoated + ACN				
	a _e / D _c		VT	
1/1	1/2	1/10		
50	70	100	A	
50	70	100	A	
20	30	50	A	
20	30	50	A	
20	30	40	A	
20	30	50	A	
20	30	50	A	
20	30	40	A	
20	20	30	A	
10	20	30	A	
20	30	50	A	
20	30	40	A	
10	20	30	A	
10	20	20	A	
10	10	20	A	
20	30	40	B	
10	10	20	B	
10	20	20	B	
20	30	50	A	
20	20	30	A	
30	40	50	A	
20	30	50	A	
20	30	50	A	
20	20	30	A	
20	30	40	A	

Cutting data for copy milling

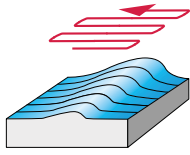

Cutting tool material	Solid carbide			
	Family	Des.	λ	Page
	ConeFit™ N 40	H8E11118 H8E01118	40° 40°	E 192 E 192

Material group	Classification of the main material groups and code letters		Brinell hardness HB	Tensile strength R _m N/mm ²	Machining group ¹	Dia. 10 – 25					
						Z = 2 + 4					
	Workpiece material					TAX			a _e / D _c	VT	
		1/5	1/20	1/50							
P	Unalloyed steel	C ≤ 0,25 %	annealed	125	428	P1	230	310	370	A	
		C > 0,25... ≤ 0,55 %	annealed	190	639	P2	220	300	360	A	
		C > 0,25... ≤ 0,55 %	tempered	210	708	P3	190	260	310	A	
		C > 0,55 %	annealed	190	639	P4	190	260	310	A	
		C > 0,55 %	tempered	300	1013	P5	150	180	220	A	
		Free cutting steel (short-chipping)	annealed	220	745	P6	190	260	310	A	
	Low-alloyed steel	annealed		175	591	P7	190	260	310	A	
		tempered		300	1013	P8	150	180	220	A	
		tempered		380	1282	P9	120	150	180	A	
		tempered		430	1477	P10	100	130	150	A	
	High-alloyed steel and high-alloyed tool steel	annealed		200	675	P11	190	260	310	A	
		hardened and tempered		300	1013	P12	150	180	220	A	
		hardened and tempered		400	1361	P13	100	130	150	A	
	Stainless steel	ferritic / martensitic, annealed		200	675	P14	70	90	100	A	
		martensitic, tempered		330	1114	P15	50	60	80	A	
M	Stainless steel	austenitic, quench hardened		200	675	M1	80	110	130	B	
		austenitic, precipitation hardened (PH)		300	1013	M2	50	60	80	B	
		austenitic / ferritic, duplex		230	778	M3	70	90	100	B	
K	Malleable cast iron	ferritic		200	675	K1	180	240	290	A	
		pearlitic		260	867	K2	150	190	220	A	
	Grey cast iron	low tensile strength		180	602	K3	180	240	290	A	
		high tensile strength / austenitic		245	825	K4	150	200	240	A	
	Cast iron with spheroidal graphite	ferritic		155	518	K5	180	240	290	A	
		pearlitic		265	885	K6	150	190	220	A	
GGV (CGI)			200	675	K7	130	160	190	A		
N	Aluminium wrought alloys	cannot be hardened		30	–	N1	1730	1740	1740	C	
		hardenable, hardened		100	343	N2	1740	1740	1740	C	
	Cast aluminium alloys	≤ 12 % Si, not hardenable		75	260	N3	690	920	1110	C	
		≤ 12 % Si, hardenable, hardened		90	314	N4	690	920	1110	C	
		> 12 % Si, not hardenable		130	447	N5	240	320	390	C	
	Magnesium alloys			70	250	N6	800	1060	1280	C	
Copper and copper alloys (bronze / brass)	unalloyed, electrolytic copper			100	343	N7	500	660	800	C	
	Brass, bronze, red brass			90	314	N8	500	660	800	C	
	Cu-alloys, short-chipping			110	382	N9	500	660	800	C	
	high-strength, Ampco			300	1013	N10	80	90	110	C	
S	Heat-resistant alloys	Fe-based	annealed		200	675	S1	60	90	110	B
			hardened		280	943	S2	40	50	70	B
		Ni or Co base	annealed		250	839	S3	60	90	110	B
			hardened		350	1177	S4	40	50	70	B
			cast		320	1076	S5	40	50	70	B
	Titanium alloys	Pure titanium			200	675	S6	210	300	380	B
		α and β alloys, hardened			375	1262	S7	60	100	130	B
		β alloys			410	1396	S8	60	100	130	B
	Tungsten alloys			300	1013	S9					
	Molybdenum alloys			300	1013	S10					
H	Hardened steel	hardened and tempered		50 HRC	–	H1	80	100	120	B	
		hardened and tempered		55 HRC	–	H2					
		hardened and tempered		60 HRC	–	H3					
	Hardened cast iron	hardened and tempered		55 HRC	–	H4					
O	Thermoplasts	without abrasive fillers				O1	400	530	640	C	
	Thermosetting plastics	without abrasive fillers				O2	200	270	320	C	
	Plastic, glass-fibre reinforced	GFRP				O3					
	Plastic, carbon-fibre reinforced	CFRP				O4					
	Plastic, aramid-fibre reinforced	AFRP				O5					
	Graphite (technical)			80 Shore		O6					

¹ The machining groups are assigned from page H 8.

The specified cutting data are average recommended values.
For special applications, adjustment is recommended.

Solid carbide													
Family				Des.				λ				Page	
30				H800111				30°				E 194	
				H8001118								E 194	
				H8011118								E 193	
				H8111118								E 193	
Family				Des.				λ				Page	
Mini				H404691				30°				E 206	
HSC 30				H4046918								E 206	
HSC 30				H8001918								E 196	
				H8006418								E 197	
				H8016418								E 197	
Family				Des.				λ				Page	
AL 30				H602111				30°				E 205	
Dia. 2 – 16				Dia. 0.3 – 16				Dia. 2 – 16					
Z = 2 + 4				Z = 2 + 4				Z = 2					
uncoated				uncoated + TAX				uncoated					
		a _e / D _c		VT				a _e / D _c		VT			
1/5	1/20	1/50		1/5	1/20	1/50		1/5	1/20	1/50		VT	
230	310	370	A	260	340	410	A						
220	300	360	A	250	330	400	A						
190	260	310	A	230	280	340	A						
190	260	310	A	230	280	340	A						
150	180	220	A	160	200	240	A						
190	260	310	A	230	280	340	A						
190	260	310	A	230	280	340	A						
150	180	220	A	160	200	240	A						
120	150	180	A	130	170	200	A						
100	130	150	A	110	140	170	A						
190	260	310	A	230	280	340	A						
150	180	220	A	160	200	240	A						
100	130	150	A	110	140	170	A						
70	90	100	A	80	100	120	A						
50	60	80	A	60	70	90	A						
80	110	130	B	100	120	140	B						
50	60	80	B	60	70	90	B						
70	90	100	B	80	100	120	B						
180	240	290	A	200	270	320	A						
150	190	220	A	170	210	250	A						
180	240	290	A	200	270	320	A						
150	200	240	A	180	220	270	A						
180	240	290	A	200	270	320	A						
150	190	220	A	170	210	250	A						
130	160	190	A	140	180	210	A						
1730	1740	1740	C	1450	1450	1450	C	1770	1790	1790	C		
1740	1740	1740	C	1450	1450	1450	C	1790	1790	1790	C		
690	920	1110	C	770	1030	1230	C	440	590	710	C		
690	920	1110	C	770	1030	1230	C	440	590	710	C		
240	320	390	C	270	360	430	C	180	240	280	C		
800	1060	1280	C	880	1180	1420	C	440	590	710	C		
500	660	800	C	550	740	890	C	270	350	430	C		
500	660	800	C	550	740	890	C	270	350	430	C		
500	660	800	C	550	740	890	C	270	350	430	C		
80	90	110	C	90	100	130	C						
60	90	110	B	70	100	130	B						
40	50	70	B	40	60	70	B						
60	90	110	B	70	100	130	B						
40	50	70	B	40	60	70	B						
40	50	70	B	40	60	70	B						
210	300	380	B	230	330	420	B						
60	100	130	B	70	110	140	B						
60	100	130	B	70	110	140	B						
80	100	120	B	90	110	130	B						
400	530	640	C	470	590	710	C	180	240	280	C		
200	270	320	C	220	300	360	C	130	180	210	C		

Cutting data for copy milling

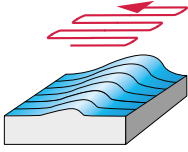

Cutting tool material	Solid carbide			
	Family	Des.	λ	Page
	HSC 30	H4046919	30°	E 207
		H8001919		E 198
		H8006419		E 199
		H8016419		E 199
	30	H8001119	30°	E 195

Material group	Classification of the main material groups and code letters		Brinell hardness HB	Tensile strength R _m N/mm ²	Machining group ¹	Dia. 0.3 – 12				
						Z = 2 + 4				
	Workpiece material					DIA				
						1/2	a _e / D _c 1/10	1/20	VT	
P	Unalloyed steel	C ≤ 0,25 %	annealed	125	428	P1				
		C > 0,25... ≤ 0,55 %	annealed	190	639	P2				
		C > 0,25... ≤ 0,55 %	tempered	210	708	P3				
		C > 0,55 %	annealed	190	639	P4				
		C > 0,55 %	tempered	300	1013	P5				
		Free cutting steel (short-chipping)	annealed	220	745	P6				
	Low-alloyed steel		annealed	175	591	P7				
			tempered	300	1013	P8				
			tempered	380	1282	P9				
			tempered	430	1477	P10				
	High-alloyed steel and high-alloyed tool steel		annealed	200	675	P11				
			hardened and tempered	300	1013	P12				
			hardened and tempered	400	1361	P13				
	Stainless steel		ferritic / martensitic, annealed	200	675	P14				
			martensitic, tempered	330	1114	P15				
M	Stainless steel		austenitic, quench hardened	200	675	M1				
			austenitic, precipitation hardened (PH)	300	1013	M2				
			austenitic / ferritic, duplex	230	778	M3				
K	Malleable cast iron		ferritic	200	675	K1				
			pearlitic	260	867	K2				
	Grey cast iron		low tensile strength	180	602	K3				
			high tensile strength / austenitic	245	825	K4				
	Cast iron with spheroidal graphite		ferritic	155	518	K5				
			pearlitic	265	885	K6				
	GGV (CGI)			200	675	K7				
N	Aluminium wrought alloys		cannot be hardened	30	–	N1				
			hardenable, hardened	100	343	N2				
	Cast aluminium alloys		≤ 12 % Si, not hardenable	75	260	N3				
			≤ 12 % Si, hardenable, hardened	90	314	N4				
			> 12 % Si, not hardenable	130	447	N5				
	Magnesium alloys			70	250	N6				
		Copper and copper alloys (bronze / brass)		unalloyed, electrolytic copper	100	343	N7			
	Brass, bronze, red brass		90	314	N8					
	Cu-alloys, short-chipping		110	382	N9					
	high-strength, Ampco		300	1013	N10					
S	Heat-resistant alloys	Fe-based	annealed	200	675	S1				
			hardened	280	943	S2				
		Ni or Co base	annealed	250	839	S3				
			hardened	350	1177	S4				
			cast	320	1076	S5				
	Titanium alloys		Pure titanium	200	675	S6				
			α and β alloys, hardened	375	1262	S7				
			β alloys	410	1396	S8				
	Tungsten alloys			300	1013	S9				
	Molybdenum alloys			300	1013	S10				
H	Hardened steel		hardened and tempered	50 HRC	–	H1				
			hardened and tempered	55 HRC	–	H2				
			hardened and tempered	60 HRC	–	H3				
	Hardened cast iron		hardened and tempered	55 HRC	–	H4				
O	Thermoplasts		without abrasive fillers			O1				
	Thermosetting plastics		without abrasive fillers			O2				
	Plastic, glass-fibre reinforced		GFRP			O3				
	Plastic, carbon-fibre reinforced		CFRP			O4				
	Plastic, aramid-fibre reinforced		AFRP			O5				
	Graphite (technical)			80 Shore			O6	500	700	800

¹ The machining groups are assigned from page H 8.

The specified cutting data are average recommended values.
For special applications, adjustment is recommended.

Solid carbide								HSS							
Family	Des.	λ	Page	Family	Des.	λ	Page	Family	Des.	λ	Page	Family	Des.	λ	Page
Ultra	H4046928	30°	E 208	Ultra	H8014028	30°	E 203	30	P312674	30°	E 209	30	P3166117	30°	E 211
HSC 30	H8004028		E 200	HSC 30	H8014128		E 204		P316601		E 210		P8112017		E 212
(48-63 HRC)	H8004128		E 200	(48-63 HRC)	H8016428		E 202		P3166017		E 210		P811211		E 212
	H8004728		E 201		H8074128		E 203		P316611		E 211				
	H8006428		E 202												
Dia. 0.3 – 16				Dia. 3 – 16				Dia. 2 – 30				Dia. 3 – 32			
Z = 2				Z = 2 + 4				Z = 2				Z = 2 – 6			
TAX				TAX				uncoated + ACN				uncoated + ACN			
	a_e / D_c		VT		a_e / D_c		VT		a_e / D_c		VT		a_e / D_c		VT
1/10	1/20	1/50		1/10	1/20	1/50		1/5	1/20	1/50		1/5	1/20	1/50	
								110	140	170	A	90	120	140	A
								110	140	170	A	90	120	140	A
								50	60	80	A	40	50	60	A
								50	60	80	A	40	50	60	A
								40	50	60	A	30	50	50	A
								50	60	80	A	40	50	60	A
								50	60	80	A	40	50	60	A
								40	50	60	A	30	50	50	A
								30	40	50	A	30	40	50	A
160	180	220	A					30	40	40	A	20	30	40	A
								50	60	80	A	40	50	60	A
								40	50	60	A	30	50	50	A
								30	40	40	A	20	30	40	A
								20	30	40	A	20	30	30	A
								20	20	30	A	10	20	20	A
								40	50	60	B	30	40	50	B
								20	20	30	B	10	20	20	B
								20	30	40	B	20	30	30	B
								50	60	80	A	40	50	60	A
								40	50	60	A	30	40	50	A
								60	70	90	A	50	60	80	A
								50	60	80	A	40	50	60	A
								50	60	80	A	40	50	60	A
								40	50	60	A	30	40	50	A
								40	50	60	A	30	40	50	A
								40	50	60	A	30	40	50	A
								330	430	520	C	270	360	440	C
								330	430	520	C	270	360	440	C
								190	250	300	C	160	210	250	C
								190	250	300	C	160	210	250	C
								110	150	180	C	90	130	150	C
								200	270	320	C	170	220	270	C
								220	300	360	C	190	250	300	C
								220	300	360	C	190	250	300	C
								220	300	360	C	190	250	300	C
								30	40	50	C	20	30	40	C
								30	40	50	B	20	30	40	B
								20	20	30	B	10	20	20	B
								30	40	50	B	20	30	40	B
								20	20	30	B	10	20	20	B
								20	20	30	B	10	20	20	B
								60	80	100	B	50	70	80	B
								40	50	60	B	30	40	50	B
								40	50	60	B	30	40	50	B
								120	140	170	B	90	110	130	B
								130	140	170	B	100	110	130	B
								80	80	100	B	80	90	100	B
								130	140	170	B	100	110	130	B

Cutting data for profile milling

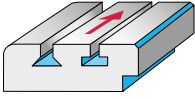

Cutting tool material	Solid carbide			
	Family	Des.	λ	Page
	ConeFit™ Chamfer milling cutter 60°	H3E58518	0°	E 220
	90°	H3E58318	0°	E 219
120°	H3E58118	0°	E 218	

Material group	Classification of the main material groups and code letters		Brinell hardness HB	Tensile strength R _m N/mm ²	Machining group ¹	Dia. 12					
						Z = 6					
	Workpiece material					TAX			a _e / D _c	VT	
		1/3	1/10	1/20							
P	Unalloyed steel	C ≤ 0,25 %	annealed	125	428	P1	220	320	380	A	
		C > 0,25... ≤ 0,55 %	annealed	190	639	P2	220	320	380	A	
		C > 0,25... ≤ 0,55 %	tempered	210	708	P3	180	260	320	A	
		C > 0,55 %	annealed	190	639	P4	180	260	320	A	
		C > 0,55 %	tempered	300	1013	P5	130	180	230	A	
		Free cutting steel (short-chipping)	annealed	220	745	P6	180	260	320	A	
	Low-alloyed steel	annealed		175	591	P7	180	260	320	A	
		tempered		300	1013	P8	130	180	230	A	
		tempered		380	1282	P9	110	150	170	A	
		tempered		430	1477	P10	90	130	160	A	
	High-alloyed steel and high-alloyed tool steel	annealed		200	675	P11	180	260	320	A	
		hardened and tempered		300	1013	P12	130	180	230	A	
		hardened and tempered		400	1361	P13	90	130	160	A	
	Stainless steel	ferritic / martensitic, annealed		200	675	P14	60	90	110	A	
		martensitic, tempered		330	1114	P15	50	70	80	A	
M	Stainless steel	austenitic, quench hardened		200	675	M1	80	110	130	B	
		austenitic, precipitation hardened (PH)		300	1013	M2	50	70	80	B	
		austenitic / ferritic, duplex		230	778	M3	60	90	110	B	
K	Malleable cast iron	ferritic		200	675	K1	170	240	300	A	
		pearlitic		260	867	K2	130	190	230	A	
	Grey cast iron	low tensile strength		180	602	K3	170	240	300	A	
		high tensile strength / austenitic		245	825	K4	170	240	300	A	
	Cast iron with spheroidal graphite	ferritic		155	518	K5	170	240	300	A	
		pearlitic		265	885	K6	130	190	230	A	
GGV (CGI)			200	675	K7	110	160	200	A		
N	Aluminium wrought alloys	cannot be hardened		30	–	N1	1600	2300	2900	C	
		hardenable, hardened		100	343	N2	1600	2300	2900	C	
	Cast aluminium alloys	≤ 12 % Si, not hardenable		75	260	N3	260	370	450	C	
		≤ 12 % Si, hardenable, hardened		90	314	N4	260	370	450	C	
		> 12 % Si, not hardenable		130	447	N5	170	240	300	C	
	Magnesium alloys			70	250	N6	750	1100	1300	C	
	Copper and copper alloys (bronze / brass)	unalloyed, electrolytic copper			100	343	N7	480	680	840	C
Brass, bronze, red brass			90	314	N8	480	680	840	C		
Cu-alloys, short-chipping			110	382	N9	480	680	840	C		
high-strength, Ampco			300	1013	N10	70	100	120	C		
S	Heat-resistant alloys	Fe-based	annealed		200	675	S1	60	90	110	B
			hardened		280	943	S2	40	50	70	B
		Ni or Co base	annealed		250	839	S3	60	90	110	B
			hardened		350	1177	S4	40	50	70	B
			cast		320	1076	S5	40	50	70	B
	Titanium alloys	Pure titanium			200	675	S6	200	290	370	B
		α and β alloys, hardened			375	1262	S7	60	90	120	B
		β alloys			410	1396	S8	60	90	120	B
	Tungsten alloys			300	1013	S9	70	100	120	B	
	Molybdenum alloys			300	1013	S10	70	100	120	B	
H	Hardened steel	hardened and tempered		50 HRC	–	H1	70	100	120	B	
		hardened and tempered		55 HRC	–	H2					
		hardened and tempered		60 HRC	–	H3					
	Hardened cast iron	hardened and tempered		55 HRC	–	H4					
O	Thermoplasts	without abrasive fillers				O1	380	550	670	C	
	Thermosetting plastics	without abrasive fillers				O2					
	Plastic, glass-fibre reinforced	GFRP				O3					
	Plastic, carbon-fibre reinforced	CFRP				O4					
	Plastic, aramid-fibre reinforced	AFRP				O5					
	Graphite (technical)			80 Shore		O6					

¹ The machining groups are assigned from page H 8.

The specified cutting data are average recommended values.
For special applications, adjustment is recommended.

Solid carbide										Solid carbide				Solid carbide			
Family	Des.	λ	Page	Family	Des.	λ	Page	Family	Des.	λ	Page	Family	Des.	λ	Page		
Chamfer milling cutter 60°	H305851	0°	E 220	Chamfer milling cutter 90°	H305831	0°	E 219	Forwards / reverse deburrer	H3053918	0°	E 221	ConeFit™ Quarter-round profile milling cutters	H3E68118	0°	E 222		
	H3058518	E 220	H3058318		E 219												
	H3158518	E 220	H3158318		E 219												
					120°	0°	E 218					Quarter-round profile milling cutters	H3068118	0°	E 222		
Dia. 6 + 10				Dia. 6 – 12				Dia. 6 – 12				Dia. 4 – 20					
Z = 4				Z = 4 – 6				Z = 4 + 6				Z = 3 + 4					
uncoated + TAX				uncoated + TAX				TAX				TAX					
		a_e / D_c				VT				a_e / D_c				VT			
	1/3	1/10	1/20		1/3	1/10	1/20		1/10	1/20	1/50		Radius		VT		
	220	320	380	A	220	320	380	A	220	320	380	A	310		A		
	220	320	380	A	220	320	380	A	220	320	380	A	310		A		
	180	260	320	A	180	260	320	A	180	260	320	A	260		A		
	180	260	320	A	180	260	320	A	180	260	320	A	260		A		
	130	180	230	A	130	180	230	A	130	180	230	A	190		A		
	180	260	320	A	180	260	320	A	180	260	320	A	260		A		
	180	260	320	A	180	260	320	A	180	260	320	A	260		A		
	130	180	230	A	130	180	230	A	130	180	230	A	190		A		
	110	150	170	A	110	150	170	A	110	150	170	A	150		A		
	90	130	160	A	90	130	160	A	90	130	160	A	130		A		
	180	260	320	A	180	260	320	A	180	260	320	A	260		A		
	130	180	230	A	130	180	230	A	130	180	230	A	190		A		
	90	130	160	A	90	130	160	A	90	130	160	A	130		A		
	60	90	110	A	60	90	110	A	60	90	110	A	90		A		
	50	70	80	A	50	70	80	A	50	70	80	A	70		A		
	80	110	130	B	80	110	130	B	80	110	130	B	100		B		
	50	70	80	B	50	70	80	B	50	70	80	B	70		B		
	60	90	110	B	60	90	110	B	60	90	110	B	90		B		
	170	240	300	A	170	240	300	A	170	240	300	A	240		A		
	130	190	230	A	130	190	230	A	130	190	230	A	190		A		
	170	240	300	A	170	240	300	A	170	240	300	A	240		A		
	170	240	300	A	170	240	300	A	170	240	300	A	200		A		
	170	240	300	A	170	240	300	A	170	240	300	A	240		A		
	130	190	230	A	130	190	230	A	130	190	230	A	190		A		
	110	160	200	A	110	160	200	A	110	160	200	A	120		A		
	1600	2300	2900	C	1600	2300	2900	C	1600	2300	2900	C	2300		C		
	1600	2300	2900	C	1600	2300	2900	C	1600	2300	2900	C	2300		C		
	260	370	450	C	260	370	450	C	260	370	450	C	370		C		
	260	370	450	C	260	370	450	C	260	370	450	C	370		C		
	170	240	300	C	170	240	300	C	170	240	300	C	240		C		
	750	1100	1300	C	750	1100	1300	C	750	1100	1300	C	1100		C		
	480	680	840	C	480	680	840	C	480	680	840	C	680		C		
	480	680	840	C	480	680	840	C	480	680	840	C	680		C		
	480	680	840	C	480	680	840	C	480	680	840	C	680		C		
	70	100	120	C	70	100	120	C	70	100	120	C	100		C		
	60	90	110	B	60	90	110	B	60	90	110	B	90		B		
	40	50	70	B	40	50	70	B	40	50	70	B	50		B		
	60	90	110	B	60	90	110	B	60	90	110	B	90		B		
	40	50	70	B	40	50	70	B	40	50	70	B	50		B		
	40	50	70	B	40	50	70	B	40	50	70	B	50		B		
	200	290	370	B	200	290	370	B	200	290	370	B	280		B		
	60	90	120	B	60	90	120	B	60	90	120	B	80		B		
	60	90	120	B	60	90	120	B	60	90	120	B	80		B		
	70	100	120	B	70	100	120	B	70	100	120	B	100		B		
	70	100	120	B	70	100	120	B	70	100	120	B	100		B		
	70	100	120	B	70	100	120	B	70	100	120	B	100		B		
	380	550	670	C	380	550	670	C	380	550	670	C	540		C		

Cutting data for profile milling

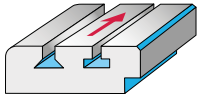

Cutting tool material	Solid carbide			
	Family	Des.	λ	Page
N 10 Keyway cutters	P313231		10°	E 225
	P313211			E 225

Material group	Classification of the main material groups and code letters		Brinell hardness HB	Tensile strength R _m N/mm ²	Machining group ¹	Dia. 4.5 – 45.5					
						Z = 6 – 14					
	Workpiece material					uncoated		a _e / D _c		VT	
1/1			1/2								
P	Unalloyed steel	C ≤ 0,25 %	annealed	125	428	P1	30	40		A	
		C > 0,25... ≤ 0,55 %	annealed	190	639	P2	30	40		A	
		C > 0,25... ≤ 0,55 %	tempered	210	708	P3	20	30		A	
		C > 0,55 %	annealed	190	639	P4	20	30		A	
		C > 0,55 %	tempered	300	1013	P5	20	30		A	
		Free cutting steel (short-chipping)	annealed	220	745	P6	20	30		A	
	Low-alloyed steel		annealed		175	591	P7	20	30		A
			tempered		300	1013	P8	20	30		A
			tempered		380	1282	P9	10	20		A
			tempered		430	1477	P10	10	20		A
	High-alloyed steel and high-alloyed tool steel		annealed		200	675	P11	20	30		A
			hardened and tempered		300	1013	P12	20	30		A
			hardened and tempered		400	1361	P13	10	20		A
	Stainless steel		ferritic / martensitic, annealed		200	675	P14	10	10		A
			martensitic, tempered		330	1114	P15	10	10		A
M	Stainless steel		austenitic, quench hardened	200	675	M1	10	20		B	
			austenitic, precipitation hardened (PH)	300	1013	M2	10	10		B	
			austenitic / ferritic, duplex	230	778	M3	10	10		B	
K	Malleable cast iron		ferritic	200	675	K1	20	30		A	
			pearlitic	260	867	K2	10	20		A	
	Grey cast iron		low tensile strength	180	602	K3	20	30		A	
			high tensile strength / austenitic	245	825	K4	20	30		A	
	Cast iron with spheroidal graphite		ferritic	155	518	K5	20	30		A	
			pearlitic	265	885	K6	10	20		A	
	GGV (CGI)			200	675	K7	10	20		A	
N	Aluminium wrought alloys		cannot be hardened	30	–	N1	200	300		C	
			hardenable, hardened	100	343	N2	200	300		C	
	Cast aluminium alloys		≤ 12 % Si, not hardenable	75	260	N3	40	50		C	
			≤ 12 % Si, hardenable, hardened	90	314	N4	40	50		C	
	Magnesium alloys		> 12 % Si, not hardenable	130	447	N5	30	40		C	
				70	250	N6	70	90		C	
Copper and copper alloys (bronze / brass)		unalloyed, electrolytic copper		100	343	N7	100	130		C	
		Brass, bronze, red brass		90	314	N8	100	130		C	
		Cu-alloys, short-chipping		110	382	N9	100	130		C	
		high-strength, Ampco		300	1013	N10	10	20		C	
S	Heat-resistant alloys	Fe-based	annealed	200	675	S1					
			hardened	280	943	S2					
		Ni or Co base	annealed	250	839	S3					
			hardened	350	1177	S4					
			cast	320	1076	S5					
	Titanium alloys		Pure titanium		200	675	S6				
			α and β alloys, hardened		375	1262	S7				
			β alloys		410	1396	S8				
		Tungsten alloys		300	1013	S9					
		Molybdenum alloys		300	1013	S10					
H	Hardened steel		hardened and tempered	50 HRC	–	H1					
			hardened and tempered	55 HRC	–	H2					
			hardened and tempered	60 HRC	–	H3					
		Hardened cast iron		hardened and tempered	55 HRC	–	H4				
O		Thermoplasts	without abrasive fillers			O1	100	130		C	
		Thermosetting plastics	without abrasive fillers			O2					
		Plastic, glass-fibre reinforced	GFRP			O3					
		Plastic, carbon-fibre reinforced	CFRP			O4					
		Plastic, aramid-fibre reinforced	AFRP			O5					
		Graphite (technical)			80 Shore		O6				

¹ The machining groups are assigned from page H 8.

The specified cutting data are average recommended values.
For special applications, adjustment is recommended.

Solid carbide				Solid carbide				Solid carbide				Solid carbide					
Family	Des.	λ	Page	Family	Des.	λ	Page	Family	Des.	λ	Page	Family	Des.	λ	Page		
N 12 T-slot milling cutter	P314801	12°	E 223	Kordel F 12 T-slot milling cutter	P314101	12°	E 224	Dovetail milling cutters	P315801	0°	E 227	Quarter- round profile milling cutters	P316881	0°	E 226		
	P3148016	E 223				P315821	E 227										
						P315831	E 228										
						P315851	E 228										
	Dia. 16 – 50				Dia. 16 – 50				Dia. 12 – 32				Dia. 8 – 20				
	Z = 6 – 10				Z = 6 – 10				Z = 10 – 12				Z = 4 – 6				
	uncoated + TiCN				uncoated				uncoated				uncoated				
			a _e / D _c				VT				a _e / D _c				VT		
	1/1	1/2				1/1	1/2			1/3	1/10	1/20			Radius		VT
	30	40			A	30	40		A	30	40	40	A		35		A
30	40		A	30	40		A	30	40	40	A		35		A		
20	30		A	20	30		A	20	30	30	A		25		A		
20	30		A	20	30		A	20	30	30	A		25		A		
20	30		A	20	30		A	10	20	30	A		20		A		
20	30		A	20	30		A	20	30	30	A		25		A		
20	30		A	20	30		A	20	30	30	A		25		A		
20	30		A	20	30		A	10	20	30	A		20		A		
10	20		A	10	20		A	10	20	20	A		15		A		
10	20		A	10	20		A	10	10	20	A		13		A		
20	30		A	20	30		A	20	30	30	A		25		A		
20	30		A	20	30		A	10	20	30	A		20		A		
10	20		A	10	20		A	10	10	20	A		13		A		
10	10		A	10	10		A	10	10	20	A		10		A		
10	10		A	10	10		A	10	10	10	A		8		A		
10	20		B	10	20		B	10	20	20	B		15		B		
10	10		B	10	10		B	10	10	10	B		8		B		
10	10		B	10	10		B	10	10	20	B		10		B		
20	30		A	20	30		A	20	30	30	A		25		A		
10	20		A	10	20		A	10	20	20	A		15		A		
20	30		A	20	30		A	0	0	0	A		0		A		
20	30		A	20	30		A	0	0	0	A		0		A		
20	30		A	20	30		A	20	30	30	A		25		A		
10	20		A	10	20		A	10	20	20	A		15		A		
10	20		A	10	20		A	20	30	30	A		25		A		
200	300		C	200	300		C	150	250	300	C		250		C		
200	300		C	200	300		C	150	250	300	C		250		C		
40	50		C	40	50		C	30	40	50	C		40		C		
40	50		C	40	50		C	30	40	50	C		40		C		
30	40		C	30	40		C	20	40	50	C		35		C		
70	90		C	70	90		C	50	70	90	C		70		C		
100	130		C	100	130		C	70	110	140	C		110		C		
100	130		C	100	130		C	70	110	140	C		110		C		
100	130		C	100	130		C	70	110	140	C		110		C		
10	20		C	10	20		C	10	20	20	C		15		C		
								10	10	20	B		13		B		
								4	10	10	B		7		B		
								10	10	20	B		13		B		
								4	10	10	B		7		B		
								4	10	10	B		7		B		
								20	40	50	B		35		B		
								10	20	30	B		20		B		
								10	20	30	B		20		B		
								4	10	10	B		7		B		
								4	10	10	B		7		B		
															B		
				100	130		C								C		
													50				

Feed matrices – f_z table

The specified feed rates are average recommended values.
For special applications, adjustment is recommended.

A Material groups ISO P, ISO K and titanium alloys

a_e [mm]*	Feed per tooth f_z [mm]										
	Dia. 0.3 mm	Dia. 0.5 mm	Dia. 1 mm	Dia. 2 mm	Dia. 3 mm	Dia. 4 mm	Dia. 6 mm	Dia. 8 mm	Dia. 10 mm	Dia. 12 mm	Dia. 14 mm
0,01	0,02	0,02	0,03	0,06	0,09	0,12	0,15	0,15	0,20		
0,05	0,01	0,01	0,02	0,04	0,07	0,10	0,12	0,15	0,20		
0,1	0,01	0,01	0,02	0,03	0,05	0,08	0,10	0,15	0,20	0,20	0,20
0,2	0,01	0,01	0,01	0,03	0,04	0,06	0,08	0,15	0,18	0,20	0,20
0,5		0,01	0,01	0,02	0,03	0,05	0,07	0,12	0,15	0,15	0,15
1			0,01	0,02	0,03	0,04	0,06	0,09	0,12	0,12	0,12
2				0,02	0,03	0,03	0,05	0,08	0,11	0,12	0,12
3					0,02	0,02	0,04	0,07	0,10	0,12	0,12
5						0,02	0,04	0,07	0,10	0,12	0,12
6							0,03	0,06	0,08	0,10	0,10
8								0,05	0,07	0,09	0,10
10									0,06	0,08	0,10
12										0,07	0,09
14											0,08
16											
18											
20											
25											
32											
40											
50											
63											
80											
100											
160											
200											

A (continued)

a_e [mm]*	Feed per tooth f_z [mm]											
	Dia. 16 mm	Dia. 18 mm	Dia. 20 mm	Dia. 25 mm	Dia. 32 mm	Dia. 40 mm	Dia. 50 mm	Dia. 63 mm	Dia. 80 mm	Dia. 100 mm	Dia. 160 mm	Dia. 200 mm
0,01												
0,05												
0,1	0,20											
0,2	0,20	0,20	0,25									
0,5	0,15	0,20	0,25	0,25								
1	0,12	0,15	0,20	0,25	0,25	0,30	0,30	0,30	0,40	0,40	0,50	0,50
2	0,12	0,15	0,20	0,20	0,25	0,25	0,25	0,30	0,30	0,40	0,40	0,40
3	0,12	0,14	0,18	0,20	0,20	0,25	0,25	0,25	0,30	0,30	0,40	0,40
5	0,12	0,12	0,15	0,20	0,20	0,20	0,25	0,25	0,25	0,30	0,30	0,30
6	0,12	0,12	0,15	0,20	0,20	0,20	0,20	0,25	0,25	0,25	0,30	0,30
8	0,12	0,12	0,15	0,20	0,20	0,20	0,20	0,20	0,25	0,25	0,25	0,25
10	0,12	0,12	0,14	0,16	0,20	0,20	0,20	0,20	0,20	0,25	0,25	0,25
12	0,11	0,12	0,14	0,16	0,16	0,20	0,20	0,20	0,20	0,20	0,25	0,25
14	0,10	0,12	0,13	0,15	0,16	0,16	0,20	0,20	0,20	0,20	0,20	0,25
16	0,09	0,10	0,12	0,15	0,15	0,16	0,16	0,20	0,20	0,20	0,20	0,20
18		0,10	0,11	0,13	0,15	0,15	0,16	0,16	0,20	0,20	0,20	0,20
20			0,10	0,12	0,13	0,15	0,15	0,16	0,16	0,20	0,20	0,20
25				0,10	0,12	0,13	0,15	0,15	0,16	0,16	0,20	0,20
32					0,10	0,12	0,13	0,15	0,15	0,16	0,16	0,20
40						0,10	0,12	0,13	0,15	0,15	0,16	0,16
50							0,10	0,12	0,13	0,15	0,15	0,16
63								0,10	0,12	0,13	0,15	0,15
80									0,10	0,12	0,13	0,15
100										0,10	0,12	0,13
160											0,10	0,12
200												0,10

*radial feed in mm.

The specified feed rates are average recommended values.
For special applications, adjustment is recommended.

B Material groups ISO M, ISO H, heat-resistant alloys, tungsten alloys and molybdenum alloys

a _e [mm]*	Feed per tooth f _z [mm]										
	Dia. 0.3 mm	Dia. 0.5 mm	Dia. 1 mm	Dia. 2 mm	Dia. 3 mm	Dia. 4 mm	Dia. 6 mm	Dia. 8 mm	Dia. 10 mm	Dia. 12 mm	Dia. 14 mm
0,01	0,02	0,02	0,02	0,05	0,07	0,10	0,12	0,12	0,16		
0,05	0,01	0,01	0,02	0,03	0,06	0,08	0,10	0,12	0,16		
0,1	0,01	0,01	0,02	0,03	0,04	0,06	0,08	0,12	0,16	0,16	0,16
0,2	0,01	0,01	0,01	0,02	0,03	0,05	0,06	0,12	0,14	0,16	0,16
0,5		0,01	0,01	0,02	0,02	0,04	0,06	0,10	0,12	0,12	0,12
1			0,01	0,02	0,02	0,03	0,05	0,07	0,10	0,10	0,10
2				0,02	0,02	0,02	0,04	0,06	0,09	0,10	0,10
3					0,02	0,02	0,04	0,06	0,08	0,10	0,10
5						0,02	0,03	0,06	0,08	0,10	0,10
6							0,02	0,05	0,06	0,08	0,08
8								0,04	0,06	0,07	0,08
10									0,05	0,06	0,08
12										0,06	0,07
14											0,06
16											
18											
20											
25											
32											
40											
50											
63											
80											
100											
160											
200											

B (continued)

a _e [mm]*	Feed per tooth f _z [mm]											
	Dia. 16 mm	Dia. 18 mm	Dia. 20 mm	Dia. 25 mm	Dia. 32 mm	Dia. 40 mm	Dia. 50 mm	Dia. 63 mm	Dia. 80 mm	Dia. 100 mm	Dia. 160 mm	Dia. 200 mm
0,01												
0,05												
0,1	0,16											
0,2	0,16	0,16	0,20									
0,5	0,12	0,16	0,20	0,20								
1	0,10	0,12	0,16	0,20	0,20	0,24	0,24	0,24	0,32	0,32	0,40	0,40
2	0,10	0,12	0,16	0,16	0,20	0,20	0,20	0,24	0,24	0,32	0,32	0,32
3	0,10	0,11	0,14	0,16	0,16	0,20	0,20	0,20	0,24	0,24	0,32	0,32
5	0,10	0,10	0,12	0,16	0,16	0,16	0,20	0,20	0,20	0,24	0,24	0,24
6	0,10	0,10	0,12	0,16	0,16	0,16	0,16	0,20	0,20	0,20	0,24	0,24
8	0,10	0,10	0,12	0,16	0,16	0,16	0,16	0,16	0,20	0,20	0,20	0,20
10	0,10	0,10	0,11	0,13	0,16	0,16	0,16	0,16	0,16	0,20	0,20	0,20
12	0,09	0,10	0,11	0,13	0,13	0,16	0,16	0,16	0,16	0,16	0,20	0,20
14	0,08	0,10	0,10	0,12	0,13	0,13	0,16	0,16	0,16	0,16	0,16	0,20
16	0,07	0,08	0,10	0,12	0,12	0,13	0,13	0,16	0,16	0,16	0,16	0,16
18		0,08	0,09	0,10	0,12	0,12	0,13	0,13	0,16	0,16	0,16	0,16
20			0,08	0,10	0,10	0,12	0,12	0,13	0,13	0,16	0,16	0,16
25				0,08	0,10	0,10	0,12	0,12	0,13	0,13	0,16	0,16
32					0,08	0,10	0,10	0,12	0,12	0,13	0,13	0,16
40						0,08	0,10	0,10	0,12	0,12	0,13	0,13
50							0,08	0,10	0,10	0,12	0,12	0,13
63								0,08	0,10	0,10	0,12	0,12
80									0,08	0,10	0,10	0,12
100										0,08	0,10	0,10
160											0,08	0,10
200												0,08

*radial feed in mm.

Feed matrices – f_z table

The specified feed rates are average recommended values.
For special applications, adjustment is recommended.

C Material groups ISO N and ISO O

a_e [mm]*	Feed per tooth f_z [mm]										
	Dia. 0.3 mm	Dia. 0.5 mm	Dia. 1 mm	Dia. 2 mm	Dia. 3 mm	Dia. 4 mm	Dia. 6 mm	Dia. 8 mm	Dia. 10 mm	Dia. 12 mm	Dia. 14 mm
0,01	0,04	0,04	0,07	0,13	0,20	0,26	0,33	0,33	0,44		
0,05	0,03	0,03	0,06	0,09	0,15	0,22	0,26	0,33	0,44		
0,1	0,02	0,03	0,04	0,08	0,11	0,18	0,22	0,33	0,44	0,44	0,44
0,2	0,02	0,02	0,03	0,07	0,09	0,13	0,18	0,33	0,40	0,44	0,44
0,5		0,02	0,03	0,06	0,07	0,11	0,15	0,26	0,33	0,33	0,33
1			0,02	0,06	0,07	0,09	0,13	0,20	0,26	0,26	0,26
2				0,04	0,07	0,07	0,11	0,18	0,24	0,26	0,26
3					0,04	0,06	0,10	0,17	0,23	0,26	0,26
5						0,04	0,09	0,15	0,22	0,26	0,26
6							0,07	0,13	0,18	0,22	0,22
8								0,11	0,15	0,20	0,22
10									0,13	0,18	0,22
12										0,15	0,20
14											0,18
16											
18											
20											
25											
32											
40											
50											
63											
80											
100											
160											
200											

C (continued)

a_e [mm]*	Feed per tooth f_z [mm]											
	Dia. 16 mm	Dia. 18 mm	Dia. 20 mm	Dia. 25 mm	Dia. 32 mm	Dia. 40 mm	Dia. 50 mm	Dia. 63 mm	Dia. 80 mm	Dia. 100 mm	Dia. 160 mm	Dia. 200 mm
0,01												
0,05												
0,1	0,44											
0,2	0,44	0,44	0,50									
0,5	0,33	0,44	0,50	0,50								
1	0,26	0,33	0,44	0,50	0,50	0,50	0,50	0,50	0,50	0,50	0,50	0,50
2	0,26	0,33	0,44	0,44	0,50	0,50	0,50	0,50	0,50	0,50	0,50	0,50
3	0,26	0,30	0,39	0,44	0,44	0,50	0,50	0,50	0,50	0,50	0,50	0,50
5	0,26	0,26	0,33	0,44	0,44	0,44	0,50	0,50	0,50	0,50	0,50	0,50
6	0,26	0,26	0,33	0,44	0,44	0,44	0,44	0,50	0,50	0,50	0,50	0,50
8	0,26	0,26	0,33	0,44	0,44	0,44	0,44	0,44	0,55	0,55	0,55	0,55
10	0,26	0,26	0,31	0,35	0,44	0,44	0,44	0,44	0,44	0,50	0,55	0,55
12	0,24	0,26	0,31	0,35	0,35	0,44	0,44	0,44	0,44	0,44	0,50	0,50
14	0,22	0,26	0,29	0,33	0,35	0,35	0,44	0,44	0,44	0,44	0,44	0,50
16	0,20	0,22	0,26	0,33	0,33	0,35	0,35	0,44	0,44	0,44	0,44	0,44
18		0,22	0,24	0,29	0,33	0,33	0,35	0,35	0,44	0,44	0,44	0,44
20			0,22	0,26	0,29	0,33	0,33	0,35	0,35	0,44	0,44	0,44
25				0,22	0,26	0,29	0,33	0,33	0,35	0,35	0,44	0,44
32					0,22	0,26	0,29	0,33	0,33	0,35	0,35	0,44
40						0,22	0,26	0,29	0,33	0,33	0,35	0,35
50							0,22	0,26	0,29	0,33	0,33	0,35
63								0,22	0,26	0,29	0,33	0,33
80									0,22	0,26	0,29	0,33
100										0,22	0,26	0,29
160											0,22	0,26
200												0,22

*radial feed in mm.

The specified feed rates are average recommended values.
For special applications, adjustment is recommended.

D Protostar® Flash ISO-P, M, K, N, S, O

a _e [mm]*	Feed per tooth f _z [mm]										
	Dia. 3 mm	Dia. 4 mm	Dia. 6 mm	Dia. 8 mm	Dia. 10 mm	Dia. 12 mm	Dia. 14 mm	Dia. 16 mm	Dia. 18 mm	Dia. 20 mm	Dia. 25 mm
0,8	0,07	0,10									
1,5	0,07	0,10	0,16	0,25							
3	0,07	0,10	0,16	0,25	0,30						
5		0,10	0,16	0,25	0,30	0,35					
6			0,16	0,25	0,30	0,35	0,40	0,50	0,60		
8				0,25	0,30	0,35	0,40	0,50	0,60	0,70	0,70
10					0,30	0,35	0,40	0,50	0,60	0,70	0,70
12							0,40	0,50	0,60	0,70	0,70
14							0,40	0,50	0,60	0,70	0,70
16								0,50	0,60	0,70	0,70
18									0,60	0,70	0,70
20										0,70	0,70
25											0,70

E Protostar® Flash ISO-H

a _e [mm]*	Feed per tooth f _z [mm]										
	Dia. 3 mm	Dia. 4 mm	Dia. 6 mm	Dia. 8 mm	Dia. 10 mm	Dia. 12 mm	Dia. 14 mm	Dia. 16 mm	Dia. 18 mm	Dia. 20 mm	Dia. 25 mm
0,8	0,06	0,08									
1,5	0,06	0,08	0,13	0,20							
3	0,06	0,08	0,13	0,20	0,24						
5		0,08	0,13	0,20	0,24	0,28					
6			0,13	0,20	0,24	0,28	0,32	0,40	0,48		
8				0,20	0,24	0,28	0,32	0,40	0,48	0,56	0,56
10					0,24	0,28	0,32	0,40	0,48	0,56	0,56
12							0,32	0,40	0,48	0,56	0,56
14							0,32	0,40	0,48	0,56	0,56
16								0,40	0,48	0,56	0,56
18									0,48	0,56	0,56
20										0,56	0,56
25											0,56

F Proto-max™_{ST}

a _e [mm]*	Feed per tooth f _z [mm]												
	Dia. 1 mm	Dia. 2 mm	Dia. 3 mm	Dia. 4 mm	Dia. 6 mm	Dia. 8 mm	Dia. 10 mm	Dia. 12 mm	Dia. 14 mm	Dia. 16 mm	Dia. 18 mm	Dia. 20 mm	Dia. 25 mm
0,01	0,04	0,08	0,11	0,14	0,18	0,18	0,24						
0,05	0,03	0,05	0,09	0,12	0,14	0,18	0,24						
0,1	0,02	0,04	0,06	0,10	0,12	0,18	0,24	0,24	0,24	0,24			
0,2	0,02	0,04	0,05	0,07	0,10	0,18	0,22	0,24	0,24	0,24	0,24	0,3	
0,5	0,01	0,03	0,04	0,06	0,08	0,14	0,18	0,18	0,18	0,18	0,24	0,3	0,30
1	0,01	0,03	0,04	0,05	0,07	0,11	0,14	0,14	0,14	0,14	0,18	0,24	0,30
2		0,02	0,04	0,04	0,06	0,10	0,13	0,14	0,14	0,14	0,18	0,24	0,24
3			0,02	0,03	0,05	0,09	0,13	0,14	0,14	0,14	0,16	0,21	0,24
5				0,02	0,05	0,08	0,12	0,14	0,14	0,14	0,14	0,18	0,24
6					0,04	0,07	0,10	0,12	0,12	0,14	0,14	0,18	0,24
8						0,06	0,08	0,11	0,12	0,14	0,14	0,18	0,24
10							0,07	0,10	0,12	0,14	0,14	0,17	0,19
12								0,08	0,11	0,13	0,14	0,17	0,19
14									0,10	0,12	0,14	0,16	0,18
16										0,11	0,12	0,14	0,18
18											0,12	0,13	0,16
20												0,12	0,14
25													0,12

*radial feed in mm.

Feed matrices – f_z table for brazed tools

The specified feed rates are average recommended values.
For special applications, adjustment is recommended.

G Aluminium wrought alloys

Feed per tooth f_z [mm]														
a_e / D_c	Dia. 6 mm	Dia. 8 mm	Dia. 10 mm	Dia. 12 mm	Dia. 16 mm	Dia. 20 mm	Dia. 25 mm	Dia. 32 mm	Dia. 40 mm	Dia. 50 mm	Dia. 63 mm	Dia. 80 mm	Dia. 100 mm	Dia. 125 mm
1/50	0,08	0,07	0,09	0,09	0,12	0,12	0,12	0,15	0,15					
1/20	0,07	0,06	0,08	0,08	0,10	0,10	0,10	0,13	0,13					
1/10	0,06	0,06	0,07	0,07	0,10	0,07	0,10	0,12	0,12	0,12	0,12	0,12	0,12	0,12
1/5	0,06	0,06	0,07	0,07	0,09	0,09	0,09	0,11	0,11	0,11	0,11	0,11	0,11	0,11
1/2	0,05	0,05	0,06	0,06	0,08	0,08	0,08	0,10	0,10	0,10	0,10	0,10	0,10	0,10
1/1	0,05	0,05	0,06	0,06	0,08	0,08	0,08	0,10	0,10	0,10	0,10	0,10	0,10	0,10

H Magnesium alloys / copper and copper alloys

Feed per tooth f_z [mm]														
a_e / D_c	Dia. 6 mm	Dia. 8 mm	Dia. 10 mm	Dia. 12 mm	Dia. 16 mm	Dia. 20 mm	Dia. 25 mm	Dia. 32 mm	Dia. 40 mm	Dia. 50 mm	Dia. 63 mm	Dia. 80 mm	Dia. 100 mm	Dia. 125 mm
1/50	0,04	0,04	0,06	0,06	0,09	0,09	0,09	0,11	0,11					
1/20	0,04	0,04	0,05	0,05	0,08	0,08	0,08	0,10	0,10					
1/10	0,04	0,04	0,05	0,05	0,07	0,07	0,07	0,09	0,09	0,09	0,09	0,09	0,09	0,09
1/5	0,03	0,03	0,04	0,04	0,07	0,07	0,07	0,08	0,08	0,08	0,08	0,08	0,08	0,08
1/2	0,03	0,03	0,04	0,04	0,06	0,06	0,06	0,07	0,07	0,07	0,07	0,07	0,07	0,07
1/1	0,03	0,03	0,04	0,04	0,06	0,06	0,06	0,07	0,07	0,07	0,07	0,07	0,07	0,07

I Thermoplastics, duroplastics, plastic, graphite

Feed per tooth f_z [mm]														
a_e / D_c	Dia. 6 mm	Dia. 8 mm	Dia. 10 mm	Dia. 12 mm	Dia. 16 mm	Dia. 20 mm	Dia. 25 mm	Dia. 32 mm	Dia. 40 mm	Dia. 50 mm	Dia. 63 mm	Dia. 80 mm	Dia. 100 mm	Dia. 125 mm
1/50	0,05	0,05	0,07	0,07	0,10	0,10	0,10	0,13	0,13					
1/20	0,05	0,05	0,06	0,06	0,09	0,09	0,09	0,11	0,11					
1/10	0,04	0,04	0,06	0,06	0,08	0,08	0,08	0,10	0,10	0,10	0,10	0,10	0,10	0,10
1/5	0,04	0,04	0,05	0,05	0,08	0,08	0,08	0,09	0,09	0,09	0,09	0,09	0,09	0,09
1/2	0,03	0,03	0,05	0,05	0,07	0,07	0,07	0,08	0,08	0,08	0,08	0,08	0,08	0,08
1/1	0,03	0,03	0,05	0,05	0,07	0,07	0,07	0,08	0,08	0,08	0,08	0,08	0,08	0,08

J Unalloyed steel, malleable cast iron, ductile cast iron and CGI

Feed per tooth f_z [mm]										
a_e [mm]*	Dia. 16 mm	Dia. 20 mm	Dia. 25 mm	Dia. 32 mm	Dia. 40 mm	Dia. 50 mm	Dia. 63 mm	Dia. 80 mm	Dia. 100 mm	
1,0	0,12	0,12	0,12	0,12	0,13					
2,0	0,12	0,12	0,12	0,12	0,12	0,20				
3,0	0,11	0,12	0,12	0,12	0,12	0,19	0,20			
4,0	0,10	0,11	0,12	0,12	0,12	0,18	0,19	0,20		
5,0	0,10	0,10	0,11	0,12	0,12	0,18	0,18	0,19	0,20	
6,0	0,10	0,10	0,10	0,11	0,12	0,17	0,18	0,18	0,19	
8,0	0,10	0,10	0,10	0,10	0,11	0,17	0,17	0,18	0,18	
10,0	0,10	0,10	0,10	0,10	0,10	0,17	0,17	0,17	0,18	
12,0	0,10	0,10	0,10	0,10	0,10	0,16	0,17	0,17	0,17	
16,0	0,10	0,10	0,10	0,10	0,10	0,15	0,16	0,17	0,17	
20,0		0,10	0,10	0,10	0,10	0,15	0,15	0,16	0,17	
25,0			0,10	0,10	0,10	0,15	0,15	0,15	0,16	
32,0				0,10	0,10	0,15	0,15	0,15	0,15	
40,0					0,10	0,15	0,15	0,15	0,15	
50,0						0,15	0,15	0,15	0,15	
63,0							0,15	0,15	0,15	
80,0								0,15	0,15	
100,0									0,15	

*radial feed in mm.

The specified feed rates are average recommended values.
For special applications, adjustment is recommended.

K Grey cast iron

Feed per tooth f_z [mm]									
a_e [mm]*	Dia. 16 mm	Dia. 20 mm	Dia. 25 mm	Dia. 32 mm	Dia. 40 mm	Dia. 50 mm	Dia. 63 mm	Dia. 80 mm	Dia. 100 mm
1,0	0,13	0,13	0,13	0,14	0,15				
2,0	0,13	0,13	0,13	0,13	0,14	0,26			
3,0	0,13	0,13	0,13	0,13	0,13	0,25	0,26		
4,0	0,12	0,13	0,13	0,13	0,13	0,24	0,25	0,26	
5,0	0,12	0,12	0,13	0,13	0,13	0,24	0,24	0,25	0,26
6,0	0,12	0,12	0,12	0,13	0,13	0,23	0,24	0,24	0,25
8,0	0,12	0,12	0,12	0,12	0,13	0,22	0,23	0,24	0,24
10,0	0,12	0,12	0,12	0,12	0,12	0,22	0,22	0,23	0,24
12,0	0,12	0,12	0,12	0,12	0,12	0,21	0,22	0,22	0,23
16,0	0,12	0,12	0,12	0,12	0,12	0,20	0,21	0,22	0,22
20,0		0,12	0,12	0,12	0,12	0,20	0,20	0,21	0,22
25,0			0,12	0,12	0,12	0,20	0,20	0,20	0,21
32,0				0,12	0,12	0,20	0,20	0,20	0,20
40,0					0,12	0,20	0,20	0,20	0,20
50,0						0,20	0,20	0,20	0,20
63,0							0,20	0,20	0,20
80,0								0,20	0,20
100,0									0,20

L Low-alloyed steel, high-alloyed steel and high-alloyed tool steel

Feed per tooth f_z [mm]									
a_e [mm]*	Dia. 16 mm	Dia. 20 mm	Dia. 25 mm	Dia. 32 mm	Dia. 40 mm	Dia. 50 mm	Dia. 63 mm	Dia. 80 mm	Dia. 100 mm
1,0	0,09	0,09	0,09	0,1	0,10				
2,0	0,09	0,09	0,09	0,09	0,10	0,17			
3,0	0,09	0,09	0,09	0,09	0,09	0,16	0,17		
4,0	0,08	0,09	0,09	0,09	0,09	0,15	0,16	0,17	
5,0	0,08	0,08	0,09	0,09	0,09	0,14	0,15	0,16	0,17
6,0	0,08	0,08	0,08	0,09	0,09	0,14	0,14	0,15	0,16
8,0	0,08	0,08	0,08	0,08	0,09	0,14	0,14	0,14	0,15
10,0	0,08	0,08	0,08	0,08	0,08	0,13	0,14	0,14	0,14
12,0	0,08	0,08	0,08	0,08	0,08	0,13	0,13	0,14	0,14
16,0	0,08	0,08	0,08	0,08	0,08	0,13	0,13	0,13	0,14
20,0		0,08	0,08	0,08	0,08	0,13	0,13	0,13	0,13
25,0			0,08	0,08	0,08	0,12	0,13	0,13	0,13
32,0				0,08	0,08	0,12	0,12	0,13	0,13
40,0					0,08	0,12	0,12	0,12	0,13
50,0						0,12	0,12	0,12	0,12
63,0							0,12	0,12	0,12
80,0								0,12	0,12
100,0									0,12

M Stainless steel (ISO P)

Feed per tooth f_z [mm]									
a_e [mm]*	Dia. 16 mm	Dia. 20 mm	Dia. 25 mm	Dia. 32 mm	Dia. 40 mm	Dia. 50 mm	Dia. 63 mm	Dia. 80 mm	Dia. 100 mm
1,0	0,07	0,07	0,07	0,08	0,08				
2,0	0,07	0,07	0,07	0,07	0,08	0,14			
3,0	0,07	0,07	0,07	0,07	0,07	0,13	0,14		
4,0	0,06	0,07	0,07	0,07	0,07	0,12	0,13	0,14	
5,0	0,06	0,06	0,07	0,07	0,07	0,12	0,12	0,13	0,14
6,0	0,06	0,06	0,06	0,07	0,07	0,12	0,12	0,12	0,13
8,0	0,06	0,06	0,06	0,06	0,07	0,12	0,12	0,12	0,12
10,0	0,06	0,06	0,06	0,06	0,06	0,11	0,12	0,12	0,12
12,0	0,06	0,06	0,06	0,06	0,06	0,11	0,11	0,12	0,12
16,0	0,06	0,06	0,06	0,06	0,06	0,11	0,11	0,11	0,12
20,0		0,06	0,06	0,06	0,06	0,11	0,11	0,11	0,11
25,0			0,06	0,06	0,06	0,10	0,11	0,11	0,11
32,0				0,06	0,06	0,10	0,10	0,11	0,11
40,0					0,06	0,10	0,10	0,10	0,11
50,0						0,10	0,10	0,10	0,10
63,0							0,10	0,10	0,10
80,0								0,10	0,10
100,0									0,10

*radial feed in mm.

v_c correction factors*

v_c correction factors – toolholder / steel

v_c correction factors		Type	α	max. speed
AK610.Z16.E10.005	$v_c \times 1$	A	-	40.000
AK610.Z10.E10.020	$v_c \times 0,9$	A	-	30.000
AK610.Z16.E10.050	$v_c \times 0,6$	B	89°	12.000
AK610.Z16.E10.036	$v_c \times 0,7$	C	85°	15.000
AK610.Z16.E12.005	$v_c \times 1$	A	-	40.000
AK610.Z12.E12.022	$v_c \times 0,9$	A	-	30.000
AK610.Z16.E12.060	$v_c \times 0,6$	B	89°	10.000
AK610.Z16.E12.025	$v_c \times 0,7$	C	85°	15.000
AK610.Z20.E16.005	$v_c \times 1$	A	-	40.000
AK610.Z20.E16.025	$v_c \times 0,9$	A	-	30.000
AK610.Z20.E16.075	$v_c \times 0,6$	B	89°	10.000
AK610.Z25.E16.054	$v_c \times 0,7$	C	85°	15.000
AK610.Z20.E20.030	$v_c \times 0,8$	A	-	20.000
AK610.Z25.E20.005	$v_c \times 1$	A	-	30.000
AK610.Z32.E20.073	$v_c \times 0,7$	C	85°	20.000
AK610.Z32.E25.005	$v_c \times 1$	A	-	30.000
AK610.Z25.E25.040	$v_c \times 0,7$	A	-	15.000
AK610.Z32.E25.045	$v_c \times 0,7$	C	85°	20.000

Type A

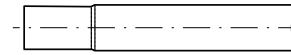

Type B

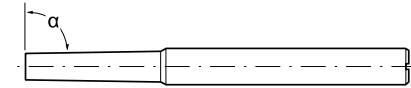

Type C

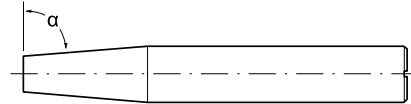

v_c correction factors – toolholder / solid carbide

v_c correction factors		Type	α	max. speed
AK610.Z10.E10.050C	$v_c \times 0,8$	A	-	20.000
AK610.Z16.E10.100C	$v_c \times 0,7$	B	89°	15.000
AK610.Z12.E12.048C	$v_c \times 0,9$	A	-	30.000
AK610.Z16.E12.090C	$v_c \times 0,7$	B	89°	15.000
AK610.Z16.E16.080C	$v_c \times 0,9$	A	-	30.000
AK610.Z20.E16.118C	$v_c \times 0,6$	B	89°	10.000
AK610.Z20.E20.038C	$v_c \times 1$	A	-	30.000
AK610.Z25.E25.120C	$v_c \times 0,6$	A	-	10.000

The specified feed rates are average recommended values. For specific applications, adjustment is recommended.

*** Please note:**

With ConeFit™ points, cutting speed should be adjusted based on projection length and shank type. Observe the maximum rotational speed. For cutting data, see page E 230 onwards.

Cutting tool material and coatings

HSS cutting tool materials

For Walter Prototyp milling cutters, four groups of high-speed steel are used.

HSS	High-speed steel for general applications (side and face milling cutters)
HSS-E	High-speed steel with 5 % Co for increased stress, particularly high thermal loads
HSS-E Co8	High-speed steel with 8 % Co for highest possible heat resistance, corresponds to US standard designation M 42 (end mills for general use, available in standard dimensions and with Morse taper shank, shell end mills)
HSS-PM	Powder-metallurgical high-speed steel with very high content of alloying elements Benefits: high degree of purity and uniformity of the microstructure, high wear resistance and heat resistance (end mills and shell end mills for more demanding applications)

Material no.	Short name	Old standard designation	AISI ASTM	AFNOR	B.S.	UNI	Alloy table					
							C	Cr	W	Mo	V	Co
1.3343	S 6-5-2	DMo5	M2	–	BM2	HS 6-5-2	0,82	4,0	6,5	5,0	2,0	–
1.3243	S 6-5-2-5	EMo5 Co5	M35	6.5.2.5	–	HS 6-5-2-5	0,82	4,5	6,0	5,0	2,0	5,0
1.3247	S 2-10-1-8	–	M42	–	BM42	HS 2-9-1-8	1,08	4,0	1,5	9,5	1,2	8,25

Trade name ASP







Coatings

Surface coating has developed into a proven technological process for improving the performance of metal cutting tools. By contrast with surface treatment, the tool surface remains chemically unaltered and a thin layer is applied. For Walter Prototyp high-speed steel and carbide tools, the coating is produced by the PVD method, which works at process temperatures of below 600 °C and does not, therefore, result in any change to the base material. Hard material layers have a higher hardness and wear resistance than the cutting material itself.





In addition, they:

- help to improve the low-friction quality of the tool surface
- keep the cutting tool material and the material to be machined apart
- act as a thermal insulation layer





Coated tools not only have a longer life, they can also be used with higher cutting speeds and feed rates.

Surface treatment / coating	Method / coating	Property	Colour	
uncoated	No treatment	–	uncoated	
TAX	TiAlN coating	Universal coating for solid carbide milling cutters	black-violet	
TAZ	TiAlN / zirconium nitride coating	High-performance layer specially developed for machining steel: chemical resistance to emulsions and oils; effective against built up edge	champagne	
CRN	Chromium nitride coating	Very thin layer with high degree of toughness; minimised coating roughness for excellent chip flow, especially with aluminium materials	rainbow-coloured	
DIA	Diamond coating	For machining graphite and AISi alloys	grey	
ACN	Aluminium chromium nitride coating	High-performance coating with particularly low friction for titanium machining tools but also for HSS tools	blue-violet	

Walter Prototyp – milling tool types





Remarks	Tool type	Remarks on field of applications	Workpiece material group							Helix angle	Coating
			P	M	K	N	S	H	O		
Roughing	 <p>Qmax</p>	<p>Qmax HR</p> <ul style="list-style-type: none"> – Solid carbide roughing milling cutters with HR Kordel profile – In accordance with DIN 6527 K and L – Shank in accordance with DIN 6535 HB – With and without internal cooling – Use with conditions tending towards unstable 	•	••	•					30° / 40° / 45°	TAX
	 <p>Qmax</p>	<p>Qmax HNR</p> <ul style="list-style-type: none"> – Solid carbide roughing milling cutters with HNR Kordel profile – In accordance with DIN 6527 K and L – Shank in accordance with DIN 6535 HB – Without internal cooling – Use with conditions tending towards stable 	••	••	••					30°	TAX
	 <p>Ti</p>	<p>Ti NS 30</p> <ul style="list-style-type: none"> – Solid carbide roughing milling cutters with chip breaker for reduced power requirement – Shank in accordance with DIN 6535 HA and HB – Without internal cooling – Specially developed for titanium materials 		•	•		••			30°	ACN
	 <p>Flash</p>	<p>N 50 to 55 HRC</p> <ul style="list-style-type: none"> – Solid carbide end mills with special end geometry for HSC machining – Shank in accordance with DIN 6535 HA – Without internal cooling – For universal use 	••	•	•	••		•		50°	TAX
	 <p>Flash</p>	<p>H 50 from 55 to 63 HRC</p> <ul style="list-style-type: none"> – Solid carbide end mills with special end geometry for HSC machining – Shank in accordance with DIN 6535 HA – Without internal cooling – Specially developed for hardened materials 	••					••	•	50°	TAX

Walter Prototyp – milling tool types

Remarks	Tool type	Remarks on field of applications	Workpiece material group							Helix angle	Coating
			P	M	K	N	S	H	O		
Roughing and finishing	 Proto-max™_{ST}	3-edge tools – Solid carbide high performance end mills for machining slots up to 2 x D _c – Shank in accordance with DIN 6535 HA with special treatment against pull-out – With neck – Specially developed for steel materials, but also compatible with stainless materials	••	•						45°	TAZ
	 Proto-max™_{ST}	4-edge tools – Solid carbide high performance end mills for machining slots up to 1.5 x D _c – Shank in accordance with DIN 6535 HA with special treatment against pull-out – With neck – Specially developed for steel materials, but also compatible with stainless materials	••	•						50°	TAZ
	 Tough Guys	N 50 to 48 HRC – Solid carbide high performance end mills with or without corner radius for slots up to 0.9 x D _c – Shank in accordance with DIN 6535 HA and HB – Different core diameters for increased stability – For universal use	••	•	•		•	•		50°	TAX
	 Tough Guys	H 50 from 48 to 63 HRC – Solid carbide high performance end mills with or without corner radius – Shank in accordance with DIN 6535 HA and HB – Different core diameters for increased stability – Specially developed for hardened materials	••				•	••		50°	TAX
	 TI	TI 40 – Solid carbide high performance end mills – Shank in accordance with DIN 6535 HA with special treatment against pull-out – With neck and internal cooling – Specially developed for titanium		•			••			40°	ACN



Walter Prototyp – milling tool types

Remarks	Tool type	Remarks on field of applications	Workpiece material group							Helix angle	Coating	
			P	M	K	N	S	H	O			
Roughing and finishing	Ultra 	From 48 to 63 HRC – Solid carbide high performance end mills – Tools in an extremely wide selection of versions, with sharp cutting edge, with corner radius and also including ball-nose end mills. Dimensions from 0.3–25 mm – Specially developed for hardened materials	••						••	•	30° / 50°	TAX
	Graphite 	With DIA coating – Solid carbide high performance end mills specially developed for machining graphite electrodes – Tools in an extremely wide selection of versions, with sharp cutting edge, with corner radius and also including ball-nose end mills. Dimensions from 0.4–16 mm – Specially developed for graphite materials								••	30°	DIA
Finishing	Multipurpose cutters 	N 60 – Solid carbide high performance end mills with 6 cutting edges – D _c = diameters of 6–20 mm – Shank in accordance with DIN 6535 HA	••	•							60°	TAX
		N 50 – Solid carbide high performance end mills with 4–8 cutting edges – D _c = diameters of 6–20 mm – Shank in accordance with DIN 6535 HA	••	•				•			50°	TAX
	TI 	TI 45 – Solid carbide high performance end mills – Shank in accordance with DIN 6535 HA – With neck – Specially developed for finishing titanium			•		••				45°	ACN

ConeFit™ installation instructions



Safety information:
Please wear safety gloves when assembling with the tool holder, because the edges of the ConeFit™ milling heads are sharp.

Clean the interface and support face on the milling cutter and tool holder.

Place the ConeFit™ tool holder in its adaptor.

Screw the ConeFit™ milling cutter by hand into the ConeFit™ tool holder (figure 1).

Using a torque wrench and the specified torque (see table), tighten the ConeFit™ milling cutter to ensure a form-fit connection.

Ensure that the gap is closed and that the cutter is located against the support face (figure 2).

Cutter head fitting torques

E	SW	Nm
10	8	12
12	10	15
16	12	30
20	16	50
25	20	65

Honeycomb tools: installation instructions

Version 1: Chopper without cutting knife

These tools are used in a similar way to a shell end mill and are fitted to the adaptor spindle individually using the clamping screw.

- ① Clamping screw
- ② Chopper
- ③ Wedge
- ④ Adaptor



Version 2: Chopper with cutting knife

The chopper and the cutting knife are fitted to the spindle together. As a consequence of the slightly larger diameter D_c of the cutting knife, the "honeycomb" is cut off and then broken down.

- ① Clamping screw
- ② Cutting knife
- ③ Chopper
- ④ Wedge
- ⑤ Adaptor



Protostar® Flash

High-speed milling cutter with special end-face geometry for extremely high feed rates

Chip thickness h is reduced thanks to the special end-face geometry. Extremely high feeds are possible. Forces are diverted axially towards the centre of the tool, which helps to stabilise the machining process.

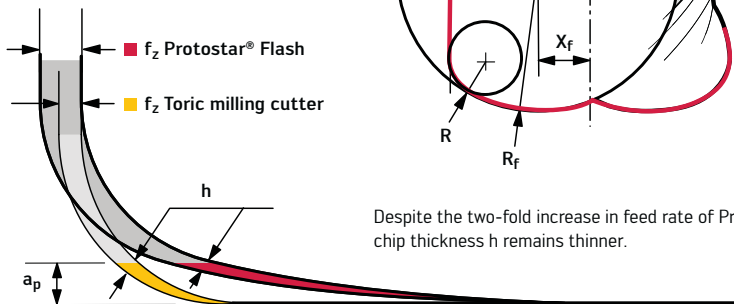

Despite the two-fold increase in feed rate of Protostar® Flash, chip thickness h remains thinner.

In comparison with conventional toric tools (figure 1), the special geometry of Protostar® Flash (figure 2) reduces the amount of residual material produced. This minimises the work associated with the residual material, which has benefits for the service life of the subsequent finishing tool.

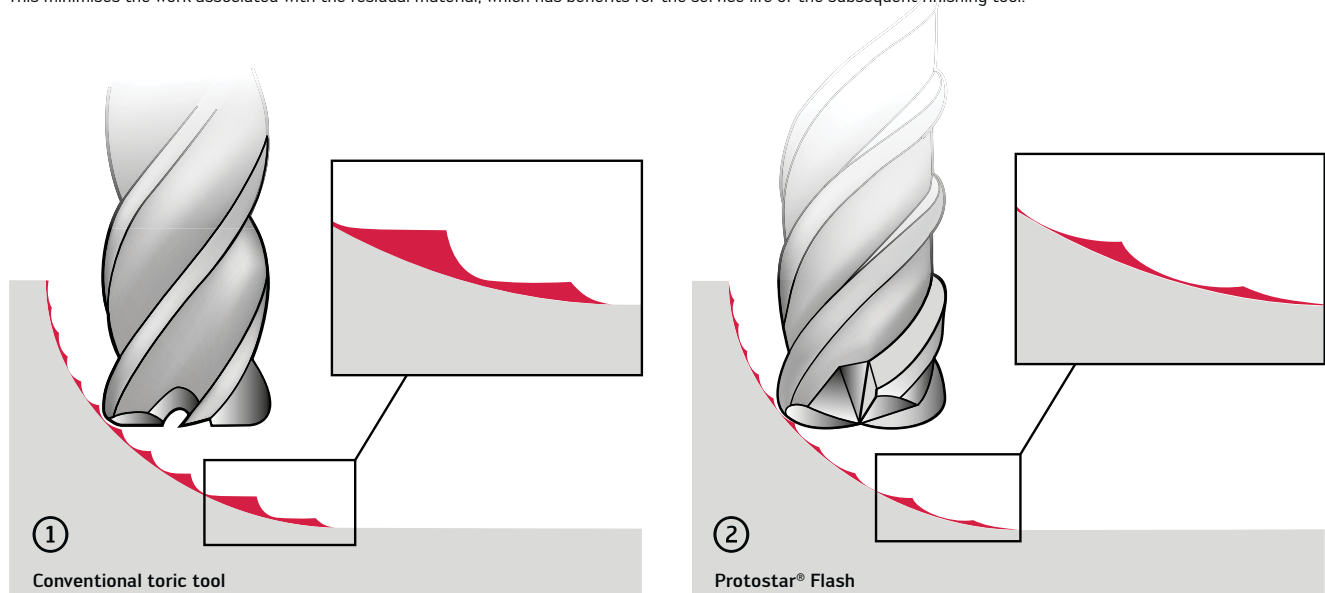

Recommended copy and finish milling application

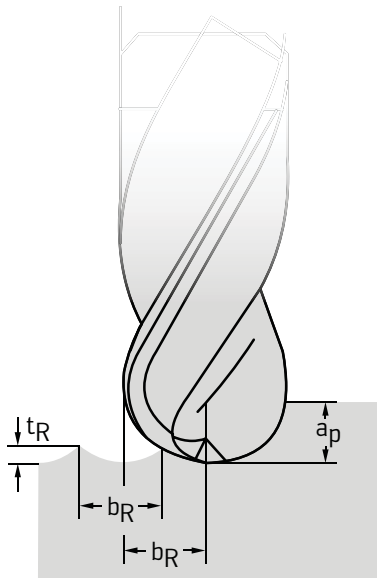

Tool diameter D_c (mm)	Row width (b_R) for groove depth $t_R = 5 \mu\text{m}$	Row width (b_R) for groove depth $t_R = 2 \mu\text{m}$
0,3	0,08	0,04
0,4	0,09	0,05
0,5	0,10	0,06
0,6	0,11	0,07
0,8	0,12	0,08
1	0,14	0,09
1,5	0,17	0,11
2	0,20	0,12
2,5	0,22	0,14
3	0,25	0,16
4	0,28	0,18
5	0,31	0,20
6	0,34	0,22
8	0,40	0,25
10	0,45	0,28
12	0,49	0,31
16	0,56	0,36
20	0,63	0,40
25	0,71	0,45
32	0,80	0,50

Maximum ramping angle with solid carbide and HSS milling cutters E [°]

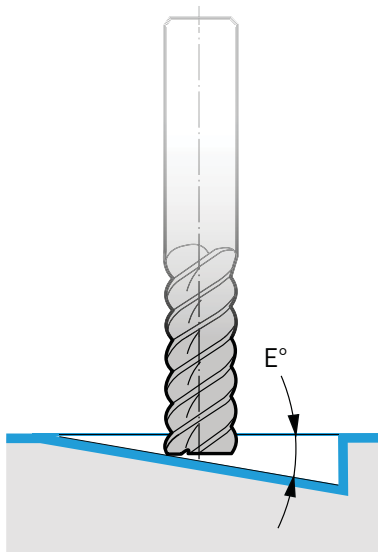

Material group	Workpiece material	Number of teeth					
		2	3	4	5	6-8	8
P	Steel	10*	8*	5	5	4	3
M	Stainless steel	5	5	5	5	4	3
K	Cast iron	10	10	8	6	5	3
N	NF metals	15	15	15	10	10	5
S	High temperature alloys and titanium alloys	5	5	5	5	4	3
H	Hard materials	2	2	1,5	1,5	1,5	1
O	Other	15	15	15	10	10	5

* at $R_m > 1,100 \text{ N/mm}^2$, reduce ramping angle by 25 %.



CONTENTS

Milling cutters with indexable inserts

	Information	F 2
Milling inserts	Product range overview	F 5
	Designation key	F 6
	Walter Select – Milling	F 10
	Walter indexable inserts for milling	F 12
Walter milling cutters with indexable inserts	Product range overview	F 50
	System overview of ScrewFit	F 52
	Overview for system indexable inserts	F 54
	System overview of face mill F 2010	F 56
	Designation key	F 59
	Walter Select – Face milling	F 60
	Walter face mills	F 66
	Walter Select – Shoulder milling	F 134
	Walter shoulder mills	F 138
	Walter Select – Slot milling	F 170
	Walter slot mills	F 174
	Walter Select – Copy milling	F 212
	Walter copy mills	F 214
	Walter Select – Profile milling	F 234
Walter profile mills	F 236	
Walter Select – Circular interpolation milling	F 242	
Walter circular interpolation mills	F 244	
Technical Information	Cutting data	F 246
	Feed determinations	F 264
	Cutting material application tables	F 294
	Geometry overview of milling indexing inserts	F 296
	Setting and assembly instructions	F 300
	Tightening torques	F 309
	Information on high-speed cutting	F 310
	Roughing/finishing combinations	F 312
	Application information on milling	F 314

Tools for milling

The Walter and Walter Prototyp speciality brands provide you with the right milling cutter: From the Mini-Cutter with a diameter of 0.3 mm made from solid carbide to the face mills with carbide indexable inserts with a diameter of 315 mm in cartridge form.

A variety of cutting tool materials, such as coated carbide, PCD, CBN or HSS, ensure coverage of a broad range of applications. Thanks to the large selection of tool types and geometries, you will always find the optimum solution to meet your different workpiece and material requirements.

1 Proto-max™_{ST}

- Solid carbide high-speed milling cutter, specially developed for steel cutting
- Suitable for roughing with maximum stock removal volumes and for finishing
- Slot milling down to $2 \times D_c$ possible

2 ConeFit™

- Modular solid carbide milling system for most accurate concentricity and providing flexibility through the widest available selection of geometries and shank variants
- Diameter range from 10 to 25 mm
- Can be used universally for roughing, finishing, 3D contour milling and profile milling

3 Xtra-tec® octagon cutters F 4080 / F 4081

- Universally usable tools for face milling, circular interpolation milling, inclined plunging, pocketing and chamfering
- F 4081: special variant for circular interpolation milling with smooth bores
- Highly cost-effective thanks to 8-edge indexable insert

4 Xtra-tec® shoulder mill F 4042

- Wide programme variety through the selection of five insert sizes and corner radii of 0.2 to 6.0 mm
- Also many different geometries for ideal adaptation of tool to the respective machining task

5 Xtra-tec® side and face milling cutters F 4053 / F 4153 / F 4253

- Slitting cutters with cutting width of 4 mm; tangential side and face mills with cutting width up to 25 mm
- Tools equipped with a single insert type by means of right and left cutting edges on an indexable insert

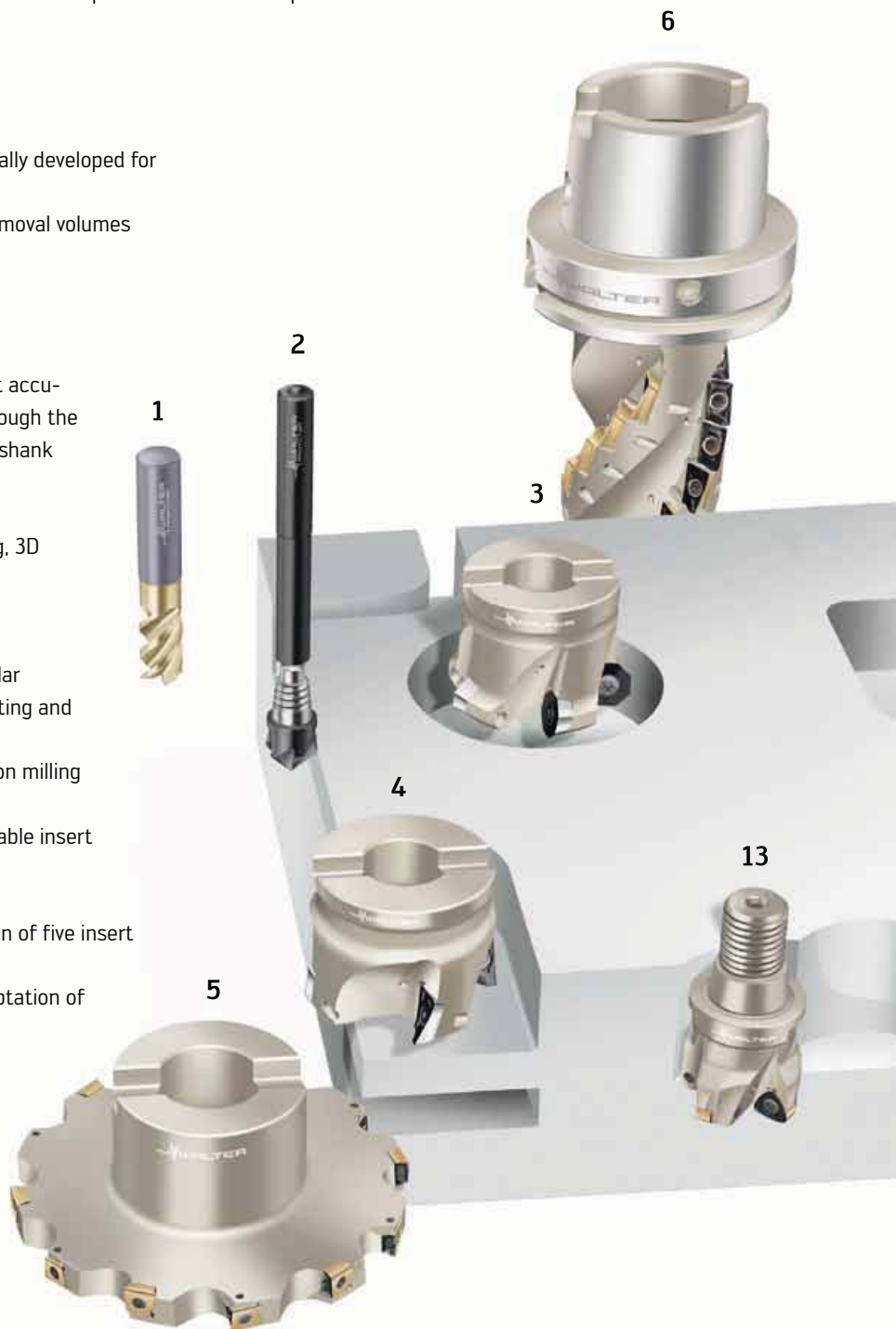

6 Xtra-tec® porcupine cutters

F 4038 / F 4138 / F 4238 / F 4338

- For use in shoulder milling and for trimming operations on an extremely wide range of materials
- Diameter range from 20 to 125 mm, cutting lengths up to 124 mm
- High machining volume also on low-performance machines due to extremely positive indexable inserts

7 Protostar® Tough Guys

- Extremely universal and efficient solid carbide mills for corner and slot milling, inclined plunging and circular interpolation milling
- Suitable for slot and contour milling due to wide range of chip clearance depths in the face area

8 Xtra-tec® face mills F 4033 / F 4047 / F 4048

- 8-edge system inserts for wide range of approach angles
- Maximum productivity during face milling by means of extremely positive geometries in combination with tough, negative inserts

9 Protostar® N 40 Ball-nose end mill

- Compatible with all forms in 5-axis machining applications, but also with machines with 3 axes and suitable for Z constant operations
- Extremely efficient TAX coating

10 Protostar® N 50 multipurpose cutter

- Maximum productivity when trimming by means of large number of teeth (6, 7 or 8)
- Optimum chip removal thanks to 50° helix angle

11 Xtra-tec® heptagon cutter F 4045

- For roughing on all cast iron workpieces
- With 14-edge indexable insert and highest pitch for maximum machined volume

12 Xtra-tec® shoulder mill F 4041

- Unique insert design with four cutting edges per insert and exact 90° corners at the shoulder that is created
- Helical cutting edges with negative inserts for soft, positive cutting

13 Xtra-tec® High Performance mill F 4030

- Feeds of up to 3.5 mm / tooth possible
- Optimum productivity at the same time as optimum process reliability and a soft cutting action due to unique, negative indexable insert design

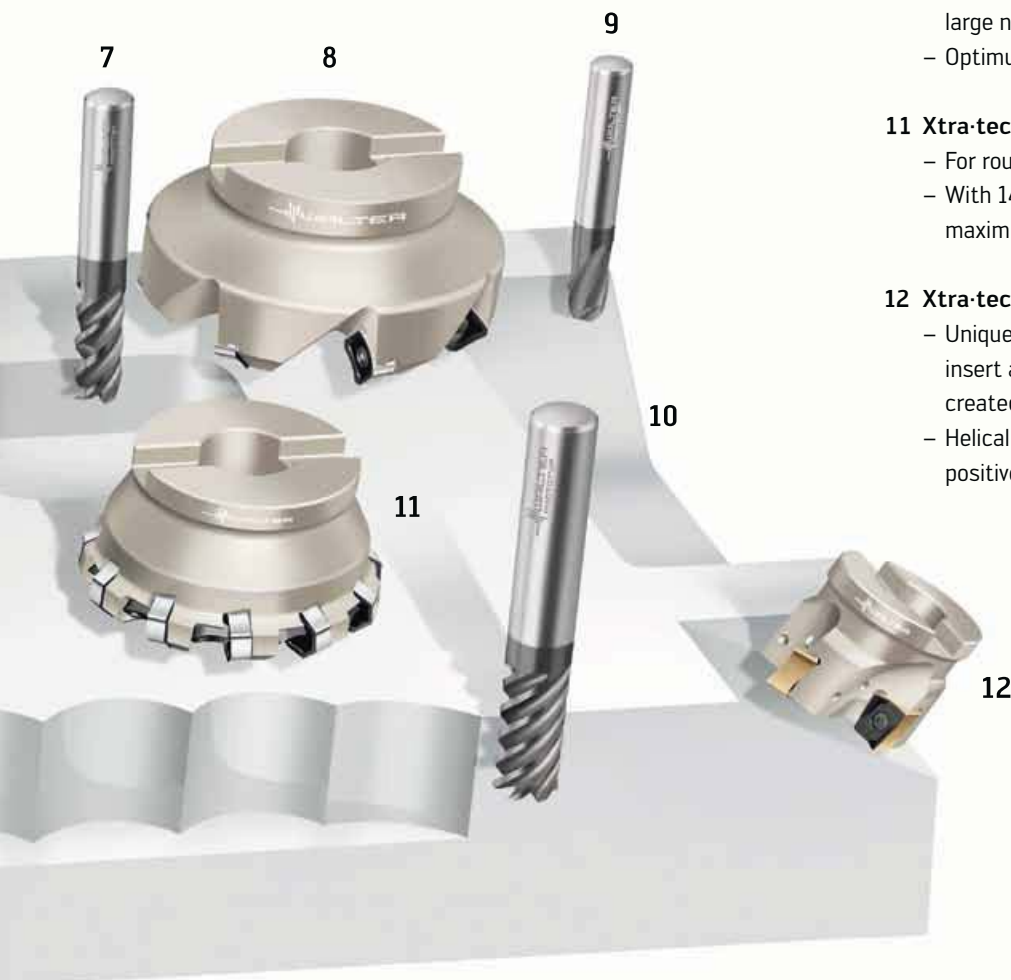













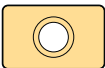





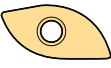
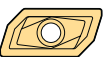

Tiger-tec[®] Silver



Product range overview of milling inserts



Insert shape	Description	Page
	A Positive rhombic for Xtra-tec®	F 12
	C Tangential rhombic	F 43
	L Positive rhombic Tangential rhombic Negative rhombic for Xtra-tec®	F 16 F 43 F 36
	M Positive rhombic	F 17
	O Positive octagonal for Xtra-tec® Finishing inserts	F 19 F 33
	R Positive round	F 23
	S Positive square Negative square F 2254 Negative square for Xtra-tec®	F 26 F 37 F 38
	T Positive triangular Negative triangular	F 31 F 40
	X Negative heptagon for Xtra-tec®	F 40
	X Positive form inserts for copy milling cutters	F 31
	Z Positive rhombic	F 32

Insert shape	Description	Page
	NSM . . Indexable inserts for slitting cutters	F 45
	P 20200 Positive rhombic	F 46
	P 23 . . Wendelnovex® inserts	F 36
	P 236 . . Negative triangular for Xtra-tec® High Performance mill	F 37
	P 263 . . Positive triangular for high performance milling cutters for copy milling cutters	F 21 F 20
	P 2792 Positive rhombic	F 46
	P 32 . . Indexable inserts for profile milling cutters	F 22
	P 44 . . Tangential rhombic	F 47
	P 8001 Toric indexable insert for Xtra-tec® profile mill	F 22
	Finishing inserts	F 35 F 41 F 48

Designation key in accordance with ISO 1832 for indexable inserts for milling

Example

R	D	H	W	16	05	M0	T		-	A27
1	2	3	4	5	6	7	8	9		12

1	
Insert shape	
A	
B	
C	
D	
E	
H	
K	
L	
M	
O	
P	
R	
S	
T	
V	
W	

2	
Clearance angle	
A	
B	
C	
D	
E	
F	
G	
N	
P	

3			
Tolerances			
Permissible deviation in mm for			
	d	m	s
	A	± 0,025	± 0,005
	C	± 0,025	± 0,013
	E	± 0,025	± 0,025
	F	± 0,013	± 0,005
	G	± 0,025	± 0,025
	H	± 0,013	± 0,013
	J ¹	± 0,05-0,15 ²	± 0,005
	K ¹	± 0,05-0,15 ²	± 0,013
	L ¹	± 0,05-0,15 ²	± 0,025
	M	± 0,05-0,15 ²	± 0,08-0,20 ²
	N	± 0,05-0,15 ²	± 0,08-0,20 ²
	U	± 0,08-0,25 ²	± 0,13-0,38 ²

¹ Inserts with ground secondary cutting edges
² depending on insert size (see ISO standard 1832)

7			
Corner radius			
01 r = 0,1	Approach angle	Clearance angle of secondary cutting edge	00 for diameter with imperial dimensions converted into mm
02 r = 0,2	A 45°	A 3°	M0 for diameter in metric sizes
04 r = 0,4	D 60°	B 5°	
08 r = 0,8	E 75°	C 7°	
12 r = 1,2	F 85°	D 15°	
16 r = 1,6	P 90°	E 20°	
24 r = 2,4	Z other approach angles	F 25°	
		G 30°	
		N 0°	
		P 11°	
		Z other clearance angles	

8	
Edge formation	
E	
F	
T	
S	

9	
Cutting direction	
R	
L	
N	

4			5		6	
Machining and fastening features			Cutting edge length		Insert thickness	
A	J	U				01 s = 1,59
B	M	W				T1 s = 1,98
C	N	X				02 s = 2,38
F	Q					T2 s = 2,78
G	R					03 s = 3,18
H	T					T3 s = 3,97
						04 s = 4,76
						05 s = 5,56
						06 s = 6,35
						07 s = 7,94
						09 s = 9,52

10
Chamfer width
010 = 0.10 mm
020 = 0.20 mm
025 = 0.25 mm
070 = 0.70 mm
150 = 1.50 mm
200 = 2.00 mm





11
Chamfer angle
15 = 15°
20 = 20°





12		
Manufacturer's specifications		
The ISO code includes 9 symbols.	A 25	G 56
The symbols 8 and / or 9 should be only used when required.	A 27	G 67
	A 51	G 77
	A 57	G 85
	A 88	G 88
The manufacturer can add other symbols which can be combined with the ISO code by means of a hyphen (e.g. for the form of the chip breaker).	B 57T	K 85
		K 88
	D 27	
	D 51	L 55
	D 55	L 88
	D 56	
	D 57	
	D 67	
	F 27	
	F 55	
	F 56	
	F 57	
	F 57T	
	F 67	





Geometry designation keys for indexable inserts for milling

Example

A	5	7
1	2	3

1		
Chip breaker groove		
small		A = 0°
		B = 6°
		D = 10°
		E = 15°
		F = 16°
		G = 20°
		K = 25°
		L = 28°
large		

2		
Cutting edge		
heavily chamfered		2
		5
		6
		7
sharp		8

3		
Clearance		
	1	e.g. vibration damped
	5	
	6	Clearance
	7	
	8	

Designation key for coated carbides – milling

Example

W	K	P	35	S
Walter	1	2	3	4

1	
1. Primary application or coating type	
P	Steel
M	Stainless steel
K	Cast iron
N	NF metals
S	Difficult-to-cut materials
H	Hard materials
A	CVD aluminium oxide coating
X	PVD coating

2	
2. Primary application	
P	Steel
M	Stainless steel
K	Cast iron
N	NF metals
S	Difficult-to-cut materials
H	Hard materials

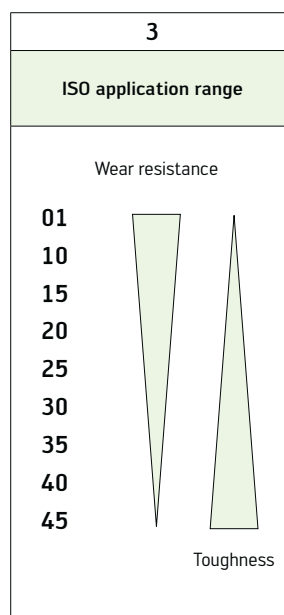

4	
Generation	
S	Tiger-tec® Silver

Walter Select for milling inserts

Step by step to the right indexable insert

STEP 1





Determine the **material** to be machined, from page H 8 onwards.

Note the machining group that corresponds to your material e.g.: P10.

Code letter	Machining group	Groups of the materials to be machined	
P	P1–P15	Steel	All types of steel and cast steel, with the exception of steel with an austenitic structure
M	M1–M3	Stainless steel	Stainless austenitic steel and austenitic-ferritic steel and cast steel
K	K1–K7	Cast iron	Grey cast iron, cast iron with spheroidal graphite, malleable cast iron, cast iron with vermicular graphite
N	N1–N10	NF metals	Aluminium and other non-ferrous metals, non-ferrous materials
S	S1–S10	High temperature alloys and titanium alloys	Heat resisting special alloys based on iron, nickel and cobalt, titanium and titanium alloys
H	H1–H4	Hard materials	Hardened steel, hardened cast iron materials, chilled cast iron
O	O1–O6	Other	Plastics, fibre glass and carbon fibre reinforced plastics, graphite

STEP 2

Select the **machining conditions**:

Tool projection	Machine stability, clamping system and workpiece		
	very good	good	moderate
short projection length			
Extended tool projection			

STEP 3

Select your **tool** in accordance with your application and individual requirements. Then select your milling cutter from the corresponding tool page.

Machining method		
<p>Face milling see page F 60</p>	<p>Circular interpolation milling see page F 242</p>	<p>Profile milling see page F 234</p>
<p>Shoulder milling see page F 134</p>	<p>Slot milling see page F 170</p>	<p>Copy milling see page F 112</p>

STEP 4

Define your optimal **indexable insert grades and geometries** on the appropriate tool page. Here, please take into consideration the machining conditions (step 2) and the material to be machined.

Detailed geometry description for the Xtra-tec® tools, F 2330 and F 2334 see page F 296.

Indexable inserts		Material groups																						
Designation	Tolerance class	Number of cutting edges	l ₂ mm	l mm	s mm	α	α ₂	r mm	b mm	P			M		K			N		S		H		
										WKP25	WKP35	WSP35	WSP45	WSP45	WSP45	WKP25	WKP35	WKP35	WKP35	WKP35	WKP35	WKP35	WKP35	WKP35
ADGT0803PER-D51	G	2	6,75	9,52	3,35	15°	20°	0,4	1,2	●	●	●	●	●	●	●	●	●	●	●	●	●	●	●
ADGT1204PER-D51	G	2	8,4	13,6	4,76	15°	20°	0,8	1,2	●	●	●	●	●	●	●	●	●	●	●	●	●	●	●
ADGT1606PER-D51	G	2	10,8	17,5	6,15	15°	20°	0,8	1,6	●	●	●	●	●	●	●	●	●	●	●	●	●	●	●
ADGT1807PER-D51	G	2	14,5	19,0	7,0	15°	17°	1,2	1,8	●	●	●	●	●	●	●	●	●	●	●	●	●	●	●
ADGT0803PER-D56	G	2	6,75	9,52	3,35	15°	20°	0,4	1,2	●	●	●	●	●	●	●	●	●	●	●	●	●	●	●
ADGT1204PER-D56	G	2	8,4	13,6	4,76	15°	20°	0,8	1,2	●	●	●	●	●	●	●	●	●	●	●	●	●	●	●
ADGT1606PER-D56	G	2	10,8	17,5	6,15	15°	20°	0,8	1,6	●	●	●	●	●	●	●	●	●	●	●	●	●	●	●
ADGT1807PER-D56	G	2	14,5	19,0	7,0	15°	17°	1,2	1,8	●	●	●	●	●	●	●	●	●	●	●	●	●	●	●
ADGT10T3PER-D67	G	2	7,25	11,3	3,8	15°	15°	0,8	1,2	●	●	●	●	●	●	●	●	●	●	●	●	●	●	●
ADGT10T316R-D67	G	2	7,25	11,3	3,8	15°	15°	1,6	1,2	●	●	●	●	●	●	●	●	●	●	●	●	●	●	●
ADGT10T325R-D67	G	2	7,25	11,3	3,8	15°	15°	2,5	1,0	●	●	●	●	●	●	●	●	●	●	●	●	●	●	●
ADGT10T330R-D67	G	2	7,25	11,3	3,8	15°	15°	3,0	0,8	●	●	●	●	●	●	●	●	●	●	●	●	●	●	●
ADGT10T332R-D67	G	2	7,25	11,3	3,8	15°	15°	3,2	0,8	●	●	●	●	●	●	●	●	●	●	●	●	●	●	●
ADGT1204PER-D67	G	2	8,4	13,6	4,76	15°	20°	0,8	1,2	●	●	●	●	●	●	●	●	●	●	●	●	●	●	●
ADGT120416R-D67	G	2	8,4	13,6	4,76	15°	20°	1,6	1,0	●	●	●	●	●	●	●	●	●	●	●	●	●	●	●
ADGT120430R-D67	G	2	8,4	13,6	4,76	15°	20°	3,0	0,8	●	●	●	●	●	●	●	●	●	●	●	●	●	●	●
ADGT1606PER-D67	G	2	10,8	17,5	6,15	15°	20°	0,8	1,6	●	●	●	●	●	●	●	●	●	●	●	●	●	●	●
ADGT160616R-D67	G	2	10,8	17,5	6,15	15°	20°	1,6	1,0	●	●	●	●	●	●	●	●	●	●	●	●	●	●	●
ADGT160630R-D67	G	2	10,8	17,5	6,15	15°	20°	3,0	0,8	●	●	●	●	●	●	●	●	●	●	●	●	●	●	●
ADGT0803PER-F56	G	2	6,75	9,52	3,35	15°	20°	0,4	1,2	●	●	●	●	●	●	●	●	●	●	●	●	●	●	●
ADGT1204PER-F56	G	2	8,4	13,6	4,76	15°	20°	0,8	1,2	●	●	●	●	●	●	●	●	●	●	●	●	●	●	●
ADGT1606PER-F56	G	2	10,8	17,5	6,15	15°	20°	0,8	1,6	●	●	●	●	●	●	●	●	●	●	●	●	●	●	●

WALTER SELECT

Best insert for:

good
 moderate
 unfavourable
 machining conditions

STEP 5

Select the **cutting data** from page F 246.



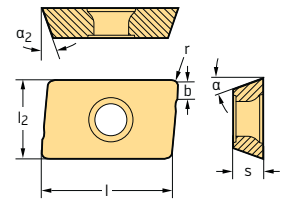

Cutting data for roughing Face / shoulder milling		Material groups																
Material group	Structure of main material groups and identification letters	Bore hardness HB	Tensile strength R _m N/mm ²	Machining group ¹⁾	Cutting material grades													
					Starting values for cutting speed v _c [m/min]													
					WKP355		WKP35		WKP25									
					a _{ap} / D _h * 1/1 1/2	a _{ap} / D _h * 1/1 1/5	a _{ap} / D _h * 1/1 1/5	a _{ap} / D _h * 1/1 1/5	a _{ap} / D _h * 1/1 1/5	a _{ap} / D _h * 1/1 1/5	a _{ap} / D _h * 1/1 1/5	a _{ap} / D _h * 1/1 1/5	a _{ap} / D _h * 1/1 1/5	a _{ap} / D _h * 1/1 1/5	a _{ap} / D _h * 1/1 1/5	a _{ap} / D _h * 1/1 1/5		
P	Unalloyed steel	C ≤ 0.25 %	annealed	125 428 P1	●	●	●	●	●	●	●	●	●	●	●	●	●	●
		C > 0.25 ... ≤ 0.55 %	annealed	190 639 P2	●	●	●	●	●	●	●	●	●	●	●	●	●	●
		C > 0.25 ... ≤ 0.55 %	tempered	210 708 P3	●	●	●	●	●	●	●	●	●	●	●	●	●	●
		C > 0.55 %	annealed	190 639 P4	●	●	●	●	●	●	●	●	●	●	●	●	●	●
		C > 0.55 %	tempered	300 1013 P5	●	●	●	●	●	●	●	●	●	●	●	●	●	●
		Free cutting steel (short-chipping)	annealed	220 745 P6	●	●	●	●	●	●	●	●	●	●	●	●	●	●
P	Low-alloyed steel	annealed	175 591 P7	●	●	●	●	●	●	●	●	●	●	●	●	●	●	
		tempered	300 1013 P8	●	●	●	●	●	●	●	●	●	●	●	●	●	●	
		tempered	380 1282 P9	●	●	●	●	●	●	●	●	●	●	●	●	●	●	
P	High-alloyed steel and high-alloyed tool steel	tempered	430 1477 P10	●	●	●	●	●	●	●	●	●	●	●	●	●	●	
		annealed	200 675 P11	●	●	●	●	●	●	●	●	●	●	●	●	●	●	
		hardened and tempered	300 1013 P12	●	●	●	●	●	●	●	●	●	●	●	●	●	●	●
P	Stainless steel	hardened and tempered	400 1361 P13	●	●	●	●	●	●	●	●	●	●	●	●	●	●	
		ferritic / martensitic, annealed	200 675 P14	●	●	●	●	●	●	●	●	●	●	●	●	●	●	
		martensitic, tempered	330 1114 P15	●	●	●	●	●	●	●	●	●	●	●	●	●	●	●
M	Stainless steel	austenitic, quench hardened	200 675 K1	●	●	●	●	●	●	●	●	●	●	●	●	●	●	
		austenitic, precipitation hardened (PH)	300 1013 K2	●	●	●	●	●	●	●	●	●	●	●	●	●	●	●
		austenitic / ferritic, duplex	230 778 K3	●	●	●	●	●	●	●	●	●	●	●	●	●	●	●
K	Malleable cast iron	ferritic	200 675 K1	●	●	●	●	●	●	●	●	●	●	●	●	●	●	
		pearlitic	260 867 K2	●	●	●	●	●	●	●	●	●	●	●	●	●	●	●
K	Grey cast iron		180 593 K2	●	●	●	●	●	●	●	●	●	●	●	●	●	●	

Positive rhombic

Tiger-tec®



Indexable inserts

Designation	Tolerance class	Number of cutting edges	l ₂ mm	l mm	s mm	α	α ₂	r mm	b mm	P				M		K					N		S		H							
										HC				HC		HC					HC	HW	HC		HC							
										WKP25	WKP35	WKP35S	WSP45	WSM35	WSP45	WAK15	WKK25	WKP25	WKP35	WKP35S	WXN15	WK10	WSM35	WSP45	WHP15							
 ADGT0803PER-D51	G	2	6,75	9,52	3,35	15°	20°	0,4	1,2	☉	☉	☉	☉	☉	☉	☉	☉	☉	☉	☉	☉	☉	☉	☉	☉	☉	☉					
ADGT1204PER-D51	G	2	8,4	13,6	4,76	15°	20°	0,8	1,2	☉	☉	☉	☉	☉	☉	☉	☉	☉	☉	☉	☉	☉	☉	☉	☉	☉	☉	☉				
ADGT1606PER-D51	G	2	10,8	17,5	6,15	15°	20°	0,8	1,6	☉	☉	☉	☉	☉	☉	☉	☉	☉	☉	☉	☉	☉	☉	☉	☉	☉	☉	☉				
ADGT1807PER-D51	G	2	14,5	19,0	7,0	15°	17°	1,2	1,8	☉	☉	☉	☉	☉	☉	☉	☉	☉	☉	☉	☉	☉	☉	☉	☉	☉	☉	☉				
 ADGT0803PER-D56	G	2	6,75	9,52	3,35	15°	20°	0,4	1,2	☉	☉	☉	☉	☉	☉	☉	☉	☉	☉	☉	☉	☉	☉	☉	☉	☉	☉	☉				
ADGT1204PER-D56	G	2	8,4	13,6	4,76	15°	20°	0,8	1,2	☉	☉	☉	☉	☉	☉	☉	☉	☉	☉	☉	☉	☉	☉	☉	☉	☉	☉	☉	☉			
ADGT1606PER-D56	G	2	10,8	17,5	6,15	15°	20°	0,8	1,6	☉	☉	☉	☉	☉	☉	☉	☉	☉	☉	☉	☉	☉	☉	☉	☉	☉	☉	☉	☉			
ADGT1807PER-D56	G	2	14,5	19,0	7,0	15°	17°	1,2	1,8	☉	☉	☉	☉	☉	☉	☉	☉	☉	☉	☉	☉	☉	☉	☉	☉	☉	☉	☉	☉			
 ADGT10T3PER-D67	G	2	7,25	11,3	3,8	15°	15°	0,8	1,2	☉	☉	☉	☉	☉	☉	☉	☉	☉	☉	☉	☉	☉	☉	☉	☉	☉	☉	☉	☉			
ADGT10T316R-D67	G	2	7,25	11,3	3,8	15°	15°	1,6	1,2	☉	☉	☉	☉	☉	☉	☉	☉	☉	☉	☉	☉	☉	☉	☉	☉	☉	☉	☉	☉	☉		
ADGT10T325R-D67	G	2	7,25	11,3	3,8	15°	15°	2,5	1,0	☉	☉	☉	☉	☉	☉	☉	☉	☉	☉	☉	☉	☉	☉	☉	☉	☉	☉	☉	☉	☉		
ADGT10T330R-D67	G	2	7,25	11,3	3,8	15°	15°	3,0	0,8	☉	☉	☉	☉	☉	☉	☉	☉	☉	☉	☉	☉	☉	☉	☉	☉	☉	☉	☉	☉	☉		
ADGT10T332R-D67	G	2	7,25	11,3	3,8	15°	15°	3,2	0,8	☉	☉	☉	☉	☉	☉	☉	☉	☉	☉	☉	☉	☉	☉	☉	☉	☉	☉	☉	☉	☉	☉	
ADGT1204PER-D67	G	2	8,4	13,6	4,76	15°	20°	0,8	1,2	☉	☉	☉	☉	☉	☉	☉	☉	☉	☉	☉	☉	☉	☉	☉	☉	☉	☉	☉	☉	☉		
ADGT120416R-D67	G	2	8,4	13,6	4,76	15°	20°	1,6	1,0	☉	☉	☉	☉	☉	☉	☉	☉	☉	☉	☉	☉	☉	☉	☉	☉	☉	☉	☉	☉	☉	☉	
ADGT120430R-D67	G	2	8,4	13,6	4,76	15°	20°	3,0	0,8	☉	☉	☉	☉	☉	☉	☉	☉	☉	☉	☉	☉	☉	☉	☉	☉	☉	☉	☉	☉	☉	☉	
ADGT1606PER-D67	G	2	10,8	17,5	6,15	15°	20°	0,8	1,6	☉	☉	☉	☉	☉	☉	☉	☉	☉	☉	☉	☉	☉	☉	☉	☉	☉	☉	☉	☉	☉	☉	
ADGT160616R-D67	G	2	10,8	17,5	6,15	15°	20°	1,6	1,0	☉	☉	☉	☉	☉	☉	☉	☉	☉	☉	☉	☉	☉	☉	☉	☉	☉	☉	☉	☉	☉	☉	
ADGT160630R-D67	G	2	10,8	17,5	6,15	15°	20°	3,0	0,8	☉	☉	☉	☉	☉	☉	☉	☉	☉	☉	☉	☉	☉	☉	☉	☉	☉	☉	☉	☉	☉	☉	
 ADGT0803PER-F56	G	2	6,75	9,52	3,35	15°	20°	0,4	1,2	☉	☉	☉	☉	☉	☉	☉	☉	☉	☉	☉	☉	☉	☉	☉	☉	☉	☉	☉	☉	☉		
ADGT1204PER-F56	G	2	8,4	13,6	4,76	15°	20°	0,8	1,2	☉	☉	☉	☉	☉	☉	☉	☉	☉	☉	☉	☉	☉	☉	☉	☉	☉	☉	☉	☉	☉	☉	
ADGT1606PER-F56	G	2	10,8	17,5	6,15	15°	20°	0,8	1,6	☉	☉	☉	☉	☉	☉	☉	☉	☉	☉	☉	☉	☉	☉	☉	☉	☉	☉	☉	☉	☉	☉	
 ADGT10T3PER-G77	G	2	7,25	11,3	3,8	15°	15°	0,8	1,2	☉	☉	☉	☉	☉	☉	☉	☉	☉	☉	☉	☉	☉	☉	☉	☉	☉	☉	☉	☉	☉	☉	
ADGT10T316R-G77	G	2	7,25	11,3	3,8	15°	15°	1,6	1,2	☉	☉	☉	☉	☉	☉	☉	☉	☉	☉	☉	☉	☉	☉	☉	☉	☉	☉	☉	☉	☉	☉	☉
ADGT10T325R-G77	G	2	7,25	11,3	3,8	15°	15°	2,5	1,0	☉	☉	☉	☉	☉	☉	☉	☉	☉	☉	☉	☉	☉	☉	☉	☉	☉	☉	☉	☉	☉	☉	☉
ADGT10T330R-G77	G	2	7,25	11,3	3,8	15°	15°	3,0	0,8	☉	☉	☉	☉	☉	☉	☉	☉	☉	☉	☉	☉	☉	☉	☉	☉	☉	☉	☉	☉	☉	☉	☉
ADGT10T332R-G77	G	2	7,25	11,3	3,8	15°	15°	3,2	0,8	☉	☉	☉	☉	☉	☉	☉	☉	☉	☉	☉	☉	☉	☉	☉	☉	☉	☉	☉	☉	☉	☉	☉
ADGT1204PER-G77	G	2	8,4	13,6	4,76	15°	20°	0,8	1,2	☉	☉	☉	☉	☉	☉	☉	☉	☉	☉	☉	☉	☉	☉	☉	☉	☉	☉	☉	☉	☉	☉	☉
ADGT1606PER-G77	G	2	10,8	17,5	6,15	15°	20°	0,8	1,6	☉	☉	☉	☉	☉	☉	☉	☉	☉	☉	☉	☉	☉	☉	☉	☉	☉	☉	☉	☉	☉	☉	☉



 HC = Coated carbide
 HW = Uncoated carbide

Positive rhombic

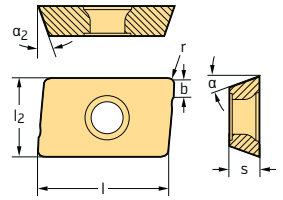
Tiger-tec®



Indexable inserts

Designation	Tolerance class	Number of cutting edges	l ₂ mm	l mm	s mm	α	α ₂	r mm	b mm	P				M		K				N		S		H		
										HC				HC		HC				HC	HW	HC		HC		
										WKP25	WKP35	WKP35S	WSP45	WSM35	WSP45	WAK15	WKK25	WKP25	WKP35	WKP35S	WXN15	WK10	WSM35	WSP45	WHH15	
 ADHT0803PEL-G88	H	2	6,75	9,52	3,35	15°	20°	0,4	1,2																	
ADHT0803PER-G88	H	2	6,75	9,52	3,35	15°	20°	0,4	1,2																	
ADHT10T3PER-G88	H	2	7,25	11,3	3,8	15°	15°	0,8	1,2																	
ADHT1204PEL-G88	H	2	8,4	13,6	4,76	15°	20°	0,8	1,2																	
ADHT1204PER-G88	H	2	8,4	13,6	4,76	15°	20°	0,8	1,2																	
ADHT120416L-G88	H	2	8,4	13,6	4,76	15°	20°	1,6	1,0																	
ADHT120416R-G88	H	2	8,4	13,6	4,76	15°	20°	1,6	1,0																	
ADHT120425L-G88	H	2	8,4	13,6	4,76	15°	20°	2,5	0,8																	
ADHT120425R-G88	H	2	8,4	13,6	4,76	15°	20°	2,5	0,8																	
ADHT120430R-G88	H	2	8,4	13,6	4,76	15°	20°	3,0	0,8																	
ADHT120430L-G88	H	2	8,4	13,6	4,76	15°	20°	3,0	0,8																	
ADHT120440L-G88	H	2	8,4	13,6	4,76	15°	20°	4,0	0,4																	
ADHT120440R-G88	H	2	8,4	13,6	4,76	15°	20°	4,0	0,4																	
ADHT1606PEL-G88	H	2	10,8	17,5	6,15	15°	20°	0,8	1,6																	
ADHT1606PER-G88	H	2	10,8	17,5	6,15	15°	20°	0,8	1,6																	
ADHT160616L-G88	H	2	10,8	17,5	6,15	15°	20°	1,6	1,4																	
ADHT160616R-G88	H	2	10,8	17,5	6,15	15°	20°	1,6	1,4																	
ADHT160625R-G88	H	2	10,8	17,5	6,15	15°	20°	2,5	1,2																	
ADHT160625L-G88	H	2	10,8	17,5	6,15	15°	20°	2,5	1,2																	
ADHT160630L-G88	H	2	10,8	17,5	6,15	15°	20°	3,0	1,2																	
ADHT160630R-G88	H	2	10,8	17,5	6,15	15°	20°	3,0	1,2																	
ADHT160640L-G88	H	2	10,8	17,5	6,15	15°	20°	4,0	1,0																	
ADHT160640R-G88	H	2	10,8	17,5	6,15	15°	20°	4,0	1,0																	
 ADKT0803PEL-F56	K	2	6,75	9,52	3,35	15°	20°	0,4	1,2																	
ADKT0803PER-F56	K	2	6,75	9,52	3,35	15°	20°	0,4	1,2																	
ADKT10T3PER-F56	K	2	7,25	11,3	3,8	15°	15°	0,8	1,2																	
ADKT1204PEL-F56	K	2	8,4	13,6	4,76	15°	20°	0,8	1,2																	
ADKT1204PER-F56	K	2	8,4	13,6	4,76	15°	20°	0,8	1,2																	
ADKT1606PEL-F56	K	2	10,8	17,5	6,15	15°	20°	0,8	1,6																	
ADKT1606PER-F56	K	2	10,8	17,5	6,15	15°	20°	0,8	1,6																	
 ADMT080304R-D56	M	2	6,75	9,52	3,35	15°	20°	0,4	1,2																	
ADMT120408R-D56	M	2	8,4	13,6	4,76	15°	20°	0,8	1,2																	
ADMT160608R-D56	M	2	10,8	17,5	6,15	15°	20°	0,8	1,6																	
ADMT180712R-D56	M	2	14,5	19,0	7,0	15°	17°	1,2	1,8																	

HC = Coated carbide
 HW = Uncoated carbide

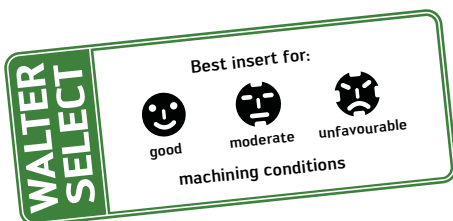

Positive rhombic

Tiger-tec®

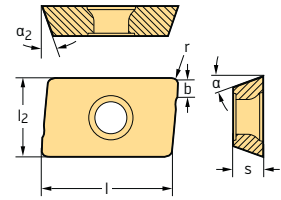

Indexable inserts

Designation	Tolerance class	Number of cutting edges	l ₂ mm	l mm	s mm	α	α ₂	r mm	b mm	P				M		K					N		S		H
										HC				HC		HC					HC	HW	HC		HC
										WKP25	WKP35	WKP35S	WSP45	WSM35	WSP45	WAK15	WKK25	WKP25	WKP35	WKP35S	WXN15	WK10	WSM35	WSP45	WHH15
ADMT080302R-F56	M	2	6,75	9,52	3,35	15°	20°	0,2	1,2	⊕	⊕	⊕	⊕	⊕	⊕							⊕	⊕		
ADMT080304L-F56	M	2	6,75	9,52	3,35	15°	20°	0,4	1,2	⊕	⊕	⊕	⊕	⊕	⊕							⊕	⊕		
ADMT080304R-F56	M	2	6,75	9,52	3,35	15°	20°	0,4	1,2	⊕	⊕	⊕	⊕	⊕	⊕							⊕	⊕		
ADMT080308L-F56	M	2	6,75	9,52	3,35	15°	20°	0,8	1,2	⊕	⊕	⊕	⊕	⊕	⊕							⊕	⊕		
ADMT080308R-F56	M	2	6,75	9,52	3,35	15°	20°	0,8	1,2	⊕	⊕	⊕	⊕	⊕	⊕							⊕	⊕		
ADMT080312R-F56	M	2	6,75	9,52	3,35	15°	20°	1,2	1,0	⊕	⊕	⊕	⊕	⊕	⊕							⊕	⊕		
ADMT080316R-F56	M	2	6,75	9,52	3,35	15°	20°	1,6	1,0	⊕	⊕	⊕	⊕	⊕	⊕							⊕	⊕		
ADMT080320R-F56	M	2	6,75	9,52	3,35	15°	20°	2,0	1,0	⊕	⊕	⊕	⊕	⊕	⊕							⊕	⊕		
ADMT10T304R-F56	M	2	7,25	11,3	3,8	15°	15°	0,4	1,2	⊕	⊕	⊕	⊕	⊕	⊕							⊕	⊕		
ADMT10T308R-F56	M	2	7,25	11,3	3,8	15°	15°	0,8	1,2	⊕	⊕	⊕	⊕	⊕	⊕							⊕	⊕		
ADMT10T312R-F56	M	2	7,25	11,3	3,8	15°	15°	1,2	1,2	⊕	⊕	⊕	⊕	⊕	⊕							⊕	⊕		
ADMT10T316R-F56	M	2	7,25	11,3	3,8	15°	15°	1,6	1,2	⊕	⊕	⊕	⊕	⊕	⊕							⊕	⊕		
ADMT10T320R-F56	M	2	7,25	11,3	3,8	15°	15°	2,0	1,0	⊕	⊕	⊕	⊕	⊕	⊕							⊕	⊕		
ADMT10T325R-F56	M	2	7,25	11,3	3,8	15°	15°	2,5	1,0	⊕	⊕	⊕	⊕	⊕	⊕							⊕	⊕		
ADMT10T330R-F56	M	2	7,25	11,3	3,8	15°	15°	3,0	0,8	⊕	⊕	⊕	⊕	⊕	⊕							⊕	⊕		
ADMT10T332R-F56	M	2	7,25	11,3	3,8	15°	15°	3,2	0,8	⊕	⊕	⊕	⊕	⊕	⊕							⊕	⊕		
ADMT120404R-F56	M	2	6,75	9,52	3,35	15°	20°	0,4	1,2	⊕	⊕	⊕	⊕	⊕	⊕							⊕	⊕		
ADMT120408R-F56	M	2	8,4	13,6	4,76	15°	20°	0,8	1,2	⊕	⊕	⊕	⊕	⊕	⊕							⊕	⊕		
ADMT120408L-F56	M	2	8,4	13,6	4,76	15°	20°	0,8	1,2	⊕	⊕	⊕	⊕	⊕	⊕							⊕	⊕		
ADMT120412R-F56	M	2	8,4	13,6	4,76	15°	20°	1,2	1,2	⊕	⊕	⊕	⊕	⊕	⊕							⊕	⊕		
ADMT120416R-F56	M	2	8,4	13,6	4,76	15°	20°	1,6	1,0	⊕	⊕	⊕	⊕	⊕	⊕							⊕	⊕		
ADMT120416L-F56	M	2	8,4	13,6	4,76	15°	20°	1,6	1,0	⊕	⊕	⊕	⊕	⊕	⊕							⊕	⊕		
ADMT120420R-F56	M	2	8,4	13,6	4,76	15°	20°	2,0	1,0	⊕	⊕	⊕	⊕	⊕	⊕							⊕	⊕		
ADMT120425L-F56	M	2	8,4	13,6	4,76	15°	20°	2,5	0,8	⊕	⊕	⊕	⊕	⊕	⊕							⊕	⊕		
ADMT120425R-F56	M	2	8,4	13,6	4,76	15°	20°	2,5	0,8	⊕	⊕	⊕	⊕	⊕	⊕							⊕	⊕		
ADMT120430R-F56	M	2	8,4	13,6	4,76	15°	20°	3,0	0,8	⊕	⊕	⊕	⊕	⊕	⊕							⊕	⊕		
ADMT120430L-F56	M	2	8,4	13,6	4,76	15°	20°	3,0	0,8	⊕	⊕	⊕	⊕	⊕	⊕							⊕	⊕		
ADMT120432R-F56	M	2	8,4	13,6	4,76	15°	20°	3,2	0,8	⊕	⊕	⊕	⊕	⊕	⊕							⊕	⊕		
ADMT120440L-F56	M	2	8,4	13,6	4,76	15°	20°	4,0	0,4	⊕	⊕	⊕	⊕	⊕	⊕							⊕	⊕		
ADMT120440R-F56	M	2	8,4	13,6	4,76	15°	20°	4,0	0,4	⊕	⊕	⊕	⊕	⊕	⊕							⊕	⊕		
ADMT160608L-F56	M	2	10,8	17,5	6,15	15°	20°	0,8	1,6	⊕	⊕	⊕	⊕	⊕	⊕							⊕	⊕		
ADMT160608R-F56	M	2	10,8	17,5	6,15	15°	20°	0,8	1,6	⊕	⊕	⊕	⊕	⊕	⊕							⊕	⊕		
ADMT160612R-F56	M	2	10,8	17,5	6,15	15°	20°	1,2	1,6	⊕	⊕	⊕	⊕	⊕	⊕							⊕	⊕		
ADMT160616R-F56	M	2	10,8	17,5	6,15	15°	20°	1,6	1,4	⊕	⊕	⊕	⊕	⊕	⊕							⊕	⊕		
ADMT160616L-F56	M	2	10,8	17,5	6,15	15°	20°	1,6	1,4	⊕	⊕	⊕	⊕	⊕	⊕							⊕	⊕		
ADMT160620R-F56	M	2	10,8	17,5	6,15	15°	20°	2,0	1,4	⊕	⊕	⊕	⊕	⊕	⊕							⊕	⊕		
ADMT160625R-F56	M	2	10,8	17,5	6,15	15°	20°	2,5	1,2	⊕	⊕	⊕	⊕	⊕	⊕							⊕	⊕		
ADMT160625L-F56	M	2	10,8	17,5	6,15	15°	20°	2,5	1,2	⊕	⊕	⊕	⊕	⊕	⊕							⊕	⊕		
ADMT160630R-F56	M	2	10,8	17,5	6,15	15°	20°	3,0	1,2	⊕	⊕	⊕	⊕	⊕	⊕							⊕	⊕		
ADMT160630L-F56	M	2	10,8	17,5	6,15	15°	20°	3,0	1,2	⊕	⊕	⊕	⊕	⊕	⊕							⊕	⊕		
ADMT160632R-F56	M	2	10,8	17,5	6,15	15°	20°	3,2	1,2	⊕	⊕	⊕	⊕	⊕	⊕							⊕	⊕		
ADMT160640L-F56	M	2	10,8	17,5	6,15	15°	20°	4,0	1,0	⊕	⊕	⊕	⊕	⊕	⊕							⊕	⊕		
ADMT160640R-F56	M	2	10,8	17,5	6,15	15°	20°	4,0	1,0	⊕	⊕	⊕	⊕	⊕	⊕							⊕	⊕		
ADMT160650R-F56	M	2	10,8	17,5	6,15	15°	20°	5,0	-	⊕	⊕	⊕	⊕	⊕	⊕							⊕	⊕		
ADMT160660R-F56	M	2	10,8	17,5	6,15	15°	20°	6,0	-	⊕	⊕	⊕	⊕	⊕	⊕							⊕	⊕		
ADMT180712R-F56	M	2	14,5	19,0	7,0	15°	20°	1,2	1,8	⊕	⊕	⊕	⊕	⊕	⊕							⊕	⊕		

 HC = Coated carbide
 HW = Uncoated carbide

Positive rhombic

Tiger-tec®

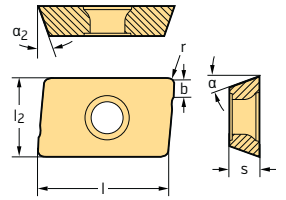

Indexable inserts

Designation	Tolerance class	Number of cutting edges	l ₂ mm	l mm	s mm	α	α ₂	r mm	b mm	P				M		K				N		S		H
										HC				HC		HC				HC	HW	HC		HC
										WKP25	WKP35	WKP35S	WSP45	WSM35	WSP45	WAK15	WKK25	WKP25	WKP35	WKP35S	WXN15	WK10	WSM35	WSP45
 ADMT080304R-G56	M	2	6,75	9,52	3,35	15°	20°	0,4	1,2	☉	☉	☉	☉	☉	☉			☉	☉		☉	☉		
ADMT10T308R-G56	M	2	7,25	11,3	3,8	15°	15°	0,8	1,2	☉	☉	☉	☉	☉	☉			☉	☉		☉	☉		
ADMT10T316R-G56	M	2	7,25	11,3	3,8	15°	15°	1,6	1,2	☉	☉	☉	☉	☉	☉			☉	☉		☉	☉		
ADMT10T325R-G56	M	2	7,25	11,3	3,8	15°	15°	2,5	1,0	☉	☉	☉	☉	☉	☉			☉	☉		☉	☉		
ADMT10T332R-G56	M	2	7,25	11,3	3,8	15°	15°	3,2	0,8	☉	☉	☉	☉	☉	☉			☉	☉		☉	☉		
ADMT120408R-G56	M	2	8,4	13,6	4,76	15°	20°	0,8	1,2	☉	☉	☉	☉	☉	☉			☉	☉		☉	☉		
ADMT160608R-G56	M	2	10,8	17,5	6,15	15°	20°	0,8	1,6	☉	☉	☉	☉	☉	☉			☉	☉		☉	☉		

HC = Coated carbide
 HW = Uncoated carbide

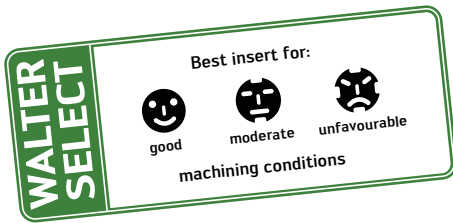

Positive rhombic

Tiger-tec®

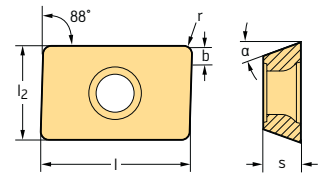

Indexable inserts

Designation	Tolerance class	Number of cutting edges	l ₂ mm	l mm	s mm	α	r mm	b mm	P				M		K				N		S		H	
									HC	HC	HC	HC	HC	HC	HC	HW	HC	HW	HC	HC	HC			
									WKP25	WKP35	WKP35S	WSP45	WSM35	WSP45	WAK15	WKK25	WKP25	WKP35	WKP35S	WXN15	WK10	WSM35	WSP45	WHH15
LPGT070304R-F55	G	2	6,35	7,94	3,18	11°	0,4	1,2	⊕	⊕	⊕	⊕	⊕	⊕	⊕	⊕	⊕	⊕	⊕	⊕	⊕	⊕	⊕	⊕
LPGT15T308R-F55	G	2	9,52	15	3,97	11°	0,8	1,4	⊕	⊕	⊕	⊕	⊕	⊕	⊕	⊕	⊕	⊕	⊕	⊕	⊕	⊕	⊕	⊕
LPGT150412R-F55	G	2	12,7	15,88	4,76	11°	1,2	1,6	⊕	⊕	⊕	⊕	⊕	⊕	⊕	⊕	⊕	⊕	⊕	⊕	⊕	⊕	⊕	⊕
LPGT1506PPR-F57	G	2	12,7	15,88	6,35	11°	1,2	1,6	⊕	⊕	⊕	⊕	⊕	⊕	⊕	⊕	⊕	⊕	⊕	⊕	⊕	⊕	⊕	⊕
LPGW070304R-A57	G	2	6,35	7,94	3,18	11°	0,4	1,2	⊕	⊕	⊕	⊕	⊕	⊕	⊕	⊕	⊕	⊕	⊕	⊕	⊕	⊕	⊕	⊕
LPGW15T308R-A57	G	2	9,52	15	3,97	11°	0,8	1,4	⊕	⊕	⊕	⊕	⊕	⊕	⊕	⊕	⊕	⊕	⊕	⊕	⊕	⊕	⊕	⊕
LPGW150412R-A57	G	2	12,7	15,88	4,76	11°	1,2	1,6	⊕	⊕	⊕	⊕	⊕	⊕	⊕	⊕	⊕	⊕	⊕	⊕	⊕	⊕	⊕	⊕
LPHW150612R-A51	H	2	15,88	12,7	6,35	11°	1,2	-	⊕	⊕	⊕	⊕	⊕	⊕	⊕	⊕	⊕	⊕	⊕	⊕	⊕	⊕	⊕	⊕
LPHW1506PPR-A57	H	2	12,7	15,88	6,35	11°	1,2	1,6	⊕	⊕	⊕	⊕	⊕	⊕	⊕	⊕	⊕	⊕	⊕	⊕	⊕	⊕	⊕	⊕
LPMT070304R-D51	M	2	6,35	7,94	3,18	11°	0,4	1,2	⊕	⊕	⊕	⊕	⊕	⊕	⊕	⊕	⊕	⊕	⊕	⊕	⊕	⊕	⊕	⊕
LPMT15T308R-D51	M	2	9,52	15	3,97	11°	0,8	1,4	⊕	⊕	⊕	⊕	⊕	⊕	⊕	⊕	⊕	⊕	⊕	⊕	⊕	⊕	⊕	⊕
LPMT150412R-D51	M	2	12,7	15,88	4,76	11°	1,2	1,6	⊕	⊕	⊕	⊕	⊕	⊕	⊕	⊕	⊕	⊕	⊕	⊕	⊕	⊕	⊕	⊕
LPMT150612R-D51	M	2	12,7	15,88	6,35	11°	1,2	-	⊕	⊕	⊕	⊕	⊕	⊕	⊕	⊕	⊕	⊕	⊕	⊕	⊕	⊕	⊕	⊕
LPMT150612R-D57	M	2	12,7	15,88	6,35	11°	1,2	-	⊕	⊕	⊕	⊕	⊕	⊕	⊕	⊕	⊕	⊕	⊕	⊕	⊕	⊕	⊕	⊕
LPMW070304TR-A27	M	2	6,35	7,94	3,18	11°	0,4	-	⊕	⊕	⊕	⊕	⊕	⊕	⊕	⊕	⊕	⊕	⊕	⊕	⊕	⊕	⊕	⊕
LPMW15T308TR-A27	M	2	9,52	15	3,97	11°	0,8	-	⊕	⊕	⊕	⊕	⊕	⊕	⊕	⊕	⊕	⊕	⊕	⊕	⊕	⊕	⊕	⊕
LPMW150412TR-A27	M	2	12,7	15,88	4,76	11°	1,2	-	⊕	⊕	⊕	⊕	⊕	⊕	⊕	⊕	⊕	⊕	⊕	⊕	⊕	⊕	⊕	⊕
LPMW150612TR-A27	M	2	12,7	15,88	6,35	11°	1,2	-	⊕	⊕	⊕	⊕	⊕	⊕	⊕	⊕	⊕	⊕	⊕	⊕	⊕	⊕	⊕	⊕

 HC = Coated carbide
 HW = Uncoated carbide

Positive rhombic

Tiger-tec®

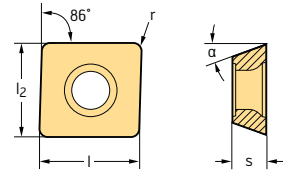

Indexable inserts

Designation	Tolerance class	Number of cutting edges	l ₂ mm	l mm	s mm	α	r mm	P				M		K				N		S		H	
								WC	HC	WC	HC	WC	HC	WC	HC	WC	HW	WC	HC	WC	HC	WC	HC
MPHT120408-G88	H	2	12,7	12,7	4,76	11°	0,8	⊕	⊕	⊕	⊕							⊕					
MPHW120408-A57	H	2	12,7	12,7	4,76	11°	0,8	⊕	⊕	⊕				⊕									
MPHX060304-A57	H	2	6,35	6,35	3,18	11°	0,4	⊕	⊕	⊕				⊕									
MPHX080305-A57	H	2	8,3	8,3	3,18	11°	0,5	⊕	⊕	⊕				⊕									
MPHX060304-G88	H	2	6,35	6,35	3,18	11°	0,4											⊕					
MPHX080305-G88	H	2	8,3	8,3	3,18	11°	0,5											⊕					
MPMT120408-F57	M	2	12,7	12,7	4,76	11°	0,8	⊕	⊕	⊕	⊕	⊕								⊕	⊕		
MPMX060304-F57	M	2	6,35	6,35	3,18	11°	0,4	⊕	⊕	⊕	⊕	⊕								⊕	⊕		
MPMX080305-F57	M	2	8,3	8,3	3,18	11°	0,5	⊕	⊕	⊕	⊕	⊕	⊕							⊕	⊕		

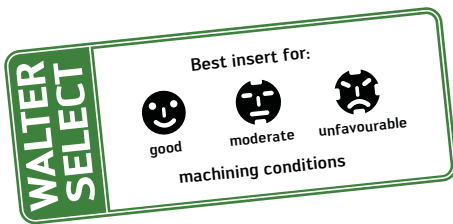

HC = Coated carbide
 HW = Uncoated carbide

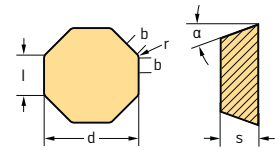

Positive octagonal

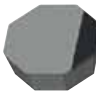

Indexable inserts

Designation	Tolerance class	Number of cutting edges	l mm	d mm	s mm	α	r mm	b mm	P				M		K				N		S		H		
									WC	HC	WC	HC	WC	HC	WC	HC	WC	HC	WC	HC	WC	HC			
 OPHN0504ZZN-A27	H	2	5	12,7	4,76	11°	0,4	1,2																	
 OPHN050412-A57 OPHN0504ZZN-A57	H	8	5	12,7	4,76	11°	1,2	-																	
	H	8	5	12,7	4,76	11°	0,4	1,2	⊕	⊗					⊕		⊕	⊗	⊕						
 OPHR0504ZZN-F57	H	8	5	12,7	4,76	11°	0,4	1,2																	
										⊕															

HC = Coated carbide
 HW = Uncoated carbide
 CN = Silicon nitride Si₃N₄
 BH = CBN with high CBN content

Positive octagonal

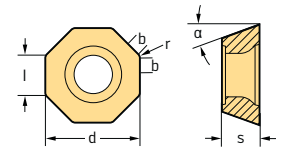

Indexable inserts

Designation	Tolerance class	Number of cutting edges	l mm	d mm	s mm	α	r mm	b mm	P				M		K					N		S		H	HF			
									HC				HC		HC					CN	HC	HW	HC		HC	HF		
									WKP25	WKP35	WKP35S	WSP45	WSM35	WSP45	WAK15	WKK25	WKP25	WKP35	WKP35S	WSN10	WXN15	WK10	WSM35	WSP45	WHH15	WMG40		
ODHT050408-F57	H	8	5	12,7	4,76	15°	0,8	-	⊗	⊗	⊗	⊗	⊗	⊗														
ODHT0504ZZN-F57*	H	8	5	12,7	4,76	15°	0,8	1,2	⊗	⊗	⊗	⊗	⊗	⊗													⊗	
ODHT060512-F57	H	8	6	15,88	5,56	15°	0,8	-	⊗	⊗	⊗	⊗	⊗	⊗														
ODHT0605ZZN-F57*	H	8	6	15,88	5,56	15°	0,8	1,6	⊗	⊗	⊗	⊗	⊗	⊗													⊗	
ODHT050408-G88	H	8	5	12,7	4,76	15°	0,8	-													⊗	⊗						
ODHT0504ZZN-G88*	H	8	5	12,7	4,76	15°	0,8	1,2													⊗	⊗						
ODHT060512-G88	H	8	6	15,88	5,56	15°	0,8	-													⊗	⊗						
ODHT0605ZZN-G88*	H	8	6	15,88	5,56	15°	0,8	1,6													⊗	⊗						
ODHW050412-A57	H	8	5	12,7	4,76	15°	1,2	-												⊗								
ODHW060516-A57	H	8	5	15,88	5,56	15°	1,6	-												⊗								
ODHW050408-A57	H	8	5	12,7	4,76	15°	0,8	-	⊗	⊗	⊗				⊗		⊗	⊗	⊗									
ODHW0504ZZN-A57*	H	8	5	12,7	4,76	15°	0,8	1,2	⊗	⊗	⊗				⊗		⊗	⊗	⊗									
ODHW060512-A57	H	8	6	15,88	5,56	15°	1,2	-	⊗	⊗	⊗				⊗		⊗	⊗	⊗									
ODHW0605ZZN-A57*	H	8	6	15,88	5,56	15°	0,8	1,6	⊗	⊗	⊗				⊗		⊗	⊗	⊗									
ODMT050408-D57	M	8	5	12,7	4,76	15°	0,8	-	⊗	⊗	⊗	⊗	⊗	⊗		⊗	⊗	⊗	⊗				⊗	⊗				
ODMT0504ZZN-D57*	M	8	5	12,7	4,76	15°	0,8	1,2	⊗	⊗	⊗	⊗	⊗	⊗		⊗	⊗	⊗	⊗				⊗	⊗				
ODMT060512-D57	M	8	6	15,88	5,56	15°	1,2	-	⊗	⊗	⊗	⊗	⊗	⊗		⊗	⊗	⊗	⊗				⊗	⊗				
ODMT0605ZZN-D57*	M	8	6	15,88	5,56	15°	0,8	1,6	⊗	⊗	⊗	⊗	⊗	⊗		⊗	⊗	⊗	⊗				⊗	⊗				
ODMW050408T-A27	M	8	5	12,7	4,76	15°	0,8	-	⊗	⊗	⊗					⊗	⊗	⊗	⊗									
ODMW060508T-A27	M	8	6	15,88	5,56	15°	0,8	-	⊗	⊗	⊗					⊗	⊗	⊗	⊗									
ODMW050408-A57	M	8	5	12,7	4,76	15°	0,8	-	⊗	⊗	⊗				⊗	⊗	⊗	⊗	⊗									
ODMW060508-A57	M	8	6	15,88	5,56	15°	0,8	-	⊗	⊗	⊗				⊗	⊗	⊗	⊗	⊗									

* ZZN for k = 43° only

HC = Coated carbide
 HW = Uncoated carbide
 HF = Uncoated fine-grained carbide
 CN = Silicon nitride Si₃N₄

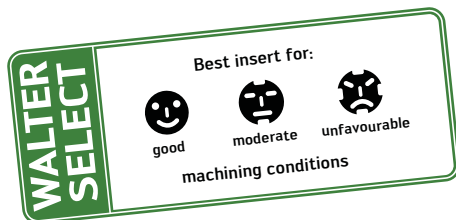

Positive triangular

Tiger-tec®

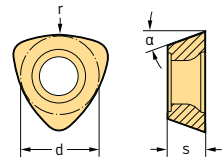

Indexable inserts

Designation	Tolerance class	Number of cutting edges	d mm	s mm	α	R mm	P				M		K				N		S		H
							HC				HC		HC				HC	HW	HC		HC
							WKP25	WKP35	WKP35S	WSP45	WSM35	WSP45	WAK15	WKK25	WKP25	WKP35	WKP35S	WXN15	WK10	WSM35	WSP45
	P26315R10	M	3	6,75	2,78	14°	10,0	☺	☺	☺	☺	☺	☺			☺	☺	☺	☺		
	P26315R12	M	3	8,5	3,18	14°	12,5	☺	☺	☺	☺	☺	☺			☺	☺	☺	☺		
	P26315R15	M	3	10,5	3,97	14°	15,0	☺	☺	☺	☺	☺	☺			☺	☺	☺	☺		
	P26315R16	M	3	10,5	3,97	14°	16,0	☺	☺	☺	☺	☺	☺			☺	☺	☺	☺		
	P26315R20	M	3	12,7	4,76	11°	20,0	☺	☺	☺	☺	☺	☺			☺	☺	☺	☺		
	P26315R25	M	3	12,7	4,76	11°	25,0	☺	☺	☺	☺	☺	☺			☺	☺	☺	☺		
	P26315R31	M	3	12,7	4,76	11°	31,5	☺	☺	☺	☺	☺	☺			☺	☺	☺	☺		
	P26316R10-G88	G	3	6,75	2,78	14°	10,0									☺					
	P26316R12-G88	G	3	8,5	3,18	14°	12,5									☺					
	P26316R15-G88	G	3	10,5	3,97	14°	15,0									☺					
	P26316R16-G88	G	3	10,5	3,97	14°	16,0									☺					
	P26316R20-G88	G	3	12,7	4,76	11°	20,0									☺					
	P26316R25-G88	G	3	12,7	4,76	11°	25,0									☺					
	P26316R31-G88	G	3	12,7	4,76	11°	31,5									☺					
	P26325R25	M	3	13,0	5,56	14°	25,0	☺	☺	☺	☺	☺	☺	☺	☺			☺	☺		
	P26325R31	M	3	13,0	5,56	14°	31,5	☺	☺	☺	☺	☺	☺	☺	☺			☺	☺		

HC = Coated carbide
HW = Uncoated carbide

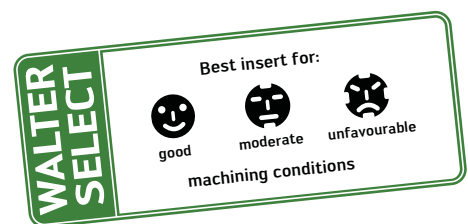

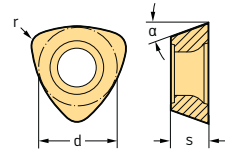

Positive triangular

Tiger-tec®



Indexable inserts

Designation	Tolerance class	Number of cutting edges	d mm	s mm	α	r mm	P				M		K				N		S		H
							HC				HC		HC				HC	HW	HC		HC
							WKP25	WKP35	WKP35S	WSP45	WSM35	WSP45	WAK15	WKK25	WKP25	WKP35	WKP35S	WXN15	WK10	WSM35	WSP45
 P26335R10 P26335R14 P26335R25	M	3	6,75	3,18	14°	0,8	☺	☺	☺	☺	☺	☺		☺	☺	☺		☺	☺		
	M	3	9,52	3,97	14°	1,2	☺	☺	☺	☺	☺	☺		☺	☺	☺		☺	☺		
	M	3	13,0	5,56	14°	2,0	☺	☺	☺	☺	☺	☺		☺	☺	☺		☺	☺		
 P26337R10 P26337R14 P26337R25	M	3	6,75	3,18	14°	0,8	☺	☺	☺	☺	☺	☺		☺	☺	☺		☺	☺		
	M	3	9,52	3,97	14°	1,2	☺	☺	☺	☺	☺	☺		☺	☺	☺		☺	☺		
	M	3	13,0	5,56	14°	2,0	☺	☺	☺	☺	☺	☺		☺	☺	☺		☺	☺		
 P26339R10 P26339R14 P26339R25	M	3	6,75	3,18	14°	0,8	☺	☺	☺	☺	☺	☺		☺	☺	☺		☺	☺		
	M	3	9,52	3,97	14°	1,2	☺	☺	☺	☺	☺	☺		☺	☺	☺		☺	☺		
	M	3	13,0	5,56	14°	2,0	☺	☺	☺	☺	☺	☺		☺	☺	☺		☺	☺		

HC = Coated carbide
HW = Uncoated carbide

Positive triangular

Tiger-tec®

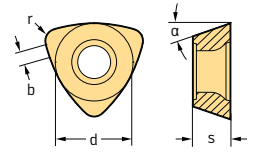

Indexable inserts

Designation	Tolerance class	Number of cutting edges	d mm	s mm	α	r mm	b mm	P				M		K				N		S		H
								HC				HC		HC				HC	HW	HC		HC
								WKP25	WKP35	WKP35S	WSP45	WSM35	WSP45	WAK15	WKK25	WKP25	WKP35	WKP35S	WXN15	WK10	WSM35	WSP45
 P26379-R10 P26379-R14 P26379-R25	M	3	6,75	3,18	14°	0,8	0,9	☺	☺	☺	☺	☺	☺		☺	☺	☺		☺	☺		
	M	3	9,52	3,97	14°	1,2	1,0	☺	☺	☺	☺	☺	☺		☺	☺	☺		☺	☺		
	M	3	13,0	5,6	14°	2,0	1,1	☺	☺	☺	☺	☺	☺		☺	☺	☺		☺	☺		



HC = Coated carbide
HW = Uncoated carbide

Profile inserts

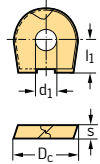
Tiger-tec®



Indexable inserts

Designation	Tolerance class	Number of cutting edges	D _c ^{+0.03} mm	s mm	l ₁ mm	d ₁ mm	P				M				K				N		S				H
							WKP25	WKP35	WKP35S	WSP45	WSP46	WSM35	WSM36	WSP45	WSP46	WAK15	WKK25	WKP25	WKP35	WKP35S	WXN15	WK10	WSM35	WSM36	WSP45
 P3201-D08	H	2	8	2.0	4	3	⊗	⊗									⊗	⊗							⊗
P3201-D10	H	2	10	2.5	5	4	⊗	⊗									⊗	⊗							⊗
P3201-D12	H	2	12	2.5	6	5	⊗	⊗									⊗	⊗							⊗
P3201-D16	H	2	16	3.0	6	5	⊗	⊗									⊗	⊗							⊗
P3201-D20	H	2	20	3.0	6	5	⊗	⊗									⊗	⊗							⊗
P3201-D25	H	2	25	4.0	9	6	⊗	⊗									⊗	⊗							⊗
P3201-D30	H	2	30	5.0	10	8	⊗	⊗									⊗	⊗							⊗
P3201-D32	H	2	32	5.0	10	8	⊗	⊗									⊗	⊗							⊗
 P3204-D08	H	2	8	2.0	4	3	⊗				⊗						⊗						⊗	⊗	⊗
P3204-D10	H	2	10	2.5	5	4	⊗				⊗						⊗						⊗	⊗	⊗
P3204-D12	H	2	12	2.5	6	5	⊗				⊗						⊗						⊗	⊗	⊗
P3204-D16	H	2	16	3.0	6	5	⊗				⊗						⊗						⊗	⊗	⊗
P3204-D20	H	2	20	3.0	6	5	⊗				⊗						⊗						⊗	⊗	⊗
P3204-D25	H	2	25	4.0	9	6	⊗				⊗						⊗						⊗	⊗	⊗
P3204-D30	H	2	30	5.0	10	8	⊗				⊗						⊗						⊗	⊗	⊗
P3204-D32	H	2	32	5.0	10	8	⊗				⊗						⊗						⊗	⊗	⊗

HC = Coated carbide

HW = Uncoated carbide

Toric profile inserts

Tiger-tec®

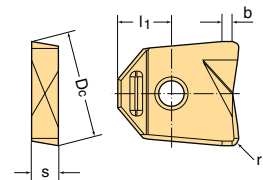

Indexable inserts

Designation	Tolerance class	Number of cutting edges	D _c ^{+0.01} mm	s mm	r mm	b mm	l ₁ mm	P				M				K				N		S				H
								WKP25	WKP35	WKP35S	WSP45	WSP46	WSM35	WSP45	WSP46	WAK15	WKK25	WKP25	WKP35	WKP35S	WXN15	WK10	WSM35	WSP45	WSP46	WHH15
 P8001-D12R05R-A57	H	2	12	2.5	0.5	1.5	7.0	⊗	⊗								⊗								⊗	
P8001-D12R10R-A57	H	2	12	2.5	1.0	1.5	7.0	⊗	⊗								⊗								⊗	
P8001-D16R10R-A57	H	2	16	4.0	1.0	1.5	8.0	⊗	⊗								⊗								⊗	
P8001-D20R16R-A57	H	2	20	5.0	1.6	1.5	10.2	⊗	⊗								⊗								⊗	
P8001-D25R20R-A57	H	2	25	6.0	2.0	1.5	10.7	⊗	⊗								⊗								⊗	
P8001-D32R20R-A57	H	2	32	6.0	2.0	1.5	12.0	⊗	⊗								⊗								⊗	

HC = Coated carbide

HW = Uncoated carbide

Positive round

Tiger-tec®

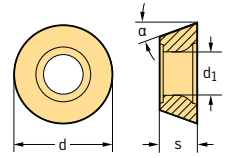

Indexable inserts

Designation	Tolerance class	Number of cutting edges	d mm	s mm	α	d ₁ mm	P				M		K				N		S		H
							HC				HC		HC				HC	HW	HC		HC
							WKP25	WKP35	WKP35S	WSP45	WSM35	WSP45	WAK15	WKK25	WKP25	WKP35	WKP35S	WXN15	WK10	WSM35	WSP45
ROGX0803M0-G77	G	4	8	3,18	11°	3,4				☒	☒	☒						☒	☒		
ROGX10T3M0-G77	G	4	10	3,97	11°	4,4				☒	☒	☒						☒	☒		
ROGX1204M0-G77	G	4	12	4,76	11°	4,4				☒	☒	☒						☒	☒		
ROGX1605M0-G77	G	6	16	5,56	15°	5,5				☒	☒	☒						☒	☒		
ROHX0803M0T-A27	H	4	8	3,18	11°	3,4	☒	☒	☒					☒	☒	☒					
ROHX10T3M0T-A27	H	4	10	3,97	11°	4,4	☒	☒	☒					☒	☒	☒					
ROHX1204M0T-A27	H	4	12	4,76	11°	4,4	☒	☒	☒					☒	☒	☒					
ROHX1605M0T-A27	H	6	16	5,56	15°	5,5	☒	☒	☒					☒	☒	☒					
ROHX2006M0T-A27	H	8	20	6,35	15°	6,5	☒	☒	☒					☒	☒	☒					
ROHX0803M0-D57	H	4	8	3,18	11°	3,4	☒	☒	☒	☒	☒	☒		☒	☒	☒		☒	☒		
ROHX10T3M0-D57	H	4	10	3,97	11°	4,4	☒	☒	☒	☒	☒	☒		☒	☒	☒		☒	☒		
ROHX1204M0-D57	H	4	12	4,76	11°	4,4	☒	☒	☒	☒	☒	☒		☒	☒	☒		☒	☒		
ROHX1605M0-D57	H	6	16	5,56	15°	5,5	☒	☒	☒	☒	☒	☒		☒	☒	☒		☒	☒		
ROHX2006M0-D57	H	8	20	6,35	15°	6,5	☒	☒	☒	☒	☒	☒		☒	☒	☒		☒	☒		
ROHX0803M0-D67	H	4	8	3,18	11°	3,4		☒	☒	☒	☒	☒				☒		☒	☒		
ROHX10T3M0-D67	H	4	10	3,97	11°	4,4		☒	☒	☒	☒	☒				☒		☒	☒		
ROHX1204M0-D67	H	4	12	4,76	11°	4,4		☒	☒	☒	☒	☒				☒		☒	☒		
ROHX1605M0-D67	H	6	16	5,56	15°	5,5		☒	☒	☒	☒	☒				☒		☒	☒		
ROMX0803M0-D57	M	4	8	3,18	11°	3,4		☒	☒	☒	☒	☒				☒		☒	☒		
ROMX10T3M0-D57	M	4	10	3,97	11°	4,4		☒	☒	☒	☒	☒				☒		☒	☒		
ROMX1204M0-D57	M	4	12	4,76	11°	4,4		☒	☒	☒	☒	☒				☒		☒	☒		
ROMX1605M0-D57	M	6	16	5,56	15°	5,5		☒	☒	☒	☒	☒				☒		☒	☒		
ROMX2006M0-D57	M	8	20	6,35	15°	6,5		☒	☒	☒	☒	☒				☒		☒	☒		

HC = Coated carbide
HW = Uncoated carbide

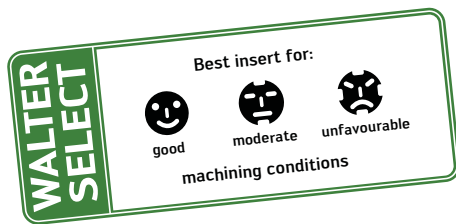

Positive round

Tiger-tec®

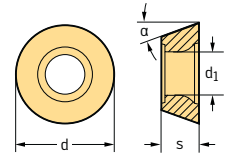

Indexable inserts

Designation	Tolerance class	d mm	s mm	α	d ₁ mm	P				M		K			N		S		H	HF
						HC				HC		HC			HC	HW	HC		HC	
						WKP25	WKP35	WKP35S	WSP45	WSM35	WSP45	WAK15	WKK25	WKP25	WKP35	WKP35S	WXN15	WK10	WSM35	WSP45
	RDGT0803M0-G85	G	8	3,18	15°	3,4														
	RDGT10T3M0-G85	G	10	3,97	15°	4,4														
	RDGT1204M0-G85	G	12	4,76	15°	4,4														
	RDGT1505M0-G85	G	15	5,56	15°	5,5														
	RDGT1605M0-G85	G	16	5,56	15°	5,5														
	RDGT2006M0-G85	G	20	6,35	15°	6,5														
	RDGT0803M0-G88	G	8	3,18	15°	3,4							☉	☉						
	RDGT10T3M0-G88	G	10	3,97	15°	4,4							☉	☉						
	RDGT1204M0-G88	G	12	4,76	15°	4,4							☉	☉						
	RDGT1505M0-G88	G	15	5,56	15°	5,5							☉	☉						
	RDGT1605M0-G88	G	16	5,56	15°	5,5							☉	☉						
	RDGT2006M0-G88	G	20	6,35	15°	6,5							☉	☉						
	RDHW0803M0-A27	H	8	3,18	15°	3,4	☉	☉	☉				☉	☉	☉					
	RDHW10T3M0-A27	H	10	3,97	15°	4,4	☉	☉	☉				☉	☉	☉					
	RDHW1204M0-A27	H	12	4,76	15°	4,4	☉	☉	☉				☉	☉	☉					
	RDHW1505M0-A27	H	15	5,56	15°	5,5	☉	☉	☉				☉	☉	☉					
	RDHW1605M0-A27	H	16	5,56	15°	5,5	☉	☉	☉				☉	☉	☉					
	RDHW2006M0-A27	H	20	6,35	15°	6,5	☉	☉	☉				☉	☉	☉					
	RDHW0803M0-A57	H	8	3,18	15°	3,4	☉					☉	☉						☉	
	RDHW10T3M0-A57	H	10	3,97	15°	4,4	☉					☉	☉						☉	
	RDHW1204M0-A57	H	12	4,76	15°	4,4	☉					☉	☉						☉	
	RDHW1505M0-A57	H	15	5,56	15°	5,5	☉					☉	☉						☉	
	RDHW1605M0-A57	H	16	5,56	15°	5,5	☉					☉	☉						☉	
	RDHW2006M0-A57	H	20	6,35	15°	6,5	☉					☉	☉						☉	
	RDMT0803M0-D57	M	8	3,18	15°	3,4	☉	☉	☉	☉	☉		☉	☉	☉		☉	☉		
	RDMT10T3M0-D57	M	10	3,97	15°	4,4	☉	☉	☉	☉	☉		☉	☉	☉		☉	☉		
	RDMT1204M0-D57	M	12	4,76	15°	4,4	☉	☉	☉	☉	☉		☉	☉	☉		☉	☉		
	RDMT1505M0-D57	M	15	5,56	15°	5,5	☉	☉	☉	☉	☉		☉	☉	☉		☉	☉		
	RDMT1605M0-D57	M	16	5,56	15°	5,5	☉	☉	☉	☉	☉		☉	☉	☉		☉	☉		
	RDMT2006M0-D57	M	20	6,35	15°	6,5	☉	☉	☉	☉	☉		☉	☉	☉		☉	☉		
	RDMW0803M0-A27	M	8	3,18	15°	3,4	☉	☉	☉				☉	☉	☉					
	RDMW10T3M0-A27	M	10	3,97	15°	4,4	☉	☉	☉				☉	☉	☉					
	RDMW1204M0-A27	M	12	4,76	15°	4,4	☉	☉	☉				☉	☉	☉					
	RDMW1605M0-A27	M	16	5,56	15°	5,5	☉	☉	☉				☉	☉	☉					
	RDMW2006M0-A27	M	20	6,35	15°	6,5	☉	☉	☉				☉	☉	☉					

HC = Coated carbide
 HW = Uncoated carbide
 HF = Uncoated fine-grained carbide

Positive round

Tiger-tec®

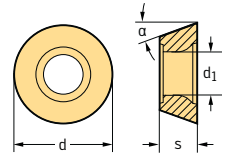

Indexable inserts

Designation	Tolerance class	d mm	s mm	α	d ₁ mm	P				M		K			N		S		H	HF			
						HC	HC	HC	HC	HC	HC	HC	HW	HC	HC	HC	HF						
						WKP25	WKP35	WKP35S	WSP45	WSM35	WSP45	WAK15	WKK25	WKP25	WKP35	WKP35S	WXN15	WK10	WSM35	WSP45	WHH15	WMG40	
	RDMX0702M0T-A27	M	7	2,38	15°	2,8	☉	☉	☉					☉	☉	☉							
	RDMX1003M0T-A27	M	10	3,18	15°	4,4	☉	☉	☉					☉	☉	☉							
	RDMX12T3M0T-A27	M	12	3,97	15°	4,4	☉	☉	☉					☉	☉	☉							
	RDMX1604M0T-A27	M	16	4,76	15°	5,5	☉	☉	☉					☉	☉	☉							
	RDMX2006M0T-A27	M	20	6,0	15°	5,5	☉	☉	☉					☉	☉	☉							
	RDHX0702M0T-A27	H	7	2,38	15°	2,8	☉	☉	☉					☉	☉	☉							
	RDHX07T1M0T-A27	H	7	1,99	15°	2,8	☉	☉	☉					☉	☉	☉							
	RDHX1003M0T-A27	H	10	3,18	15°	4,4	☉	☉	☉					☉	☉	☉							
	RDHX12T3M0T-A27	H	12	3,97	15°	4,4	☉	☉	☉					☉	☉	☉							
	RDHX1604M0T-A27	H	16	4,76	15°	5,5	☉	☉	☉					☉	☉	☉							
	RDHX2006M0T-A27	H	20	6,0	15°	5,5	☉	☉	☉					☉	☉	☉							
	RDHX0501M0-A57	H	5	1,47	15°	2,15	☉					☉		☉								☉	
	RDHX0702M0-A57	H	7	2,38	15°	2,8	☉					☉		☉								☉	
	RDHX07T1M0-A57	H	7	1,99	15°	2,8	☉					☉		☉								☉	
	RDHX1003M0-A57	H	10	3,18	15°	4,4	☉					☉		☉								☉	
	RDHX12T3M0-A57	H	12	3,97	15°	4,4	☉					☉		☉								☉	
	RDHX1604M0-A57	H	16	4,76	15°	5,5	☉					☉		☉								☉	
	RDGX0501M0-G85	G	5	1,45	15°	2,15																	☉
	RDGX0702M0-G85	G	7	2,38	15°	2,8																	☉
	RDGX07T1M0-G85	G	7	1,99	15°	2,8																	☉
	RDGX1003M0-G85	G	10	3,18	15°	4,4																	☉
	RDGX12T3M0-G85	G	12	3,97	15°	4,4																	☉
	RDGX1604M0-G85	G	16	4,76	15°	5,5																	☉

HC = Coated carbide
 HW = Uncoated carbide
 HF = Uncoated fine-grained carbide

WALTER SELECT

Best insert for:

☺
good

☹
moderate

☹
unfavourable

machining conditions

Positive square

Tiger-tec®

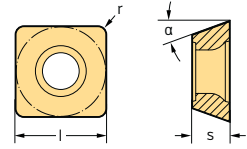

Indexable inserts

Designation	Tolerance class	Number of cutting edges	l mm	s mm	α	r mm	P				M		K				N		S		H	
							HC				HC		HC				CN	HC	HW	HC		HC
							WKP25	WKP35	WKP35S	WSP45	WSM35	WSP45	WAK15	WKK25	WKP25	WKP35	WKP35S	WSN10	WXN15	WK10	WSM35	WSP45
SPGT120606-F57	G	4	12,7	6,35	11°	0,6	☉	☉	☉	☉	☉	☉	☉	☉	☉	☉	☉	☉	☉	☉		
SPHT060304-G88	H	4	6,35	3,18	11°	0,4											☉	☉				
SPHT09T308-G88	H	4	9,52	3,97	11°	0,8											☉	☉				
SPHT120408-G88	H	4	12,7	4,76	11°	0,8											☉	☉				
SPHW120412-A57	H	4	12,7	4,76	11°	1,2						☉										
SPHW120416-A57	H	4	12,7	4,76	11°	1,6						☉										
SPHW120606-A57	H	4	12,7	6,35	11°	0,6	☉	☉					☉	☉								
SPHW120606-A51	H	4	12,7	6,35	11°	0,6	☉	☉					☉	☉								
SPMT060304-D51	M	4	6,35	3,18	11°	0,4	☉	☉	☉	☉	☉	☉	☉	☉					☉	☉		
SPMT09T308-D51	M	4	9,52	3,97	11°	0,8	☉	☉	☉	☉	☉	☉	☉	☉					☉	☉		
SPMT120408-D51	M	4	12,7	4,76	11°	0,8	☉	☉	☉	☉	☉	☉	☉	☉					☉	☉		
SPMT120606-D51	M	4	12,7	6,35	11°	0,6	☉	☉	☉	☉	☉	☉	☉	☉					☉	☉		
SPMT120606-D57	M	4	12,7	6,35	11°	0,6	☉	☉	☉	☉	☉	☉	☉	☉					☉	☉		
SPMT060304-F55	M	4	6,35	3,18	11°	0,4	☉	☉	☉	☉	☉	☉	☉	☉					☉	☉		
SPMT09T308-F55	M	4	9,52	3,97	11°	0,8	☉	☉	☉	☉	☉	☉	☉	☉					☉	☉		
SPMT120408-F55	M	4	12,7	4,76	11°	0,8	☉	☉	☉	☉	☉	☉	☉	☉					☉	☉		
SPMW060304T-A27	M	4	6,35	3,18	11°	0,4	☉	☉	☉	☉			☉	☉								
SPMW09T308T-A27	M	4	9,52	3,97	11°	0,8	☉	☉	☉	☉			☉	☉								
SPMW120408T-A27	M	4	12,7	4,76	11°	0,8	☉	☉	☉	☉			☉	☉								
SPMW120606T-A27	M	4	12,7	6,35	11°	0,6	☉	☉	☉	☉			☉	☉								
SPMW060304-A57	M	4	6,35	3,18	11°	0,4	☉	☉	☉	☉			☉	☉								
SPMW09T308-A57	M	4	9,52	3,97	11°	0,8	☉	☉	☉	☉			☉	☉								
SPMW120408-A57	M	4	12,7	4,76	11°	0,8	☉	☉	☉	☉			☉	☉								

HC = Coated carbide
 HW = Uncoated carbide
 CN = Silicon nitride Si₃N₄

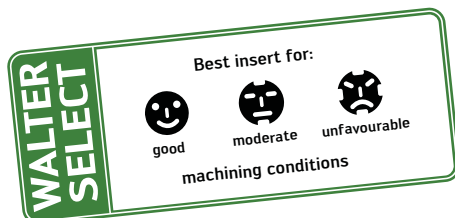



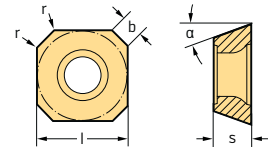











Positive square



Tiger-tec®

Indexable inserts

Designation	Tolerance class	Number of cutting edges	l mm	s mm	α	r mm	b mm	P				M		K				N		S		H
								WC	HC	HC	WC	WC	WC	WC	WC	WC	WC	WC	WC	WC	WC	WC
 SDGT09T3AEN-F57	G	4	9,52	3,97	15°	0,3	1,2	⊕	⊕	⊕	⊕	⊕	⊕	⊕	⊕	⊕	⊕	⊕	⊕	⊕	⊕	
 SDGT09T3AEN-G88	G	4	9,52	3,97	15°	0,3	1,2											⊕	⊕			
 SDHW09T3AEN-A57	H	4	9,52	3,97	15°	0,3	1,2	⊕	⊕	⊕			⊕	⊕	⊕	⊕						
 SDMW09T3AEN-A57	M	4	9,52	3,97	15°	0,5	1,2	⊕	⊕	⊕			⊕	⊕	⊕	⊕						
 SDMT09T3AEN-D57	M	4	9,52	3,97	15°	0,5	1,2	⊕	⊕	⊕	⊕	⊕								⊕	⊕	
 SDMW09T3AETN-A27	M	4	9,52	3,97	15°	0,5	1,2	⊕	⊕	⊕			⊕	⊕	⊕	⊕						
 SDMW09T3AEN-A57	M	4	9,52	3,97	15°	0,5	1,2	⊕	⊕	⊕			⊕	⊕	⊕	⊕						
 SEHT1204AFN	H	4	12,7	4,76	20°	0,8	2,0		⊕	⊕	⊕	⊕	⊕					⊕	⊕	⊕		
 SEHT1204AFN-K88	H	4	12,7	4,76	20°	0,8	1,8													⊕		
 SEHW1204AFN	H	4	12,7	4,76	20°	0,8	2,0	⊕	⊕	⊕			⊕	⊕	⊕	⊕						
 SEHW1504AFN	H	4	15,88	4,76	20°	0,8	2,1	⊕	⊕	⊕			⊕	⊕	⊕	⊕						
 SPGT1204AEN-K88	G	4	12,7	4,76	11°	-	1,5													⊕	⊕	
 SPKT1204AZN	K	4	12,7	4,76	11°	-	1,4	⊕	⊕	⊕	⊕	⊕	⊕	⊕	⊕	⊕					⊕	⊕
 SPKT1504AZN	K	4	15,88	4,76	11°	-	1,7	⊕	⊕	⊕			⊕	⊕	⊕	⊕					⊕	⊕



HC = Coated carbide
HW = Uncoated carbide

Positive square

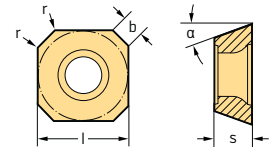
Tiger-tec®



Indexable inserts

Designation	Tolerance class	Number of cutting edges	l mm	s mm	α	r mm	b mm	P				M		K				N		S		H		
								HC	HC	HC	HC	HC	HC	HC	HW	HC	HC	HC						
								WKP25	WKP35	WKP35S	WSP45	WSM35	WSP45	WAK15	WKK25	WKP25	WKP35	WKP35S	WXN15	WK10	WSM35	WSP45	WHH15	
 SPMT1204AEN	M	4	12,7	4,76	11°	0,5	1,4	☉	☉	☉	☉	☉	☉	☉	☉	☉	☉	☉			☉	☉		
 SPMW1204AEN-A57	M	4	12,7	4,76	11°	0,5	1,4	☉	☉	☉				☉	☉	☉	☉							
 SPMW1204AETN-A27	M	4	12,7	4,76	11°	0,5	1,4	☉	☉	☉					☉	☉	☉							





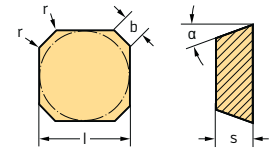

HC = Coated carbide
HW = Uncoated carbide

Positive square

Tiger-tec®



Indexable inserts

Designation	Tolerance class	Number of cutting edges	l mm	s mm	α	r mm	b mm	P				M		K				N		S		H		
								HC	HC	HC	HC	HC	HC	HC	HW	HC	HC	HC						
								WKP25	WKP35	WKP35S	WSP45	WSM35	WSP45	WAK15	WKK25	WKP25	WKP35	WKP35S	WXN15	WK10	WSM35	WSP45	WHH15	
 SEKR1203AFTN	K	4	12,7	3,18	20°	0,425	1,9	☉	☉							☉	☉	☉						
 SEKR1204AFN	K	4	12,7	4,76	20°	0,34	1,9	☉	☉							☉	☉	☉						
 SEM1203AFN	M	4	12,7	3,18	20°	0,5	1,9	☉	☉	☉				☉	☉	☉	☉							
 SEKN1203AFN	K	4	12,7	3,18	20°	0,625	1,9	☉	☉	☉				☉	☉	☉	☉							
 SEKN1504AFN	K	4	15,88	4,76	20°	0,35	2,0	☉	☉	☉				☉	☉	☉	☉							
 SEMR1203AFTN	M	4	12,7	3,18	20°	0,5	1,9	☉	☉								☉	☉						

HC = Coated carbide
HW = Uncoated carbide

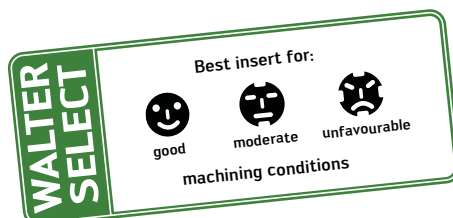

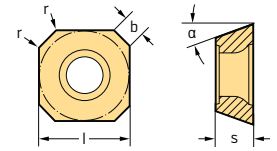

Positive square



Tiger-tec®

Indexable inserts

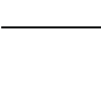
Designation	Tolerance class	Number of cutting edges	l mm	s mm	α	r mm	b mm	P				M		K			N		S		H	
								WKP25	WKP35	WKP35S	WSP45	WSM35	WSP45	WAK15	WKK25	WKP25	WKP35	WKP35S	WXN15	WK10	WSM35	WSP45
 SPGT1204EDR-F55	G	4	12,7	4,76	11°	0,5	1,25	⊕	⊕	⊕	⊗	⊗	⊗	⊗	⊗	⊗	⊗	⊗	⊗	⊗	⊗	
 SPJW1204EDR	J	4	12,7	4,76	11°	-	1,4	⊕	⊕	⊕			⊕	⊕	⊕	⊕						
 SPJW1504EDR	J	4	15,88	4,76	11°	-	1,5	⊕	⊕	⊕			⊕	⊕	⊕	⊕						





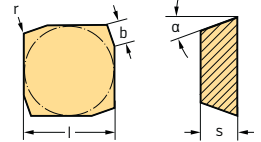



HC = Coated carbide
HW = Uncoated carbide

Positive square



Tiger-tec®

Indexable inserts

Designation	Tolerance class	Number of cutting edges	l mm	s mm	α	r mm	b mm	P				M		K			N		S		H
								WKP25	WKP35	WKP35S	WSP45	WSM35	WSP45	WAK15	WKK25	WKP25	WKP35	WKP35S	WXN15	WK10	WSM35
 SPFN1203EDR	F	4	12,7	3,18	11°	-	1,4	⊗	⊗	⊗			⊕	⊕	⊕	⊕					
 SPFN1204EDN	F	4	12,7	4,76	11°	0,5	1,7	⊕	⊕	⊕			⊕	⊕	⊕	⊕					
 SPFN1204ZPN	F	4	12,7	4,76	11°	0,8	1,7	⊕	⊕	⊕			⊕	⊕	⊕	⊕					
 SPFR1204EDR	F	4	12,7	4,76	11°	0,5	2,0	⊕	⊕				⊕		⊕	⊕					
 SPFR1204ZPN	F	4	12,7	4,76	11°	0,8	1,7	⊕	⊕	⊕			⊕	⊕	⊕	⊕					
 SPFR1204ZPR	F	4	12,7	4,76	11°	0,8	1,7	⊕	⊕	⊕			⊕	⊕	⊕	⊕					
 SPKN1203EDR	K	4	12,7	3,18	11°	-	1,4	⊕	⊕	⊕			⊕	⊕	⊕	⊕					
 SPKN1204EDR	K	4	12,7	4,76	11°	-	1,4	⊕	⊕	⊕			⊕	⊕	⊕	⊕					
 SPKN1504EDR	K	4	15,88	4,76	11°	-	1,5	⊕	⊕	⊕			⊕	⊕	⊕	⊕					
SPMN1203EDR	M	4	12,7	3,18	11°	0,2	1,4	⊗	⊗	⊗			⊕	⊕	⊕	⊕					
SPMN1204EDR	M	4	12,7	4,76	11°	0,2	1,4	⊗	⊗	⊗			⊕	⊕	⊕	⊕					

HC = Coated carbide
HW = Uncoated carbide

Positive square

Tiger-tec®

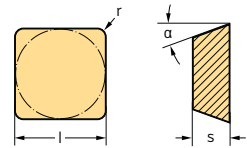

Indexable inserts

Designation	Tolerance class	Number of cutting edges	l mm	s mm	α	r mm	P				M		K				N		S		H
							WC	HC	HC	WC	WC	HC	HC	HC	HW	HC	HC	WC	HC		
SPNR120412	N	4	12,7	4,76	11°	1,2	⊕	⊕	⊗				⊕	⊕	⊗	⊗					



HC = Coated carbide
HW = Uncoated carbide

Positive square

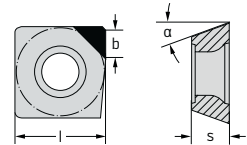

Indexable inserts

Designation	Tolerance class	Number of cutting edges	l mm	s mm	α	b mm	P				M		K				N		S		H	
							WC	HC	HC	WC	WC	HC	HC	HC	HW	DP	HC	HC	WC	HC		
SPHW1204EDR-A88	H	1	12,7	4,76	11°	1,5																
SPHW1204PDR-A88	H	1	12,7	4,76	11°	1,5																

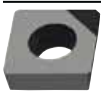



HC = Coated carbide
HW = Uncoated carbide
DP = polycrystalline diamond

Positive triangular

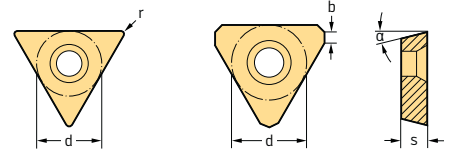
Tiger-tec®



Indexable inserts

Designation	Tolerance class	Number of cutting edges	d mm	s mm	α	b mm	P				M		K				N		S		H			
							HC				HC		HC				HC	HW	HC		HC			
							WKP25	WKP35	WKP35S	WSP45	WSM35	WSP45	WAK15	WKK25	WKP25	WKP35	WKP35S	WXN15	WK10	WSM35	WSP45	WHH15		
 TPAW1604PPN TPAW2204PPN	A	3	9,52	4,76	11°	1,2	☉	☉	☉				☉	☉	☉	☉	☉							
	A	3	12,7	4,76	11°	1,2		☉	☉						☉	☉	☉							
 TPJW1604PPN TPJW2204PPN	J	3	9,52	4,76	11°	1,2	☉	☉	☉				☉	☉	☉	☉	☉							
	J	3	12,7	4,76	11°	1,2		☉	☉						☉	☉	☉							

HC = Coated carbide
HW = Uncoated carbide

Positive form inserts

Tiger-tec®

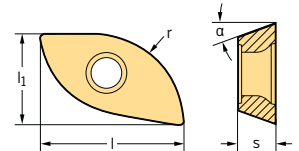

Indexable inserts

Designation	Tolerance class	Number of cutting edges	l ₂ mm	l mm	s mm	α	r mm	P				M		K				N		S		H		
								HC				HC		HC				HC	HW	HC		HC		
								WKP25	WKP35	WKP35S	WSP45	WSM35	WSP45	WAK15	WKK25	WKP25	WKP35	WKP35S	WXN15	WK10	WSM35	WSP45	WHH15	
 XDMT1303080R-F55 XDMT16T3100R-F55 XDMT2004125R-F55 XDMT2405150R-F55 XDMT2506160R-F55 XDMT3207200R-F55 XDMT4009250R-F55	M	2	8,56	13,12	3,0	15°	8	☉	☉	☉	☉	☉	☉			☉	☉	☉	☉					
	M	2	9,0	15,93	3,74	15°	10	☉	☉	☉	☉	☉	☉			☉	☉	☉	☉					
	M	2	11,26	19,94	4,68	15°	12,5	☉	☉	☉	☉	☉	☉			☉	☉	☉	☉					
	M	2	13,52	23,94	5,62	15°	15	☉	☉	☉	☉	☉	☉			☉	☉	☉	☉					
	M	2	14,43	25,54	6,0	15°	16	☉	☉	☉	☉	☉	☉			☉	☉	☉	☉					
	M	2	18,05	31,95	10,0	15°	20	☉	☉	☉	☉	☉	☉			☉	☉	☉	☉					
	M	2	22,57	39,95	12,5	15°	25	☉	☉	☉	☉	☉	☉			☉	☉	☉	☉					

HC = Coated carbide
HW = Uncoated carbide

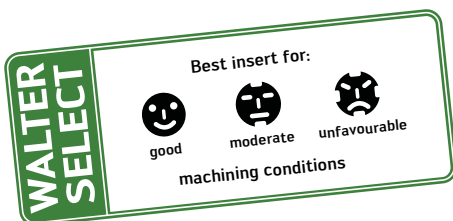

Positive rhombic

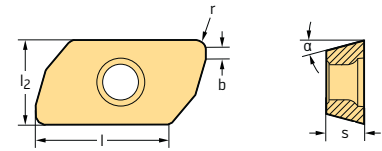

Indexable inserts

Designation	Tolerance class	Number of cutting edges	l ₂ mm	l mm	s mm	α	r mm	b mm	P				M		K				N		S		H	HF
									WKP25	WKP35	WKP35S	WSP45	WSM35	WSP45	WAK15	WKK25	WKP25	WKP35	WKP35S	WXN15	WK10	WSM35	WSP45	WHH15
 ZDGT150404R-K85	G	2	10,5	16,2	4,76	15°	0,4	1,2											☉	☉				☉
ZDGT150408R-K85	G	2	10,5	16,2	4,76	15°	0,8	1,2											☉	☉				☉
ZDGT150412R-K85	G	2	10,5	16,2	4,76	15°	1,2	1,2											☉	☉				☉
ZDGT150416R-K85	G	2	10,5	16,2	4,76	15°	1,6	1,2											☉	☉				☉
ZDGT150420R-K85	G	2	10,5	16,2	4,76	15°	2,0	1,2											☉	☉				☉
ZDGT150425R-K85	G	2	10,5	16,2	4,76	15°	2,5	1,2											☉	☉				☉
ZDGT150430R-K85	G	2	10,5	16,2	4,76	15°	3,0	1,2											☉	☉				☉
ZDGT150440R-K85	G	2	10,5	16,2	4,76	15°	4,0	1,2											☉	☉				☉
ZDGT200508R-K85	G	2	14,0	21,2	5,56	15°	0,8	1,2											☉	☉				☉
ZDGT200512R-K85	G	2	14,0	21,2	5,56	15°	1,2	1,2											☉	☉				☉
ZDGT200516R-K85	G	2	14,0	21,2	5,56	15°	1,6	1,2											☉	☉				☉
ZDGT200520R-K85	G	2	14,0	21,2	5,56	15°	2,0	1,2											☉	☉				☉
ZDGT200530R-K85	G	2	14,0	21,2	5,56	15°	3,0	1,2											☉	☉				☉
ZDGT200540R-K85	G	2	14,0	21,2	5,56	15°	4,0	1,2											☉	☉				☉
ZDGT200550R-K85	G	2	14,0	21,2	5,56	15°	5,0	1,2											☉	☉				☉
ZDGT200560R-K85	G	2	14,0	21,2	5,56	15°	6,0	1,2											☉	☉				☉
ZDGT200564R-K85	G	2	14,0	21,2	5,56	15°	6,4	1,2											☉	☉				☉

HC = Coated carbide

HW = Uncoated carbide

HF = Uncoated fine-grained carbide

Finishing inserts

Tiger-tec®

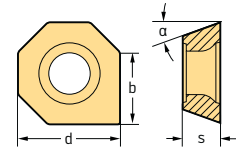

Indexable inserts

	Designation	Tolerance class	Number of cutting edges	d mm	s mm	α	b mm	P				M		K				N		S		H				
								HC				HC		HC				HC	HW	HC		HC	HC			
								WKP25	WKP35	WKP35S	WSP45	WSM35	WSP45	WAK15	WKK25	WKP25	WKP35	WKP35S	WXN15	WK10	WSM35	WSP45	WHH15	WXM15		
	ODHX0504ZZR-A57	H	1	12,7	4,76	15°	7,2	☒	☒	☒				☒			☒	☒						☒	☒	
	ODHX0605ZZR-A57	H	1	15,88	5,56	15°	9,4	☒	☒					☒			☒	☒							☒	☒
	ODHX0605ZZN-A88	H	8	15,88	5,56	15°	6,0							☒											☒	☒
	ODHX0605ZZN-A57	H	8	15,88	5,56	15°	6,0							☒											☒	☒

HC = Coated carbide
HW = Uncoated carbide

WALTER SELECT

Best insert for:

☺
good

☹
moderate

☹
unfavourable



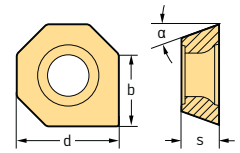

machining conditions

Finishing inserts

Tiger-tec®



Indexable inserts

Designation	Tolerance class	Number of cutting edges	d mm	s mm	α	b mm	P				M		K					N		S		H			
							HC				HC		HC					BH	HC	HW	HC		HC	HC	
							WKP25	WKP35	WKP35S	WSP45	WSM35	WSP45	WAK15	WKK25	WKP25	WKP35	WKP35S	WCB80	WXN15	WK10	WSM35	WSP45	WHH15	WXM15	
 OPHX0504ZZR-A27	H	1	12,7	4,76	11°	7,8												☺							
 OPHX0504ZZN-A88	H	8	12,7	4,76	11°	5,0							☺											☺	☺
 OPHX0504ZZN-A57	H	8	12,7	4,76	11°	5,0							☺											☺	☺
 OPHX0504ZZR-A57	H	1	12,7	4,76	11°	7,8							☺											☺	☺



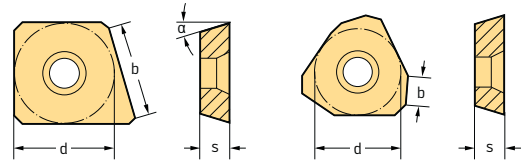

HC = Coated carbide
 HW = Uncoated carbide
 BH = CBN with high CBN content

Finishing inserts

Tiger-tec®



Indexable inserts

Designation	Tolerance class	Number of cutting edge	d mm	s mm	α	b mm	P				M		K					N			S		H				
							HC				HC		HC					HC	HW	DP	HC		HC	HC			
							WKP25	WKP35	WKP35S	WSP45	WSM35	WSP45	WAK15	WKK25	WKP25	WKP35	WKP35S	WXN15	WK10	WCD10	WSM35	WSP45	WHH15	WXM15			
 P2901-1R	H	1	12,7	4,76	11°	11							☺						☺					☺	☺		
 P2903-2R	A	3	9,52	4,76	11°	3,5							☺						☺					☺	☺		
 P2905-1	F	4	12,7	4,76	11°	10							☺						☺					☺	☺		
 SPHX1204PDR-A88	H	1	12,7	4,76	11°	3,5														☺							

HC = Coated carbide
 HW = Uncoated carbide
 DP = polycrystalline diamond

WALTER SELECT

Best insert for:

 good



 moderate

 unfavourable

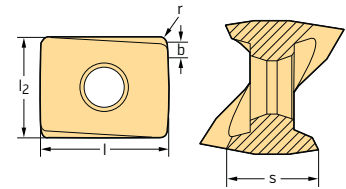

machining conditions

Negative rhombic

Tiger-tec®



Indexable inserts

Designation	Tolerance class	Number of cutting edges	l ₂ mm	l mm	s mm	r mm	b mm	P				M		K				N		S		H	
								HC				HC		HC				HC	HW	HC		HC	
								WKP25	WKP35	WKP35S	WSP45	WSM35	WSP45	WAK15	WKK25	WKP25	WKP35	WKP35S	WXN15	WK10	WSM35	WSP45	WHH15
 LNGX130708R-L55	G	4	11	13,6	7,94	0,8	1,2	☺	☺	☺	☺	☺	☺	☺	☺	☺	☺	☺			☺	☺	
LNGX130712R-L55	G	4	11	13,6	7,94	1,2	1,0	☺	☺	☺	☺	☺	☺			☺	☺	☺			☺	☺	
LNGX130716R-L55	G	4	11	13,6	7,94	1,6	0,9	☺	☺	☺	☺	☺	☺			☺	☺	☺			☺	☺	
LNGX130720R-L55	G	4	11	13,6	7,94	2,0	0,7	☺	☺	☺	☺	☺	☺			☺	☺	☺			☺	☺	
LNGX130725R-L55	G	4	11	13,6	7,94	2,5	0,6	☺	☺	☺	☺	☺	☺			☺	☺	☺			☺	☺	
LNGX130730R-L55	G	4	11	13,6	7,94	3,0	0,7	☺	☺	☺	☺	☺	☺			☺	☺	☺			☺	☺	
 LNGX130708R-L88	G	4	11	13,6	7,94	0,8	1,2												☺	☺			
LNGX130712R-L88	G	4	11	13,6	7,94	1,2	1,0												☺	☺			
LNGX130716R-L88	G	4	11	13,6	7,94	1,6	0,9												☺	☺			
LNGX130720R-L88	G	4	11	13,6	7,94	2,0	0,7												☺	☺			
LNGX130725R-L88	G	4	11	13,6	7,94	2,5	0,6												☺	☺			
LNGX130730R-L88	G	4	11	13,6	7,94	3,0	0,7												☺	☺			



HC = Coated carbide
HW = Uncoated carbide

Wendelnovex® inserts

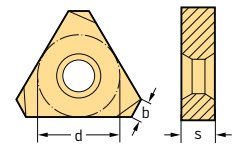
Tiger-tec®



Indexable inserts

Designation	Tolerance class	Number of cutting edges	d mm	s mm	b mm	P				M		K				N		S		H		
						HC				HC		HC				HC	HW	HC		HC		
						WKP25	WKP35	WKP35S	WSP45	WSM35	WSP45	WAK15	WKK25	WKP25	WKP35	WKP35S	WXN15	WK10	WSM35	WSP45	WHH15	
 P2352-1R	A	6	15	4,5	1,1	☺	☺	☺				☺		☺	☺	☺						
P2352-2R	A	6	18	4,5	1,1		☺	☺							☺	☺						
 P23522-1R	A	6	15	4,5	1,1		☺	☺				☺			☺	☺						
 P2372-1R	A	6	15	4,5	1,1		☺	☺							☺	☺						

HC = Coated carbide
HW = Uncoated carbide

Positive triangular

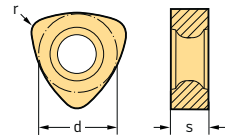

Tiger-tec®

Indexable inserts

Designation	Tolerance class	Number of cutting edges	d mm	s mm	r mm	P				M		K			N		S		H
						HC				HC		HC			HC	HW	HC		HC
						WKP25	WKP35	WKP35S	WSP45	WSM35	WSP45	WAK15	WKK25	WKP25	WKP35	WKP35S	WXN15	WK10	WSM35
P23696-1.0	M	6	9,52	5,0	1,2	☺	☺	☺	☺	☺	☺								
P23696-2.0	M	6	13,5	7,0	1,6	☺	☺	☺	☺	☺									

HC = Coated carbide
HW = Uncoated carbide

Negative square

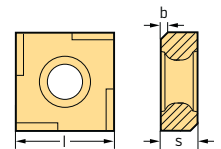

Tiger-tec®

Indexable inserts

Designation	Tolerance class	Number of cutting edges	l mm	s mm	b mm	P				M		K			N		S		H
						HC				HC		HC			HC	HW	HC		HC
						WKP25	WKP35	WKP35S	WSP45	WSM35	WSP45	WAK15	WKK25	WKP25	WKP35	WKP35S	WXN15	WK10	WSM35
SNHQ1205ZZR-A57T	H	8	12	5,0	0,8	☺	☺	☺				☺							

HC = Coated carbide
HW = Uncoated carbide

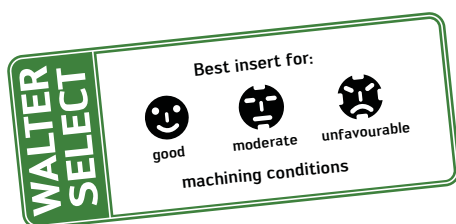

Negative square

Tiger-tec®

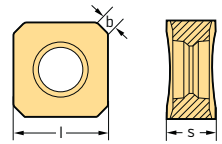

Indexable inserts

Designation	Tolerance class	Number of cutting edges	l mm	s mm	b mm	P				M			K				N		S		H
						HC				HC			HC				HC	HW	HC		HC
						WKP25	WKP35	WKP35S	WSP45	WSM35	WSP45	WAK15	WKK25	WKP25	WKP35	WKP35S	WXN15	WK10	WSM35	WSP45	WHH15
	SNGX1205ANN-D27	G	8	12,7	6,4	1,5	⊕	⊕	⊕				⊕	⊕	⊕	⊕					
	SNGX1205ANN-F27	G	8	12,7	6,4	1,5	⊕	⊕	⊕				⊕	⊕	⊕	⊕					
	SNGX1205ANN-F57	G	8	12,7	6,4	1,5	⊕	⊕	⊕	⊕	⊕		⊕	⊕	⊕	⊕		⊕	⊕		
	SNGX1205ANN-F67	G	8	12,7	6,4	1,5	⊕	⊕	⊕	⊕	⊕	⊕	⊕	⊕	⊕	⊕		⊕	⊕		
	SNGX1606ANN-D27	G	8	16,0	7,8	1,8	⊕	⊕	⊕				⊕	⊕	⊕	⊕					
	SNGX1606ANN-F27	G	8	16,0	7,8	1,8	⊕	⊕	⊕				⊕	⊕	⊕	⊕					
	SNGX1606ANN-F57	G	8	16,0	7,8	1,8	⊕	⊕	⊕	⊕	⊕		⊕	⊕	⊕	⊕		⊕	⊕		
	SNGX1606ANN-F67	G	8	16,0	7,8	1,8	⊕	⊕	⊕	⊕	⊕	⊕	⊕	⊕	⊕	⊕		⊕	⊕		
	SNMX1205ANN-F27	M	8	12,7	6,4	1,5	⊕	⊕	⊕				⊕	⊕	⊕	⊕					
	SNMX1205ANN-F57	M	8	12,7	6,4	1,5	⊕	⊕	⊕				⊕	⊕	⊕	⊕					
	SNMX1205ANN-F67	M	8	12,7	6,4	1,5	⊕	⊕	⊕				⊕	⊕	⊕	⊕					

HC = Coated carbide
HW = Uncoated carbide

Negative square

Tiger-tec®

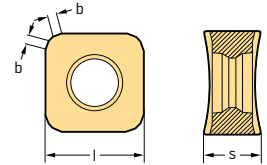

Indexable inserts

Designation	Tolerance class	Number of cutting edges	l mm	s mm	b mm	P				M			K				N		S		H
						HC				HC			HC				HC	HW	HC		HC
						WKP25	WKP35	WKP35S	WSP45	WSM35	WSP45	WAK15	WKK25	WKP25	WKP35	WKP35S	WXN15	WK10	WSM35	WSP45	WHH15
	SNGX1205ENN-F27	G	8	12,7	6,4	1,2	⊕	⊕	⊕				⊕	⊕	⊕	⊕					
	SNGX1205ENN-F57	G	8	12,7	6,4	1,2	⊕	⊕	⊕	⊕	⊕		⊕	⊕	⊕	⊕		⊕	⊕		
	SNGX1205ENN-F67	G	8	12,7	6,4	1,2	⊕	⊕	⊕	⊕	⊕	⊕	⊕	⊕	⊕	⊕		⊕	⊕		

HC = Coated carbide
HW = Uncoated carbide

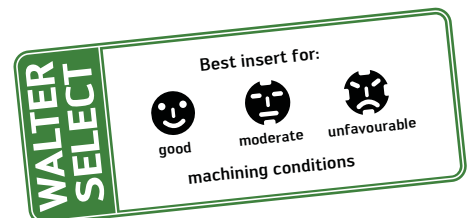

Negative square

Tiger-tec®

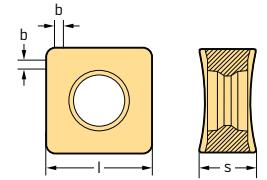

Indexable inserts

Designation	Tolerance class	Number of cutting edges	l mm	s mm	b mm	P				M		K			N		S		H
						HC				HC		HC			HC	HW	HC		HC
						WKP25	WKP35	WKP35S	WSP45	WSM35	WSP45	WAK15	WKK25	WKP25	WKP35	WKP35S	WXN15	WK10	WSM35
 SNGX1205ZNN-F27	G	8	12,7	6,4	1,2	☉	☉	☉	☉	☉	☉			☉	☉	☉	☉		
SNGX1205ZNN-F57	G	8	12,7	6,4	1,2	☉	☉	☉	☉	☉	☉			☉	☉		☉	☉	
SNGX1205ZNN-F67	G	8	12,7	6,4	1,2	☉	☉	☉	☉	☉	☉			☉	☉		☉	☉	



HC = Coated carbide
HW = Uncoated carbide

Negative square

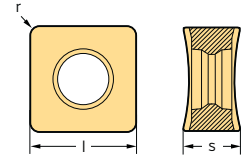
Tiger-tec®



Indexable inserts

Designation	Tolerance class	Number of cutting edges	l mm	s mm	r mm	P				M		K			N		S		H
						HC				HC		HC			HC	HW	HC		HC
						WKP25	WKP35	WKP35S	WSP45	WSM35	WSP45	WAK15	WKK25	WKP25	WKP35	WKP35S	WXN15	WK10	WSM35
 SNGX120512-F57	G	8	12,7	6,4	1,2	☉	☉	☉	☉	☉	☉			☉	☉		☉	☉	
 SNMX120512-D27	M	8	12,7	6,4	1,2	☉	☉	☉	☉			☉	☉	☉	☉				
SNMX120512-F27	M	8	12,7	6,4	1,2	☉	☉	☉	☉			☉	☉	☉	☉				
SNMX120512-F57	M	8	12,7	6,4	1,2	☉	☉	☉	☉	☉	☉			☉	☉		☉	☉	
SNMX120512-F67	M	8	12,7	6,4	1,2	☉	☉	☉	☉	☉	☉			☉	☉		☉	☉	
SNMX120520-D27	M	8	12,7	6,4	2,0	☉	☉	☉	☉			☉	☉	☉	☉				
SNMX120520-F57	M	8	12,7	6,4	2,0	☉	☉	☉	☉	☉	☉			☉	☉		☉	☉	
SNMX160620-D27	M	8	16,0	7,8	2,0	☉	☉	☉	☉			☉	☉	☉	☉				
SNMX160620-F27	M	8	16,0	7,8	2,0	☉	☉	☉	☉			☉	☉	☉	☉				
SNMX160620-F57	M	8	16,0	7,8	2,0	☉	☉	☉	☉	☉	☉			☉	☉		☉	☉	
SNMX160620-F67	M	8	16,0	7,8	2,0	☉	☉	☉	☉	☉	☉			☉	☉		☉	☉	
SNMX160640-D27	M	8	16,0	7,8	4,0	☉	☉	☉	☉			☉	☉	☉	☉				
SNMX160640-F27	M	8	16,0	7,8	4,0	☉	☉	☉	☉			☉	☉	☉	☉				
SNMX160640-F57	M	8	16,0	7,8	4,0	☉	☉	☉	☉	☉	☉			☉	☉		☉	☉	
SNMX160640-F67	M	8	16,0	7,8	4,0	☉	☉	☉	☉	☉	☉			☉	☉		☉	☉	

HC = Coated carbide
HW = Uncoated carbide

Negative triangular

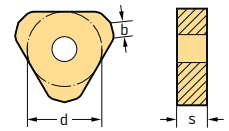

Tiger-tec®

Indexable inserts

Designation	Tolerance class	Number of cutting edges	d mm	s mm	b mm	P HC				M HC		K HC				N HC HW		S HC		H HC
						WKP25	WKP35	WKP35S	WSP45	WSM35	WSP45	WAK15	WKK25	WKP25	WKP35	WKP35S	WXN15	WK10	WSM35	WSP45
TNEF1204AN-D57	E	6	12,7	4,76	1,8	☉	☉	☉				☉	☉	☉	☉					



HC = Coated carbide
HW = Uncoated carbide

Negative heptagonal

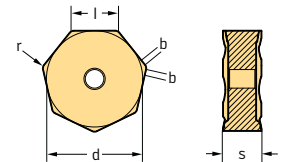

Tiger-tec®

Indexable inserts

Designation	Tolerance class	Number of cutting edges	l mm	d mm	s mm	r mm	b mm	P HC				M HC		K HC				N HC HW		S HC		H HC
								WKP25	WKP35	WKP35S	WSP45	WSM35	WSP45	WAK15	WKK25	WKP25	WKP35	WKP35S	WXN15	WK10	WSM35	WSP45
XNHF070508-D27	H	14	7	14,5	5,8	0,8	-	☉	☉	☉				☉	☉	☉	☉					
XNHF070508-D57	H	14	7	14,5	5,8	0,8	-	☉	☉	☉				☉	☉	☉	☉					
XNHF070508-D67	H	14	7	14,5	5,8	0,8	-	☉	☉	☉			☉	☉	☉	☉	☉					
XNHF0705ANN-D27	H	14	7	14,5	5,8	0,8	1,1	☉	☉	☉				☉	☉	☉	☉					
XNHF0705ANN-D57	H	14	7	14,5	5,8	0,8	1,1	☉	☉	☉				☉	☉	☉	☉					
XNHF0705ANN-D67	H	14	7	14,5	5,8	0,8	1,1	☉	☉	☉			☉	☉	☉	☉	☉					
XNHF090612-D27	H	14	9	19,05	6,35	1,2	-	☉	☉	☉				☉	☉	☉	☉					
XNHF090612-D57	H	14	9	19,05	6,35	1,2	-	☉	☉	☉				☉	☉	☉	☉					
XNHF090612-D67	H	14	9	19,05	6,35	1,2	-	☉	☉	☉			☉	☉	☉	☉	☉					
XNHF0906ANN-D27	H	14	9	19,05	6,35	0,8	1,4	☉	☉	☉				☉	☉	☉	☉					
XNHF0906ANN-D57	H	14	9	19,05	6,35	0,8	1,4	☉	☉	☉				☉	☉	☉	☉					
XNHF0906ANN-D67	H	14	9	19,05	6,35	0,8	1,4	☉	☉	☉			☉	☉	☉	☉	☉					

HC = Coated carbide
HW = Uncoated carbide

Finishing inserts

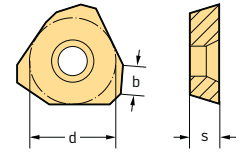

Indexable inserts

Designation	Tolerance class	Number of cutting edges	d mm	s mm	b mm	P				M		K			N		S		H				
						HC				HC		HC			HC	HW	HC		HC				
						WKP25	WKP35	WKP35S	WSP45	WSM35	WSP45	WAK15	WKK25	WKP25	WKP35	WKP35S	WXN15	WK10	WSM35	WSP45	WHH15		
 P2553-1R	A	3	15	4,5	4																		
P2553-3R	A	3	18	4,5	7,5																		

HC = Coated carbide
HW = Uncoated carbide

Finishing inserts

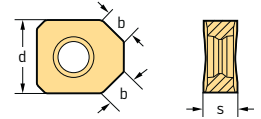

Tiger-tec®

Indexable inserts

Designation	Tolerance class	Number of cutting edges	d mm	s mm	b mm	P				M		K			N		S		H				
						HC				HC		HC			HC	HW	HC		HC				
						WKP25	WKP35	WKP35S	WSP45	WSM35	WSP45	WAK15	WKK25	WKP25	WKP35	WKP35S	WXN15	WK10	WSM35	WSP45	WHH15	WXMI15	
 XNGX1205ANN-F67	G	2	12,7	6,09	4,7																		

HC = Coated carbide
HW = Uncoated carbide

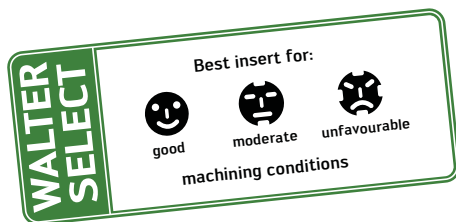

Finishing inserts

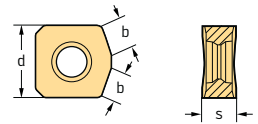

Tiger-tec®

Indexable inserts

Designation	Tolerance class	Number of cutting edges	d mm	s mm	b mm	P				M		K				N		S		H	
						WKP25	WKP35	WKP35S	WSP45	WSM35	WSP45	WAK15	WKK25	WKP25	WKP35	WKP35S	WXN15	WK10	WSM35	WSP45	WHH15
XNGX1205ENN-F67	G	2	12,7	4,76	4,5																

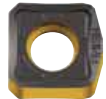
 HC = Coated carbide
 HW = Uncoated carbide

Finishing inserts

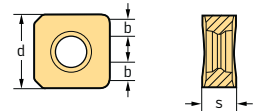

Tiger-tec®

Indexable inserts

Designation	Tolerance class	Number of cutting edges	d mm	s mm	b mm	P				M		K				N		S		H	
						WKP25	WKP35	WKP35S	WSP45	WSM35	WSP45	WAK15	WKK25	WKP25	WKP35	WKP35S	WXN15	WK10	WSM35	WSP45	WHH15
XNGX1205ZNN-F67	G	2	12,7	6,64	4,0																

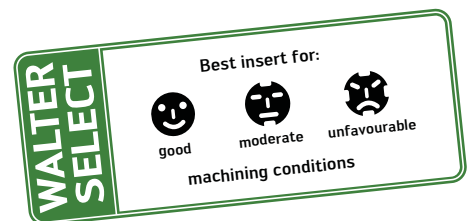
 HC = Coated carbide
 HW = Uncoated carbide

Tangential rhombic

Tiger-tec®

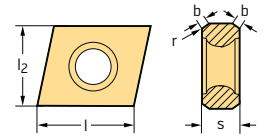

Indexable inserts

Designation	Tolerance class	Number of cutting edges	l ₂ mm	l mm	s mm	r mm	b mm	P				M		K			N		S		H	
								WKP25	WKP35	WKP35S	WSP45	WSM35	WSP45	WAK15	WKK25	WKP25	WKP35	WKP35S	WXN15	WK10	WSM35	WSP45
	CNHQ0805PPN-A57T	H	2	9	8	5.0	0.8	1.2	⊕	⊕	⊕	⊕			⊕	⊕	⊕	⊕				
	CNHQ1206PPN-A57T	H	2	13	12	6.5	0.8	1.5	⊕	⊕	⊕	⊕			⊕	⊕	⊕	⊕				
	CNHQ1608PPN-A57T	H	2	15	16	8.0	1.2	1.8	⊕	⊕	⊕	⊕			⊕	⊕	⊕	⊕				
	CNHU0805PPN-D57T	H	2	9	8	5.0	0.8	1.2	⊕	⊕	⊕	⊕	⊕			⊕	⊕	⊕		⊕	⊕	
	CNHU1206PPN-D57T	H	2	13	12	6.5	0.8	1.5	⊕	⊕	⊕	⊕	⊕			⊕	⊕	⊕		⊕	⊕	
	CNHU1608PPN-D57T	H	2	15	16	8.0	1.2	1.8	⊕	⊕	⊕	⊕	⊕			⊕	⊕	⊕		⊕	⊕	
	CNMQ080508T-A27T	M	2	9	8	5.0	0.8	-		⊕	⊕	⊕				⊕	⊕	⊕				
	CNMQ120608T-A27T	M	2	13	12	6.5	0.8	-		⊕	⊕	⊕				⊕	⊕	⊕				
	CNMQ160812T-A27T	M	2	15	16	8.0	1.2	-		⊕	⊕	⊕				⊕	⊕	⊕				
	CNMQ080508-A57T	M	2	9	8	5.0	0.8	-	⊕	⊕	⊕	⊕			⊕	⊕	⊕	⊕				
	CNMQ120608-A57T	M	2	13	12	6.5	0.8	-	⊕	⊕	⊕	⊕			⊕	⊕	⊕	⊕				
	CNMQ160812-A57T	M	2	15	16	8.0	1.2	-	⊕	⊕	⊕	⊕			⊕	⊕	⊕	⊕				
	CNMQ080508-D57T	M	2	9	8	5.0	0.8	-	⊕	⊕	⊕	⊕	⊕			⊕	⊕	⊕		⊕	⊕	
	CNMQ120608-D57T	M	2	13	12	6.5	0.8	-	⊕	⊕	⊕	⊕	⊕			⊕	⊕	⊕		⊕	⊕	
	CNMQ160812-D57T	M	2	15	16	8.0	1.2	-	⊕	⊕	⊕	⊕	⊕			⊕	⊕	⊕		⊕	⊕	

Note:
l₂ = Cutting width

HC = Coated carbide
HW = Uncoated carbide

Tangential rhombic

Tiger-tec®

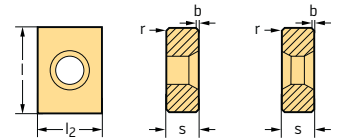

Indexable inserts

Designation	Tolerance class	Number of cutting edges	l ₂ mm	l mm	s mm	r mm	b mm	P				M		K			N		S		H	
								WKP25	WKP35	WKP35S	WSP45	WSM35	WSP45	WAK15	WKK25	WKP25	WKP35	WKP35S	WXN15	WK10	WSM35	WSP45
	LNKU2010DPTR-F27T	K	4	15	20	10.5	0.6	1.2	⊕						⊕							
	LNKU3010DPTR-F27T	K	4	15	30	10.5	0.6	1.2	⊕						⊕							
	LNKU2010DPR-F57T	K	4	15	20	10.5	0.6	1.2	⊕	⊕	⊕				⊕	⊕	⊕					
	LNKU3010DPR-F57T	K	4	15	30	10.5	0.6	1.2	⊕	⊕	⊕				⊕	⊕	⊕					

HC = Coated carbide
HW = Uncoated carbide

Tangential rhombic

Tiger-tec®

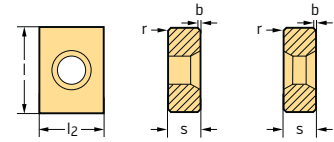

Indexable inserts

Designation	Tolerance class	Number of cutting edges	l ₂ mm	l mm	s mm	r mm	P				M		K				N		S		H
							WKP25	WKP35	WKP35S	WSP45	WSM35	WSP45	WAK15	WKK25	WKP25	WKP35	WKP35S	WCN15	WK10	WSM35	WSP45
LNMU150812T-F27T LNMU201012T-F27T	M	4	14	15	8	1.2	⊗	⊗	⊗						⊗	⊗	⊗				
	M	4	16	20	10	1.2	⊗	⊗	⊗						⊗	⊗	⊗				
LNMU150812-F57T LNMU201012-F57T	M	4	14	15	8	1.2	⊕	⊕	⊕				⊕		⊕	⊕	⊕				
	M	4	16	20	10	1.2	⊕	⊕	⊕				⊕		⊕	⊕	⊕				

 HC = Coated carbide
 HW = Uncoated carbide

Tangential rhombic

Tiger-tec®

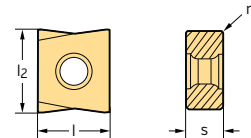

Indexable inserts

Designation	Tolerance class	Number of cutting edges	l ₂ mm	l mm	s mm	r mm	P				M		K				N		S		H
							WKP25	WKP35	WKP35S	WSP45	WSM35	WSP45	WAK15	WKK25	WKP25	WKP35	WKP35S	WCN15	WK10	WSM35	WSP45
LNHU080304-B57T LNHU080404-B57T LNHU100508-B57T LNHU120608-B57T LNHU160812-B57T	H	4	9,0	8,0	3,5	0,4	⊗	⊗	⊗				⊗	⊗	⊗	⊗					
	H	4	9,4	8,0	4,5	0,4	⊗	⊗	⊗				⊗	⊗	⊗	⊗					
	H	4	12,3	10	5,5	0,8	⊗	⊗	⊗				⊗	⊗	⊗	⊗					
	H	4	13,9	12,0	6,5	0,8	⊗	⊗	⊗				⊗	⊗	⊗	⊗					
	H	4	16,0	16,9	8,0	1,2	⊗	⊗	⊗				⊗	⊗	⊗	⊗					
LNHU080304-F57T LNHU080404-F57T LNHU100508-F57T LNHU120608-F57T LNHU160812-F57T	H	4	9,0	8,0	3,5	0,4	⊕	⊕	⊕	⊕	⊕	⊕	⊕	⊕	⊕	⊕			⊕	⊕	
	H	4	9,4	8,0	4,5	0,4	⊕	⊕	⊕	⊕	⊕	⊕	⊕	⊕	⊕	⊕			⊕	⊕	
	H	4	12,3	10,0	5,5	0,8	⊕	⊕	⊕	⊕	⊕	⊕	⊕	⊕	⊕	⊕			⊕	⊕	
	H	4	13,9	12,0	6,5	0,8	⊕	⊕	⊕	⊕	⊕	⊕	⊕	⊕	⊕	⊕			⊕	⊕	
	H	4	16,0	16,9	8,0	1,2	⊕	⊕	⊕	⊕	⊕	⊕	⊕	⊕	⊕	⊕			⊕	⊕	
LNMU080304-B57T LNMU080404-B57T LNMU100508-B57T LNMU120608-B57T LNMU160812-B57T	M	4	8,0	9,0	3,5	0,4	⊗	⊗	⊗				⊗	⊗	⊗	⊗					
	M	4	9,4	8,0	4,5	0,4	⊗	⊗	⊗				⊗	⊗	⊗	⊗					
	M	4	12,3	10,0	5,5	0,8	⊗	⊗	⊗				⊗	⊗	⊗	⊗					
	M	4	13,9	12,0	6,5	0,8	⊗	⊗	⊗				⊗	⊗	⊗	⊗					
	M	4	16,0	16,9	8,0	1,2	⊗	⊗	⊗				⊗	⊗	⊗	⊗					
LNMU080304-F57T LNMU080404-F57T LNMU100508-F57T LNMU120608-F57T LNMU160812-F57T	M	4	8,0	9,0	3,5	0,4	⊕	⊕	⊕	⊕	⊕	⊕	⊕	⊕	⊕	⊕			⊕	⊕	
	M	4	9,4	8,0	4,5	0,4	⊕	⊕	⊕	⊕	⊕	⊕	⊕	⊕	⊕	⊕			⊕	⊕	
	M	4	12,3	10,0	5,5	0,8	⊕	⊕	⊕	⊕	⊕	⊕	⊕	⊕	⊕	⊕			⊕	⊕	
	M	4	13,9	12,0	6,5	0,8	⊕	⊕	⊕	⊕	⊕	⊕	⊕	⊕	⊕	⊕			⊕	⊕	
	M	4	16,0	16,9	8,0	1,2	⊕	⊕	⊕	⊕	⊕	⊕	⊕	⊕	⊕	⊕			⊕	⊕	



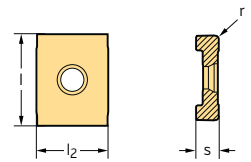

 HC = Coated carbide
 HW = Uncoated carbide

Tangential rhombic

Tiger-tec®



Indexable inserts







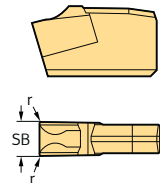





Designation	Tolerance class	Number of cutting edges	l ₂ mm	l mm	s mm	r mm	P				M		K				N		S		H			
							HC				HC		HC				HC	HW	HC		HC			
							WKP25	WKP35	WKP35S	WSP45	WSM35	WSP45	WAK15	WKK25	WKP25	WKP35	WKP35S	WXN15	WK10	WSM35	WSP45	WHH15		
 LNHX070204-D57T	H	4	7	9	2,4	0,4	☉	☉	☉				☉	☉	☉	☉	☉							
 LNHX070204-F57T	H	4	7	9	2,4	0,4	☉	☉	☉	☉	☉	☉			☉	☉	☉				☉	☉		
 LNMX070204-D57T	M	4	7	9	2,4	0,4	☉	☉	☉				☉	☉	☉	☉	☉							
 LNMX070204-F57T	M	4	7	9	2,4	0,4	☉	☉	☉	☉	☉	☉			☉	☉	☉				☉	☉		

HC = Coated carbide
HW = Uncoated carbide

Indexable inserts



Indexable inserts

Designation	Number of cutting edges	SB mm	r mm	P				M		K				N		H	HF					
				HC				HC		HC				HW	HC	HC	WF					
				WKP25	WKP35	WKP35S	WTP35	WXP35	WSP45	WSM35	WSP45	WAK15	WAK25	WKP25	WKP35	WKP35S	WK10	WXN15	WHH15	WMG30		
 NSM3.90016EC-GDW	1	1,6	0,15																		☉	
 NSM3.90022EC-GDW	1	2,2	0,2																		☉	
 NSM3.90030EC-GDW	1	3,0	0,2																		☉	
 NSM3.90040EC-GDW	1	4,0	0,2																		☉	
 NSM3.90016SN-GBW	1	1,6	0,15				☉	☉				☉										
 NSM3.90022SN-GBW	1	2,2	0,2				☉	☉				☉										
 NSM3.90030SN-GBW	1	3,0	0,2				☉	☉				☉										
 NSM3.90040SN-GBW	1	4,0	0,2				☉	☉				☉										
 NSM3.90016SN-GDW	1	1,6	0,15				☉	☉				☉										
 NSM3.90022SN-GDW	1	2,2	0,2				☉	☉				☉										
 NSM3.90030SN-GDW	1	3,0	0,2				☉	☉				☉										
 NSM3.90040SN-GDW	1	4,0	0,2				☉	☉				☉										

HC = Coated carbide
HW = Uncoated carbide
HF = Uncoated fine-grained carbide

Positive rhombic

Tiger-tec®

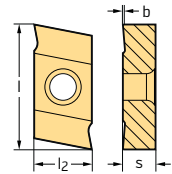

Indexable inserts

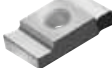
Designation	Tolerance class	Number of cutting edges	l ₂ mm	l mm	s mm	b mm	P				M		K			N		S		H
							HC				HC		HC			HC	HW	HC		HC
							WKP25	WKP35	WKP35S	WSP45	WSM35	WSP45	WAK15	WKK25	WKP25	WKP35	WKP35S	WXN15	WK10	WSM35
 P20200-1.1	H	2	5,5	9,0	2,35	0,1	☉	☉	☉				☉	☉	☉					
P20200-1.2	H	2	5,5	9,0	2,35	0,15	☉	☉	☉				☉	☉	☉					
P20200-1.3	H	2	5,5	9,0	2,35	0,15	☉	☉	☉				☉	☉	☉					
P20200-1.4	H	2	5,5	9,0	2,35	0,15	☉	☉	☉				☉	☉	☉					
P20200-1.5	H	2	5,5	9,0	2,35	0,15	☉	☉	☉				☉	☉	☉					
P20200-2.1	H	2	7,0	12,0	3,4	0,15	☉	☉	☉				☉	☉	☉					
P20200-2.2	H	2	7,0	12,0	3,4	0,15	☉	☉	☉				☉	☉	☉					
P20200-2.3	H	2	7,0	12,0	3,4	0,15	☉	☉	☉				☉	☉	☉					
P20200-3.1	H	2	9,52	18,5	5,4	0,15	☉	☉	☉				☉	☉	☉					
P20200-3.2	H	2	9,52	18,5	5,4	0,15	☉	☉	☉				☉	☉	☉					
P20200-3.3	H	2	9,52	18,5	5,4	0,15	☉	☉	☉				☉	☉	☉					

For the tolerance of the assembled tool, see page F 236.

 HC = Coated carbide
 HW = Uncoated carbide

Positive rhombic

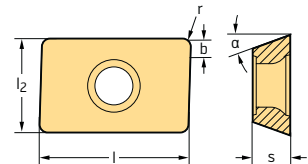

Indexable inserts

Designation	Tolerance class	Number of cutting edges	l ₂ mm	l mm	s mm	b mm	P				M		K			N		S		H
							HC				HC		HC			HC	HW	HC		HC
							WKP25	WKP35	WKP35S	WSP45	WSM35	WSP45	WAK15	WKK25	WKP25	WKP35	WKP35S	WXN15	WK10	WSM35
 P2792-1	H	2	9,52	9,52	4,76	0,3							☉							

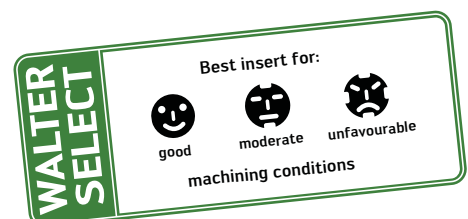
 HC = Coated carbide
 HW = Uncoated carbide

Tangential rhombic

Tiger-tec®

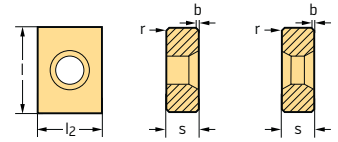

Indexable inserts

Designation	Tolerance class	Number of cutting edges	l ₂ mm	l mm	s mm	b mm	P				M		K				N		S		H
							WKP25	WKP35	WKP35S	WSP45	WSM35	WSP45	WAK15	WKK25	WKP25	WKP35	WKP35S	WXN15	WK10	WSM35	WSP45
 P4406-1 P4406-2 P4406-3 P4406-4 P4406-5	H	4	9,52	12,7	3,5	0,5	☒	☒	☒			☒			☒	☒					
	H	4	9,52	12,7	4,0	0,5	☒	☒	☒			☒			☒	☒					
	H	4	9,52	12,7	4,76	0,4		☒	☒			☒			☒	☒					
	H	4	9,52	12,7	5,5	0,4		☒	☒			☒			☒	☒					
	H	4	9,52	12,7	6,35	0,4		☒	☒			☒			☒	☒					
 P44462-1 P44462-2 P44462-3 P44462-4 P44462-5	H	4	9,52	12,7	3,5	0,5	☒	☒	☒					☒	☒						
	H	4	9,52	12,7	4,0	0,5	☒	☒	☒					☒	☒						
	H	4	9,52	12,7	4,76	0,4		☒	☒					☒	☒						
	H	4	9,52	12,7	5,5	0,4		☒	☒					☒	☒						
	H	4	9,52	12,7	6,35	0,4		☒	☒					☒	☒						

HC = Coated carbide
HW = Uncoated carbide

Tangential rhombic

Tiger-tec®

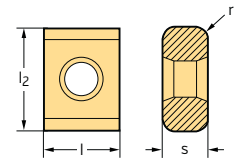

Indexable inserts

Designation	Tolerance class	Number of cutting edges	l ₂ mm	l mm	s mm	r mm	P				M		K				N		S		H
							WKP25	WKP35	WKP35S	WSP45	WSM35	WSP45	WAK15	WKK25	WKP25	WKP35	WKP35S	WXN15	WK10	WSM35	WSP45
 P44280-1R08-D57 P44280-1R10-D57 P44280-1R125-D57 P44280-1R15-D57 P44280-1R20-D57 P44280-2R25-D57 P44280-2R30-D57 P44280-2R40-D57	H	8	12,7	9,52	5,5	0,8	☒				☒			☒							
	H	8	12,7	9,52	5,5	1,0	☒				☒			☒							
	H	8	12,7	9,52	5,5	1,25	☒				☒			☒							
	H	8	12,7	9,52	5,5	1,5	☒				☒			☒							
	H	8	12,7	9,52	5,5	2,0	☒				☒			☒							
	H	8	12,7	9,52	6,35	2,5	☒				☒			☒							
	H	8	12,7	9,52	6,35	3,0	☒				☒			☒							
	H	4	12,7	9,52	6,35	4,0	☒				☒			☒							
 P44290-1R08-D57 P44290-1R10-D57 P44290-1R125-D57 P44290-1R15-D57 P44290-1R20-D57 P44290-2R25-D57 P44290-2R30-D57 P44290-2R40-D57	M	8	12,7	9,52	5,5	0,8	☒				☒			☒							
	M	8	12,7	9,52	5,5	1,0	☒				☒			☒							
	M	8	12,7	9,52	5,5	1,25	☒				☒			☒							
	M	8	12,7	9,52	5,5	1,5	☒				☒			☒							
	M	8	12,7	9,52	5,5	2,0	☒				☒			☒							
	M	8	12,7	9,52	6,35	2,5	☒				☒			☒							
	M	8	12,7	9,52	6,35	3,0	☒				☒			☒							
	M	4	12,7	9,52	6,35	4,0	☒				☒			☒							

HC = Coated carbide
HW = Uncoated carbide

Finishing inserts

Tiger-tec®

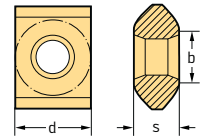

Indexable inserts

Designation	Tolerance class	Number of cutting edges	d mm	s mm	b mm	P				M		K				N		S		H		HC	
						WC	HC	WC	HC	WC	HC	WC	HC	WC	HW	WC	HC	WC	HC	WC	HC		
P45420-G67	G	4	9,52	4,76	7,0	WKP25	WKP35	WKP35S	WSP45	WSM35	WSP45	WAK15	WKK25	WKP25	WKP35	WKP35S	WXN15	WK10	WSM35	WSP45	WHH15	WXM15	
												☺										☺	☺



HC = Coated carbide
HW = Uncoated carbide

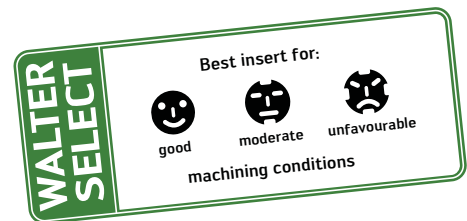



Product range overview of milling cutters with inserts

Face / shoulder milling

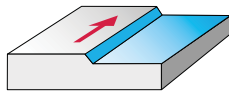

For Walter Select, see page F 60

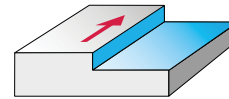

For Walter Select, see page F 134

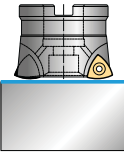
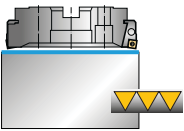
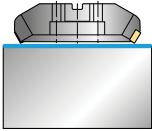
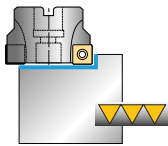
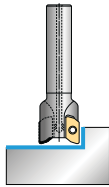
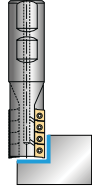
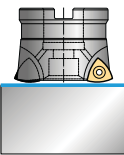
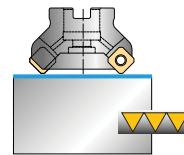
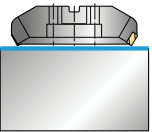
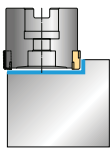
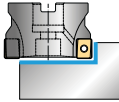
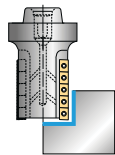
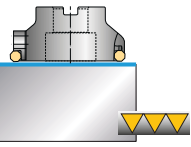
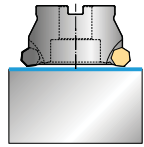
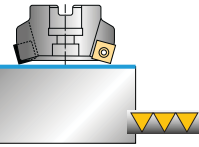
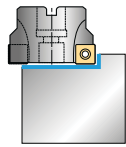
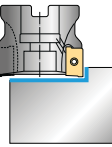
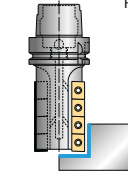
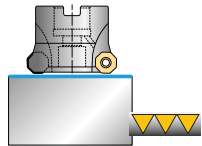
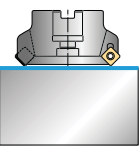
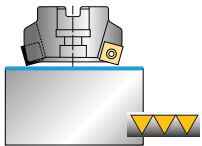
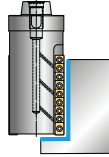
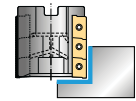
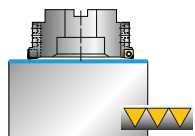
$\kappa = 0-15^\circ$ $D_a = 20-85 \text{ mm}$ F 2330 Page F 114 	$\kappa = 0-90^\circ$ $D_c = 80-315 \text{ mm}$ F 2010 Page F 66 	$\kappa = 60^\circ$ $D_c = 100-315 \text{ mm}$ F 2260 Page F 110 	$\kappa = 88^\circ$ $D_c = 40-200 \text{ mm}$ Xtra-tec® F 4048 Page F 128 	$\kappa = 90^\circ$ $D_c = 25-63 \text{ mm}$ F 3040 Page F 140 	$\kappa = 90^\circ$ $D_c = 20-32 \text{ mm}$ F 4038 Page F 162 Xtra-tec® 
$\kappa = 0-21^\circ$ $D_a = 25-100 \text{ mm}$ Xtra-tec® F 4030 Page F 116 	$\kappa = 45^\circ$ $D_c = 40-200 \text{ mm}$ Xtra-tec® F 4033 Page F 118 	$\kappa = 60^\circ$ $D_c = 125-315 \text{ mm}$ F 2265 Page F 112 	$\kappa = 89^\circ$ $D_c = 50-160 \text{ mm}$ F 2254 Page F 108 	$\kappa = 90^\circ$ $D_c = 40-160 \text{ mm}$ Xtra-tec® F 4041 Page F 142 	$\kappa = 90^\circ$ $D_c = 32-80 \text{ mm}$ Xtra-tec® F 4138 Page F 164 
$\kappa = 43^\circ$ $D_c = 80-250 \text{ mm}$ F 2146 Page F 96 	$\kappa = 45^\circ$ $D_c = 63-200 \text{ mm}$ Xtra-tec® F 4045 Page F 122 	$\kappa = 75^\circ$ $D_c = 32-100 \text{ mm}$ F 2235 Page F 102 	$\kappa = 89^\circ/45^\circ$ $D_c = 16-160 \text{ mm}$ F 2241 Page F 138 	$\kappa = 90^\circ$ $D_c = 10-160 \text{ mm}$ Xtra-tec® F 4042 Page F 144 	$\kappa = 90^\circ$ $D_c = 40-80 \text{ mm}$ Xtra-tec® F 4238 Page F 166 
$\kappa = 43^\circ$ $D_a = 32-170 \text{ mm}$ Xtra-tec® F 4080 Page F 130 	$\kappa = 45^\circ$ $D_c = 20-160 \text{ mm}$ F 2233 Page F 98 	$\kappa = 75^\circ$ $D_c = 40-200 \text{ mm}$ Xtra-tec® F 4047 Page F 126 		$\kappa = 90^\circ$ $D_c = 63-100 \text{ mm}$ F 2338F Page F 160 	$\kappa = 90^\circ$ $D_c = 63-125 \text{ mm}$ Xtra-tec® F 4338 Page F 168 
	$\kappa = 75^\circ + 90^\circ$ $D_c = 63-200 \text{ mm}$ F 2250 Page F 104 				

	Slot milling		Copy milling		Profile milling	Circular interpolation milling	
	<p>For Walter Select, see page F 170</p>		<p>For Walter Select, see page F 212</p>		<p>For Walter Select, see page F 234</p>	<p>For Walter Select, see page F 242</p>	
	$\kappa = 90^\circ$ $D_C = 20-125 \text{ mm}$	$\kappa = 90^\circ$ $D_C = 80-315 \text{ mm}$	$D_C = 8-32 \text{ mm}$	$D_a = 10-40 \text{ mm}$	$\kappa = 90^\circ$ $D_C = 16-63 \text{ mm}$	$\kappa = 45^\circ$ $D_a = 36-85 \text{ mm}$	$D_a = 12-160 \text{ mm}$
	F 2238 Page F 176	F 2252 Page F 186	F 2139 Page F 214	F 2231/A Page F 216	F 2036 Page F 236	Xtra-tec® F 4081 Page F 244	F 2234 Page F 218
	$\kappa = 90^\circ$ $D_C = 63-100 \text{ mm}$	$\kappa = 90^\circ$ $D_C = 63-250 \text{ mm}$	$D_C = 20-50 \text{ mm}$	$D_a = 12-160 \text{ mm}$	$\kappa = 90^\circ$ $D_C = 21-50 \text{ mm}$	$\kappa = 45^\circ$ $D_a = 32-170 \text{ mm}$	$D_a = 25-160 \text{ mm}$
	F 2338 Page F 184	F 2255 Page F 198	F 2239 B Page F 226	F 2234 Page F 218	F 2243 Page F 240	Xtra-tec® F 4080 Page F 130	F 2334 Page F 222
	$\kappa = 90^\circ$ $D_C = 18-40 \text{ mm}$	$\kappa = 90^\circ$ $D_C = 80-160 \text{ mm}$	$D_C = 16-50 \text{ mm}$	$D_a = 25-160 \text{ mm}$	$\kappa = 45^\circ$ $D_C = 12-40 \text{ mm}$	$\kappa = 0^\circ-15^\circ$ $D_a = 20-85 \text{ mm}$	$\kappa = 90^\circ$ $D_C = 25-63 \text{ mm}$
	F 2237 Page F 174	Xtra-tec® F 4053 Page F 200	F 2339 Page F 228	F 2334 Page F 222	F 2232 Page F 238	F 2330 Page F 114	F 3040 Page F 140
	$\kappa = 0^\circ-15^\circ$ $D_a = 20-85 \text{ mm}$	$\kappa = 90^\circ$ $D_C = 80-200 \text{ mm}$	$\kappa = 90^\circ$ $D_C = 12-32 \text{ mm}$			$\kappa = 0^\circ-21^\circ$ $D_a = 25-100 \text{ mm}$	$\kappa = 90^\circ$ $D_C = 10-160 \text{ mm}$
	F 2330 Page F 114	Xtra-tec® F 4153 Page F 204	F 4031 Page F 232 Xtra-tec®			Xtra-tec® F 4030 Page F 116	Xtra-tec® F 4042 Page F 144
	$\kappa = 0^\circ-21^\circ$ $D_a = 25-100 \text{ mm}$	$\kappa = 90^\circ$ $D_C = 100-315 \text{ mm}$					
	Xtra-tec® F 4030 Page F 116	Xtra-tec® F 4253 Page F 208					

System overview of ScrewFit for boring and circular interpolation milling



AK 530
Page G 71

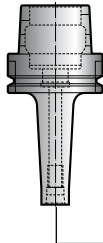

AK 531
Page G 73

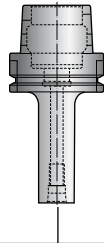

AK 540
Page G 74



AK 541
Page G 76

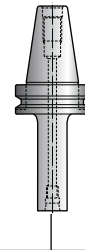

AK 580
Page G 80

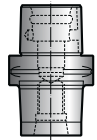

Drilling / Circular interpolation milling

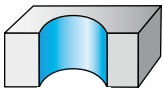

B 4011
Page C 50
Xtra-tec®



F 4030
Page F 116
Xtra-tec®

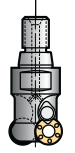

F 2231
Page F 216



F 2234
Page F 218

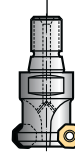

F 4080
Page F 130
Xtra-tec®



F 4081
Page F 244
Xtra-tec®



F 2330
Page F 114



F 2334
Page F 222



F 3040
Page F 140



F 4042
Page F 144
Xtra-tec®

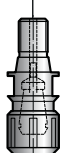

AK 300 T
Page G 60

Counterboring

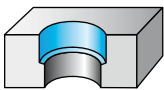

B 322 .
Page C 92 / C 94
Walter Boring^{MEDIUM}

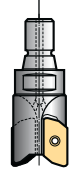

F 3040
Page F 140



F 4042
Page F 144
Xtra-tec®



F 4031
Page F 232
Xtra-tec®



F 4081
Page F 244
Xtra-tec®



Solid carbide and HSS drills see page B 4

Precision boring

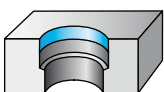

B 4030*
Page C 100–C 102
Walter Precision^{MINI}



B 3230*
Page C 108
Walter Precision^{MEDIUM}



B 4030*
Page C 110

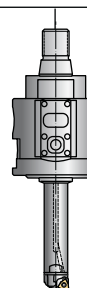

B 4035*
Page C 116
Walter Precision^{DIGITAL}

* Only in combination with AK 53 . CO and AK 54 . CO . For cutting edge orientation for ScrewFit precision boring tools, see page C 192.

ScrewFit system overview of milling



AK 500
Page G 67



AK 510
Page G 68



AK 520
Page G 69

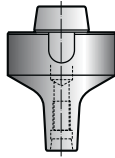

AK 521
Page G 70



AK 522
Page G 70

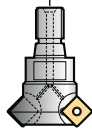

F 2232¹
Page F 238



F 4080
Page F 130
Xtra-tec®



F 2330
Page F 114
(Surface and Plunge milling cutter)

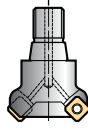

F 4033
Page F 118
Xtra-tec®



F 4047
Page F 126
Xtra-tec®



F 4048
Page F 128
Xtra-tec®



F 4030
Page F 116
Xtra-tec®

Face milling

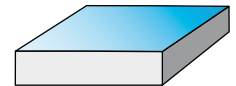

AK 300 T
Page F 60



F 2241
Page F 138



F 3040
Page F 140



F 4.38
Page F 162
Xtra-tec®

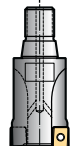

F 4041
Page F 142
Xtra-tec®



F 4042
Page F 144
Xtra-tec®



F 4042R
Page F 148
Xtra-tec®



F 4722
Page E 52

Shoulder / Slot Milling

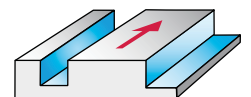

Solid carbide and HSS mills see page E 4



F 2139
Page F 214



F 2231
Page F 216



F 2234
Page F 218



F 2239
Page F 226



F 2339
Page F 228



F 2334
Page F 222



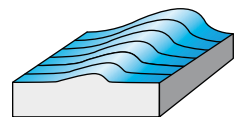

F 4031
Page F 232
Xtra-tec®

Copy milling



¹ for chamfering 45°

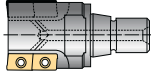
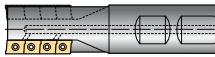
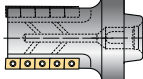
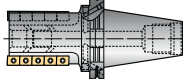
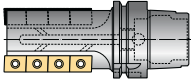
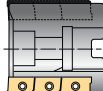
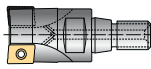
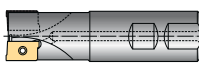
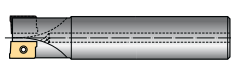

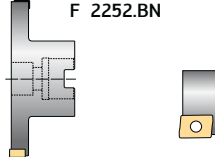
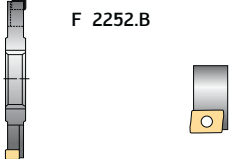
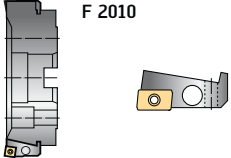







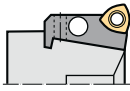

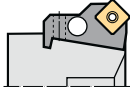

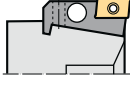

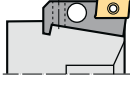

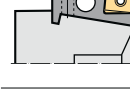
Overview of AD . . system inserts

suitable for milling cutter type		AD . . 0803 . .	AD . . 10T3 . .	AD . . 1204 . .	AD . . 1606 . .	AD . . 1807 . .
AD . . 		F 4038.T Page F 162		F 4138.T Page F 164	F 4238.T Page F 166	
		F 4038.W Page F 162		F 4138.W Page F 164		
				F 4138.N Page F 164	F 4238.N Page F 166	F 4338.N Page F 168
				F 4138.S Page F 164	F 4238.S Page F 166	F 4338.S Page F 168
				F 4138.H Page F 164	F 4238.H Page F 166	F 4338.H Page F 168
				F 4138.B Page F 164	F 4238.B Page F 166	F 4338.B Page F 168
		F 4042.T Page F 144	F 4042R.T Page F 148	F 4042.T Page F 152	F 4042.T Page F 156	F 4042.T Page F 158
		F 4042.W Page F 144	F 4042R.W Page F 148	F 4042.W Page F 152		
		F 4042.Z Page F 146	F 4042R.Z Page F 150	F 4042.Z Page F 152		
		F 4042.B Page F 146	F 4042R.B Page F 150	F 4042.B Page F 154	F 4042.B Page F 156	F 4042.B Page F 158
		F 2252.BN	FR/L 724 Page F 192		FR/L 725 Page F 192	FR/L 726 Page F 192
		F 2252.B	FR/L 724 Page F 186		FR/L 725 Page F 186	FR/L 726 Page F 186
		F 2010			FR 718M Page F 86	FR 719M Page F 88

Overview of SN . X system inserts

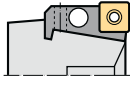
suitable for milling cutter type		SN . X 120512 . . 120520 . .	SN . X 160620 . . 160640 . .	SN . X 1205 ANN . .	SN . X 1606 ANN . .	SN . X 1205 ENN . .	SN . X 1205 ZNN . .
SN . X 	 $\kappa = 45^\circ$	F 4033.T Page F 118		F 4033.T Page F 118			
	 $\kappa = 45^\circ$	F 4033.B Page F 118	F 4033.B Page F 120	F 4033.B Page F 118	F 4033.B Page F 120		
	 $\kappa = 75^\circ$	F 4047.T Page F 126				F 4047.T Page F 126	
	 $\kappa = 75^\circ$	F 4047.B Page F 126				F 4047.B Page F 126	
	 $\kappa = 88^\circ$	F 4048.T Page F 128					F 4048.T Page F 128
	 $\kappa = 88^\circ$	F 4048.B Page F 128					F 4048.B Page F 128
F 2010	 $\kappa = 45^\circ$	FR 720M Page F 72	FR 732M Page F 74	FR 720M Page F 72	FR 732M Page F 74		
	 $\kappa = 75^\circ$	FR 727M Page F 78				FR 727M Page F 78	
	 $\kappa = 88^\circ$	FR 728M Page F 82					FR 728M Page F 82

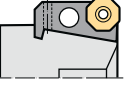
System overview of face mill F 2010 Microplan adjustable

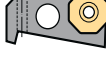
F 2010	Cartridge design	D_c [mm]	max. cutting depth [mm]	Indexable inserts	Finishing cartridges for roughing- finishing combination*	as supplement to tool
	 <p>K = 0–15° F 2010...R729M Page F 66</p>	70–305	2,0	 <p>P 2633 . – R 25</p>		<p>F 2330 D_c = 20–85 mm Page F 114</p>
	 <p>K = 45° F 2010...R732M Page F 74</p>	80–315	9,0	 <p>SN . X 1606 ANN SN . X 160620 SN . X 160640</p>		<p>F 4033 D_c = 50–200 mm Page F 120</p>
	 <p>K = 90° F 2010...R718M Page F 86</p>	80–315	11,7	 <p>AD . . 1204 . .</p>		<p>F 4042...11 D_c = 25–80 mm Page F 152</p>
	 <p>K = 90° F 2010...R719M Page F 88</p>	80–315	15,0	 <p>AD . . 1606 . .</p>		<p>F 4042...15 D_c = 40–160 mm Page F 156</p>
	 <p>K = 90° F 2010...R722M Page F 92</p>	80–315	13,0	 <p>LNGX . .</p>		<p>F 4041 D_c = 40–160 mm Page F 142</p>
	 <p>F 2010...R723M Page F 94</p>	74–309	8,0	 <p>RO . X 1605 . .</p>		<p>F 2334...08 D_c = 52–141 mm Page F 224</p>
	 <p>K = 75° F 2010...R727M Page F 78</p>	80–315	8,0	 <p>SN . . 1205 ENN SN . X 120512 SN . X 120520</p>  <p>Finishing insert: XNGX 1205 ENN</p>		<p>F 4047 D_c = 40–200 mm Page F 126</p>
	 <p>K = 88° F 2010...R728M Page F 82</p>	80–315	10,0	 <p>SN . . 1205 ZNN, SN . X 120512 SN . X 120520</p>  <p>Finishing insert: XNGX 1205 ZNN</p>		<p>F 4048 D_c = 40–200 mm Page F 128</p>
	 <p>K = 43° F 2010...R592M Page F 68</p>	80–315	4,0	 <p>OD . . 0605 . .</p>  <p>Finishing insert ODHX 0605ZZR is installed in cartridge FR 592M</p>	 <p>Cartridge: FR 681M Insert: ODHX 0605ZZN</p>	<p>F 4080 D_c = 50–160 mm Page F 132</p>

F 2010	Cartridge design	D _c [mm]	max. cutting depth [mm]	Indexable inserts	Finishing cartridges for roughing- finishing combination*	as a supplement to the tool
	 K = 45° F 2010...R720M Page F 72	80–315	6,5	 SN . X 1205 ANN SN . X 120512 SN . X 120520	 Cartridge: FR 448 M Insert: P 2905–1 Cartridge: FR 681M Insert: ODHX 0605 ZZN Cartridge: FR 730 M Indexable insert: XNGX 1205 ANN	F 4033 D _c = 40–200 mm Page F 118
	 K = 45° F 2010...R495M Page F 76	80–315	7,0	SP . . 1204 . .	 Cartridge: FR 448M Insert P 2905–1	F 2233...07 D _c = 25–160 mm Page F 100
	 K = 75° F 2010...R441M Page F 80	80–315	10,0	 Finishing insert P 2901–1 is installed in cartridge FR 441M	 Cartridge: FR 448 M Insert: P 2905–1	F 2235 D _c = 32–100 mm Page F 102
	 K = 89°45' F 2010...R445M Page F 84	80–315	11,0	SP . . 1204 . .	 Cartridge: FR 448 M Insert: P 2905–1	F 2241...12 D _c = 32–160 mm Page F 138
	 K = 45° F 2010...R681M Page F 70 	80–315	0,5–2,0 (4,0)	ODHX 0605 ZZN		
	 K = 90° F 2010...R500M Page F 90 	80–315	0,5–1,0 (9,0)	P 2903–2R		

* where using this finishing method, one or several roughing cartridges must be replaced by a finishing cartridge.



Designation key for milling cutters

Example

F	4	0	42	T	45	050	Z05	15	
1	2	3	4	5	6	7	8	9	10

1
Tool range
F Milling cutters

2
Generation

3
Version or insert size

4																																		
Tool type																																		
<table border="0"> <tr> <td>10 Face mill with cartridges</td> <td>47 Face mill $\kappa = 75^\circ$</td> </tr> <tr> <td>30 High Performance mill</td> <td>48 Shoulder mill $\kappa = 88^\circ$</td> </tr> <tr> <td>31 Toric copy mill</td> <td>50 Face mill for PCD inserts</td> </tr> <tr> <td>32 Chamfer mill $\kappa = 45^\circ$</td> <td>52 Side and face mill with cartridges</td> </tr> <tr> <td>33 Face mill $\kappa = 45^\circ$, screw clamped</td> <td>53 Side and face mill with tangential insert arrangement</td> </tr> <tr> <td>34 Milling cutter with round inserts</td> <td>54 Close pitch cutter for cast iron $\kappa = 89^\circ$</td> </tr> <tr> <td>35 Face mill $\kappa = 75^\circ$</td> <td>55 Slitting cutter</td> </tr> <tr> <td>36 Circular slot milling cutter</td> <td>60 Heavy-duty cutter $\kappa = 60^\circ$</td> </tr> <tr> <td>37 Routing cutter</td> <td>65 Heavy-duty cutter with helix geometry $\kappa = 60^\circ$</td> </tr> <tr> <td>38 Porcupine cutter</td> <td>80 Octagon cutter $\kappa = 43^\circ$</td> </tr> <tr> <td>39 Copy mill with ball shape</td> <td>81 Octagon cutter $\kappa = 45^\circ$</td> </tr> <tr> <td>40 Shoulder mill for aluminium</td> <td></td> </tr> <tr> <td>41 Shoulder mill with 4 cutting edges per insert</td> <td></td> </tr> <tr> <td>42 Shoulder mill with 2 cutting edges per insert</td> <td></td> </tr> <tr> <td>43 T-slot milling cutter</td> <td></td> </tr> <tr> <td>45 Heptagon cutter $\kappa = 45^\circ$</td> <td></td> </tr> <tr> <td>46 Face mill $\kappa = 43^\circ$, wedge-clamped</td> <td></td> </tr> </table>	10 Face mill with cartridges	47 Face mill $\kappa = 75^\circ$	30 High Performance mill	48 Shoulder mill $\kappa = 88^\circ$	31 Toric copy mill	50 Face mill for PCD inserts	32 Chamfer mill $\kappa = 45^\circ$	52 Side and face mill with cartridges	33 Face mill $\kappa = 45^\circ$, screw clamped	53 Side and face mill with tangential insert arrangement	34 Milling cutter with round inserts	54 Close pitch cutter for cast iron $\kappa = 89^\circ$	35 Face mill $\kappa = 75^\circ$	55 Slitting cutter	36 Circular slot milling cutter	60 Heavy-duty cutter $\kappa = 60^\circ$	37 Routing cutter	65 Heavy-duty cutter with helix geometry $\kappa = 60^\circ$	38 Porcupine cutter	80 Octagon cutter $\kappa = 43^\circ$	39 Copy mill with ball shape	81 Octagon cutter $\kappa = 45^\circ$	40 Shoulder mill for aluminium		41 Shoulder mill with 4 cutting edges per insert		42 Shoulder mill with 2 cutting edges per insert		43 T-slot milling cutter		45 Heptagon cutter $\kappa = 45^\circ$		46 Face mill $\kappa = 43^\circ$, wedge-clamped	
10 Face mill with cartridges	47 Face mill $\kappa = 75^\circ$																																	
30 High Performance mill	48 Shoulder mill $\kappa = 88^\circ$																																	
31 Toric copy mill	50 Face mill for PCD inserts																																	
32 Chamfer mill $\kappa = 45^\circ$	52 Side and face mill with cartridges																																	
33 Face mill $\kappa = 45^\circ$, screw clamped	53 Side and face mill with tangential insert arrangement																																	
34 Milling cutter with round inserts	54 Close pitch cutter for cast iron $\kappa = 89^\circ$																																	
35 Face mill $\kappa = 75^\circ$	55 Slitting cutter																																	
36 Circular slot milling cutter	60 Heavy-duty cutter $\kappa = 60^\circ$																																	
37 Routing cutter	65 Heavy-duty cutter with helix geometry $\kappa = 60^\circ$																																	
38 Porcupine cutter	80 Octagon cutter $\kappa = 43^\circ$																																	
39 Copy mill with ball shape	81 Octagon cutter $\kappa = 45^\circ$																																	
40 Shoulder mill for aluminium																																		
41 Shoulder mill with 4 cutting edges per insert																																		
42 Shoulder mill with 2 cutting edges per insert																																		
43 T-slot milling cutter																																		
45 Heptagon cutter $\kappa = 45^\circ$																																		
46 Face mill $\kappa = 43^\circ$, wedge-clamped																																		

5									
Interface									
<table border="0"> <tr> <td>B Bore</td> </tr> <tr> <td>BN Bore with hub</td> </tr> <tr> <td>H HSK</td> </tr> <tr> <td>M Morse taper</td> </tr> <tr> <td>N NCT</td> </tr> <tr> <td>S Steep taper</td> </tr> <tr> <td>T ScrewFit</td> </tr> <tr> <td>W Weldon shank</td> </tr> <tr> <td>Z Cylindrical shank</td> </tr> </table>	B Bore	BN Bore with hub	H HSK	M Morse taper	N NCT	S Steep taper	T ScrewFit	W Weldon shank	Z Cylindrical shank
B Bore									
BN Bore with hub									
H HSK									
M Morse taper									
N NCT									
S Steep taper									
T ScrewFit									
W Weldon shank									
Z Cylindrical shank									

6
Interface size

7
Cutting diameter

8
No. of teeth

9
Maximum cutting depth or cutting width

10
Cutting direction and cartridge type
only with F 2010 / F 2146 / F 2250 / F 2252:
R Right-hand
L Left-hand
S Cutting on 3 sides

Walter Select – face milling

Application			
Approach angle κ	43°	45°	45°
Face milling cutter	F 2146 	F 2233 	F 4033 Xtra-tec®
Ø range	80–250	20–160	40–200
Page	F 96	F 98	F 118
P Steel	•	••	••
M Stainless steel	•	••	••
K Cast iron	••	••	••
N NF metals		••	••
S Difficult-to-machine materials	•	••	••
H Hard materials	•	•	•
O Other		•	•
Basic insert shapes			
Insert types	OP .. 0504 ..	SD .. 09T3 .. SP .. 1204 ..	SN . X 1205 .. SN . X 1606 ..
Max. cutting depths [mm]	3/8	5 + 7	6,5 + 9
Number of cutting edges per indexable insert	8	4	8

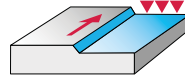
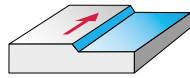

	75° + 90°	75°	75°	88°
	F 2250	F 2235	F 4047	F 4048
			Xtra-tec®	Xtra-tec®
	63-200	32-100	40-200	40-200
	F 104	F 102	F 126	F 128
		••	••	••
		••	••	••
		••	••	••
	••	••	•	•
		••	••	••
		•		
	SP...1204...	SP...1204...	SN.X1205...	SN.X1205...
	3 + 4	10	8	10
	1	4	8	8



Walter Select – face milling

Application				
Approach angle κ	45°	60°	60°	89°
Face milling cutter	F 4045 Xtra-tec®	F 2260 	F 2265 	F 2254
Ø range [mm]	63–200	100–315	125–315	50–160
Page	F 122	F 110	F 112	F 108
P Steel	•	•	••	
M Stainless steel			•	
K Cast iron	••	••	•	••
N NF metals				
S Difficult-to-machine materials			•	
H Hard materials				
O Other				
Basic insert shape				
Insert types	XNHF 0705 .. XNHF 0906 ..	LNMU 1508 .. LNMU 2010 ..	LNKU 2010 .. LNKU 3010 ..	SNHQ 1205 ..
Max. cutting depths [mm]	4 + 6	11 + 15	12 + 20	7
Number of cutting edges per indexable insert	14	4	4	8

<p>43°</p>	<p>0-15°</p>	<p>0-21°</p>
<p>F 4080</p> <p>Xtra-tec®</p>	<p>F 2330</p>	<p>F 4030</p> <p>Xtra-tec®</p>
<p>32-170</p>	<p>20-85</p>	<p>25-100</p>
<p>F 130</p>	<p>F 114</p>	<p>F 116</p>
<p>••</p>	<p>••</p>	<p>••</p>
<p>••</p>	<p>••</p>	<p>••</p>
<p>••</p>	<p>••</p>	<p>••</p>
<p>••</p>	<p>••</p>	<p>••</p>
<p>••</p>	<p>••</p>	<p>••</p>
<p>••</p>	<p>••</p>	<p>••</p>
<p>•</p>	<p>•</p>	<p>•</p>
<p>•</p>	<p>•</p>	<p>•</p>
<p>OD .. 0504 .. OD .. 0605 ..</p>	<p>P 2633 . P 26379</p>	<p>P 23696 - 1,0 P 23696 - 2,0</p>
<p>3/8 + 4/10</p>	<p>1 + 1,5 + 2</p>	<p>1 + 2</p>
<p>8</p>	<p>3</p>	<p>6</p>



Walter Select – face milling

Application					
Roughing	▲	▲	▲		
Finishing milling	▲	▲	▲		
Shoulder milling				▲	
Shoulder milling (finishing)				▲	
Plunging					
Circular interpolation milling					
Pocket milling					
Approach angle κ	45°	75°	45° / 75° / 88°	89°45'	
Face mill	F 2010 				
Ø range [mm]	80–315	80–315	80–315	80–315	
Page	F 76	F 80	F 72–75, F 78, F82	F 84	
P Steel	●●	●●	●●	●●	
M Stainless steel	●●	●●	●●	●●	
K Cast iron	●●	●●	●●	●●	
N NF metals	●●	●●	●●	●●	
S Difficult-to-machine materials	●	●	●●	●	
H Hard materials	●		●	●	
O Other	●	●	●	●	
Basic insert shapes					
Insert types	SP .. 1204 ..	SP .. 1204 ..	SN .. 1205 .. SN .. 1606 ..*	SP .. 1204 ..	
Max. cutting depths [mm]	6 + 7	10	6,5 + 8 + 9 + 10	11	
Number of cutting edges per indexable insert	4	4	8	4	

* SN .. 1606 .. for 45° lead only.

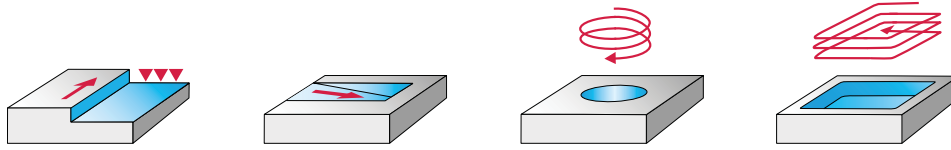

				▲	▲	▲
					▲	▲
	▲	▲				
	▲	▲	▲			
		▲		▲	▲	▲
		▲		▲	▲	▲
		▲		▲	▲	▲
	90°	90°	90°	0-15°	43° / 45°	—

F 2010

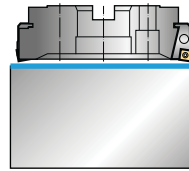

	80-315	80-315	80-315	70-305	80-315	74-309
	F 92	F 86-89	F 90	F 66	F 68-71	F 94
	●●	●●	●●	●●	●●	●●
	●●	●●	●	●●	●●	●●
	●●	●●	●●	●●	●●	●●
	●●	●●			●●	●
	●●	●●		●●	●●	●●
	●	●		●		●
	●	●			●	
	LNGX 1307 ..	AD .. 1204 .. AD .. 1606 ..	P 2903 ..	P 2633 ..-R25 P 26379-R25	OD .. 0605 ..	RO . X 1605 ..
	13	11,7 + 15	1/9	2	2 + 4/10	8
	4	2	3	3	8	6



Face mill F 2010

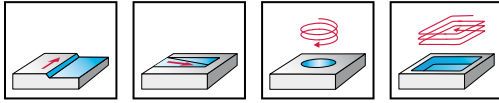
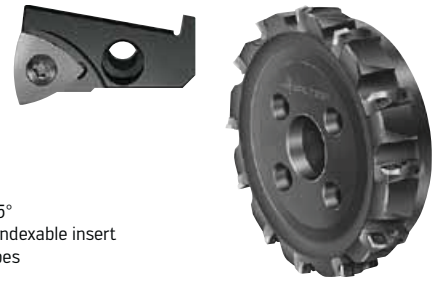

- Approach angle $\kappa = 0 - 15^\circ$
- Three cutting edges per indexable insert
- Positive basic insert shapes
- f_z up to 3.5 mm
- Axial runout adjustable

Tool	Designation	D_c mm	D_a mm	d_1 mm	l_4 mm	L_c mm	Z	kg	No. of indexable inserts	Type
Cyl. bore DIN 138 longitudinal key way 	F2010.B.080.Z06.02.R729M	70	87	27	50	2	6	1,2	6	P 2633 . - R 25 P 26379 - R 25
	F2010.B.100.Z07.02.R729M	90	107	32	50	2	7	1,8	7	
	F2010.B.125.Z08.02.R729M	115	132	40	63	2	8	3,5	8	
Cyl. bore DIN 138 longitudinal key way 	F2010.B.160.Z10.02.R729M	150	167	40/40 B	63	2	10	5,5	10	P 2633 . - R 25 P 26379 - R 25
	F2010.B.200.Z12.02.R729M	190	207	60/50 B	63	2	12	8,2	12	P 2633 . - R 25 P 26379 - R 25
	F2010.B.250.Z12.02.R729M	240	257	60/50 B	63	2	12	14,6	12	
F2010.B.250.Z16.02.R729M	240	257	60/50 B	63	2	16	14,5	16		
Cyl. bore DIN 138 longitudinal key way 	F2010.B.315.Z14.02.R729M	305	322,15	60/50-60 BB	80	2	14	26,3	14	P 2633 . - R 25 P 26379 - R 25
	F2010.B.315.Z18.02.R729M	305	322,15	60/50-60 BB	80	2	18	26,2	18	

Bodies and assembly parts are included in the scope of delivery.

Assembly parts

D _c mm		70-305
	Adjusting bolt	FS303 (Torx 20)
	Cartridge for tool body	FR729M
	Clamping screw for cartridge	FS247 (SW 4)
	Tightening torque	8,0 Nm
	Clamping screw for insert	FS1030 (Torx 20)
	Tightening torque	5,0 Nm

Accessories

D _c mm		70-305
	ISO 2936 Allen key for cartridge	ISO2936-4 (SW 4)
	Screwdriver for indexable insert and adjusting pin	FS228 (Torx 20)

Indexable inserts

Designation	Radius mm	Face chamfer width mm	P		M		K			N		S		H				
			HC	HC	HC	HC	HC	HW	HC	HC	HC							
			WKP25	WKP35	WKP35S	WSP45	WSM35	WSP45	WAK15	WKK25	WKP25	WKP35	WKP35S	WXN15	WK10	WSM35	WSP45	WHH15
P26335R25	2,0	-	☺	☺	☺	☺	☺	☺		☺	☺	☺	☺			☺	☺	
P26337R25	2,0	-	☺	☺	☺	☺	☺	☺		☺	☺	☺	☺			☺	☺	
P26339R25	2,0	-	☺	☺	☺	☺	☺	☺		☺	☺	☺	☺			☺	☺	
P26379-R25	2,0	1,1	☺	☺	☺	☺	☺	☺		☺	☺	☺	☺			☺	☺	

HC = Coated carbide
HW = Uncoated carbide

WALTER SELECT

Best insert for:

☺
good

☹
moderate

☹
unfavourable

machining conditions

Face mill F 2010

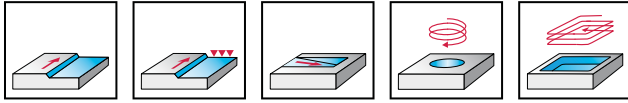
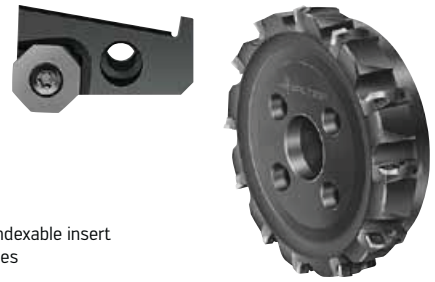

- Approach angle $\kappa = 43^\circ$
- Eight cutting edges per indexable insert
- Positive basic insert shapes
- Axial runout adjustable
- Finishing inserts available

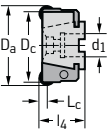
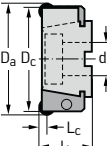
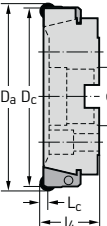
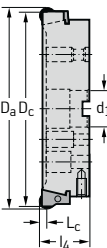
Tool	Designation	D_c mm	D_a mm	d_1 mm	l_4 mm	L_c mm	Z	kg	No. of indexable inserts	Type
Cyl. bore DIN 138 longitudinal key way 	F2010.B.080.Z06.04.R592M	80	90	27	50	4	6	1,2	6	OD...0605...
	F2010.B.100.Z07.04.R592M	100	110	32	50	4	7	1,8	7	
	F2010.B.125.Z08.04.R592M	125	135	40	63	4	8	3,5	8	
Cyl. bore DIN 138 longitudinal key way 	F2010.B.160.Z10.04.R592M	160	170	40/40 B	63	4	10	5,5	10	OD...0605...
Cyl. bore DIN 138 longitudinal key way 	F2010.B.200.Z12.04.R592M	200	210	60/50 B	63	4	12	8,2	12	OD...0605...
	F2010.B.250.Z12.04.R592M	250	260	60/50 B	63	4	12	14,7	12	
	F2010.B.250.Z16.04.R592M	250	260	60/50 B	63	4	16	14,6	16	
Cyl. bore DIN 138 longitudinal key way 	F2010.B.315.Z14.04.R592M	315	325	60/50-60 BB	80	4	14	26,3	14	OD...0605...
	F2010.B.315.Z18.04.R592M	315	325	60/50-60 BB	80	4	18	26,2	18	

Bodies and assembly parts are included in the scope of delivery.

Assembly parts

		D _c mm	80-315
	Adjusting bolt		FS303 (Torx 20)
	Cartridge for tool body		FR592M
	Clamping screw for cartridge		FS247 (SW 4)
	Tightening torque		8,0 Nm
	Clamping screw for insert		FS1030 (Torx 20)
	Tightening torque		5,0 Nm

Accessories

		D _c mm	80-315
	Finishing cartridge for tool body		FR681M
	Finishing insert		ODHX0605ZZN ...
	ISO 2936 Allen key for cartridge		ISO2936-4 (SW 4)
	Screwdriver for indexable insert and adjusting bolt		FS228 (Torx 20)

Indexable inserts

Designation	Radius mm	Face chamfer width mm	P		M		K			N		S		H		HF			
			HC		HC		HC			CN	HC	HW	HC		HC	HC			
			WKP25	WKP35	WKP35S	WSP45	WSM35	WSP45	WAK15	WKK25	WKP25	WKP35	WKP35S	WSN10	WXN15	WK10	WSM35	WSP45	WHH15
ODHT060512-F57	0,8	-	☺	☺	☺	☺			☺	☺			☺	☺					
ODHT060512-G88	0,8	-											☺	☺					
ODHT0605ZZN-F57	0,8	1,6	☺	☺	☺	☺			☺	☺			☺	☺					☺
ODHT0605ZZN-G88	0,8	1,6											☺	☺					
ODHW060512-A57	1,2	-	☺	☺	☺			☺	☺	☺									
ODHW060516-A57	1,6	-									☺								
ODHW0605ZZN-A57	0,8	1,6	☺	☺	☺			☺	☺	☺									
ODHX0605ZZR-A57*	0,8	9,4		☺	☺			☺										☺	☺
ODMT060512-D57	1,2	-	☺	☺	☺	☺		☺	☺	☺									
ODMT0605ZZN-D57	0,8	1,6	☺	☺	☺	☺		☺	☺	☺									
ODMW060508-A57	0,8	-	☺	☺	☺			☺	☺	☺									
ODMW060508T-A27	0,8	-	☺	☺	☺			☺	☺	☺									

For roughing / finishing combinations, see page F 312.
 * Only in combination with ODH ... ZZN ...

HC = Coated carbide
 CN = Silicon nitride Si₃N₄
 HW = Uncoated carbide
 HF = Uncoated fine-grained carbide

WALTER SELECT

Best insert for:

☺
good

☹
moderate

☹
unfavourable

machining conditions

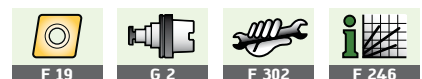

Face mill F 2010

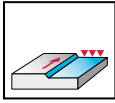
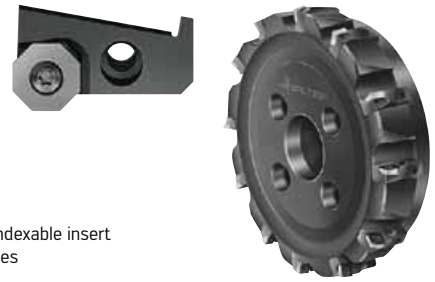

- Approach angle $\kappa = 45^\circ$
- Eight cutting edges per indexable insert
- Positive basic insert shapes
- Axial runout adjustable
- Finishing inserts available

Tool	Designation	D _c mm	D _a mm	d ₁ mm	l ₄ mm	L _c mm	Z	kg	No. of indexable inserts	Type
Cyl. bore DIN 138 longitudinal key way	F2010.B.080.Z06.02.R681M	80	90	27	50	2	6	1,2	6	ODHX 0605 ZZN
	F2010.B.100.Z07.02.R681M	100	110	32	50	2	7	1,8	7	
	F2010.B.125.Z08.02.R681M	125	135	40	63	2	8	3,5	8	
Cyl. bore DIN 138 longitudinal key way	F2010.B.160.Z10.02.R681M	160	170	40/40 B	63	2	10	5,5	10	ODHX 0605 ZZN
Cyl. bore DIN 138 longitudinal key way	F2010.B.200.Z12.02.R681M	200	210	60/50 B	63	2	12	8,2	12	ODHX 0605 ZZN
	F2010.B.250.Z16.02.R681M	250	260	60/50 B	63	2	16	14,6	16	
Cyl. bore DIN 138 longitudinal key way	F2010.B.315.Z18.02.R681M	315	325	60/50-60 BB	80	2	18	26,2	18	ODHX 0605 ZZN

Bodies and assembly parts are included in the scope of delivery.

Assembly parts

D _c mm		80-315
	Adjusting bolt	FS303 (Torx 20)
	Cartridge for tool body	FR681M
	Clamping screw for cartridge	FS247 (SW 4)
	Tightening torque	8,0 Nm
	Clamping screw for insert	FS1030 (Torx 20)
	Tightening torque	5,0 Nm

Accessories

D _c mm		80-315
	ISO 2936 Allen key for cartridge	ISO2936-4 (SW 4)
	Screwdriver for indexable insert and adjusting bolt	FS228 (Torx 20)

Indexable inserts

Designation	Radius mm	Face chamfer width mm	P		M		K		N		S		H						
			HC	HC	HC	HC	HC	HW	HC	HC	HC	HC							
			WKP25	WKP35	WKP35S	WSP45	WSM35	WSP45	WAK15	WKK25	WKP25	WKP35	WKP35S	WXN15	WK10	WSM35	WSP45	WHH15	WXM15
ODHX0605ZZN-A57	1,8	6,0							⊕									⊕	⊕
ODHX0605ZZN-A88	1,8	6,0							⊕									⊕	⊕

HC = Coated carbide
HW = Uncoated carbide

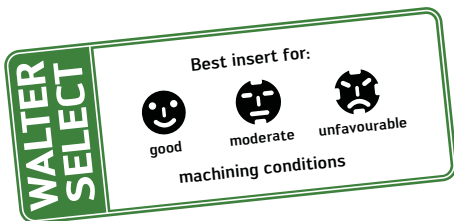

Face mill F 2010

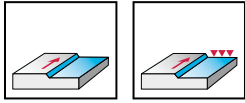
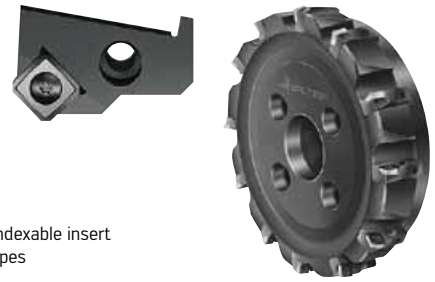

- Approach angle $\kappa = 45^\circ$
- Eight cutting edges per indexable insert
- Negative basic insert shapes
- Axial runout adjustable
- Finishing inserts available

Tool	Designation	D_c mm	D_a mm	d_1 mm	l_4 mm	L_c mm	Z	kg	No. of indexable inserts	Type
Cyl. bore DIN 138 longitudinal key way	F2010.B.080.Z06.06.R720M	80	94	27	50	6,5	6	1,3	6	SN . . 1205 . .
	F2010.B.100.Z07.06.R720M	100	114	32	50	6,5	7	1,9	7	
	F2010.B.125.Z08.06.R720M	125	139	40	63	6,5	8	3,6	8	
Cyl. bore DIN 138 longitudinal key way	F2010.B.160.Z10.06.R720M	160	174	40/40 B	63	6,5	10	5,6	10	SN . . 1205 . .
Cyl. bore DIN 138 longitudinal key way	F2010.B.200.Z12.06.R720M	200	214	60/50 B	63	6,5	12	8,3	12	SN . . 1205 . .
	F2010.B.250.Z12.06.R720M	250	264	60/50 B	63	6,5	12	14,8	12	
	F2010.B.250.Z16.06.R720M	250	264	60/50 B	63	6,5	16	14,6	16	
Cyl. bore DIN 138 longitudinal key way	F2010.B.315.Z14.06.R720M	315	329	60/50-60 BB	80	6,5	14	26,3	14	SN . . 1205 . .
	F2010.B.315.Z18.06.R720M	315	329	60/50-60 BB	80	6,5	18	26,2	18	

Bodies and assembly parts are included in the scope of delivery.

Assembly parts

D _c mm		80-315
	Adjusting bolt	FS303 (Torx 20)
	Cartridge for tool body	FR720M
	Clamping screw for cartridge	FS247 (SW 4)
	Tightening torque	8,0 Nm
	Clamping screw for insert	FS1459 (Torx 15 IP)
	Tightening torque	4,0 Nm

Accessories

D _c mm		80-315
	Cartridge for tool body	FR730M
	Finishing insert	XNGX1205ANN-F67*
	ISO 2936 Allen key for cartridge	ISO2936-4 (SW 4)
	Screwdriver for adjusting bolt	FS228 (Torx 20)
	Screwdriver for indexable insert	FS1485 (Torx 15IP)

Indexable inserts

Designation	Radius mm	Face chamfer width mm	P		M		K			N		S		H					
			HC	HC	HC	HC	HC	HW	HC	HC	HC	HC							
			WKP25	WKP35	WKP35S	WSP45	WSM35	WSP45	WAK15	WKK25	WKP25	WKP35	WKP35S	WXN15	WK10	WSM35	WSP45	WHH15	WXM15
SNGX120512-F57	1,2	-	☺	☺	☺	☺	☺	☺		☺	☺	☺	☺			☺	☺		
SNGX1205ANN-D27	-	1,5	☺	☺	☺					☺	☺	☺	☺						
SNGX1205ANN-F27	-	1,5	☺	☺	☺					☺	☺	☺	☺						
SNGX1205ANN-F57	-	1,5	☺	☺	☺	☺	☺	☺		☺	☺	☺	☺			☺	☺		
SNGX1205ANN-F67	-	1,5	☺	☺	☺	☺	☺	☺	☺	☺	☺	☺	☺			☺	☺		
SNHX1205ANN-K88	-	1,5												☺	☺				
SNMX120512-D27	1,2	-	☺	☺	☺					☺	☺	☺	☺						
SNMX120512-F27	1,2	-	☺	☺	☺					☺	☺	☺	☺						
SNMX120512-F57	1,2	-	☺	☺	☺	☺	☺	☺		☺	☺	☺	☺			☺	☺		
SNMX120512-F67	1,2	-	☺	☺	☺	☺	☺	☺	☺	☺	☺	☺	☺			☺	☺		
SNMX120520-D27	2,0	-	☺	☺	☺					☺	☺	☺	☺						
SNMX120520-F57	2,0	-	☺	☺	☺	☺	☺	☺		☺	☺	☺	☺			☺	☺		
SNMX1205ANN-F27	-	1,5	☺	☺	☺					☺	☺	☺	☺						
SNMX1205ANN-F57	-	1,5	☺	☺	☺					☺	☺	☺	☺						
SNMX1205ANN-F67	-	1,5	☺	☺	☺				☺	☺	☺	☺	☺						
XNGX1205ANN-F67*	-	4,7							☺									☺	☺

* Only in combination with SNGX1205ANN.
For roughing / finishing combinations, see page F 312.

HC = Coated carbide
HW = Uncoated carbide

WALTER SELECT

Best insert for:

☺
good

☹
moderate

☹
unfavourable

machining conditions

F 38

G 2

F 302

F 246

Face mill F 2010

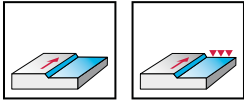
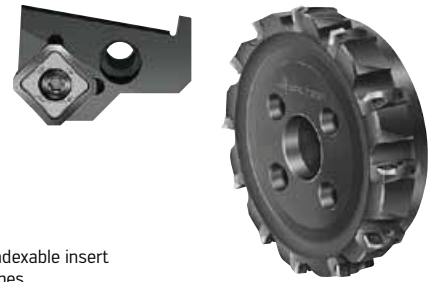

- Approach angle $\kappa = 45^\circ$
- Eight cutting edges per indexable insert
- Negative basic insert shapes
- Axial runout adjustable

Tool	Designation	D_c mm	D_a mm	d_1 mm	l_4 mm	L_c mm	Z	kg	No. of indexable inserts	Type
Cyl. bore DIN 138 longitudinal key way	F2010.B.080.Z06.09.R732M	80	97	27	50	9	6	1,2	6	SN . X1606 . .
	F2010.B.100.Z07.09.R732M	100	117	32	50	9	7	1,9	7	
	F2010.B.125.Z08.09.R732M	125	142	40	63	9	8	3,6	8	
Cyl. bore DIN 138 longitudinal key way	F2010.B.160.Z10.09.R732M	160	177	40/40 B	63	9	10	5,6	10	SN . X1606 . .
Cyl. bore DIN 138 longitudinal key way	F2010.B.200.Z12.09.R732M	200	217	60/50 B	63	9	12	8,3	12	SN . X1606 . .
	F2010.B.250.Z12.09.R732M	250	267	60/50 B	63	9	12	14,8	12	
	F2010.B.250.Z16.09.R732M	250	267	60/50 B	63	9	16	14,6	16	
Cyl. bore DIN 138 longitudinal key way	F2010.B.315.Z14.09.R732M	315	332	60/50-60 BB	63	9	14	26,3	14	SN . X1606 . .
	F2010.B.315.Z18.09.R732M	315	332	60/50-60 BB	63	9	18	26,2	18	

Bodies and assembly parts are included in the scope of delivery.

Assembly parts

		D _c mm	80-315
	Adjusting bolt		FS303 (Torx 20)
	Cartridge for tool body		FR732M
	Clamping screw for cartridge		FS247 (SW 4)
	Tightening torque		8,0 Nm
	Clamping screw for insert		FS2139 (Torx 20 IP)
	Tightening torque		5,0 Nm

Accessories

		D _c mm	80-315
	ISO 2936 Allen key for cartridge		ISO2936-4 (SW 4)
	Screwdriver for adjusting bolt		FS228 (Torx 20)
	Screwdriver for indexable insert		FS1486 (Torx 20IP)

Indexable inserts

Designation	Radius mm	Face chamfer width mm	P		M		K			N		S		H		
			HC		HC		HC			HC	HW	HC	HC			
			WKP25	WKP35	WKP35S	WSP45	WSM35	WSP45	WAK15	WKK25	WKP25	WKP35	WKP35S	WXN15	WK10	WSM35
SNGX1606ANN-D27	-	1,8	☺	☺	☺			☺	☺	☺	☺			☺	☺	
SNGX1606ANN-F27	-	1,8	☺	☺	☺			☺	☺	☺	☺			☺	☺	
SNGX1606ANN-F57	-	1,8	☺	☺	☺			☺	☺	☺	☺			☺	☺	
SNGX1606ANN-F67	-	1,8	☺	☺	☺			☺	☺	☺	☺			☺	☺	
SNMX160620-D27	2,0	-	☺	☺	☺			☺	☺	☺	☺			☺	☺	
SNMX160620-F27	2,0	-	☺	☺	☺			☺	☺	☺	☺			☺	☺	
SNMX160620-F57	2,0	-	☺	☺	☺			☺	☺	☺	☺			☺	☺	
SNMX160620-F67	2,0	-	☺	☺	☺			☺	☺	☺	☺			☺	☺	
SNMX160640-D27	4,0	-	☺	☺	☺			☺	☺	☺	☺			☺	☺	
SNMX160640-F27	4,0	-	☺	☺	☺			☺	☺	☺	☺			☺	☺	
SNMX160640-F57	4,0	-	☺	☺	☺			☺	☺	☺	☺			☺	☺	
SNMX160640-F67	4,0	-	☺	☺	☺			☺	☺	☺	☺			☺	☺	

HC = Coated carbide
HW = Uncoated carbide

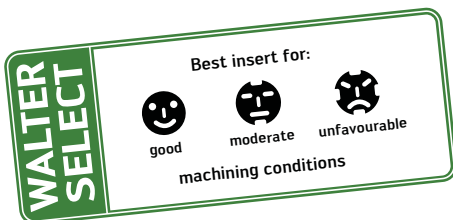

Face mill F 2010

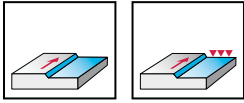
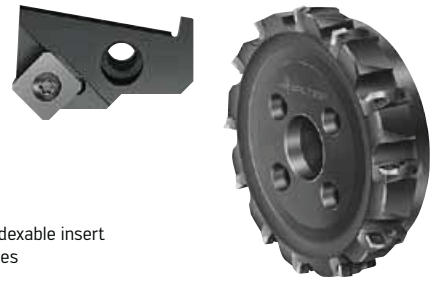

- Approach angle $\kappa = 45^\circ$
- Four cutting edges per indexable insert
- Positive basic insert shapes
- Axial runout adjustable
- Finishing inserts available

Tool	Designation	D _c mm	D _a mm	d ₁ mm	l ₄ mm	L _c mm	Z	kg	No. of indexable inserts	Type
Cyl. bore DIN 138 longitudinal key way	F2010.B.080.Z06.07.R495M	80	94	27	50	7	6	1,2	6	SP...1204...
	F2010.B.100.Z07.07.R495M	100	114	32	50	7	7	1,8	7	
	F2010.B.125.Z08.07.R495M	125	139	40	63	7	8	3,5	8	
Cyl. bore DIN 138 longitudinal key way	F2010.B.160.Z10.07.R495M	160	174	40/40 B	63	7	10	5,5	10	SP...1204...
Cyl. bore DIN 138 longitudinal key way	F2010.B.200.Z12.07.R495M	200	214	60/50 B	63	7	12	8,3	12	SP...1204...
	F2010.B.250.Z12.07.R495M	250	264	60/50 B	63	7	12	14,7	12	
	F2010.B.250.Z16.07.R495M	250	264	60/50 B	63	7	16	14,6	16	
Cyl. bore DIN 138 longitudinal key way	F2010.B.315.Z14.07.R495M	315	329	60/50-60 BB	80	7	14	26,3	14	SP...1204...
	F2010.B.315.Z18.07.R495M	315	329	60/50-60 BB	80	7	18	26,2	18	

Bodies and assembly parts are included in the scope of delivery.

Assembly parts

		D _c mm	80-315
	Adjusting bolt		FS303 (Torx 20)
	Cartridge for tool body		FR495M
	Clamping screw for cartridge		FS247 (SW 4)
	Tightening torque		8,0 Nm
	Clamping screw for insert		FS243 (Torx 20)
	Tightening torque		5,0 Nm

Accessories

		D _c mm	80-315
	Finishing cartridge for tool body		FR448M
	Finishing insert		P2905-1
	ISO 2936 Allen key for cartridge		ISO2936-4 (SW 4)
	Screwdriver for indexable insert and adjusting bolt		FS228 (Torx 20)

Indexable inserts

	Designation	Radius mm	Face chamfer width mm	P				M		K				N		S		H		
				HC	HC	HC	HC	HC	HC	CN	HC	HW	HC	HC	HC					
				WKP25	WKP35	WKP35S	WSP45	WSM35	WSP45	WAK15	WKK25	WKP25	WKP35	WKP35S	WSN10	WXN15	WK10	WSM35	WSP45	WHH15
	SPGT1204AEN-K88	-	1,5																	
	SPKT1204AZN	-	1,4	☺	☺	☺	☺	☺	☺	☺	☺	☺	☺	☺		☺	☺		☺	☺
	SPMT1204AEN	0,5	1,4	☺	☺	☺	☺	☺	☺	☺	☺	☺	☺	☺					☺	☺
	SPMW1204AEN-A57	0,5	1,4	☺	☺	☺				☺	☺	☺	☺							
	SPMW1204AETN-A27	0,5	1,4	☺	☺	☺					☺	☺	☺							

For roughing / finishing combinations, see page F 312.

HC = Coated carbide
 CN = Silicon nitride Si₃N₄
 HW = Uncoated carbide

WALTER SELECT

Best insert for:

☺
good

☹
moderate

☹
unfavourable

machining conditions

Face mill F 2010

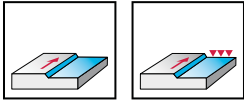
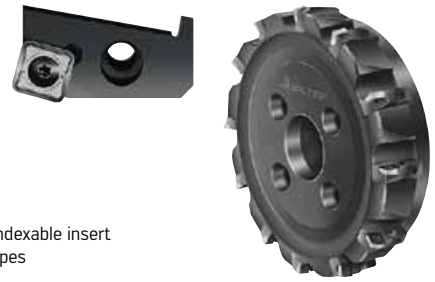

- Approach angle $\kappa = 75^\circ$
- Eight cutting edges per indexable insert
- Negative basic insert shapes
- Axial runout adjustable
- Finishing inserts available

Tool	Designation	D_c mm	D_a mm	d_1 mm	l_4 mm	L_c mm	Z	kg	No. of indexable inserts	Type
Cyl. bore DIN 138 longitudinal key way 	F2010.B.080.Z06.08.R727M	80	86	27	50	8	6	1,2	6	SN .. 1205 ..
	F2010.B.100.Z07.08.R727M	100	106	32	50	8	7	1,8	7	
	F2010.B.125.Z08.08.R727M	125	131	40	63	8	8	3,5	8	
Cyl. bore DIN 138 longitudinal key way 	F2010.B.160.Z10.08.R727M	160	166	40/40 B	63	8	10	5,5	10	SN .. 1205 ..
Cyl. bore DIN 138 longitudinal key way 	F2010.B.200.Z12.08.R727M	200	206	60/50 B	63	8	12	8,2	12	SN .. 1205 ..
	F2010.B.250.Z12.08.R727M	250	256	60/50 B	63	8	12	14,6	12	
	F2010.B.250.Z16.08.R727M	250	256	60/50 B	63	8	16	14,5	16	
Cyl. bore DIN 138 longitudinal key way 	F2010.B.315.Z14.08.R727M	315	321	60/50- 60 BB	80	8	14	26,3	14	SN .. 1205 ..
	F2010.B.315.Z18.08.R727M	315	321	60/50- 60 BB	80	8	18	26,2	18	

Bodies and assembly parts are included in the scope of delivery.

Assembly parts

D _c mm		80-315
	Adjusting bolt	FS303 (Torx 20)
	Cartridge for tool body	FR727M
	Clamping screw for cartridge	FS247 (SW 4)
	Tightening torque	8,0 Nm
	Clamping screw for insert	FS1459 (Torx 15 IP)
	Tightening torque	4,0 Nm

Accessories

D _c mm		80-315
	ISO 2936 Allen key for cartridge	ISO2936-4 (SW 4)
	Screwdriver for adjusting bolt	FS228 (Torx 20)
	Screwdriver for indexable insert	FS1485 (Torx 15IP)

Indexable inserts

Designation	Radius mm	Face chamfer width mm	P				M		K				N		S		H	
			WKP25	WKP35	WKP35S	WSP45	WSM35	WSP45	WAK15	WKK25	WKP25	WKP35	WKP35S	WXN15	WK10	WSM35	WSP45	WHH15
SNGX120512-F57	1,2	-	☺	☺	☹	☹	☹	☹	☹	☹	☹	☹	☹	☹	☹	☹	☹	☹
SNGX1205ENN-F27	0,8	1,2	☺	☺	☹	☹	☹	☹	☹	☹	☹	☹	☹	☹	☹	☹	☹	☹
SNGX1205ENN-F57	0,8	1,2	☺	☺	☹	☹	☹	☹	☹	☹	☹	☹	☹	☹	☹	☹	☹	☹
SNGX1205ENN-F67	0,8	1,2	☺	☺	☹	☹	☹	☹	☹	☹	☹	☹	☹	☹	☹	☹	☹	☹
SNMX120512-D27	1,2	-	☺	☺	☹	☹	☹	☹	☹	☹	☹	☹	☹	☹	☹	☹	☹	☹
SNMX120512-F27	1,2	-	☺	☺	☹	☹	☹	☹	☹	☹	☹	☹	☹	☹	☹	☹	☹	☹
SNMX120512-F57	1,2	-	☺	☺	☹	☹	☹	☹	☹	☹	☹	☹	☹	☹	☹	☹	☹	☹
SNMX120512-F67	1,2	-	☺	☺	☹	☹	☹	☹	☹	☹	☹	☹	☹	☹	☹	☹	☹	☹
SNMX120520-D27	2,0	-	☺	☺	☹	☹	☹	☹	☹	☹	☹	☹	☹	☹	☹	☹	☹	☹
XNGX1205ENN-F67*	-	4,5															☺	☺

* Only in combination with SNGX1205ENN.
For roughing / finishing combinations, see page F 312.

HC = Coated carbide
HW = Uncoated carbide

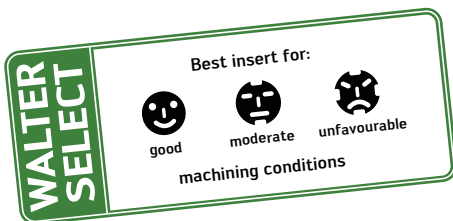

Face mill F 2010

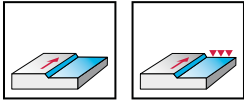
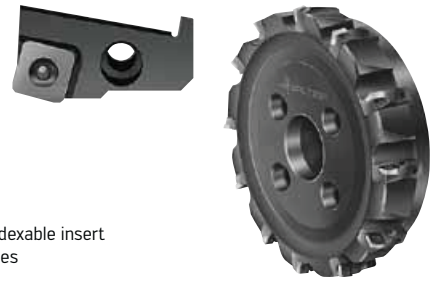

- Approach angle $\kappa = 75^\circ$
- Four cutting edges per indexable insert
- Positive basic insert shapes
- Axial runout adjustable
- Finishing inserts available

Tool	Designation	D_c mm	D_a mm	d_1 mm	l_4 mm	L_c mm	Z	kg	No. of indexable inserts	Type
Cyl. bore DIN 138 longitudinal key way 	F2010.B.080.Z06.10.R441M	80	86	27	50	10	6	1,2	6	SP .. 1204 ..
	F2010.B.100.Z07.10.R441M	100	106	32	50	10	7	1,8	7	
	F2010.B.125.Z08.10.R441M	125	131	40	63	10	8	3,5	8	
Cyl. bore DIN 138 longitudinal key way 	F2010.B.160.Z10.10.R441M	160	166	40/40 B	63	10	10	5,5	10	SP .. 1204 ..
	F2010.B.200.Z12.10.R441M	200	206	60/50 B	63	10	12	8,2	12	SP .. 1204 ..
	F2010.B.250.Z12.10.R441M	250	256	60/50 B	63	10	12	14,6	12	
F2010.B.250.Z16.10.R441M	250	256	60/50 B	63	10	16	14,5	16		
Cyl. bore DIN 138 longitudinal key way 	F2010.B.315.Z14.10.R441M	315	321	60/50- 60 BB	80	10	14	26,2	14	SP .. 1204 ..
	F2010.B.315.Z18.10.R441M	315	321	60/50- 60 BB	80	10	18	26	18	

Bodies and assembly parts are included in the scope of delivery.

Assembly parts

D _c mm		80-315
	Adjusting bolt	FS303 (Torx 20)
	Cartridge for tool body	FR441M
	Clamping screw for cartridge	FS247 (SW 4)
	Tightening torque	8,0 Nm
	Clamping screw for insert	FS243 (Torx 20)
	Tightening torque	5,0 Nm

Accessories

D _c mm		80-315
	Finishing cartridge for tool body	FR448M
	Finishing insert	P2905-1*
	ISO 2936 Allen key for cartridge	ISO2936-4 (SW 4)
	Screwdriver for adjusting bolt	FS228 (Torx 20)

Indexable inserts

Designation	Radius mm	Face chamfer width mm	P				M			K				N		S		H	
			HC				HC			HC				HC	HW	HC		HC	HC
			WKP25	WKP35	WKP35S	WSP45	WSM35	WSP45	WAK15	WKK25	WKP25	WKP35	WKP35S	WSN10	WXN15	WK10	WSM35	WSP45	WHH15
P2901-1R*	-	11										☺							
SPHT120408-G88	0,8	-											☺	☺					
SPHW120416-A57	1,6	-										☺							
SPJW1204EDR	-	1,4	☺	☺	☺														
SPGT1204EDR-F55	-	1,8	☺	☺	☺	☺	☺	☺	☺	☺					☺	☺			
SPMT120408-D51	0,8	-	☺	☺	☺	☺	☺	☺	☺	☺					☺	☺			
SPMT120408-F55	0,8	-	☺	☺	☺	☺	☺	☺	☺	☺					☺	☺			
SPMW120408-A57	0,8	-	☺	☺	☺		☺	☺	☺	☺					☺	☺			
SPMW120408T-A27	0,8	-	☺	☺	☺		☺	☺	☺	☺					☺	☺			

For roughing / finishing combinations, see page F 312.

* Only in combination with SP . . 1204EDR.

HC = Coated carbide

CN = Silicon nitride Si₃N₄

HW = Uncoated carbide

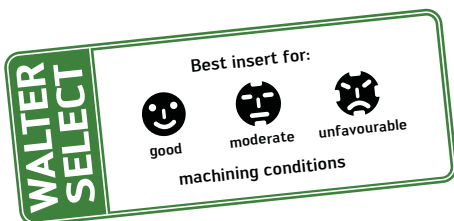

Face mill F 2010

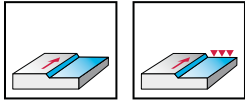
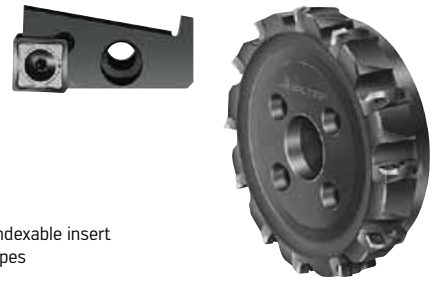

- Approach angle $\kappa = 88^\circ$
- Eight cutting edges per indexable insert
- Negative basic insert shapes
- Axial runout adjustable
- Finishing inserts available

Tool	Designation	D_c mm	D_a mm	d_1 mm	l_4 mm	L_c mm	Z	kg	No. of indexable inserts	Type
Cyl. bore DIN 138 longitudinal key way	F2010.B.080.Z06.10.R728M	80	86	27	50	10	6	1,2	6	SN .. 1205 ..
	F2010.B.100.Z07.10.R728M	100	106	32	50	10	7	1,8	7	
	F2010.B.125.Z08.10.R728M	125	131	40	63	10	8	3,5	8	
Cyl. bore DIN 138 longitudinal key way	F2010.B.160.Z10.10.R728M	160	166	40/40 B	63	10	10	5,5	10	SN .. 1205 ..
Cyl. bore DIN 138 longitudinal key way	F2010.B.200.Z12.10.R728M	200	206	60/50 B	63	10	12	8,2	12	SN .. 1205 ..
	F2010.B.250.Z12.10.R728M	250	256	60/50 B	63	10	12	14,6	12	
	F2010.B.250.Z16.10.R728M	250	256	60/50 B	63	10	16	14,5	16	
Cyl. bore DIN 138 longitudinal key way	F2010.B.315.Z14.10.R728M	315	321	60/50- 60 BB	80	10	14	26,3	14	SN .. 1205 ..
	F2010.B.315.Z18.10.R728M	315	321	60/50- 60 BB	80	10	18	26,2	18	

Bodies and assembly parts are included in the scope of delivery.

Assembly parts

D _c mm		80-315
	Adjusting bolt	FS303 (Torx 20)
	Cartridge for tool body	FR728M
	Clamping screw for cartridge	FS247 (SW 4)
	Tightening torque	8,0 Nm
	Clamping screw for insert	FS1459 (Torx 15 IP)
	Tightening torque	4,0 Nm

Accessories

D _c mm		80-315
	ISO 2936 Allen key for cartridge	ISO2936-4 (SW 4)
	Screwdriver for adjusting bolt	FS228 (Torx 20)
	Screwdriver for indexable insert	FS1485 (Torx 15IP)

Indexable inserts

		Radius mm	Face chamfer width mm	P				M		K				N		S		H	
				HC				HC		HC				HC	HW	HC		HC	HC
				WKP25	WKP35	WKP35S	WSP45	WSM35	WSP45	WAK15	WKK25	WKP25	WKP35	WKP35S	WXN15	WK10	WSM35	WSP45	WHH15
	SNGX120512-F57	1,2	-	☺	☺	☺	☺	☺	☺										
	SNGX1205ZNN-D27	0,8	-	☺															
	SNGX1205ZNN-F27	0,8	1,2	☺	☺	☺													
	SNGX1205ZNN-F57	0,8	1,2	☺	☺	☺													
	SNGX1205ZNN-F67	0,8	1,2	☺	☺	☺													
	SNMX120512-D27	1,2	-	☺	☺	☺													
	SNMX120512-F27	1,2	-	☺	☺	☺													
	SNMX120512-F57	1,2	-	☺	☺	☺													
	SNMX120512-F67	1,2	-	☺	☺	☺													
	SNMX120520-D27	2,0	-	☺	☺	☺													
	XNGX1205ZNN-F67*	-	4,0														☺	☺	

* Only in combination with SNGX1205ZNN.
For roughing / finishing combinations, see page F 312.

HC = Coated carbide
HW = Uncoated carbide

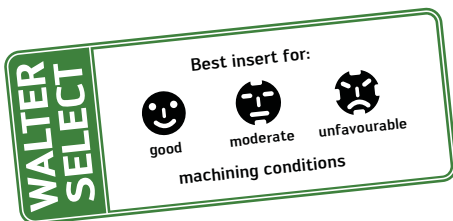

Face mill F 2010

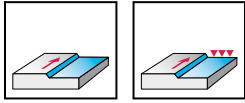
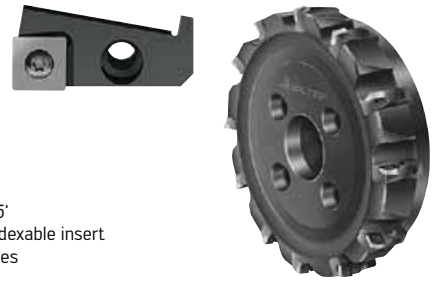

- Approach angle $\kappa = 89^\circ 45'$
- Four cutting edges per indexable insert
- Positive basic insert shapes
- Axial runout adjustable
- Finishing inserts available

Tool	Designation	D _c mm	d ₁ mm	l ₄ mm	L _c mm	Z	kg	No. of indexable inserts	Type
Cyl. bore DIN 138 longitudinal key way	F2010.B.080.Z06.11.R445M	80	27	50	11	6	1,1	6	SP .. 1204 ..
	F2010.B.100.Z07.11.R445M	100	32	50	11	7	1,7	7	
	F2010.B.125.Z08.11.R445M	125	40	63	11	8	3,4	8	
Cyl. bore DIN 138 longitudinal key way	F2010.B.160.Z10.11.R445M	160	40/40 B	63	11	10	5,4	10	SP .. 1204 ..
Cyl. bore DIN 138 longitudinal key way	F2010.B.200.Z12.11.R445M	200	60/50 B	63	11	12	8,1	12	SP .. 1204 ..
	F2010.B.250.Z12.11.R445M	250	60/50 B	63	11	12	14,6	12	
	F2010.B.250.Z16.11.R445M	250	60/50 B	63	11	16	14,4	16	
Cyl. bore DIN 138 longitudinal key way	F2010.B.315.Z14.11.R445M	315	60/50-60 BB	80	11	14	26,1	14	SP .. 1204 ..
	F2010.B.315.Z18.11.R445M	315	60/50-60 BB	80	11	18	25,9	18	

Bodies and assembly parts are included in the scope of delivery.

Assembly parts

D _c mm		80-315
	Adjusting bolt	FS303 (Torx 20)
	Cartridge for tool body	FR445M
	Clamping screw for cartridge	FS247 (SW 4)
	Tightening torque	8,0 Nm
	Clamping screw for insert	FS243 (Torx 20)
	Tightening torque	5,0 Nm

Accessories

D _c mm		80-315
	Finishing cartridge for tool body	FR448M
	Finishing insert	P2905-1
	ISO 2936 Allen key for cartridge	ISO2936-4 (SW 4)
	Screwdriver for adjusting bolt	FS228 (Torx 20)

Indexable inserts

Designation	Radius mm	Face chamfer width mm	P				M		K				N		S		H	
			HC		HC		HC		CN		HC	HW	HC		HC			
			WKP25	WKP35	WKP35S	WSP45	WSM35	WSP45	WAK15	WKK25	WKP25	WKP35	WKP35S	WSN10	WXN15	WK10	WSM35	WSP45
SPHT120408-G88	0,8	-											☺	☺				
SPHW120416-A57	1,6	-										☺						
SPMT120408-D51	0,8	-	☺	☺	☺	☺	☺	☺		☺	☺	☺				☺	☺	
SPMT120408-F55	0,8	-		☺	☺	☺	☺	☺	☺		☺	☺	☺			☺	☺	
SPMW120408-A57	0,8	-	☺	☺	☺			☺		☺	☺	☺						
SPMW120408T-A27	0,8	-	☺	☺	☺					☺	☺	☺						

For roughing / finishing combinations, see page F 312.

HC = Coated carbide
 CN = Silicon nitride Si₃N₄
 HW = Uncoated carbide

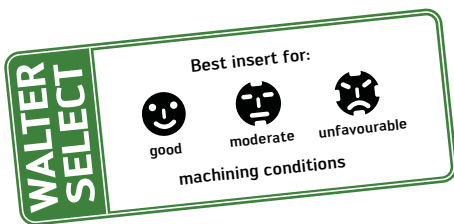

Face mill F 2010

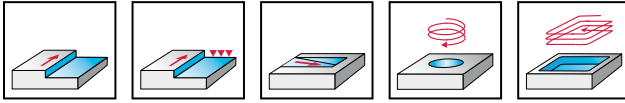
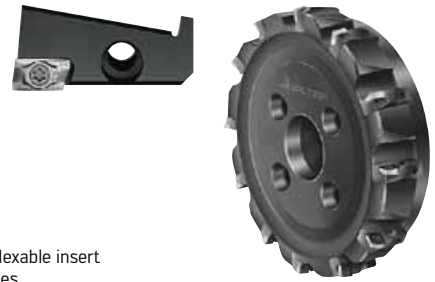

- Approach angle $\kappa = 90^\circ$
- Two cutting edges per indexable insert
- Positive basic insert shapes
- Axial runout adjustable

Tool	Designation	D _c mm	d ₁ mm	l ₄ mm	L _c mm	Z	kg	No. of indexable inserts	Type
Cyl. bore DIN 138 longitudinal key way 	F2010.B.080.Z06.11.R718M	80	27	50	11,7	6	1,2	6	AD . . 1204 . .
	F2010.B.100.Z07.11.R718M	100	32	50	11,7	7	1,7	7	
	F2010.B.125.Z08.11.R718M	125	40	63	11,7	8	3,4	8	
Cyl. bore DIN 138 longitudinal key way 	F2010.B.160.Z10.11.R718M	160	40/40 B	63	11,7	10	5,4	10	AD . . 1204 . .
Cyl. bore DIN 138 longitudinal key way 	F2010.B.200.Z12.11.R718M	200	60/50 B	63	11,7	12	8,1	12	AD . . 1204 . .
	F2010.B.250.Z12.11.R718M	250	60/50 B	63	11,7	12	14,6	12	
	F2010.B.250.Z16.11.R718M	250	60/50 B	63	11,7	16	14,4	16	
Cyl. bore DIN 138 longitudinal key way 	F2010.B.315.Z14.11.R718M	315	60/50-60 BB	80	11	14	26,3	14	AD . . 1204 . .
	F2010.B.315.Z18.11.R718M	315	60/50-60 BB	80	11	18	26,2	18	

Bodies and assembly parts are included in the scope of delivery.

Assembly parts

D _c mm		80-315
	Adjusting bolt	FS303 (Torx 20)
	Cartridge for tool body	FR718M
	Clamping screw for cartridge	FS247 (SW 4)
	Tightening torque	8,0 Nm
	Clamping screw for insert	FS1457 (Torx 9 IP)
	Tightening torque	2,0 Nm

Accessories

D _c mm		80-315
	ISO 2936 Allen key for cartridge	ISO2936-4 (SW 4)
	Screwdriver for adjusting bolt	FS228 (Torx 20)
	Screwdriver for indexable insert	FS1484 (Torx 9IP)

Indexable inserts

	Radius mm	Face chamfer width mm	P		M		K				N		S		H		
			HC		HC		HC				HC	HW	HC		HC		
			WKP25	WKP35	WKP35S	WSP45	WSM35	WSP45	WAK15	WKK25	WKP25	WKP35	WKP35S	WXN15	WK10	WSM35	WSP45
	ADGT120416R-D67	1,6	1,0														
	ADGT120430R-D67	3,0	0,8														
	ADGT1204PER-D51	0,8	1,2														
	ADGT1204PER-D56	0,8	1,2														
	ADGT1204PER-D67	0,8	1,2														
	ADGT1204PER-F56	0,8	1,2														
	ADGT1204PER-G77	0,8	1,2														
	ADHT120416R-G88	1,6	1,0														
	ADHT120425R-G88	2,5	0,8														
	ADHT120430R-G88	3,0	0,8														
	ADHT120440R-G88	4,0	0,4														
	ADHT1204PER-G88	0,8	1,2														
	ADMT120404R-F56	0,4	1,2														
	ADMT120408R-D56	0,8	1,2														
	ADMT120408R-F56	0,8	1,2														
	ADMT120408R-G56	0,8	1,2														
	ADMT120412R-F56	1,2	1,2														
	ADMT120416R-F56	1,6	1,0														
	ADMT120420R-F56	2,0	1,0														
	ADMT120425R-F56	2,5	0,8														
	ADMT120430R-F56	3,0	0,8														
	ADMT120432R-F56	3,2	0,8														
	ADMT120440R-F56	4,0	0,4														

If the corner radius R=2.0 mm or above, the body and the cartridge in the corner section must be reworked:

$$R_{(body)} = R_{(insert)} - 1 \text{ mm}$$

HC = Coated carbide
HW = Uncoated carbide



Face mill F 2010

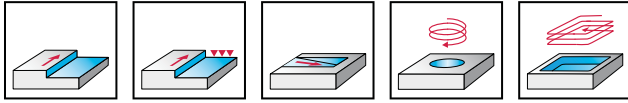
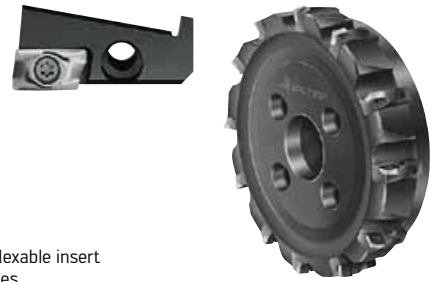

- Approach angle $\kappa = 90^\circ$
- Two cutting edges per indexable insert
- Positive basic insert shapes
- Axial runout adjustable

Tool	Designation	D _c mm	d ₁ mm	l ₄ mm	L _c mm	Z	kg	No. of indexable inserts	Type
Cyl. bore DIN 138 longitudinal key way 	F2010.B.080.Z06.15.R719M	80	27	50	15	6	1,2	6	AD . . 1606 . .
	F2010.B.100.Z07.15.R719M	100	32	50	15	7	1,8	7	
	F2010.B.125.Z08.15.R719M	125	40	63	15	8	3,5	8	
Cyl. bore DIN 138 longitudinal key way 	F2010.B.160.Z10.15.R719M	160	40/40 B	63	15	10	5,5	10	AD . . 1606 . .
Cyl. bore DIN 138 longitudinal key way 	F2010.B.200.Z12.15.R719M	200	60/50 B	63	15	12	8,2	12	AD . . 1606 . .
	F2010.B.250.Z12.15.R719M	250	60/50 B	63	15	12	14,7	12	
	F2010.B.250.Z16.15.R719M	250	60/50 B	63	15	16	14,6	16	
Cyl. bore DIN 138 longitudinal key way 	F2010.B.315.Z14.15.R719M	315	60/50-60 BB	80	15	14	26,3	14	AD . . 1606 . .
	F2010.B.315.Z18.15.R719M	315	60/50-60 BB	80	15	18	26,2	18	

Bodies and assembly parts are included in the scope of delivery.

Assembly parts

D _c mm		80-315
	Adjusting bolt	FS303 (Torx 20)
	Cartridge for tool body	FR719M
	Clamping screw for cartridge	FS247 (SW 4)
	Tightening torque	8,0 Nm
	Clamping screw for insert	FS1453 (Torx 15 IP)
	Tightening torque	3,5 Nm

Accessories

D _c mm		80-315
	ISO 2936 Allen key for cartridge	ISO2936-4 (SW 4)
	Screwdriver for adjusting pin	FS228 (Torx 20)
	Screwdriver for clamping screw	FS1485 (Torx 15IP)

Indexable inserts

	Radius mm	Face chamfer width mm	P		M		K			N		S		H			
			HC		HC		HC			HC	HW	HC	HC				
			WKP25	WKP35	WKP35S	WSP45	WSM35	WSP45	WAK15	WKK25	WKP25	WKP35	WKP35S	WXN15	WK10	WSM35	WSP45
	ADGT1606PER-D51	0,8	1,6	⊕	⊕	⊕	⊕	⊕	⊕	⊕	⊕	⊕	⊕	⊕	⊕	⊕	⊕
	ADGT1606PER-D56	0,8	1,6	⊕	⊕	⊕	⊕	⊕	⊕	⊕	⊕	⊕	⊕	⊕	⊕	⊕	⊕
	ADGT1606PER-F56	0,8	1,6	⊕	⊕	⊕	⊕	⊕	⊕	⊕	⊕	⊕	⊕	⊕	⊕	⊕	⊕
	ADHT160616R-G88	1,6	1,4	⊕	⊕	⊕	⊕	⊕	⊕	⊕	⊕	⊕	⊕	⊕	⊕	⊕	⊕
	ADHT160625R-G88	2,5	1,2	⊕	⊕	⊕	⊕	⊕	⊕	⊕	⊕	⊕	⊕	⊕	⊕	⊕	⊕
	ADHT160630R-G88	3,0	1,2	⊕	⊕	⊕	⊕	⊕	⊕	⊕	⊕	⊕	⊕	⊕	⊕	⊕	⊕
	ADHT160640R-G88	4,0	1,0	⊕	⊕	⊕	⊕	⊕	⊕	⊕	⊕	⊕	⊕	⊕	⊕	⊕	⊕
	ADHT1606PER-G88	0,8	1,6	⊕	⊕	⊕	⊕	⊕	⊕	⊕	⊕	⊕	⊕	⊕	⊕	⊕	⊕
	ADKT1606PER-F56	0,8	1,6	⊕	⊕	⊕	⊕	⊕	⊕	⊕	⊕	⊕	⊕	⊕	⊕	⊕	⊕
	ADMT160608R-D56	0,8	1,6	⊕	⊕	⊕	⊕	⊕	⊕	⊕	⊕	⊕	⊕	⊕	⊕	⊕	⊕
	ADMT160608R-F56	0,8	1,6	⊕	⊕	⊕	⊕	⊕	⊕	⊕	⊕	⊕	⊕	⊕	⊕	⊕	⊕
	ADMT160608R-G56	0,8	1,6	⊕	⊕	⊕	⊕	⊕	⊕	⊕	⊕	⊕	⊕	⊕	⊕	⊕	⊕
	ADMT160612R-F56	1,2	1,6	⊕	⊕	⊕	⊕	⊕	⊕	⊕	⊕	⊕	⊕	⊕	⊕	⊕	⊕
	ADMT160616R-F56	1,6	1,4	⊕	⊕	⊕	⊕	⊕	⊕	⊕	⊕	⊕	⊕	⊕	⊕	⊕	⊕
	ADMT160620R-F56	2,0	1,4	⊕	⊕	⊕	⊕	⊕	⊕	⊕	⊕	⊕	⊕	⊕	⊕	⊕	⊕
	ADMT160625R-F56	2,5	1,2	⊕	⊕	⊕	⊕	⊕	⊕	⊕	⊕	⊕	⊕	⊕	⊕	⊕	⊕
	ADMT160630R-F56	3,0	1,2	⊕	⊕	⊕	⊕	⊕	⊕	⊕	⊕	⊕	⊕	⊕	⊕	⊕	⊕
	ADMT160632R-F56	3,2	1,2	⊕	⊕	⊕	⊕	⊕	⊕	⊕	⊕	⊕	⊕	⊕	⊕	⊕	⊕
	ADMT160640R-F56	4,0	1,0	⊕	⊕	⊕	⊕	⊕	⊕	⊕	⊕	⊕	⊕	⊕	⊕	⊕	⊕
	ADMT160650R-F56	5,0	-	⊕	⊕	⊕	⊕	⊕	⊕	⊕	⊕	⊕	⊕	⊕	⊕	⊕	⊕
	ADMT160660R-F56	6,0	-	⊕	⊕	⊕	⊕	⊕	⊕	⊕	⊕	⊕	⊕	⊕	⊕	⊕	⊕

From corner radius R=2.0 mm, the body and cartridge must be reworked in the corner area.
 $R_{(body)} = R_{(insert)} - 1 \text{ mm}$

HC = Coated carbide
 HW = Uncoated carbide

WALTER SELECT

Best insert for:

good

moderate

unfavourable

machining conditions

F 12

G 2

F 302

F 246

Face mill F 2010

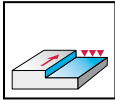
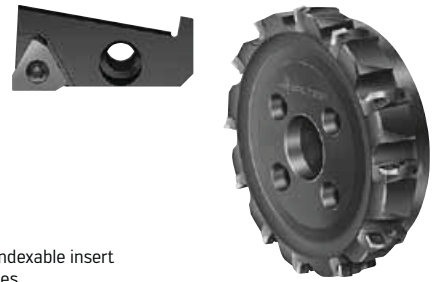

- Approach angle $\kappa = 90^\circ$
- Three cutting edges per indexable insert
- Positive basic insert shapes
- Axial runout adjustable

Tool	Designation	D _c mm	d ₁ mm	l ₄ mm	L _c mm	Z	kg	No. of indexable inserts	Type
Cyl. bore DIN 138 longitudinal key way 	F2010.B.080.Z06.09.R500M	80	27	50	9	6	1,1	6	P 2903 - 2R
	F2010.B.100.Z07.09.R500M	100	32	50	9	7	1,7	7	
	F2010.B.125.Z08.09.R500M	125	40	63	9	8	3,3	8	
Cyl. bore DIN 138 longitudinal key way 	F2010.B.160.Z10.09.R500M	160	40/40 B	63	9	10	5,3	10	P 2903 - 2R
Cyl. bore DIN 138 longitudinal key way 	F2010.B.200.Z12.09.R500M	200	60/50 B	63	9	12	7,9	12	P 2903 - 2R
	F2010.B.250.Z12.09.R500M	250	60/50 B	63	9	12	14,6	12	
	F2010.B.250.Z16.09.R500M	250	60/50 B	63	9	16	14,4	16	
Cyl. bore DIN 138 longitudinal key way 	F2010.B.315.Z14.09.R500M	315	60/50-60 BB	80	9	14	26,1	14	P 2903 - 2R
	F2010.B.315.Z18.09.R500M	315	60/50-60 BB	80	9	18	26	18	

Bodies and assembly parts are included in the scope of delivery.

Assembly parts

D _c mm		80-315
	Adjusting bolt	FS303 (Torx 20)
	Cartridge for tool body	FR500M
	Clamping screw for cartridge	FS247 (SW 4)
	Tightening torque	8,0 Nm
	Clamping screw for insert	FS244 (Torx 15)
	Tightening torque	3,0 Nm

Accessories

D _c mm		80-315
	ISO 2936 Allen key for cartridge	ISO2936-4 (SW 4)
	Screwdriver for adjusting bolt	FS228 (Torx 20)
	Screwdriver for clamping screw	FS229 (Torx 15)

Indexable inserts

	Radius mm	Face chamfer width mm	P				M		K				N		S		H		
			HC				HC		HC				HC HW		HC		HC		
			WKP25	WKP35	WKP35S	WSP45	WSM35	WSP45	WAK15	WKK25	WKP25	WKP35	WKP35S	WXN15	WK10	WSM35	WSP45	WHH15	WXM15
	P2903-2R	-	3,5					☺						☺				☺	☺

HC = Coated carbide
HW = Uncoated carbide

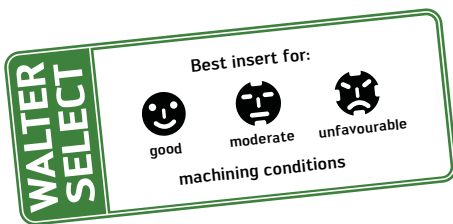

Face mill F 2010

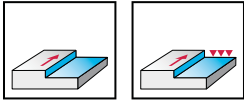

- Approach angle $\kappa = 90^\circ$
- Four cutting edges per indexable insert
- Negative basic insert shapes
- Axial runout adjustable

Tool	Designation	D _c mm	d ₁ mm	l ₄ mm	L _c mm	Z	kg	No. of indexable inserts	Type
Cyl. bore DIN 138 longitudinal key way 	F2010.B.080.Z06.13.R722M	80	27	50	13	6	1,2	6	LN .. 1307 ..
	F2010.B.100.Z07.13.R722M	100	32	50	13	7	1,8	7	
	F2010.B.125.Z08.13.R722M	125	40	63	13	8	3,5	8	
Cyl. bore DIN 138 longitudinal key way 	F2010.B.160.Z10.13.R722M	160	40/40 B	63	13	10	5,5	10	LN .. 1307 ..
Cyl. bore DIN 138 longitudinal key way 	F2010.B.200.Z12.13.R722M	200	60/50 B	63	13	12	8,2	12	LN .. 1307 ..
	F2010.B.250.Z12.13.R722M	250	60/50 B	63	13	12	14,6	12	
	F2010.B.250.Z16.13.R722M	250	60/50 B	63	13	16	14,5	16	
Cyl. bore DIN 138 longitudinal key way 	F2010.B.315.Z14.13.R722M	315	60/50-60 BB	80	13	14	26,3	14	LN .. 1307 ..
	F2010.B.315.Z18.13.R722M	315	60/50-60 BB	80	13	18	26,2	18	

Bodies and assembly parts are included in the scope of delivery.

Assembly parts

D _c mm		80-315
	Adjusting bolt	FS303 (Torx 20)
	Cartridge for tool body	FR722M
	Clamping screw for cartridge	FS247 (SW 4)
	Tightening torque	8,0 Nm
	Clamping screw for insert	FS1458 (Torx 15IP)
	Tightening torque	2,5 Nm

Accessories

D _c mm		80-315
	ISO 2936 Allen key for cartridge	ISO2936-4 (SW 4)
	Screwdriver for adjusting bolt	FS228 (Torx 20)
	Screwdriver for indexable insert	FS1485 (Torx 15IP)

Indexable inserts

	Radius mm	Face chamfer width mm	P				M		K				N		S		H	
			HC	HC	HC	HC	HC	HC	HC	HW	HC	HW	HC	HC				
			WKP25	WKP35	WKP35S	WSP45	WSM35	WSP45	WAK15	WKK25	WKP25	WKP35	WKP35S	WXN15	WK10	WSM35	WSP45	WHH15
	LNGX130708R-L55	0,8	1,2	☺	☺	☺	☺	☺	☺	☺	☺	☺	☺	☺	☺	☺	☺	
	LNGX130708R-L88	0,8	1,2											☺	☺			
	LNGX130712R-L55	1,2	1,0	☺	☺	☺	☺	☺			☺	☺	☺			☺	☺	
	LNGX130712R-L88	1,2	1,0											☺	☺			
	LNGX130716R-L55	1,6	0,9	☺	☺	☺	☺	☺			☺	☺	☺			☺	☺	
	LNGX130716R-L88	1,6	0,9											☺	☺			
	LNGX130720R-L55	2,0	0,7	☺	☺	☺	☺	☺			☺	☺	☺			☺	☺	
	LNGX130720R-L88	2,0	0,7											☺	☺			
	LNGX130725R-L55	2,5	0,6	☺	☺	☺	☺	☺			☺	☺	☺			☺	☺	
	LNGX130725R-L88	2,5	0,6											☺	☺			
	LNGX130730R-L55	3,0	0,7	☺	☺	☺	☺	☺			☺	☺	☺			☺	☺	
	LNGX130730R-L88	3,0	0,7											☺	☺			

From corner radius R=2.0 mm, the body and cartridge must be reworked in the corner area.

$$R_{(body)} = R_{(insert)}$$

HC = Coated carbide

HW = Uncoated carbide

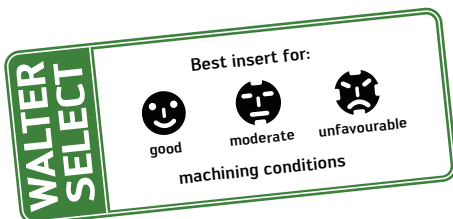

Face mill F 2010

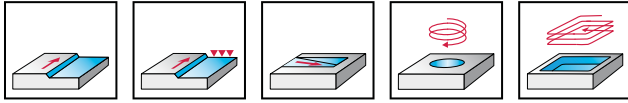
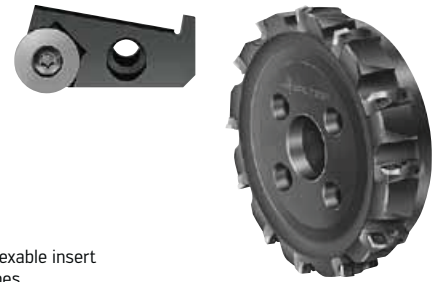

- Six cutting edges per indexable insert
- Positive basic insert shapes
- Axial runout adjustable

Tool	Designation	D _c mm	D _a mm	d ₁ mm	l ₄ mm	L _c mm	Z	kg	No. of indexable inserts	Type
Cyl. bore DIN 138 longitudinal key way 	F2010.B.080.Z06.08.R723M	67	83	27	50	8	6	1,2	6	RO . X 1605 . .
	F2010.B.100.Z07.08.R723M	87	103	32	50	8	7	1,2	7	
	F2010.B.125.Z08.08.R723M	112	128	40	63	8	8	3,5	8	
Cyl. bore DIN 138 longitudinal key way 	F2010.B.160.Z10.08.R723M	147	163	40/40 B	63	8	10	5,5	10	RO . X 1605 . .
Cyl. bore DIN 138 longitudinal key way 	F2010.B.200.Z12.08.R723M	187	203	60/50 B	63	8	12	8,2	12	RO . X 1605 . .
	F2010.B.250.Z12.08.R723M	237	253	60/50 B	63	8	12	14,7	12	
	F2010.B.250.Z16.08.R723M	237	253	60/50 B	63	8	16	14,5	16	
Cyl. bore DIN 138 longitudinal key way 	F2010.B.315.Z14.08.R723M	302	318	60/50- 60 BB	80	8	14	26,3	14	RO . X 1605 . .
	F2010.B.315.Z18.08.R723M	302	318	60/50- 60 BB	80	8	18	26,2	18	

Bodies and assembly parts are included in the scope of delivery.

Assembly parts

D _c mm		67-302
	Adjusting bolt	FS303 (Torx 20)
	Cartridge for tool body	FR723M
	Clamping screw for cartridge	FS247 (SW 4)
	Tightening torque	8,0 Nm
	Clamping screw for insert	FS1030 (Torx 20)
	Tightening torque	5,0 Nm

Accessories

D _c mm		67-302
	ISO 2936 Allen key for cartridge	ISO2936-4 (SW 4)
	Screwdriver for indexable insert and adjusting bolt	FS228 (Torx 20)

Indexable inserts

	Radius mm	P		M		K			N		S		H				
		HC		HC		HC			HC	HW	HC		HC				
		WKP25	WKP35	WKP35S	WSP45	WSM35	WSP45	WAK15	WKK25	WKP25	WKP35	WKP35S	WXN15	WK10	WSM35	WSP45	WHH15
	ROGX1605M0-G77																
	ROHX1605M0-D57	⊕	⊕	⊕	⊕	⊕								⊕	⊕		
	ROHX1605M0-D67		⊕	⊕	⊕	⊕								⊕	⊕		
	ROHX1605M0T-A27	⊕	⊕	⊕					⊕	⊕	⊕						
	ROMX1605M0-D57		⊕	⊕	⊕	⊕								⊕	⊕		

HC = Coated carbide
HW = Uncoated carbide

WALTER SELECT

Best insert for:

good

moderate

unfavourable

machining conditions

Octagon close pitch cutter F 2146

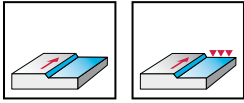

- Approach angle $\kappa = 43^\circ$
- Eight cutting edges per indexable insert
- Positive basic insert shapes
- Finishing cutting edges adjustable
- Finishing inserts available

Tool	Designation	D_c mm	d_1 mm	l_4 mm	L_c mm	L_{c2} mm	Z^1	kg	No. of indexable inserts	Type
Cyl. bore DIN 138 longitudinal key way	F2146.B27.080.Z10.R599	80	27	50	3	8	8 + 2	1,3	10	OP . . 0504 . .
	F2146.B27.080.Z10.R683 ¹	80	27	50	3	8	8 + 2	1,3	10	
Cyl. bore DIN 138 longitudinal key way	F2146.B32.100.Z12.R599	100	32	50	3	8	10 + 2	2,0	12	OP . . 0504 . .
	F2146.B32.100.Z12.R683 ¹	100	32	50	3	8	10 + 2	2,0	12	
	F2146.B40.125.Z15.R599	125	40	63	3	8	12 + 3	3,9	15	
	F2146.B40.125.Z15.R683 ¹	125	40	63	3	8	12 + 3	3,9	15	
Cyl. bore DIN 138 longitudinal key way	F2146.B40.160.Z22.R599	160	40/40 B	63	3	8	18 + 4	6,2	22	OP . . 0504 . .
	F2146.B40.160.Z22.R683 ¹	160	40/40 B	63	3	8	18 + 4	6,2	22	
	F2146.B60.200.Z28.R599	200	60/50 B	63	3	8	24 + 4	9,5	28	
	F2146.B60.200.Z28.R683 ¹	200	60/50 B	63	3	8	24 + 4	9,5	28	
	F2146.B60.250.Z36.R599	250	60/50 B	63	3	8	30 + 6	15	36	
	F2146.B60.250.Z36.R683 ¹	250	60/50 B	63	3	8	30 + 6	15	36	

Outside diameter $D_a = D_c + 10$ mm.

* $Z = 8+2 \rightarrow$ 8 roughing inserts + 2 axially adjustable finishing cutting edges with finishing cartridge.

Bodies and assembly parts are included in the scope of delivery.

For information on high-speed applications, see page F 310.

¹ These tools are fitted with a finishing cartridge (FR683).

Only use OPHX0504ZZN indexable inserts.

Assembly parts

		D _c mm	80-250
	Finishing cartridge K=43°		FR599
	Finishing cartridge K=45°		FR683
	Eccentric pin for finishing cartridge		FS1130 (SW 3)
	Tension spring		FS1099
	Clamping wedge for insert		FK281
	Clamping wedge for adjustable indexable insert		FR600
	Clamping screw for finishing cartridge		FS1149 (SW 4)
	Tightening torque		6,5 Nm
	Clamping screw for clamping wedge		FS746 (Torx 15IP)
	Tightening torque		6,5 Nm

* Indexable insert for finishing cartridge FR683 OPHX0504ZZN...

Accessories

		D _c mm	80-250
	Torque T-handle for interchangeable blade		FS2041
	ISO 2936-4 Allen key for finishing cartridge		ISO2936-4 (SW 4)
	Key for eccentric pin		FS227 (SW 3)
	Interchangeable blade		FS2047 (Torx 15IP)

Indexable inserts

	Designation	Radius mm	Face chamfer width mm	P		M		K				N		S		H		HC
				HC	HC	HC	HC	CN	BH	HC	HW	HC	HW	HC	HW	HC	HW	
	OPHN050412-A57	1,2	-															
	OPHN0504ZZN-A27	0,4	1,2															
	OPHN0504ZZN-A57	0,4	1,2	☺	☺			☺		☺	☺							
	OPHR0504ZZN-F57	0,4	1,2	☺						☺								
	OPHX0504ZZN-A57	0,4	5,0					☺									☺	☺
	OPHX0504ZZN-A88	1,0	5,0					☺									☺	☺
	OPHX0504ZZR-A27	1,8	7,8									☺						
	OPHX0504ZZR-A57	1,8	7,8					☺									☺	☺

For roughing / finishing combinations, see page F 312.

HC = Coated carbide
 CN = Silicon nitride Si₃N₄
 BH = CBN with high CBN content
 HW = Uncoated carbide

WALTER SELECT

Best insert for:

☺
good

☹
moderate

☹☹
unfavourable

machining conditions

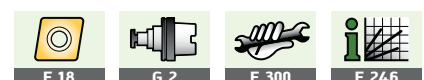

Mini KW face mill F 2233 SD .. 09T3

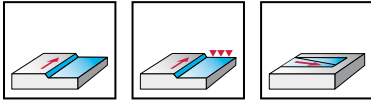

- Approach angle $\kappa = 45^\circ$
- Four cutting edges per indexable insert
- Positive basic insert shapes

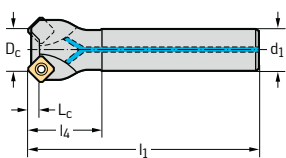
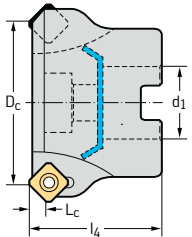
Tool	Designation	D _c mm	d ₁ mm	l ₄ mm	L _c mm	l ₁ mm	Z	kg	No. of indexable inserts	Type
Cylindrical shank 	F2233.Z20.020.Z02.05	20	20	35	5	110	2	0,3	2	SD .. 09T3 ..
	F2233.Z20.025.Z03.05	25	20	35	5	110	3	0,3	3	
	F2233.Z20.032.Z04.05	32	20	35	5	110	4	0,3	4	
Cyl. bore DIN 138 longitudinal key way 	F2233.B.032.Z03.05	32	16	40	5		3	0,2	3	SD .. 09T3 ..
	F2233.B.032.Z04.05	32	16	40	5		4	0,2	4	
	F2233.B.032.Z05.05	32	16	40	5		5	0,2	5	
	F2233.B.040.Z03.05	40	22	40	5		3	0,3	3	
	F2233.B.040.Z04.05	40	22	40	5		4	0,3	4	
	F2233.B.040.Z06.05	40	22	40	5		6	0,3	6	
	F2233.B.050.Z04.05	50	22	40	5		4	0,4	4	
	F2233.B.050.Z05.05	50	22	40	5		5	0,4	5	
	F2233.B.050.Z08.05	50	22	40	5		8	0,4	8	
	F2233.B.063.Z05.05	63	22	40	5		5	0,6	5	
	F2233.B.063.Z06.05	63	22	40	5		6	0,6	6	
	F2233.B.063.Z10.05	63	22	40	5		10	0,6	10	
	F2233.B.080.Z06.05	80	27	50	5		6	1,2	6	
	F2233.B.080.Z07.05	80	27	50	5		7	1,2	7	
	F2233.B.080.Z12.05	80	27	50	5		12	1,2	12	
	F2233.B.100.Z07.05	100	32	50	5		7	1,8	7	
	F2233.B.100.Z08.05	100	32	50	5		8	1,9	8	
	F2233.B.100.Z14.05	100	32	50	5		14	2,0	14	

Bodies and assembly parts are included in the scope of delivery.

Assembly parts

	D _c mm	20-100
	Clamping screw for insert	FS359 (Torx 15)
	Tightening torque	2,5 Nm

Accessories

	D _c mm	20-100
	Screwdriver	FS229 (Torx 15)

Indexable inserts

Designation	Radius mm	Face chamfer width mm	P				M		K				N		S		H
			HC				HC		HC				CN	HC	HW	HC	HC
			WKP25	WKP35	WKP35S	WSP45	WSM35	WSP45	WAK15	WKK25	WKP25	WKP35	WKP35S	WSN10	WXN15	WK10	WSM35
SDGT09T3AEN-F57	0,3	1,2	☺	☺	☺	☺	☺			☺	☺						
SDGT09T3AEN-G88	0,3	1,2										☺	☺				
SDHW09T312-A57	1,2	-										☺					
SDHW09T3AEN-A57	0,3	1,2	☺	☺	☺		☺		☺	☺	☺						
SDMT09T3AEN-D57	0,5	1,2	☺	☺	☺	☺			☺	☺	☺					☺	☺
SDMW09T3AEN-A57	0,5	1,2	☺	☺	☺		☺		☺	☺	☺						
SDMW09T3AETN-A27	0,5	1,2	☺	☺	☺				☺	☺	☺						

HC = Coated carbide
 CN = Silicon nitride Si₃N₄
 HW = Uncoated carbide

WALTER SELECT

Best insert for:

☺
good

☹
moderate

☹
unfavourable

machining conditions

Mini KW face mill F 2233 SP . . 1204

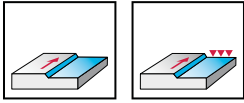

- Approach angle $\kappa = 45^\circ$
- Four cutting edges per indexable insert
- Positive basic insert shapes

Tool	Designation	D _c mm	d ₁ mm	l ₄ mm	L _c mm	l ₁ mm	Z	kg	No. of indexable inserts	Type
Shank DIN 1835-B 	F2233.W.025.Z02.07	25	25	38	7	95	2	0,4	2	SP . . 1204 . .
	F2233.W.032.Z03.07	32	32	44	7	105	3	0,6	3	
	F2233.W.040.Z04.07	40	32	44	7	105	4	0,7	4	
Cyl. bore DIN 138 longitudinal key way 	F2233.B.040.Z03.07	40	16	40	7		3	0,3	3	SP . . 1204 . .
	F2233.B.050.Z04.07	50	22	40	7		4	0,4	4	
	F2233.B.063.Z05.07	63	22	40	7		5	0,6	5	
	F2233.B.080.Z06.07	80	27	50	7		6	1,1	6	
	F2233.B.100.Z07.07	100	32	50	7		7	2,0	7	
	F2233.B.125.Z08.07	125	40	63	7		8	3,8	8	
Cyl. bore DIN 138 longitudinal key way 	F2233.B.160.Z09.07	160	40/40 B	63	7		9	5,5	9	SP . . 1204 . .

Bodies and assembly parts are included in the scope of delivery.

Assembly parts

	D _c mm	25-160
	Clamping screw for insert	FS1030 (Torx 20)

Accessories

	D _c mm	25-125	160
	Gasket		O-R 96X4
	Sealing disc set, complete (incl. gasket and screws)		FS936 COMPLETE SET
	Screwdriver	FS228 (Torx 20)	FS228 (Torx 20)

Indexable inserts

	Radius mm	Face chamfer width mm	P				M		K				N			S		H	
			HC				HC		HC					CN	HC	HW	HC	HC	
			WKP 25	WKP 35	WKP 35S	WSP 45	WSM 35	WSP 45	WAK 15	WKK 25	WKP 25	WKP 35	WKP 35S	WSN 10	WXN 15	WK 10	WSM 35	WSP 45	WHH 15
SPGT1204AEN-K88	-	1,5													☺	☺			
SPHW120416-A57	1,6	-												☺					
SPKT1204AZN	-	1,4	☺	☺	☺	☺	☺	☺	☺		☺	☺	☺				☺	☺	
SPMT1204AEN	0,5	1,4	☺	☺	☺	☺	☺	☺	☺		☺	☺	☺				☺	☺	
SPKT1204AZN	-	1,4	☺	☺	☺	☺	☺	☺	☺		☺	☺	☺				☺	☺	
SPMW1204AEN-A57	0,5	1,4	☺	☺	☺				☺		☺	☺	☺						
SPMW1204AETN-A27	0,5	1,4	☺	☺	☺						☺	☺	☺						

HC = Coated carbide
 CN = Silicon nitride Si₃N₄
 HW = Uncoated carbide

WALTER SELECT

Best insert for:

☺
good

☹
moderate

☹
unfavourable

machining conditions

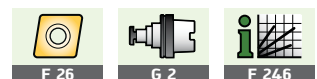

Face mill F 2235

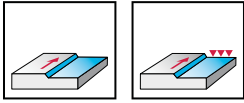
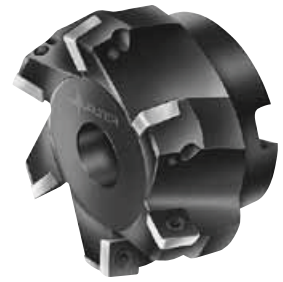

- Approach angle $\kappa = 75^\circ$
- Four cutting edges per indexable insert
- Positive basic insert shapes
- Finishing inserts available

Tool	Designation	D_c mm	d_1 mm	l_4 mm	L_c mm	l_1 mm	Z	kg	No. of indexable inserts	Type
Shank DIN 1835-B 	F2235.W.032.Z02.10	32	32	49	10	110	2	0,7	2	SP .. 1204 ..
	F2235.W.040.Z03.10	40	32	49	10	110	3	0,8	3	
Cyl. bore DIN 138 longitudinal key way 	F2235.B.050.Z04.10	50	22	40	10		4	0,4	4	SP .. 1204 ..
	F2235.B.063.Z05.10	63	22	40	10		5	0,6	5	
	F2235.B.080.Z06.10	80	27	50	10		6	1,2	6	
Cyl. bore DIN 138 longitudinal key way 	F2235.B.100.Z07.10	100	32	50	10		7	2,0	7	SP .. 1204 ..

Bodies and assembly parts are included in the scope of delivery.

Assembly parts

	D _c mm	32-100
	Clamping screw for insert	FS1030 (Torx 20)
	Tightening torque	5,0 Nm

Accessories

	D _c mm	32-100
	Screwdriver	FS228 (Torx 20)

Indexable inserts

	Radius mm	Face chamfer width mm	P				M		K				N		S		H		
			HC				HC		HC				CN	HC	HW	HC		HC	HC
			WKP25	WKP35	WKP35S	WSP45	WSM35	WSP45	WAK15	WKK25	WKP25	WKP35	WKP35S	WSN10	WXN15	WK10	WSM35	WSP45	WHH15
	P2901-1R*	-	11																
	SPHT120408-G88	0,8	-																
	SPHW120416-A57	1,6	-																
	SPJW1204EDR	-	1,4																
	SPGT1204EDR-F55	0,5	1,25																
	SPMT120408-D51	0,8																	
	SPMT120408-F55	0,8																	
	SPMW120408-A57	0,8																	
	SPMW120408T-A27	0,8																	

* Only in combination with SP..1204EDR...
For roughing / finishing combinations, see page F 312.

HC = Coated carbide
CN = Silicon nitride Si₃N₄
HW = Uncoated carbide

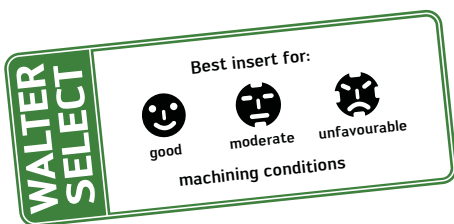

Light alloy milling cutter F 2250



- Approach angle $\kappa = 75^\circ + 90^\circ*$
- One cutting edge per indexable insert
- Positive basic insert shapes
- Axial runout adjustable
- For aluminium machining
- Finishing inserts available

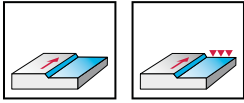

Tool	Designation	D _c mm	d ₁ mm	l ₄ mm	L _c mm	Z	kg	No. of indexable inserts	Type
Cyl. bore	F2250.B22.063.Z05.03	63	22	40	3/4	5	0,4	5	SP . . 1204 . .
DIN 138 longitudinal key way	F2250.B27.080.Z06.03	80	27	50	3/4	6	0,8	6	
	F2250.B32.100.Z07.03	100	32	50	3/4	7	0,9	7	

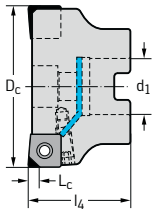

Bodies and assembly parts are included in the scope of delivery.

Pre-balanced to G 16 for n = 10000 rpm

* Approach angle $\kappa = 75^\circ$ (EDR) / $\kappa = 90^\circ$ (PDR)

For information on high-speed applications, see page F 310.

Assembly parts

D _c mm		63-100
	Countersunk screw	FS1148 (SW 2,5)
	Clamping screw for insert	FS1030 (Torx 20)
	Tightening torque	5,0 Nm
	Balancing screw	FS1145 (SW 2,5)

Accessories

D _c mm		63-100
	ISO 2936 Allen key for counter-sunk screw and balancing screw	ISO2936-2,5 (SW 2,5)
	Screwdriver	FS228 (Torx 20)

Indexable inserts

Designation	a _p max mm	Face chamfer width mm	P				M		K				N			S		H		
			WC	HC	DP	DP	WC	HC	DP	DP	WC	HC	DP	WC	HC	DP	WC	HC		
SPHW1204EDR-A88	3	1,5	WKP25	WKP35	WKP35S	WSP45	WSM35	WSP45	WAK15	WKK25	WKP25	WKP35	WKP35S	WXN15	WK10	WCD10	WSM35	WSP45	WHH15	
SPHW1204PDR-A88	4	1,5																		
SPHX1204PDR-A88*	0,5	3,5																		

* Only in combination with SPHW1204PDR-A88.
For roughing / finishing combinations, see page F 312.

HC = Coated carbide
HW = Uncoated carbide
DP = polycrystalline diamond

WALTER SELECT

Best insert for:

good

moderate

unfavourable

machining conditions

Light alloy milling cutter F 2250

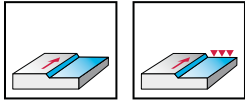

- Approach angle $\kappa = 75^\circ + 90^\circ*$
- One cutting edge per indexable insert
- Positive basic insert shapes
- Axial runout adjustable
- For aluminium machining
- Finishing inserts available

Tool	Designation	D _C mm	d ₁ mm	l ₄ mm	L _C mm	Z	kg	No. of indexable inserts	Type
Cyl. bore DIN 138 longitudinal key way	F2250.B.080.Z06.03.R594	80	27	63	3	6	1,1	6	SP .. 1204 ..
	F2250.B.100.Z07.03.R594	100	32	63	3	7	1,8	7	
Cyl. bore DIN 138 longitudinal key way	F2250.B.125.Z08.03.R594	125	40	63	3	8	1,2	8	SP .. 1204 ..
Cyl. bore DIN 138 longitudinal key way	F2250.B.160.Z10.03.R594	160	40/40 B	63	3	10	1,9	10	SP .. 1204 ..
Cyl. bore DIN 138 longitudinal key way	F2250.B.200.Z12.03.R594	200	60/50 B	63	3	12	4,1	12	SP .. 1204 ..

Bodies and assembly parts are included in the scope of delivery.

Pre-balanced to G 16 for n = 10000 rpm

For information on high-speed applications, see page F 310.

D_C 80-100 mm = steel basic body

D_C 125-200 mm = basic body made of high-tensile aluminium

* Approach angle $\kappa = 75^\circ$ (EDR) / $\kappa = 90^\circ$ (PDR)

Assembly parts

D _c mm	80-100	125-200
	FS1131	FS1131
	FR594	FR594
	FS1100	FS1100
	FS1146	FS1147
	14,0 Nm	14,0 Nm
	FS1030 (Torx 20)	FS1030 (Torx 20)
	5,0 Nm	5,0 Nm
	FS1145 (SW 2,5)	FS1145 (SW 2,5)

Accessories

D _c mm	80-200
	FR595
	SPHX1204PDR-A88*
	ISO2936-5 (SW 5) ISO2936-2,5 (SW 2,5)
	FS228 (Torx 20)

Indexable inserts

Designation	a _p max mm	Face chamfer width mm	P				M		K				N			S		H	
			HC	HC	HC	HC	HC	HC	HC	HC	HC	HC	HC	HC	HC	HC			
			WKP25	WKP35	WKP35S	WSP45	WSM35	WSP45	WAK15	WKK25	WKP25	WKP35	WKP35S	WXN15	WK10	WGD10	WSM35	WSP45	WHH15
SPHW1204EDR-A88	3	1,5																	
SPHW1204PDR-A88	4	1,5																	
SPHX1204PDR-A88*	0,5	3,5																	

* Only in combination with SPHW1204PDR-A88.
For roughing / finishing combinations, see page F 312.

HC = Coated carbide
HW = Uncoated carbide
DP = polycrystalline diamond

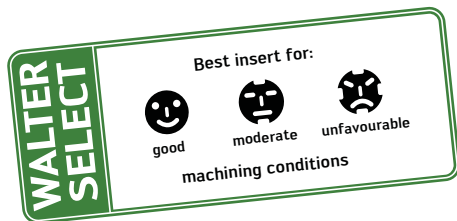

Face / shoulder mill F 2254

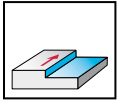

- Approach angle $\kappa = 89^\circ$
- Eight cutting edges per indexable insert
- Negative basic insert shapes
- Tangential indexable insert arrangement
- Runout adjustable from $D_c = 100$ mm

Tool	Designation	D_c mm	d_1 mm	l_4 mm	L_c mm	Z	kg	No. of indexable inserts	Type
Cyl. bore DIN 138 longitudinal key way	F2254.B.050.Z09.07	50	22	40	7	9	0,4	9	SNH . . 1205 . .
	F2254.B.063.Z12.07	63	22	40	7	12	0,7	12	
	F2254.B.080.Z15.07	80	27	50	7	15	1,2	15	
Cyl. bore DIN 138 longitudinal key way	F2254.B.100.Z19.07	100	32	50	7	19	2,1	19	SNH . . 1205 . .
	F2254.B.125.Z23.07	125	40	63	7	23	3,6	23	
Cyl. bore DIN 138 longitudinal key way	F2254.B.160.Z30.07	160	40/40 B	63	7	30	4,3	30	SNH . . 1205 . .

Bodies and assembly parts are included in the scope of delivery.

Assembly parts

	D _c mm	50-80	100-160
	Setting wedge		FK324
	Clamping screw for setting wedge		FS1160
	Clamping screw for insert	FS1007 (Torx 15)	FS1007 (Torx 15)
	Tightening torque	2,5 Nm	2,5 Nm

Accessories

	D _c mm	50-80	100-160
	Key for setting wedge		FS227 (SW 3)
	Screwdriver	FS229 (Torx 15)	FS229 (Torx 15)

Indexable inserts

Designation	Radius mm	Facet mm	P				M		K				N		S		H
			WC	WC	WC	WC	WC	WC	WC	WC	WC	WC	WC	WC	WC	WC	WC
SNHQ1205ZZR-A57T	-	0,8 x 45°	WC	WC	WC	WC	WC	WC	WC	WC	WC	WC	WC	WC	WC	WC	WC

HC = Coated carbide
HW = Uncoated carbide

WALTER SELECT

Best insert for:

good

moderate

unfavourable

machining conditions

Heavy-duty cutter F 2260

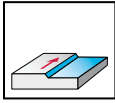

- Approach angle $\kappa = 60^\circ$
- Four cutting edges per indexable insert
- Negative basic insert shapes
- Tangential indexable insert arrangement

Tool	Designation	D _c mm	D _a mm	d ₁ mm	l ₄ mm	L _c mm	Z	 kg	No. of indexable inserts	Type
Cyl. bore DIN 138 longitudinal key way	F2260.B.100.Z06.11	100	113	32	50	11	6	2,4	6	LN .. 1508 ..
	F2260.B.125.Z08.11	125	138	40	63	11	8	3,8	8	
	F2260.B.125.Z06.15	125	143	40	63	15	6	4,4	6	
Cyl. bore DIN 138 longitudinal key way	F2260.B.160.Z10.11	160	173	40/40 B	63	11	10	6,6	10	LN .. 1508 ..
	F2260.B.160.Z08.15	160	178	40/40 B	63	15	8	7,0	8	
Cyl. bore DIN 138 longitudinal key way	F2260.B.200.Z12.11	200	213	60/50 B	63	11	12	10,2	12	LN .. 1508 ..
	F2260.B.200.Z10.15	200	218	60/50 B	63	15	10	10,0	10	
	F2260.B.250.Z14.11	250	263	60/50 B	63	11	14	16,2	14	
	F2260.B.250.Z12.15	250	268	60/50 B	63	15	12	17,2	12	
Cyl. bore DIN 138 longitudinal key way	F2260.B.315.Z16.11	315	328	60/50- 60 BB	80	11	16	31,0	16	LN .. 1508 ..
	F2260.B.315.Z14.15	315	333	60/50- 60 BB	80	15	14	33,8	14	

Bodies and assembly parts are included in the scope of delivery.

Assembly parts

	D _c mm	100-315
	Clamping screw for insert	FS1009 (Torx 20)
	Tightening torque	5.0 Nm

Accessories

	D _c mm	100-315
	Screwdriver	FS228 (Torx 20)

Indexable inserts

Designation	Radius mm	Face chamfer width mm	P				M		K				N		S		H
			HC				HC		HC				HC	HW	HC	HC	HC
			WKP25	WKP35	WKP35S	WSP45	WSM35	WSP45	WAK15	WKK25	WKP25	WKP35	WKP35S	WXN15	WK10	WSM35	WSP45
LNMU150812-F57T	1,2	-	⊕	⊕	⊕			⊕	⊕	⊕	⊕						
LNMU150812T-F27T	1,2	-	⊕	⊕	⊕			⊕	⊕	⊕	⊕						
LNMU201012-F57T	1,2	-	⊕	⊕	⊕			⊕	⊕	⊕	⊕						
LNMU201012T-F27T	1,2	-	⊕	⊕	⊕			⊕	⊕	⊕	⊕						

HC = Coated carbide
 HW = Uncoated carbide

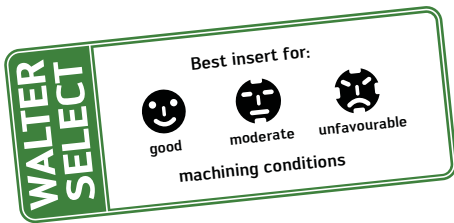

Heavy-duty cutter F 2265

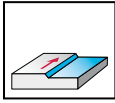
Wendelnovex®

- Approach angle $\kappa = 60^\circ$
- Four cutting edges per indexable insert
- Negative basic insert shapes
- Tangential indexable insert arrangement

Tool	Designation	D _c mm	D _a mm	d ₁ mm	l ₄ mm	L _c mm	Z	kg	No. of indexable inserts	Type
Cyl. bore DIN 138 longitudinal key way 	F2265.B.125.Z06.12	125	140	40	63	12	6	4,4	6	LN...2010..
Cyl. bore DIN 138 longitudinal key way 	F2265.B.160.Z08.12	160	175	40/40B	63	12	8	6,4	8	LN...2010..
Cyl. bore DIN 138 longitudinal key way 	F2265.B.200.Z10.12	200	215	60/50B	63	12	10	10,1	10	LN...2010..
	F2265.B.200.Z08.20	200	225	60/50B	63	20	8	12,0	8	LN...3010..
	F2265.B.250.Z12.12	250	265	60/50B	63	12	12	17,8	12	LN...2010..
	F2265.B.250.Z10.20	250	275	60/50B	63	20	10	19,2	10	LN...3010..
Cyl. bore DIN 138 longitudinal key way 	F2265.B.315.Z14.12	315	330	60/50-60 BB	80	12	14	38,0	14	LN...2010..
	F2265.B.315.Z12.20	315	340	60/50-60 BB	80	20	12	38,0	12	LN...3010..

Bodies and assembly parts are included in the scope of delivery.

Assembly parts

	D _c mm	125-315
	Clamping screw for insert	FS1009 (Torx 20)
	Tightening torque	5,0 Nm

Accessories

	D _c mm	125-315
	Screwdriver	FS228 (Torx 20)

Indexable inserts

Designation	Radius mm	Face chamfer width mm	P				M		K			N		S		H	
			HC				HC		HC			HC	HW	HC	HC	HC	
			WKP25	WKP35	WKP35S	WSP45	WSM35	WSP45	WAK15	WKK25	WKP25	WKP35	WKP35S	WXN15	WK10	WSM35	WSP45
LNKU2010DPR-F57T	0,6	1,2	☺	☹	☹				☹	☹	☹						
LNKU2010DPTR-F27T	0,6	1,2	☹						☹								
LNKU3010DPR-F57T	0,6	1,2	☺	☹	☹				☹	☹	☹						
LNKU3010DPTR-F27T	0,6	1,2	☹						☹								

HC = Coated carbide
HW = Uncoated carbide

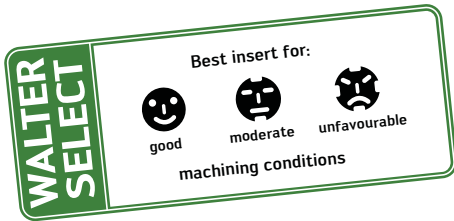

High Performance mill F 2330

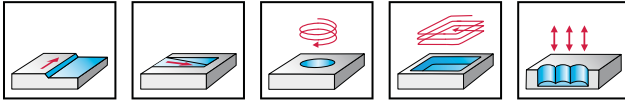
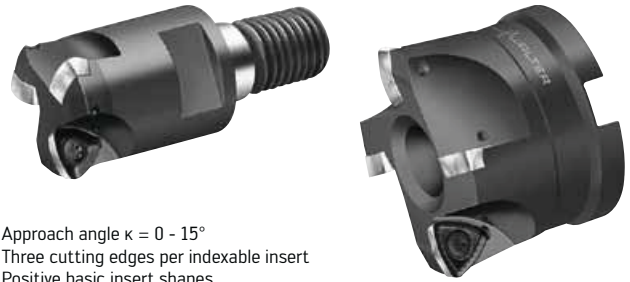

- Approach angle $\kappa = 0 - 15^\circ$
- Three cutting edges per indexable insert
- Positive basic insert shapes
- f_z up to 3.5 mm

Tool	Designation	D _c mm	D _a mm	d ₁ mm	l ₄ mm	l ₁ mm	L _c mm	a _r mm	Z	kg	No. of indexable inserts	Type
NCT ScrewFit 	F2330.T18.020.Z02.01	10	20	T18	30		1	7	2	0,1	2	P 2633 . - R 10
	F2330.T22.025.Z03.01	15	25	T22	35		1	7	3	0,1	3	P 26379 - R 10
	F2330.T28.032.Z03.01,5	18	32	T28	40		1,5	10	3	0,2	3	P 2633 . - R 14 P 26379 - R 14
	F2330.T28.035.Z03.01,5	21	35	T28	40		1,5	10	3	0,2	3	
	F2330.T36.040.Z03.01,5	26	40	T36	40		1,5	10	3	0,4	3	
F2330.T36.042.Z03.01,5	28	42	T36	40		1,5	10	3	0,4	3		
Cylindrical shank 	F2330.Z20.020.Z02.01	10	20	20	30	200	1	7	2	0,1	2	P 2633 . - R 10
	F2330.Z25.025.Z03.01	15	25	25	35	200	1	7	3	0,1	3	P 26379 - R 10
	F2330.Z32.032.Z03.01,5	18	32	32	40	250	1,5	10	3	0,5	3	P 2633 . - R 14 P 26379 - R 14
Cyl. bore DIN 138 longitudinal key way 	F2330.B22.050.Z04.01,5	30	50	22	40		1,5	1,5	4	0,4	4	P 2633 . - R 14
	F2330.B.052.Z05.01,5	38	52	22	40		1,5	10	5	0,5	5	P 26379 - R 14
	F2330.B.052.Z03.02*	32	52	22	40		2	15	3	0,4	3	P 2633 . - R 25 P 26379 - R 25
	F2330.B22.063.Z05.01,5	49	63	22	50		1,5	1,5	5	0,6	5	P 2633 . - R 14 P 26379 - R 14
	F2330.B22.063.Z04.02	43	63	22	50		2	15	4	0,6	4	P 2633 . - R 25 P 26379 - R 25
	F2330.B.066.Z06.01,5	52	66	27	50		1,5	10	6	0,8	6	P 2633 . - R 14 P 26379 - R 14
	F2330.B.066.Z04.02*	46	66	27	50		2	15	4	0,7	4	P 2633 . - R 25 P 26379 - R 25
	F2330.B27.80.Z01.5	66	80	27	50		1,5	1,5	6	1,0	6	
	F2330.B27.080.Z05.02	60	80	27	50		2	15	5	0,9	5	
	F2330.B.085.Z07.01,5	71	85	27	50		1,5	10	7	1,0	7	P 2633 . - R 14 P 26379 - R 14
F2330.B.085.Z05.02*	65	85	27	50		2	15	5	1,0	5	P 2633 . - R 25 P 26379 - R 25	

Bodies and assembly parts are included in the scope of delivery.

For programming information, see page F 316.

For flat wrenches for screw heads, see page G 105.

* D_a measured via master insert P 26325-R 25 with R 0.8.

Actual cut diameter at D_a 52=51.3 mm, D_a 66=65.3 mm, D_a 85=84.3 mm.

Assembly parts

Type	P 2633 . - R 10	P 2633 . - R 14	P 2633 . - R 25
Clamping screw for insert	FS923 (Torx 8)	FS359 (Torx 15)	FS1030 (Torx 20)
Tightening torque	0,8 Nm	2,5 Nm	5,0 Nm

Accessories

Type	P 2633 . - R 10	P 2633 . - R 14	P 2633 . - R 25
Screwdriver	FS230 (Torx 8)	FS229 (Torx 15)	FS228 (Torx 20)

Indexable inserts

	Radius mm	Face chamfer width mm	P		M		K				N		S		H		
			HC		HC		HC				HC	HW	HC		HC		
			WKP25	WKP35	WKP35S	WSP45	WSM35	WSP45	WAK15	WKK25	WKP25	WKP35	WKP35S	WXN15	WK10	WSM35	WSP45
P26335R10	0,8	-	☺	☺	☺	☺	☺	☺	☺	☺	☺	☺	☺	☺	☺	☺	
P26335R14	1,2	-	☺	☺	☺	☺	☺	☺	☺	☺	☺	☺	☺	☺	☺	☺	
P26335R25	2	-	☺	☺	☺	☺	☺	☺	☺	☺	☺	☺	☺	☺	☺	☺	
P26337R10	0,8	-	☺	☺	☺	☺	☺	☺	☺	☺	☺	☺	☺	☺	☺	☺	
P26337R14	1,2	-	☺	☺	☺	☺	☺	☺	☺	☺	☺	☺	☺	☺	☺	☺	
P26337R25	2	-	☺	☺	☺	☺	☺	☺	☺	☺	☺	☺	☺	☺	☺	☺	
P26339R10	0,8	-	☺	☺	☺	☺	☺	☺	☺	☺	☺	☺	☺	☺	☺	☺	
P26339R14	1,2	-	☺	☺	☺	☺	☺	☺	☺	☺	☺	☺	☺	☺	☺	☺	
P26339R25	2	-	☺	☺	☺	☺	☺	☺	☺	☺	☺	☺	☺	☺	☺	☺	
P26379-R10	0,8	0,9	☺	☺	☺	☺	☺	☺	☺	☺	☺	☺	☺	☺	☺	☺	
P26379-R14	1,2	1,0	☺	☺	☺	☺	☺	☺	☺	☺	☺	☺	☺	☺	☺	☺	
P26379-R25	2	1,1	☺	☺	☺	☺	☺	☺	☺	☺	☺	☺	☺	☺	☺	☺	

HC = Coated carbide
HW = Uncoated carbide

WALTER SELECT

Best insert for:

☺
good

☹
moderate

☹
unfavourable

machining conditions

High Performance mill F 4030

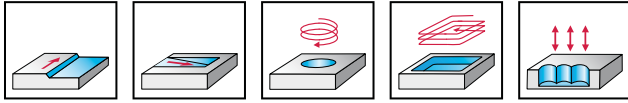
Xtra-tec®

- Approach angle $\kappa = 0 - 21^\circ$
- Six cutting edges per indexable insert
- Negative basic insert shapes
- F_z up to 3.5 mm

Tool	Designation	D _c mm	D _a mm	d ₁ mm	l ₄ mm	l ₁ mm	L _c mm	a _r mm	Z	kg	No. of indexable inserts	Type
NCT ScrewFit 	F4030.T22.025.Z02.01	13,4	25	T22	35		1	6	2	0,1	2	P 23696 - 1.0
	F4030.T28.032.Z03.01	20,4	32	T28	40		1	7	3	0,2	3	
	F4030.T28.035.Z03.01	23,4	35	T28	40		1	7	3	0,2	3	
	F4030.T36.040.Z03.01	28,4	40	T36	40		1	7	3	0,3	3	
	F4030.T36.040.Z04.01	28,4	40	T36	40		1	7	4	0,3	4	
	F4030.T36.042.Z03.01	28,4	42	T36	40		1	7	3	0,4	3	
	F4030.T36.042.Z02.02	24	42	T36	40		2	9,5	2	0,3	2	
	F4030.T45.050.Z03.02	32	50	T45	45		2	10	3	0,5	3	
	F4030.T45.050.Z04.02	32	50	T45	45		2	10	4	0,5	4	
	F4030.T45.052.Z03.02	34	52	T45	45		2	10	3	0,5	3	
Cylindrical shank without flat 	F4030.Z25.025.Z02.01	13,4	25	25	35	200	1	6	2	0,7	2	P 23696 - 1.0
	F4030.Z32.032.Z03.01	20,4	32	32	40	250	1	7	3	1,4	3	
Cyl. bore DIN 138 longitudinal key way 	F4030.B22.050.Z04.01	38,4	50	22	40		1	7	4	0,4	4	P 23696 - 1.0
	F4030.B22.050.Z05.01	38,4	50	22	40		1	7	5	0,3	5	
	F4030.B22.052.Z04.01	40,4	52	22	40		1	7	4	0,4	4	
	F4030.B22.063.Z05.01	51,4	63	22	50		1	7	5	0,7	5	
	F4030.B22.063.Z06.01	51,4	63	22	50		1	7	6	0,7	6	
	F4030.B22.063.Z04.02	45	63	22	50		2	10	4	0,7	4	
	P 23696 - 2.0	F4030.B22.063.Z05.02	45	63	22	50		2	10	5	0,7	5
		F4030.B27.066.Z04.02	48	66	27	50		2	10	4	0,7	4
		F4030.B27.080.Z05.02	62	80	27	50		2	10	5	1,1	5
		F4030.B27.080.Z06.02	62	80	27	50		2	10	6	1,1	6
		F4030.B27.085.Z05.02	67	85	27	50		2	10	5	1,2	5
		F4030.B32.100.Z06.02	82	100	32	50		2	10	6	1,6	6
		F4030.B32.100.Z07.02	82	100	32	50		2	10	7	1,6	7

Bodies and assembly parts are included in the scope of delivery.

For programming information, see page F 315.

For flat wrenches for screw heads, see page G 105.

Assembly parts

Insert types		P 23696 - 1.0	P 23696 - 2.0
	Clamping screw for insert	FS2081 (Torx 15 IP)	FS1495 (Torx 20 IP)
	Tightening torque	3,0 Nm	5,0 Nm

Accessories

Insert types		P 23696 - 1.0	P 23696 - 2.0
	Torque screwdriver	FS2003	FS2003
	Screwdriver	FS1485 (Torx 15IP)	FS1486 (Torx 20IP)
	Interchangeable blade	FS2014 (Torx 15IP)	FS2015 (Torx 20IP)

Indexable inserts

	Radius mm	P				M		K			N		S		H		
		HC				HC		HC			HC	HW	HC	HC	HC		
		WKP25	WKP35	WKP35S	WSP45	WSM35	WSP45	WAK15	WKK25	WKP25	WKP35	WKP35S	WXN15	WK10	WSM35	WSP45	WHH15
	P23696-1.0	☺	☺	☺	☺	☺	☺		☺	☺	☺	☺			☺	☺	
	P23696-2.0	☺	☺	☺	☺	☺	☺		☺	☺	☺	☺			☺	☺	

HC = Coated carbide
 HW = Uncoated carbide

WALTER SELECT

Best insert for:

☺
good

☹
moderate

☹
unfavourable

machining conditions

Face mill F 4033 SN . X 1205

Xtra-tec®

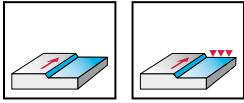

- Approach angle $\kappa = 45^\circ$
- Eight cutting edges per indexable insert
- Negative basic insert shapes
- Finishing inserts available

Tool	Designation	D _c mm	d ₁ mm	l ₄ mm	L _c mm	Z	kg	No. of indexable inserts	Types
NCT ScrewFit 	F4033.T36.040.Z03.06	40	T36	40	6,5	3	0,4	3	SN . X 1205 . .
	F4033.T36.040.Z04.06	40	T36	40	6,5	4	0,4	4	
	F4033.T45.050.Z04.06	50	T45	45	6,5	4	0,6	4	
	F4033.T45.050.Z06.06	50	T45	45	6,5	6	0,6	6	
Cyl. bore DIN 138 longitudinal key way 	F4033.B22.050.Z03.06	50	22	40	6,5	3	0,4	3	SN . X 1205 . .
	F4033.B22.050.Z04.06	50	22	40	6,5	4	0,4	4	
	F4033.B22.050.Z06.06	50	22	40	6,5	6	0,4	6	
	F4033.B22.063.Z04.06	63	22	40	6,5	4	0,7	4	
	F4033.B22.063.Z06.06	63	22	40	6,5	6	0,6	6	
	F4033.B22.063.Z08.06	63	22	40	6,5	8	0,6	8	
	F4033.B27.063.Z04.06	63	27	50	6,5	4	0,9	4	
	F4033.B27.063.Z06.06	63	27	50	6,5	6	0,8	6	
	F4033.B27.063.Z08.06	63	27	50	6,5	8	0,6	8	
	F4033.B27.080.Z05.06	80	27	50	6,5	5	1,5	5	
	F4033.B27.080.Z07.06	80	27	50	6,5	7	1,4	7	
	F4033.B27.080.Z10.06	80	27	50	6,5	10	1,3	10	
	F4033.B32.100.Z06.06	100	32	50	6,5	6	1,9	6	
	F4033.B32.100.Z08.06	100	32	50	6,5	8	1,9	8	
	F4033.B32.100.Z12.06	100	32	50	6,5	12	1,9	12	
	F4033.B40.125.Z07.06	125	40	63	6,5	7	3,2	7	
	F4033.B40.125.Z10.06	125	40	63	6,5	10	3,2	10	
	F4033.B40.125.Z16.06	125	40	63	6,5	16	3,2	16	
Cyl. bore DIN 138 longitudinal key way 	F4033.B40.160.Z08.06	160	40/40 B	63	6,5	8	5,9	8	SN . X 1205 . .
	F4033.B40.160.Z12.06	160	40/40B	63	6,5	12	5,9	12	
	F4033.B40.160.Z20.06	160	40/40B	63	6,5	20	5,6	20	
	F4033.B60.200.Z10.06*	200	60/50 B	63	6,5	10	8,8	10	
	F4033.B60.200.Z18.06*	200	60/50 B	63	6,5	18	9,1	18	
	F4033.B60.200.Z26.06*	200	60/50 B	63	6,5	26	9,4	26	

Bodies and assembly parts are included in the scope of delivery.

For flat wrenches for screw heads, see page G 105.

* Without internal coolant supply.

Assembly parts

D _c mm	40-200	
	Clamping screw for insert	FS1459 (Torx 15 IP)
	Tightening torque	4

Accessories

D _c mm	40-125	160	200
	Gasket	O-R 96X4	
	Sealing disc set (incl. gasket and screws)	FS936 COMPLETE SET	
	Torque screwdriver	FS2003	FS2003
	Screwdriver	FS1485 (Torx 15IP)	FS1485 (Torx 15IP)
	Interchangeable blade	FS2014 (Torx 15IP)	FS2014 (Torx 15IP)

Indexable inserts

	Radius mm	Face chamfer width mm	P				M		K				N		S		H		
			HC	HC	HC	HC	HC	HC	HC	HC	HC	HC	HC	HC	HC	HC	HC		
			WKP25	WKP35	WKP35S	WSP45	WSM35	WSP45	WAK15	WKK25	WKP25	WKP35	WKP35S	WXN15	WK10	WSM35	WSP45	WHH15	WXM15
SNGX120512-F57	1,2	-	☺	☺	☺	☺	☺	☺			☺	☺	☺			☺	☺		
SNGX1205ANN-D27	-	1,5	☺	☺	☺						☺	☺	☺						
SNGX1205ANN-F27	-	1,5	☺	☺	☺						☺	☺	☺						
SNGX1205ANN-F57	-	1,5	☺	☺	☺						☺	☺	☺			☺	☺		
SNGX1205ANN-F67	-	1,5	☺	☺	☺				☺		☺	☺	☺			☺	☺		
SNHX1205ANN-K88	-	1,5							☺					☺	☺				
SNMX120512-D27	1,2	-	☺	☺	☺						☺	☺	☺						
SNMX120512-F27	1,2	-	☺	☺	☺						☺	☺	☺						
SNMX120512-F57	1,2	-	☺	☺	☺						☺	☺	☺						
SNMX120512-F67	1,2	-	☺	☺	☺				☺		☺	☺	☺			☺	☺		
SNMX120520-D27	2,0	-	☺	☺	☺						☺	☺	☺						
SNMX120520-F57	2,0	-	☺	☺	☺						☺	☺	☺			☺	☺		
SNMX1205ANN-F27	-	1,5	☺	☺	☺						☺	☺	☺						
SNMX1205ANN-F57	-	1,5	☺	☺	☺						☺	☺	☺						
SNMX1205ANN-F67	-	1,5	☺	☺	☺				☺		☺	☺	☺						
XNGX1205ANN-F67*	-	4,7							☺										☺

* Only in combination with SNGX1205ANN.
For roughing / finishing combinations, see page F 312.

HC = Coated carbide
HW = Uncoated carbide

WALTER SELECT

Best insert for:

good

moderate

unfavourable

machining conditions

Face mill F 4033 SN . X 1606

Xtra-tec®

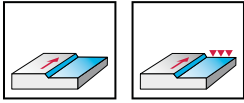

- Approach angle $\kappa = 45^\circ$
- Eight cutting edges per indexable insert
- Negative basic insert shapes

Tool	Designation	D _c mm	d ₁ mm	l ₄ mm	L _c mm	Z	kg	No. of indexable inserts	Type
Cyl. bore DIN 138 longitudinal key way 	F4033.B22.050.Z04.09	50	22	50	9	4	0,6	4	SN . X 1606 . .
	F4033.B22.063.Z05.09	63	22	50	9	5	0,8	5	
	F4033.B27.080.Z06.09	80	27	63	9	6	1,9	6	
	F4033.B32.100.Z07.09	100	32	63	9	7	2,7	7	
	F4033.B40.125.Z08.09	125	40	63	9	8	4,0	8	
Cyl. bore DIN 138 longitudinal key way 	F4033.B40.160.Z09.09	160	40/40 B	63	9	9	5,8	9	SN . X 1606 . .
	F4033.B60.200.Z10.09*	200	60/50 B	63	9	10	10,0	10	

Bodies and assembly parts are included in the scope of delivery.

* Without internal coolant supply.

Assembly parts

D _c mm	50-200	
	Clamping screw for insert	FS1495 (Torx 20 IP)
	Tightening torque	5,0 Nm

Accessories

D _c mm	50-125	160	200
	Gasket	O-R 96X4	
	Sealing disc set, complete	FS936 COMPLETE SET	
	Torque screwdriver	FS2003	FS2003
	Screwdriver	FS1486 (Torx 20IP)	FS1486 (Torx 20IP)
	Interchangeable blade	FS2015 (Torx 20IP)	FS2015 (Torx 20IP)

Indexable inserts

	Radius mm	Face chamfer width mm	P				M		K				N		S		H
			HC				HC		HC				HC	HW	HC		HC
			WKP25	WKP35	WKP35S	WSP45	WSM35	WSP45	WAK15	WKK25	WKP25	WKP35	WKP35S	WXN15	WK10	WSM35	WSP45
	SNGX1606ANN-D27	-	1.8	☺	☺	☺	☺			☺	☺	☺	☺				
	SNGX1606ANN-F27	-	1.8	☺	☺	☺	☺			☺	☺	☺	☺				
	SNGX1606ANN-F57	-	1.8	☺	☺	☺	☺			☺	☺	☺	☺			☺	☺
	SNGX1606ANN-F67	-	1.8	☺	☺	☺	☺			☺	☺	☺	☺			☺	☺
	SNMX160620-D27	2,0	-	☺	☺	☺	☺			☺	☺	☺	☺				
	SNMX160620-F27	2,0	-	☺	☺	☺	☺			☺	☺	☺	☺				
	SNMX160620-F57	2,0	-	☺	☺	☺	☺			☺	☺	☺	☺			☺	☺
	SNMX160620-F67	2,0	-	☺	☺	☺	☺			☺	☺	☺	☺			☺	☺
	SNMX160640-D27	4,0	-	☺	☺	☺	☺			☺	☺	☺	☺				
	SNMX160640-F27	4,0	-	☺	☺	☺	☺			☺	☺	☺	☺				
	SNMX160640-F57	4,0	-	☺	☺	☺	☺			☺	☺	☺	☺			☺	☺
	SNMX160640-F67	4,0	-	☺	☺	☺	☺			☺	☺	☺	☺			☺	☺

HC = Coated carbide
HW = Uncoated carbide

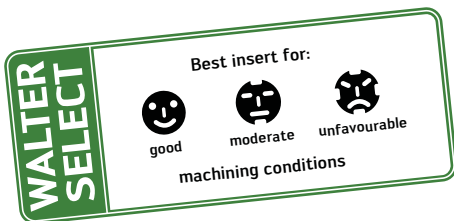

Heptagon cutter F 4045 XNHF 0705

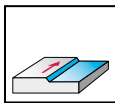
Xtra-tec®

- Approach angle $\kappa = 45^\circ$
- Fourteen cutting edges per indexable insert
- Negative basic insert shapes

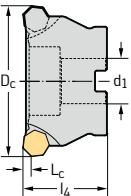
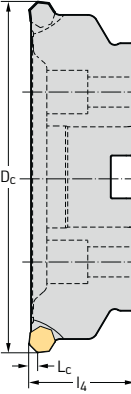
Tool	Designation	D_c mm	d_1 mm	l_4 mm	L_c mm	Z	kg	No. of indexable inserts	Type	
Cyl. bore DIN 138 longitudinal key way 	F4045.B27.063.Z09.04	63	27	50	4	9	0,7	9	XNHF 0705 . .	
	F4045.B27.080.Z11.04	80	27	50	4	11	1,4	11		
	F4045.B32.100.Z14.04	100	32	50	4	14	1,8	14		
	F4045.B40.125.Z18.04	125	40	63	4	18	3,2	18		
Cyl. bore DIN 138 longitudinal key way 	F4045.B40.160.Z22.04	160	40/40B	63	4	22	5,7	22	XNHF 0705 . .	
	F4045.B60.200.Z28.04	200	6050/B	63	4	28	9,5	28		

Bodies and assembly parts are included in the scope of delivery.

Assembly parts

D _c mm		63-200
	Clamping wedge	FK374
	Clamping screw for clamping wedge	FS2134 (Torx 15IP)
	Tightening torque	6,0 Nm

Accessories

D _c mm		63-200
	T-handle torque wrench	FS2041
	Screwdriver	FS1485 (Torx 15IP)
	Interchangeable blade for clamping wedge	FS2047 (Torx 15IP)

Indexable inserts

	Radius mm	Face chamfer width mm	P				M		K				N		S		H
			HC				HC		HC				HC	HW	HC	HC	
			WKP25	WKP35	WKP35S	WSP45	WSM35	WSP45	WAK15	WKK25	WKP25	WKP35	WKP35S	WXN15	WK10	WSM35	WSP45
	XNHF070508-D27	0,8	-	☺	☺	☺				☺	☺	☺	☺				
	XNHF070508-D57	0,8	-	☺	☺	☺				☺	☺	☺	☺				
	XNHF070508-D67	0,8	-	☺	☺	☺			☺	☺	☺	☺	☺				
	XNHF0705ANN-D27	-	1.1	☺	☺	☺				☺	☺	☺	☺				
	XNHF0705ANN-D57	-	1.1	☺	☺	☺				☺	☺	☺	☺				
	XNHF0705ANN-D67	-	1.1	☺	☺	☺			☺	☺	☺	☺	☺				

HC = Coated carbide
 HW = Uncoated carbide

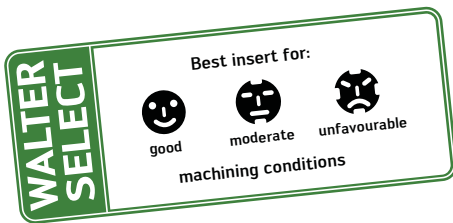

Heptagon cutter F 4045 XNHF 0906

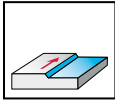
Xtra-tec®

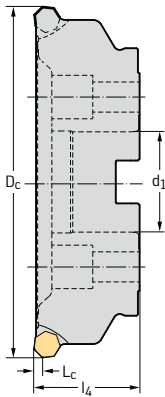
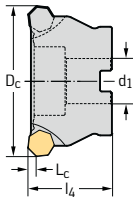

- Approach angle $\kappa = 45^\circ$
- Fourteen cutting edges per indexable insert
- Negative basic insert shapes

Tool	Designation	D _c mm	d ₁ mm	l ₄ mm	L _c mm	Z	kg	No. of indexable inserts	Type
Cyl. bore DIN 138 longitudinal key way	F4045.B27.080.Z09.06	80	27	50	6	9	1,1	9	XNHF 0906 . .
	F4045.B32.100.Z12.06	100	32	50	6	12	1,9	12	
	F4045.B40.125.Z16.06	125	40	50	6	16	3,5	16	
Cyl. bore DIN 138 longitudinal key way	F4045.B40.160.Z20.06	160	40	63	6	20	6,2	20	XNHF 0906 . .
	F4045.B60.200.Z26.06	200	60/50-60 BB	63	6	26	9,9	26	





Bodies and assembly parts are included in the scope of delivery.

Assembly parts

D _c mm		80-200
	Clamping wedge	FK375
	Clamping screw for clamping wedge	FS2157 (Torx 25IP)
	Tightening torque	6,0 Nm

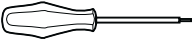
Accessories

D _c mm		80-200
	T-handle torque wrench	FS2041
	Screwdriver	FS1487 (Torx 25IP)
	Interchangeable blade for clamping wedge	FS2049 (Torx 25IP)

Indexable inserts

	Radius mm	Face chamfer width mm	P				M		K			N		S		H
			HC				HC		HC			HC	HW	HC	HC	
			WKP25	WKP35	WKP35S	WSP45	WSM35	WSP45	WAK15	WKK25	WKP25	WKP35	WKP35S	WXN15	WK10	WSM35
	XNHF090612-D27	1,2	-	☺	☺	☺			☺	☺	☺					
	XNHF090612-D57	1,2	-	☺	☺	☺			☺	☺	☺					
	XNHF090612-D67	1,2	-	☺	☺	☺		☺	☺	☺	☺					
	XNHF0906ANN-D27	-	1,4	☺	☺	☺			☺	☺	☺					
	XNHF0906ANN-D57	-	1,4	☺	☺	☺			☺	☺	☺					
	XNHF0906ANN-D67	-	1,4	☺	☺	☺		☺	☺	☺	☺					

HC = Coated carbide
 HW = Uncoated carbide

WALTER SELECT

Best insert for:

☺
good

☹
moderate

☹
unfavourable

machining conditions

Face mill F 4047

Xtra-tec®

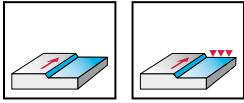
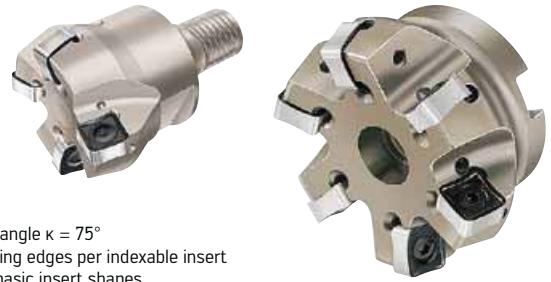

- Approach angle $\kappa = 75^\circ$
- Eight cutting edges per indexable insert
- Negative basic insert shapes
- Finishing inserts available

Tool	Designation	D _c mm	d ₁ mm	l ₄ mm	Z	kg	No. of indexable inserts	Type
NCT ScrewFit	F4047.T36.040.Z03.08	40	T36	40	3	1,1	3	SN . X 1205 . .
	F4047.T45.050.Z04.08	50	T45	45	4	1,1	4	
Cyl. bore DIN 138 longitudinal key way	F4047.B22.050.Z03.08	50	22	40	3	0,4	3	SN . X 1205 . .
	F4047.B22.050.Z04.08	50	22	40	4	0,3	4	
	F4047.B22.063.Z04.08	63	22	40	4	0,6	4	
	F4047.B22.063.Z06.08	63	22	40	6	0,6	6	
	F4047.B22.063.Z07.08	63	22	40	7	0,6	7	
	F4047.B27.063.Z04.08	63	27	50	4	0,7	4	
	F4047.B27.063.Z06.08	63	27	50	6	0,6	6	
	F4047.B27.063.Z07.08	63	27	50	7	0,7	7	
	F4047.B27.080.Z05.08	80	27	50	5	1,1	5	
	F4047.B27.080.Z07.08	80	27	50	7	1,1	7	
	F4047.B27.080.Z09.08	80	27	50	9	1,1	9	
	F4047.B32.100.Z06.08	100	32	50	6	1,8	6	
	F4047.B32.100.Z08.08	100	32	50	8	1,8	8	
	F4047.B32.100.Z11.08	100	32	50	11	1,8	11	
	F4047.B40.125.Z07.08	125	40	63	7	3,3	7	
	F4047.B40.125.Z10.08	125	40	63	10	3,2	10	
	F4047.B40.125.Z14.08	125	40	63	14	3,0	14	
Cyl. bore DIN 138 longitudinal key way	F4047.B40.160.Z08.08	160	40/40 B	63	8	5,2	8	SN . X 1205 . .
	F4047.B40.160.Z12.08	160	40/40 B	63	12	5,2	12	
	F4047.B40.160.Z18.08	160	40/40 B	63	18	5,2	18	
	F4047.B60.200.Z10.08*	200	60/50 B	63	10	9,9	10	
	F4047.B60.200.Z14.08*	200	60/50 B	63	14	9,5	14	
	F4047.B60.200.Z22.08*	200	60/50 B	63	22	8,6	22	

Bodies and assembly parts are included in the scope of delivery.

For flat wrenches for screw heads, see page G 105.

* Without internal coolant supply.

Assembly parts

D _c mm		40-200
	Clamping screw for insert	FS1459 (Torx 15 IP)
	Tightening torque	4,0 Nm

Accessories

D _c mm		40-125	160	200
	Gasket		O-R 96X4	
	Sealing disc set, complete (incl. gasket and screws)		FS936 COMPLETE SET	
	Torque screwdriver	FS2003	FS2003	FS2003
	Screwdriver	FS1485 (Torx 15IP)	FS1485 (Torx 15IP)	FS1485 (Torx 15IP)
	Interchangeable blade	FS2014 (Torx 15IP)	FS2014 (Torx 15IP)	FS2014 (Torx 15IP)

Indexable inserts

	Part number	Radius mm	Face chamfer width mm	P				M		K				N		S		H		
				HC	HC	HC	HC	HC	HC	HC	HW	HC	HC	HC	HC					
				WKP25	WKP35	WKP35S	WSP45	WSM35	WSP45	WAK15	WKK25	WKP25	WKP35	WKP35S	WXN15	WK10	WSM35	WSP45	WHH15	WXM15
	SNGX120512-F57	1,2	-	☺	☺	☺	☺	☺	☺			☺	☺	☺			☺	☺		
	SNGX1205ENN-F27	0,8	1,2	☺	☺	☺						☺	☺	☺						
	SNGX1205ENN-F57	0,8	1,2	☺	☺	☺						☺	☺	☺						
	SNGX1205ENN-F67	0,8	1,2	☺	☺	☺				☺		☺	☺	☺						
	SNMX120512-D27	1,2	-	☺	☺	☺						☺	☺	☺						
	SNMX120512-F27	1,2	-	☺	☺	☺						☺	☺	☺						
	SNMX120512-F57	1,2	-	☺	☺	☺						☺	☺	☺						
	SNMX120512-F67	1,2	-	☺	☺	☺						☺	☺	☺						
	SNMX120520-D27	2,0	-	☺	☺	☺						☺	☺	☺						
	XNGX1205ENN-F67*	-	4,5							☺										☺

* Only in combination with SNGX1205ENN.
For roughing / finishing combinations, see page F 312.

HC = Coated carbide
HW = Uncoated carbide

WALTER SELECT

Best insert for:

☺
good

☹
moderate

☹
unfavourable

maching conditions

Face mill F 4048

Xtra-tec®

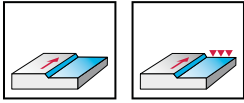
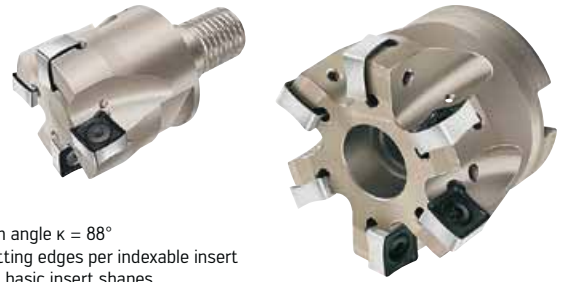

- Approach angle $\kappa = 88^\circ$
- Eight cutting edges per indexable insert
- Negative basic insert shapes
- Finishing inserts available

Tool	Designation	D _c mm	d ₁ mm	l ₄ mm	L _c mm	Z	kg	No. of indexable inserts	Type
NCT ScrewFit	F4048.T36.040.Z03.10	40	T36	40	10	3	0,4	3	SN . X 1205 . .
	F4048.T45.050.Z04.10	50	T45	45	10	4	0,6	4	
Cyl. bore DIN 138 longitudinal key way	F4048.B22.050.Z03.10	50	22	40	10	3	0,3	3	SN . X 1205 . .
	F4048.B22.050.Z04.10	50	22	40	10	4	0,3	4	
	F4048.B22.063.Z04.10	63	22	40	10	4	0,5	4	
	F4048.B22.063.Z06.10	63	22	40	10	6	0,5	6	
	F4048.B22.063.Z07.10	63	22	40	10	7	0,5	7	
	F4048.B27.063.Z04.10	63	27	50	10	4	0,6	4	
	F4048.B27.063.Z06.10	63	27	50	10	6	0,6	6	
	F4048.B27.063.Z07.10	63	27	50	10	7	0,6	7	
	F4048.B27.080.Z05.10	80	27	50	10	5	1,1	5	
	F4048.B27.080.Z07.10	80	27	50	10	7	1,0	7	
	F4048.B27.080.Z09.10	80	27	50	10	9	1,0	9	
	F4048.B32.100.Z06.10	100	32	50	10	6	1,8	6	
	F4048.B32.100.Z08.10	100	32	50	10	8	1,8	8	
	F4048.B32.100.Z11.10	100	32	50	10	11	1,8	11	
	F4048.B40.125.Z07.10	125	40	63	10	7	3,0	7	
	F4048.B40.125.Z10.10	125	40	63	10	10	2,9	10	
	F4048.B40.125.Z14.10	125	40	63	10	14	2,8	14	
Cyl. bore DIN 138 longitudinal key way	F4048.B40.160.Z08.10	160	40/40 B	63	10	8	5,2	12	SN . X 1205 . .
	F4048.B40.160.Z12.10	160	40/40 B	63	10	12	5,1	12	
	F4048.B40.160.Z18.10	160	40/40 B	63	10	18	5,0	18	
	F4048.B60.200.Z10.10*	200	60/50 B	63	10	10	9,6	10	
	F4048.B60.200.Z14.10*	200	60/50 B	63	10	14	8,6	14	
	F4048.B60.200.Z22.10*	200	60/50 B	63	10	22	8,4	22	

Bodies and assembly parts are included in the scope of delivery.

For flat wrenches for screw heads, see page G 105.

* Without internal coolant supply.

Assembly parts

D _c mm	40-200	
	Clamping screw for insert	FS1459 (Torx 15 IP)
	Tightening torque	4,0 Nm

Accessories

D _c mm	40-125	160	200
	Gasket	O-R 96X4	
	Sealing disc set, complete (incl. gasket and screws)	FS936 COMPLETE SET	
	Torque screwdriver	FS2003	FS2003
	Screwdriver	FS1485 (Torx 15IP)	FS1485 (Torx 15IP)
	Interchangeable blade	FS2014 (Torx 15IP)	FS2014 (Torx 15IP)

Indexable inserts

	Part number	Radius mm	Face chamfer width mm	P				M		K				N		S		H		
				HC	HC	HC	HC	HC	HC	HC	HW	HC	HC	HC	HC					
				WKP25	WKP35	WKP35S	WSP45	WSM35	WSP45	WAK15	WKK25	WKP25	WKP35	WKP35S	WXN15	WK10	WSM35	WSP45	WHH15	WXM15
	SNGX120512-F57	1,2	-	☺	☺	☺	☺	☺	☺			☺	☺	☺			☺	☺		
	SNGX1205ZNN-D27	0,8	-	☺	☺	☺	☺	☺	☺			☺	☺	☺			☺	☺		
	SNGX1205ZNN-F27	0,8	1,2	☺	☺	☺	☺	☺	☺			☺	☺	☺			☺	☺		
	SNGX1205ZNN-F57	0,8	1,2	☺	☺	☺	☺	☺	☺			☺	☺	☺			☺	☺		
	SNGX1205ZNN-F67	0,8	1,2	☺	☺	☺	☺	☺	☺	☺		☺	☺	☺			☺	☺		
	SNMX120512-D27	1,2	-	☺	☺	☺	☺	☺	☺			☺	☺	☺			☺	☺		
	SNMX120512-F27	1,2	-	☺	☺	☺	☺	☺	☺			☺	☺	☺			☺	☺		
	SNMX120512-F57	1,2	-	☺	☺	☺	☺	☺	☺			☺	☺	☺			☺	☺		
	SNMX120512-F67	1,2	-	☺	☺	☺	☺	☺	☺			☺	☺	☺			☺	☺		
	SNMX120520-D27	2,0	-	☺	☺	☺	☺	☺	☺			☺	☺	☺			☺	☺		
	XNGX1205ZNN-F67*	-	4,0							☺									☺	☺

* Only in combination with SNGX1205ZNN.
For roughing / finishing combinations, see page F 312.

HC = Coated carbide
HW = Uncoated carbide

WALTER SELECT

Best insert for:

☺
good

☹
moderate

☹
unfavourable

machining conditions

Octagon cutter F 4080 OD.. 0504..

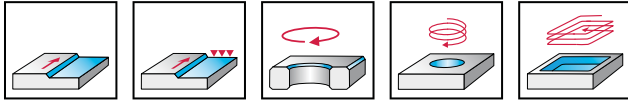
Xtra-tec®

- Approach angle $\kappa = 43^\circ$
- Eight cutting edges per indexable insert
- Positive basic insert shapes
- Finishing inserts available

Tool	Designation	D _c mm	D _a mm	d ₁ mm	l ₄ mm	L _c mm	L _{c2} mm	l ₁ mm	Z	kg	No. of indexable inserts	Type	
NCT ScrewFit 	F4080.T28.032.Z02.03*	24	32	T28	40	3	8		2	0,2	2	OD .. 0504 ..	
	F4080.T36.040.Z03.03*	32	40	T36	40	3	8		3	0,3	3		
Shank DIN 1835-B 	F4080.W32.032.Z02.03*	24	32	32	114	3	8	175	2	0,8	2	OD .. 0504 ..	
	F4080.W32.040.Z03.03*	32	40	32	114	3	8	175	3	0,8	3		
Cylindrical shank 	F4080.Z20.032.Z02.03*	24	32	20	35	3	8	110	2	0,3	2	OD .. 0504 ..	
	F4080.Z25.032.Z02.03*	24	32	25	35	3	8	150	2	0,5	2		
	F4080.Z20.040.Z03.03*	32	40	20	35	3	8	110	3	0,3	3		
	F4080.Z25.040.Z03.03*	32	40	25	35	3	8	150	3	0,6	3		
Cyl. bore DIN 138 longitudinal key way 	F4080.B16.050.Z04.03*	42	50	16	40	3	8		4	0,2	4	OD .. 0504 ..	
	F4080.B22.052.Z04.03*	44	52	22	45	3	8		4	0,3	4		
	F4080.B16.050DC.Z04.03*	50	58	16	40	3	8		4	0,3	4		
	F4080.B22.063.Z05.03*	55	63	22	40	3	8		5	0,4	5		
	F4080.B22.063.Z06.03*	55	63	22	40	3	8		6	0,4	6		
	F4080.B27.066.Z05.03*	58	66	27	50	3	8		5	0,7	5		
	F4080.B22.063DC.Z06.03*	63	71	22	40	3	8		6	0,6	6		
	F4080.B27.080.Z06.03*	72	80	27	50	3	8		6	0,9	6		
	F4080.B27.080.Z07.03*	72	80	27	50	3	8		7	1,0	7		
	F4080.B27.080DC.Z07.03*	80	88	27	50	3	8		7	1,2	7		
	F4080.B32.100.Z06.03*	92	100	32	50	3	8		6	1,5	6		
	F4080.B32.100.Z08.03*	92	100	32	50	3	8		8	1,7	8		
	F4080.B32.100DC.Z08.03*	100	108	32	50	3	8		8	1,9	8		
	F4080.B40.125.Z07.03*	117	125	40	63	3	8		7	3,0	7		
	F4080.B40.125.Z10.03*	117	125	40	63	3	8		10	3,0	10		
F4080.B40.125DC.Z10.03*	125	133	40	63	3	8		10	3,6	10			

Bodies and assembly parts are included in the scope of delivery.

For flat wrenches for screw heads, see page G 105.

* Design balanced to G 6.3 where n = 10000 rpm

Assembly parts

D _c mm	24-55	58-125
	FS2119 (Torx 15 IP)	FS2110 (Torx 15IP)
Tightening torque	3,0 Nm	3,0 Nm

Accessories

D _c mm	24-125
	FS2003
	FS1485 (Torx 15IP)
	FS2014 (Torx 15IP)

Indexable inserts

	Radius mm	Face chamfer width mm	P		M		K				N		S		H		HF			
			WKP25	WKP35	WKP35S	WSP45	WSM35	WSP45	WAK15	WKK25	WKP25	WKP35	WKP35S	WSN10	WXN15	WK10	WSM35	WSP45	WHH15	WXM15
	ODHT050408-F57	0,8	-	⊗	⊗	⊗	⊗	⊗			⊗	⊗								
	ODHT050408-G88	0,8	-										⊗	⊗						
	ODHT0504ZZN-F57	0,8	1,2	⊗	⊗	⊗	⊗	⊗			⊗	⊗								⊗
	ODHT0504ZZN-G88	0,8	1,2										⊗	⊗						
	ODHW050408-A57	0,8	-	⊗	⊗	⊗			⊗	⊗	⊗	⊗								
	ODHW050412-A57	1,2	-										⊗							
	ODHX0504ZZR-A57*	0,8	7,2	⊗	⊗	⊗			⊗	⊗	⊗							⊗	⊗	
	ODMT050408-D57	0,8	-	⊗	⊗	⊗	⊗	⊗	⊗	⊗	⊗				⊗	⊗				
	ODMT0504ZZN-D57	0,8	1,2	⊗	⊗	⊗	⊗	⊗	⊗	⊗	⊗				⊗	⊗				
	ODMW050408-A57	0,8	-	⊗	⊗	⊗			⊗	⊗	⊗									
	ODMW050408T-A27	0,8	-	⊗	⊗	⊗			⊗	⊗	⊗									

* Only in combination with ODH.0504ZZN.
For roughing / finishing combinations, see page F 312.

HC = Coated carbide
CN = Silicon nitride Si₃N₄
HW = Uncoated carbide
HF = Uncoated fine-grained carbide

Octagon cutter F 4080 OD..0605..

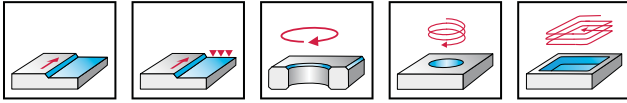
Xtra-tec®

- Approach angle $\kappa = 43^\circ$
- Eight cutting edges per indexable insert
- Positive basic insert shapes
- Finishing inserts available

Tool	Designation	D _c mm	D _a mm	d ₁ mm	l ₄ mm	L _c mm	L _{c2} mm	Z	kg	No. of indexable inserts	Type
Cyl. bore DIN 138 longitudinal key way 	F4080.B16.050.Z03.04*	40	50	16	40	4	10	3	0,2	3	OD . . 0605 . .
	F4080.B22.052.Z03.04*	42	52	22	45	4	10	3	0,3	3	
	F4080.B16.050DC.Z03.04*	50	60	16	40	4	10	3	0,3	3	
	F4080.B22.063.Z04.04*	53	63	22	40	4	10	4	0,4	4	
	F4080.B22.063.Z05.04*	53	63	22	40	4	10	5	0,5	5	
	F4080.B27.066.Z05.04*	56	66	27	50	4	10	5	0,6	5	
	F4080.B22.063DC.Z05.04*	63	73	22	40	4	10	5	0,5	5	
	F4080.B27.080.Z05.04*	70	80	27	50	4	10	5	0,8	5	
	F4080.B27.080.Z06.04*	70	80	27	50	4	10	6	0,9	6	
	F4080.B27.080DC.Z06.04*	80	90	27	50	4	10	6	1,2	6	
	F4080.B32.100.Z05.04*	90	100	32	50	4	10	5	1,5	5	
	F4080.B32.100.Z07.04*	90	100	32	50	4	10	7	1,6	7	
	F4080.B32.100DC.Z07.04*	100	110	32	50	4	10	7	1,9	7	
	F4080.B40.125.Z06.04*	115	125	40	63	4	10	6	2,9	6	
	F4080.B40.125.Z08.04*	115	125	40	63	4	10	8	3,0	8	
	F4080.B40.125DC.Z08.04*	125	135	40	63	4	10	8	2,5	8	
Cyl. bore DIN 138 longitudinal key way 	F4080.B40.160.Z07.04*	150	160	40/40 B	63	4	10	7	4,2	7	OD . . 0605 . .
	F4080.B40.160.Z09.04*	150	160	40/40 B	63	4	10	9	4,6	9	
	F4080.B40.160DC.Z09.04*	160	170	40/40 B	63	4	10	9	5,0	9	

Bodies and assembly parts are included in the scope of delivery.

* Design balanced to G 6.3 where n = 10000 rpm

Assembly parts

	D _c mm	40-160
	Clamping screw for insert	FS1495 (Torx 20 IP)
	Tightening torque	5,0 Nm

Accessories

	D _c mm	40-125	150-160
	Gasket		O-R 96X4
	Sealing disc set, complete		FS936 COMPLETE SET
	Torque screwdriver	FS2003	FS2003
	Screwdriver	FS1486 (Torx 20IP)	FS1486 (Torx 20IP)
	Interchangeable blade	FS2015 (Torx 20IP)	FS2015 (Torx 20IP)

Indexable inserts

	Part Number	Radius mm	Face chamfer width mm	P				M		K				N		S		H	HC	HF		
				HC	HC	HC	HC	HC	HC	HC	HC	HC	HC	HC	HC	HC	HC	HC	HC	HC	HC	
	ODHT060512-F57	0,8	-	WKP25	WKP35	WKP35S	WSP45	WSM35	WSP45	WAK15	WKK25	WKP25	WKP35	WKP35S	WSN10	WXN15	WK10	WSM35	WSP45	WHH15	WXM15	WMG40
	ODHT060512-G88	0,8	-	⊕	⊕	⊕	⊕	⊕	⊕							⊕	⊕					
	ODHT0605ZZN-F57	0,8	1,6	⊕	⊕	⊕	⊕	⊕	⊕				⊕	⊕				⊕	⊕			
	ODHT0605ZZN-G88	0,8	1,6													⊕	⊕					
	ODHW060512-A57	1,2	-	⊕	⊕	⊕				⊕	⊕	⊕	⊕	⊕								
	ODHW060516-A57	1,6	-												⊕							
	ODHW0605ZZN-A57	0,8	1,6	⊕	⊕	⊕				⊕	⊕	⊕	⊕	⊕								
	ODHX0605ZZR-A57*	0,8	9,4							⊕		⊕	⊕							⊕	⊕	
	ODMT060512-D57	1,2	-	⊕	⊕	⊕	⊕	⊕	⊕	⊕	⊕	⊕	⊕	⊕				⊕	⊕			
	ODMT0605ZZN-D57	0,8	1,6	⊕	⊕	⊕	⊕	⊕	⊕	⊕	⊕	⊕	⊕	⊕				⊕	⊕			
	ODMW060508-A57	0,8	-	⊕	⊕	⊕			⊕	⊕	⊕	⊕	⊕	⊕								
	ODMW060508T-A27	0,8	-	⊕	⊕	⊕			⊕	⊕	⊕	⊕	⊕	⊕								

* Only in combination with ODH.0605ZZN.
For roughing / finishing combinations, see page F 312.

HC = Coated carbide
CN = Silicon nitride Si₃N₄
HW = Uncoated carbide
HF = Uncoated fine-grained carbide

WALTER SELECT

Best insert for:

good

moderate

unfavourable

machining conditions

Walter Select – shoulder milling

Application			
Approach angle κ	89°45'	90°	
Shoulder milling cutter	F 2241 	F 4041 	
Ø range [mm]	16–160	40–160	
Page	F 138	F 142	
P Steel	••	••	
M Stainless steel	••	••	
K Cast iron	••	••	
N NF metals	••	••	
S Difficult-to-machine materials	••	••	
H Hard materials	•		
O Other	•	•	
Basic insert shapes			
Insert types	SP .. 0603 .. SP .. 09T3 .. SP .. 1204 ..	LNGX 1307 ..	
Max. cutting depths [mm]	6 + 9 + 12	13	
Number of cutting edges per indexable insert	4	4	

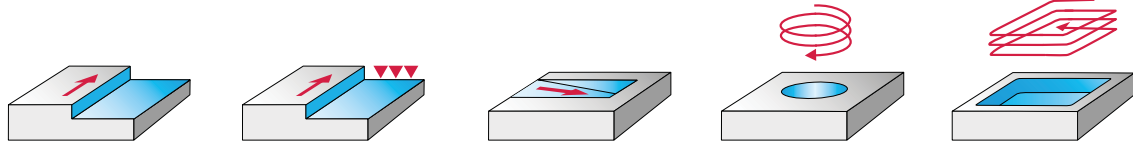

	90°	90°	90°
	F 4042R	F 4042	F 3040
	Xtra-tec®	Xtra-tec®	
	16-63	10-160	25-63
	F 148	F 144 / F 152	F 140
	••	••	
	••	••	
	••	••	•
	••	••	••
	••	••	•
	•	•	
	•	•	•
	AD . T 10T3 . .	AD . T 0803 . . AD . T 1204 . . AD . T 1606 . . AD . T 1807 . .	ZDGT 1504 . . ZDGT 2005 . .
	10	8 + 11,7 + 15 + 16	15 + 20
	2	2	2



Walter Select – shoulder milling

Application				
Approach angle κ	90°	90°	90°	
Shoulder milling cutter	F 2338F 	F 4038 Xtra-tec®	F 4138 Xtra-tec®	
Ø range [mm]	63–100	20–32	32–80	
Page	F 160	F 162	F 164	
P Steel	••	••	••	
M Stainless steel	•	••	••	
K Cast iron	••	••	••	
N NF metals	•	••	••	
S Difficult-to-machine materials	•	••	••	
H Hard materials				
O Other		•	•	
Basic insert shapes				
Insert types	LP .. 1506 .. SP .. 1206 ..	AD .. 0803 ..	AD .. 1204 ..	
Max. cutting depths [mm]	103	37	76	
Number of cutting edges per indexable insert	2/4	2	2	

	90°	90°
	F 4238	F 4338
	<p>Xtra-tec®</p>	<p>Xtra-tec®</p>
	40-80	63-125
	F 166	F 168
	••	••
	••	••
	••	••
	••	•
	••	••
	•	
	AD .. 1606 ..	AD .. 1807 ..
	112	124
	2	2



Shoulder milling cutter F 2241

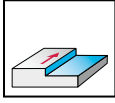

- Approach angle $\kappa = 89^\circ 45'$
- Four cutting edges per indexable insert
- Positive basic insert shapes

Tool	Designation	D _c mm	d ₁ mm	l ₄ mm	L _c mm	l ₁ mm	Z	kg	No. of indexable inserts	Type
NCT ScrewFit 	F2241.T14.016.Z02.06	16	T14	25	6		2	0,1	2	
	F2241.T18.020.Z03.06	20	T18	30	6		3	0,1	3	SP .. 0603 ..
	F2241.T22.025.Z02.09	25	T22	35	9		2	0,1	2	
	F2241.T28.032.Z03.09	32	T28	40	9		3	0,2	3	SP .. 09T3 ..
	F2241.T36.040.Z03.12	40	T36	40	12		3	0,3	3	SP .. 1204 ..
	F2241.T36.040.Z04.09	40	T36	40	9		4	0,4	4	SP .. 09T3 ..
	F2241.T36.040.Z06.06	40	T36	40	6		6	0,4	6	SP .. 0603 ..
	F2241.T45.050.Z04.12	50	T45	40	12		4	0,5	4	SP .. 1204 ..
F2241.T45.050.Z06.09	50	T45	40	9		6	0,5	6	SP .. 09T3 ..	
Shank DIN 1835-B 	F2241.W.016.Z02.06	16	16	31	6	80	2	0,1	2	SP .. 0603 ..
	F2241.W.020.Z03.06	20	20	39	6	90	3	0,2	3	
	F2241.W.025.Z02.09	25	25	43	9	100	2	0,3	2	SP .. 09T3 ..
	F2241.W.025.Z04.06	25	25	43	6	100	4	0,3	4	SP .. 0603 ..
	F2241.W20.025.Z02.09	25	20	43	9	94	2	0,2	2	SP .. 09T3 ..
	F2241.W20.025.Z04.06	25	20	43	6	94	4	0,2	4	
	F2241.W20.032.Z05.06	32	20	49	6	100	5	0,5	5	SP .. 0603 ..
	F2241.W.032.Z05.06	32	32	49	6	110	5	0,6	5	
	F2241.W.032.Z03.09	32	32	49	9	110	3	0,6	3	SP .. 09T3 ..
	F2241.W.032.Z02.12	32	32	49	12	110	2	0,6	2	SP .. 1204 ..
	F2241.W20.032.Z03.09	32	20	49	9	100	3	0,3	3	SP .. 09T3 ..
	F2241.W.040.Z03.12	40	32	49	12	110	3	0,7	3	SP .. 1204 ..
	F2241.W.040.Z04.09	40	32	49	9	110	4	0,7	4	SP .. 09T3 ..
	F2241.W.040.Z06.06	40	32	49	6	110	6	0,7	6	SP .. 0603 ..
Cylindrical shank 	F2241.Z.025.Z02.09	25	25	43	9	200	2	0,7	2	
	F2241.Z.032.Z03.09	32	32	49	9	250	3	1,5	3	SP .. 09T3 ..
	F2241.Z.040.Z04.09	40	32	49	9	250	4	1,6	4	
Cyl. bore DIN 138 longitudinal key way 	F2241.B.040.Z05.09	40	16	40	9		5	0,22	5	SP .. 09T3 ..
	F2241.B.050.Z04.12	50	22	40	12		4	0,28	4	SP .. 1204 ..
	F2241.B.050.Z06.09	50	22	40	9		6	0,3	6	SP .. 09T3 ..
	F2241.B.063.Z05.12	63	22	40	12		5	0,5	5	SP .. 1204 ..
	F2241.B.063.Z07.09	63	22	40	9		7	0,6	7	SP .. 09T3 ..
	F2241.B.080.Z06.12	80	27	50	12		6	1	6	SP .. 1204 ..
	F2241.B.080.Z08.09	80	27	50	9		8	1,1	8	SP .. 09T3 ..
	F2241.B.100.Z07.12	100	32	50	12		7	1,7	7	SP .. 1204 ..
	F2241.B.100.Z09.09	100	32	50	9		9	1,8	9	SP .. 09T3 ..
	F2241.B.125.Z08.12	125	40	63	12		8	3,1	8	SP .. 1204 ..
	F2241.B.125.Z11.09	125	40	63	9		11	3,4	11	SP .. 09T3 ..

Bodies and assembly parts are included in the scope of delivery.
 For flat wrenches for screw heads, see page G 105.

Continued

Continued

Tool	Designation	D _c mm	d ₁ mm	l ₄ mm	L _c mm	l ₁ mm	Z		No. of indexable inserts	Type
Cyl. bore DIN 138 longitudinal key way	F2241.B.160.Z10.12	160	40/40 B	63	12	—	10	4,0	10	SP .. 1204 ..
	F2241.B.160.Z13.09	160	40/40 B	63	9	—	13	4,0	13	SP .. 09T3 ..

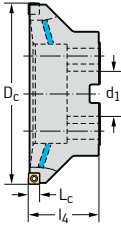

Bodies and assembly parts are included in the scope of delivery.

Assembly parts		SP .. 0603 ..	SP .. 09T3 ..	SP .. 1204 ..
	Clamping screw for insert	FS923 (Torx 8)	FS359 (Torx 15)	FS1030 (Torx 20)

Accessories		SP .. 0603 ..	SP .. 09T3 ..	SP .. 1204 ..
	Screwdriver	FS230 (Torx 8)	FS229 (Torx 15)	FS228 (Torx 20)

Indexable inserts

Designation	Radius mm	P		M	K			N		S	H					
		HC		HC	HC			CN	HC	HW	HC	HC				
		WKP25	WKP35	WKP35S	WSP45	WSM35	WSP45	WAK15	WKP25	WKP35	WKP35S	WSN10	WXN15	WK10	WSM35	WSP45
SPHT060304-G88	0,4										☺	☺				
SPHT09T308-G88	0,8										☺	☺				
SPHT120408-G88	0,8										☺	☺				
SPHW120412-A57	1,2									☺						
SPHW120416-A57	1,6									☺						
SPMT060304-D51	0,4	☺	☺	☺	☺			☺	☺	☺				☺	☺	
SPMT060304-F55	0,4	☺	☺	☺	☺	☺		☺	☺	☺				☺	☺	
SPMT09T308-D51	0,8	☺	☺	☺	☺	☺		☺	☺	☺				☺	☺	
SPMT09T308-F55	0,8	☺	☺	☺	☺	☺	☺	☺	☺	☺				☺	☺	
SPMT120408-D51	0,8	☺	☺	☺	☺	☺		☺	☺	☺				☺	☺	
SPMT120408-F55	0,8	☺	☺	☺	☺	☺	☺	☺	☺	☺				☺	☺	
SPMW060304-A57	0,4	☺	☺	☺			☺	☺	☺	☺						
SPMW060304T-A27	0,4	☺	☺	☺				☺	☺	☺						
SPMW09T308-A57	0,8	☺	☺	☺			☺	☺	☺	☺						
SPMW09T308T-A27	0,8	☺	☺	☺				☺	☺	☺						
SPMW120408-A57	0,8	☺	☺	☺			☺	☺	☺	☺						
SPMW120408T-A27	0,8	☺	☺	☺				☺	☺	☺						

HC = Coated carbide
 CN = Silicon nitride Si₃N₄
 HW = Uncoated carbide

WALTER SELECT

Best insert for:

☺
good

☹
moderate

☹
unfavourable

machining conditions

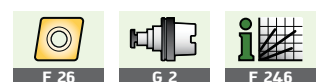

Ramping mill F 3040

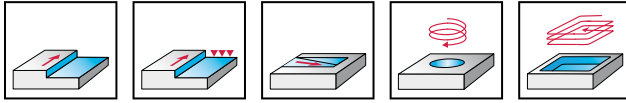

- Approach angle $\kappa = 90^\circ$
- Two cutting edges per indexable insert
- Positive basic insert shapes
- For pocket machining
- For aluminium machining

Tool	Designation	D _c mm	d ₁ mm	l ₄ mm	L _c mm	l ₁ mm	l ₁₆ mm	Z	kg	No. of indexable inserts	Type	
NCT ScrewFit 	F3040.T22.025.Z02.15	25	T22	45	15			2	0,1	2	ZD .. 1504 ..	
	F3040.T28.032.Z02.15	32	T28	45	15			2	0,2	2	ZD .. 2005 ..	
	F3040.T28.032.Z02.20	32	T28	55	20			2	0,2	2		
	F3040.T36.040.Z03.15	40	T36	45	15			3	0,3	3		
		F3040.T36.040.Z02.20	40	T36	50	20			2	0,4	2	
Cylindrical shank 	F3040.Z20.025.Z02.15.S	25	20	40	15	110		2	0,7	2	ZD .. 1504 ..	
	F3040.Z20.032.Z02.15.S	32	20	40	15	110		2	0,3	2	ZD .. 2005 ..	
	F3040.Z20.032.Z02.20.S	32	20	50	20	120		2	0,3	2		
Cylindrical shank 	F3040.Z25.025.Z02.15.L	25	25	40	15	150		2	0,5	2	ZD .. 1504 ..	
	F3040.Z25.032.Z02.15.L	32	25	40	15	175		2	0,6	2		
	F3040.Z32.032.Z02.15.L	32	32	40	15	175		2	1,0	2	ZD .. 2005 ..	
	F3040.Z25.032.Z02.20.L	32	25	50	20	175		2	0,6	2		
	F3040.Z32.032.Z02.20.L	32	32	50	20	175		2	0,9	2		
		F3040.Z32.040.Z03.15.L	40	32	55	15	175		3	1,0	3	ZD .. 1504 ..
		F3040.Z32.040.Z02.20.L	40	32	50	20	175		2	1,0	2	ZD .. 2005 ..
HSK DIN 69893/1-A 	F3040.H63A.025.Z02.15	25	HSK-A63	110	15		55	2	1,1	2	ZD .. 1504 ..	
	F3040.H63A.032.Z02.15	32	HSK-A63	110	15		60	2	1,1	2		
	F3040.H63A.032.Z02.20	32	HSK-A63	110	20		65	2	1,2	2	ZD .. 2005 ..	
	F3040.H63A.040.Z03.15	40	HSK-A63	110	15		60	3	1,3	3	ZD .. 1504 ..	
	F3040.H63A.040.Z02.20	40	HSK-A63	110	20		65	2	1,3	2	ZD .. 2005 ..	
Cyl. bore DIN 138 longitudinal key way 	F3040.B.040.Z03.15	40	16	50	15			3	0,2	3	ZD .. 1504 ..	
	F3040.B.050.Z04.15	50	22	50	15			4	0,3	4	ZD .. 2005 ..	
	F3040.B.050.Z03.20	50	22	60	20			3	0,4	3		
	F3040.B.063.Z05.15	63	22	50	15			5	0,6	5	ZD .. 1504 ..	
	F3040.B.063.Z04.20	63	22	50	20			4	0,5	4	ZD .. 2005 ..	

Bodies and assembly parts are included in the scope of delivery.

Cutter body with HSK balanced to G6.3 n=20000 rpm, with ID chip pocket, ID chip pocket not included, others balanced to G6.3 n=10,000 rpm are pre-balanced.

For information on high-speed applications, see page F 310.

For flat wrenches for screw heads, see page G 105.

For HSK accessories, see page H 42.

For special clamping screws for arbour mounted tools, see page G 115.

Assembly parts		Insert types D _c mm	ZD .. 1504 .. 25-32	ZD .. 1504 .. 40-63	ZD .. 2005 .. 32	ZD .. 1205 .. 40-63
	Clamping screw for insert		FS1011 (Torx 15)	FS 378 (Torx 15)	FS1029 (Torx 20)	FS1030 (Torx 20)
	Tightening torque		3,0 Nm	3,0 Nm	5,0 Nm	5,0 Nm

Accessories		Insert types D _c mm	ZD .. 1504 .. 25-63	ZD .. 2005 .. 32-63
	Screwdriver		FS229 (Torx 15)	FS229 (Torx 15)

Indexable inserts

Designation	Radius mm	Face chamfer width mm	P				M		K				N		S		H	HF	
			HC	HC	HC	HC	HC	HC	HC	HW	HC	HC	HC	HC	HF				
			WKP25	WKP35	WKP35S	WSP45	WSM35	WSP45	WAK15	WKK25	WKP25	WKP35	WKP35S	WXN15	WK10	WSM35	WSP45	WHH15	WNG40
ZDGT150404R-K85	0,4	1,2												☺	☺				☺
ZDGT150408R-K85	0,8	1,2												☺	☺				☺
ZDGT150412R-K85	1,2	1,2												☺	☺				☺
ZDGT150416R-K85	1,6	1,2												☺	☺				☺
ZDGT150420R-K85	2,0	1,2												☺	☺				☺
ZDGT150425R-K85	2,5	1,2												☺	☺				☺
ZDGT150430R-K85	3,0	1,2												☺	☺				☺
ZDGT150440R-K85	4,0	1,2												☺	☺				☺
ZDGT200508R-K85	0,8	1,2												☺	☺				☺
ZDGT200512R-K85	1,2	1,2												☺	☺				☺
ZDGT200516R-K85	1,6	1,2												☺	☺				☺
ZDGT200520R-K85	2,0	1,2												☺	☺				☺
ZDGT200530R-K85	3,0	1,2												☺	☺				☺
ZDGT200540R-K85	4,0	1,2												☺	☺				☺
ZDGT200550R-K85	5,0	1,2												☺	☺				☺
ZDGT200560R-K85	6,0	1,2												☺	☺				☺
ZDGT200564R-K85	6,4	1,2												☺	☺				☺

If the corner radius is R = 2.0 mm or above, the body in the corner section must be reworked:
 $R_{(body)} = R_{(insert)} - 1 \text{ mm}$

HC = Coated carbide
 HW = Uncoated carbide
 HF = Uncoated fine-grained carbide

WALTER SELECT

Best insert for:

☺
good

⚠
moderate

☹
unfavourable

machining conditions

Shoulder milling cutter F 4041

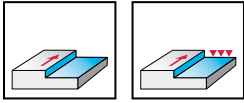
Xtra-tec®

- Approach angle $\kappa = 90^\circ$
- Four cutting edges per indexable insert
- Negative basic insert shapes





Tool	Designation	D _c mm	d ₁ mm	l ₄ mm	L _c mm	l ₁ mm	Z	kg	No. of indexable inserts	Type
NCT ScrewFit 	F4041.T36.040.Z03.13	40	T36	40	13		3	0,3	3	LN .. 1307 ..
	F4041.T45.050.Z03.13	50	T45	40	13		3	0,5	3	
	F4041.T45.050.Z04.13	50	T45	40	13		4	0,5	4	
Shank DIN 1835-B 	F4041.W32.040.Z03.13	40	32	49	13	110	3	0,7	3	LN .. 1307 ..
Cyl. bore DIN 138 longitudinal key way 	F4041.B.040.Z03.13	40	16	40	13		3	0,2	3	LN .. 1307 ..
	F4041.B.050.Z03.13	50	22	40	13		3	0,3	3	
	F4041.B.050.Z04.13	50	22	40	13		4	0,3	4	
	F4041.B.063.Z04.13	63	22	40	13		4	0,6	4	
	F4041.B.063.Z06.13	63	22	40	13		6	0,6	6	
	F4041.B27.063.Z04.13	63	27	50	13		4	0,7	4	
	F4041.B27.063.Z06.13	63	27	50	13		6	0,6	6	
	F4041.B.080.Z05.13	80	27	50	13		5	1,1	5	
	F4041.B.080.Z07.13	80	27	50	13		7	1,1	7	
	F4041.B.100.Z05.13	100	32	50	13		5	1,9	5	
	F4041.B.100.Z08.13	100	32	50	13		8	1,9	8	
	F4041.B.125.Z07.13	125	40	63	13		7	3,4	7	
	F4041.B.125.Z10.13	125	40	63	13		10	3,5	10	
Cyl. bore DIN 138 longitudinal key way 	F4041.B.160.Z08.13	160	40/40 B	63	13		8	4,4	8	LN .. 1307 ..
	F4041.B.160.Z12.13	160	40/40 B	63	13		12	4,6	12	

Bodies and assembly parts are included in the scope of delivery.
 For flat wrenches for screw heads, see page G 105.

Assembly parts

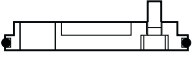
	D _c mm	40-160
	Clamping screw for insert	FS1458 (Torx 15IP)
	Tightening torque	2,5 Nm

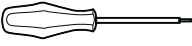
Accessories

	D _c mm	40-125	160
	Gasket		O-R 96X4
	Sealing disc set, complete (incl. gasket + screws)		FS936 COMPLETE SET
	Torque screwdriver	FS2003	FS2003
	Screwdriver	FS1485 (Torx 15IP)	FS1485 (Torx 15IP)
	Interchangeable blade	FS2014 (Torx 15IP)	FS2014 (Torx 15IP)

Indexable inserts

Designation	Radius mm	Face chamfer width mm	P				M		K				N		S		H
			HC	HC	HC	HC	HC	HC	HC	HC	HW	HC	HW	HC	HC	HC	
 LNGX130708R-L55	0,8	1,2	☺	☺	☺	☺	☺	☺	☺	☺	☺	☺	☺	☺	☺	☺	
LNGX130708R-L88	0,8	1,2	☺	☺	☺	☺	☺	☺	☺	☺	☺	☺	☺	☺	☺	☺	
LNGX130712R-L55	1,2	1,0	☺	☺	☺	☺	☺	☺	☺	☺	☺	☺	☺	☺	☺	☺	
LNGX130712R-L88	1,2	1,0	☺	☺	☺	☺	☺	☺	☺	☺	☺	☺	☺	☺	☺	☺	
LNGX130716R-L55	1,6	0,9	☺	☺	☺	☺	☺	☺	☺	☺	☺	☺	☺	☺	☺	☺	
LNGX130716R-L88	1,6	0,9	☺	☺	☺	☺	☺	☺	☺	☺	☺	☺	☺	☺	☺	☺	
LNGX130720R-L55	2,0	0,7	☺	☺	☺	☺	☺	☺	☺	☺	☺	☺	☺	☺	☺	☺	
LNGX130720R-L88	2,0	0,7	☺	☺	☺	☺	☺	☺	☺	☺	☺	☺	☺	☺	☺	☺	
LNGX130725R-L55	2,5	0,6	☺	☺	☺	☺	☺	☺	☺	☺	☺	☺	☺	☺	☺	☺	
LNGX130725R-L88	2,5	0,6	☺	☺	☺	☺	☺	☺	☺	☺	☺	☺	☺	☺	☺	☺	
LNGX130730R-L55	3,0	0,7	☺	☺	☺	☺	☺	☺	☺	☺	☺	☺	☺	☺	☺	☺	
LNGX130730R-L88	3,0	0,7	☺	☺	☺	☺	☺	☺	☺	☺	☺	☺	☺	☺	☺	☺	

If the corner radius is R = 1.2 mm or above, the body in the corner section must be reworked:

$$R_{(body)} = R_{(insert)}$$

HC = Coated carbide

HW = Uncoated carbide

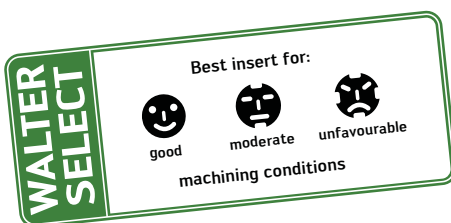

Shoulder milling cutter F 4042

AD . . 0803

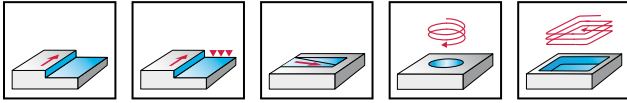
Xtra-tec®

- Approach angle $\kappa = 90^\circ$
- Two cutting edges per indexable insert
- Positive basic insert shapes

Tool	Designation	D_c mm	d_1 mm	l_4 mm	L_c mm	l_1 mm	Z	kg	No. of indexable inserts	Type
NCT ScrewFit 	F4042.T09.010.Z01.08*	10	T09	20	8		1	0,1	1	AD . . 0803 . .
	F4042.T09.012.Z01.08*	12	T09	20	8		1	0,1	1	
	F4042.T14.016.Z02.08	16	T14	25	8		2	0,1	2	
	F4042.T14.018.Z02.08*	18	T14	25	8		2	0,1	2	
	F4042.T18.020.Z02.08*	20	T18	30	8		2	0,1	2	
	F4042.T18.020.Z03.08	20	T18	30	8		3	0,1	3	
	F4042.T18.022.Z03.08*	22	T18	30	8		3	0,1	3	
	F4042.T22.025.Z02.08*	25	T22	35	8		2	0,1	2	
	F4042.T22.025.Z03.08*	25	T22	35	8		3	0,1	3	
	F4042.T22.025.Z04.08*	25	T22	35	8		4	0,1	4	
	F4042.T28.032.Z03.08*	32	T28	40	8		3	0,2	3	
	F4042.T28.032.Z04.08*	32	T28	40	8		4	0,2	4	
	F4042.T28.032.Z05.08*	32	T28	40	8		5	0,1	5	
	F4042.T36.040.Z03.08*	40	T36	40	8		3	0,4	3	
	F4042.T36.040.Z04.08*	40	T36	40	8		4	0,4	4	
	F4042.T36.040.Z06.08*	40	T36	40	8		6	0,4	6	
	F4042.T45.050.Z04.08*	50	T45	40	8		4	0,5	4	
	F4042.T45.050.Z05.08*	50	T45	40	8		5	0,5	5	
	F4042.T45.050.Z07.08*	50	T45	40	8		7	0,5	7	
	Shank DIN 1835-B 	F4042.W16.010.Z01.08	10	16	31	8	80	1	0,1	
F4042.W16.012.Z01.08		12	16	31	8	80	1	0,1	1	
F4042.W16.016.Z02.08		16	16	41	8	90	2	0,1	2	
F4042.W20.020.Z02.08		20	20	39	8	90	2	0,2	2	
F4042.W20.020.Z03.08		20	20	39	8	90	3	0,2	3	
F4042.W25.025.Z02.08		25	25	43	8	100	2	0,4	2	
F4042.W25.025.Z03.08		25	25	43	8	100	3	0,4	3	
F4042.W25.025.Z04.08		25	25	43	8	100	4	0,3	4	
F4042.W32.032.Z03.08		32	32	49	8	110	3	0,6	3	
F4042.W32.032.Z04.08		32	32	49	8	110	4	0,6	4	
F4042.W32.032.Z05.08		32	32	49	8	110	5	0,6	5	
F4042.W32.040.Z03.08		40	32	49	8	110	3	0,7	3	
F4042.W32.040.Z04.08		40	32	49	8	110	4	0,7	4	
F4042.W32.040.Z06.08		40	32	49	8	110	6	0,7	6	

Bodies and assembly parts are included in the scope of delivery.

For flat wrenches for screw heads, see page G 105.

 * Design balanced to G 6.3 where $n = 10000$ rpm

Assembly parts

	D _c mm	10-12	16-50
	Clamping screw for insert	FS1455 (Torx 8 IP)	FS1454 (Torx 8 IP)
	Tightening torque	1,2 Nm	1,2 Nm

Accessories

	D _c mm	10-50
	Torque screwdriver	FS2001
	Screwdriver	FS1483 (Torx 8IP)
	Interchangeable blade	FS2012 (Torx 8IP)

Indexable inserts

Designation	Radius mm	Face chamfer width mm	P		M		K				N		S		H	
			HC		HC		HC				HC	HW	HC		HC	
			WKP25	WKP35	WKP35S	WSP45	WSM35	WSP45	WAK15	WKK25	WKP25	WKP35	WKP35S	WXN15	WK10	WSM35
ADGT0803PER-D51	0,4	1,2	☺	☺	☺	☺	☺	☺	☺	☺	☺			☺	☺	
ADGT0803PER-D56	0,4	1,2	☺	☺	☺	☺	☺	☺	☺	☺	☺			☺	☺	
ADGT0803PER-F56	0,4	1,2				☺	☺							☺	☺	
ADHT0803PER-G88	0,4	1,2										☺	☺			
ADKT0803PER-F56	0,4	1,2	☺	☺	☺	☺	☺	☺	☺	☺	☺				☺	
ADMT080302R-F56	0,2	1,2		☺	☺	☺	☺							☺	☺	
ADMT080304R-D56	0,4	1,2	☺	☺	☺	☺	☺	☺	☺	☺	☺			☺	☺	
ADMT080304R-F56	0,4	1,2	☺	☺	☺	☺	☺	☺	☺	☺	☺			☺	☺	
ADMT080304R-G56	0,4	1,2		☺	☺	☺	☺							☺	☺	
ADMT080308R-F56	0,8	1,2		☺	☺	☺	☺							☺	☺	
ADMT080312R-F56	1,2	1,0		☺	☺	☺	☺							☺	☺	
ADMT080316R-F56	1,6	1,0		☺	☺	☺	☺							☺	☺	
ADMT080320R-F56	2,0	1,0		☺	☺	☺	☺							☺	☺	
ADMT080325R-F56	2,5	0,8		☺												

If the corner radius is R = 1.6 mm or above, the body in the corner section must be reworked:

$$R_{(\text{body})} = R_{(\text{insert})} - 1 \text{ mm}$$

HC = Coated carbide

HW = Uncoated carbide

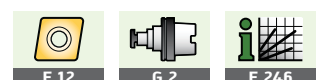
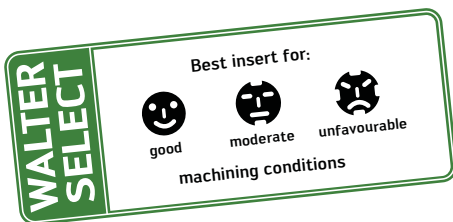

Shoulder milling cutter F 4042

AD . . 0803

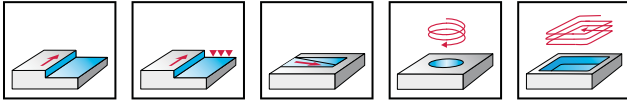
Xtra-tec®

- Approach angle $\kappa = 90^\circ$
- Two cutting edges per indexable insert
- Positive basic insert shapes



Tool	Designation	D_c mm	d_1 mm	l_4 mm	L_c mm	l_1 mm	Z	kg	No. of indexable inserts	Type
Cylindrical shank 	F4042.Z16.010.Z01.08	10	16	31	8	160	1	0,2	1	AD . . 0803 . .
	F4042.Z16.012.Z01.08	12	16	31	8	160	1	0,2	1	
	F4042.Z16.016.Z02.08	16	16	41	8	180	2	0,2	2	
	F4042.Z16.018.Z02.08	18	16	41	8	180	2	0,3	2	
	F4042.Z20.020.Z02.08	20	20	39	8	200	2	0,5	2	
	F4042.Z20.020.Z03.08	20	20	39	8	200	3	0,5	3	
	F4042.Z20.022.Z03.08	22	20	39	8	200	3	0,5	3	
	F4042.Z25.025.Z02.08	25	25	43	8	200	2	0,7	2	
	F4042.Z25.025.Z03.08	25	25	43	8	200	3	0,7	3	
	F4042.Z25.025.Z04.08	25	25	43	8	200	4	0,7	4	
Cyl. bore DIN 138 longitudinal key way 	F4042.B.040.Z06.08	40	16	40	8		6	0,2	6	AD . . 0803 . .
	F4042.B16.040.Z03.08	40	16	40	8		3	0,3	3	
	F4042.B16.040.Z04.08	40	16	40	8		4	0,2	4	
	F4042.B.050.Z07.08	50	22	40	8		7	0,4	7	
	F4042.B22.050.Z04.08	50	22	40	8		4	0,4	4	
	F4042.B22.050.Z05.08	50	22	40	8		5	0,4	5	

Bodies and assembly parts are included in the scope of delivery.

Assembly parts

D _c mm	10-12	16-50
	FS1455 (Torx 8 IP)	FS1454 (Torx 8 IP)
Tightening torque	1,2 Nm	1,2 Nm

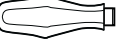
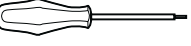
Accessories

D _c mm	10-50
	FS2001
	FS1483 (Torx 8IP)
	FS2012 (Torx 8IP)

Indexable inserts

Designation	Radius mm	Face chamfer width mm	P				M		K				N			S		H
			HC				HC		HC				HC	HW	DP	HC		HC
			WKP25	WKP35	WKP35S	WSP45	WSM35	WSP45	WAK15	WKK25	WKP25	WKP35	WKP35S	WXN15	WK10	WCD10	WSM35	WSP45
 ADGT0803PER-D51	0,4	1,2	☺	☺	☺	☺	☺	☺	☺	☺	☺	☺	☺	☺	☺	☺	☺	☺
ADGT0803PER-D56	0,4	1,2	☺	☺	☺	☺	☺	☺	☺	☺	☺	☺	☺	☺	☺	☺	☺	☺
ADGT0803PER-F56	0,4	1,2	☺	☺	☺	☺	☺	☺	☺	☺	☺	☺	☺	☺	☺	☺	☺	☺
ADHT0803PER-G88	0,4	1,2	☺	☺	☺	☺	☺	☺	☺	☺	☺	☺	☺	☺	☺	☺	☺	☺
ADKT0803PER-F56	0,4	1,2	☺	☺	☺	☺	☺	☺	☺	☺	☺	☺	☺	☺	☺	☺	☺	☺
ADMT080302R-F56	0,2	1,2	☺	☺	☺	☺	☺	☺	☺	☺	☺	☺	☺	☺	☺	☺	☺	☺
ADMT080304R-D56	0,4	1,2	☺	☺	☺	☺	☺	☺	☺	☺	☺	☺	☺	☺	☺	☺	☺	☺
ADMT080304R-F56	0,4	1,2	☺	☺	☺	☺	☺	☺	☺	☺	☺	☺	☺	☺	☺	☺	☺	☺
ADMT080304R-G56	0,4	1,2	☺	☺	☺	☺	☺	☺	☺	☺	☺	☺	☺	☺	☺	☺	☺	☺
ADMT080308R-F56	0,8	1,2	☺	☺	☺	☺	☺	☺	☺	☺	☺	☺	☺	☺	☺	☺	☺	☺
ADMT080312R-F56	1,2	1,0	☺	☺	☺	☺	☺	☺	☺	☺	☺	☺	☺	☺	☺	☺	☺	☺
ADMT080316R-F56	1,6	1,0	☺	☺	☺	☺	☺	☺	☺	☺	☺	☺	☺	☺	☺	☺	☺	☺
ADMT080320R-F56	2,0	1,0	☺	☺	☺	☺	☺	☺	☺	☺	☺	☺	☺	☺	☺	☺	☺	☺
ADMT080325R-F56	2,5	0,8	☺	☺	☺	☺	☺	☺	☺	☺	☺	☺	☺	☺	☺	☺	☺	☺

If the corner radius is $R = 1.6$ mm or above, the body in the corner section must be reworked:

$$R_{(\text{body})} = R_{(\text{insert})} - 1 \text{ mm}$$

HC = Coated carbide

HW = Uncoated carbide

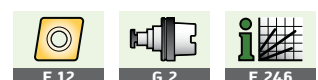
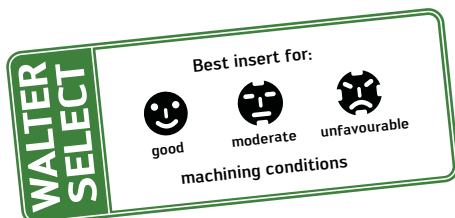

Shoulder mill F 4042R

AD . . 10T3

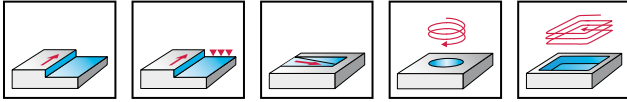
Xtra-tec®

- Approach angle $\kappa = 90^\circ$
- Two cutting edges per indexable insert
- Positive basic insert shapes
- Reinforced design

Tool	Designation	D _c mm	d ₁ mm	l ₄ mm	L _c mm	l ₁ mm	Z	kg	No. of indexable inserts	Type
NCT ScrewFit 	F4042R.T14.016.Z02.10*	16	T14	25	10		2	0,1	2	AD . . 10T3 . .
	F4042R.T18.020.Z02.10*	20	T18	30	10		2	0,1	2	
	F4042R.T18.020.Z03.10*	20	T18	30	10		3	0,1	3	
	F4042R.T22.025.Z02.10*	25	T22	35	10		2	0,1	2	
	F4042R.T22.025.Z03.10*	25	T22	35	10		3	0,1	3	
	F4042R.T22.025.Z04.10*	25	T22	35	10		4	0,1	4	
	F4042R.T28.032.Z03.10*	32	T28	35	10		3	0,2	3	
	F4042R.T28.032.Z04.10*	32	T28	35	10		4	0,2	4	
	F4042R.T28.032.Z05.10*	32	T28	35	10		5	0,1	5	
	F4042R.T36.040.Z04.10*	40	T36	40	10		4	0,4	4	
	F4042R.T36.040.Z05.10*	40	T36	40	10		5	0,4	5	
	F4042R.T36.040.Z06.10*	40	T36	40	10		6	0,4	6	
	F4042R.T45.050.Z05.10*	50	T45	40	10		5	0,5	5	
	F4042R.T45.050.Z06.10*	50	T45	40	10		6	0,5	6	
	F4042R.T45.050.Z07.10*	50	T45	40	10		7	0,6	7	
Shank DIN 1835-B 	F4042R.W16.016.Z02.10*	16	16	26	10	85	2	0,1	2	AD . . 10T3 . .
	F4042R.W20.020.Z02.10*	20	20	30	10	90	2	0,2	2	
	F4042R.W20.020.Z03.10*	20	20	30	10	90	3	0,2	3	
	F4042R.W25.025.Z02.10*	25	25	30	10	100	2	0,4	2	
	F4042R.W25.025.Z03.10*	25	25	30	10	100	3	0,3	3	
	F4042R.W25.025.Z04.10*	25	25	30	10	100	4	0,3	4	
	F4042R.W32.032.Z03.10*	32	32	30	10	110	3	0,6	3	
	F4042R.W32.032.Z04.10*	32	32	30	10	110	4	0,6	4	
	F4042R.W32.032.Z05.10*	32	32	30	10	110	5	0,6	5	

Bodies and assembly parts are included in the scope of delivery.

* Design balanced to G 6.3 where n = 10000 rpm

For flat wrenches for screw heads, see page G 105.

Assembly parts

D_c mm 16-50



Clamping screw for insert

FS1454 (Torx 8 IP)

Tightening torque

1,2 Nm

Accessories

D_c mm 16-50



Torque screwdriver

FS2001

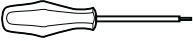

Screwdriver

FS1483 (Torx 8IP)



Interchangeable blade

FS2012 (Torx 8IP)

Indexable inserts

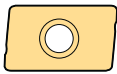
	Radius mm	Face chamfer width mm	P				M		K			N		S		H	
			HC				HC		HC			HC	HW	HC		HC	
			WKP25	WKP35	WKP35S	WSP45	WSM35	WSP45	WAK15	WKK25	WKP25	WKP35	WKP35S	WXN15	WK10	WSM35	WSP45
 ADGT10T316R-D67	1,6	1,2		☒	☒	☒	☒				☒	☒			☒	☒	
ADGT10T316R-G77	1,6	1,2				☒	☒								☒	☒	
ADGT10T325R-D67	2,5	1,0		☒	☒	☒	☒				☒	☒			☒	☒	
ADGT10T325R-G77	2,5	1,0				☒	☒								☒	☒	
ADGT10T330R-D67	3,0	0,8		☒	☒	☒	☒				☒	☒			☒	☒	
ADGT10T330R-G77	3,0	0,8				☒	☒								☒	☒	
ADGT10T332R-D67	3,2	0,8		☒	☒	☒	☒				☒	☒			☒	☒	
ADGT10T332R-G77	3,2	0,8				☒	☒								☒	☒	
ADGT10T3PER-D67	0,8	1,2		☒	☒	☒	☒				☒	☒			☒	☒	
ADGT10T3PER-G77	0,8	1,2				☒	☒								☒	☒	
ADHT10T3PER-G88	0,8	1,2										☒	☒				
ADKT10T3PER-F56	0,8	1,2	☒	☒	☒	☒	☒	☒	☒		☒	☒			☒	☒	
ADMT10T308R-F56	0,8	1,2	☒	☒	☒	☒	☒	☒	☒	☒	☒	☒			☒	☒	
ADMT10T308R-G56	0,8	1,2		☒	☒	☒	☒				☒	☒			☒	☒	
ADMT10T312R-F56	1,2	1,2		☒	☒	☒	☒				☒	☒			☒	☒	
ADMT10T316R-F56	1,6	1,2		☒	☒	☒	☒				☒	☒			☒	☒	
ADMT10T316R-G56	1,6	1,2		☒	☒	☒	☒				☒	☒			☒	☒	
ADMT10T320R-F56	2,0	1,0		☒	☒	☒	☒				☒	☒			☒	☒	
ADMT10T325R-F56	2,5	1,0		☒	☒	☒	☒				☒	☒			☒	☒	
ADMT10T325R-G56	2,5	1,0		☒	☒	☒	☒				☒	☒			☒	☒	
ADMT10T330R-F56	3,0	0,8		☒	☒	☒	☒				☒	☒			☒	☒	
ADMT10T332R-F56	3,2	0,8		☒	☒	☒	☒				☒	☒			☒	☒	
ADMT10T332R-G56	3,2	0,8		☒	☒	☒	☒				☒	☒			☒	☒	

If the corner radius is $R = 1.6$ mm or above, the body in the corner section must be reworked:

$$R_{(body)} = R_{(insert)} - 1 \text{ mm}$$

HC = Coated carbide

HW = Uncoated carbide

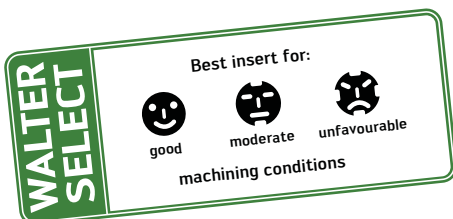

F 12



G 2



F 246

Shoulder mill F 4042R

AD . . 10T3

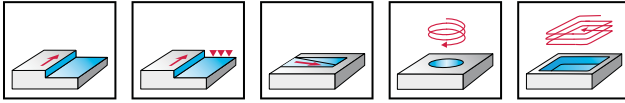
Xtra-tec®

- Approach angle $\kappa = 90^\circ$
- Two cutting edges per indexable insert
- Positive basic insert shapes
- Reinforced design

Tool	Designation	D_c mm	d_1 mm	l_4 mm	L_c mm	l_1 mm	Z	kg	No. of indexable inserts	Type
Cylindrical shank 	F4042R.Z16.016.Z02.10*	16	16	26	10	180	2	0,3	2	AD . . 10T3 . .
	F4042R.Z20.020.Z02.10*	20	20	30	10	200	2	0,3	2	
	F4042R.Z20.020.Z03.10*	20	20	30	10	200	3	0,8	3	
	F4042R.Z25.025.Z02.10*	25	25	32	10	200	2	0,7	2	
	F4042R.Z25.025.Z03.10*	25	25	32	10	200	3	0,7	3	
	F4042R.Z32.032.Z03.10*	32	32	40	10	200	3	1,2	3	
	F4042R.Z32.032.Z04.10*	32	32	40	10	200	4	1,2	4	
Cyl. bore DIN 138 longitudinal key way 	F4042R.B16.040.Z04.10*	40	16	40	10		4	0,2	4	AD . . 10T3 . .
	F4042R.B16.040.Z05.10*	40	16	40	10		5	0,2	5	
	F4042R.B16.040.Z06.10*	40	16	40	10		6	0,3	6	
	F4042R.B22.050.Z05.10*	50	22	40	10		5	0,4	5	
	F4042R.B22.050.Z06.10*	50	22	40	10		6	0,4	6	
	F4042R.B22.050.Z07.10*	50	22	40	10		7	0,4	7	
	F4042R.B22.063.Z06.10*	63	22	40	10		6	0,7	6	
	F4042R.B22.063.Z07.10*	63	22	40	10		7	0,7	7	
	F4042R.B22.063.Z09.10*	63	22	40	10		9	0,7	9	

Bodies and assembly parts are included in the scope of delivery.

 * Design balanced to G 6.3 where $n = 10000$ rpm

Assembly parts

D _c mm		16-63
	Clamping screw for insert	FS1454 (Torx 8 IP)
	Tightening torque	1,2 Nm

Accessories

D _c mm		16-63
	Torque screwdriver	FS2001
	Screwdriver	FS1483 (Torx 8IP)
	Interchangeable blade	FS2012 (Torx 8IP)

Indexable inserts

Designation	Radius mm	Face chamfer width mm	P				M		K			N		S		H	
			HC				HC		HC			HC	HW	HC		HC	
			WKP25	WKP35	WKP35S	WSP45	WSM35	WSP45	WAK15	WKK25	WKP25	WKP35	WKP35S	WXN15	WK10	WSM35	WSP45
ADGT10T316R-D67	1,6	1,2		⊗	⊗	⊗	⊗				⊗	⊗			⊗	⊗	
ADGT10T316R-G77	1,6	1,2				⊗	⊗								⊗	⊗	
ADGT10T325R-D67	2,5	1,0		⊗	⊗	⊗	⊗				⊗	⊗			⊗	⊗	
ADGT10T325R-G77	2,5	1,0				⊗	⊗								⊗	⊗	
ADGT10T330R-D67	3,0	0,8		⊗	⊗	⊗	⊗				⊗	⊗			⊗	⊗	
ADGT10T330R-G77	3,0	0,8				⊗	⊗								⊗	⊗	
ADGT10T332R-D67	3,2	0,8		⊗	⊗	⊗	⊗				⊗	⊗			⊗	⊗	
ADGT10T332R-G77	3,2	0,8				⊗	⊗								⊗	⊗	
ADGT10T3PER-D67	0,8	1,2		⊗	⊗	⊗	⊗				⊗	⊗			⊗	⊗	
ADGT10T3PER-G77	0,8	1,2				⊗	⊗								⊗	⊗	
ADHT10T3PER-G88	0,8	1,2										⊗	⊗				
ADKT10T3PER-F56	0,8	1,2	⊗	⊗	⊗	⊗	⊗	⊗		⊗	⊗				⊗	⊗	
ADMT10T308R-F56	0,8	1,2	⊗	⊗	⊗	⊗	⊗	⊗	⊗	⊗	⊗				⊗	⊗	
ADMT10T308R-G56	0,8	1,2		⊗	⊗	⊗	⊗	⊗			⊗	⊗			⊗	⊗	
ADMT10T312R-F56	1,2	1,2		⊗	⊗	⊗	⊗	⊗			⊗	⊗			⊗	⊗	
ADMT10T316R-F56	1,6	1,2		⊗	⊗	⊗	⊗	⊗			⊗	⊗			⊗	⊗	
ADMT10T316R-G56	1,6	1,2		⊗	⊗	⊗	⊗	⊗			⊗	⊗			⊗	⊗	
ADMT10T320R-F56	2,0	1,0		⊗	⊗	⊗	⊗	⊗			⊗	⊗			⊗	⊗	
ADMT10T325R-F56	2,5	1,0		⊗	⊗	⊗	⊗	⊗			⊗	⊗			⊗	⊗	
ADMT10T325R-G56	2,5	1,0		⊗	⊗	⊗	⊗	⊗			⊗	⊗			⊗	⊗	
ADMT10T330R-F56	3,0	0,8		⊗	⊗	⊗	⊗	⊗			⊗	⊗			⊗	⊗	
ADMT10T332R-F56	3,2	0,8		⊗	⊗	⊗	⊗	⊗			⊗	⊗			⊗	⊗	
ADMT10T332R-G56	3,2	0,8		⊗	⊗	⊗	⊗	⊗			⊗	⊗			⊗	⊗	

If the corner radius is R = 1.6 mm or above, the body in the corner section must be reworked:
 $R_{(body)} = R_{(insert)} - 1 \text{ mm}$

HC = Coated carbide
 HW = Uncoated carbide

WALTER SELECT

Best insert for:

good

moderate

unfavourable

machining conditions

F 12

G 2

F 246

Shoulder milling cutter F 4042

AD . . 1204

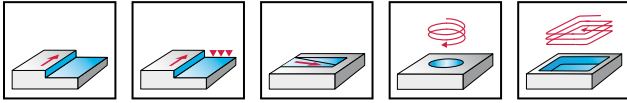
Xtra-tec®

- Approach angle $\kappa = 90^\circ$
- Two cutting edges per indexable insert
- Positive basic insert shapes

Tool	Designation	D_c mm	d_1 mm	l_4 mm	L_c mm	l_1 mm	Z	kg	No. of indexable inserts	Type
NCT ScrewFit 	F4042.T18.022.Z02.11*	22	T18	30	11,7		2	0,1	2	AD . . 1204 . .
	F4042.T22.025.Z02.11*	25	T22	35	11,7		2	0,1	2	
	F4042.T22.025.Z03.11*	25	T22	35	11,7		3	0,1	3	
	F4042.T28.032.Z02.11*	32	T28	40	11,7		2	0,2	2	
	F4042.T28.032.Z03.11*	32	T28	40	11,7		3	0,2	3	
	F4042.T28.032.Z04.11*	32	T28	40	11,7		4	0,2	4	
	F4042.T36.040.Z03.11*	40	T36	40	11,7		3	0,4	3	
	F4042.T36.040.Z04.11*	40	T36	40	11,7		4	0,4	4	
	F4042.T36.040.Z05.11*	40	T36	40	11,7		5	0,4	5	
	F4042.T45.050.Z03.11*	50	T45	40	11,7		3	0,7	3	
	F4042.T45.050.Z04.11*	50	T45	40	11,7		4	0,5	4	
	F4042.T45.050.Z06.11*	50	T45	40	11,7		6	0,5	6	
Shank DIN 1835-B 	F4042.W25.025.Z02.11	25	25	43	11,7	100	2	0,3	2	AD . . 1204 . .
	F4042.W25.025.Z03.11	25	25	43	11,7	100	3	0,3	3	
	F4042.W32.032.Z02.11	32	32	49	11,7	110	2	0,6	2	
	F4042.W32.032.Z03.11	32	32	49	11,7	110	3	0,6	3	
	F4042.W32.032.Z04.11	32	32	49	11,7	110	4	0,6	4	
	F4042.W32.040.Z05.11	40	32	49	11,7	110	5	0,7	5	
	F4042.W40.040.Z03.11	40	40	49	11,7	120	3	1,1	3	
	F4042.W40.040.Z04.11	40	40	49	11,7	120	4	1,1	4	
Cylindrical shank 	F4042.Z20.022.Z02.11	22	20	38	11,7	200	2	0,5	2	AD . . 1204 . .
	F4042.Z25.025.Z02.11	25	25	38	11,7	200	2	0,7	2	
	F4042.Z25.025.Z03.11	25	25	38	11,7	200	3	0,7	3	
	F4042.Z32.032.Z02.11	32	32	39	11,7	250	2	1,5	2	
	F4042.Z32.032.Z03.11	32	32	39	11,7	250	3	1,5	3	
	F4042.Z32.032.Z04.11	32	32	39	11,7	250	4	1,5	4	
	F4042.Z32.040.Z05.11	40	32	44	11,7	250	5	1,6	5	
	F4042.Z40.040.Z03.11	40	40	44	11,7	250	3	2,3	3	
	F4042.Z40.040.Z04.11	40	40	44	11,7	250	4	2,3	4	

Bodies and assembly parts are included in the scope of delivery.

For flat wrenches for screw heads, see page G 105.

 * Design balanced to G 6.3 where $n = 10000$ rpm

Assembly parts

	D _c mm	22-25	32-50
	Clamping screw for insert	FS1456 (Torx 9 IP)	FS1457 (Torx 9 IP)
	Tightening torque	2,0 Nm	2,0 Nm

Accessories

	D _c mm	22-50
	Torque screwdriver	FS2003
	Screwdriver	FS1484 (Torx 9IP)
	Interchangeable blade	FS2013 (Torx 9IP)

Indexable inserts

Designation	Radius mm	Face chamfer width mm	P		M		K				N		S		H		
			HC		HC		HC				HC	HW	HC		HC		
			WKP25	WKP35	WKP35S	WSP45	WSM35	WSP45	WAK15	WKK25	WKP25	WKP35	WKP35S	WXN15	WK10	WSM35	WSP45
ADGT120416R-D67	1,6	1,0		☒	☒	☒	☒								☒	☒	
ADGT120430R-D67	3,0	0,8		☒	☒	☒	☒								☒	☒	
ADGT1204PER-D51	0,8	1,2	☒	☒	☒	☒			☒	☒	☒					☒	
ADGT1204PER-D56	0,8	1,2	☒	☒	☒	☒			☒	☒	☒				☒	☒	
ADGT1204PER-D67	0,8	1,2		☒	☒	☒			☒	☒	☒				☒	☒	
ADGT1204PER-F56	0,8	1,2				☒	☒								☒	☒	
ADGT1204PER-G77	0,8	1,2				☒	☒								☒	☒	
ADHT120416R-G88	1,6	1,0										☒	☒				
ADHT120425R-G88	2,5	0,8										☒	☒				
ADHT120430R-G88	3,0	0,8										☒	☒				
ADHT120440R-G88	4,0	0,4										☒	☒				
ADHT1204PER-G88	0,8	1,2										☒	☒				
ADMT120404R-F56	0,4	1,2		☒	☒	☒	☒				☒				☒	☒	
ADMT120408R-D56	0,8	1,2	☒	☒	☒	☒		☒	☒	☒	☒				☒	☒	
ADMT120408R-F56	0,8	1,2	☒	☒	☒	☒		☒	☒	☒	☒				☒	☒	
ADMT120408R-G56	0,8	1,2		☒	☒	☒	☒				☒				☒	☒	
ADMT120412R-F56	1,2	1,2	☒	☒	☒	☒			☒	☒	☒				☒	☒	
ADMT120416R-F56	1,6	1,0		☒	☒	☒	☒				☒				☒	☒	
ADMT120420R-F56	2,0	1,0		☒	☒	☒	☒				☒				☒	☒	
ADMT120425R-F56	2,5	0,8		☒	☒	☒	☒				☒				☒	☒	
ADMT120430R-F56	3,0	0,8		☒	☒	☒	☒				☒				☒	☒	
ADMT120432R-F56	3,2	0,8		☒	☒	☒	☒				☒				☒	☒	
ADMT120440R-F56	4,0	0,4		☒	☒	☒	☒				☒				☒	☒	

If the corner radius is R = 2.0 mm or above, the body in the corner section must be reworked:
 $R_{(body)} = R_{(insert)} - 1 \text{ mm}$

HC = Coated carbide
 HW = Uncoated carbide

WALTER SELECT

Best insert for:

☺
good

☹
moderate

☹
unfavourable

machining conditions

F 12

G 2

F 246

Shoulder milling cutter F 4042 AD . . 1204

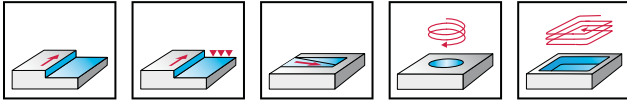
Xtra-tec®

- Approach angle $\kappa = 90^\circ$
- Two cutting edges per indexable insert
- Positive basic insert shapes

Tool	Designation	D_c mm	d_1 mm	l_4 mm	L_c mm	Z	kg	No. of indexable inserts	Type
Cyl. bore DIN 138 longitudinal key way 	F4042.B.040.Z03.11*	40	16	40	11,7	3	0,2	3	AD . . 1204 . .
	F4042.B.040.Z05.11	40	16	40	11,7	5	0,2	5	
	F4042.B16.040.Z04.11	40	16	40	11,7	4	0,2	4	
	F4042.B22.050.Z03.11	50	22	40	11,7	3	0,4	3	
	F4042.B.050.Z06.11	50	22	40	11,7	6	0,4	6	
	F4042.B.050.Z04.11*	50	22	40	11,7	4	0,3	4	
	F4042.B27.063.Z05.11*	63	27	50	11,7	5	0,7	5	
	F4042.B27.063.Z04.11	63	27	50	11,7	4	0,8	4	
	F4042.B22.063.Z04.11	63	22	40	11,7	4	0,6	4	
	F4042.B.063.Z07.11	63	22	40	11,7	7	0,6	7	
	F4042.B.063.Z05.11*	63	22	40	11,7	5	0,6	5	
	F4042.B27.063.Z07.11	63	27	50	11,7	7	0,6	7	
	F4042.B.080.Z06.11*	80	27	50	11,7	6	1,1	6	
	F4042.B.080.Z08.11	80	27	50	11,7	8	1,1	8	
	F4042.B27.080.Z05.11	80	27	50	11,7	5	1,1	5	

Bodies and assembly parts are included in the scope of delivery.

 * Design balanced to G 6.3 where $n = 10000$ rpm

Assembly parts

	D_c mm	40-80
	Clamping screw for insert	FS1457 (Torx 9 IP)
	Tightening torque	2,0 Nm

Accessories

	D_c mm	40-80
	Torque screwdriver	FS2003
	Screwdriver	FS1484 (Torx 9IP)
	Interchangeable blade	FS2013 (Torx 9IP)

Indexable inserts

Designation	Radius mm	Face chamfer width mm	P		M		K				N		S		H	
			HC		HC		HC				HC	HW	HC		HC	
			WKP25	WKP35	WKP35S	WSP45	WSM35	WSP45	WAK15	WKK25	WKP25	WKP35	WKP35S	WXN15	WK10	WSM35
ADGT120416R-D67	1,6	1,0														
ADGT120430R-D67	3,0	0,8														
ADGT1204PER-D51	0,8	1,2														
ADGT1204PER-D56	0,8	1,2														
ADGT1204PER-D67	0,8	1,2														
ADGT1204PER-F56	0,8	1,2														
ADGT1204PER-G77	0,8	1,2														
ADHT120416R-G88	1,6	1,0														
ADHT120425R-G88	2,5	0,8														
ADHT120430R-G88	3,0	0,8														
ADHT120440R-G88	4,0	0,4														
ADHT1204PER-G88	0,8	1,2														
ADMT120404R-F56	0,4	1,2														
ADMT120408R-D56	0,8	1,2														
ADMT120408R-F56	0,8	1,2														
ADMT120408R-G56	0,8	1,2														
ADMT120412R-F56	1,2	1,2														
ADMT120416R-F56	1,6	1,0														
ADMT120420R-F56	2,0	1,0														
ADMT120425R-F56	2,5	0,8														
ADMT120430R-F56	3,0	0,8														
ADMT120432R-F56	3,2	0,8														
ADMT120440R-F56	4,0	0,4														

If the corner radius is R = 2.0 mm or above, the body in the corner section must be reworked:
 $R_{(body)} = R_{(insert)} - 1 \text{ mm}$

HC = Coated carbide
 HW = Uncoated carbide

WALTER SELECT

Best insert for:

good

moderate

unfavourable

machining conditions

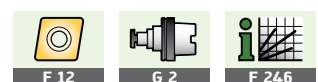

Shoulder milling cutter F 4042

AD . . 1606

Xtra-tec®

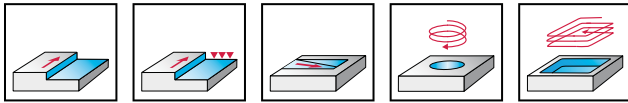

- Approach angle $\kappa = 90^\circ$
- Two cutting edges per indexable insert
- Positive basic insert shapes

Tool	Designation	D _c mm	d ₁ mm	l ₄ mm	L _c mm	Z	kg	No. of indexable inserts	Type
NCT ScrewFit 	F4042.T36.040.Z03.15*	40	T36	40	15	3	0,2	3	AD . . 1606 . .
	F4042.T36.040.Z04.15*	40	T36	40	15	4	0,3	4	
	F4042.T45.050.Z03.15*	50	T45	40	15	3	0,5	3	
	F4042.T45.050.Z05.15*	50	T45	40	15	5	0,5	5	
Cyl. bore DIN 138 longitudinal key way 	F4042.B.040.Z03.15*	40	16	40	15	3	0,2	3	AD . . 1606 . .
	F4042.B.040.Z04.15	40	16	40	15	4	0,2	4	
	F4042.B.050.Z03.15*	50	22	40	15	3	0,3	3	
	F4042.B.050.Z05.15	50	22	40	15	5	0,3	5	
	F4042.B.063.Z06.15	63	22	40	15	6	0,6	6	
	F4042.B.063.Z04.15*	63	22	40	15	4	0,6	4	
	F4042.B27.063.Z06.15	63	27	50	15	6	0,4	6	
	F4042.B27.063.Z04.15*	63	27	50	15	4	0,6	4	
	F4042.B27.080.Z04.15	80	27	50	15	4	1,1	4	
	F4042.B.080.Z05.15*	80	27	50	15	5	1,0	5	
	F4042.B.080.Z07.15	80	27	50	15	7	1,1	7	
	F4042.B.100.Z05.15*	100	32	50	15	5	1,6	5	
	F4042.B.100.Z08.15	100	32	50	15	8	1,8	8	
	F4042.B32.100.Z04.15	100	32	50	15	4	1,7	4	
	F4042.B.125.Z07.15*	125	40	63	15	7	3,2	7	
F4042.B.125.Z10.15	125	40	63	15	10	3,5	10		
F4042.B40.125.Z05.15	125	40	63	15	5	3,3	5		
Cyl. bore DIN 138 longitudinal key way 	F4042.B.160.Z08.15*	160	40/40 B	63	15	8	4,2	8	AD . . 1606 . .
	F4042.B.160.Z12.15	160	40/40 B	63	15	12	4,4	12	
	F4042.B40.160.Z06.15	160	40/40 B	63	15	6	4,2	6	

Bodies and assembly parts are included in the scope of delivery.

For flat wrenches for screw heads, see page G 105.

* Design balanced to G 6.3 where n = 10000 rpm

Assembly parts

	D _c mm	40-160
	Clamping screw for insert	FS1453 (Torx 15 IP)
	Tightening torque	3,5 Nm

Accessories

	D _c mm	40-125	160
	Gasket		O-R 96X4
	Sealing disc set, complete (incl. gasket + screws)		FS936 COMPLETE SET
	Torque screwdriver	FS2003	FS2003
	Screwdriver	FS1485 (Torx 15IP)	FS1485 (Torx 15IP)
	Interchangeable blade	FS2014 (Torx 15IP)	FS2014 (Torx 15IP)

Indexable inserts

Designation	Radius mm	Face chamfer width mm	P				M		K				N		S		H	
			HC	HC	HC	HC	HC	HC	HC	HC	HC	HW	HC	HC	HC			
			WKP25	WKP35	WKP35S	WSP45	WSM35	WSP45	WAK15	WKK25	WKP25	WKP35	WKP35S	WXN15	WK10	WSM35	WSP45	WHH15
ADGT1606PER-D51	0,8	1,6	☺	☺	☺	☺	☺	☺		☺	☺	☺	☺			☺	☺	
ADGT1606PER-D56	0,8	1,6	☺	☺	☺	☺	☺	☺		☺	☺	☺	☺			☺	☺	
ADGT1606PER-F56	0,8	1,6				☺	☺	☺								☺	☺	
ADHT160616R-G88	1,6	1,4												☺	☺			
ADHT160625R-G88	2,5	1,2												☺	☺			
ADHT160630R-G88	3,0	1,2												☺	☺			
ADHT160640R-G88	4,0	1,0												☺	☺			
ADHT1606PER-G88	0,8	1,6												☺	☺			
ADKT1606PER-F56	0,8	1,6	☺	☺	☺	☺	☺	☺	☺	☺	☺	☺	☺					☺
ADMT160608R-D56	0,8	1,6	☺	☺	☺	☺	☺	☺	☺	☺	☺	☺	☺					☺
ADMT160608R-F56	0,8	1,6	☺	☺	☺	☺	☺	☺	☺	☺	☺	☺	☺					☺
ADMT160608R-G56	0,8	1,6		☺	☺	☺	☺	☺								☺	☺	
ADMT160612R-F56	1,2	1,6		☺	☺	☺	☺	☺								☺	☺	
ADMT160616R-F56	1,6	1,4		☺	☺	☺	☺	☺								☺	☺	
ADMT160620R-F56	2,0	1,4		☺	☺	☺	☺	☺								☺	☺	
ADMT160625R-F56	2,5	1,2		☺	☺	☺	☺	☺								☺	☺	
ADMT160630R-F56	3,0	1,2		☺	☺	☺	☺	☺								☺	☺	
ADMT160632R-F56	3,2	1,2		☺	☺	☺	☺	☺								☺	☺	
ADMT160640R-F56	4,0	1,0		☺	☺	☺	☺	☺								☺	☺	
ADMT160650R-F56	5,0	-		☺	☺	☺	☺	☺								☺	☺	
ADMT160660R-F56	6,0	-		☺	☺	☺	☺	☺								☺	☺	

If the corner radius is R = 2.0 mm or above, the body in the corner section must be reworked:

$$R_{(body)} = R_{(insert)} - 1 \text{ mm}$$

HC = Coated carbide

HW = Uncoated carbide

WALTER SELECT

Best insert for:

☺
good

☹
moderate

☹
unfavourable

machining conditions

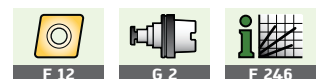

Shoulder milling cutter F 4042

AD . . 1807

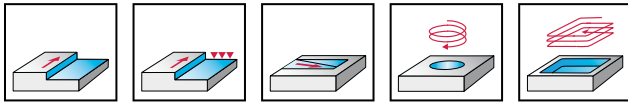
Xtra-tec®

- Approach angle $\kappa = 90^\circ$
- Two cutting edges per indexable insert
- Positive basic insert shapes

Tool	Designation	D _c mm	d ₁ mm	l ₄ mm	L _c mm	Z	kg	No. of indexable inserts	Type
NCT ScrewFit	F4042.T45.050.Z03.16	50	T45	40	16,7	3	0,5	3	AD . . 1807 . .
	F4042.T45.050.Z04.16*	50	T45	40	16,7	4	0,4	4	
Cyl. bore DIN 138 longitudinal key way	F4042.B27.063.Z04.16	63	27	50	16,7	4	0,7	4	AD . . 1807 . .
	F4042.B27.063.Z05.16*	63	27	50	16,7	5	0,6	5	
	F4042.B27.080.Z05.16	80	27	50	16,7	5	1,1	5	
	F4042.B27.080.Z06.16*	80	27	50	16,7	6	1,0	6	
	F4042.B32.100.Z06.16	100	32	50	16,7	6	1,8	6	
	F4042.B32.100.Z07.16*	100	32	50	16,7	7	1,8	7	
	F4042.B40.125.Z06.16	125	40	63	16,7	6	3,5	6	
	F4042.B40.125.Z08.16*	125	40	63	16,7	8	3,2	8	
Cyl. bore DIN 138 longitudinal key way	F4042.B40.160.Z08.16	160	40/40 B	63	16,7	8	4,3	8	AD . . 1807 . .
	F4042.B40.160.Z10.16*	160	40/40 B	63	16,7	10	4,0	10	

Bodies and assembly parts are included in the scope of delivery.





For flat wrenches for screw heads, see page G 105.

* Design balanced to G 6.3 where n = 10000 rpm

Assembly parts

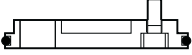
	D _c mm	50-160
	Clamping screw for insert	FS1495 (Torx 20 IP)
	Tightening torque	5,0 Nm

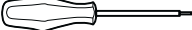
Accessories

	D _c mm	50-125	160
	Gasket		O-R 96X4
	Sealing disc set, complete (incl. gasket and screws)		FS936 COMPLETE SET
	Torque screwdriver	FS2003	FS2003
	Screwdriver	FS1486 (Torx 20IP)	FS1486 (Torx 20IP)
	Interchangeable blade	FS2015 (Torx 20IP)	FS2015 (Torx 20IP)

Indexable inserts

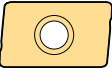
Designation	Radius mm	Face chamfer width mm	P				M		K				N		S		H	
			HC				HC		HC				HC	HW	HC		HC	
			WKP25	WKP35	WKP35S	WSP45	WSM35	WSP45	WAK15	WKK25	WKP25	WKP35	WKP35S	WXN15	WK10	WSM35	WSP45	WHH15
 ADGT1807PER-D51	1,2	1,8	☺	☺	☺	☺	☺	☺			☺	☺	☺					
ADGT1807PER-D56	1,2	1,8	☺	☺	☺	☺	☺	☺			☺	☺	☺			☺	☺	
ADMT180712R-D56	1,2	1,8	☺	☺	☺	☺	☺	☺		☺	☺	☺	☺				☺	
ADMT180712R-F56	1,2	1,8	☺	☺	☺	☺	☺	☺		☺	☺	☺	☺				☺	

HC = Coated carbide
HW = Uncoated carbide

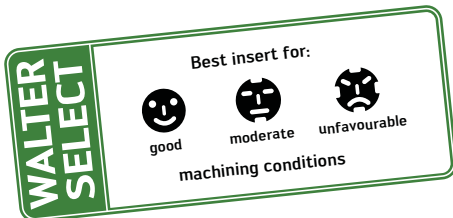

Porcupine cutter F 2338 F

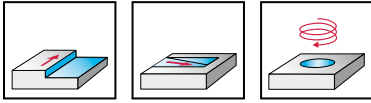

- Approach angle $\kappa = 90^\circ$
- Two / four cutting edges per indexable insert
- Positive basic insert shapes
- Full effective teeth

Tool	Designation	D_c mm	d_1 mm	l_4 mm	l_{16} mm	L_c mm	Z	kg	No. of indexable inserts	Type
Modular adaptor NCT	F2338F.N8.063.Z03.81	63	NCT 80	135	106	81	3	2,7	3 18	LP .. 1506 .. SP .. 1206 ..
	F2338F.N8.080.Z05.103	80	NCT 80	155	132	103	5	4,3	5 40	
Cyl. bore DIN 138 longitudinal key way	F2338F.B.063.Z03.48	63	27	70		48	3	0,9	3 9	LP .. 1506 .. SP .. 1206 ..
	F2338F.B.066.Z03.48	66	27	70		48	3	1,0	3 9	
	F2338F.B.066.Z04.48	66	27	70		48	4	1,0	4 12	
	F2338F.B.080.Z04.59	80	32	80		59	4	1,8	4 16	
	F2338F.B.080.Z05.70	80	32	95		70	5	2,2	5 25	
	F2338F.B.085.Z04.59	85	32	85		59	4	2,3	4 16	
	F2338F.B.085.Z05.70	85	32	95		70	5	2,6	5 25	
	F2338F.B.100.Z06.81	100	40	105		81	6	4,2	6 36	

Bodies and assembly parts are included in the scope of delivery.
For special clamping screws for arbour mounted tools, see page G 115.

Assembly parts

D_c mm 63-100



Clamping screw for insert LP . . . FS1153 (Torx 20)

Tightening torque 5,0 Nm



Clamping screw for insert SP . . . FS1031 (Torx 20)

Tightening torque 5,0 Nm

Accessories

D_c mm 63-100

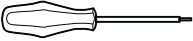

Screwdriver

FS228 (Torx 20)

Indexable inserts

Designation	Radius mm	Face chamfer width mm	P		M		K			N		S		H			
			HC		HC		HC			HC	HW	HC		HC			
			WKP25	WKP35	WKP35S	WSP45	WSM35	WSP45	WAK15	WKK25	WKP25	WKP35	WKP35S	WXN15	WK10	WSM35	WSP45
	LPGT1506PPR-F57	1,2	1,6	☒	☒	☒	☒	☒	☒	☒	☒	☒	☒	☒	☒	☒	
	LPHW150612R-A51	1,2	-	☒	☒	☒				☒	☒	☒			☒	☒	
	LPHW1506PPR-A57	1,2	1,6	☒	☒	☒		☒		☒	☒	☒			☒	☒	
	LPMT150612R-D51	1,2	-	☒	☒	☒	☒			☒	☒	☒			☒	☒	
	LPMT150612R-D57	1,2	-	☒	☒	☒	☒	☒	☒	☒	☒	☒			☒	☒	
	LPMW150612TR-A27	1,2	-	☒	☒	☒				☒	☒	☒			☒	☒	
	SPGT120606-F57	0,6	-	☒	☒	☒	☒			☒	☒			☒	☒		
	SPHW120606-A51	0,6	-	☒	☒	☒				☒	☒			☒	☒		
	SPHW120606-A57	0,6	-	☒	☒	☒		☒		☒	☒			☒	☒		
	SPMT120606-D51	0,6	-	☒	☒	☒	☒			☒	☒			☒	☒		
	SPMT120606-D57	0,6	-	☒	☒	☒	☒	☒	☒	☒	☒			☒	☒		
	SPMW120606T-A27	0,6	-	☒	☒	☒				☒	☒	☒			☒	☒	

HC = Coated carbide
HW = Uncoated carbide

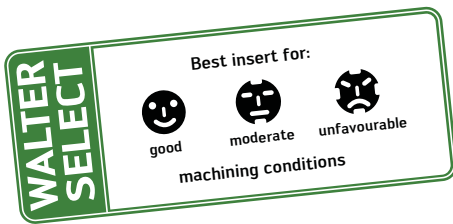

Porcupine cutter F 4038

AD . . 0803

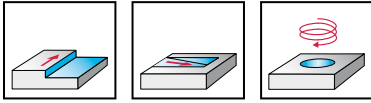
Xtra-tec®



- Approach angle $\kappa = 90^\circ$
- Two cutting edges per indexable insert
- Positive basic insert shapes
- Full effective teeth

Tool	Designation	D_c mm	d_1 mm	l_4 mm	l_1 mm	L_c mm	Z	kg	No. of indexable inserts	Type
NCT ScrewFit 	F4038.T18.020.Z01.15	20	T18	30		15	1	0,1	3	AD . . 0803 . .
	F4038.T22.025.Z02.22	25	T22	40		22	2	0,1	6	
	F4038.T28.032.Z03.30	32	T28	50		30	3	0,2	12	
Shank DIN 1835-B 	F4038.W20.020.Z01.30	20	20	45	96	30	1	0,2	5	AD . . 0803 . .
	F4038.W25.025.Z02.30	25	25	50	100	30	2	0,4	8	
	F4038.W32.032.Z03.30	32	32	50	105	30	3	0,6	12	
	F4038.W32.032.Z03.37	32	32	50	111	37	3	0,5	15	



Bodies and assembly parts are included in the scope of delivery.

For flat wrenches for screw heads, see page G 105.

Assembly parts

	D _c mm	20	25-32
	Clamping screw for insert	FS1455 (Torx 8 IP)	FS1454 (Torx 8 IP)
	Tightening torque	1,2 Nm	1,2 Nm

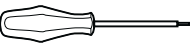
Accessories

	D _c mm	20-32
	Torque screwdriver	FS2001
	Screwdriver	FS1483 (Torx 8IP)
	Interchangeable blade	FS2012 (Torx 8IP)

Indexable inserts

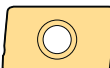
Designation	Radius mm	Face chamfer width mm	P				M		K				N		S		H	
			WKP25	WKP35	WKP35S	WSP45	WSM35	WSP45	WAK15	WKK25	WKP25	WKP35	WKP35S	WXN15	WK10	WSM35		WSP45
 ADGT0803PER-D51	0,4	1,2	☺	☺	☺	☺	☺	☺	☺	☺	☺	☺	☺	☺	☺	☺	☺	☺
ADGT0803PER-D56	0,4	1,2	☺	☺	☺	☺	☺	☺	☺	☺	☺	☺	☺	☺	☺	☺	☺	☺
ADGT0803PER-F56	0,4	1,2	☺	☺	☺	☺	☺	☺	☺	☺	☺	☺	☺	☺	☺	☺	☺	☺
ADHT0803PER-G88	0,4	1,2	☺	☺	☺	☺	☺	☺	☺	☺	☺	☺	☺	☺	☺	☺	☺	☺
ADKT0803PER-F56	0,4	1,2	☺	☺	☺	☺	☺	☺	☺	☺	☺	☺	☺	☺	☺	☺	☺	☺
ADMT080302R-F56	0,2	1,2	☺	☺	☺	☺	☺	☺	☺	☺	☺	☺	☺	☺	☺	☺	☺	☺
ADMT080304R-D56	0,4	1,2	☺	☺	☺	☺	☺	☺	☺	☺	☺	☺	☺	☺	☺	☺	☺	☺
ADMT080304R-F56	0,4	1,2	☺	☺	☺	☺	☺	☺	☺	☺	☺	☺	☺	☺	☺	☺	☺	☺
ADMT080304R-G56	0,4	1,2	☺	☺	☺	☺	☺	☺	☺	☺	☺	☺	☺	☺	☺	☺	☺	☺
ADMT080308R-F56	0,8	1,2	☺	☺	☺	☺	☺	☺	☺	☺	☺	☺	☺	☺	☺	☺	☺	☺
ADMT080312R-F56	1,2	1,0	☺	☺	☺	☺	☺	☺	☺	☺	☺	☺	☺	☺	☺	☺	☺	☺
ADMT080316R-F56	1,6	1,0	☺	☺	☺	☺	☺	☺	☺	☺	☺	☺	☺	☺	☺	☺	☺	☺
ADMT080320R-F56	2,0	1,0	☺	☺	☺	☺	☺	☺	☺	☺	☺	☺	☺	☺	☺	☺	☺	☺
ADMT080325R-F56	2,5	0,8	☺	☺	☺	☺	☺	☺	☺	☺	☺	☺	☺	☺	☺	☺	☺	☺

If the corner radius is $R = 1.6$ mm or above, the body in the corner section must be reworked:

$$R_{(\text{body})} = R_{(\text{insert})} - 1 \text{ mm}$$

HC = Coated carbide

HW = Uncoated carbide

Indexable inserts with corner radius $R > 0.4$ mm can only be used as front inserts.

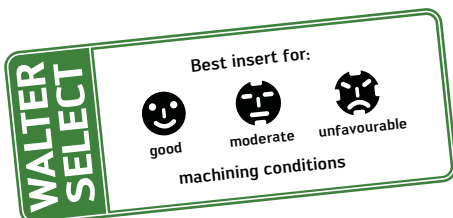

Porcupine cutter F 4138

AD . . 1204

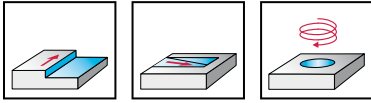
Xtra-tec®

- Approach angle $\kappa = 90^\circ$
- Two cutting edges
- Positive basic insert shapes
- Full effective teeth

Tool	Designation	D _c mm	d ₁ mm	l ₄ mm	L ₁₆ mm	l ₁ mm	L _c mm	Z	kg	No. of indexable inserts	Type
NCT ScrewFit	F4138.T28.032.Z02.33	32	T28	50			33	2	0,2	6	AD . . 1204 . .
	F4138.T36.040.Z03.33	40	T36	55			33	3	0,4	9	
Shank DIN 1835-B	F4138.W32.032.Z02.43	32	32	64		125	43	2	0,6	8	AD . . 1204 . .
	F4138.W40.040.Z03.54	40	40	79		150	54	3	1,0	15	
SK DIN 69871-AD/B	F4138.S4.040.Z03.54	40	SK40 AD/B	100	64		54	3	1,3	15	AD . . 1204 . .
	F4138.S5.040.Z03.65	40	SK50 AD/B	120	75		65	3	3,4	18	
Modular adaptor NCT	F4138.N6.040.Z03.54	40	NCT 63	105	69		54	3	1,1	15	AD . . 1204 . .
	F4138.N8.050.Z04.65	50	NCT 80	116	80		65	4	1,9	24	
	F4138.N8.063.Z05.76	63	NCT 80	125	99		76	5	2,5	35	
HSK DIN 69893/1-A	F4138.H63A.040.Z03.54	40	HSK- A63	101	64		54	3	1,1	15	AD . . 1204 . .
	F4138.H100A.050.Z04.43	50	HSK- A100	100	53		43	4	2,7	16	
	F4138.H63A.050.Z04.43	50	HSK- A63	90	53		43	4	1,3	16	
Cyl. bore DIN 138 longitudinal key way	F4138.B16.040.Z03.33	40	16	55			33	3	0,3	9	AD . . 1204 . .
	F4138.B16.040.Z03.43	40	16	65			43	3	0,3	12	
	F4138.B22.050.Z04.43	50	22	65			43	4	0,5	16	
	F4138.B22.050.Z04.54	50	22	75			54	4	0,6	20	
	F4138.B27.063.Z05.43	63	27	70			43	5	1,0	20	
	F4138.B27.063.Z05.54	63	27	80			54	5	1,0	25	
	F4138.B32.080.Z06.54	80	32	85			54	6	2,1	30	
F4138.B32.080.Z06.65	80	32	95			65	6	2,4	36		

Bodies and assembly parts are included in the scope of delivery.

For flat wrenches for screw heads, see page G 105.

For HSK accessories, see page H 42.

For special clamping screws for arbour mounted tools, see page G 115.

For pull studs for steep tapers, see page H 42.

Assembly parts

D _c mm		32-80
	Clamping screw for insert	FS1457 (Torx 9 IP)
	Tightening torque	2,0 Nm

Accessories

D _c mm		32-80
	Torque screwdriver	FS2003
	Screwdriver	FS1484 (Torx 9IP)
	Interchangeable blade	FS2013 (Torx 9IP)

Indexable inserts

Designation	Radius mm	Face chamfer width mm	P		M		K				N		S		H		
			HC		HC		HC				HC	HW	HC		HC		
			WKP25	WKP35	WKP35S	WSP45	WSM35	WSP45	WAK15	WKK25	WKP25	WKP35	WKP35S	WXN15	WK10	WSM35	WSP45
	ADGT120416R-D67	1,6	1,0	☒	☒	☒	☒	☒	☒	☒	☒	☒	☒	☒	☒	☒	
	ADGT120430R-D67	3,0	0,8	☒	☒	☒	☒	☒	☒	☒	☒	☒	☒	☒	☒	☒	
	ADGT1204PER-D51	0,8	1,2	☒	☒	☒	☒	☒	☒	☒	☒	☒	☒	☒	☒	☒	
	ADGT1204PER-D56	0,8	1,2	☒	☒	☒	☒	☒	☒	☒	☒	☒	☒	☒	☒	☒	
	ADGT1204PER-D67	0,8	1,2	☒	☒	☒	☒	☒	☒	☒	☒	☒	☒	☒	☒	☒	
	ADGT1204PER-F56	0,8	1,2	☒	☒	☒	☒	☒	☒	☒	☒	☒	☒	☒	☒	☒	
	ADGT1204PER-G77	0,8	1,2	☒	☒	☒	☒	☒	☒	☒	☒	☒	☒	☒	☒	☒	
	ADHT120416R-G88	1,6	1,0	☒	☒	☒	☒	☒	☒	☒	☒	☒	☒	☒	☒	☒	
	ADHT120425R-G88	2,5	0,8	☒	☒	☒	☒	☒	☒	☒	☒	☒	☒	☒	☒	☒	
	ADHT120430R-G88	3,0	0,8	☒	☒	☒	☒	☒	☒	☒	☒	☒	☒	☒	☒	☒	
	ADHT120440R-G88	4,0	0,4	☒	☒	☒	☒	☒	☒	☒	☒	☒	☒	☒	☒	☒	
	ADHT1204PER-G88	0,8	1,2	☒	☒	☒	☒	☒	☒	☒	☒	☒	☒	☒	☒	☒	
	ADMT120404R-F56	0,4	1,2	☒	☒	☒	☒	☒	☒	☒	☒	☒	☒	☒	☒	☒	
	ADMT120408R-D56	0,8	1,2	☒	☒	☒	☒	☒	☒	☒	☒	☒	☒	☒	☒	☒	
	ADMT120408R-F56	0,8	1,2	☒	☒	☒	☒	☒	☒	☒	☒	☒	☒	☒	☒	☒	
	ADMT120408R-G56	0,8	1,2	☒	☒	☒	☒	☒	☒	☒	☒	☒	☒	☒	☒	☒	
	ADMT120412R-F56	1,2	1,2	☒	☒	☒	☒	☒	☒	☒	☒	☒	☒	☒	☒	☒	
	ADMT120416R-F56	1,6	1,0	☒	☒	☒	☒	☒	☒	☒	☒	☒	☒	☒	☒	☒	
	ADMT120420R-F56	2,0	1,0	☒	☒	☒	☒	☒	☒	☒	☒	☒	☒	☒	☒	☒	
	ADMT120425R-F56	2,5	0,8	☒	☒	☒	☒	☒	☒	☒	☒	☒	☒	☒	☒	☒	
	ADMT120430R-F56	3,0	0,8	☒	☒	☒	☒	☒	☒	☒	☒	☒	☒	☒	☒	☒	
	ADMT120432R-F56	3,2	0,8	☒	☒	☒	☒	☒	☒	☒	☒	☒	☒	☒	☒	☒	
	ADMT120440R-F56	4,0	0,4	☒	☒	☒	☒	☒	☒	☒	☒	☒	☒	☒	☒	☒	

If the corner radius is R = 2.0 mm or above, the body in the corner section must be reworked:

$$R_{(\text{body})} = R_{(\text{insert})} - 1 \text{ mm}$$

HC = Coated carbide

HW = Uncoated carbide

Indexable inserts with corner radius R > 0.8 mm can only be used as front inserts.

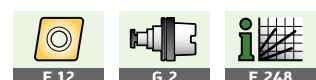
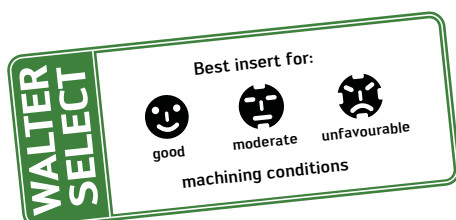

Porcupine cutter F 4238

AD . . 1606

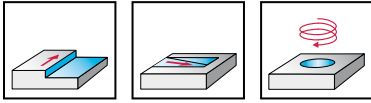
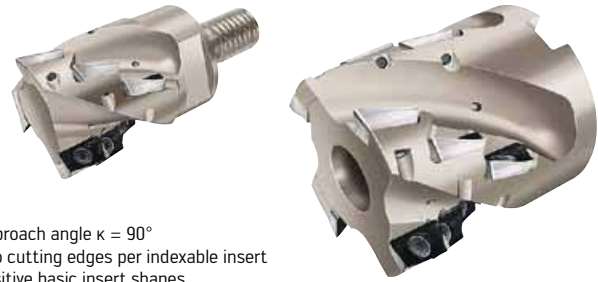
Xtra-tec®

- Approach angle $\kappa = 90^\circ$
- Two cutting edges per indexable insert
- Positive basic insert shapes
- Full effective teeth

Tool	Designation	D_c mm	d_1 mm	l_4 mm	l_{16} mm	L_c mm	Z	kg	No. of indexable inserts	Type
NCT ScrewFit	F4238.T36.040.Z03.29	40	T36	55		29	3	0,3	6	AD . . 1606 . .
	F4238.T45.050.Z03.43	50	T45	70		43	3	0,6	9	
SK DIN 69871-AD/B	F4238.S4.040.Z03.29	40	SK40	75	54	29	3	1,2	6	AD . . 1606 . .
	F4238.S4.050.Z03.43	50	SK40	85	65	43	3	1,6	9	
	F4238.S5.050.Z03.85	50	SK50	140	106	85	3	4,0	18	
	F4238.S5.063.Z03.99	63	SK50	153	121	99	3	4,7	21	
	F4238.S5.080.Z04.112	80	SK50	163	138	112	4	6,3	32	
Modular adaptor NCT	F4238.N6.040.Z03.57	40	NCT 63	108	80	57	3	1,2	12	AD . . 1606 . .
	F4238.N8.040.Z03.57	40	NCT 80	105	68	57	3	1,5	12	
	F4238.N8.050.Z03.71	50	NCT 80	122	93	71	3	2,1	15	
	F4238.N8.063.Z04.85	63	NCT 80	136	111	85	4	2,9	24	
	F4238.N8.080.Z05.99	80	NCT 80	150	130	99	5	4,6	35	
HSK DIN 69893/1-A	F4238.H100A.063.Z03.71	63	HSK-A100	125	82	71	3	3,5	15	AD . . 1606 . .
	F4238.H100A.080.Z04.85	80	HSK-A100	140	96	85	4	4,8	24	
Cyl. bore DIN 138 longitudinal key way	F4238.B22.050.Z03.43	50	22	60		43	3	0,5	9	AD . . 1606 . .
	F4238.B27.063.Z04.43	63	27	70		43	4	0,9	12	
	F4238.B27.063.Z04.57	63	27	85		57	4	1,3	16	
	F4238.B27.066.Z04.57	66	27	85		57	4	1,5	16	
	F4238.B32.080.Z05.57	80	32	85		57	5	2,0	20	
	F4238.B32.080.Z05.71	80	32	100		71	5	2,6	25	
	F4238.B32.085.Z05.71	85	32	100		74	5	3,1	25	

Bodies and assembly parts are included in the scope of delivery.

For flat wrenches for screw heads, see page G 105.

For HSK accessories, see page H 42.

For special clamping screws for arbour mounted tools, see page G 115.

For pull studs for steep tapers, see page H 42.

Assembly parts

D_c mm

40-85



Clamping screw for insert

FS1453 (Torx 15 IP)

Tightening torque

3,5 Nm

Accessories

D_c mm

40-85



Torque screwdriver

FS2003

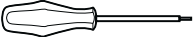

Screwdriver

FS1485 (Torx 15IP)



Interchangeable blade

FS2014 (Torx 15IP)

Indexable inserts

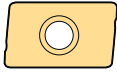
Designation	Radius mm	Face chamfer width mm	P				M		K				N		S		H
			HC				HC		HC				HC	HW	HC		HC
			WKP25	WKP35	WKP35S	WSP45	WSM35	WSP45	WAK15	WKK25	WKP25	WKP35	WKP35S	WXN15	WK10	WSM35	WSP45
 ADGT1606PER-D51	0,8	1,6	☺	☺	☺	☺	☺										
ADGT1606PER-D56	0,8	1,6	☺	☺	☺	☺	☺										
ADGT1606PER-F56	0,8	1,6				☺	☺										
ADHT160616R-G88	1,6	1,4											☺	☺			
ADHT160625R-G88	2,5	1,2											☺	☺			
ADHT160630R-G88	3,0	1,2											☺	☺			
ADHT160640R-G88	4,0	1,0											☺	☺			
ADHT1606PER-G88	0,8	1,6											☺	☺			
ADKT1606PER-F56	0,8	1,6	☺	☺	☺	☺		☺									☺
ADMT160608R-D56	0,8	1,6	☺	☺	☺	☺		☺	☺	☺	☺						☺
ADMT160608R-F56	0,8	1,6	☺	☺	☺	☺		☺	☺	☺	☺						☺
ADMT160608R-G56	0,8	1,6		☺	☺	☺				☺	☺						☺
ADMT160612R-F56	1,2	1,6		☺	☺	☺				☺	☺						☺
ADMT160616R-F56	1,6	1,4		☺	☺	☺				☺	☺						☺
ADMT160620R-F56	2,0	1,4		☺	☺	☺				☺	☺						☺
ADMT160625R-F56	2,5	1,2		☺	☺	☺				☺	☺						☺
ADMT160630R-F56	3,0	1,2		☺	☺	☺				☺	☺						☺
ADMT160632R-F56	3,2	1,2		☺	☺	☺				☺	☺						☺
ADMT160640R-F56	4,0	1,0		☺	☺	☺				☺	☺						☺
ADMT160650R-F56	5,0	-		☺	☺	☺				☺	☺						☺
ADMT160660R-F56	6,0	-		☺	☺	☺				☺	☺						☺

If the corner radius is R = 2.0 mm or above, the body in the corner section must be reworked:

$$R_{(\text{body})} = R_{(\text{insert})} - 1 \text{ mm}$$

Indexable inserts with corner radius R > 0.8 mm can only be used front inserts.

HC = Coated carbide

HW = Uncoated carbide

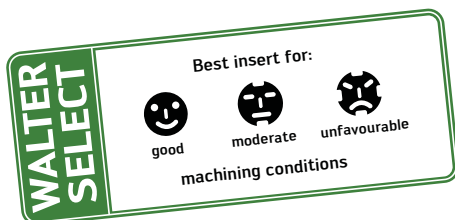

Porcupine cutter F 4338 AD . . 1807

Xtra-tec®

- Approach angle $\kappa = 90^\circ$
- Two cutting edges per indexable insert
- Positive basic insert shapes
- Full effective teeth

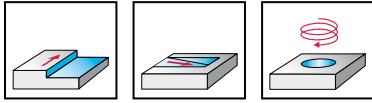

Tool	Designation	D _c mm	d ₁ mm	l ₄ mm	l ₁₆ mm	L _c mm	Z	kg	No. of indexable inserts	Type
Modular adaptor NCT	F4338.N8.063.Z04.94	63	NCT 80	117	117	94	4	2,9	24	AD . . 1807 . .
	F4338.N8.080.Z05.109	80	NCT 80	140	124	109	5	4,8	35	
SK DIN 69871-AD/B	F4338.S5.063.Z04.109	63	SK50 AD/B	125	125	109	4	4,8	28	AD . . 1807 . .
	F4338.S5.080.Z05.124	80	SK50 AD/B	163	140	124	5	6,2	40	
HSK DIN 69893/1-A	F4338.H100A.063.Z04.109	63	HSK100 A	165	126	109	4	4,2	28	AD . . 1807 . .
	F4338.H100A.080.Z05.124	80	HSK100 A	180	140	124	5	6,0	40	
Cyl. bore DIN 138 longitudinal key way	F4338.B27.063.Z04.31	63	27	53		31	4	0,8	8	AD . . 1807 . .
	F4338.B27.063.Z04.47	63	27	69		47	4	1,0	12	
	F4338.B27.063.Z04.63	63	27	85		63	4	1,3	16	
	F4338.B32.080.Z05.31	80	32	53		31	5	1,3	10	
	F4338.B32.080.Z05.63	80	32	85		63	5	2,1	20	
	F4338.B32.080.Z05.78	80	32	100		78	5	2,5	25	
	F4338.B40.100.Z05.78	100	40	105		78	5	4,2	25	
F4338.B40.125.Z06.94	125	40	120		94	6	8,1	36		

Bodies and assembly parts are included in the scope of delivery.

For HSK accessories, see page H 42.

For special clamping screws for arbour mounted tools, see page G 115.

For pull studs for steep tapers, see page H 42.

Assembly parts

		D _c mm	63-125
	Clamping screw for insert		FS1495 (Torx 20 IP)
	Tightening torque		5,0 Nm

Accessories

		D _c mm	63-125
	Torque screwdriver		FS2003
	Screwdriver		FS1486 (Torx 20IP)
	Interchangeable blade		FS2015 (Torx 20IP)

Indexable inserts

	Radius mm	Face chamfer width mm	P		M	K				N		S		H			
			HC		HC	HC				HC	HW	HC		HC			
			WKP25	WKP35	WKP35S	WSP45	WSM35	WSP45	WAK15	WKK25	WKP25	WKP35	WKP35S	WXN15	WK10	WSM35	WSP45
	ADGT1807PER-D51	1,2	1,8	☉	☉	☉	☉	☉	☉	☉	☉	☉	☉	☉	☉	☉	☉
	ADGT1807PER-D56	1,2	1,8	☉	☉	☉	☉	☉	☉	☉	☉	☉	☉	☉	☉	☉	☉
	ADMT180712R-D56	1,2	1,8	☉	☉	☉	☉	☉	☉	☉	☉	☉	☉	☉	☉	☉	☉
	ADMT180712R-F56	1,2	1,8	☉	☉	☉	☉	☉	☉	☉	☉	☉	☉	☉	☉	☉	☉

HC = Coated carbide
HW = Uncoated carbide

WALTER SELECT

Best insert for:

☉
good

☉
moderate

☉
unfavourable

machining conditions

Walter Select – slot milling

Application		
Approach angle κ	90°	
Slot milling cutter	F 2237 	
Ø range [mm]	18–40	
Page	F 174	
P Steel	••	
M Stainless steel	••	
K Cast iron	••	
N NF metals	•	
S Difficult-to-machine materials	•	
H Hard materials		
O Other		
Basic insert shapes		
Insert types	LP .. 07 .. /SP .. 06 .. LP .. 15 .. /SP .. 09 .. SP .. 12 ..	
Max. cutting depths [mm]	25	
Number of cutting edges per indexable insert	2/4	

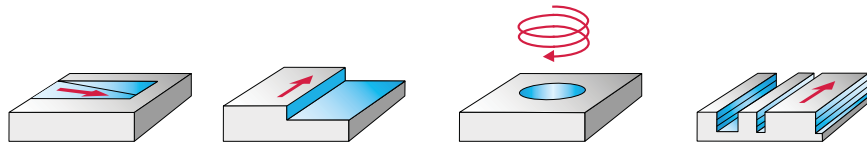

	90°	90°	90°
	F 2238CE / CK	F 2238	F 2338
	50-80	20-125	63-100
	F 178	F 176	F 184
	••	••	••
	••	••	••
	••	••	••
	•	•	•
	••	••	••
	LP .. 1504 .. SP .. 1204 ..	LP .. 0703 .. /LP .. 1504 .. LP .. 15T3 .. SP .. 0603 .. /SP .. 09T3 .. SP .. 1204 ..	LP .. 1506 .. SP .. 1206 ..
	117	87	103
	2/4	2/4	2/4



Walter Select – slot milling

Application				
Approach angle κ	90°		90°	
Slot milling cutter	F 2252 		F 2255 	
Ø range [mm]	100–315	80–315	63–250	
Page	F 186 / F 190	F 188 / F 194	F 198	
P Steel	••	••	••	
M Stainless steel	••	••	•	
K Cast iron	••	••	••	
N NF metals	••	••	••	
S Difficult-to-machine materials	••	•	•	
H Hard materials		•		
O Other	•	•	•	
Basic insert shape				
Insert types	AD .. 0803 .. AD .. 1204 .. AD .. 1606 ..	MP .. 0603 .. MP .. 0803 .. MP .. 1204 ..	NSM 3.900 ..	
Helical milling max. cutting depths [mm]	8 + 11,7 + 15	6 + 8 + 12	—	
Full side and face milling Max. cutting widths [mm]	12–25	8–23,5	1,6 + 2,2 + 3 + 4	
Number of cutting edges per indexable insert	2	2	1	

	90°	90°	90°
	F 4053	F 4153	F 4253
	Xtra-tec®	Xtra-tec®	Xtra-tec®
	80-160	80-200	100-315
	F 200	F 204	F 208
	••	••	••
	••	••	••
	••	••	••
	•	•	•
	••	••	••
	LNHX 070204 ..	LN .. 0803 .. LN .. 0804 .. LN .. 1005 ..	LN .. 0804 .. LN .. 1005 .. LN .. 1206 .. LN .. 1608 ..
	—	—	—
	4	6 + 8 + 10	12 + 14 + 16 + 20 + 25
	2 + 2	2 + 2	2 + 2



Routing cutter F 2237

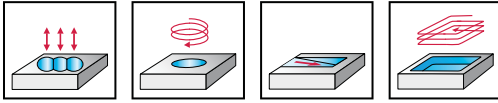

- Approach angle $\kappa = 90^\circ$
- Two / four cutting edges per indexable insert
- Positive basic insert shapes

Tool	Designation	D_c mm	d_1 mm	l_4 mm	L_c mm	l_1 mm	Z	kg	No. of indexable inserts	Type
Shank DIN 228-A 	F2237.M.018.Z01.07	18	MK 2	30	7	94	1	0,2	1 1	SP .. 0603 .. LP .. 0703 ..
	F2237.M.020.Z01.13	20	MK 2	30	13	94	1	0,1	2 1	
	F2237.M.025.Z01.14	25	MK 2	40	14	104	1	0,2	1 1	
	F2237.M.030.Z01.22	30	MK 3	45	22	126	1	0,3	2 1	SP .. 09T3 .. LP .. 15T3 ..
	F2237.M.032.Z01.22	32	MK 3	45	22	126	1	0,6	2 1	
	F2237.M.040.Z01.25	40	MK 4	60	25	162	1	0,8	1 1 1	SP .. 09T3 .. SP .. 1204 .. LP .. 1504 ..
Shank DIN 1835-B 	F2237.W.018.Z01.07	18	16	31	7	80	1	0,1	1 1	SP .. 0603 .. LP .. 0703 ..
	F2237.W.020.Z01.13	20	20	34	13	85	1	0,2	2 1	
	F2237.W.025.Z01.14	25	25	43	14	100	1	0,3	1 1	
	F2237.W.030.Z01.22	30	32	54	22	115	1	0,6	2 1	SP .. 09T3 .. LP .. 15T3 ..
	F2237.W.032.Z01.22	32	32	54	22	115	1	0,6	2 1	
	F2237.W.040.Z01.25	40	32	69	25	130	1	0,8	1 1 1	SP .. 09T3 .. SP .. 1204 .. LP .. 1504 ..

Bodies and assembly parts are included in the scope of delivery.

Assembly parts

D _c mm	18-20	25	30-32	40
	FS923 (Torx 8)	FS920 (Torx 15)	FS359 (Torx 15)	FS1030 (Torx 20)
Tightening torque	0,8 Nm	2,5 Nm	2,5 Nm	5,0 Nm
Clamping screw for insert				FS359 (Torx 15)
Tightening torque				2,5 Nm

Accessories

D _c mm	18-20	25-32	40
	FS230 (Torx 8)	FS229 (Torx 15)	FS229 (Torx 15)
Screwdriver			FS228 (Torx 20)

Indexable inserts

Designation	Radius mm	Face chamfer width mm	P				M		K				N		S		H		
			HC	HC	HC	HC	HC	HC	HC	HC	HC	HC	HC	HC	HC	HC			
			WKP25	WKP35	WKP35S	WSP45	WSM35	WSP45	WAK15	WKK25	WKP25	WKP35	WKP35S	WSN10	WXN15	WK10	WSM35	WSP45	WHH15
	LPGT070304R-F55	0,4	1,2	☺	☺	☺	☺	☺	☺	☺	☺	☺	☺	☺	☺	☺	☺	☺	☺
	LPGT150412R-F55	1,2	1,6	☺	☺	☺	☺	☺	☺	☺	☺	☺	☺	☺	☺	☺	☺	☺	☺
	LPGT15T308R-F55	0,8	1,4	☺	☺	☺	☺	☺	☺	☺	☺	☺	☺	☺	☺	☺	☺	☺	☺
	LPMT070304R-D51	0,4	1,2	☺	☺	☺	☺	☺	☺	☺	☺	☺	☺	☺	☺	☺	☺	☺	☺
	LPMT150412R-D51	1,2	1,6	☺	☺	☺	☺	☺	☺	☺	☺	☺	☺	☺	☺	☺	☺	☺	☺
	LPMT15T308R-D51	0,8	1,4	☺	☺	☺	☺	☺	☺	☺	☺	☺	☺	☺	☺	☺	☺	☺	☺
	SPMT060304-D51	0,4	-	☺	☺	☺	☺	☺	☺	☺	☺	☺	☺	☺	☺	☺	☺	☺	☺
	SPMT060304-F55	0,4	-	☺	☺	☺	☺	☺	☺	☺	☺	☺	☺	☺	☺	☺	☺	☺	☺
	SPMT09T308-D51	0,8	-	☺	☺	☺	☺	☺	☺	☺	☺	☺	☺	☺	☺	☺	☺	☺	☺
	SPMT09T308-F55	0,8	-	☺	☺	☺	☺	☺	☺	☺	☺	☺	☺	☺	☺	☺	☺	☺	☺
	SPMT120408-D51	0,8	-	☺	☺	☺	☺	☺	☺	☺	☺	☺	☺	☺	☺	☺	☺	☺	☺
	SPMT120408-F55	0,8	-	☺	☺	☺	☺	☺	☺	☺	☺	☺	☺	☺	☺	☺	☺	☺	☺

HC = Coated carbide
HW = Uncoated carbide

WALTER SELECT

Best insert for:

☺
good

☹
moderate

☹
unfavourable

machining conditions



Porcupine cutter F 2238

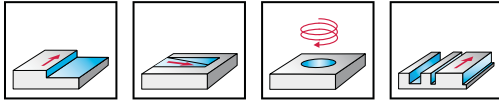

- Approach angle $\kappa = 90^\circ$
- Two / four cutting edges per indexable insert
- Positive basic insert shapes
- Half effective teeth

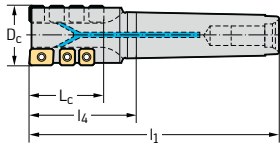
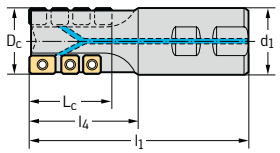
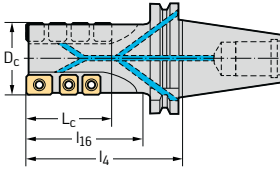
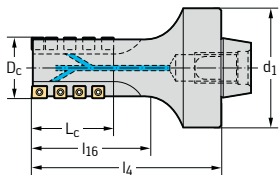
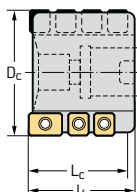
Tool	Designation	D _c mm	d ₁ mm	l ₄ mm	L ₁₆ mm	l ₁ mm	L _c mm	Z	kg	No. of indexable inserts	Type
Shank DIN 228-A 	F2238.M.020.Z01.22	20	MK 2	40		104	22	1	0,2	4 1	
	F2238.M.025.Z02.27	25	MK 2	45		109	27	2	0,2	10 2	SP .. 0603 .. LP .. 0703 ..
	F2238.M.032.Z02.37	32	MK 3	55		136	37	2	0,4	14 2	
	F2238.M.040.Z02.50	40	MK 4	75		178	50	2	0,9	12 2	SP .. 09T3 .. LP .. 15T3 ..
Shank DIN 1835-B 	F2238.W.020.Z01.22	20		34		85	22	1	0,2	4 1	
	F2238.W.025.Z02.27	25		43		100	27	2	0,3	10 2	SP .. 0603 .. LP .. 0703 ..
	F2238.W.032.Z02.37	32		54		115	37	2	0,6	14 2	
	F2238.W.040.Z02.50	40		69		140	50	2	1,1	12 2	SP .. 09T3 .. LP .. 15T3 ..
SK DIN 69871+2080 	F2238.S4.040.Z02.50	40	SK 40	95	75,25		50	2	1,2	12 2	SP .. 09T3 .. LP .. 15T3 ..
Modular adaptor NCT 	F2238.N6.032.Z02.42	32	NCT 63	100	63		42	2	0,9	16 2	SP .. 0603 .. LP .. 0703 ..
	F2238.N6.040.Z02.50	40	NCT 63	105	73		50	2	1,1	2 2	LP .. 15T3 .. SP .. 09T3 ..
Cyl. bore DIN 138 longitudinal key way 	F2238.B.050.Z02.42	50		53			42	2	0,5	10 2	
	F2238.B.063.Z03.50	63		54			50	3	0,8	18 3	SP .. 09T3 .. LP .. 15T3 ..
	F2238.B.065.Z03.50	65		54			50	3	0,9	18 3	
	F2238.B.080.Z03.67	80		80			67	3	1,7	18 3	
	F2238.B.082.Z03.67	82		80			67	3	1,7	18 3	SP .. 1204 .. LP .. 1504 ..
	F2238.B.100.Z04.77	100		90			77	4	3,4	28 4	
	F2238.B.125.Z05.87	125		100			87	5	6,2	40 5	

Bodies and assembly parts are included in the scope of delivery.

For assembly aids, see page G 105.

For special clamping screws for arbour mounted tools, see page G 115.

For pull studs for steep tapers, see page H 42.

Assembly parts

D _c mm	20-32	40-65	80-125
	FS925 (Torx 8)	FS359 (Torx 15)	FS1030 (Torx 20)
Tightening torque	0,8 Nm	2,5 Nm	5,0 Nm

Accessories

D _c mm	20-32	40-65	80-125
	FS230 (Torx 8)	FS229 (Torx 15)	FS228 (Torx 20)

Indexable inserts

Designation	Radius mm	Face chamfer width mm	P				M		K				N		S		H		
			HC	HC	HC	HC	HC	HC	HC	HC	HC	HC	HC	HC	HC	HC			
			WKP25	WKP35	WKP35S	WSP45	WSM35	WSP45	WAK15	WKK25	WKP25	WKP35	WKP35S	WSN10	WXN15	WK10	WSM35	WSP45	WHH15
LPGT070304R-F55	0,4	1,2	☉	☉	☉	☉	☉	☉	☉		☉	☉	☉				☉	☉	
LPGT150412R-F55	1,2	1,6	☉	☉	☉	☉	☉	☉	☉		☉	☉	☉				☉	☉	
LPGT15T308R-F55	0,8	1,4	☉	☉	☉	☉	☉	☉	☉		☉	☉	☉				☉	☉	
LPGW070304R-A57	0,4	1,2	☉	☉	☉				☉		☉	☉	☉						
LPGW150412R-A57	1,2	1,6	☉	☉	☉				☉		☉	☉	☉						
LPGW15T308R-A57	0,8	1,4	☉	☉	☉				☉		☉	☉	☉						
LPMT070304R-D51	0,4	1,2	☉	☉	☉	☉	☉	☉			☉	☉	☉				☉	☉	
LPMT150412R-D51	1,2	1,6	☉	☉	☉	☉	☉	☉			☉	☉	☉				☉	☉	
LPMT15T308R-D51	0,8	1,4	☉	☉	☉	☉	☉	☉			☉	☉	☉				☉	☉	
LPMW070304TR-A27	0,4	-	☉	☉	☉						☉	☉	☉						
LPMW150412TR-A27	1,2	-	☉	☉	☉						☉	☉	☉						
LPMW15T308TR-A27	0,8	-	☉	☉	☉						☉	☉	☉						
SPMT060304-D51	0,4	-	☉	☉	☉	☉	☉	☉			☉	☉	☉				☉	☉	
SPMT060304-F55	0,4	-	☉	☉	☉	☉	☉	☉	☉		☉	☉	☉				☉	☉	
SPMT09T308-D51	0,8	-	☉	☉	☉	☉	☉	☉			☉	☉	☉				☉	☉	
SPMT09T308-F55	0,8	-	☉	☉	☉	☉	☉	☉	☉		☉	☉	☉				☉	☉	
SPMT120408-D51	0,8	-	☉	☉	☉	☉	☉	☉			☉	☉	☉				☉	☉	
SPMT120408-F55	0,8	-	☉	☉	☉	☉	☉	☉	☉		☉	☉	☉				☉	☉	
SPMW060304-A57	0,4	-	☉	☉	☉				☉		☉	☉	☉						
SPMW060304T-A27	0,4	-	☉	☉	☉						☉	☉	☉						
SPMW09T308-A57	0,8	-	☉	☉	☉				☉		☉	☉	☉						
SPMW09T308T-A27	0,8	-	☉	☉	☉				☉		☉	☉	☉						
SPMW120408-A57	0,8	-	☉	☉	☉				☉		☉	☉	☉						
SPMW120408T-A27	0,8	-	☉	☉	☉				☉		☉	☉	☉						

HC = Coated carbide
 HW = Uncoated carbide

WALTER SELECT

Best insert for:

☉
good

☉
moderate

☉
unfavourable

machining conditions

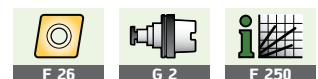

Porcupine cutter F 2238 CE

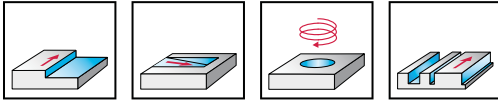

- Approach angle $\kappa = 90^\circ$
- Two / four cutting edges per indexable insert
- Positive basic insert shapes
- Half effective teeth
- With corner front piece

Tool	Designation	D_c mm	d_1 mm	l_4 mm	l_{16} mm	L_c mm	Z	kg	No. of indexable inserts	Type
SK DIN 69871+2080 	F2238CE.S5.050.Z02.056	50	SK 50	120	84	56	2	3,7	10 2	SP .. 1204 .. LP .. 1504 ..
	F2238CE.S5.063.Z02.077	63	SK 50	135	102	77	2	4,3	14 2	
	F2238CE.S5.063.Z02.087	63	SK 50	145	112	87	2	4,5	16 2	
	F2238CE.S5.063.Z02.097	63	SK 50	155	122	97	2	4,6	18 2	
	F2238CE.S5.080.Z03.097	80	SK 50	150	130	97	3	6,9	27 3	
	F2238CE.S5.080.Z03.107	80	SK 50	160	140	107	3	7,1	30 3	
	F2238CE.S5.080.Z03.117	80	SK 50	170	150	117	3	7,2	33 3	
Modular adaptor NCT 	F2238CE.N8.050.Z02.056	50	NCT 80	115	81	56	2	2,0	10 2	SP .. 1204 .. LP .. 1504 ..
	F2238CE.N8.050.Z02.077	50	NCT 80	135	101	77	2	2,2	14 2	
	F2238CE.N8.063.Z02.077	63	NCT 80	125	95	77	2	2,5	14 2	
	F2238CE.N8.063.Z02.087	63	NCT 80	135	105	87	2	2,6	16 2	
	F2238CE.N8.063.Z02.097	63	NCT 80	145	115	97	2	2,7	18 2	
	F2238CE.N8.080.Z03.097	80	NCT 80	145	126	97	3	4,0	30 3	
	F2238CE.N8.080.Z03.107	80	NCT 80	155	136	107	3	4,2	30 3	
F2238CE.N8.080.Z03.117	80	NCT 80	165	146	117	3	4,3	33 3		

Bodies, front piece and assembly parts are included in the scope of delivery.

The pull stud to be ordered depends on the required DIN standard.

When using with DIN 2080 adaptors, one of the drive pins must be removed.

For pull studs for steep tapers, see page H 42.

For assembly aids, see page G 105.

Assembly parts		D _c mm	50	50	63	63	63	80	80	80
		L _c mm	56	77	77	87	97	97	107	117
	Clamping screw for insert		FS1030 (Torx 20)	FS1030 (Torx 20)	FS1030 (Torx 20)	FS1030 (Torx 20)	FS1030 (Torx 20)	FS1030 (Torx 20)	FS1030 (Torx 20)	FS1030 (Torx 20)
	Tightening torque		5,0 Nm	5,0 Nm	5,0 Nm	5,0 Nm	5,0 Nm	5,0 Nm	5,0 Nm	5,0 Nm
	Clamping screw for front piece		FS370 (SW10)	FS370 (SW10)						
	Tightening torque		40,0 Nm	40,0 Nm						
	Clamping screw for front piece				FS371 (SW10)	FS372 (SW10)		FS373 (SW12)	FS374 (SW2)	
	Tightening torque				120,0 Nm	120,0 Nm		120,0 Nm	120,0 Nm	
	Clamping screw for front piece						FS1032 (SW8)			FS1033 (SW8)
	Tightening torque						120,0 Nm			120,0 Nm
	Front piece		F2238CE.C. 050.Z02.024	F2238CE.C. 050.Z02.034	F2238CE.C. 063.Z02.024	F2238CE.C. 063.Z02.034	F2238CE.C. 063.Z02.0244	F2238CE.C. 080.Z03.024	F2238CE.C. 080.Z03.034	F2238CE.C. 080.Z03.044

Accessories		D _c mm	50	50	63	63	63	80	80	80
		L _c mm	56	77	77	87	97	97	107	117
	Screwdriver		FS228 (Torx 20)	FS228 (Torx 20)	FS228 (Torx 20)	FS228 (Torx 20)	FS228 (Torx 20)	FS228 (Torx 20)	FS228 (Torx 20)	FS228 (Torx 20)
	Socket wrench						FS1043 (SW8)			FS1043 (SW8)

Indexable inserts

Designation	Radius mm	Face chamfer width mm	P				M		K				N		S		H		
			HC		HC		HC		CN		HC	HW	HC		HC				
			WKP25	WKP35	WKP35S	WSP45	WSM35	WSP45	WAK15	WKK25	WKP25	WKP35	WKP35S	WSN10	WXN15	WK10	WSM35	WSP45	WHH15
LPGT150412R-F55	1,2	1,6	☺	☺	☺	☺	☺	☺	☺		☺	☺	☺				☺	☺	
LPGW150412R-A57	1,2	1,6	☺	☺	☺	☺	☺	☺	☺		☺	☺	☺				☺	☺	
LPMT150412R-D51	1,2	1,6	☺	☺	☺	☺	☺	☺			☺	☺	☺				☺	☺	
LPMW150412TR-A27	1,2	-	☺	☺	☺	☺	☺	☺			☺	☺	☺				☺	☺	
SPMT120408-D51	0,8	-	☺	☺	☺	☺	☺	☺			☺	☺	☺				☺	☺	
SPMT120408-F55	0,8	-	☺	☺	☺	☺	☺	☺			☺	☺	☺				☺	☺	
SPMW120408-A57	0,8	-	☺	☺	☺	☺	☺	☺			☺	☺	☺				☺	☺	
SPMW120408T-A27	0,8	-	☺	☺	☺	☺	☺	☺			☺	☺	☺				☺	☺	

HC = Coated carbide
HW = Uncoated carbide

WALTER SELECT

Best insert for:

☺
good

☹
moderate

☹
unfavourable

machining conditions

Porcupine basic body F 2238CK

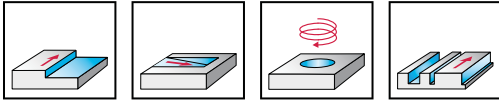

- Approach angle $\kappa = 90^\circ$
- Two cutting edges per indexable insert
- Positive basic insert shapes
- Basic body for porcupine cutter

Tool	Designation	D_c mm	d_1 mm	l_4 mm	l_{16} mm	L_c mm	Z	kg	No. of indexable inserts	Type
SK DIN 69871+2080 	F2238CK.S5.050.Z02.032	50	SK 50	96	60	32,4	2	3,5	6	SP .. 1204 ..
	F2238CK.S5.063.Z02.053	63	SK 50	111	78	52,9	2	3,9	10	
	F2238CK.S5.080.Z03.073	80	SK 50	126	105	73,4	3	6,2	21	
	Modular adaptor NCT	F2238CK.N8.050.Z02.032	50	NCT 80	91	56	32,4	2	1,8	6
F2238CK.N8.050.Z02.053	50	NCT 80	111	77	53	2	1,8	10		
F2238CK.N8.063.Z02.053	63	NCT 80	101	71	53	2	2,1	10		
F2238CK.N8.080.Z03.073	80	NCT 80	121	98	73,4	3	3,3	21		

Bodies and assembly parts are included in the scope of delivery.
 The pull stud to be ordered depends on the required DIN standard.
 When using with DIN 2080 adaptors, one of the drive pins must be removed.
 For assembly aids, see page G 105.
 For pull studs for steep tapers, see page H 42.

Assembly parts

D _c mm		50-80
	Clamping screw for insert	FS1030 (Torx 20)
	Tightening torque	5,0 Nm

Accessories

D _c mm		50-80
	Screwdriver	FS228 (Torx 20)

Indexable inserts

Designation	Radius mm	P		M		K				N		S		H				
		HC		HC		HC				CN	HC	HW	HC		HC			
		WKP25	WKP35	WKP35S	WSP45	WSM35	WSP45	WAK15	WKK25	WKP25	WKP35	WKP35S	WSN10	WXN15	WK10	WSM35	WSP45	WHH15
SPMT120408-D51	0,8	☺	☺	☺	☺	☺	☺	☺	☺	☺	☺	☺	☺	☺	☺	☺	☺	
SPMT120408-F55	0,8	☺	☺	☺	☺	☺	☺	☺	☺	☺	☺	☺	☺	☺	☺	☺	☺	
SPMW120408-A57	0,8	☺	☺	☺			☺	☺	☺	☺	☺	☺	☺	☺	☺	☺	☺	
SPMW120408T-A27	0,8	☺	☺	☺			☺	☺	☺	☺	☺	☺	☺	☺	☺	☺	☺	

HC = Coated carbide
HW = Uncoated carbide

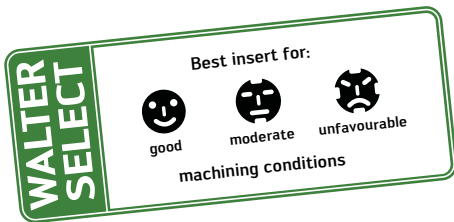

Porcupine front piece F 2238CE . C

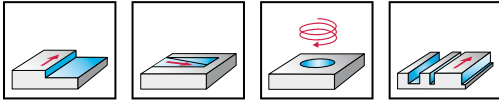

- Approach angle $\kappa = 90^\circ$
- Two / four cutting edges per indexable insert
- Positive basic insert shapes
- Half effective teeth
- Corner front piece

Tool	Designation	D _c mm	L _c mm	Z	kg	No. of indexable inserts	Type
	F2238CE.C.050.Z02.024	50	24	2	0,2	4 2	SP . . 1204 . . LP . . 1504 . .
	F2238CE.C.063.Z02.024	63	24	2	0,3	4 2	
	F2238CE.C.063.Z02.034	63	34	2	0,4	6 2	
	F2238CE.C.063.Z02.044	63	44	2	0,6	8 2	
	F2238CE.C.080.Z03.024	80	24	3	0,5	6 3	
	F2238CE.C.080.Z03.034	80	34	3	0,7	9 3	
	F2238CE.C.080.Z03.044	80	44	3	0,9	12 3	

Bodies and assembly parts are included in the scope of delivery.
 For assembly aids, see page G 105.

Assembly parts

D_c mm

50-80



Clamping screw for insert

FS1030 (Torx 20)

Accessories

D_c mm

50-80

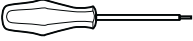

Screwdriver

FS228 (Torx 20)

Indexable inserts

	Designation	Radius mm	Face chamfer width mm	P				M		K				N		S		H		
				HC	HC	HC	HC	HC	HC	CN	HC	HW	HC	HC	HC	HC				
				WKP25	WKP35	WKP35S	WSP45	WSM35	WSP45	WAK15	WKK25	WKP25	WKP35	WKP35S	WSN10	WXN15	WK10	WSM35	WSP45	WHH15
	LPGT150412R-F55	1,2	1,6	⊕	⊕	⊕	⊕	⊕	⊕	⊕		⊕	⊕	⊕				⊕	⊕	
	LPGW150412R-A57	1,2	1,6	⊕	⊕	⊕	⊕			⊕		⊕	⊕	⊕						
	LPMT150412R-D51	1,2	1,6	⊕	⊕	⊕	⊕	⊕	⊕			⊕	⊕	⊕					⊕	⊕
	LPMW150412TR-A27	1,2	-	⊕	⊕	⊕	⊕					⊕	⊕	⊕						
	SPMT120408-D51	0,8	-	⊕	⊕	⊕	⊕	⊕	⊕			⊕	⊕	⊕					⊕	⊕
	SPMT120408-F55	0,8	-	⊕	⊕	⊕	⊕	⊕	⊕	⊕		⊕	⊕	⊕					⊕	⊕
	SPMW120408-A57	0,8	-	⊕	⊕	⊕	⊕			⊕		⊕	⊕	⊕						
	SPMW120408T-A27	0,8	-	⊕	⊕	⊕	⊕					⊕	⊕	⊕						

HC = Coated carbide
HW = Uncoated carbide

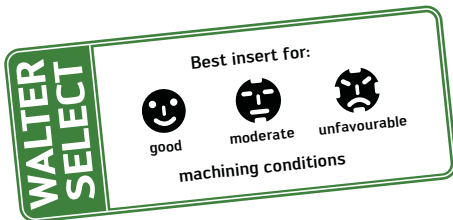

Porcupine cutter F 2338

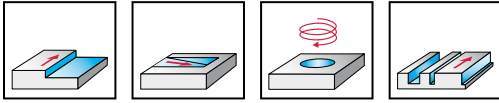

- Approach angle $\kappa = 90^\circ$
- Two cutting edges per indexable insert
- Positive basic insert shapes
- Half effective teeth

Tool	Designation	D_c mm	d_1 mm	l_4 mm	l_{16} mm	L_c mm	Z	kg	No. of indexable inserts	Type
Modular adaptor NCT	F2338.N8.063.Z02.78	63	NCT 80	135	108	78	2	2,6	2 14	SP .. 1206 ..
	F2338.N8.080.Z02.100	80	NCT 80	155	132	100	2	4,1	2 18	LP .. 1506 ..

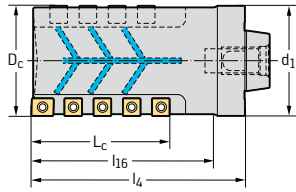

Bodies and assembly parts are included in the scope of delivery.
For assembly aids, see page G 105.

Assembly parts

D_c mm 63-80



Clamping screw for insert	FS1031 (Torx 20)
Tightening torque	5,0 Nm

Accessories

D_c mm 63-80

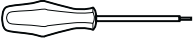

Screwdriver	FS228 (Torx 20)
-------------	-----------------

Indexable inserts

Designation	Radius mm	Face chamfer width mm	P		M		K				N		S		H		
			HC		HC		HC				HC	HW	HC		HC		
			WKP25	WKP35	WKP35S	WSP45	WSM35	WSP45	WAK15	WKK25	WKP25	WKP35	WKP35S	WXN15	WK10	WSM35	WSP45
	LPGT1506PPR-F57	1,2	1,6	☹	☹	☹	☹	☹	☹	☹	☹	☹	☹	☹	☹	☹	
	LPHW150612R-A51	1,2	-	☹	☹	☹	☹	☹	☹	☹	☹	☹	☹	☹	☹	☹	
	LPHW1506PPR-A57	1,2	1,6	☹	☹	☹	☹	☹	☹	☹	☹	☹	☹	☹	☹	☹	
	LPMT150612R-D51	1,2	-	☹	☹	☹	☹	☹	☹	☹	☹	☹	☹	☹	☹	☹	
	LPMT150612R-D57	1,2	-	☹	☹	☹	☹	☹	☹	☹	☹	☹	☹	☹	☹	☹	
	LPMW150612TR-A27	1,2	-	☹	☹	☹	☹	☹	☹	☹	☹	☹	☹	☹	☹	☹	
	SPGT120606-F57	0,6	-	☹	☹	☹	☹	☹	☹	☹	☹	☹	☹	☹	☹		
	SPHW120606-A51	0,6	-	☹	☹	☹	☹	☹	☹	☹	☹	☹	☹	☹	☹		
	SPHW120606-A57	0,6	-	☹	☹	☹	☹	☹	☹	☹	☹	☹	☹	☹	☹		
	SPMT120606-D51	0,6	-	☹	☹	☹	☹	☹	☹	☹	☹	☹	☹	☹	☹		
	SPMT120606-D57	0,6	-	☹	☹	☹	☹	☹	☹	☹	☹	☹	☹	☹	☹		
	SPMW120606T-A27	0,6	-	☹	☹	☹	☹	☹	☹	☹	☹	☹	☹	☹	☹		

HC = Coated carbide
HW = Uncoated carbide

WALTER SELECT

Best insert for:

good

moderate

unfavourable

machining conditions

Side and face mill F 2252.B

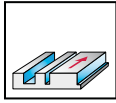

- Approach angle $\kappa = 90^\circ$
- Two cutting edges per indexable insert
- Positive basic insert shapes
- Helical milling
- Cutting on two sides

Tool	Designation	D _C mm	d ₁ mm	d ₆ mm	L _C mm	NB mm	Z	 kg	No. of indexable inserts	Type	
Cyl. bore longitudinal key way DIN 138 	F2252.B.100.Z08.08.R724	100	32	50	8	12	8	0,5	8	AD .. 0803 .. R	
	F2252.B.125.Z10.08.R724	125	40	65	8	12	10	0,7	10		
	F2252.B.160.Z12.08.R724	160	40	65	8	12	12	1,4	12		
	F2252.B.125.Z08.11.R725	125	40	65	11,7	19	8	8	1,0	8	AD .. 1204 .. R
	F2252.B.160.Z10.11.R725	160	40	65	11,7	19	10	2,0	10		
	F2252.B.200.Z12.11.R725	200	50	75	11,7	19	12	3,3	12		
	F2252.B.250.Z16.11.R725	250	60	90	11,7	19	16	5,3	16		
	F2252.B.125.Z08.15.R726	125	40	65	15	19	8	8	1,0	8	AD .. 1606 .. R
	F2252.B.160.Z10.15.R726	160	40	65	15	19	10	2,0	10		
	F2252.B.200.Z12.15.R726	200	50	75	15	19	12	3,3	12		
	F2252.B.250.Z16.15.R726	250	60	90	15	19	16	5,3	16		
	F2252.B.315.Z20.15.R726	315	60	90	15	19	20	8,9	20		
	Cyl. bore longitudinal key way DIN 138 	F2252.B.100.Z08.08.L724	100	32	50	8	12	8	0,5	8	AD .. 0803 .. L
F2252.B.125.Z10.08.L724		125	40	65	8	12	10	0,7	10		
F2252.B.160.Z12.08.L724		160	40	65	8	12	12	1,4	12		
F2252.B.125.Z08.11.L725		125	40	65	11,7	19	8	8	1,0	8	AD .. 1204 .. L
F2252.B.160.Z10.11.L725		160	40	65	11,7	19	10	2,0	10		
F2252.B.200.Z12.11.L725		200	50	75	11,7	19	12	3,3	12		
F2252.B.250.Z16.11.L725		250	60	90	11,7	19	16	5,3	16		
F2252.B.125.Z08.15.L726		125	40	65	15	19	8	8	1,0	8	AD .. 1606 .. L
F2252.B.160.Z10.15.L726		160	40	65	15	19	10	2,0	10		
F2252.B.200.Z12.15.L726		200	50	75	15	19	12	3,3	12		
F2252.B.250.Z16.15.L726		250	60	90	15	19	16	5,3	16		
F2252.B.315.Z20.15.L726		315	60	90	15	19	20	8,9	20		

Bodies and assembly parts are included in the scope of delivery.

Depending on cutting edge diameter and insert size, the profile on the component will vary.

Cutting width can be adjusted.

Assembly parts

Insert types	AD .. 0803 .. L	AD .. 0803 .. R	AD .. 1204 .. L	AD .. 1204 .. R	AD .. 1606 .. L	AD .. 1606 .. R
Eccentric bolt	FS1170	FS1170	FS1171	FS1171	FS1171	FS1171
Spring washer	FS1220	FS1220	FS1221	FS1221	FS1221	FS1221
Cartridge for tool body	FL724	FR724	FL725	FR725	FL726	FR726
Clamping sleeve	FS1167	FS1167	FS1168	FS1168	FS1168	FS1168
Clamping wedge	FK360	FK360	FK359	FK359	FK359	FK359
Clamping screw for clamping wedge	FS239	FS239	FS1162	FS1162	FS1162	FS1162
Tightening torque	6,5 Nm	6,5 Nm	9,0 Nm	9,0 Nm	9,0 Nm	9,0 Nm
Clamping screw for insert	FS1454 (Torx 8 IP)	FS1454 (Torx 8 IP)	FS1457 (Torx 9 IP)	FS1457 (Torx 9 IP)	FS1453 (Torx 15 IP)	FS1453 (Torx 15 IP)
Tightening torque	0,8 Nm	0,8 Nm	2,5 Nm	2,5 Nm	2,5 Nm	2,5 Nm

Accessories

Insert types		AD...0803...L	AD...0803...R	AD...1204...L	AD...1204...R	AD...1606...L	AD...1606...R
	Finishing cartridge for tool body	FL695	FR695	FL696	FR696	FL696	FR696
	Finishing insert	P2905-0	P2905-0	P2905-1	P2905-1	P2905-1	P2905-1
	ISO2936 Allen key for clamping wedge	ISO2936-3 (SW3)	ISO2936-3 (SW3)	ISO2936-4 (SW4)	ISO2936-4 (SW4)	ISO2936-4 (SW4)	ISO2936-4 (SW4)
	Screwdriver for indexable insert	FS1483 (Torx 8IP)	FS1483 (Torx 8IP)	FS1484 (Torx 9IP)	FS1484 (Torx 9IP)	FS1485 (Torx 15IP)	FS1485 (Torx 15IP)

Indexable inserts

Designation	Radius mm	Face chamfer width mm	P				M		K				N		S		H
			HC				HC		HC				HC	HW	HC		HC
			WKP25	WKP35	WKP35S	WSP45	WSM35	WSP45	WAK15	WKK25	WKP25	WKP35	WKP35S	WXN15	WK10	WSM35	WSP45
	ADHT0803PER-G88	0,4	1,2														
	ADHT0803PEL-G88	0,4	1,2														
	ADKT0803PER-F56	0,4	1,2														
	ADKT0803PEL-F56	0,4	1,2														
	ADMT080304R-F56	0,4	1,2														
	ADMT080304L-F56	0,4	1,2														
	ADMT080308R-F56	0,8	1,0														
	ADMT080308L-F56	0,8	1,0														
	ADHT1204PER-G88	0,8	1,2														
	ADHT1204PEL-G88	0,8	1,2														
	ADKT1204PER-F56	0,8	1,2														
	ADKT1204PEL-F56	0,8	1,2														
	ADMT120408R-F56	0,8	1,2														
	ADMT120408L-F56	0,8	1,2														
	ADHT1606PER-G88	0,8	1,6														
	ADHT1606PEL-G88	0,8	1,6														
	ADKT1606PER-F56	0,8	1,6														
	ADKT1606PEL-F56	0,8	1,6														
	ADMT160608R-F56	0,8	1,6														
	ADMT160608L-F56	0,8	1,6														

HC = Coated carbide
HW = Uncoated carbide

WALTER SELECT

Best insert for:

good

moderate

unfavourable

machining conditions

Side and face mill F 2252.B

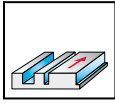

- Approach angle $\kappa = 90^\circ$
- Two cutting edges per indexable insert
- Positive basic insert shapes
- Helical milling
- Cutting on two sides

Tool	Designation	D _C mm	d ₁ mm	d ₆ mm	L _C mm	NB mm	Z	 kg	No. of indexable inserts	Type
Cyl. bore longitudinal key way DIN 138 	F2252.B.080.Z06.06.R684	80	22	37	6	8	6	0,2	6	MP...0603...
	F2252.B.100.Z08.06.R684	100	32	50	6	8	8	0,4	8	
	F2252.B.125.Z10.06.R684	125	40	65	6	8	10	0,6	10	
	MP...0803...	F2252.B.100.Z08.08.R685	100	32	50	8	12	8	0,4	8
		F2252.B.125.Z10.08.R685	125	40	65	8	12	10	0,7	10
		F2252.B.160.Z12.08.R685	160	40	65	8	12	12	1,4	12
	MP...1204...	F2252.B.125.Z08.12.R686	125	40	65	12	19	8	1,0	8
		F2252.B.160.Z10.12.R686	160	40	65	12	19	10	2,0	10
		F2252.B.200.Z12.12.R686	200	50	75	12	19	12	3,3	12
		F2252.B.250.Z16.12.R686	250	60	90	12	19	16	5,3	16
	F2252.B.315.Z20.12.R686	315	60	90	12	19	20	8,9	20	
Cyl. bore longitudinal key way DIN 138 	F2252.B.080.Z06.06.L684	80	22	37	6	8	6	0,2	6	MP...0603...
	F2252.B.100.Z08.06.L684	100	32	50	6	8	8	0,4	8	
	F2252.B.125.Z10.06.L684	125	40	65	6	8	10	0,6	10	
	MP...0803...	F2252.B.100.Z08.08.L685	100	32	50	8	12	8	0,5	8
		F2252.B.125.Z10.08.L685	125	40	65	8	12	10	0,7	10
		F2252.B.160.Z12.08.L685	160	40	65	8	12	12	1,3	12
	MP...1204...	F2252.B.125.Z08.12.L686	125	40	65	12	19	8	1,0	8
		F2252.B.160.Z10.12.L686	160	40	65	12	19	10	2,0	10
		F2252.B.200.Z12.12.L686	200	50	75	12	19	12	3,3	12
		F2252.B.250.Z16.12.L686	250	60	90	12	19	16	5,3	16
	F2252.B.315.Z20.12.L686	315	60	90	12	19	20	8,9	20	

Bodies and assembly parts are included in the scope of delivery.
Cutting width can be adjusted.

Assembly parts

Insert types		MP .. 0603 ..	MP .. 0803 ..	MP .. 1204 ..
	Eccentric bolt	FS1169	FS1170	FS1171
	Spring washer	FS1220	FS1220	FS1221
	Cartridge for tool body	FL684	FL685	FL686
		FR684	FR685	FR686
	Clamping sleeve	FS1166	FS1167	FS1168
	Clamping wedge	FK358	FK360	FK359
	Clamping screw for clamping wedge	FS1161	FS239	FS1162
	Tightening torque	3,5 Nm	6,5 Nm	9,0 Nm
	Clamping screw for insert	FS923 (Torx 8)	FS1005 (Torx 8)	FS1029 (Torx 20)
	Tightening torque	0,8 Nm	1,5 Nm	5,0 Nm

Accessories

Insert types		MP .. 0603 ..	MP .. 0803 ..	MP .. 1204 ..
	Finishing cartridge for tool body		FR695	F696
			FL695	FL696
	Finishing insert		P2905-0	P2905-1
	ISO2936 Allen key for clamping wedge	ISO2936-2.5 (SW2,5)	ISO2936-3 (SW3)	ISO2936-4 (SW4)
	Screwdriver for indexable insert	FS230 (Torx 8)	FS230 (Torx 8)	FS228 (Torx 20)

Indexable inserts

Designation	Radius mm	P				M		K				N		S		H
		HC				HC		HC				HC	HW	HC		HC
		WKP25	WKP35	WKP35S	WSP45	WSM35	WSP45	WAK15	WKK25	WKP25	WKP35	WKP35S	WXN15	WK10	WSM35	WSP45
MPHT120408-G88	0,8											☺				
MPHW120408-A57	0,8	☹	☹	☹			☹	☹	☹	☹	☹	☹				
MPHX060304-A57	0,4	☹	☹	☹			☹	☹	☹	☹	☹	☹				
MPHX060304-G88	0,4											☺				
MPHX080305-A57	0,5	☹	☹	☹			☹	☹	☹	☹	☹	☹				
MPHX080305-G88	0,5											☺				
MPMT120408-F57	0,8		☹	☹	☹	☹				☹	☹			☹	☹	
MPMX060304-F57	0,4		☹	☹	☹	☹				☹	☹			☹	☹	
MPMX080305-F57	0,5		☹	☹	☹	☹	☹			☹	☹			☹	☹	

HC = Coated carbide
HW = Uncoated carbide

WALTER SELECT

Best insert for:

☺
good

☹
moderate

☹
unfavourable

machining conditions

Side and face mill F 2252.B

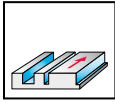

- Approach angle $\kappa = 90^\circ$
- Two cutting edges per indexable insert
- Positive basic insert shapes
- Full side and face milling
- Cutting on three sides

Tool	Designation	D _c mm	d ₁ mm	d ₆ mm	l ₄ mm	SB _{min}	SB _{max}	NB mm	Z	kg	No. of indexable inserts	Type
Cyl. bore longitudinal key way DIN 138 	F2252.B.100.Z04.12.S724	100	32	50	12	12	14	12	4	0,5	4 4	AD...0803...R AD...0803...L
	F2252.B.100.Z04.14.S724	100	32	50	14	14	16	14	4	0,6	4 4	
	F2252.B.125.Z05.12.S724	125	40	65	12	12	14	12	5	0,7	5 5	
	F2252.B.125.Z05.14.S724	125	40	65	14	14	16	14	5	0,8	5 5	
	F2252.B.160.Z06.12.S724	160	40	65	12	12	14	12	6	1,4	6 6	
	F2252.B.160.Z06.14.S724	160	40	65	14	14	16	14	0	1,6	6 6	
	F2252.B.125.Z04.16.S725	125	40	65	16	16	19	16	4	0,9	4 4	AD...1204...R AD...1204...L
	F2252.B.125.Z04.19.S725	125	40	65	19	19	22	19	4	1,0	4 4	
	F2252.B.160.Z05.16.S725	160	40	65	16	16	19	16	5	1,6	5 5	
	F2252.B.160.Z05.19.S725	160	40	65	19	19	22	19	5	2,0	5 5	
	F2252.B.200.Z06.16.S725	200	50	75	16	16	19	16	6	2,7	6 6	
	F2252.B.200.Z06.19.S725	200	50	75	19	19	22	19	6	3,3	6 6	
	F2252.B.250.Z08.16.S725	250	60	90	16	16	19	16	8	4,4	8 8	AD...1606...R AD...1606...L
	F2252.B.250.Z08.19.S725	250	60	90	19	19	22	19	8	5,3	8 8	
	F2252.B.315.Z10.16.S725	315	60	90	16	16	19	16	10	7,3	10 10	
	F2252.B.315.Z10.19.S725	315	60	90	19	19	22	19	10	8,9	10 10	
	F2252.B.125.Z04.22.S726	125	40	65	22	22	25	22	4	1,2	4 4	AD...1606...R AD...1606...L
	F2252.B.160.Z05.22.S726	160	40	65	22	22	25	22	5	2,3	5 5	
	F2252.B.200.Z06.22.S726	200	50	75	22	22	25	22	6	3,8	6 6	
	F2252.B.250.Z08.22.S726	250	60	90	22	22	25	22	8	6,2	8 8	

Bodies and assembly parts are included in the scope of delivery.
Depending on cutting edge diameter and insert size, the profile in the base of the groove will vary.
Cutting width can be adjusted.

Assembly parts	Insert types	AD...0803...	AD...1204...	AD...1606...
	Eccentric bolt	FS1170	FS1171	FS1171
	Spring washer	FS1220	FS1221	FS1221
	Cartridge for tool body	FR724	FL725	FL726
		FL724	FR725	FR726
	Clamping sleeve	FS1167	FS1168	FS1168
	Clamping wedge	FK360	FK359	FK359
	Clamping screw for clamping wedge	FS239	FS1162	FS1162
	Tightening torque	6,5 Nm	9,0 Nm	9,0 Nm
	Clamping screw for insert	FS1454 (Torx 8 IP)	FS1457 (Torx 9 IP)	FS1453 (Torx 15 IP)
	Tightening torque	0,8 Nm	2,5 Nm	2,5 Nm

Accessories

Insert types	AD..0803..L	AD..0803..R	AD..1204..L	AD..1204..R	AD..1606..L	AD..1606..R
Finishing cartridge for tool body	FL695	FR695	FL696	FR696	FL696	FR696
Finishing insert	P2905-0	P2905-0	P2905-1	P2905-1	P2905-1	P2905-1
ISO2936 Allen key for clamping wedge	ISO2936-3 (SW3)	ISO2936-3 (SW3)	ISO2936-4 (SW4)	ISO2936-4 (SW4)	ISO2936-4 (SW4)	ISO2936-4 (SW4)
Screwdriver for indexable insert	FS1483 (Torx 8IP)	FS1483 (Torx 8IP)	FS1484 (Torx 9IP)	FS1484 (Torx 9IP)	FS1485 (Torx 15IP)	FS1485 (Torx 15IP)

Indexable inserts

Designation	Radius mm	Face chamfer width mm	P			M		K				N		S		H		
			HC			HC		HC				HC	HW	HC		HC		
			WKP25	WKP35	WKP35S	WSP45	WSM35	WSP45	WAK15	WKK25	WKP25	WKP35	WKP35S	WXN15	WK10	WSM35	WSP45	WHH15
ADHT0803PER-G88	0,4	1,2												☺	☺			
ADHT0803PEL-G88	0,4	1,2												☺	☺			
ADKT0803PER-F56	0,4	1,2	☺	☺	☺	☺	☺	☺	☺	☺	☺	☺	☺			☺	☺	
ADKT0803PEL-F56	0,4	1,2		☺	☺	☺	☺	☺										☺
ADMT080304R-F56	0,4	1,2	☺	☺	☺	☺	☺	☺	☺	☺	☺	☺	☺			☺	☺	
ADMT080304L-F56	0,4	1,2		☺	☺	☺	☺	☺										☺
ADMT080308R-F56	0,8	1,0		☺	☺	☺	☺	☺								☺	☺	
ADMT080308L-F56	0,8	1,0		☺	☺	☺	☺	☺										☺
ADHT1204PER-G88	0,8	1,2												☺	☺			
ADHT1204PEL-G88	0,8	1,2												☺	☺			
ADKT1204PER-F56	0,8	1,2	☺	☺	☺	☺	☺	☺	☺	☺	☺	☺	☺			☺	☺	
ADKT1204PEL-F56	0,8	1,2		☺	☺	☺	☺	☺										☺
ADMT120408R-F56	0,8	1,2	☺	☺	☺	☺	☺	☺	☺	☺	☺	☺	☺			☺	☺	
ADMT120408L-F56	0,8	1,2		☺	☺	☺	☺	☺										☺
ADHT1606PER-G88	0,8	1,6												☺	☺			
ADHT1606PEL-G88	0,8	1,6												☺	☺			
ADKT1606PER-F56	0,8	1,6	☺	☺	☺	☺	☺	☺	☺	☺	☺	☺	☺			☺	☺	
ADKT1606PEL-F56	0,8	1,6		☺	☺	☺	☺	☺										☺
ADMT160608R-F56	0,8	1,6	☺	☺	☺	☺	☺	☺	☺	☺	☺	☺	☺			☺	☺	
ADMT160608L-F56	0,8	1,6		☺	☺	☺	☺	☺										☺

HC = Coated carbide
HW = Uncoated carbide

WALTER SELECT

Best insert for:

☺
good

☹
moderate

☹
unfavourable

machining conditions

Side and face mill F 2252.BN

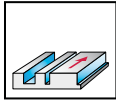
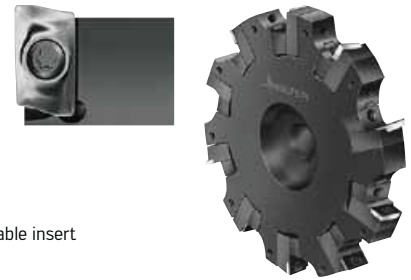

- Approach angle $\kappa = 90^\circ$
- Two cutting edges per indexable insert
- Positive basic insert shapes
- Full side and face milling
- Cutting on three sides

Tool	Designation	D _c mm	d ₁ mm	d ₆ mm	l ₄ mm	SB _{min}	SB _{max}	a _e mm	Z	kg	No. of indexable inserts	Type
Cyl. bore longitudinal key way DIN 138 	F2252.BN.100.Z04.12.S724	100	27	48	50	12	14	24	4	0,9	4/4	AD...0803...R AD...0803...L
	F2252.BN.100.Z04.14.S724	100	27	48	50	14	16	24	4	1,0	4/4	
	F2252.BN.125.Z05.12.S724	125	32	60	50	12	14	30	5	1,1	5/5	
	F2252.BN.125.Z05.14.S724	125	32	60	50	14	16	30	5	1,2	5/5	
	F2252.BN.160.Z06.12.S724	160	40	75	50	12	14	40	6	1,8	6/6	
	F2252.BN.160.Z06.14.S724	160	40	75	50	14	16	40	6	2,0	6/6	
	F2252.BN.125.Z04.16.S725	125	32	60	50	16	19	30	4	1,5	4/4	AD...1204...R AD...1204...L
	F2252.BN.125.Z04.19.S725	125	32	60	50	19	22	30	4	1,7	4/4	
	F2252.BN.160.Z05.16.S725	160	40	75	50	16	19	40	5	2,3	5/5	
	F2252.BN.160.Z05.19.S725	160	40	75	50	19	22	40	5	2,6	5/5	
	F2252.BN.200.Z06.16.S725	200	40	90	50	16	19	50	6	3,5	6/6	
	F2252.BN.200.Z06.19.S725	200	40	90	50	19	22	50	6	4,1	6/6	
	F2252.BN.250.Z08.16.S725	250	60/50 B	135	50	16	19	55	8	5,8	8/8	AD...1606...R AD...1606...L
	F2252.BN.250.Z08.19.S725	250	60/50 B	135	50	19	22	55	8	6,6	8/8	
	F2252.BN.315.Z10.16.S725	315	60/50 B	135	50	16	19	85	10	11,4	10/10	
	F2252.BN.315.Z10.19.S725	315	60/50 B	135	50	19	22	85	10	12,1	10/10	
	F2252.BN.125.Z04.22.S726	125	32	60	50	22	25	30	4	1,9	4/4	AD...1606...R AD...1606...L
	F2252.BN.160.Z05.22.S726	160	40	75	50	22	22	40	5	3,0	5/5	
	F2252.BN.200.Z06.22.S726	200	40	90	50	22	25	50	6	4,6	6/6	
	F2252.BN.250.Z08.22.S726	250	60/50 B	135	50	22	25	55	8	7,4	8/8	

Bodies and assembly parts are included in the scope of delivery.
Depending on cutting edge diameter and insert size, the profile in the base of the groove will vary.
Cutting width can be adjusted.

Assembly parts		AD...0803..	AD...1204..	AD...1606..
	Eccentric bolt	FS1170	FS1171	FS1171
	Spring washer	FS1220	FS1221	FS1221
	Cartridge for tool body	FR724	FL725	FL726
		FL724	FR725	FR726
	Clamping sleeve	FS1167	FS1168	FS1168
	Clamping wedge	FK360	FK359	FK359
	Clamping screw for clamping wedge	FS239	FS1162	FS1162
	Tightening torque	6,5 Nm	9,0 Nm	9,0 Nm
	Clamping screw for insert	FS1454 (Torx 8 IP)	FS1457 (Torx 9 IP)	FS1453 (Torx 15 IP)
	Tightening torque	0,8 Nm	2,5 Nm	2,5 Nm

Accessories

Insert types		AD..0803..L	AD..0803..R	AD..1204..L	AD..1204..R	AD..1606..L	AD..1606..R
	Finishing cartridge for tool body	FL695	FR695	FL696	FR696	FL696	FR696
	Finishing insert	P2905-0	P2905-0	P2905-1	P2905-1	P2905-1	P2905-1
	ISO 2936 Allen key for clamping wedge	ISO2936-3 (SW3)	ISO2936-3 (SW3)	ISO2936-4 (SW4)	ISO2936-4 (SW4)	ISO2936-4 (SW4)	ISO2936-4 (SW4)
	Screwdriver for indexable insert	FS1483 (Torx 8IP)	FS1483 (Torx 8IP)	FS1484 (Torx 9IP)	FS1484 (Torx 9IP)	FS1485 (Torx 15IP)	FS1485 (Torx 15IP)

Indexable inserts

Designation	Radius mm	Face chamfer width mm	P				M		K				N		S		H
			HC				HC		HC				HC	HW	HC		HC
			WKP25	WKP35	WKP35S	WSP45	WSM35	WSP45	WAK15	WKK25	WKP25	WKP35	WKP35S	WXN15	WK10	WSM35	WSP45
	ADHT0803PER-G88	0,4	1,2									☺	☺				
	ADHT0803PEL-G88	0,4	1,2									☺	☺				
	ADKT0803PER-F56	0,4	1,2	☺	☺	☺	☺	☺	☺	☺	☺			☺	☺		
	ADKT0803PEL-F56	0,4	1,2		☺	☺	☺	☺								☺	
	ADMT080304R-F56	0,4	1,2	☺	☺	☺	☺	☺	☺	☺	☺			☺	☺		
	ADMT080304L-F56	0,4	1,2		☺	☺	☺	☺								☺	
	ADMT080308R-F56	0,8	1,0		☺	☺	☺	☺						☺	☺		
	ADMT080308L-F56	0,8	1,0		☺	☺	☺	☺								☺	
	ADHT1204PER-G88	0,8	1,2									☺	☺				
	ADHT1204PEL-G88	0,8	1,2									☺	☺				
	ADKT1204PER-F56	0,8	1,2	☺	☺	☺	☺	☺	☺	☺	☺			☺	☺		
	ADKT1204PEL-F56	0,8	1,2		☺	☺	☺	☺								☺	
	ADMT120408R-F56	0,8	1,2	☺	☺	☺	☺	☺	☺	☺	☺			☺	☺		
	ADMT120408L-F56	0,8	1,2		☺	☺	☺	☺								☺	
	ADHT1606PER-G88	0,8	1,6									☺	☺				
	ADHT1606PEL-G88	0,8	1,6									☺	☺				
	ADKT1606PER-F56	0,8	1,6	☺	☺	☺	☺	☺	☺	☺	☺			☺	☺		
	ADKT1606PEL-F56	0,8	1,6		☺	☺	☺	☺								☺	
	ADMT160608R-F56	0,8	1,6	☺	☺	☺	☺	☺	☺	☺	☺			☺	☺		
	ADMT160608L-F56	0,8	1,6		☺	☺	☺	☺								☺	

HC = Coated carbide
HW = Uncoated carbide

WALTER SELECT

Best insert for:

☺
good

☹
moderate

☹
unfavourable

machining conditions



Side and face mill F 2252.B

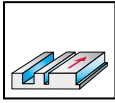

- Approach angle $\kappa = 90^\circ$
- Two cutting edges per indexable insert
- Positive basic insert shapes
- Full side and face milling
- Cutting on three sides

Tool	Designation	D _c mm	d ₁ mm	d ₆ mm	l ₄ mm	SB _{min}	SB _{max}	NB mm	Z	kg	No. of indexable inserts	Type	
Cyl. bore longitudinal key way DIN 138 	F2252.B.080.Z03.08.S684	80	22	37	8	8	9	8	3	0,2	6	MP...0603...	
	F2252.B.080.Z03.09.S684	80	22	37	9	9	10	9	3	0,2	6		
	F2252.B.100.Z04.08.S684	100	32	50	8	8	9	8	4	0,4	8		
	F2252.B.100.Z04.09.S684	100	32	50	9	9	10	9	4	0,4	8		
	F2252.B.125.Z05.08.S684	125	40	65	8	8	9	8	5	0,6	10		
	F2252.B.125.Z05.09.S684	125	40	65	9	9	10	9	5	0,7	10		
	F2252.B.160.Z06.08.S684	160	40	65	8	8	9	8	6	1,0	12		
	F2252.B.160.Z06.09.S684	160	40	65	9	9	10	9	6	1,1	12		
	F2252.B.100.Z04.10.S685	100	32	50	10	10	12	10	4	0,4	8		MP...0803...
	F2252.B.100.Z04.12.S685	100	32	50	12	12	14	12	4	0,5	8		
	F2252.B.100.Z04.14.S685	100	32	50	14	14	16	14	4	0,6	8		
	F2252.B.125.Z05.10.S685	125	40	65	10	10	12	10	5	0,6	10		
	F2252.B.125.Z05.12.S685	125	40	65	12	12	14	12	5	0,7	10		
	F2252.B.125.Z05.14.S685	125	40	65	14	14	16	14	5	0,8	10		
	F2252.B.160.Z06.10.S685	160	40	65	10	10	12	10	6	1,2	12		
	F2252.B.160.Z06.12.S685	160	40	65	12	12	14	12	6	1,4	12		
	F2252.B.160.Z06.14.S685	160	40	65	14	14	16	14	6	1,6	12		
	F2252.B.125.Z04.16.S686	125	40	65	16	16	19	16	4	0,9	8	MP...1204...	
	F2252.B.125.Z04.19.S686	125	40	65	19	19	22	19	4	1,1	8		
	F2252.B.125.Z04.22.S686	125	40	65	22	22	23,5	22	4	1,3	8		
	F2252.B.160.Z05.16.S686	160	40	65	16	16	19	16	5	1,7	10		
	F2252.B.160.Z05.19.S686	160	40	65	19	19	22	19	5	2,0	10		
	F2252.B.160.Z05.22.S686	160	40	65	22	22	23,5	22	5	2,3	10		
	F2252.B.200.Z06.16.S686	200	50	75	16	16	19	16	6	2,8	12		
	F2252.B.200.Z06.19.S686	200	50	75	19	19	22	19	6	3,3	12		
	F2252.B.200.Z06.22.S686	200	50	75	22	22	23,5	22	6	3,8	12		
	F2252.B.250.Z08.16.S686	250	60	90	16	16	19	16	8	4,5	16		
	F2252.B.250.Z08.19.S686	250	60	90	19	19	22	19	8	5,3	16		
	F2252.B.250.Z08.22.S686	250	60	90	22	22	23,5	22	8	6,2	16		
	F2252.B.315.Z10.16.S686	315	60	90	16	16	19	16	10	7,4	20		
	F2252.B.315.Z10.19.S686	315	60	90	19	19	22	19	10	8,9	20		

Bodies and assembly parts are included in the scope of delivery.
Cutting width can be adjusted.

Assembly parts

Insert types		MP .. 0603 ..	MP .. 0803 ..	MP .. 1204 ..
	Eccentric bolt	FS1169	FS1170	FS1171
	Spring washer	FS1220	FS1220	FS1221
	Cartridge for tool body	FL684	FL685	FL686
		FR684	FR685	FR686
	Clamping sleeve	FS1166	FS1167	FS1168
	Clamping wedge	FK358	FK360	FK359
	Clamping screw for clamping wedge	FS1161	FS239	FS1162
	Tightening torque	3,5 Nm	6,5 Nm	9,0 Nm
	Clamping screw for insert	FS923 (Torx 8)	FS1005 (Torx 8)	FS1029 (Torx 20)
	Tightening torque	0,8 Nm	1,5 Nm	5,0 Nm

Accessories

Insert types		MP .. 0603 ..	MP .. 0803 ..	MP .. 1204 ..
	Finishing cartridge for tool body		FR695	F696
			FL695	FL696
	Finishing insert		P2905-0	P2905-1
	ISO 2936 Allen key for clamping wedge	ISO2936-2.5 (SW2,5)	ISO2936-3 (SW3)	ISO2936-4 (SW4)
	Screwdriver for indexable insert	FS230 (Torx 8)	FS230 (Torx 8)	FS228 (Torx 20)

Indexable inserts

Designation	Radius mm	P				M			K				N		S		H
		HC				HC			HC				HC	HW	HC		HC
		WKP25	WKP35	WKP35S	WSP45	WSM35	WSP45	WAK15	WKK25	WKP25	WKP35	WKP35S	WXN15	WK10	WSM35	WSP45	WHH15
MPHT120408-G88	0,8																
MPHW120408-A57	0,8	☺	☺	☺			☺	☺	☺	☺	☺						
MPHX060304-A57	0,4	☺	☺	☺			☺	☺	☺	☺	☺						
MPHX060304-G88	0,4										☺						
MPHX080305-A57	0,5	☺	☺	☺			☺	☺	☺	☺							
MPHX080305-G88	0,5										☺						
MPMT120408-F57	0,8		☺	☺	☺	☺				☺	☺			☺	☺		
MPMX060304-F57	0,4		☺	☺	☺	☺				☺	☺			☺	☺		
MPMX080305-F57	0,5		☺	☺	☺	☺	☺			☺	☺			☺	☺		

HC = Coated carbide
HW = Uncoated carbide

WALTER SELECT

Best insert for:

☺
good

☹
moderate

☹
unfavourable

machining conditions

Side and face mill F 2252.BN

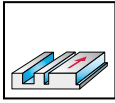

- Approach angle $\kappa = 90^\circ$
- Two cutting edges per indexable insert
- Positive basic insert shapes
- Full side and face milling
- Cutting on three sides

Tool	Designation	D _c mm	d ₁ mm	d ₆ mm	l ₄ mm	SB _{min}	SB _{max}	a _e mm	Z	kg	No. of indexable inserts	Type	
Cyl. bore longitudinal key way DIN 138 	F2252.BN.080.Z03.08.S684	80	22	35	40	8	9	20	3	0,4	6	MP...0603...	
	F2252.BN.080.Z03.09.S684	80	22	35	40	9	10	20	3	0,5	6		
	F2252.BN.100.Z04.08.S684	100	27	48	50	8	9	24	4	0,6	8		
	F2252.BN.100.Z04.09.S684	100	27	48	50	9	10	24	4	0,7	8		
	F2252.BN.125.Z05.08.S684	125	32	60	50	8	9	30	5	0,9	10		
	F2252.BN.125.Z05.09.S684	125	32	60	50	9	10	30	5	1,0	10		
	F2252.BN.160.Z06.08.S684	160	40	75	50	8	9	40	6	1,3	12		
	F2252.BN.160.Z06.09.S684	160	40	75	50	9	10	40	6	1,4	12		
	F2252.BN.100.Z04.10.S685	100	27	48	50	10	12	24	4	0,7	8		MP...0803...
	F2252.BN.100.Z04.12.S685	100	27	48	50	12	14	24	4	0,8	8		
	F2252.BN.100.Z04.14.S685	100	27	48	50	14	16	24	4	0,9	8		
	F2252.BN.125.Z05.10.S685	125	32	60	50	10	12	30	5	1,0	10		
	F2252.BN.125.Z05.12.S685	125	32	60	50	12	14	30	5	1,1	10		
	F2252.BN.125.Z05.14.S685	125	32	60	50	14	16	30	5	1,2	10		
	F2252.BN.160.Z06.10.S685	160	40	75	50	10	12	40	6	1,6	12		
	F2252.BN.160.Z06.12.S685	160	40	75	50	12	14	40	6	1,8	12		
	F2252.BN.160.Z06.14.S685	160	40	75	50	14	16	40	6	2,0	12		
	F2252.BN.125.Z04.16.S686	125	32	60	50	16	19	30	4	1,5	8	MP...1204...	
	F2252.BN.125.Z04.19.S686	125	32	60	50	19	22	30	4	1,7	8		
	F2252.BN.125.Z04.22.S686	125	32	60	50	22	23,5	30	4	1,9	8		
F2252.BN.160.Z05.16.S686	160	40	75	50	16	19	40	5	2,3	10			
F2252.BN.160.Z05.19.S686	160	40	75	50	19	22	40	5	2,6	10			
F2252.BN.160.Z05.22.S686	160	40	75	50	22	23,5	40	5	3,0	10			
F2252.BN.200.Z06.16.S686	200	40	90	50	16	19	50	6	3,5	12			
F2252.BN.200.Z06.19.S686	200	40	90	50	19	22	50	6	4,1	12			
F2252.BN.200.Z06.22.S686	200	40	90	50	22	23,5	50	6	4,6	12			
F2252.BN.250.Z08.16.S686	250	60/50 B	135	50	16	19	55	8	5,8	16			
F2252.BN.250.Z08.19.S686	250	60/50 B	135	50	19	22	55	8	6,6	16			
F2252.BN.250.Z08.22.S686	250	60/50 B	135	50	22	23,5	55	8	7,4	16			
F2252.BN.315.Z10.16.S686	315	60/50 B	135	50	16	19	85	10	11,4	20			
F2252.BN.315.Z10.19.S686	315	60/50 B	135	50	19	22	85	10	12,1	20			

Bodies and assembly parts are included in the scope of delivery.
Cutting width can be adjusted.

Assembly parts

Insert types		MP .. 0603 ..	MP .. 0803 ..	MP .. 1204 ..
	Eccentric bolt	FS1169	FS1170	FS1171
	Spring washer	FS1220	FS1220	FS1221
	Cartridge for tool body	FL684	FL685	FL686
		FR684	FR685	FR686
	Clamping sleeve	FS1166	FS1167	FS1168
	Clamping wedge	FK358	FK360	FK359
	Clamping screw for clamping wedge	FS1161	FS239	FS1162
	Tightening torque	3,5 Nm	6,5 Nm	
	Clamping screw for insert	FS923 (Torx 8)	FS1005 (Torx 8)	FS1029 (Torx 20)
	Tightening torque	0,8 Nm	1,5 Nm	

Accessories

Insert types		MP .. 0603 ..	MP .. 0803 ..	MP .. 1204 ..
	Finishing cartridge for tool body		FR695	F696
			FL695	FL696
	Finishing insert		P2905-0	P2905-1
	ISO 2936 Allen key for clamping wedge	ISO2936-2.5 (SW2,5)	ISO2936-3 (SW3)	ISO2936-4 (SW4)
	Screwdriver for indexable insert	FS230 (Torx 8)	FS230 (Torx 8)	FS228 (Torx 20)

Indexable inserts

Designation	Radius mm	P				M		K				N		S		H
		HC				HC		HC				HC	HW	HC		HC
		WKP25	WKP35	WKP35S	WSP45	WSM35	WSP45	WAK15	WKK25	WKP25	WKP35	WKP35S	WXN15	WK10	WSM35	WSP45
MPHT120408-G88	0,8											☺				
MPHW120408-A57	0,8	☹	☹	☹			☹	☹	☹	☹	☹	☹				
MPHX060304-A57	0,4	☹	☹	☹			☹	☹	☹	☹	☹	☹				
MPHX060304-G88	0,4											☺				
MPHX080305-A57	0,5	☹	☹	☹			☹	☹	☹	☹	☹	☹				
MPHX080305-G88	0,5											☺				
MPMT120408-F57	0,8		☹	☹	☹	☹				☹	☹				☹	☹
MPMX060304-F57	0,4		☹	☹	☹	☹				☹	☹				☹	☹
MPMX080305-F57	0,5		☹	☹	☹	☹	☹			☹	☹				☹	☹

HC = Coated carbide
HW = Uncoated carbide

WALTER SELECT

Best insert for:

☺
good

☹
moderate

☹
unfavourable

machining conditions

Slitting cutter F 2255.B

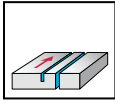

- Approach angle $\kappa = 90^\circ$
- One cutting edge per indexable insert
- Positive basic insert shapes

Tool	Designation	D _c mm	d ₁ mm	SB mm	a _e max mm	l ₁₀ mm	Z	kg	No. of indexable inserts	
									Type	Type
Cyl. bore longitudinal key way DIN 138 	F2255.B.063.Z05.1,6	63	16	1,6	15	1,3	5	0,1	5	NSM 3.90016 ..
	F2255.B.063.Z05.2,2	63	16	2,2	15	1,8	5	0,1	5	NSM 3.90022 ..
	F2255.B.063.Z04.3,0	63	16	3	15	2,4	4	0,1	4	NSM 3.90030 ..
	F2255.B.063.Z04.4,0	63	16	4	15	3,4	4	0,1	4	NSM 3.90040 ..
	F2255.B.080.Z07.1,6	80	16	1,6	21	1,3	7	0,1	7	NSM 3.90016 ..
	F2255.B.080.Z07.2,2	80	16	2,2	21	1,8	7	0,1	7	NSM 3.90022 ..
	F2255.B.080.Z06.3,0	80	16	3	21	2,4	6	0,1	6	NSM 3.90030 ..
	F2255.B.080.Z06.4,0	80	16	4	21	3,4	6	0,1	6	NSM 3.90040 ..
	F2255.B.100.Z09.1,6	100	22	1,6	27	1,3	9	0,1	9	NSM 3.90016 ..
	F2255.B.100.Z09.2,2	100	22	2,2	27	1,8	9	0,1	9	NSM 3.90022 ..
	F2255.B.100.Z09.3,0	100	22	3	27	2,4	9	0,1	9	NSM 3.90030 ..
	F2255.B.100.Z09.4,0	100	22	4	27	3,4	9	0,2	9	NSM 3.90040 ..
	F2255.B.125.Z11.1,6	125	32	1,6	35	1,3	11	0,1	11	NSM 3.90016 ..
	F2255.B.125.Z11.2,2	125	32	2,2	35	1,8	11	0,1	11	NSM 3.90022 ..
	F2255.B.125.Z11.3,0	125	32	3	35	2,4	11	0,2	11	NSM 3.90030 ..
	F2255.B.125.Z11.4,0	125	32	4	35	3,4	11	0,3	11	NSM 3.90040 ..
	F2255.B.160.Z14.2,2	160	40	2,2	40	1,8	14	0,3	14	NSM 3.90022 ..
	F2255.B.160.Z14.3,0	160	40	3	40	2,4	14	0,4	14	NSM 3.90030 ..
	F2255.B.160.Z14.4,0	160	40	4	40	3,4	14	0,4	14	NSM 3.90040 ..
	F2255.B.200.Z19.3,0	200	40	3	60	2,4	19	0,5	19	NSM 3.90030 ..
	F2255.B.200.Z19.4,0	200	40	4	60	3,4	19	0,7	19	NSM 3.90040 ..
	F2255.B.250.Z24.3,0	250	40	3	85	2,4	24	0,8	24	NSM 3.90030 ..
	F2255.B.250.Z24.4,0	250	40	4	85	3,4	24	1,0	24	NSM 3.90040 ..

Values for a_e max in combination with drive collar.

For information on high-speed applications, see page F 310.

To fit the indexable insert, use the insert key FS 1353 (see page F 304).

Accessories	D _c mm SB	63 1,6-2,2	63 3-4	80 1,6-4	100 1,6-4	125 1,6-4	160 2,2-4	200 3-4	250 3-4
 Drive collar Insert key Clamping screw for retaining washer Retaining washer instead of drive collar		FS1345	FS1346	FS1347	FS1348	FS1349	FS1350	FS1350	FS1350
		FS1353	FS1353	FS1353	FS1353	FS1353	FS1353	FS1353	FS1353
								FS966 (SW 5)	FS966 (SW 5)
								FS1351	FS1352
									FS1351

The drive collar or retaining washers should always be ordered in pairs.
Clamping screws for retaining washers are included in the scope of delivery.

Indexable inserts

Designation	SB mm	Radius mm	P					M		K			N		H	HF			
			HC					HC		HC			HW	HC	HC	WMG30			
			WKP25	WKP35	WKP35S	WXP35	WTP35	WSP45	WSM35	WSP45	WAK15	WAK25	WKP25	WKP35	WKP35S	WK10	WXN15	WHH15	WMG30
NSM3.90016EC-GDW	1,6	0,15																	
NSM3.90016SN-GBW	1,6	0,15																	
NSM3.90016SN-GDW	1,6	0,15																	
NSM3.90022EC-GDW	2,2	0,2																	
NSM3.90022SN-GBW	2,2	0,2																	
NSM3.90022SN-GDW	2,2	0,2																	
NSM3.90030EC-GDW	3,0	0,2																	
NSM3.90030SN-GBW	3,0	0,2																	
NSM3.90030SN-GDW	3,0	0,2																	
NSM3.90040EC-GDW	4,0	0,2																	
NSM3.90040SN-GBW	4,0	0,2																	
NSM3.90040SN-GDW	4,0	0,2																	

HC = Coated carbide
HW = Uncoated carbide
HF = Uncoated fine-grained carbide

WALTER SELECT

Best insert for:

good

moderate

unfavourable

machining conditions

Side and face mill F 4053

Xtra-tec®

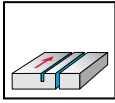

- Approach angle $\kappa = 90^\circ$
- Two + two cutting edges per indexable insert
- Negative basic insert shapes
- Tangential indexable insert arrangement
- Full side and face milling
- Cutting on three sides

Tool	Designation	D _C mm	d ₁ mm	d ₆ mm	SB mm	a _e max mm	NB mm	Z	kg	No. of indexable inserts	Type
Cyl. bore longitudinal key way DIN 138	F4053.B27.080.Z04.04	80	27	42	4	18	8	4	0,2	8	LN . . 0702 . .
	F4053.B32.100.Z05.04	100	32	50	4	24	8	5	0,3	10	
	F4053.B40.125.Z06.04	125	40	65	4	29	8	6	0,4	12	
	F4053.B40.160.Z08.04	160	40	65	4	46	8	8	0,7	16	

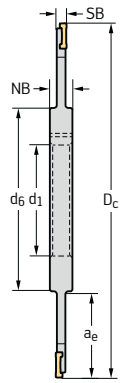

Bodies and assembly parts are included in the scope of delivery.

Assembly parts

		D _C mm	80-160
	Clamping screw for insert		FS2076 (Torx 6 IP)
	Tightening torque		0,6 Nm

Accessories

		D _C mm	80-160
	Torque screwdriver		FS2001
	Screwdriver		FS2086 (Torx 6IP)
	Interchangeable blade		FS2085 (Torx 6IP)

Indexable inserts

Designation	Radius mm	P				M		K				N		S		H
		HC				HC		HC				HC	HW	HC	HC	HC
		WKP25	WKP35	WKP35S	WSP45	WSM35	WSP45	WAK15	WKK25	WKP25	WKP35	WKP35S	WXN15	WK10	WSM35	WSP45
LNHX070204-D57T	0,4	☺	☺	☺	☺	☺	☺	☺	☺	☺	☺					
LNHX070204-F57T	0,4	☺	☺	☺	☺	☺	☺	☺	☺	☺	☺			☺	☺	
LNMX070204-D57T	0,4	☺	☺	☺	☺	☺	☺	☺	☺	☺	☺			☺	☺	
LNMX070204-F57T	0,4	☺	☺	☺	☺	☺	☺	☺	☺	☺	☺			☺	☺	

HC = Coated carbide
HW = Uncoated carbide

WALTER SELECT

Best insert for:

☺
good

☺
moderate

☺
unfavourable

machining conditions

Side and face mill F 4053.BN

Xtra-tec®



- Approach angle $\kappa = 90^\circ$
- Two + two cutting edges per indexable insert
- Negative basic insert shapes
- Tangential indexable insert arrangement
- Full side and face milling
- Cutting on three sides

Tool	Designation	D_C mm	d_1 mm	d_6 mm	l_4 mm	SB mm	a_e max mm	Z	kg	No. of indexable inserts	Type
Cyl. bore longitudinal key way DIN 138	F4053.BN22.080.Z04.04R	80	22	45	40	4	16	4	0,5	8	LN . . 0702 . .
	F4053.BN27.100.Z05.04R	100	27	48	50	4	24	5	0,7	10	
	F4053.BN32.125.Z06.04R	125	32	60	50	4	30	6	1,1	12	
	F4053.BN40.160.Z08.04R	160	40	75	50	4	40	8	1,6	16	

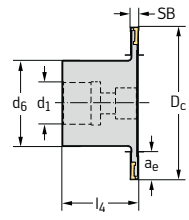



Bodies and assembly parts are included in the scope of delivery.

Assembly parts

D _C mm		80-160
	Clamping screw for insert	FS2076 (Torx 6 IP)
	Tightening torque	0,6 Nm

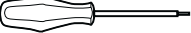
Accessories

D _C mm		80-160
	Torque screwdriver	FS2001
	Screwdriver	FS2086 (Torx 6IP)
	Interchangeable blade	FS2085 (Torx 6IP)

Indexable inserts

Designation	Radius mm	P				M		K				N		S		H
		HC				HC		HC				HC	HW	HC		HC
		WKP25	WKP35	WKP35S	WSP45	WSM35	WSP45	WAK15	WKK25	WKP25	WKP35	WKP35S	WXN15	WK10	WSM35	WSP45
 LNHX070204-D57T	0,4	☉	☉	☉	☉	☉	☉	☉	☉	☉	☉					
LNHX070204-F57T	0,4	☉	☉	☉	☉	☉	☉	☉	☉	☉	☉					
LNMX070204-D57T	0,4	☉	☉	☉	☉	☉	☉	☉	☉	☉	☉			☉	☉	
LNMX070204-F57T	0,4	☉	☉	☉	☉	☉	☉	☉	☉	☉	☉			☉	☉	

HC = Coated carbide
HW = Uncoated carbide

WALTER SELECT

Best insert for:

☉
good

☉
moderate

☉
unfavourable

machining conditions

Side and face mill F 4153

Xtra-tec®

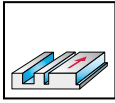

- Approach angle $\kappa = 90^\circ$
- Two + two cutting edges per indexable insert
- Negative basic insert shapes
- Tangential indexable insert arrangement
- Full side and face milling
- Cutting on three sides

Tool	Designation	D _C mm	d ₁ mm	d ₆ mm	SB mm	a _e max mm	NB mm	Z	kg	No. of indexable inserts	Type
Cyl. bore longitudinal key way DIN 138 	F4153.B27.080.Z04.06	80	27	42	6	18	12	4	0,2	8	LN . . 0803 . .
	F4153.B32.100.Z05.06	100	32	50	6	24	12	5	0,3	10	
	F4153.B40.125.Z06.06	125	40	65	6	29	12	6	0,5	12	
	F4153.B40.160.Z08.06	160	40	65	6	46	12	8	0,8	16	
	F4153.B50.200.Z09.06	200	50	75	6	61	12	9	1,2	18	
	F4153.B27.080.Z04.08	80	27	42	8	18	12	4	0,2	8	
	LN . . 0804 . .	F4153.B32.100.Z05.08	100	32	50	8	24	12	5	0,4	10
		F4153.B40.125.Z06.08	125	40	65	8	29	12	6	0,6	12
		F4153.B40.160.Z08.08	160	40	65	8	46	12	8	1,0	16
		F4153.B50.200.Z09.08	200	50	75	8	61	12	9	1,5	18
		F4153.B27.080.Z04.10	80	27	42	10	18	12	4	0,2	8
		F4153.B32.100.Z05.10	100	32	50	10	24	12	5	0,4	10
	LN . . 1005 . .	F4153.B40.125.Z06.10	125	40	65	10	29	12	6	0,6	12
		F4153.B40.160.Z07.10	160	40	65	10	46	12	7	1,1	14
		F4153.B50.200.Z08.10	200	50	75	10	61	12	8	1,6	16

Bodies and assembly parts are included in the scope of delivery.

Assembly parts

Insert types	LN . . 0803 . .	LN . . 0804 . .	LN . . 1005 . .
Clamping screw for insert	FS2077 (Torx 9 IP)	FS2078 (Torx 9 IP)	FS2080 (Torx 15 IP)
Tightening torque	1,5 Nm	1,5 Nm	2,5 Nm

Accessories

Insert types	LN . . 0803 . .-LN . . 0804 . .	LN . . 1005 . .
Torque screwdriver	FS2003	FS2003
Screwdriver	FS1484 (Torx 9IP)	FS1485 (Torx 15IP)
Interchangeable blade	FS2013 (Torx 9IP)	FS2014 (Torx 15IP)

Indexable inserts

Designation	Radius mm	P				M		K				N		S		H
		HC				HC		HC				HC	HW	HC		HC
		WKP25	WKP35	WKP35S	WSP45	WSM35	WSP45	WAK15	WKK25	WKP25	WKP35	WKP35S	WXN15	WK10	WSM35	WSP45
LNHU080304-B57T	0,4	⊗	⊗	⊗	⊗	⊗	⊗	⊗	⊗	⊗	⊗					
LNHU080304-F57T	0,4	⊗	⊗	⊗	⊗	⊗	⊗	⊗	⊗	⊗	⊗					
LNHU080404-B57T	0,4	⊗	⊗	⊗	⊗	⊗	⊗	⊗	⊗	⊗	⊗					
LNHU080404-F57T	0,4	⊗	⊗	⊗	⊗	⊗	⊗	⊗	⊗	⊗	⊗					
LNHU100508-B57T	0,8	⊗	⊗	⊗	⊗	⊗	⊗	⊗	⊗	⊗	⊗					
LNHU100508-F57T	0,8	⊗	⊗	⊗	⊗	⊗	⊗	⊗	⊗	⊗	⊗					
LNMU080304-B57T	0,4	⊗	⊗	⊗	⊗	⊗	⊗	⊗	⊗	⊗	⊗					
LNMU080304-F57T	0,4	⊗	⊗	⊗	⊗	⊗	⊗	⊗	⊗	⊗	⊗					
LNMU080404-B57T	0,4	⊗	⊗	⊗	⊗	⊗	⊗	⊗	⊗	⊗	⊗					
LNMU080404-F57T	0,4	⊗	⊗	⊗	⊗	⊗	⊗	⊗	⊗	⊗	⊗					
LNMU100508-B57T	0,8	⊗	⊗	⊗	⊗	⊗	⊗	⊗	⊗	⊗	⊗					
LNMU100508-F57T	0,8	⊗	⊗	⊗	⊗	⊗	⊗	⊗	⊗	⊗	⊗					

HC = Coated carbide
HW = Uncoated carbide

WALTER SELECT

Best insert for:

good

moderate

unfavourable

machining conditions

Side and face mill F 4153.BN

Xtra-tec®

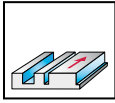

- Approach angle $\kappa = 90^\circ$
- Two + two cutting edges per indexable insert
- Negative basic insert shapes
- Tangential indexable insert arrangement
- Full side and face milling
- Cutting on three sides

Tool	Designation	D _C mm	d ₁ mm	d ₆ mm	l ₄ mm	SB mm	a _e max mm	Z	kg	No. of indexable inserts	Type
Cyl. bore longitudinal key way DIN 138 	F4153.BN22.080.Z04.06R	80	22	45	40	6	16	4	0,5	8	LN . . 0803 . .
	F4153.BN27.100.Z05.06R	100	27	48	50	6	25	5	0,7	10	
	F4153.BN32.125.Z06.06R	125	32	60	50	6	30	6	1,1	12	
	F4153.BN40.160.Z08.06R	160	40	75	50	6	40	8	1,5	16	
	F4153.BN40.200.Z09.06R	200	40/40 B	90	50	6	50	9	2,3	18	
	F4153.BN22.080.Z04.08R	80	22	45	40	8	16	4	0,5	8	LN . . 0804 . .
	F4153.BN27.100.Z05.08R	100	27	48	50	8	25	5	0,8	10	
	F4153.BN32.125.Z06.08R	125	32	60	50	8	30	6	1,2	12	
	F4153.BN40.160.Z08.08R	160	40	75	50	8	40	8	1,7	16	
	F4153.BN40.200.Z09.08R	200	40/40 B	90	50	8	50	9	2,6	18	
	F4153.BN22.080.Z04.10R	80	22	45	40	10	16	4	0,5	8	LN . . 1005 . .
	F4153.BN27.100.Z05.10R	100	27	48	50	10	25	5	0,8	10	
	F4153.BN32.125.Z06.10R	125	32	60	50	10	30	6	1,3	12	
	F4153.BN40.160.Z07.10R	160	40	75	50	10	40	7	1,9	14	
	F4153.BN40.200.Z08.10R	200	40/40 B	90	50	10	50	8	2,8	16	

Bodies and assembly parts are included in the scope of delivery.

Assembly parts

Insert types	LN . . 0803 . .	LN . . 0804 . .	LN . . 1005 . .
Clamping screw for insert	FS2077 (Torx 9 IP)	FS2078 (Torx 9 IP)	FS2080 (Torx 15 IP)
Tightening torque	1,5 Nm	1,5 Nm	2,5 Nm

Accessories

Insert types	LN . . 0803 . .-LN . . 0804 . .	LN . . 1005 . .
Torque screwdriver	FS2003	FS2003
Screwdriver	FS1484 (Torx 9IP)	FS1485 (Torx 15IP)
Interchangeable blade	FS2013 (Torx 9IP)	FS2014 (Torx 15IP)

Indexable inserts

Designation	Radius mm	P				M		K				N		S		H
		HC				HC		HC				HC	HW	HC		HC
		WKP25	WKP35	WKP35S	WSP45	WSM35	WSP45	WAK15	WKK25	WKP25	WKP35	WKP35S	WXN15	WK10	WSM35	WSP45
LNHU080304-B57T	0,4	⊗	⊗	⊗	⊗	⊗	⊗	⊗	⊗	⊗	⊗					
LNHU080304-F57T	0,4	⊗	⊗	⊗	⊗	⊗	⊗	⊗	⊗	⊗	⊗					
LNHU080404-B57T	0,4	⊗	⊗	⊗	⊗	⊗	⊗	⊗	⊗	⊗	⊗					
LNHU080404-F57T	0,4	⊗	⊗	⊗	⊗	⊗	⊗	⊗	⊗	⊗	⊗					
LNHU100508-B57T	0,8	⊗	⊗	⊗	⊗	⊗	⊗	⊗	⊗	⊗	⊗					
LNHU100508-F57T	0,8	⊗	⊗	⊗	⊗	⊗	⊗	⊗	⊗	⊗	⊗					
LNMU080304-B57T	0,4	⊗	⊗	⊗	⊗	⊗	⊗	⊗	⊗	⊗	⊗					
LNMU080304-F57T	0,4	⊗	⊗	⊗	⊗	⊗	⊗	⊗	⊗	⊗	⊗					
LNMU080404-B57T	0,4	⊗	⊗	⊗	⊗	⊗	⊗	⊗	⊗	⊗	⊗					
LNMU080404-F57T	0,4	⊗	⊗	⊗	⊗	⊗	⊗	⊗	⊗	⊗	⊗					
LNMU100508-B57T	0,8	⊗	⊗	⊗	⊗	⊗	⊗	⊗	⊗	⊗	⊗					
LNMU100508-F57T	0,8	⊗	⊗	⊗	⊗	⊗	⊗	⊗	⊗	⊗	⊗					

HC = Coated carbide
HW = Uncoated carbide

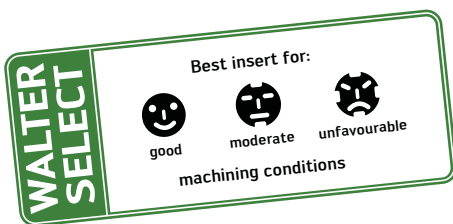

Side and face mill F 4253.B

Xtra-tec®

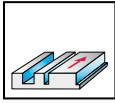

- Approach angle $\kappa = 90^\circ$
- Two + two cutting edges per indexable insert
- Negative basic insert shapes
- Tangential indexable insert arrangement
- Cross-toothed, cutting on three sides
- Axial runout adjustable

Tool	Designation	D _C mm	d ₁ mm	d ₆ mm	SB mm	a _e mm	NB mm	Z	kg	No. of indexable inserts	Type	
Cyl. bore longitudinal key way DIN 138 	F4253.B32.100.Z05.12	100	32	50	12	24	12	5	0,5	10	LN .. 0804 ..	
	F4253.B40.125.Z06.12	125	40	65	12	29	12	6	0,8	12		
	F4253.B40.160.Z07.12	160	40	65	12	46	12	7	1,3	14		
	F4253.B50.200.Z08.12	200	50	75	12	61	12	8	2,2	16		
	F4253.B32.100.Z05.14	100	32	50	14	24	14	5	0,6	10		
	F4253.B40.125.Z06.14	125	40	65	14	29	14	6	0,9	12		
	F4253.B40.160.Z07.14	160	40	65	14	46	14	7	1,6	14		
	F4253.B50.200.Z08.14	200	50	75	14	61	14	8	2,6	16		
	F4253.B40.125.Z05.16	125	40	65	16	29	16	5	1,0	10		LN .. 1005 ..
	F4253.B40.160.Z06.16	160	40	65	16	46	16	6	1,8	12		
	F4253.B50.200.Z07.16	200	50	75	16	61	16	7	2,8	14		
	F4253.B40.160.Z06.20	160	40	65	20	29	20	6	2,2	12	LN .. 1206 ..	
	F4253.B50.200.Z07.20	200	50	75	20	46	20	7	3,5	14		
	F4253.B60.250.Z08.20	250	60	90	20	78	20	8	5,6	16	LN .. 1605 ..	
	F4253.B40.160.Z06.25	160	40	65	25	29	25	6	2,8	12		
	F4253.B50.200.Z07.25	200	50	75	25	46	25	7	4,4	14		
	F4253.B60.250.Z08.25	250	60	90	25	78	25	8	7,1	16		
	F4253.B60.315.Z10.25	315	60	90	25	110	25	10	13,3	20		

Bodies and assembly parts are included in the scope of delivery.

Assembly parts

Insert types	LN .. 0804 ..	LN .. 1005 ..	LN .. 1206 ..	LN .. 1605 ..
Adjusting screw for axial runout	FS2082	FS2083	FS2083	FS2113
Clamping screw for insert	FS2079 (Torx 9 IP)	FS1453 (Torx 15 IP)	FS2081 (Torx 15 IP)	FS2112 (Torx 20 IP)
Tightening torque	2,0 Nm	3,0 Nm	3,0 Nm	5,0 Nm

Accessories

Insert types	LN .. 0804 ..	LN .. 1005 .. LN .. 1206 ..	LN .. 1605 ..
Torque screwdriver	FS2003	FS2003	FS2003
Key for adjusting screw	FS2087 (Torx 6IP)	FS1490 (Torx 7IP)	FS1466 (Torx 9IP)
Screwdriver for clamping screw	FS1484 (Torx 9IP)	FS1485 (Torx 15IP)	FS1486 (Torx 20IP)
Interchangeable blade	FS2013 (Torx 9IP)	FS2014 (Torx 15IP)	FS2015 (Torx 20IP)

Indexable inserts

Designation	Radius mm	P				M		K				N		S		H
		HC				HC		HC				HC	HW	HC		HC
		WKP25	WKP35	WKP35S	WSP45	WSM35	WSP45	WAK15	WKK25	WKP25	WKP35	WKP35S	WXN15	WK10	WSM35	WSP45
LNHU100508-B57T	0,8	☺	☺	☺	☺	☺	☺	☺	☺	☺	☺	☺	☺	☺	☺	☺
LNHU100508-F57T	0,8	☺	☺	☺	☺	☺	☺	☺	☺	☺	☺	☺	☺	☺	☺	☺
LNHU120608-B57T	0,8	☺	☺	☺	☺	☺	☺	☺	☺	☺	☺	☺	☺	☺	☺	☺
LNHU120608-F57T	0,8	☺	☺	☺	☺	☺	☺	☺	☺	☺	☺	☺	☺	☺	☺	☺
LNHU160812-B57T	1,2	☺	☺	☺	☺	☺	☺	☺	☺	☺	☺	☺	☺	☺	☺	☺
LNHU160812-F57T	1,2	☺	☺	☺	☺	☺	☺	☺	☺	☺	☺	☺	☺	☺	☺	☺
LNMU100508-B57T	0,8	☺	☺	☺	☺	☺	☺	☺	☺	☺	☺	☺	☺	☺	☺	☺
LNMU100508-F57T	0,8	☺	☺	☺	☺	☺	☺	☺	☺	☺	☺	☺	☺	☺	☺	☺
LNMU120608-B57T	0,8	☺	☺	☺	☺	☺	☺	☺	☺	☺	☺	☺	☺	☺	☺	☺
LNMU120608-F57T	0,8	☺	☺	☺	☺	☺	☺	☺	☺	☺	☺	☺	☺	☺	☺	☺
LNMU160812-B57T	1,2	☺	☺	☺	☺	☺	☺	☺	☺	☺	☺	☺	☺	☺	☺	☺
LNMU160812-F57T	1,2	☺	☺	☺	☺	☺	☺	☺	☺	☺	☺	☺	☺	☺	☺	☺

HC = Coated carbide
HW = Uncoated carbide

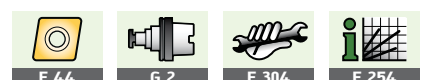
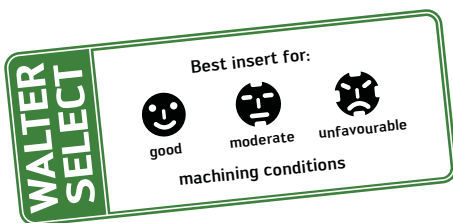

Side and face mill F 4253.BN

Xtra-tec®

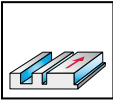

- Approach angle $\kappa = 90^\circ$
- Two + two cutting edges per indexable insert
- Negative basic insert shapes
- Tangential indexable insert arrangement
- Cross-toothed, cutting on three sides
- Axial runout adjustable

Tool	Designation	D _C mm	d ₁ mm	d ₆ mm	l ₄ mm	SB mm	a _e max mm	Z	kg	No. of indexable inserts	Type
Cyl. bore longitudinal key way DIN 138 	F4253.BN27.100.Z05.12R	100	27	48	50	12	24	5	0,9	10	LN ... 0804 ...
	F4253.BN32.125.Z06.12R	125	32	60	50	12	30	6	1,5	12	
	F4253.BN40.160.Z07.12R	160	40	75	50	12	40	7	2,2	14	
	F4253.BN40.200.Z08.12R	200	40/40 B	90	50	12	50	8	3,7	16	
	F4253.BN27.100.Z05.14R	100	27	48	50	14	24	5	1,1	10	
	F4253.BN32.125.Z06.14R	125	32	60	50	14	30	6	1,6	12	
	F4253.BN40.160.Z07.14R	160	40	75	50	14	40	7	2,4	14	
	F4253.BN40.200.Z08.14R	200	40/40 B	90	50	14	50	8	3,7	16	
	F4253.BN32.125.Z05.16R	125	32	60	50	16	30	5	1,8	10	LN ... 1005 ...
	F4253.BN40.160.Z06.16R	160	40	75	50	16	40	6	2,6	12	
	F4253.BN40.200.Z07.16R	200	40/40 B	90	50	16	50	7	3,8	14	
	F4253.BN40.160.Z06.20R	160	40	75	50	20	40	6	2,9	12	LN ... 1206 ...
	F4253.BN40.200.Z07.20R	200	40/40 B	90	50	20	50	7	4,4	14	
	F4253.BN60.250.Z08.20R	250	60/50 B	135	50	20	55	8	7,6	16	
	F4253.BN40.160.Z06.25R	160	40	75	50	25	40	6	3,2	12	LN ... 1605 ...
	F4253.BN40.200.Z07.25R	200	40/40B	90	50	25	50	7	5,1	14	
	F4253.BN60.250.Z08.25R	250	60/50B	90	50	25	55	8	8,7	16	
	F4253.BN60.315.Z10.25R	315	60/50B	135	50	25	85	10	13,4	20	

Bodies and assembly parts are included in the scope of delivery.

Assembly parts

Insert types	LN .. 0804 ..	LN .. 1005 ..	LN .. 1206 ..	LN .. 1605 ..
Adjusting screw for axial runout	FS2082	FS2083	FS2083	FS2113
Clamping screw for insert	FS2079 (Torx 9 IP)	FS1453 (Torx 15 IP)	FS2081 (Torx 15 IP)	FS2112 (Torx 20 IP)
Tightening torque	2,0 Nm	3,0 Nm	3,0 Nm	5,0 Nm

Accessories

Insert types	LN .. 0804 ..	LN .. 1005 .. LN .. 1206 ..	LN .. 1605 ..
Torque screwdriver	FS2003	FS2003	FS2003
Key for adjusting screw	FS2087 (Torx 6IP)	FS1490 (Torx 7IP)	FS1466 (Torx 9IP)
Screwdriver for clamping screw	FS1484 (Torx 9IP)	FS1485 (Torx 15IP)	FS1486 (Torx 20IP)
Interchangeable blade	FS2013 (Torx 9IP)	FS2014 (Torx 15IP)	FS2015 (Torx 20IP)

Indexable inserts

Designation	Radius mm	P				M		K				N		S		H
		HC				HC		HC				HC	HW	HC		HC
		WKP25	WKP35	WKP35S	WSP45	WSM35	WSP45	WAK15	WKK25	WKP25	WKP35	WKP35S	WXN15	WK10	WSM35	WSP45
LNHU100508-B57T	0,8	☺	☺	☺	☺	☺	☺	☺	☺	☺	☺					
LNHU100508-F57T	0,8	☺	☺	☺	☺	☺	☺	☺	☺	☺	☺			☺	☺	
LNHU120608-B57T	0,8	☺	☺	☺	☺	☺	☺	☺	☺	☺	☺					
LNHU120608-F57T	0,8	☺	☺	☺	☺	☺	☺	☺	☺	☺	☺			☺	☺	
LNHU160812-B57T	1,2	☺	☺	☺	☺	☺	☺	☺	☺	☺	☺					
LNHU160812-F57T	1,2	☺	☺	☺	☺	☺	☺	☺	☺	☺	☺			☺	☺	
LNMU100508-B57T	0,8	☺	☺	☺	☺	☺	☺	☺	☺	☺	☺					
LNMU100508-F57T	0,8	☺	☺	☺	☺	☺	☺	☺	☺	☺	☺			☺	☺	
LNMU120608-B57T	0,8	☺	☺	☺	☺	☺	☺	☺	☺	☺	☺					
LNMU120608-F57T	0,8	☺	☺	☺	☺	☺	☺	☺	☺	☺	☺			☺	☺	
LNMU160812-B57T	1,2	☺	☺	☺	☺	☺	☺	☺	☺	☺	☺					
LNMU160812-F57T	1,2	☺	☺	☺	☺	☺	☺	☺	☺	☺	☺			☺	☺	

HC = Coated carbide
HW = Uncoated carbide

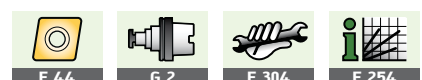
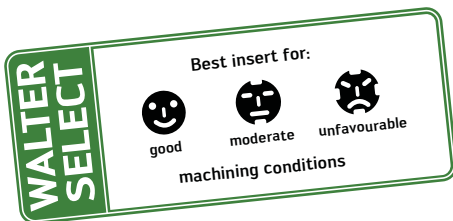

Walter Select – copy milling

Application					
Copy milling cutter	F 2139	F 2239 B	F 2231 / A	F 4031 Xtra-tec®	F 2339 / A + B
Ø range [mm]	8–32	20–50	10–40	8–32	16–50
Page	F 214	F 226	F 216	F 232	F 228
P Steel	••	••	••	••	••
M Stainless steel	••	•	••	••	••
K Cast iron	••	••	••	••	••
N NF metals	••	•	••	•	•
S Difficult-to-machine materials	••	•	•	••	•
H Hard materials	••		••	••	•
O Other	•	•	•		
Basic insert shapes					
Insert types	P 3201 P 3204	P 2631 ..	RD .. 0501/0803 .. RD .. 10T3/1204 .. RD .. 1505/1605 .. RD .. 2006 ..	P 8001	XD .. 13/16/20/24 .. XD .. 25/32/40 .. SP .. 0603/09T3 .. SP .. 1204 ..
Max. cutting depths [mm]	4–16	15–39	2,5–10		11–57
Number of cutting edges per indexable insert	1	3	–	1	2/4

	<p style="text-align: center;">F 2239</p>	<p style="text-align: center;">F 2234</p>	<p style="text-align: center;">F 2334</p>
	<p style="text-align: center;">20-63</p>	<p style="text-align: center;">12-160</p>	<p style="text-align: center;">25-160</p>
	<p style="text-align: center;">F 226</p>	<p style="text-align: center;">F 218</p>	<p style="text-align: center;">F 222</p>
	<p style="text-align: center;">••</p>	<p style="text-align: center;">••</p>	<p style="text-align: center;">••</p>
	<p style="text-align: center;">•</p>	<p style="text-align: center;">••</p>	<p style="text-align: center;">••</p>
	<p style="text-align: center;">••</p>	<p style="text-align: center;">••</p>	<p style="text-align: center;">••</p>
	<p style="text-align: center;">•</p>	<p style="text-align: center;">••</p>	<p style="text-align: center;">•</p>
	<p style="text-align: center;">•</p>	<p style="text-align: center;">•</p>	<p style="text-align: center;">••</p>
	<p style="text-align: center;">•</p>	<p style="text-align: center;">••</p>	<p style="text-align: center;">•</p>
	<p style="text-align: center;">•</p>	<p style="text-align: center;">•</p>	<p style="text-align: center;">•</p>
	<p>P 2631 .. SP .. 0603 .. SP .. 09T3 .. SP .. 1204 ..</p>	<p>RD ..</p>	<p>RO . X ..</p>
	<p style="text-align: center;">15-84</p>	<p style="text-align: center;">2,5-10</p>	<p style="text-align: center;">4-10</p>
	<p style="text-align: center;">3/4</p>	<p style="text-align: center;">-</p>	<p style="text-align: center;">4/6/8</p>



Profile mill F 2139

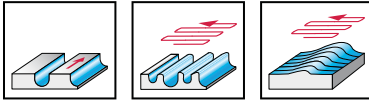

- For HSC machining
- One cutting edge per indexable insert
- Positive basic insert shape

Tool	Designation	D _c mm	R mm	d ₁ mm	l ₃ mm	l ₄ mm	l ₁ mm	Z	kg	No. of indexable inserts	Insert type
NCT ScrewFit 	F2139.T09.008.Z02.04	8	4	T09		20		2	0,1	1	P 32... - D 08
	F2139.T09.010.Z02.05	10	5	T09		25		2	0,1	1	P 32... - D 10
	F2139.T09.012.Z02.06	12	6	T09		25		2	0,1	1	P 32... - D 12
	F2139.T14.012.Z02.06	12	6	T14		25		2	0,1	1	
	F2139.T14.016.Z02.08	16	8	T14		25		2	0,1	1	P 32... - D 16
	F2139.T18.020.Z02.10	20	10	T18		30		2	0,1	1	P 32... - D 20
	F2139.T22.025.Z02.12	25	12,5	T22		35		2	0,1	1	P 32... - D 25
	F2139.T28.030.Z02.15	30	15	T28		40		2	0,2	1	P 32... - D 30
	F2139.T28.032.Z02.16	32	16	T28		40		2	0,2	1	P 32... - D 32
	Shank DIN 228-A 	F2139.5.01.040.10	10	5	MK 1		40	93,5	2	0,1	1
F2139.5.01.040.12		12	6	MK 1		40	93,5	2	0,2	1	P 32... - D 12
F2139.5.02.060.16		16	8	MK 2		60	124	2	0,3	1	P 32... - D 16
F2139.5.02.061.20		20	10	MK 2		61	125	2	0,6	1	P 32... - D 20
F2139.5.03.064.25		25	12,5	MK 3		64	145	2	1,1	1	P 32... - D 25
F2139.5.04.062.30		30	15	MK 4		62,5	165	2	1,9	1	P 32... - D 30
F2139.5.04.062.32		32	16	MK 4		62,5	165	2	1,9	1	P 32... - D 32
Shank DIN 1835-B 	F2139.5.12.140.08	8	4	12	11	94	140	2	0,1	1	P 32... - D 08
	F2139.5.12.150.10	10	5	12	15	104	150	2	0,1	1	P 32... - D 10
	F2139.5.16.160.12	12	6	16	20	111	160	2	0,1	1	P 32... - D 12
	F2139.5.20.175.16	16	8	20	26	124	175	2	0,2	1	P 32... - D 16
	F2139.5.25.190.20	20	10	25	18	133	190	2	0,3	1	P 32... - D 20
	F2139.5.32.210.25	25	12,5	32	31	149	210	2	0,3	1	P 32... - D 25
	F2139.5.40.240.30	30	15	40	25	169	240	2	0,9	1	P 32... - D 30
	F2139.5.40.240.32	32	16	40	44	169	240	2	0,9	1	P 32... - D 32
Cylindrical shank 	F2139.5.10.110.08	8	4	10		25	110	2	0,1	1	P 32... - D 08
	F2139.5.12.130.10	10	5	12		30	130	2	0,1	1	P 32... - D 10
	F2139.5.12.130.12	12	6	12		32	130	2	0,1	1	P 32... - D 12
	F2139.5.16.140.16	16	8	16		36	140	2	0,1	1	P 32... - D 16
	F2139.5.20.160.20	20	10	20		45	160	2	0,1	1	P 32... - D 20
	F2139.5.25.160.25	25	12,5	25		45	160	2	0,3	1	P 32... - D 25
	F2139.5.32.175.30	30	15	32		56	175	2	0,7	1	P 32... - D 30
	F2139.5.32.175.32	32	16	32		56	175	2	0,7	1	P 32... - D 32
Cylindrical shank Solid carbide shank 	F2139.5.08.070.08-CS	8	4	8		25	70	2	0,1	1	P 32... - D 08
	F2139.5.08.100.08-CS	8	4	8		55	100	2	0,1	1	
	F2139.5.10.080.10-CS	10	5	10		30	80	2	0,1	1	P 32... - D 10
	F2139.5.10.120.10-CS	10	5	10		70	120	2	0,1	1	
	F2139.5.12.090.12-CS	12	6	12		32	90	2	0,2	1	P 32... - D 12
	F2139.5.12.145.12-CS	12	6	12		87	145	2	0,2	1	
	F2139.5.16.110.16-CS	16	8	16		43	110	2	0,3	1	P 32... - D 16
	F2139.5.16.195.16-CS	16	8	16		128	195	2	0,5	1	
	F2139.5.20.130.20-CS	20	10	20		47	130	2	0,5	1	P 32... - D 20
	F2139.5.20.240.20-CS	20	10	20		157	240	2	0,9	1	

Bodies and assembly parts are included in the scope of delivery.

For information on high-speed applications, see page F 310.

For open-ended spanners for screw heads, see page G 105.

F2139...-CS with solid carbide shank.

Assembly parts

D _c mm	8	10	12	16	20	25	30-32
 Clamping screw for indexable insert	FS397 (Torx 8)	FS390 (Torx 15)	FS391 (Torx 20)	FS392 (Torx 20)	FS393 (Torx 20)	FS394 (Torx 20)	FS395 (Torx 30)
Tightening torque	1,0 Nm	4,0 Nm	5,0 Nm	5,0 Nm	5,0 Nm	5,0 Nm	6,0 Nm

Accessories

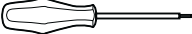
D _c mm	8	10	12-25	30-32
 Screwdriver	FS230 (Torx 8)	FS229 (Torx 15)	FS228 (Torx 20)	FS396 (Torx 30)

Indexable inserts

Designation	D _c ^{-0.03} mm	P						M				K				N		S				H	
		HC						HC				HC				HC	HW	HC				HC	HC
		WKP25	WKP35	WKP35S	WSP45	WSP46	WSM35	WSM36	WSP45	WSP46	WAK15	WKK25	WKP25	WKP35	WKP35S	WXN15	WK10	WSM35	WSM36	WSP45	WSP46	WHH15	WXM15
 P3201-D08	8	☺	☺						☺			☺							☺	☺	☺		
P3201-D10	10	☺	☺						☺			☺							☺	☺	☺		
P3201-D12	12	☺	☺						☺			☺							☺	☺	☺		
P3201-D16	16	☺	☺						☺			☺							☺	☺	☺		
P3201-D20	20	☺	☺						☺			☺							☺	☺	☺		
P3201-D25	25	☺	☺						☺			☺							☺	☺	☺		
P3201-D30	30	☺	☺						☺			☺							☺	☺	☺		
P3201-D32	32	☺	☺						☺			☺							☺	☺	☺		
P3204-D08	8	☺			☺			☺			☺								☺	☺	☺		
P3204-D10	10	☺			☺			☺			☺								☺	☺	☺		
P3204-D12	12	☺			☺			☺			☺								☺	☺	☺		
P3204-D16	16	☺			☺			☺			☺								☺	☺	☺		
P3204-D20	20	☺			☺			☺			☺								☺	☺	☺		
P3204-D25	25	☺			☺			☺			☺								☺	☺	☺		
P3204-D30	30	☺			☺			☺			☺								☺	☺	☺		
P3204-D32	32	☺			☺			☺			☺								☺	☺	☺		

HC = Coated carbide

HW = Uncoated carbide

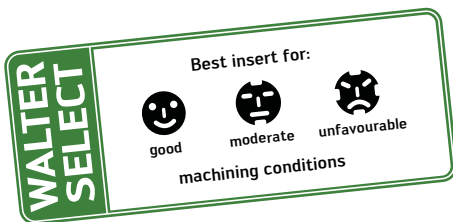

Contour mill F 2231 Form A

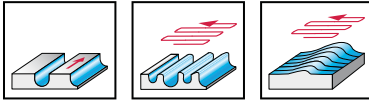

- With anti-twist protection and indexing
- Positive basic insert shape

Tool	Designation	R mm	$D_a^{-0.2}$ mm	d_1 mm	l_3 mm	l_4 mm	l_1 mm	L_c mm	Z	kg	No. of indexable inserts	Type
NCT ScrewFit $D_a - 0.05$ mm 	F2231.T09.010.Z02.02,5	2,5	10	T09		20		2,5	2	0,1	2	RD .. 0501 ..
	F2231.T14.016.Z02.04	4	16	T14		25		4	2	0,1	2	RD .. 0803 ..
	F2231.T18.020.Z02.05	5	20	T18		30		5	2	0,1	2	RD .. 10T3 ..
	F2231.T22.024.Z02.06	6	24	T22		35		6	2	0,1	2	RD .. 1204 ..
	F2231.T28.030.Z02.07	7,5	30	T28		40		7,5	2	0,2	2	RD .. 1505 ..
	F2231.T28.032.Z02.08	8	32	T28		40		8	2	0,2	2	RD .. 1605 ..
	F2231.T36.040.Z02.10	10	40	T36		45		10	2	0,3	2	RD .. 2006 ..
Shank DIN 228-A 	F2231.M.016.Z02.04	4	16	MK 2		40	104	4	2	0,1	2	RD .. 0803 ..
	F2231.M.020.Z02.05	5	20	MK 2		50	114	5	2	0,2	2	RD .. 10T3 ..
	F2231.M.024.Z02.06	6	24	MK 2		50	114	6	2	0,2	2	RD .. 1204 ..
	F2231.M.032.Z02.08	8	32	MK 3		65	146	8	2	0,4	2	RD .. 1605 ..
	F2231.M.040.Z02.10	10	40	MK 4		80	182,5	10	2	0,9	2	RD .. 2006 ..
Shank DIN 1835-B 	F2231.W.016.Z02.04.L	4	16	16	35	51	100	4	2	0,1	2	RD .. 0803 ..
	F2231.W.016.Z02.04.XL	4	16	16	31	81	130	4	2	0,2	2	
	F2231.W.020.Z02.05.L	5	20	20	39	59	110	5	2	0,2	2	RD .. 10T3 ..
	F2231.W.020.Z02.05.XL	5	20	20	40	99	150	5	2	0,3	2	
	F2231.W.024.Z02.06.L	6	24	25	48	73	130	6	2	0,4	2	RD .. 1204 ..
	F2231.W.024.Z02.06.XL	6	24	25	47	118	175	6	2	0,5	2	
	F2231.W.030.Z02.07.L	7,5	30	32	62	99	160	7,5	2	0,7	2	RD .. 1505 ..
	F2231.W.030.Z02.07.XL	7,5	30	32	62	159	220	7,5	2	1,1	2	
	F2231.W.032.Z02.08.L	8	32	32	63	99	160	8	2	0,8	2	RD .. 1605 ..
	F2231.W.032.Z02.08.XL	8	32	32	59	159	220	8	2	1,1	2	
	F2231.W.040.Z02.10.L	10	40	40	79	119	190	10	2	1,5	2	RD .. 2006 ..
F2231.W.040.Z02.10.XL	10	40	40	83	199	270	10	2	2,2	2		

Bodies and assembly parts are included in the scope of delivery.
For open-ended spanners for screw heads, see page G 105.

Assembly parts

D _a mm	10	16	20	24	30-32	40	
	Clamp				FS1035	FS1022	FS1022
	Clamping screw for clamp				FS359 (Torx 15)	FS1030 (Torx 20)	FS1031 (Torx 20)
	Tightening torque				2,5 Nm	5,0 Nm	5,0 Nm
	Clamping screw for indexable insert	FS1358 (Torx 6)	FS1005 (Torx 8)	FS920 (Torx 15)	FS359 (Torx 15)	FS1030 (Torx 20)	FS1010 (Torx 20)
	Tightening torque	0,4 Nm	1,0 Nm	2,5 Nm	2,5 Nm	5,0 Nm	5,0 Nm

Accessories

D _a mm	10	16	20-24	30-40	
	Screwdriver	FS1063 (Torx 6)	FS230 (Torx 8)	FS229 (Torx 15)	FS228 (Torx 20)

Indexable inserts

Designation	Radius mm	P		M		K			N		S	H	N							
		HC		HC		HC			HC	HW	HC	HC	HF							
		WKP25	WKP35	WKP35S	WSP45	WSM35	WSP45	WAK15	WKK25	WKP25	WKP35	WKP35S	WXN15	WK10	WSM35	WSP45	WHH15	WMG40		
RDGT0803M0-G85	4,0																	☺		
RDGT0803M0-G88	4,0																		☺	
RDGT10T3M0-G85	5,0																		☺	
RDGT10T3M0-G88	5,0																		☺	
RDGT1204M0-G85	6,0																		☺	
RDGT1204M0-G88	6,0																		☺	
RDGT1505M0-G85	7,5																		☺	
RDGT1505M0-G88	7,5																		☺	
RDGT1605M0-G85	8,0																		☺	
RDGT1605M0-G88	8,0																		☺	
RDGT2006M0-G85	10,0																		☺	
RDGT2006M0-G88	10,0																		☺	
RDGX0501M0-G85	2,5																		☺	
RDHW0803M0-A57	4,0	☺						☺											☺	
RDHW0803M0T-A27	4,0	☺	☺	☺				☺	☺	☺									☺	
RDHW10T3M0-A57	5,0	☺	☺	☺				☺	☺	☺									☺	
RDHW10T3M0T-A27	5,0	☺	☺	☺				☺	☺	☺									☺	
RDHW1204M0-A57	6,0	☺	☺	☺				☺	☺	☺									☺	
RDHW1204M0T-A27	6,0	☺	☺	☺				☺	☺	☺									☺	
RDHW1505M0-A57	7,5	☺	☺	☺				☺	☺	☺									☺	
RDHW1505M0T-A27	7,5	☺	☺	☺				☺	☺	☺									☺	
RDHW1605M0-A57	8,0	☺	☺	☺				☺	☺	☺									☺	
RDHW1605M0T-A27	8,0	☺	☺	☺				☺	☺	☺									☺	
RDHW2006M0-A57	10,0	☺	☺	☺				☺	☺	☺									☺	
RDHW2006M0T-A27	10,0	☺	☺	☺				☺	☺	☺									☺	
RDHX0501M0-A57	2,5	☺						☺	☺	☺									☺	
RDMT0803M0-D57	4,0	☺	☺	☺	☺	☺			☺	☺	☺			☺	☺				☺	
RDMT10T3M0-D57	5,0	☺	☺	☺	☺	☺			☺	☺	☺			☺	☺				☺	
RDMT1204M0-D57	6,0	☺	☺	☺	☺	☺			☺	☺	☺			☺	☺				☺	
RDMT1505M0-D57	7,5	☺	☺	☺	☺	☺			☺	☺	☺			☺	☺				☺	
RDMT1605M0-D57	8,0	☺	☺	☺	☺	☺			☺	☺	☺			☺	☺				☺	
RDMT2006M0-D57	10,0	☺	☺	☺	☺	☺			☺	☺	☺			☺	☺				☺	
RDMW0803M0T-A27	4,0	☺	☺	☺					☺	☺										☺
RDMW10T3M0T-A27	5,0	☺	☺	☺					☺	☺										☺
RDMW1204M0T-A27	6,0	☺	☺	☺					☺	☺										☺
RDMW1605M0T-A27	8,0	☺	☺	☺					☺	☺										☺
RDMW2006M0T-A27	10,0	☺	☺	☺					☺	☺										☺

HC = Coated carbide
 HW = Uncoated carbide
 HF = Uncoated fine-grained carbide

WALTER SELECT

Best insert for:

☺
good

☹
moderate

☹
unfavourable

machining conditions

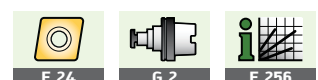

Round insert cutter F 2234

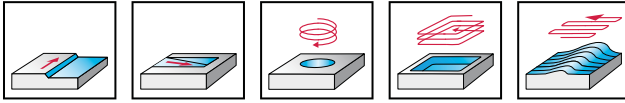

- With anti-twist protection and indexing
- Positive basic insert shape

Tool	Designation	R mm	D _a ^{-0,2} mm	d ₁ mm	l ₄ mm	l ₁ mm	L _c mm	Z	kg	No. of indexable inserts	Type
NCT ScrewFit 	F2234.T09.012.Z03.02,5	2,5	12	T09	20		2,5	3	0,1	3	RD .. 0501 ..
	F2234.T14.015.Z04.02,5	2,5	15	T14	25		2,5	4	0,4	4	RD .. 0501 ..
	F2234.T14.015.Z03.03,5	3,5	15	T14	25		3,5	3	0,1	3	RD .. 07T1 ..
	F2234.T18.020.Z05.02,5	2,5	20	T18	30		2,5	5	0,1	5	RD .. 0501 ..
	F2234.T18.020.Z04.03,5	3,5	20	T18	30		3,5	4	0,1	4	RD .. 07T1 ..
	F2234.T22.025.Z05.03,5	3,5	25	T22	35		3,5	5	0,1	5	RD .. 07T1 ..
	F2234.T22.025.Z03.04	4	25	T22	35		4	3	0,1	3	RD .. 0803 ..
	F2234.T22.025.Z03.05	5	25	T22	35		5	3	0,1	3	RD .. X 1003 ..
	F2234.T28.030.Z06.03,5	3,5	30	T28	40		3,5	6	0,2	6	RD .. X 07T1 ..
	F2234.T28.030.Z04.05	5	30	T28	40		5	4	0,2	4	RD .. X 1003 ..
	F2234.T28.030.Z03.05	5	30	T28	40		5	3	0,2	3	RD .. 10T3 ..
	F2234.T28.032.Z03.05	5	32	T28	40		5	3	0,2	3	RD .. 10T3 ..
	F2234.T28.032.Z04.05	5	32	T28	40		5	4	0,2	4	RD .. X 1003 ..
	F2234.T28.035.Z07.03,5	3,5	35	T28	40		3,5	7	0,2	7	RD .. 07T1 ..
	F2234.T28.035.Z05.05	5	35	T28	40		5	5	0,2	5	RD .. X 1003 ..
	F2234.T28.035.Z03.06	6	35	T28	40		6	3	0,2	3	RD .. X 12T3 ..
	F2234.T28.035.Z04.06	6	35	T28	40		6	4	0,2	4	RD .. X 12T3 ..
	F2234.T36.042.Z08.03,5	3,5	42	T36	40		3,5	8	0,4	8	RD .. 07T1 ..
	F2234.T36.042.Z06.05	5	42	T36	40		5	6	0,4	6	RD .. X 1003 ..
	F2234.T36.042.Z04.06	6	42	T36	40		6	4	0,4	4	RD .. X 12T3 ..
F2234.T36.042.Z05.06	6	42	T36	40		6	5	0,3	5	RD .. X 12T3 ..	
Shank DIN 228-A 	F2234.M.025.Z03.04	4	25	MK 2	55	119	4	3	0,2	3	RD .. 0803 ..
	F2234.M.032.Z03.05	5	32	MK 3	55	136	5	3	0,4	3	RD .. 10T3 ..
	F2234.M.040.Z04.06	6	40	MK 4	65	167,5	6	4	0,8	4	RD .. 1204 ..
	F2234.M.050.Z04.06	6	50	MK 4	70	172,5	6	4	1,0	4	RD .. 1204 ..
	F2234.M.050.Z03.08.L	8	50	MK 4	55	157,5	8	3	0,8	3	RD .. 1605 ..
F2234.M.050.Z03.08.XL	8	50	MK 4	100	202,5	8	3	1,1	3	RD .. 1605 ..	
Shank DIN 1835-B 	F2234.W.025.Z03.04	4	25	25	93	150	4	3	0,4	3	RD .. 0803 ..
	F2234.W.032.Z03.05	5	32	32	114	175	5	3	0,9	3	RD .. 10T3 ..
	F2234.W.040.Z04.06	6	40	40	149	220	6	4	1,7	4	RD .. 1204 ..
	F2234.W.050.Z04.06	6	50	40	109	180	6	4	1,7	4	RD .. 1204 ..
F2234.W.050.Z03.08	8	50	40	109	180	8	3	1,6	3	RD .. 1605 ..	

Bodies and assembly parts are included in the scope of delivery.
For open-ended spanners for screw heads, see page G 105.

Assembly parts

	Insert types	RD..0501..	RD..07T1..	RD..0803..	RD..10..	RD..12T3..	RD..1204..	RD..1605..
	Clamping screw for indexable insert	FS1358 (Torx 6)	FS924 (Torx 8)	FS1005 (Torx 8)	FS920 (Torx 15)	FS920 (Torx 15)	FS359 (Torx 15)	FS1030 (Torx 20)
	Tightening torque	0,4 Nm	0,8 Nm	1,0 Nm	2,5 Nm	2,5 Nm	2,5 Nm	5,0 Nm
	Clamp						FS1035	FS1022
	Clamping screw for clamp						FS359 (Torx 15)	FS1030 (Torx 20)
	Tightening torque						2,5 Nm	5,0 Nm

Accessories

	Insert types	RD .. 0501 ..	RD .. 07T1 ..	RD .. 0803 ..	RD .. 10 ..	RD .. 12T3 ..	RD .. 1204 ..	RD .. 1605 ..
	Screwdriver	FS1063 (Torx 6)	FS230 (Torx 8)	FS230 (Torx 8)	FS229 (Torx 15)	FS229 (Torx 15)	FS229 (Torx 15)	FS228 (Torx 20)

Indexable inserts

Designation	Radius mm	P				M		K				N		S		H		
		HC	HC	HC	HC	HC	HC	HC	HC	HC	HW	HC	HC	HC	HF			
		WKP25	WKP35	WKP35S	WSP45	WSM35	WSP45	WAK15	WKK25	WKP25	WKP35	WKP35S	WXN15	WK10	WSM35	WSP45	WHH15	WMG40
RDGT0803M0-G85	4,0																	☺
RDGT0803M0-G88	4,0												☺	☺				
RDGT10T3M0-G85	5,0												☺	☺				☺
RDGT10T3M0-G88	5,0												☺	☺				
RDGT1204M0-G85	6,0												☺	☺				☺
RDGT1204M0-G88	6,0												☺	☺				
RDGT1605M0-G85	8,0												☺	☺				☺
RDGT1605M0-G88	8,0												☺	☺				
RDGX0501M0-G85	2,5																	☺
RDGX07T1M0-G85	3,5																	☺
RDGX1003M0-G85	5,0																	☺
RDGX12T3M0-G85	6,0																	☺
RDHW0803M0-A57	4,0	☺						☺										☺
RDHW0803M0T-A27	4,0	☺	☺	☺				☺		☺	☺							☺
RDHW10T3M0-A57	5,0	☺	☺	☺				☺		☺	☺							☺
RDHW10T3M0T-A27	5,0	☺	☺	☺				☺		☺	☺							☺
RDHW1204M0-A57	6,0	☺	☺	☺				☺		☺	☺							☺
RDHW1204M0T-A27	6,0	☺	☺	☺				☺		☺	☺							☺
RDHW1605M0-A57	8,0	☺	☺	☺				☺		☺	☺							☺
RDHW1605M0T-A27	8,0	☺	☺	☺				☺		☺	☺							☺
RDHX0501M0-A57	2,5	☺						☺										☺
RDHX07T1M0-A57	3,5	☺						☺										☺
RDHX07T1M0T-A27	3,5	☺	☺	☺				☺		☺	☺							☺
RDHX1003M0-A57	5,0	☺	☺	☺				☺		☺	☺							☺
RDHX1003M0T-A27	5,0	☺	☺	☺				☺		☺	☺							☺
RDHX12T3M0-A57	6,0	☺	☺	☺				☺		☺	☺							☺
RDHX12T3M0T-A27	6,0	☺	☺	☺				☺		☺	☺							☺
RDMT0803M0-D57	4,0	☺	☺	☺	☺	☺				☺	☺				☺	☺		
RDMT10T3M0-D57	5,0	☺	☺	☺	☺	☺				☺	☺				☺	☺		
RDMT1204M0-D57	6,0	☺	☺	☺	☺	☺				☺	☺				☺	☺		
RDMT1605M0-D57	8,0	☺	☺	☺	☺	☺				☺	☺				☺	☺		
RDMW0803M0T-A27	4,0	☺	☺	☺						☺	☺							
RDMW10T3M0T-A27	5,0	☺	☺	☺						☺	☺							
RDMW1204M0T-A27	6,0	☺	☺	☺						☺	☺							
RDMW1605M0T-A27	8,0	☺	☺	☺						☺	☺							
RDMX1003M0T-A27	5,0	☺	☺	☺						☺	☺							
RDMX12T3M0T-A27	6,0	☺	☺	☺						☺	☺							

HC = Coated carbide
 HW = Uncoated carbide
 HF = Uncoated fine-grained carbide

WALTER SELECT

Best insert for:

☺
good

☹
moderate

☹
unfavourable

machining conditions

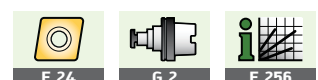

Round insert cutter F 2234

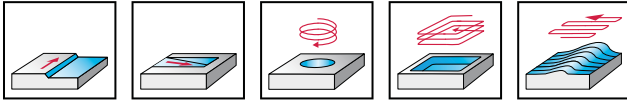
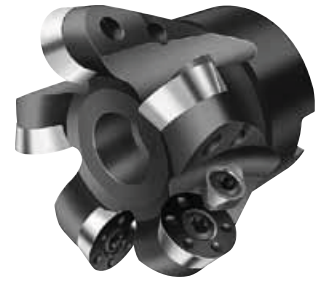

- With anti-twist protection and indexing
- Positive basic insert shape

Tool	Designation	R mm	D _a ^{-0.2} mm	d ₁ mm	d ₆ mm	l ₄ mm	L _c mm	Z	kg	No. of indexable inserts	Type	
Cyl. bore DIN 138 longitudinal key way 	F2234.B.040.Z04.06	6	40	16	31	45	6	4	0,3	4	RD.. 1204 ..	
	F2234.B.050.Z05.06	6	50	22	41	50	6	5	0,4	5	RD.. 1204 ..	
	F2234.B.050.Z04.08	8	50	16	33	50	8	4	0,3	4	RD.. 1605 ..	
	F2234.B.052.Z06.05	5	52	22	42	50	5	6	0,5	6	RD.. 10T3 ..	
	F2234.B.052.Z05.06	6	52	22	42	50	6	5	0,5	5	RD.. 1204 ..	
	F2234.B.052.Z04.08	8	52	22	42	50	8	4	0,5	4	RD.. 1605 ..	
	F2234.B.063.Z06.06	6	63	22	45	50	6	6	0,6	6	RD.. 1204 ..	
	F2234.B.063.Z05.08	8	63	22	45	50	8	5	0,6	5	RD.. 1605 ..	
	F2234.B.063.Z04.10	10	63	22	45	50	10	4	0,6	4	RD.. 2006 ..	
	F2234.B.066.Z05.08	8	66	27	50	50	8	5	0,7	5	RD.. 1605 ..	
	F2234.B.080.Z07.06	6	80	27	54	50	6	7	1,3	7	RD.. 1204 ..	
	F2234.B.080.Z06.08	8	80	27	54	50	8	6	1,3	6	RD.. 1605 ..	
	F2234.B.080.Z05.10	10	80	27	54	50	10	5	1,3	5	RD.. 2006 ..	
	F2234.B.100.Z08.06	6	100	32	80	50	6	8	2,0	8	RD.. 1204 ..	
	F2234.B.100.Z07.08	8	100	32	80	50	8	7	2,0	7	RD.. 1605 ..	
	F2234.B.100.Z06.10	10	100	32	80	50	10	6	2,0	6	RD.. 2006 ..	
	F2234.B.125.Z08.08	8	125	40	85	63	8	8	3,8	8	RD.. 1605 ..	
	F2234.B.125.Z07.10	10	125	40	85	63	10	7	3,8	7	RD.. 2006 ..	
	Cyl. bore DIN 138 longitudinal key way 	F2234.B.160.Z08.10	10	160	40/40 B	130	63	10	8	6,2	8	RD.. 2006 ..

Bodies and assembly parts are included in the scope of delivery.

Assembly parts

	Insert types	RD..10T3..	RD..1204..	RD..1605..	RD..2006..
	Clamp		FS1035	FS1022	FS1022
	Clamping screw for clamp		FS359 (Torx 15)	FS1030 (Torx 20)	FS1030 (Torx 20)
	Tightening torque		2,5 Nm	5,0 Nm	5,0 Nm
	Clamping screw for indexable insert	FS920 (Torx 15)	FS359 (Torx 15)	FS1030 (Torx 20)	FS1010 (Torx 20)
	Tightening torque	2,5 Nm	2,5 Nm	5,0 Nm	5,0 Nm

Accessories

	Insert types	RD..10T3..-RD..1204..	RD..1605..-RD..2006..
	Screwdriver	FS229 (Torx 15)	FS228 (Torx 20)

Indexable inserts

Designation	Radius mm	P				M			K				N		S		H	HF
		HC				HC			HC				HC	HW	HC		HC	HF
		WKP25	WKP35	WKP35S	WSP45	WSM35	WSP45	WAK15	WKK25	WKP25	WKP35	WKP35S	WXN15	WK10	WSM35	WSP45	WHH15	WMG40
RDGT10T3M0-G85	5,0																	☺
RDGT10T3M0-G88	5,0											☺	☺					
RDGT1204M0-G85	6,0																	☺
RDGT1204M0-G88	6,0											☺	☺					
RDGT1605M0-G85	8,0																	☺
RDGT1605M0-G88	8,0											☺	☺					
RDGT2006M0-G85	10,0																	☺
RDGT2006M0-G88	10,0											☺	☺					
RDHW10T3M0-A57	5,0	☺					☺		☺									☺
RDHW10T3M0T-A27	5,0	☺	☺	☺					☺	☺	☺							
RDHW1204M0-A57	6,0	☺					☺		☺									☺
RDHW1204M0T-A27	6,0	☺	☺	☺					☺	☺	☺							
RDHW1605M0-A57	8,0	☺					☺		☺									☺
RDHW1605M0T-A27	8,0	☺	☺	☺					☺	☺	☺							
RDHW2006M0-A57	10,0	☺					☺		☺									☺
RDHW2006M0T-A27	10,0	☺	☺	☺					☺	☺	☺							
RDMT10T3M0-D57	5,0	☺	☺	☺	☺	☺			☺	☺	☺			☺	☺			
RDMT1204M0-D57	6,0	☺	☺	☺	☺	☺			☺	☺	☺			☺	☺			
RDMT1605M0-D57	8,0	☺	☺	☺	☺	☺			☺	☺	☺			☺	☺			
RDMT2006M0-D57	10,0	☺	☺	☺	☺	☺			☺	☺	☺			☺	☺			
RDMW10T3M0T-A27	5,0	☺	☺	☺					☺	☺	☺							
RDMW1204M0T-A27	6,0	☺	☺	☺					☺	☺	☺							
RDMW1605M0T-A27	8,0	☺	☺	☺					☺	☺	☺							
RDMW2006M0T-A27	10,0	☺	☺	☺					☺	☺	☺							

HC = Coated carbide
 HW = Uncoated carbide
 HF = Uncoated fine-grained carbide

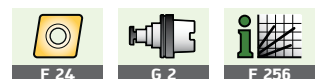
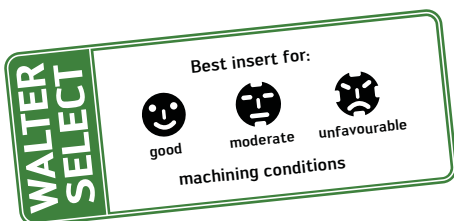

Round insert cutter F 2334

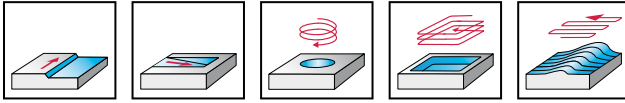

- With indexing surfaces
- Four cutting edges per indexable insert
- Positive basic insert shape

Tool	Designation	R mm	D _a ^{-0.05} mm	d ₁ mm	l ₄ mm	l ₁ mm	L _c mm	Z	kg	No. of indexable inserts	Type
NCT ScrewFit 	F2334.T22.025.Z03.04	4	25	T22	35	58	4	3	0,1	3	RO . X 0803 ..
	F2334.T22.025.Z03.05	5	25	T22	35	58	5	3	0,1	3	RO . X 10T3 ..
	F2334.T28.032.Z03.05	5	32	T28	40	69	5	3	0,2	3	
	F2334.T28.032.Z04.05	5	32	T28	40	69	5	4	0,2	4	RO . X 0803 ..
	F2334.T28.032.Z05.04	4	32	T28	40	69	4	5	0,2	5	
	F2334.T36.040.Z04.06	6	40	T36	40	75	6	4	0,4	4	
	F2334.T45.050.Z05.06	6	50	T45	40	75	6	5	0,6	5	RO . X 1204 ..
Shank DIN 1835-B 	F2334.W25.025.Z03.04	4	25	25	35	92	4	3	0,3	3	RO . X 0803 ..
	F2334.W32.032.Z03.05	5	32	32	40	101	5	3	0,5	3	RO . X 10T3 ..
	F2334.W40.040.Z04.06	6	40	40	40	111	6	4	0,7	4	RO . X 1204 ..
Cylindrical shank 	F2334.Z25.025.Z03.04	4	25	25	60	117	4	3	0,36	3	RO . X 0803 ..
	F2334.Z32.032.Z04.05	5	32	32	70	131	5	4	0,6	4	RO . X 10T3 ..
	F2334.Z32.032.Z05.04	4	32	32	70	131	4	5	0,7	5	RO . X 0803 ..

Bodies and assembly parts are included in the scope of delivery.
 For open-ended spanners for screw heads, see page G 105.

Assembly parts

Insert types	RO . X 0803 . .	RO . X 10T3 . .	RO . X 1204 . .
Clamping screw for indexable insert	FS1013 (Torx 8)	FS359 (Torx 15)	FS378 (Torx 15)
Tightening torque	1,0 Nm	2,5 Nm	3,0 Nm

Accessories

Insert types	RO . X 0803 . .	RO . X 10T3 . .-RO . X 1204 . .
Screwdriver	FS230 (Torx 8)	FS229 (Torx 15)

Indexable inserts

Designation	Radius mm	P				M		K				N		S		H	
		HC				HC		HC				HC	HW	HC		HC	
		WKP25	WKP35	WKP35S	WSP45	WSM35	WSP45	WAK15	WKK25	WKP25	WKP35	WKP35S	WXN15	WK10	WSM35	WSP45	WHH15
ROGX0803M0-G77	4,0				☺	☺									☺	☺	
ROGX10T3M0-G77	5,0				☺	☺									☺	☺	
ROGX1204M0-G77	6,0				☺	☺									☺	☺	
ROHX0803M0-D57	4,0	☺	☺	☺	☺	☺			☺	☺	☺				☺	☺	
ROHX0803M0-D67	4,0		☺	☺	☺	☺				☺	☺				☺	☺	
ROHX0803M0T-A27	4,0	☺	☺	☺					☺	☺	☺						
ROHX10T3M0-D57	5,0	☺	☺	☺	☺	☺			☺	☺	☺				☺	☺	
ROHX10T3M0-D67	5,0		☺	☺	☺	☺				☺	☺				☺	☺	
ROHX10T3M0T-A27	5,0	☺	☺	☺					☺	☺	☺						
ROHX1204M0-D57	6,0	☺	☺	☺	☺	☺			☺	☺	☺				☺	☺	
ROHX1204M0-D67	6,0		☺	☺	☺	☺				☺	☺				☺	☺	
ROHX1204M0T-A27	6,0	☺	☺	☺					☺	☺	☺						
ROMX0803M0-D57	4,0		☺	☺	☺	☺				☺	☺				☺	☺	
ROMX10T3M0-D57	5,0		☺	☺	☺	☺				☺	☺				☺	☺	
ROMX1204M0-D57	6,0		☺	☺	☺	☺				☺	☺				☺	☺	

HC = Coated carbide
HW = Uncoated carbide

WALTER SELECT

Best insert for:

☺
good

☹
moderate

☹
unfavourable

machining conditions

Round insert cutter F 2334

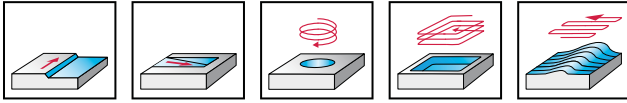

- With indexing surface
- Four / six / eight cutting edges per indexable insert
- Positive basic insert shape

Tool		Designation	R mm	D _a ^{-0.05} mm	d ₁ mm	d ₆ mm	l ₄ mm	L _c mm	Z	kg	No. of indexable inserts	Type
Cyl. bore DIN 138 longitudinal key way		F2334.B.040.Z05.05	5	40	16	35	40	5	5	0,2	5	RO . X 10T3 . .
		F2334.B.040.Z04.06	6	40	16	35	40	6	4	0,2	4	RO . X 1204 . .
		F2334.B22.050.Z06.05	5	50	22	41	40	5	6	0,3	6	RO . X 10T3 . .
		F2334.B.050.Z05.06	6	50	22	45	40	6	5	0,3	5	RO . X 1204 . .
		F2334.B22.052.Z06.05	5	52	22	41	40	5	6	0,3	6	RO . X 10T3 . .
		F2334.B22.052.Z05.05	5	52	22	41	40	5	5	0,3	5	RO . X 10T3 . .
		F2334.B22.052.Z05.06	6	52	22	41	40	6	5	0,3	5	RO . X 1204 . .
		F2334.B22.052.Z04.08	8	52	22	41	40	8	4	0,3	4	RO . X 1605 . .
		F2334.B27.063.Z07.05	5	63	27	54	50	5	7	0,7	7	RO . X 10T3 . .
		F2334.B.063.Z07.06	6	63	22	58	40	6	7	0,6	7	RO . X 1204 . .
		F2334.B27.063.Z05.08	8	63	27	54	50	8	5	0,6	5	RO . X 1605 . .
		F2334.B27.063.Z05.10	10	63	27	54	50	10	5	0,6	5	RO . X 2006 . .
		F2334.B27.066.Z06.05	5	66	27	54	50	5	6	0,7	6	RO . X 10T3 . .
		F2334.B27.066.Z07.05	5	66	27	54	50	5	7	0,6	7	RO . X 10T3 . .
		F2334.B27.066.Z06.06	6	66	27	54	50	6	6	0,7	6	RO . X 1204 . .
		F2334.B27.066.Z07.06	6	66	27	54	50	6	7	0,7	7	RO . X 1204 . .
		F2334.B27.066.Z04.08	8	66	27	54	50	8	4	0,6	4	RO . X 1605 . .
		F2334.B27.066.Z05.08	8	66	27	54	50	8	5	0,6	5	RO . X 1605 . .
		F2334.B27.066.Z05.10	10	66	27	54	50	10	5	0,6	5	RO . X 2006 . .
		F2334.B27.066.Z04.10	10	66	27	54	50	10	4	0,6	4	RO . X 2006 . .
		F2334.B27.080.Z07.06	6	80	27	60	50	6	7	1,0	7	RO . X 1204 . .
		F2334.B27.080.Z09.06	6	80	27	60	50	6	9	1,0	9	RO . X 1204 . .
		F2334.B27.080.Z06.08	8	80	27	60	50	8	6	0,9	6	RO . X 1605 . .
		F2334.B27.080.Z05.08	8	80	27	60	50	8	5	0,9	5	RO . X 1605 . .
		F2334.B27.080.Z06.10	10	80	27	60	50	10	6	0,9	6	RO . X 2006 . .
		F2334.B27.080.Z05.10	10	80	27	60	50	10	5	0,9	5	RO . X 2006 . .
		F2334.B27.096.Z06.08	8	96	27	60	50	8	6	1,4	6	RO . X 1605 . .
		F2334.B32.100.Z06.08	8	100	32	78	50	8	6	1,6	6	RO . X 1605 . .
		F2334.B32.100.Z07.10	10	100	32	78	50	10	7	1,4	7	RO . X 2006 . .
		F2334.B32.116.Z07.08	8	116	32	78	50	8	7	2,1	7	RO . X 1605 . .
		F2334.B40.125.Z07.08	8	125	40	95	63	8	7	3,4	7	RO . X 1605 . .
		F2334.B40.125.Z08.10	10	125	40	95	63	10	8	3,4	8	RO . X 2006 . .
F2334.B40.141.Z08.08	8	141	40	95	63	8	8	4,3	8	RO . X 1605 . .		
Cyl. bore DIN 138 longitudinal key way		F2334.B40.160.Z10.10	10	160	40/40 B	100	63	10	10	4,3	10	RO . X 2006 . .

Bodies and assembly parts are included in the scope of delivery.

Assembly parts

Insert types	RO . X 10T3 . .	RO . X 1204 . .	RO . X 1605 . .	RO . X 2006 . .
Clamping screw for indexable insert	FS359 (Torx 15)	FS378 (Torx 15)	FS1030 (Torx 20)	FS1036 (Torx 20)
Tightening torque	2,5 Nm	3,0 Nm	5,0 Nm	5,0 Nm

Accessories

Insert types	RO . X 10T3 . .-RO . X 1204 . .	RO . X 1605 . .	RO . X 2006 . .
Handle key		FS1173 (Torx 20)	FS1173 (Torx 20)
Screwdriver	FS229 (Torx 15)	FS228 (Torx 20)	FS228 (Torx 20)
Gasket			O-R 96X4 (for D _a = 160 mm only)
Sealing disc set, complete (incl. gasket and screws)			FS936 SET COMPLETE (for D _a = 160 mm only)

Indexable inserts

Designation	Radius mm	P		M			K			N		S		H		
		HC		HC			HC			HC	HW	HC	HC	HC		
		WKP25	WKP35	WKP35S	WSP45	WSM35	WSP45	WAK15	WKK25	WKP25	WKP35	WKP35S	WXN15	WK10	WSM35	WSP45
ROGX10T3M0-G77	5,0															
ROGX1204M0-G77	6,0															
ROGX1605M0-G77	8,0															
ROHX10T3M0-D57	5,0															
ROHX10T3M0-D67	5,0															
ROHX10T3M0T-A27	5,0															
ROHX1204M0-D57	6,0															
ROHX1204M0-D67	6,0															
ROHX1204M0T-A27	6,0															
ROHX1605M0-D57	8,0															
ROHX1605M0-D67	8,0															
ROHX1605M0T-A27	8,0															
ROHX2006M0-D57	10,0															
ROHX2006M0T-A27	10,0															
ROMX10T3M0-D57	5,0															
ROMX1204M0-D57	6,0															
ROMX1605M0-D57	8,0															
ROMX2006M0-D57	10,0															

HC = Coated carbide
HW = Uncoated carbide

WALTER SELECT

Best insert for:

good

moderate

unfavourable

machining conditions

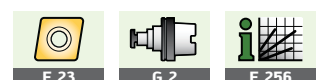

Ball nose mill F 2239 / F 2239B

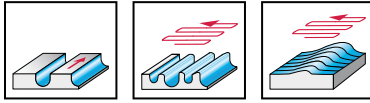

- Three / four cutting edges per indexable insert
- Positive basic insert shape
- With peripheral cutting edges

Tool	Designation	$D_c^{0.2}$ mm	R mm	d_1 mm	l_4 mm	l_1 mm	L_c mm	Z	kg	No. of indexable inserts	Type
NCT ScrewFit 	F2239.T18.020.Z01.15	20	10	T18	30		15	1	0,1	1 2	SP...0603... P 2631... - R 10
	F2239.T22.025.Z01.18	25	12,5	T22	35		18	1	0,1	1 2	SP...0603... P 2631... - R 12
	F2239.T28.030.Z01.23	30	15	T28	40		23	1	0,2	1 2	SP...09T3... P 2631... - R 15
	F2239.T28.032.Z01.24	32	16	T28	40		24	1	0,2	1 2	SP...09T3... P 2631... - R 16
	F2239.T36.040.Z01.41	40	20	T36	65		41	1	0,4	2 2	SP...1204... P 2631... - R 20
	F2239.T45.050.Z01.46	50	25	T45	70		46	1	0,8	2 3	SP...1204... P 2631... - R 25
Shank DIN 228-A 	F2239.M.020.Z01.25	20	10	MK 2	65	129	25	1	0,3	3 2	SP...0603... P 2631... - R 10
	F2239.M.025.Z01.28	25	12,5	MK 2	45	109	28	1	0,4	3 2	SP...0603... P 2631... - R 12
	F2239.M.032.Z01.38	32	16	MK 3	60	141	38	1	0,8	3 2	SP...09T3... P 2631... - R 16
	F2239.M.040.Z01.51	40	20	MK 4	75	177,5	51	1	1,3	3 2	SP...1204... P 2631... - R 20
Shank DIN 1835-B 	F2239.W.020.Z01.25	20	10	20	59	110	25	1	0,3	3 2	SP...0603... P 2631... - R 10
	F2239.W.025.Z01.28	25	12,5	25	73	130	28	1	0,4	3 2	SP...0603... P 2631... - R 12
	F2239.W.032.Z01.38	32	16	32	99	160	38	1	0,8	3 2	SP...09T3... P 2631... - R 16
	F2239.W.040.Z01.51	40	20	40	119	190	51	1	1,4	3 2	SP...1204... P 2631... - R 20
Modular adaptor NCT 	F2239.N5.050.Z01.46	50	25	NCT 50	70		46	1	0,8	2 3	SP...1204... P 2631... - R 25
	F2239.N5.050.Z01.77	50	25	NCT 50	105		77	1	1,3	5 3	
	F2239.N6.063.Z01.53	63	31,5	NCT 63	80		53	1	1,2	2 3	SP...1204... P 2631... - R 31
	F2239.N6.063.Z01.84	63	31,5	NCT 63	115		84	1	2,0	5 3	
NCT ScrewFit 	F2239B.T14.020.Z01.10	20	10	T14	25		15	1	0,1	3	P 2631... - R 10
	F2239B.T18.025.Z01.12	25	12,5	T18	30		20	1	0,2	3	P 2631... - R 12
	F2239B.T22.030.Z01.15	30	15	T22	40		24	1	0,2	3	P 2631... - R 15
	F2239B.T22.032.Z01.16	32	16	T22	40		26	1	0,2	3	P 2631... - R 16
	F2239B.T28.040.Z01.20	40	20	T28	45		32	1	0,4	3	P 2631... - R 20
Shank DIN 228-A 	F2239B.M4.040.Z01.20	40	20	MK 4	100	202,5	32	1	0,9	3	P 2631... - R 20
	F2239B.M4.050.Z01.25	50	25	MK 4	80	182,5	39	1	0,9	4	P 2631... - R 25

Bodies and assembly parts are included in the scope of delivery.
For open-ended spanners for screw heads, see page G 105.

Assembly parts

D _c mm	20	25	30-32	40-63
	FS1129 (Torx 8)	FS923 (Torx 8)	FS359 (Torx 15)	FS1030 (Torx 20)
Tightening torque	0,8 Nm	0,8 Nm	2,5 Nm	5,0 Nm

Accessories

D _c mm	20-25	30-32	40-63
	FS230 (Torx 8)	FS229 (Torx 15)	FS228 (Torx 20)

Indexable inserts

Designation	Radius mm	P		M		K			N		S		H				
		HC	HC	HC	HC	HC	HC	HW	HC	HC	HC						
		WKP25	WKP35	WKP35S	WSP45	WSM35	WSP45	WAK15	WKK25	WKP25	WKP35	WKP35S	WXN15	WK10	WSM35	WSP45	WHH15
P26315R10	0,5	☺	☺	☺	☺	☺	☺			☺	☺	☺			☺	☺	
P26315R12	0,6	☺	☺	☺	☺	☺	☺			☺	☺	☺			☺	☺	
P26315R15	0,6	☺	☺	☺	☺	☺	☺			☺	☺	☺			☺	☺	
P26315R16	0,6	☺	☺	☺	☺	☺	☺			☺	☺	☺			☺	☺	
P26315R20	0,4	☺	☺	☺	☺	☺	☺			☺	☺	☺			☺	☺	
P26315R25	1,2	☺	☺	☺	☺	☺	☺			☺	☺	☺			☺	☺	
P26315R31	0,6	☺	☺	☺	☺	☺	☺			☺	☺	☺			☺	☺	
P26316R10-G88	0,5												☺				
P26316R12-G88	0,6												☺				
P26316R15-G88	0,6												☺				
P26316R16-G88	0,6												☺				
P26316R20-G88	0,4												☺				
P26316R25-G88	1,2												☺				
P26316R31-G88	0,6												☺				
SPHT060304-G88	0,4												☺	☺			
SPHT09T308-G88	0,8												☺	☺			
SPHT120408-G88	0,8												☺	☺			
SPMT060304-D51	0,4	☺	☺	☺	☺	☺	☺			☺	☺	☺			☺	☺	
SPMT060304-F55	0,4	☺	☺	☺	☺	☺	☺	☺		☺	☺	☺			☺	☺	
SPMT09T308-D51	0,8	☺	☺	☺	☺	☺	☺			☺	☺	☺			☺	☺	
SPMT09T308-F55	0,8	☺	☺	☺	☺	☺	☺	☺		☺	☺	☺			☺	☺	
SPMT120408-D51	0,8	☺	☺	☺	☺	☺	☺			☺	☺	☺			☺	☺	
SPMT120408-F55	0,8	☺	☺	☺	☺	☺	☺	☺		☺	☺	☺			☺	☺	
SPMW060304-A57	0,4	☺	☺	☺				☺		☺	☺	☺					
SPMW060304T-A27	0,4	☺	☺	☺				☺		☺	☺	☺					
SPMW09T308-A57	0,8	☺	☺	☺				☺		☺	☺	☺					
SPMW09T308T-A27	0,8	☺	☺	☺				☺		☺	☺	☺					
SPMW120408-A57	0,8	☺	☺	☺				☺		☺	☺	☺					
SPMW120408T-A27	0,8	☺	☺	☺				☺		☺	☺	☺					

HC = Coated carbide
HW = Uncoated carbide

WALTER SELECT

Best insert for:

☺
good

☹
moderate

☹
unfavourable

machining conditions

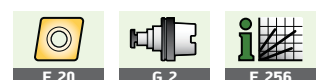

Ball nose mill F 2339 Form A

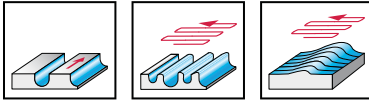

- With anti-twist protection
- Two cutting edges per indexable insert
- Positive basic insert shape

Tool	Designation	$D_c^{-0,2}$ mm	R mm	d_1 mm	l_4 mm	l_1 mm	L_c mm	Z	kg	No. of indexable inserts	Type
NCT ScrewFit 	F2339.T14.016.Z02.11	16	8	T14	25		11	2	0,1	2	XD .. 1303080 R ..
	F2339.T18.020.Z02.15	20	10	T18	30		15	2	0,1	2	XD .. 16T3100 R ..
	F2339.T22.025.Z02.20	25	12,5	T22	35		20	2	0,1	2	XD .. 2004125 R ..
	F2339.T28.030.Z02.24	30	15	T28	40		24	2	0,2	2	XD .. 2405150 R ..
	F2339.T28.032.Z02.25	32	16	T28	40		25	2	0,2	2	XD .. 2506160 R ..
	F2339.T36.040.Z02.31	40	20	T36	50		31	2	0,4	2	XD .. 3207200 R ..
	F2339.T45.050.Z02.40	50	25	T45	60		40	2	0,7	2	XD .. 4009250 R ..
Shank DIN 1835-B 	F2339.W16.016.Z02.11	16	8	16	25	74	11	2	0,2	2	XD .. 1303080 R ..
	F2339.W20.020.Z02.15	20	10	20	35	90	15	2	0,2	2	XD .. 16T3100 R ..
	F2339.W25.025.Z02.20	25	12,5	25	40	105	20	2	0,3	2	XD .. 2004125 R ..
	F2339.W32.030.Z02.24	30	15	32	50	125	24	2	0,6	2	XD .. 2405150 R ..
	F2339.W32.032.Z02.25	32	16	32	50	125	25	2	0,6	2	XD .. 2506160 R ..
	F2339.W40.040.Z02.31	40	20	40	65	150	31	2	1,2	2	XD .. 3207200 R ..

Bodies and assembly parts are included in the scope of delivery.
For open-ended spanners for screw heads, see page G 105.

Assembly parts

D _c mm	16	20	25	30-32	40	50
 Clamping screw for indexable insert	FS1454 (Torx 8 IP)	FS1013 (Torx 8)	FS378 (Torx 15)	FS1165 (Torx 20)	FS1164 (Torx 25)	FS1152 (Torx 30)
Tightening torque	1,2 Nm	1,0 Nm	2,5 Nm	6,0 Nm	10,0 Nm	10,0 Nm

Accessories

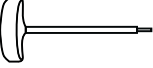
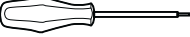
D _c mm	16	20	25	30-32	40	50
 Handle key				FS1173 (Torx 20)	FS1174 (Torx 25)	FS1175 (Torx 30)
 Screwdriver	FS1483 (Torx 8IP)	FS230 (Torx 8)	FS229 (Torx 15)			

Indexable inserts

Designation	Radius mm	P				M		K			N		S		H	
		HC				HC		HC			HC	HW	HC	HC		
		WKP25	WKP35	WKP35S	WSP45	WSM35	WSP45	WAK15	WKK25	WKP25	WKP35	WKP35S	WXN15	WK10	WSM35	WSP45
 XDMT1303080R-F55	8,0	☺	☺	☺	☺	☺	☺		☺	☺	☺			☺	☺	
XDMT16T3100R-F55	10,0	☺	☺	☺	☺	☺	☺		☺	☺	☺			☺	☺	
XDMT2004125R-F55	12,5	☺	☺	☺	☺	☺	☺		☺	☺	☺			☺	☺	
XDMT2405150R-F55	15,0	☺	☺	☺	☺	☺	☺		☺	☺	☺			☺	☺	
XDMT2506160R-F55	16,0	☺	☺	☺	☺	☺	☺		☺	☺	☺			☺	☺	
XDMT3207200R-F55	20,0	☺	☺	☺	☺	☺	☺		☺	☺	☺			☺	☺	
XDMT4009250R-F55	25,0	☺	☺	☺	☺	☺	☺		☺	☺	☺			☺	☺	

HC = Coated carbide
HW = Uncoated carbide

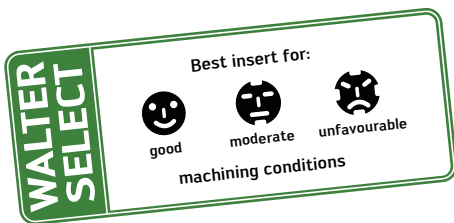

Ball nose mill F 2339 Form B

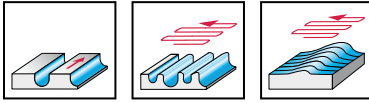

- With anti-twist protection
- Two / four cutting edges per indexable insert
- Positive basic insert shape
- With peripheral cutting edges

Tool	Designation	$D_c^{-0.2}$ mm	R mm	d_1 mm	l_4 mm	l_1 mm	L_c mm	Z	kg	No. of indexable inserts	Type
NCT ScrewFit 	F2339.T14.016.Z02.24	16	8	T14	40		24	2	0,1	2 2	SP .. 0603 .. XD .. 1303080 R ..
	F2339.T18.020.Z02.28	20	10	T18	40		28	2	0,1	2 2	SP .. 0603 .. XD .. 16T3100 R ..
	F2339.T22.025.Z02.32	25	12,5	T22	45		32	2	0,1	2 2	SP .. 0603 .. XD .. 2004125 R ..
	F2339.T28.030.Z02.42	30	15	T28	60		42	2	0,2	2 2	SP .. 09T3 .. XD .. 2405150 R ..
	F2339.T28.032.Z02.43	32	16	T28	60		43	2	0,2	2 2	SP .. 09T3 .. XD .. 2506160 R ..
Shank DIN 1835-B max. projection length 3 x D_c 	F2339.W16.016.Z02.24	16	8	16	40	89	24	2	0,1	2 2	SP .. 0603 .. XD .. 1303080 R ..
	F2339.W20.016.Z02.24	16	8	16	40	91	24	2	0,2	2 2	SP .. 0603 .. XD .. 1303080 R ..
	F2339.W20.020.Z02.28	20	10	20	50	110	28	2	0,2	2 2	SP .. 0603 .. XD .. 16T3100 R ..
	F2339.W25.025.Z02.32	25	12,5	25	55	130	32	2	0,4	2 2	SP .. 0603 .. XD .. 2004125 R ..
	F2339.W32.030.Z02.42	30	15	32	70	160	42	2	0,8	2 2	SP .. 09T3 .. XD .. 2405150 R ..
	F2339.W32.032.Z02.43	32	16	32	70	160	43	2	0,8	2 2	SP .. 09T3 .. XD .. 2506160 R ..
Cylindrical shank max. projection length 5 x D_c 	F2339.Z25.020.Z02.28	20	10	25	75	150	28	2	0,5	2 2	SP .. 0603 .. XD .. 16T3100 R ..
	F2339.Z32.025.Z02.32	25	12,5	32	95	185	32	2	0,9	2 2	SP .. 0603 .. XD .. 2004125 R ..
	F2339.Z40.030.Z02.42	30	15	40	120	220	42	2	1,2	2 2	SP .. 09T3 .. XD .. 2405150 R ..
	F2339.Z40.032.Z02.43	32	16	40	120	220	43,7	2	1,7	2 2	SP .. 09T3 .. XD .. 2506160 R ..

Bodies and assembly parts are included in the scope of delivery.

When making use of the full cutting depth L_c , $Z = 1$ should be considered for the feed rate.

For open-ended spanners for screw heads, see page G 105.

Assembly parts

D _c mm	16	20	25	30-32	40
 Clamping screw for square insert	FS1454 (Torx 8 IP)	FS923 (Torx 8)	FS923 (Torx 8)	FS359 (Torx 15)	FS1030 (Torx 20)
Tightening torque	1,2 Nm	0,8 Nm	0,8 Nm	2,5 Nm	5,0 Nm
Clamping screw for radius insert	FS1454 (Torx 8 IP)	FS1013 (Torx 8)	FS378 (Torx 15)	FS1165 (Torx 20)	FS1164 (Torx 25)
Tightening torque	1,2 Nm	1,0 Nm	2,5 Nm	6,0 Nm	10,0 Nm

Accessories

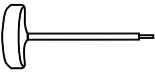
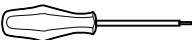
D _c mm	16	20-25	30-32	40
 Handle key			FS1173 (Torx 20)	FS1174 (Torx 25)
 Screwdriver	FS1483 (Torx 8IP)	FS230 (Torx 8)	FS229 (Torx 15)	FS228 (Torx 20)

Indexable inserts

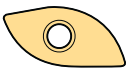
Designation	Radius mm	P		M		K			N		S		H				
		HC	HC	HC	HC	HC	HC	HW	HC	HC	HC						
		WKP25	WKP35	WKP35S	WSP45	WSM35	WSP45	WAK15	WKK25	WKP25	WKP35	WKP35S	WXN15	WK10	WSM35	WSP45	WHH15
	SPMT060304-D51	0,4	☺	☺	☺	☺	☺	☺	☺	☺	☺	☺	☺	☺	☺	☺	☺
	SPMT060304-F55	0,4	☺	☺	☺	☺	☺	☺	☺	☺	☺	☺	☺	☺	☺	☺	☺
	SPMT09T308-D51	0,8	☺	☺	☺	☺	☺	☺	☺	☺	☺	☺	☺	☺	☺	☺	☺
	SPMT09T308-F55	0,8	☺	☺	☺	☺	☺	☺	☺	☺	☺	☺	☺	☺	☺	☺	☺
	SPMT120408-D51	0,8	☺	☺	☺	☺	☺	☺	☺	☺	☺	☺	☺	☺	☺	☺	☺
	SPMT120408-F55	0,8	☺	☺	☺	☺	☺	☺	☺	☺	☺	☺	☺	☺	☺	☺	☺
	SPMW060304-A57	0,4	☺	☺	☺	☺	☺	☺	☺	☺	☺	☺	☺	☺	☺	☺	☺
	SPMW060304T-A27	0,4	☺	☺	☺	☺	☺	☺	☺	☺	☺	☺	☺	☺	☺	☺	☺
	SPMW09T308-A57	0,8	☺	☺	☺	☺	☺	☺	☺	☺	☺	☺	☺	☺	☺	☺	☺
	SPMW09T308T-A27	0,8	☺	☺	☺	☺	☺	☺	☺	☺	☺	☺	☺	☺	☺	☺	☺
	SPMW120408-A57	0,8	☺	☺	☺	☺	☺	☺	☺	☺	☺	☺	☺	☺	☺	☺	☺
	SPMW120408T-A27	0,8	☺	☺	☺	☺	☺	☺	☺	☺	☺	☺	☺	☺	☺	☺	☺
		XDMT1303080R-F55	8,0	☺	☺	☺	☺	☺	☺	☺	☺	☺	☺	☺	☺	☺	☺
XDMT16T3100R-F55		10,0	☺	☺	☺	☺	☺	☺	☺	☺	☺	☺	☺	☺	☺	☺	
XDMT2004125R-F55		12,5	☺	☺	☺	☺	☺	☺	☺	☺	☺	☺	☺	☺	☺	☺	
XDMT2405150R-F55		15,0	☺	☺	☺	☺	☺	☺	☺	☺	☺	☺	☺	☺	☺	☺	
XDMT2506160R-F55		16,0	☺	☺	☺	☺	☺	☺	☺	☺	☺	☺	☺	☺	☺	☺	
XDMT3207200R-F55		20,0	☺	☺	☺	☺	☺	☺	☺	☺	☺	☺	☺	☺	☺	☺	

HC = Coated carbide
HW = Uncoated carbide

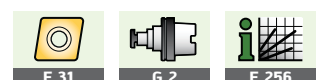
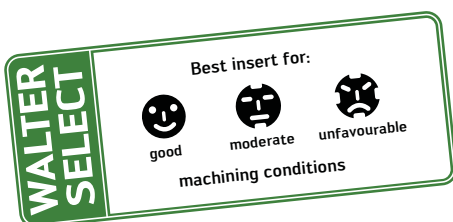

Profile mill F 4031

Xtra-tec®

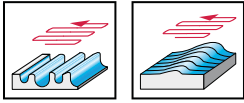

- One cutting edge per indexable insert
- Positive basic insert shape
- With trailing edge

Tool	Designation	D _c mm	d ₁ mm	l ₄ mm	l ₁ mm	Z	kg	No. of indexable inserts	Type
NCT ScrewFit 	F4031.T14.012.Z02.20	12	T14	25		2	0,1	1	P8001-D12R ..
	F4031.T14.016.Z02.25	16	T14	25		2	0,1	1	P8001-D16R ..
	F4031.T18.020.Z02.32	20	T18	30		2	0,1	1	P8001-D20R ..
	F4031.T22.025.Z02.40	25	T22	35		2	0,1	1	P8001-D25R ..
	F4031.T28.032.Z02.50	32	T22	40		2	0,2	1	P8001-D32R ..
Cylindrical shank 	F4031.Z12.012.Z02.20	12	12	32	130	2	0,1	1	P8001-D12R ..
	F4031.Z16.016.Z02.25	16	16	40	140	2	0,2	1	P8001-D16R ..
	F4031.Z20.020.Z02.32	20	20	50	160	2	0,4	1	P8001-D20R ..
	F4031.Z25.025.Z02.40	25	25	63	160	2	0,5	1	P8001-D25R ..
	F4031.Z32.032.Z02.50	32	32	80	180	2	1,0	1	P8001-D32R ..





Bodies and assembly parts are included in the scope of delivery.

For open-ended spanners for screw heads, see page G 105.

Assembly parts

D _c mm	12	16	20	25	32
 Clamping screw for indexable insert	FS2072 (Torx 20 IP)	FS2073 (Torx 20 IP)	FS2074 (Torx 20 IP)	FS2075 (Torx 20 IP)	FS2107 (Torx 30 IP)
Tightening torque	5,0 Nm	5,0 Nm	5,0 Nm	5,0 Nm	6,0 Nm

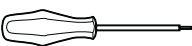
Accessories

D _c mm	12-25	32
 T-handle torque		FS2041
 Torque screwdriver	FS2003	FS2041
 Screwdriver	FS1486 (Torx 20IP)	FS2108 (Torx 30IP)
 Interchangeable blade	FS2015 (Torx 20IP)	FS2109 (Torx 30IP)

Indexable inserts

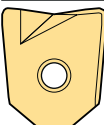
Designation	Radius mm	Trailing edge width mm	P		M		K				N		S		H				
			WKP25	WKP35	WKP35S	WSP45	WSP46	WSM35	WSP46	WAK15	WKK25	WKP25	WKP35	WKP35S	WXN15	WK10	WSM35	WSP46	WHH15
 P8001-D12R05R-A57	0,5	1,5	☒	☒		☒													
P8001-D12R10R-A57	1,0	1,5	☒			☒													☒
P8001-D16R10R-A57	1,0	1,5	☒			☒													☒
P8001-D20R16R-A57	1,6	1,5	☒			☒													☒
P8001-D25R20R-A57	2,0	1,5	☒			☒													☒
P8001-D32R20R-A57	2,0	1,5	☒			☒													☒

HC = Coated carbide
HW = Uncoated carbide

WALTER SELECT

Best insert for:



good





moderate



unfavourable

machining conditions

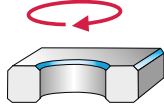
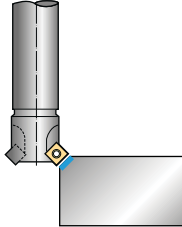
Walter Select – Profile milling

Application		
Approach angle κ	45°	
Profile milling cutter	F 2232 	
Ø range [mm]	8–40	
Page	F 238	
P Steel	••	
M Stainless steel	••	
K Cast iron	••	
N NF metals	••	
S Difficult-to-machine materials	••	
H Hard materials	•	
O Other	•	
Basic insert shape		
Insert types	SP..0603.. SP..09T3.. SP..1204..	
Max. cutting depths [mm]	3 + 5 + 7	
Number of cutting edges per indexable insert	4	

	90°	90°
	F 2036	F 2243
	16-63	21-50
	F 236	F 240
	••	••
	•	••
	••	••
	•	•
	•	•
	P 20200 - 1 P 20200 - 2 P 20200 - 3	SP.. 0603 .. SP.. 09T3 .. SP.. 1204 ..
	4	9-21
	2	4



Circular groove milling cutter F 2036

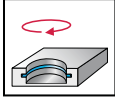

- Approach angle $\kappa = 90^\circ$
- Two cutting edges per indexable insert
- Positive basic insert shape

Tool	Designation	D_c mm	d_1 mm	l_4 mm	l_1 mm	a_e max mm	Z	kg	SB _{H13} mm	for \emptyset mm	No. of indexable inserts	Type
Combishank DIN 1835, Form B and D	F2036.5.16.090.016	16	16	42	90	1,75	1	0,2	1,1*	18-22	1	P 20200 - 1.1
									1,3*	22-32	1	P 20200 - 1.2
									1,6*	34-38	1	P 20200 - 1.3
	F2036.5.25.130.025	25	25	74	130	2,0	2	0,2	1,3*	28-32	2	P 20200 - 1.2
									1,6*	34-38	2	P 20200 - 1.3
									1,85*	40-48	2	P 20200 - 1.4
									2,15*	50-63	2	P 20200 - 1.5
	F2036.5.32.140.040	40	32	80	140	2,75	4	0,4	2,15*	50-63	4	P 20200 - 2.1
									2,65*	65-82	4	P 20200 - 2.2
									3,15*	85-100	4	P 20200 - 2.3
Modular adaptor NCT	F2036M.0.50.040.063	63	NCT 50	40		4,0	6	0,4	3,15*	85-100	6	P 20200 - 3.1
									4,15*	102-200	6	P 20200 - 3.2
									5,15*	210-300	6	P 20200 - 3.3

* Nominal size of the slot width of the workpiece in accordance with DIN 472 in relation to the bore diameter.
Bodies and assembly parts are included in the scope of delivery.

Assembly parts

	D _c mm	16-25	40	63
	Clamping screw for indexable insert	FS322 (Torx 7)	FS246 (Torx 8)	FS326 (Torx 15)
	Tightening torque	0,8 Nm	1,5 Nm	3,0 Nm

Accessories

	D _c mm	16-25	40	63
	Screwdriver	FS309 (Torx 7)	FS230 (Torx 8)	FS229 (Torx 15)

Indexable inserts

Designation	Facet mm	P				M		K				N		S		H
		HC				HC		HC				HC	HW	HC		HC
		WKP25	WKP35	WKP35S	WSP45	WSM35	WSP45	WAK15	WKK25	WKP25	WKP35	WKP35S	WXN15	WK10	WSM35	WSP45
	P20200-1.1	0,1 x 45°														
P20200-1.2	0,15 x 45°															
P20200-1.3	0,15 x 45°															
P20200-1.4	0,15 x 45°															
P20200-1.5	0,15 x 45°															
P20200-2.1	0,15 x 45°															
P20200-2.2	0,15 x 45°															
P20200-2.3	0,15 x 45°															
P20200-3.1	0,15 x 45°															
P20200-3.2	0,15 x 45°															
P20200-3.3	0,15 x 45°															

HC = Coated carbide
HW = Uncoated carbide

WALTER SELECT

Best insert for:

good

moderate

unfavourable

machining conditions

Chamfer mill F 2232

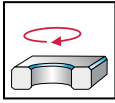

- Approach angle $\kappa = 45^\circ$
- Four cutting edges per indexable insert
- Positive basic insert shape

Tool	Designation	D _c mm	D _a mm	d ₁ mm	l ₄ mm	L _c mm	l ₁ mm	Z	kg	No. of indexable inserts	Type
NCT ScrewFit 	F2232.T09.012.Z02.03	12	20,3	T09	20	3		2	0,1	2	SP .. 0603 ..
	F2232.T14.016.Z03.03	16	24,3	T14	25	3		3	0,1	3	
	F2232.T18.020.Z02.05	20	32,2	T18	30	5		2	0,1	2	SP .. 09T3 ..
	F2232.T22.025.Z03.05	25	37,2	T22	35	5		3	0,1	3	
	F2232.T28.032.Z02.07	32	48,7	T28	40	7		2	0,3	2	SP .. 1204 ..
	F2232.T28.032.Z03.05	32	44,2	T28	40	5		3	0,3	3	SP .. 09T3 ..
	F2232.T36.040.Z03.07	40	56,7	T36	40	7		3	0,2	3	SP .. 1204 ..
	F2232.T36.040.Z04.05	40	52,2	T36	40	5		4	0,4	4	SP .. 09T3 ..
Cylindrical shank 	F2232.Z.008.Z01.03	8	16,3	12	30	3	120	1	0,1	1	SP .. 0603 ..
	F2232.Z.010.Z01.03	10	18,3	12	30	3	120	1	0,1	1	
	F2232.Z.012.Z01.05	12	24,2	16	40	5	160	1	0,2	1	SP .. 09T3 ..
	F2232.Z.012.Z02.03	12	20,3	16	40	3	160	2	0,2	2	SP .. 0603 ..
	F2232.Z.016.Z02.05	16	28,2	16	40	5	160	2	0,2	2	SP .. 09T3 ..
	F2232.Z.016.Z03.03	16	24,3	16	40	3	160	3	0,2	3	SP .. 0603 ..
	F2232.Z.020.Z01.07	20	36,7	20	40	7	200	1	0,5	1	SP .. 1204 ..
	F2232.Z.020.Z02.05	20	32,2	20	40	5	200	2	0,5	2	SP .. 09T3 ..
	F2232.Z.025.Z02.07	25	41,7	25	40	7	200	2	0,8	2	SP .. 1204 ..
	F2232.Z.025.Z03.05	25	37,2	25	40	5	200	3	0,8	3	SP .. 09T3 ..
	F2232.Z.032.Z02.07	32	48,7	32	40	7	250	2	1,6	2	SP .. 1204 ..
	F2232.Z.032.Z03.05	32	44,2	32	40	5	250	3	1,6	3	SP .. 09T3 ..
	F2232.Z.040.Z03.07	40	56,7	32	40	7	250	3	1,6	3	SP .. 1204 ..
	F2232.Z.040.Z04.05	40	52,2	32	40	5	250	4	1,6	4	SP .. 09T3 ..

Bodies and assembly parts are included in the scope of delivery.

For open-ended spanners for screw heads, see page G 105.

Assembly parts

Insert types	SP . . 0603 . .	SP . . 09T3 . .	SP . . 1204 . .
Clamping screw for indexable insert	FS923 (Torx 8)	FS359 (Torx 15)	FS1030 (Torx 20)
Tightening torque	0,8 Nm	2,5 Nm	5,0 Nm

Accessories

Insert types	SP . . 0603 . .	SP . . 09T3 . .	SP . . 1204 . .
Screwdriver	FS230 (Torx 8)	FS229 (Torx 15)	FS228 (Torx 20)

Indexable inserts

Designation	Radius mm	P				M		K				N		S		H	
		HC				HC		HC				CN	HC	HW	HC	HC	
		WKP25	WKP35	WKP35S	WSP45	WSM35	WSP45	WAK15	WKK25	WKP25	WKP35	WKP35S	WSN10	WXN15	WK10	WSM35	WSP45
SPHT060304-G88	0,4											☺	☺				
SPHT09T308-G88	0,8											☺	☺				
SPHT120408-G88	0,8											☺	☺				
SPHW120416-A57	1,6										☺						
SPMT060304-D51	0,4	☺	☺	☺	☺	☺	☺		☺	☺	☺				☺	☺	
SPMT060304-F55	0,4	☺	☺	☺	☺	☺	☺	☺		☺	☺				☺	☺	
SPMT09T308-D51	0,8	☺	☺	☺	☺	☺	☺		☺	☺	☺				☺	☺	
SPMT09T308-F55	0,8	☺	☺	☺	☺	☺	☺	☺		☺	☺				☺	☺	
SPMT120408-D51	0,8	☺	☺	☺	☺	☺	☺		☺	☺	☺				☺	☺	
SPMT120408-F55	0,8	☺	☺	☺	☺	☺	☺	☺		☺	☺				☺	☺	
SPMW060304-A57	0,4	☺	☺	☺			☺		☺	☺	☺						
SPMW060304T-A27	0,4	☺	☺	☺					☺	☺	☺						
SPMW09T308-A57	0,8	☺	☺	☺			☺		☺	☺	☺						
SPMW09T308T-A27	0,8	☺	☺	☺					☺	☺	☺						
SPMW120408-A57	0,8	☺	☺	☺			☺		☺	☺	☺						
SPMW120408T-A27	0,8	☺	☺	☺					☺	☺	☺						

HC = Coated carbide
 CN = Silicon nitride Si₃N₄
 HW = Uncoated carbide

WALTER SELECT

Best insert for:

☺
good

☹
moderate

☹☹
unfavourable

machining conditions

T-slot mill F 2243

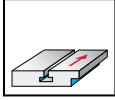

- Approach angle $\kappa = 90^\circ$
- Four cutting edges per indexable insert
- Positive basic insert shape
- For slotting in accordance with DIN 650

Tool		D_c mm	d_1 mm	d_2 mm	l_4 mm	l_1 mm	SB mm	Z	kg	No. of indexable inserts	Type
Shank DIN 1835-B	F2243.W.021.Z01.09	21	12	11	27	73	9	1	0,1	2	SP...060304
	F2243.W.025.Z02.11	25	16	12	31	80	11	2	0,1	4	
	F2243.W.032.Z02.14	32	20	17	39	90	14	2	0,2	4	SP...09T308
	F2243.W.040.Z02.17	40	25	21	49	106	17	2	0,4	4	
	F2243.W.050.Z02.21	50	32	27	61	122	21	2	0,7	4	SP...120408

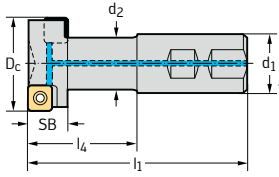

Bodies and assembly parts are included in the scope of delivery.

Assembly parts

D _c mm		21-25	32-40	50
	Clamping screw for indexable insert	FS923 (Torx 8)		
	Tightening torque	0,8 Nm		
	Clamping screw for indexable insert		FS922 (Torx 15)	FS1028 (Torx 20)
	Tightening torque		2,5 Nm	4,0 Nm

Accessories

D _c mm		21-25	32-40	50
	Screwdriver	FS230 (Torx 8)	FS229 (Torx 15)	FS228 (Torx 20)

Indexable inserts

Designation	Radius mm	P				M		K				N			S		H
		HC				HC		HC				HC	HW	HC	HC	HC	
		WKP25	WKP35	WKP35S	WSP45	WSM35	WSP45	WAK15	WKK25	WKP25	WKP35	WKP35S	WSN10	WXN15	WK10	WSM35	WSP45
	SPHT060304-G88												☺	☺			
SPHT09T308-G88	0,8												☺	☺			
SPHT120408-G88	0,8												☺	☺			
SPHW120416-A57	1,6											☺					
SPMT060304-D51	0,4	☺	☺	☺	☺	☺	☺		☺	☺	☺				☺	☺	
SPMT060304-F55	0,4	☺	☺	☺	☺	☺	☺	☺		☺	☺				☺	☺	
SPMT09T308-D51	0,8	☺	☺	☺	☺	☺	☺		☺	☺	☺				☺	☺	
SPMT09T308-F55	0,8	☺	☺	☺	☺	☺	☺		☺	☺	☺				☺	☺	
SPMT120408-D51	0,8	☺	☺	☺	☺	☺	☺		☺	☺	☺				☺	☺	
SPMT120408-F55	0,8	☺	☺	☺	☺	☺	☺		☺	☺	☺				☺	☺	
SPMW060304-A57	0,4	☺	☺	☺			☺		☺	☺	☺						
SPMW060304T-A27	0,4	☺	☺	☺					☺	☺	☺						
SPMW09T308-A57	0,8	☺	☺	☺			☺		☺	☺	☺						
SPMW09T308T-A27	0,8	☺	☺	☺					☺	☺	☺						
SPMW120408-A57	0,8	☺	☺	☺			☺		☺	☺	☺						
SPMW120408T-A27	0,8	☺	☺	☺					☺	☺	☺						

HC = Coated carbide
 CN = Silicon nitride Si₃N₄
 HW = Uncoated carbide

WALTER SELECT

Best insert for:

☺
good

☹
moderate

☹
unfavourable

machining conditions

Walter Select – circular interpolation milling

Application				
Approach angle K	43°	45° / 90°	90°	90°
Circular interpolation mill	F 4080 / F 2010	F 4081	F 3040	F 4042 / F 4042R F 2010
	Xtra-tec®	Xtra-tec®		Xtra-tec®
Ø range [mm]	32–315	28–75	25–63	10–315
Page	F 130	F 244	F 140	F 144
P Steel	••	••		••
M Stainless steel	••	••		••
K Cast iron	••	••	•	••
N NF metals	••	••	••	••
S Difficult-to-machine materials	••	••	•	••
H Hard materials				•
O Other	•	•	•	•
Basic insert shape				
Insert types	OD .. 0504 .. OD .. 0605 ..	OD .. 0504 .. OD .. 0605 ..	ZDGT 1504 .. ZDGT 2005 ..	AD . T 0803 .. AD . T 10T3 .. AD . T 1204 .. AD . T 1606 .. AD . T 1807 ..
Max. cutting depths [mm]	3/8 + 4/10	3/8 + 4/10	15 + 20	8 + 10 + 11,7 + 15 + 16
Number of cutting edges per indexable insert	2 – 8	2 – 4	2	2

	0-15°	0-21°	-	-
	F 2330 / F 2010	F 4030	F 2234	F 2334 / F 2010
		Xtra-tec®		
	20-305	25-63	12-160	25-309
	F 114	F 116	F 218	F 222
	••	••	••	••
	••	••	••	••
	••	••	••	••
			••	•
	••	••	•	••
			••	•
			•	
	P 2633 . P 26379	P 23696 - 1,0	RD ..	RO . X ..
	1 + 1,5 + 2	1	2,5-10	4-10
	3	6	3 - 6	2 - 4

Octagon cutter F 4081

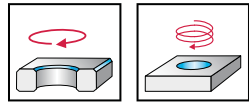
Xtra-tec®

- Approach angle $\kappa = 45^\circ / 90^\circ$
- Two to four cutting edges per indexable insert
- Positive basic insert shape
- Specially for circular interpolation milling

Tool	Designation	D _c mm	D _a mm	d ₁ mm	l ₄ mm	L _c mm	L _{c2} mm	l ₁ mm	Z	kg	No. of indexable inserts	Type
NCT ScrewFit 	F4081.T28.036.Z03.03*	28	36	T28	40	3	8		3	0,2	3	OD .. 0504 ..
	F4081.T36.044.Z03.03*	36	44	T36	40	3	8		3	0,3	3	
	F4081.T45.052.Z04.03*	44	52	T45	45	3	8		4	0,5	4	
Cylindrical shank 	F4081.Z25.036.Z03.03*	28	36	25	35	3	8	150	3	0,5	3	OD .. 0504 ..
	F4081.Z32.044.Z03.03*	36	44	32	35	3	8	200	3	1,2	3	
Cyl. bore DIN 138 longitudinal key way 	F4081.B22.052.Z03.04*	42	52	22	45	4	10		3	0,3	3	OD .. 0605 ..
	F4081.B22.052.Z04.03*	44	52	22	45	3	8		4	0,3	4	OD .. 0504 ..
	F4081.B22.052.Z04.04*	42	52	22	45	4	10		4	0,3	4	OD .. 0605 ..
	F4081.B22.052.Z05.03*	44	52	22	45	3	8		5	0,3	5	OD .. 0504 ..
	F4081.B27.066.Z04.04*	56	66	27	50	4	10		4	0,6	4	OD .. 0605 ..
	F4081.B27.066.Z05.03*	58	66	27	50	3	8		5	0,6	5	OD .. 0504 ..
	F4081.B27.066.Z05.04*	56	66	27	50	4	10		5	0,5	5	OD .. 0605 ..
	F4081.B27.066.Z06.03*	58	66	27	50	3	8		6	0,6	6	OD .. 0504 ..
	F4081.B27.085.Z05.04*	75	85	27	50	4	10		5	1,0	5	OD .. 0605 ..
	F4081.B27.085.Z06.03*	77	85	27	50	3	8		6	1,0	6	OD .. 0504 ..
	F4081.B27.085.Z06.04*	75	85	27	50	4	10		6	1,0	6	OD .. 0605 ..
	F4081.B27.085.Z07.03*	77	85	27	50	3	8		7	1,1	7	OD .. 0504 ..

Bodies and assembly parts are included in the scope of delivery.

For open-ended spanners for screw heads, see page G 105.

* Design balanced to G 6.3 where n = 10000 rpm

Assembly parts		Insert types D _a mm	OD..0504.. 36-52	OD..0504.. 66-85	OD..0605.. 52-85
	Clamping screw for indexable insert		FS2119 (Torx 15 IP)	FS 2119 (Torx 15 IP)	FS1495 (Torx 20 IP)
	Tightening torque		3,0 Nm	3,0 Nm	5,0 Nm

Accessories		Insert types D _c mm	OD..0504..	OD..0605..
	Torque screwdriver		FS2003	FS2003
	Screwdriver		FS1485 (Torx 15 IP)	FS1486 (Torx 20 IP)
	Interchangeable blade		FS2014 (Torx 15 IP)	FS2015 (Torx 20 IP)

Indexable inserts

Designation	Radius mm	P		M		K				N		S		H			
		HC		HC		HC				HC	HW	HC		HC			
		WKP25	WKP35	WKP35S	WSP45	WSM35	WSP45	WAK15	WKK25	WKP25	WKP35	WKP35S	WXN15	WK10	WSM35	WSP45	WHH15
ODHT050408-F57	0,8		⊕	⊕	⊕	⊕											
ODHT050408-G88	0,8		⊕	⊕	⊕	⊕						⊕	⊕				
ODHT060512-F57	0,8		⊕	⊕	⊕	⊕											
ODHT060512-G88	0,8											⊕	⊕				
ODHW050408-A57	0,8		⊕	⊕	⊕												
ODHW060512-A57	1,2		⊕	⊕	⊕												
ODMT050408-D57	0,8		⊕	⊕	⊕	⊕											
ODMT060512-D57	1,2		⊕	⊕	⊕	⊕											
ODMW050408-A57	0,8		⊕	⊕	⊕												
ODMW050408T-A27	0,8		⊕	⊕	⊕												

HC = Coated carbide
HW = Uncoated carbide

WALTER SELECT

Best insert for:

good

moderate

unfavourable

maching conditions

Cutting data for roughing

Face / shoulder milling

Material group	Structure of main material groups and identification letters		Brinell hardness HB	Tensile strength R_m N/mm ²	Machining group ¹	= Cutting data for wet machining = Dry machining is possible		Cutting material grades						
								Starting values for cutting speed v_c [m/min]						
								HC						
								WKP35S		WKP35		WKP25		
a_e / D_c^*		a_e / D_c^*		a_e / D_c^*		1/1 1/2		1/5		1/1 1/2				
						1/5		1/5		1/5				
P	Unalloyed steel	C ≤ 0,25 %	annealed	125	428	P1	●	●●	250	300	250	300	290	320
		C > 0,25 ... ≤ 0,55 %	annealed	190	639	P2	●	●●	220	260	220	260	260	330
		C > 0,25 ... ≤ 0,55 %	tempered	210	708	P3	●	●●	215	250	215	250	255	320
		C > 0,55 %	annealed	190	639	P4	●	●●	220	260	220	260	260	330
		C > 0,55 %	tempered	300	1013	P5	●	●●	160	180	160	180	220	260
		Free cutting steel (short-chipping)	annealed	220	745	P6	●	●●	210	240	210	240	250	315
	Low-alloyed steel	annealed	175	591	P7	●	●●	220	270	220	270	260	320	
		tempered	300	1013	P8	●	●●	170	190	170	190	210	250	
		tempered	380	1282	P9	●	●●	130	150	130	150	170	190	
		tempered	430	1477	P10	●	●●	110	130	110	130	150	170	
High-alloyed steel and high-alloyed tool steel	annealed	200	675	P11	●	●●	130	160	130	160	140	170		
	hardened and tempered	300	1013	P12	●	●●	80	90	80	90	110	130		
	hardened and tempered	400	1361	P13	●	●●	70	80	70	80	90	110		
Stainless steel	ferritic / martensitic, annealed	200	675	P14	●	●●	140	160	140	160				
	martensitic, tempered	330	1114	P15	●	●●	90	110	90	110				
M	Stainless steel	austenitic, quench hardened	200	675	M1	●●	●							
		austenitic, precipitation hardened (PH)	300	1013	M2	●●	●							
		austenitic / ferritic, duplex	230	778	M3	●●	●							
K	Malleable cast iron	ferritic	200	675	K1	●	●●	160	190	160	190	180	210	
		pearlitic	260	867	K2	●	●●	140	170	140	170	160	190	
	Grey cast iron	low tensile strength	180	602	K3	●	●●	300	330	300	330	320	350	
		high tensile strength / austenitic	245	825	K4	●	●●	190	220	190	220	180	210	
	Cast iron with spheroidal graphite	ferritic	155	518	K5	●	●●	200	220	200	220	220	240	
		pearlitic	265	885	K6	●	●●	130	150	130	150	140	170	
	GGV (CGI)		200	675	K7	●	●●	130	160	130	160	150	180	
N	Aluminium wrought alloys	cannot be hardened	30	–	N1	●●								
		hardenable, hardened	100	343	N2	●●								
	Cast aluminium alloys	≤ 12 % Si, not hardenable	75	260	N3	●●								
		≤ 12 % Si, hardenable, hardened	90	314	N4	●●								
		> 12 % Si, cannot be hardened	130	447	N5	●●								
	Magnesium alloys		70	250	N6	●●								
	Copper and copper alloys (bronze / brass)	unalloyed, electrolytic copper	100	343	N7	●●								
		Brass, bronze, red brass	90	314	N8	●●								
		Cu-alloys, short-chipping	110	382	N9	●●								
		high-strength, Ampco	300	1013	N10	●●								
S	Heat-resistant alloys	Fe-based	annealed	200	675	S1	●●							
			hardened	280	943	S2	●●							
		Ni or Co base	annealed	250	839	S3	●●							
			hardened	350	1177	S4	●●							
			cast	320	1076	S5	●●							
	Titanium alloys	Pure titanium	200	675	S6	●●								
		α and β alloys, hardened	375	1262	S7	●●								
		β alloys	410	1396	S8	●●								
	Tungsten alloys		300	1013	S9	●●								
	Molybdenum alloys		300	1013	S10	●●								
H	Hardened steel	hardened and tempered	50 HRC	–	H1		●●							
		hardened and tempered	55 HRC	–	H2		●●							
		hardened and tempered	60 HRC	–	H3		●●							
	Hardened cast iron	hardened and tempered	55 HRC	–	H4		●●							
O	Thermoplasts	without abrasive fillers			O1	●●	●	400	400	400	400			
	Thermosetting plastics	without abrasive fillers			O2	●●	●	300	300	300	300			
	Plastic, glass-fibre reinforced	GFRP			O3									
	Plastic, carbon-fibre reinforced	CFRP			O4									
	Plastic, aramid fibre reinforced	AFRP			O5									
	Graphite (technical)		80 Shore			O6		●●				400	500	

- Recommended application (the specified cutting data are regarded as starting values for the recommended application).
- Possible application, reduce cutting data by 30–50 % (increase for ISO M approx. 70–80 %).

¹ The machining groups are assigned from H 8 onwards.

² Cutting data can also be used without coolant.

* $a_e / D_c = 1/10$, $v_c = 10$ % higher than 1/5.

The specified cutting data are average recommended values.
For special applications, adjustment is recommended.

Cutting material grades																						
Starting values for cutting speed v_c [m/min]																						
WAK15		WSP45		WSM35		WKK25		WXN15		WMG40		WK10		WSN10		WCB50		WCB80		WCD10 ²		
a_e / D_c^*		a_e / D_c^*		a_e / D_c^*		a_e / D_c^*		a_e / D_c^*		a_e / D_c^*		a_e / D_c^*		a_e / D_c^*		a_e / D_c^*		a_e / D_c^*		a_e / D_c^*		
1/1	1/5	1/1	1/5	1/1	1/5	1/1	1/5	1/1	1/5	1/1	1/5	1/1	1/5	1/1	1/5	1/1	1/5	1/1	1/5	1/1	1/5	
		230	290																			
		190	250																			
		180	230																			
		190	250																			
		130	145																			
		175	225																			
		190	240																			
		130	145																			
		100	110																			
		80	90																			
		115	140																			
		75	90																			
		65	80																			
		115	140	120	150																	
		80	100	80	110																	
		110	130	130	155																	
		90	100	100	120																	
		100	120	120	140																	
210	230					190	230						900	1000								
190	210					170	200						800	900								
380	410					350	380						1100	1300			1000	1250				
230	260					190	230						900	1000			800	950				
260	280					240	260						750	900			650	800				
170	200					150	180						650	750			600	700				
180	200					160	190						650	750			600	700				
								2640	2640	1500	1500	2200	2200								3000	4000
								1980	1980	1000	1000	1650	1650								2000	2000
								660	730			550	605								1500	1500
								530	530			440	440								1000	1000
								265	310			220	260								500	500
								530	530			440	440									
								460	460			380	380									
								260	300			220	260									
								190	200			160	170									
								150	160			120	130									
		65	70	80	90							75	80									
		45	50	60	65							45	50									
		50	55	60	70							55	60									
		30	35	40	45							25	30									
		40	45	50	55							35	40									
		65	70	80	90							75	80									
		30	35	40	45							25	30									
		30	35	30	45							30	40									
		70	80	70	80							70	80									
		70	80	70	80							70	80									
65	80					65	80					65	80			450	550					
50	65					50	65					50	65			220	280					
40	50					40	50					40	50			140	220					
50	65					50	65					50	65			220	280					
400	400	400	400	400	400	400	400	400	400	400	400	400	400									
300	300	300	300	300	300	300	300	300	300	300	300	300	300									
600	800					600	800	600	800			400	500									

HC = Coated carbide
HW = Uncoated carbide
HF = Uncoated fine-grained carbide

BH = CBN with high CBN content
BL = CBN with low CBN content
DP = polycrystalline diamond
CN = Silicon nitride Si₃N₄

Cutting data for roughing

Shoulder milling with full effective teeth porcupine cutters (F2338F, F4038, F4138, F4238, F4338)

Material group	Structure of main material groups and identification letters		Brinell hardness HB	Tensile strength R_m N/mm ²	Machining group ¹	= Cutting data for wet machining = Dry machining is possible		Cutting material grades				
								Starting values for cutting speed v_c [m/min]				
								HC				
								WKP35S		WKP35		
a_e / D_c^*		a_e / D_c^*		a_e / D_c^*		a_e / D_c^*						
						1/2	1/5	1/2	1/5			
P	Unalloyed steel	C ≤ 0,25 %	annealed	125	428	P1	●	●●	195	250	195	250
		C > 0,25 ... ≤ 0,55 %	annealed	190	639	P2	●	●●	170	215	170	215
		C > 0,25 ... ≤ 0,55 %	tempered	210	708	P3	●	●●	155	190	155	190
		C > 0,55 %	annealed	190	639	P4	●	●●	170	215	170	215
		C > 0,55 %	tempered	300	1013	P5	●	●●	130	145	130	145
		Free cutting steel (short-chipping)	annealed	220	745	P6	●	●●	150	210	150	210
	Low-alloyed steel		annealed	175	591	P7	●	●●	170	215	170	215
			tempered	300	1013	P8	●	●●	130	145	130	145
			tempered	380	1282	P9	●	●●	85	100	85	100
			tempered	430	1477	P10	●	●●	80	90	80	90
	High-alloyed steel and high-alloyed tool steel		annealed	200	675	P11	●	●●	100	120	100	120
			hardened and tempered	300	1013	P12	●	●●	65	75	65	75
			hardened and tempered	400	1361	P13	●	●●	60	70	60	70
	Stainless steel		ferritic / martensitic, annealed	200	675	P14	●	●●	105	120	105	120
			martensitic, tempered	330	1114	P15	●	●●	60	70	60	70
M	Stainless steel	austenitic, quench hardened	200	675	M1	●●	●					
		austenitic, precipitation hardened (PH)	300	1013	M2	●●	●					
		austenitic / ferritic, duplex	230	778	M3	●●	●					
K	Malleable cast iron	ferritic	200	675	K1	●	●●	150	170	150	170	
		pearlitic	260	867	K2	●	●●	120	140	120	140	
	Grey cast iron	low tensile strength	180	602	K3	●	●●	160	180	160	180	
		high tensile strength / austenitic	245	825	K4	●	●●	120	140	120	140	
	Cast iron with spheroidal graphite	ferritic	155	518	K5	●	●●	140	150	140	150	
		pearlitic	265	885	K6	●	●●	105	115	105	115	
	GGV (CGI)		200	675	K7	●	●●	150	170	150	170	
N	Aluminium wrought alloys	cannot be hardened	30	–	N1	●●						
		hardenable, hardened	100	343	N2	●●						
	Cast aluminium alloys	≤ 12 % Si, not hardenable	75	260	N3	●●						
		≤ 12 % Si, hardenable, hardened	90	314	N4	●●						
		> 12 % Si, cannot be hardened	130	447	N5	●●						
	Magnesium alloys		70	250	N6	●●						
	Copper and copper alloys (bronze / brass)	unalloyed, electrolytic copper	100	343	N7	●●						
		Brass, bronze, red brass	90	314	N8	●●						
		Cu-alloys, short-chipping	110	382	N9	●●						
		high-strength, Ampco	300	1013	N10	●●						
S	Heat-resistant alloys	Fe-based	annealed	200	675	S1	●●					
			hardened	280	943	S2	●●					
		Ni or Co base	annealed	250	839	S3	●●					
			hardened	350	1177	S4	●●					
			cast	320	1076	S5	●●					
	Titanium alloys	Pure titanium	200	675	S6	●●						
		α and β alloys, hardened	375	1262	S7	●●						
		β alloys	410	1396	S8	●●						
	Tungsten alloys		300	1013	S9	●●						
	Molybdenum alloys		300	1013	S10	●●						
H	Hardened steel	hardened and tempered	50 HRC	–	H1		●●					
		hardened and tempered	55 HRC	–	H2		●●					
		hardened and tempered	60 HRC	–	H3		●●					
	Hardened cast iron	hardened and tempered	55 HRC	–	H4		●●					
O	Thermoplasts	without abrasive fillers			O1	●●	●	400	400	400	400	
	Thermosetting plastics	without abrasive fillers			O2	●●	●	300	300	300	300	
	Plastic, glass-fibre reinforced	GFRP			O3							
	Plastic, carbon-fibre reinforced	CFRP			O4							
	Plastic, aramid fibre reinforced	AFRP			O5							
	Graphite (technical)		80 Shore		O6		●●					

- Recommended application (the specified cutting data are regarded as starting values for the recommended application).
- Possible application, reduce cutting data by 30–50 % (increase for ISO M approx. 70–80 %).

¹ The machining groups are assigned from H 8 onwards.

* $a_e / D_c = 1/10$, $v_c = 10$ % higher than 1/5.

The specified cutting data are average recommended values.
For special applications, adjustment is recommended.

Cutting material grades													
Starting values for cutting speed v_c [m/min]													
HC												HW	
WKP25		WAK15		WSP45		WSM35		WKK25		WXN15		WK10	
a_e / D_c^*		a_e / D_c^*		a_e / D_c^*		a_e / D_c^*		a_e / D_c^*		a_e / D_c^*		a_e / D_c^*	
1/2	1/5	1/2	1/5	1/2	1/5	1/2	1/5	1/2	1/5	1/2	1/5	1/2	1/5
210	275			185	230								
200	255			150	200								
175	220			130	165								
200	255			150	200								
165	200			105	115								
170	210			125	160								
200	255			150	190								
155	200			105	115								
125	140			60	70								
110	120			60	70								
110	130			90	110								
80	95			65	70								
70	80			60	70								
				90	110	95	120						
				60	70	60	70						
				85	100	100	120						
				70	80	80	100						
				75	90	90	110						
120	220	210	270					190	250			70	80
130	150	160	180					140	160			65	65
180	230	220	280					200	260			75	85
130	150	160	180					140	160			55	55
150	160	180	190					160	170			70	80
120	125	155	165					135	145			65	65
120	220	210	270					190	250			70	80
										1800	1800	1500	1500
										1440	1440	1200	1200
										540	640	450	530
										430	430	360	360
										220	260	180	215
										430	430	360	360
										170	210	140	175
										280	280	230	230
										170	210	140	175
										130	170	100	130
				50	55	65	70						
				35	40	50	50						
				40	45	50	55						
				25	30	30	35						
				30	35	50	45						
				50	65	65	80						
				30	35	40	45						
				25	30	35	40						
				30	35	40	45						
				25	30	35	40						
		45	55					45	55				35
		40	50					40	50				35
		40	50					40	50				35
		400	400	400	400	400	400	400	400	400	400	400	400
		300	300	300	300	300	300	300	300	300	300	300	300
400	500	600	800					600	800	600	800	400	500

HC = Coated carbide
HW = Uncoated carbide
HF = Uncoated fine-grained carbide

BH = CBN with high CBN content
BL = CBN with low CBN content
DP = polycrystalline diamond
CN = Silicon nitride Si_3N_4

Cutting data for roughing

Slot milling with half effective teeth porcupine cutters (F2237, F2238, F2338)

Material group	Structure of main material groups and identification letters		Brinell hardness HB	Tensile strength R_m N/mm ²	Machining group ¹	= Cutting data for wet machining = Dry machining is possible		Cutting material grades			
								Starting values for cutting speed v_c [m/min]			
								HC			
								WKP35S		WKP35	
a_e / D_c^*		a_e / D_c^*		1/1 1/2		1/5					
P	Unalloyed steel	C ≤ 0,25 %	annealed	125	428	P1	● ●	195	250	195	250
		C > 0,25 ... ≤ 0,55 %	annealed	190	639	P2	● ●	170	215	170	215
		C > 0,25 ... ≤ 0,55 %	tempered	210	708	P3	● ●	155	190	155	190
		C > 0,55 %	annealed	190	639	P4	● ●	170	215	170	215
		C > 0,55 %	tempered	300	1013	P5	● ●	130	145	130	145
		Free cutting steel (short-chipping)	annealed	220	745	P6	● ●	150	210	150	210
	Low-alloyed steel	annealed	175	591	P7	● ●	170	215	170	215	
		tempered	300	1013	P8	● ●	130	145	130	145	
		tempered	380	1282	P9	● ●	85	100	85	100	
		tempered	430	1477	P10	● ●	80	90	80	90	
	High-alloyed steel and high-alloyed tool steel	annealed	200	675	P11	● ●	100	120	100	120	
		hardened and tempered	300	1013	P12	● ●	65	75	65	75	
		hardened and tempered	400	1361	P13	● ●	60	70	60	70	
	Stainless steel	ferritic / martensitic, annealed	200	675	P14	● ●	105	120	105	120	
		martensitic, tempered	330	1114	P15	● ●	60	70	60	70	
M	Stainless steel	austenitic, quench hardened	200	675	M1	● ●					
		austenitic, precipitation hardened (PH)	300	1013	M2	● ●					
		austenitic / ferritic, duplex	230	778	M3	● ●					
K	Malleable cast iron	ferritic	200	675	K1	● ●	150	170	150	170	
		pearlitic	260	867	K2	● ●	120	140	120	140	
	Grey cast iron	low tensile strength	180	602	K3	● ●	160	180	160	180	
		high tensile strength / austenitic	245	825	K4	● ●	120	140	120	140	
	Cast iron with spheroidal graphite	ferritic	155	518	K5	● ●	140	150	140	150	
		pearlitic	265	885	K6	● ●	105	115	105	115	
	GGV (CGI)		200	675	K7	● ●	150	170	150	170	
N	Aluminium wrought alloys	cannot be hardened	30	-	N1	● ●					
		hardenable, hardened	100	343	N2	● ●					
	Cast aluminium alloys	≤ 12 % Si, not hardenable	75	260	N3	● ●					
		≤ 12 % Si, hardenable, hardened	90	314	N4	● ●					
		> 12 % Si, cannot be hardened	130	447	N5	● ●					
	Magnesium alloys		70	250	N6	● ●					
	Copper and copper alloys (bronze / brass)	unalloyed, electrolytic copper	100	343	N7	● ●					
		Brass, bronze, red brass	90	314	N8	● ●					
		Cu-alloys, short-chipping	110	382	N9	● ●					
		high-strength, Ampco	300	1013	N10	● ●					
S	Heat-resistant alloys	Fe-based	annealed	200	675	S1	● ●				
			hardened	280	943	S2	● ●				
		Ni or Co base	annealed	250	839	S3	● ●				
			hardened	350	1177	S4	● ●				
			cast	320	1076	S5	● ●				
	Titanium alloys	Pure titanium	200	675	S6	● ●					
		α and β alloys, hardened	375	1262	S7	● ●					
		β alloys	410	1396	S8	● ●					
	Tungsten alloys		300	1013	S9	● ●					
	Molybdenum alloys		300	1013	S10	● ●					
H	Hardened steel	hardened and tempered	50 HRC	-	H1	● ●					
		hardened and tempered	55 HRC	-	H2	● ●					
		hardened and tempered	60 HRC	-	H3	● ●					
	Hardened cast iron	hardened and tempered	55 HRC	-	H4	● ●					
O	Thermoplasts	without abrasive fillers			O1	● ●	400	400	400	400	
	Thermosetting plastics	without abrasive fillers			O2	● ●	300	300	300	300	
	Plastic, glass-fibre reinforced	GFRP			O3						
	Plastic, carbon-fibre reinforced	CFRP			O4						
	Plastic, aramid fibre reinforced	AFRP			O5						
	Graphite (technical)		80 Shore		O6	● ●					

- Recommended application (the specified cutting data are regarded as starting values for the recommended application).
- Possible application, reduce cutting data by 30–50 % (increase for ISO M approx. 70–80 %).

¹ The machining groups are assigned from H 8 onwards.

* $a_e / D_c = 1/10$, $v_c = 10$ % higher than 1/5.

Cutting data for roughing

Circular interpolation milling

(F2231, F2234, F2330, F2334, F3040, F4030, F4042, F4080, F4081)

Material group	Structure of main material groups and identification letters		Brinell hardness HB	Tensile strength R_m N/mm ²	Machining group ¹	= Cutting data for wet machining = Dry machining is possible		Cutting material grades				
								Starting values for cutting speed v_c [m/min]				
								HC				
								WKP35S		WKP35		
a_e / D_c^*		a_e / D_c^*		1/1		1/5						
				1/2		1/5						
P	Unalloyed steel	C ≤ 0,25 %	annealed	125	428	P1	●	●●	220	270	220	270
		C > 0,25 ... ≤ 0,55 %	annealed	190	639	P2	●	●●	200	230	200	230
		C > 0,25 ... ≤ 0,55 %	tempered	210	708	P3	●	●●	210	230	210	230
		C > 0,55 %	annealed	190	639	P4	●	●●	200	230	200	230
		C > 0,55 %	tempered	300	1013	P5	●	●●	140	160	140	160
		Free cutting steel (short-chipping)	annealed	220	745	P6	●	●●	190	220	190	220
	Low-alloyed steel		annealed	175	591	P7	●	●●	200	240	200	240
			tempered	300	1013	P8	●	●●	150	170	150	170
			tempered	380	1282	P9	●	●●	110	130	110	130
			tempered	430	1477	P10	●	●●	80	100	80	100
	High-alloyed steel and high-alloyed tool steel		annealed	200	675	P11	●	●●	120	140	120	140
			hardened and tempered	300	1013	P12	●	●●	80	90	80	90
			hardened and tempered	400	1361	P13	●	●●	70	80	70	80
	Stainless steel		ferritic / martensitic, annealed	200	675	P14	●	●●	120	140	120	140
			martensitic, tempered	330	1114	P15	●	●●	60	70	60	70
M	Stainless steel	austenitic, quench hardened	200	675	M1	●●	●					
		austenitic, precipitation hardened (PH)	300	1013	M2	●●	●					
		austenitic / ferritic, duplex	230	778	M3	●●	●					
K	Malleable cast iron	ferritic	200	675	K1	●	●●	110	120	110	120	
		pearlitic	260	867	K2	●	●●	130	160	130	160	
	Grey cast iron	low tensile strength	180	602	K3	●	●●	270	300	270	300	
		high tensile strength / austenitic	245	825	K4	●	●●	150	180	150	180	
	Cast iron with spheroidal graphite	ferritic	155	518	K5	●	●●	180	200	180	200	
		pearlitic	265	885	K6	●	●●	120	140	120	140	
	GGV (CGI)		200	675	K7	●	●●	120	150	120	150	
N	Aluminium wrought alloys	cannot be hardened	30	–	N1	●●						
		hardenable, hardened	100	343	N2	●●						
	Cast aluminium alloys	≤ 12 % Si, not hardenable	75	260	N3	●●						
		≤ 12 % Si, hardenable, hardened	90	314	N4	●●						
		> 12 % Si, cannot be hardened	130	447	N5	●●						
	Magnesium alloys		70	250	N6	●●						
	Copper and copper alloys (bronze / brass)	unalloyed, electrolytic copper	100	343	N7	●●						
		Brass, bronze, red brass	90	314	N8	●●						
		Cu-alloys, short-chipping	110	382	N9	●●						
		high-strength, Ampco	300	1013	N10	●●						
S	Heat-resistant alloys	Fe-based	annealed	200	675	S1	●●					
			hardened	280	943	S2	●●					
		Ni or Co base	annealed	250	839	S3	●●					
			hardened	350	1177	S4	●●					
			cast	320	1076	S5	●●					
	Titanium alloys	Pure titanium	200	675	S6	●●						
		α and β alloys, hardened	375	1262	S7	●●						
		β alloys	410	1396	S8	●●						
	Tungsten alloys		300	1013	S9	●●						
	Molybdenum alloys		300	1013	S10	●●						
H	Hardened steel	hardened and tempered	50 HRC	–	H1		●●					
		hardened and tempered	55 HRC	–	H2		●●					
		hardened and tempered	60 HRC	–	H3		●●					
	Hardened cast iron	hardened and tempered	55 HRC	–	H4		●●					
O	Thermoplasts	without abrasive fillers			O1	●●	●	300	300	300	300	
	Thermosetting plastics	without abrasive fillers			O2	●●	●	400	400	400	400	
	Plastic, glass-fibre reinforced	GFRP			O3							
	Plastic, carbon-fibre reinforced	CFRP			O4							
	Plastic, aramid fibre reinforced	AFRP			O5							
	Graphite (technical)		80 Shore		O6		●●					

- Recommended application (the specified cutting data are regarded as starting values for the recommended application).
- Possible application, reduce cutting data by 30–50 % (increase for ISO M approx. 70–80 %).

¹ The machining groups are assigned from H 8 onwards.

* $a_e / D_c = 1/10$, $v_c = 10$ % higher than 1/5.

The specified cutting data are average recommended values.
For special applications, adjustment is recommended.

Cutting material grades																	
Starting values for cutting speed v_c [m/min]																	
HC														HF		HW	
WKP25		WAK15		WSP45		WSM35		WKK25		WXN15		WMG40		WK10			
a_e / D_c^*		a_e / D_c^*		a_e / D_c^*		a_e / D_c^*		a_e / D_c^*		a_e / D_c^*		a_e / D_c^*		a_e / D_c^*			
1/1 1/2	1/5	1/1 1/2	1/5	1/1 1/2	1/5	1/1 1/2	1/5	1/1 1/2	1/5	1/1 1/2	1/5	1/1 1/2	1/5	1/1 1/2	1/5		
260	330			210	260												
230	300			170	220												
250	310			160	210												
230	300			170	220												
200	230			120	130												
220	290			160	210												
230	290			170	210												
190	230			125	150												
140	160			85	95												
110	130			60	65												
130	150			100	130												
110	130			75	90												
100	120			65	75												
				100	120	110	130										
				55	65	60	70										
				90	100	100	120										
				70	80	80	100										
				80	90	90	110										
130	140	150	160					140	150								
150	180	160	170					150	160								
190	310	340	370					330	360								
170	200	200	220					190	210								
200	220	230	250					220	240								
130	160	160	190					150	180								
140	170	150	170					140	160								
										2640	2640	1500	1500	2200	2200		
										1780	1780	900	900	1500	1500		
										600	660			500	540		
										480	480			400	400		
										240	280			200	230		
										480	480			400	400		
										180	200			150	160		
										240	280			200	230		
										180	200			150	160		
										240	280			200	230		
				60	65	70	80					67	72				
				40	45	55	60					40	45				
				45	50	55	65					50	55				
				27	32	35	40					22	27				
				35	40	45	50					30	35				
				65	80	80	100					70	80				
				40	45	50	55					45	50				
				35	40	45	50										
				40	45	50	55										
				35	40	45	50										
		45	55					45	55						35		
		45	55					45	55						35		
		45	55					45	55						35		
		300	300	300	300	300	300	300	300	300	300	300	300	300	300		
		400	400	400	400	400	400	400	400	400	400	400	400	400	400		
400	500	600	800					600	800	600	800			400	500		

HC = Coated carbide
HW = Uncoated carbide
HF = Uncoated fine-grained carbide

BH = CBN with high CBN content
BL = CBN with low CBN content
DP = polycrystalline diamond
CN = Silicon nitride Si₃N₄

Cutting data for roughing

Slot milling with side and face mills

Material group	Structure of main material groups and identification letters		Brinell hardness HB	Tensile strength R_m N/mm ²	Machining group ¹	= Cutting data for wet machining = Dry machining is possible		Cutting material grades	
								Starting values for cutting speed v_c (m/min)	
								HC WKP355	
						a_e / D_c			
						1/4*	1/10		
P	Unalloyed steel	C ≤ 0,25 %	annealed	125	428	P1	● ●●	195	250
		C > 0,25 ... ≤ 0,55 %	annealed	190	639	P2	● ●●	170	215
		C > 0,25 ... ≤ 0,55 %	tempered	210	708	P3	● ●●	160	205
		C > 0,55 %	annealed	190	639	P4	● ●●	160	200
		C > 0,55 %	tempered	300	1013	P5	● ●●	130	145
		Free cutting steel (short-chipping)	annealed	220	745	P6	● ●●	160	205
	Low-alloyed steel	annealed		175	591	P7	● ●●	170	215
		tempered		300	1013	P8	● ●●	125	145
		tempered		380	1282	P9	● ●●	85	95
		tempered		430	1477	P10	● ●●	80	90
	High-alloyed steel and high-alloyed tool steel	annealed		200	675	P11	● ●●	100	120
		hardened and tempered		300	1013	P12	● ●●	65	80
		hardened and tempered		400	1361	P13	● ●●	60	70
	Stainless steel	ferritic / martensitic, annealed		200	675	P14	● ●●	105	130
		martensitic, tempered		330	1114	P15	● ●●	60	85
M	Stainless steel	austenitic, quench hardened		200	675	M1	●● ●		
		austenitic, precipitation hardened (PH)		300	1013	M2	●● ●		
		austenitic / ferritic, duplex		230	778	M3	●● ●		
K	Malleable cast iron	ferritic		200	675	K1	● ●●	140	155
		pearlitic		260	867	K2	● ●●	135	145
	Grey cast iron	low tensile strength		180	602	K3	● ●●	160	180
		high tensile strength / austenitic		245	825	K4	● ●●	120	140
	Cast iron with spheroidal graphite	ferritic		155	518	K5	● ●●	140	150
		pearlitic		265	885	K6	● ●●	110	120
	GGV (CGI)		200	675	K7	● ●●	120	135	
N	Aluminium wrought alloys	cannot be hardened		30	–	N1	●●		
		hardenable, hardened		100	343	N2	●●		
	Cast aluminium alloys	≤ 12 % Si, not hardenable		75	260	N3	●●		
		≤ 12 % Si, hardenable, hardened		90	314	N4	●●		
		> 12 % Si, cannot be hardened		130	447	N5	●●		
	Magnesium alloys		70	250	N6	●●			
	Copper and copper alloys (bronze / brass)	unalloyed, electrolytic copper		100	343	N7	●●		
		Brass, bronze, red brass		90	314	N8	●●		
		Cu-alloys, short-chipping		110	382	N9	●●		
		high-strength, Ampco		300	1013	N10	●●		
S	Heat-resistant alloys	Fe-based	annealed	200	675	S1	●●		
			hardened	280	943	S2	●●		
		Ni or Co base	annealed	250	839	S3	●●		
			hardened	350	1177	S4	●●		
			cast	320	1076	S5	●●		
	Titanium alloys	Pure titanium		200	675	S6	●●		
		α and β alloys, hardened		375	1262	S7	●●		
		β alloys		410	1396	S8	●●		
	Tungsten alloys		300	1013	S9	●●			
	Molybdenum alloys		300	1013	S10	●●			
H	Hardened steel	hardened and tempered		50 HRC	–	H1	●●		
		hardened and tempered		55 HRC	–	H2	●●		
		hardened and tempered		60 HRC	–	H3	●●		
	Hardened cast iron	hardened and tempered		55 HRC	–	H4	●●		
O	Thermoplasts	without abrasive fillers				O1	●● ●	400	400
	Thermosetting plastics	without abrasive fillers				O2	●● ●	300	300
	Plastic, glass-fibre reinforced	GFRP				O3			
	Plastic, carbon-fibre reinforced	CFRP				O4			
	Plastic, aramid fibre reinforced	AFRP				O5			
	Graphite (technical)			80 Shore		O6	●●		

●● Recommended application (the specified cutting data are regarded as starting values for the recommended application).

● Possible application, reduce cutting data by 30–50 % (increase for ISO M approx. 70–80 %).

¹ The machining groups are assigned from H 8 onwards.

* $a_e = a_{e \max}$.

The specified cutting data are average recommended values.
For special applications, adjustment is recommended.

Cutting material grades																	
Starting values for cutting speed v_c [m/min]																	
HC																	
WKP35		WKP25		WAK25		WAK15		WSP45		WSM35		WKK25		WXN15		WK10	
a_e / D_c		a_e / D_c		a_e / D_c		a_e / D_c		a_e / D_c		a_e / D_c		a_e / D_c^*		a_e / D_c^*		a_e / D_c^*	
1/4*	1/10	1/4*	1/10	1/4*	1/10	1/4*	1/10	1/4*	1/10	1/4*	1/10	1/4*	1/10	1/4*	1/10	1/4*	1/10
195	250	210	285	200	270			185	230								
170	215	200	255	170	230			150	200								
160	205	185	230	160	210			135	170								
160	200	185	230	160	210			135	170								
130	145	165	200	135	180			105	125								
160	205	190	245	165	225			140	180								
170	215	200	255	170	230			150	190								
125	145	155	200	135	180			105	115								
85	95	125	140	100	130			75	85								
80	90	120	130	90	120			65	75								
100	120	110	145	100	130			90	110								
65	80	75	100	70	90			60	70								
60	70	70	90	60	80			55	65								
105	130			90	120			90	110	95	120						
60	85			60	90			60	80	65	85						
				120	150			85	100	100	120						
				100	130			70	85	85	100						
				100	140			75	90	90	110						
140	155	155	180	100	120	150	200					160	200				
135	145	100	155	95	110	120	170					110	170				
160	180	180	230	150	180	220	280					200	250				
120	140	130	150	135	160	160	180					145	165				
140	150	170	190	130	150	180	190					185	210				
110	120	110	150	110	130	150	160					120	165				
120	135	120	165			165	175					130	170				
														1800	1800	1500	1500
														1440	1440	1200	1200
														540	640	450	530
														430	430	360	360
														220	280	180	230
														430	430	360	360
														170	210	140	175
														280	280	230	230
														385	385	320	320
														150	190	120	160
								55	60	70	80						
								40	45	50	55						
								45	50	55	60						
								30	35	35	40						
								35	40	45	50						
								55	60	70	80						
								30	35	40	45						
								25	30	35	40						
								30	35	40	45						
								25	30	35	40						
						50	60					50	60			40	40
						40	50					40	50			35	35
						40	50					40	50			35	35
400	400					400	400	400	400	400	400	400	400	400	400	400	400
300	300					300	300	300	300	300	300	300	300	300	300	300	300
		400	500			600	800					600	800	600	800	400	500

HC = Coated carbide
HW = Uncoated carbide
HF = Uncoated fine-grained carbide

BH = CBN with high CBN content
BL = CBN with low CBN content
DP = polycrystalline diamond
CN = Silicon nitride Si_3N_4

Cutting data for roughing

Copy milling

Material group	Structure of main material groups and identification letters		Brinell hardness HB	Tensile strength R_m N/mm ²	Machining group ¹		Cutting material grades					
							Starting values for cutting speed v_c [m/min]					
							HC WKP35S a_e / D_c					
			1/1	1/5	1/10							
P	Unalloyed steel	C ≤ 0.25 %	annealed	125	428	P1	●	●●	240	300	300	
		C > 0.25 ... ≤ 0.55 %	annealed	190	639	P2	●	●●	200	255	275	
		C > 0.25 ... ≤ 0.55 %	tempered	210	708	P3	●	●●	185	240	240	
		C > 0.55 %	annealed	190	639	P4	●	●●	155	195	210	
		C > 0.55 %	tempered	300	1013	P5	●	●●	145	180	185	
		Free cutting steel (short-chipping)	annealed	220	745	P6	●	●●	200	255	275	
	Low-alloyed steel		annealed	175	591	P7	●	●●	165	210	230	
			tempered	300	1013	P8	●	●●	155	195	215	
			tempered	380	1282	P9	●	●●	145	180	200	
			tempered	430	1477	P10	●	●●	120	155	170	
	High-alloyed steel and high-alloyed tool steel		annealed	200	675	P11	●	●●	110	145	160	
			hardened and tempered	300	1013	P12	●	●●	75	100	100	
			hardened and tempered	400	1361	P13	●	●●	65	80	90	
	Stainless steel		ferritic / martensitic, annealed	200	675	P14	●	●●	120	155	170	
			martensitic, tempered	330	1114	P15	●	●●	110	145	155	
M	Stainless steel	austenitic, quench hardened	200	675	M1	●●	●					
		austenitic, precipitation hardened (PH)	300	1013	M2	●●	●					
		austenitic / ferritic, duplex	230	778	M3	●●	●					
K	Malleable cast iron	ferritic	200	675	K1	●	●●	250	290	310		
		pearlitic	260	867	K2	●	●●	200	240	260		
	Grey cast iron	low tensile strength	180	602	K3	●	●●	240	280	300		
		high tensile strength / austenitic	245	825	K4	●	●●	190	230	250		
	Cast iron with spheroidal graphite	ferritic	155	518	K5	●	●●	240	280	300		
		pearlitic	265	885	K6	●	●●	190	230	250		
GGV (CGI)		200	675	K7	●	●●	180	220	250			
N	Aluminium wrought alloys	cannot be hardened	30	–	N1	●●						
		hardenable, hardened	100	343	N2	●●						
	Cast aluminium alloys	≤ 12 % Si, not hardenable	75	260	N3	●●						
		≤ 12 % Si, hardenable, hardened	90	314	N4	●●						
		> 12 % Si, cannot be hardened	130	447	N5	●●						
	Magnesium alloys		70	250	N6	●●						
	Copper and copper alloys (bronze / brass)	unalloyed, electrolytic copper	100	343	N7	●●						
Brass, bronze, red brass		90	314	N8	●●							
Cu-alloys, short-chipping		110	382	N9	●●							
high-strength, Ampco		300	1013	N10	●●							
S	Heat-resistant alloys	Fe-based	annealed	200	675	S1	●●					
			hardened	280	943	S2	●●					
		Ni or Co base	annealed	250	839	S3	●●					
			hardened	350	1177	S4	●●					
			cast	320	1076	S5	●●					
	Titanium alloys	Pure titanium	200	675	S6	●●						
		α and β alloys, hardened	375	1262	S7	●●						
		β alloys	410	1396	S8	●●						
	Tungsten alloys		300	1013	S9	●●						
	Molybdenum alloys		300	1013	S10	●●						
H	Hardened steel	hardened and tempered	50 HRC	–	H1		●●					
		hardened and tempered	55 HRC	–	H2		●●					
		hardened and tempered	60 HRC	–	H3		●●					
	Hardened cast iron	hardened and tempered	55 HRC	–	H4		●●					
O	Thermoplasts	without abrasive fillers			O1	●●	●	400	450	500		
	Thermosetting plastics	without abrasive fillers			O2	●●	●	300	350	400		
	Plastic, glass-fibre reinforced	GFRP			O3							
	Plastic, carbon-fibre reinforced	CFRP			O4							
	Plastic, aramid fibre reinforced	AFRP			O5							
	Graphite (technical)		80 Shore		O6		●●					

- Recommended application (the specified cutting data are regarded as starting values for the recommended application).
- Possible application, reduce cutting data by 30–50 % (increase for ISO M approx. 70–80 %).

¹ The machining groups are assigned from H 8 onwards.

Cutting data for roughing

Copy milling

Material group	Structure of main material groups and identification letters		Brinell hardness HB	Tensile strength R_m N/mm ²	Machining group ¹		Cutting material grades				
							Starting values for cutting speed v_c [m/min]				
							HC WKK25 a_e / D_c				
			1/1	1/5	1/10						
P	Unalloyed steel	C ≤ 0,25 %	annealed	125	428	P1	●	●●			
		C > 0,25 ... ≤ 0,55 %	annealed	190	639	P2	●	●●			
		C > 0,25 ... ≤ 0,55 %	tempered	210	708	P3	●	●●			
		C > 0,55 %	annealed	190	639	P4	●	●●			
		C > 0,55 %	tempered	300	1013	P5	●	●●			
		Free cutting steel (short-chipping)	annealed	220	745	P6	●	●●			
	Low-alloyed steel		annealed	175	591	P7	●	●●			
			tempered	300	1013	P8	●	●●			
			tempered	380	1282	P9	●	●●			
			tempered	430	1477	P10	●	●●			
	High-alloyed steel and high-alloyed tool steel		annealed	200	675	P11	●	●●			
			hardened and tempered	300	1013	P12	●	●●			
			hardened and tempered	400	1361	P13	●	●●			
	Stainless steel		ferritic / martensitic, annealed	200	675	P14	●	●●			
			martensitic, tempered	330	1114	P15	●	●●			
M	Stainless steel	austenitic, quench hardened	200	675	M1	●●	●				
		austenitic, precipitation hardened (PH)	300	1013	M2	●●	●				
		austenitic / ferritic, duplex	230	778	M3	●●	●				
K	Malleable cast iron	ferritic	200	675	K1	●	●●	330	375	405	
		pearlitic	260	867	K2	●	●●	285	330	360	
	Grey cast iron	low tensile strength	180	602	K3	●	●●	315	360	375	
		high tensile strength / austenitic	245	825	K4	●	●●	270	315	330	
	Cast iron with spheroidal graphite	ferritic	155	518	K5	●	●●	315	360	375	
		pearlitic	265	885	K6	●	●●	270	315	330	
	GGV (CGI)		200	675	K7	●	●●	260	300	330	
N	Aluminium wrought alloys	cannot be hardened	30	–	N1	●●					
		hardenable, hardened	100	343	N2	●●					
	Cast aluminium alloys	≤ 12 % Si, not hardenable	75	260	N3	●●					
		≤ 12 % Si, hardenable, hardened	90	314	N4	●●					
		> 12 % Si, cannot be hardened	130	447	N5	●●					
	Magnesium alloys		70	250	N6	●●					
	Copper and copper alloys (bronze / brass)	unalloyed, electrolytic copper	100	343	N7	●●					
		Brass, bronze, red brass	90	314	N8	●●					
		Cu-alloys, short-chipping	110	382	N9	●●					
		high-strength, Ampco	300	1013	N10	●●					
S	Heat-resistant alloys	Fe-based	annealed	200	675	S1	●●				
			hardened	280	943	S2	●●				
		Ni or Co base	annealed	250	839	S3	●●				
			hardened	350	1177	S4	●●				
			cast	320	1076	S5	●●				
	Titanium alloys	Pure titanium	200	675	S6	●●					
		α and β alloys, hardened	375	1262	S7	●●					
		β alloys	410	1396	S8	●●					
	Tungsten alloys		300	1013	S9	●●					
	Molybdenum alloys		300	1013	S10	●●					
H	Hardened steel	hardened and tempered	50 HRC	–	H1		●●				
		hardened and tempered	55 HRC	–	H2		●●				
		hardened and tempered	60 HRC	–	H3		●●				
	Hardened cast iron	hardened and tempered	55 HRC	–	H4		●●				
O	Thermoplasts	without abrasive fillers			O1	●●	●	600	700	800	
	Thermosetting plastics	without abrasive fillers			O2	●●	●	500	600	700	
	Plastic, glass-fibre reinforced	GFRP			O3						
	Plastic, carbon-fibre reinforced	CFRP			O4						
	Plastic, aramid fibre reinforced	AFRP			O5						
	Graphite (technical)		80 Shore		O6		●●	500	600	700	

- Recommended application (the specified cutting data are regarded as starting values for the recommended application).
- Possible application, reduce cutting data by 30–50 % (increase for ISO M approx. 70–80 %).

¹ The machining groups are assigned from H 8 onwards.

The specified cutting data are average recommended values.
For special applications, adjustment is recommended.

Cutting material grades												
Starting values for cutting speed v_c [m/min]												
WCN15			HC			HF			HW			
a_e / D_c			a_e / D_c			a_e / D_c			a_e / D_c			
1/1	1/5	1/10	1/1	1/5	1/10	1/1	1/5	1/10	1/1	1/5	1/10	
				170	225	305						
				150	200	270						
				120	160	220						
				105	140	190						
				80	105	145						
				120	160	220						
				140	185	250						
				120	160	220						
				110	150	200						
				105	140	190						
				105	140	190						
				100	130	180						
				80	100	140						
				120	160	220						
				100	130	180						
				105	140	190						
				90	120	160						
				110	150	200						
				90	120	160						
				110	150	200						
				90	130	180						
				80	110	150						
	1920	1920	2110				1600	1600	1760	2000	2000	2200
	1440	1440	1630				1200	1200	1360	1500	1500	1700
	480	530	580				400	440	480	500	550	600
	385	385	420				320	320	350	400	400	440
	190	225	250				160	190	210	200	235	260
	480	530	580				400	440	480	500	550	600
	240	310	340				200	260	280	250	320	355
	260	325	360				220	270	300	270	340	375
	365	465	515				305	390	430	380	485	535
	210	280	340				170	230	280	190	260	320
							50	55	60			
							40	45	50			
							30	35	40			
							70	90	100			
							30	40	45			
							30	40	45			
							40	45	50			
							40	45	50			
				50	65	85						
				35	50	70						
				35	45	60						
				40	55	80						
	700	800	900	700	800	900	650	800	900	700	850	950
	580	735	810	600	700	800	550	700	800	600	765	840
	600	700	800	600	700	800						

HC = Coated carbide
HW = Uncoated carbide
HF = Uncoated fine-grained carbide

BH = CBN with high CBN content
BL = CBN with low CBN content
DP = polycrystalline diamond
CN = Silicon nitride Si_3N_4

Cutting data for semi-finishing and finishing

Copy milling

Material group	Structure of main material groups and identification letters		Brinell hardness HB	Tensile strength R_m N/mm ²	Machining group ¹		Cutting material grades					
							Starting values for cutting speed v_c [m/min]					
							HC WKP35S a_e / D_c^*					
			1/1	1/5	1/20							
P	Unalloyed steel	C ≤ 0,25 %	annealed	125	428	P1	●	●●	210	275	375	
		C > 0,25 ... ≤ 0,55 %	annealed	190	639	P2	●	●●	185	255	340	
		C > 0,25 ... ≤ 0,55 %	tempered	210	708	P3	●	●●	145	185	260	
		C > 0,55 %	annealed	190	639	P4	●	●●	120	165	220	
		C > 0,55 %	tempered	300	1013	P5	●	●●	90	120	160	
		Free cutting steel (short-chipping)	annealed	220	745	P6	●	●●	190	260	340	
	Low-alloyed steel		annealed	175	591	P7	●	●●	165	220	295	
			tempered	300	1013	P8	●	●●	145	185	260	
			tempered	380	1282	P9	●	●●	130	175	240	
			tempered	430	1477	P10	●	●●	120	165	220	
	High-alloyed steel and high-alloyed tool steel		annealed	200	675	P11	●	●●	130	175	240	
			hardened and tempered	300	1013	P12	●	●●	120	165	220	
			hardened and tempered	400	1361	P13	●	●●	90	120	160	
	Stainless steel		ferritic / martensitic, annealed	200	675	P14	●	●●	145	185	260	
			martensitic, tempered	330	1114	P15	●	●●	110	1745	200	
M	Stainless steel	austenitic, quench hardened	200	675	M1	●●	●					
		austenitic, precipitation hardened (PH)	300	1013	M2	●●	●					
		austenitic / ferritic, duplex	230	778	M3	●●	●					
K	Malleable cast iron	ferritic	200	675	K1	●	●●	170	230	290		
		pearlitic	260	867	K2	●	●●	140	200	250		
	Grey cast iron	low tensile strength	180	602	K3	●	●●	190	250	300		
		high tensile strength / austenitic	245	825	K4	●	●●	140	200	250		
	Cast iron with spheroidal graphite	ferritic	155	518	K5	●	●●	190	250	300		
		pearlitic	265	885	K6	●	●●	150	210	260		
GGV (CGI)		200	675	K7	●	●●	130	190	240			
N	Aluminium wrought alloys	cannot be hardened	30	–	N1	●●						
		hardenable, hardened	100	343	N2	●●						
	Cast aluminium alloys	≤ 12 % Si, not hardenable	75	260	N3	●●						
		≤ 12 % Si, hardenable, hardened	90	314	N4	●●						
		> 12 % Si, cannot be hardened	130	447	N5	●●						
	Magnesium alloys		70	250	N6	●●						
	Copper and copper alloys (bronze / brass)	unalloyed, electrolytic copper	100	343	N7	●●						
Brass, bronze, red brass		90	314	N8	●●							
Cu-alloys, short-chipping		110	382	N9	●●							
high-strength, Ampco		300	1013	N10	●●							
S	Heat-resistant alloys	Fe-based	annealed	200	675	S1	●●					
			hardened	280	943	S2	●●					
		Ni or Co base	annealed	250	839	S3	●●					
			hardened	350	1177	S4	●●					
			cast	320	1076	S5	●●					
	Titanium alloys	Pure titanium	200	675	S6	●●						
		α and β alloys, hardened	375	1262	S7	●●						
		β alloys	410	1396	S8	●●						
	Tungsten alloys		300	1013	S9	●●						
	Molybdenum alloys		300	1013	S10	●●						
H	Hardened steel	hardened and tempered	50 HRC	–	H1		●●					
		hardened and tempered	55 HRC	–	H2		●●					
		hardened and tempered	60 HRC	–	H3		●●					
	Hardened cast iron	hardened and tempered	55 HRC	–	H4		●●					
O	Thermoplasts	without abrasive fillers			O1	●●	●	450	500	550		
	Thermosetting plastics	without abrasive fillers			O2	●●	●	350	400	450		
	Plastic, glass-fibre reinforced	GFRP			O3							
	Plastic, carbon-fibre reinforced	CFRP			O4							
	Plastic, aramid fibre reinforced	AFRP			O5							
	Graphite (technical)		80 Shore		O6		●●					

●● Recommended application (the specified cutting data are regarded as starting values for the recommended application).

● Possible application, reduce cutting data by 30–50 % (increase for ISO M approx. 70–80 %).

¹ The machining groups are assigned from H 8 onwards.

* $a_e / D_c = 1/50$, $v_c = 40$ % higher than 1/20.

Cutting data for semi-finishing and finishing

Copy milling

Material group	Structure of main material groups and identification letters		Brinell hardness HB	Tensile strength R_m N/mm ²	Machining group ¹		Cutting material grades				
							Starting values for cutting speed v_c [m/min]				
							HC WKK25 a_e / D_c^*				
			1/1	1/5	1/20						
P	Unalloyed steel	C ≤ 0,25 %	annealed	125	428	P1	●	●●			
		C > 0,25 ... ≤ 0,55 %	annealed	190	639	P2	●	●●			
		C > 0,25 ... ≤ 0,55 %	tempered	210	708	P3	●	●●			
		C > 0,55 %	annealed	190	639	P4	●	●●			
		C > 0,55 %	tempered	300	1013	P5	●	●●			
		Free cutting steel (short-chipping)	annealed	220	745	P6	●	●●			
	Low-alloyed steel		annealed	175	591	P7	●	●●			
			tempered	300	1013	P8	●	●●			
			tempered	380	1282	P9	●	●●			
			tempered	430	1477	P10	●	●●			
	High-alloyed steel and high-alloyed tool steel		annealed	200	675	P11	●	●●			
			hardened and tempered	300	1013	P12	●	●●			
			hardened and tempered	400	1361	P13	●	●●			
	Stainless steel		ferritic / martensitic, annealed	200	675	P14	●	●●			
			martensitic, tempered	330	1114	P15	●	●●			
M	Stainless steel	austenitic, quench hardened	200	675	M1	●●	●				
		austenitic, precipitation hardened (PH)	300	1013	M2	●●	●				
		austenitic / ferritic, duplex	230	778	M3	●●	●				
K	Malleable cast iron	ferritic	200	675	K1	●	●●	250	340	430	
		pearlitic	260	867	K2	●	●●	225	280	375	
	Grey cast iron	low tensile strength	180	602	K3	●	●●	270	360	450	
		high tensile strength / austenitic	245	825	K4	●	●●	225	280	375	
	Cast iron with spheroidal graphite	ferritic	155	518	K5	●	●●	270	360	450	
		pearlitic	265	885	K6	●	●●	230	280	410	
GGV (CGI)		200	675	K7	●	●●	210	270	360		
N	Aluminium wrought alloys	cannot be hardened	30	–	N1	●●					
		hardenable, hardened	100	343	N2	●●					
	Cast aluminium alloys	≤ 12 % Si, not hardenable	75	260	N3	●●					
		≤ 12 % Si, hardenable, hardened	90	314	N4	●●					
		> 12 % Si, cannot be hardened	130	447	N5	●●					
	Magnesium alloys		70	250	N6	●●					
	Copper and copper alloys (bronze / brass)	unalloyed, electrolytic copper	100	343	N7	●●					
		Brass, bronze, red brass	90	314	N8	●●					
		Cu-alloys, short-chipping	110	382	N9	●●					
		high-strength, Ampco	300	1013	N10	●●					
S	Heat-resistant alloys	Fe-based	annealed	200	675	S1	●●				
			hardened	280	943	S2	●●				
		Ni or Co base	annealed	250	839	S3	●●				
			hardened	350	1177	S4	●●				
			cast	320	1076	S5	●●				
	Titanium alloys	Pure titanium	200	675	S6	●●					
		α and β alloys, hardened	375	1262	S7	●●	35	45	60		
		β alloys	410	1396	S8	●●					
	Tungsten alloys		300	1013	S9	●●					
	Molybdenum alloys		300	1013	S10	●●					
H	Hardened steel	hardened and tempered	50 HRC	–	H1		●●				
		hardened and tempered	55 HRC	–	H2		●●				
		hardened and tempered	60 HRC	–	H3		●●				
	Hardened cast iron	hardened and tempered	55 HRC	–	H4		●●				
O	Thermoplasts	without abrasive fillers			O1	●●	●	700	800	900	
	Thermosetting plastics	without abrasive fillers			O2	●●	●	600	700	800	
	Plastic, glass-fibre reinforced	GFRP			O3						
	Plastic, carbon-fibre reinforced	CFRP			O4						
	Plastic, aramid fibre reinforced	AFRP			O5						
	Graphite (technical)		80 Shore		O6		●●	600	700	900	

●● Recommended application (the specified cutting data are regarded as starting values for the recommended application).

● Possible application, reduce cutting data by 30–50 % (increase for ISO M approx. 70–80 %).

¹ The machining groups are assigned from H 8 onwards.

* $a_e / D_c = 1/50$, $v_c = 40$ % higher than 1/20.

Feed determination (starting values) Face / shoulder mill

Mill type	F 2010 / F 4080	F 2146	F 2010 / F 2233	F 2010 / F 4033				
<p>Feed per tooth f_{z0} for $a_e = D_c$ $a_p = a_{p \max} = L_c$</p>	<p>Xtra-tec®</p>			<p>Xtra-tec®</p>				
Approach angle κ	43°	43°	45°	45°				
Page	F 130	F 96	F 98	F 118				
Material group	f_{z0} [mm]		f_{z0} [mm]		f_{z0} [mm]			
	F 4080	F 2010 / F 4080		F 2233	F 2010 / F 2233			
	32–125	50–315	80–250	20–80	25–315	40–315 50–315		
Maximum cutting data $a_{p \max} = L_c$ [mm]	3/8	4/10	3	5	7	6 9		
P	Unalloyed steel ¹	0,45	0,45	0,25	0,20	0,25	0,25	0,40
	Low-alloyed steel	0,40	0,40	0,20	0,15	0,20	0,20	0,35
	High-alloyed steel and tool steel	0,30	0,30	0,20	0,15	0,20	0,20	0,30
	Stainless steel	0,20	0,20	0,20	0,12	0,15	0,15	0,20
M	Stainless steel ²	0,15	0,15		0,10	0,12	0,12	0,15
K	Malleable cast iron	0,40	0,40	0,30	0,20	0,25	0,25	0,30
	Grey cast iron	0,50	0,50	0,35	0,25	0,30	0,30	0,50
	Cast iron with spheroidal graphite	0,40	0,40	0,30	0,20	0,25	0,25	0,40
	GGV (CGI)	0,25	0,25	0,20	0,18	0,20	0,20	0,25
N	Aluminium wrought alloys	0,25	0,25	0,12	0,12	0,15	0,15	
	Cast aluminium alloys	0,20	0,20	0,12	0,12	0,15	0,15	
	Magnesium alloys	0,15	0,15	0,10	0,10	0,12	0,12	
	Copper and copper alloys (bronze / brass)	0,15	0,15	0,10	0,10	0,12	0,12	
S	Heat-resistant alloys	0,15	0,15		0,10	0,12	0,12	0,15
	Titanium alloys	0,15	0,15		0,10	0,12	0,12	0,15
	Tungsten alloys	0,15	0,15		0,10	0,12	0,12	0,15
	Molybdenum alloys	0,15	0,15		0,10	0,12	0,12	0,15
H	Hardened steel							
	Hardened cast iron							
O	Thermoplasts	0,20	0,20		0,10	0,15	0,15	0,20
	Plastic, carbon-fibre reinforced							
	Graphite (technical)	0,15	0,15		0,10	0,15	0,15	0,20
Insert types	OD..0504..	OD..0605..	OP..0504..	SD..09T3..	SP..1204..	SN..X 120512.. SN..X 120520.. SN..X 1205ANN	SNMX 160620.. SNMX 160640.. SNGX 1606ANN	
Correction factor K_{a_e} for the feed per tooth depending on the ratio of cut width a_e to cutter diameter D_c	$a_e / D_c = 1/1 - 1/2$	1,0	1,0	1,0	1,0	1,0	1,0	1,0
	1/5	1,1	1,1	1,1	1,1	1,1	1,1	1,1
	1/10	1,2	1,2	1,2	1,2	1,2	1,2	1,2
	1/20	1,3	1,3	1,3	1,3	1,3	1,3	1,3
	1/50							
Correction factor K_{a_p} for the feed per tooth depending on the cutting depth a_p	$a_p = 1$	1,0	1,0					
	2	1,0	1,0					
	3	1,0	1,0					
	4	0,6	1,0					
	6	0,6	0,6					
$f_z = f_{z0} \cdot K_{a_e} \cdot K_{a_p}$	8	0,6	0,6					
	$a_{p \max} = L_c$	0,6	0,6					

¹ and cast steel

² and austenitic / ferritic

The specified feed rates are average recommended values.
For special applications, adjustment is recommended.

F 4045		F 2260		F 2265		F 2010 / F 2235		F 2010 / F 4047		F 2010 / F 4048	
Xtra-tec®								Xtra-tec®		Xtra-tec®	
45°		60°		60°		75°		75°		88°	
F 122		F 110		F 112		F 102		F 126		F 128	
f _{Z0} [mm]		f _{Z0} [mm]		f _{Z0} [mm]		f _{Z0} [mm]		f _{Z0} [mm]		f _{Z0} [mm]	
63-200 80-200		100-315 125-315		125-315 200-315		32-315		40-315		40-315	
4 6		11 15		12 20		10		8		10	
		0,60 0,60		0,60 1,00		0,25		0,22		0,20	
		0,45 0,50		0,50 0,80		0,20		0,20		0,18	
				0,40 0,50		0,20		0,20		0,18	
				0,40 0,40		0,20		0,15		0,12	
				0,30 0,30		0,15		0,12		0,10	
0,25 0,30		0,80 0,80		0,80 0,80		0,25		0,22		0,20	
0,30 0,50		1,00 1,00		1,00 1,00		0,30		0,25		0,22	
0,25 0,40		0,80 0,80		0,80 0,80		0,25		0,22		0,20	
0,20 0,25		0,35 0,40		0,35 0,35		0,20		0,20		0,18	
						0,20					
						0,18					
						0,15					
						0,15					
						0,10		0,10		0,08	
						0,10		0,10		0,08	
						0,10		0,10		0,08	
						0,10		0,10		0,08	
		0,30 0,40		0,30 0,40		0,15		0,15		0,15	
		0,30 0,40		0,30 0,40		0,15		0,15		0,15	
XNHF 0705 ..		LNMF 1508 ..		LNMF 2010 ..		LNMF 2010 ..		SN . X 120512 .. SN . X 120520 .. SN . X 1205ENN		SN . X 120512 .. SN . X 120520 .. SN . X 1205ZNN	
XNHF 0906 ..		LNMF 2010 ..		LNKF 3010 ..		SP .. 1204 ..		1,0		1,0	
1,0		1,0		1,0		1,0		1,0		1,0	
1,1		1,1		1,1		1,1		1,1		1,1	
1,2		1,2		1,2		1,2		1,2		1,2	
1,3		1,3		1,3		1,3		1,3		1,3	

Feed determination (starting values) Face / shoulder mill

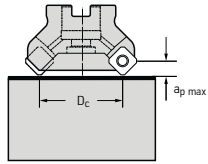
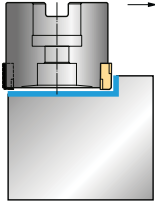
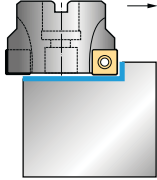
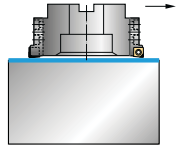
Mill type		F 2254	F 2010 / F 2241			F 2250	
Feed per tooth f_{z0} for $a_e = D_c$ $a_p = a_{p \max} = L_c$ 							
Approach angle κ		89°	89° 45'			75° + 90°	
Page		F 108	F 138			F 104	
Material group	f_{z0} [mm]		f_{z0} [mm]			f_{z0} [mm]	
	Tool \emptyset or \emptyset range [mm]	50–160	F 2241 16–40	F 2241 25–160	F 2010 F 2241 32–315	63–200	
	Maximum cutting data $a_{p \max} = L_c$ [mm]	7	6	9	12	3/4	
P	Unalloyed steel ¹	0,15	0,10	0,15	0,20		
	Low-alloyed steel	0,10	0,08	0,12	0,15		
	High-alloyed steel and tool steel	0,10	0,08	0,12	0,15		
	Stainless steel	0,08	0,06	0,10	0,12		
M	Stainless steel ²		0,06	0,08	0,10		
K	Malleable cast iron	0,10	0,10	0,15	0,20		
	Grey cast iron	0,15	0,12	0,20	0,25		
	Cast iron with spheroidal graphite	0,15	0,10	0,15	0,20		
	GGV (CGI)	0,08	0,08	0,10	0,15		
N	Aluminium wrought alloys		0,10	0,12	0,15	0,15	
	Cast aluminium alloys		0,10	0,12	0,15	0,15	
	Magnesium alloys		0,08	0,10	0,12	0,15	
	Copper and copper alloys (bronze / brass)		0,08	0,10	0,12	0,10	
S	Heat-resistant alloys		0,06	0,10	0,10		
	Titanium alloys		0,06	0,10	0,10		
	Tungsten alloys		0,06	0,10	0,10		
	Molybdenum alloys		0,06	0,10	0,10		
H	Hardened steel						
	Hardened cast iron						
O	Thermoplasts		0,07	0,10	0,15		
	Plastic, carbon-fibre reinforced						
	Graphite (technical)		0,07	0,10	0,15		
Insert types		SNHQ 1205...	SP...0603..	SP...09T3..	SP...1204..	SPHW 1204... WCD10	
Correction factor K_{a_e}							
for the feed per tooth depending on the ratio of cut width a_e to cutter diameter D_c		$a_e / D_c =$					
		1/1 – 1/2	1,0	1,0	1,0	1,0	
		1/5	1,4	1,1	1,1	1,1	
		1/10	1,5	1,2	1,2	1,2	
		1/20	1,8	1,3	1,3	1,3	
$f_z = f_{z0} \cdot K_{a_e}$		1/50	2,0				

¹ and cast steel

² and austenitic / ferritic

The specified feed rates are average recommended values.
For special applications, adjustment is recommended.

F 3040		F 2010 / F 4041		F 2010 / F 4042				
90°		90°		90°				
F 140		F 142		F 144				
f _{Z0} (mm)		f _{Z0} (mm)		f _{Z0} (mm)				
				F 4042	F 4042R	F 2010 F 4042	F 2010 F 4042	F 4042
25–63	32–63	40–315		10–50	16–63	25–315	40–315	50–160
15	20	13		8	10	11.7	15	16.7
		0.20		0.15	0.18	0.20	0.25	0.30
		0.15		0.10	0.12	0.15	0.18	0.22
		0.15		0.10	0.12	0.15	0.18	0.22
		0.12		0.08	0.10	0.12	0.15	0.18
0.10	0.10	0.10		0.08	0.08	0.10	0.12	0.14
0.20	0.20	0.20		0.12	0.18	0.20	0.25	0.30
0.25	0.25	0.25		0.15	0.20	0.25	0.30	0.40
0.20	0.20	0.20		0.12	0.15	0.20	0.25	0.30
0.20	0.20	0.15		0.10	0.12	0.15	0.18	0.20
0.15	0.20	0.12		0.10	0.12	0.12	0.15	
0.12	0.15	0.15		0.12	0.15	0.15	0.15	
0.12	0.12	0.12		0.10	0.12	0.12	0.15	
0.10	0.10	0.10		0.08	0.10	0.10	0.12	
0.12	0.12	0.12		0.08	0.10	0.12	0.15	0.18
0.12	0.12	0.12		0.08	0.10	0.12	0.15	0.18
0.12	0.12	0.12		0.08	0.10	0.12	0.15	0.18
0.12	0.12	0.12		0.08	0.10	0.12	0.15	0.18
0.15	0.15	0.15		0.12	0.15	0.17	0.20	0.20
0.12	0.12	0.12		0.10	0.12	0.15	0.15	0.15
ZDGT 1504 ..	ZDGT 2005 ..	LNGX 1307 ..		AD .. 0803 ..	AD .. 10T3 ..	AD .. 1204 ..	AD .. T 1606 ..	AD .. T 1807 ..
1.0	1.0	1.0		1.0	1.0	1.0	1.0	1.0
1.1	1.1	1.1		1.1	1.1	1.1	1.1	1.1
1.2	1.2	1.2		1.2	1.2	1.2	1.2	1.2
1.3	1.3	1.3		1.3	1.3	1.3	1.3	1.3

Feed determination (starting values) HPC milling cutter

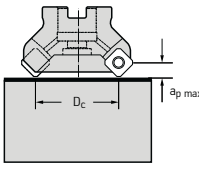
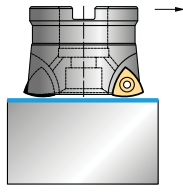
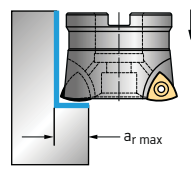
Mill type		F 2010 / F 2330			F 2330		
Feed per tooth f_{z0} for $a_e = D_c$ $a_p = a_{p \max} = L_c$ 		 for face milling operations			 for plunging		
Approach angle κ		0–15°			0–15°		
Page		F 114			F 114		
Material group		f_{z0} (mm)			f_{z0} (mm)		
		F 2330	F 2330	F 2010 F 2330			
	Tool \emptyset or \emptyset range (mm)	20–25	32–85	52–315	20–25	32–85	52–85
	Maximum cutting data $a_{p \max} = L_c$ (mm)	1.0	1.5	2.0	$a_{r \max} = 7$ mm	$a_{r \max} = 10$ mm	$a_{r \max} = 15$ mm
P	Unalloyed steel ¹	1.20	1.60	2.00	0.18	0.25	0.30
	Low-alloyed steel	1.00	1.40	1.80	0.16	0.22	0.25
	High-alloyed steel and tool steel	0.70	1.00	1.20	0.12	0.16	0.22
	Stainless steel	0.50	0.60	0.80	0.10	0.12	0.15
M	Stainless steel ²	0.50	0.60	0.80	0.10	0.12	0.15
	Malleable cast iron	1.00	1.40	1.80	0.16	0.22	0.28
K	Grey cast iron	1.20	1.60	2.00	0.18	0.25	0.30
	Cast iron with spheroidal graphite	1.00	1.40	1.80	0.16	0.22	0.28
	GGV (CGI)	1.00	1.40	1.80	0.16	0.22	0.28
N	Aluminium wrought alloys						
	Cast aluminium alloys						
	Magnesium alloys						
	Copper and copper alloys (bronze / brass)						
S	Heat-resistant alloys	0.50	0.60	0.80	0.08	0.10	0.12
	Titanium alloys	0.50	0.60	0.80	0.08	0.10	0.12
	Tungsten alloys	0.50	0.60	0.80	0.08	0.10	0.12
	Molybdenum alloys	0.50	0.60	0.80	0.08	0.10	0.12
H	Hardened steel						
	Hardened cast iron						
O	Thermoplasts	0.30	0.40	0.50	0.12	0.15	0.20
	Plastic, carbon-fibre reinforced						
	Graphite (technical)	0.50	0.60	0.80	0.10	0.12	0.15
Insert types		P2633 . -R10 P26379-R10	P2633 . -R14 P26379-R14	P2633 . -R25 P26379-R25	P2633 . -R10 P26379-R10	P2633 . -R14 P26379-R14	P2633 . -R25 P26379-R25
Correction factor K_{a_e}		$a_e / D_c = 1/1 - 1/2$					
		1.0					
		1.4					
for the feed per tooth depending on the ratio of cut width a_e to cutter diameter D_c		$1/5$					
		1.4					
		1.8					
		$1/10$					
		1.8					
		$1/20$					
		1.8					
		$1/50$					
		1.8					
Correction factor K_{a_p}		$a_p = 0.5$					
		1.3					
		1.4					
for the feed per tooth depending on the cutting depth a_p		1.0					
		1.0					
		1.2					
		1.5					
		1.0					
		1.2					
		2.0					
		1.0					
Correction factor K		$1 < (L : D_c) = \leq 2$					
		1.4					
		1.4					
		1.4					
		1.0					
		1.0					
		1.0					
		0.7					
		0.7					
		0.7					
$f_z = f_{z0} \cdot K_{a_e} \cdot K_{a_p} \cdot K$		$4 < (L : D_c) = \leq 6$					
		0.7					
		0.7					
		0.7					
		0.5					
		0.5					
		0.5					

¹ and cast steel

² and austenitic / ferritic

The specified feed rates are average recommended values.
For special applications, adjustment is recommended.

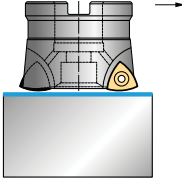
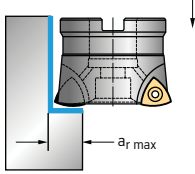
F 4030		F 4030	
 for face milling operations Xtra-tec®		 for plunging Xtra-tec®	
0–21° F 116		0–21° F 116	
f _{Z0} [mm]		f _{Z0} [mm]	
25–63	50–100	25–63	50–100
1.0	2.0	a _{r max} = 7 mm	a _{r max} = 10 mm
1.60	2.00	0.25	0.30
1.40	1.80	0.22	0.25
1.00	1.20	0.16	0.22
0.60	0.80	0.12	0.15
0.60	0.80	0.12	0.15
1.60	1.80	0.25	0.28
1.40	2.00	0.22	0.30
1.40	1.80	0.22	0.28
1.40	1.80	0.22	0.28
0.60	0.80	0.10	0.12
0.60	0.80	0.10	0.12
0.60	0.80	0.10	0.12
0.60	0.80	0.10	0.12
0.40	0.50	0.15	0.20
0.60	0.80	0.12	0.15
P23696-1.0	P23696-2.0	P23696-1.0	P23696-2.0
1.0	1.0		
1.4	1.3		
1.8	1.6		
1.4	1.5		
1.2	1.4		
1.0	1.2		
	1.0		
1.4	1.4	1.0	1.0
1.0	1.0	0.7	0.7
0.7	0.7	0.5	0.5

Feed determination (start values)

Shoulder mill – porcupine cutter, full effective teeth

Mill type		F 2338F	F 4038	
<p>Feed per tooth f_{z0} for $a_e = D_c$ $a_p = a_{p\ max} = L_c$</p>			<p>Xtra-tec®</p>	
Approach angle κ		90°	90°	
Page		F 160	F 162	
Material group	f_{z0} [mm]			
	Tool \emptyset or \emptyset range [mm]	63–100	20–32	
	Maximum cutting data $a_{p\ max} = L_c$ [mm]	48–103	15–37	
P	Unalloyed steel ¹	0,30	0,15	
	Low-alloyed steel	0,25	0,10	
	High-alloyed steel and tool steel	0,20	0,10	
	Stainless steel	0,15	0,08	
M	Stainless steel ²	0,15	0,08	
K	Malleable cast iron	0,40	0,15	
	Grey cast iron	0,30	0,12	
	Cast iron with spheroidal graphite	0,30	0,12	
	GGV (CGI)	0,30	0,12	
N	Aluminium wrought alloys		0,12	
	Cast aluminium alloys		0,10	
	Magnesium alloys		0,10	
	Copper and copper alloys (bronze / brass)		0,10	
S	Heat-resistant alloys	0,12	0,08	
	Titanium alloys	0,12	0,08	
	Tungsten alloys	0,12	0,08	
	Molybdenum alloys	0,12	0,08	
H	Hardened steel			
	Hardened cast iron			
O	Thermoplasts		0,1	
	Plastic, carbon-fibre reinforced			
	Graphite (technical)		0,1	
Insert types		SP..1506.. LP..1506..	AD..0803..	
Correction factor K_{a_e} for the feed per tooth depending on the ratio of cut width a_e to cutter diameter D_c	$a_e / D_c = 1/2$	1,0**	1,0**	
	1/5	1,1	1,1	
	1/10	1,2	1,2	
	1/20	1,3	1,3	
	1/50		1,5	
Correction factor K_{a_p} for the feed per tooth depending on the cutting depth a_p	$a_p = 6$	1,0	1,0	
	9	1,0	1,0	
	12	1,0	1,0	
	$0,5 \times D_c$	1,0	1,0	
	$0,75 \times D_c$	0,8	0,8	
$f_z = f_{z0} \cdot K_{a_e} \cdot K_{a_p}$	$1 \times D_c$	0,7	0,7	
	$a_{p\ max} = L_c$	0,5*	0,5*	

¹ and cast steel

² and austenitic / ferritic

 * only possible if $a_e / D_c < 1/5$

 ** only possible if $a_p < 0,75 \times D_c$

The specified feed rates are average recommended values.
For special applications, adjustment is recommended.

	F 4138	F 4238	F 4338
	Xtra-tec®	Xtra-tec®	Xtra-tec®
	90°	90°	90°
	F 164	F 166	F 168
	f_{z0} [mm]	f_{z0} [mm]	f_{z0} [mm]
	32–80	40–85	63–125
	33–76	29–112	31–124
	0.20	0.25	0.25
	0.15	0.20	0.20
	0.15	0.18	0.20
	0.12	0.12	0.15
	0.10	0.12	0.15
	0.25	0.28	0.30
	0.20	0.22	0.25
	0.20	0.22	0.25
	0.20	0.22	0.25
	0.15	0.15	
	0.12	0.12	
	0.12	0.12	
	0.12	0.12	
	0.12	0.12	0.12
	0.12	0.12	0.12
	0.12	0.12	0.12
	0.12	0.12	0.12
	0.15	0.15	0.15
	0.12	0.15	0.15
	AD .. 1204 ..	AD .. 1606 ..	AD .. 1807 ..
	1,0**	1,0**	1,0*
	1,1	1,1	1,1
	1,2	1,2	1,2
	1,3	1,3	1,3
	1,5	1,5	1,5
	1,0	1,0	1,0
	1,0	1,0	1,0
	1,0	1,0	1,0
	1,0	1,0	1,0
	0,8	0,8	0,8
	0,7	0,7	0,7
	0,5*	0,5*	0,5*

Feed determination (starting values) Slot mill

Mill type		F 2237			
Approach angle κ		90°			
Page		F 174			
Material group		f_{z0} (mm)			
	Tool \emptyset or \emptyset range (mm)	18–20	25–32	40	
	Maximum cutting data $a_{p \max} = L_c$ (mm)	7+13	14+22	25	
P	Unalloyed steel ¹	0,10*	0,15*	0,20*	
	Low-alloyed steel	0,08*	0,12*	0,15*	
	High-alloyed steel and tool steel	0,08*	0,12*	0,15*	
	Stainless steel	0,06*	0,08*	0,12*	
M	Stainless steel ²	0,06*	0,08*	0,10*	
K	Malleable cast iron	0,12*	0,20*	0,25*	
	Grey cast iron	0,10*	0,15*	0,20*	
	Cast iron with spheroidal graphite	0,10*	0,15*	0,20*	
	GGV (CGI)	0,10*	0,15*	0,20*	
N	Aluminium wrought alloys	0,10*	0,12*	0,12*	
	Cast aluminium alloys	0,08*	0,10*	0,10*	
	Magnesium alloys	0,10*	0,12*	0,12*	
	Copper and copper alloys (bronze / brass)	0,08*	0,10*	0,10*	
S	Heat-resistant alloys	0,06*	0,10*	0,10*	
	Titanium alloys	0,06*	0,10*	0,10*	
	Tungsten alloys	0,06*	0,10*	0,10*	
	Molybdenum alloys	0,06*	0,10*	0,10*	
H	Hardened steel				
	Hardened cast iron				
O	Thermoplasts	0,07	0,10	0,10	
	Plastic, carbon-fibre reinforced				
	Graphite (technical)	0,07	0,10	0,10	
Insert types		SP .. 0603 .. LP .. 0703 ..	SP .. 09T3 .. LP .. 15T3 ..	SP .. 09T3 .. SP .. 1204 .. LP .. 1504 ..	
Correction factor K_{a_e}	for the feed per tooth depending on the ratio of cut width a_e to cutter diameter D_c	$a_e / D_c = 1/1 - 1/2$	1,0	1,0	1,0
		1/5	1,1	1,1	1,1
		1/10	1,2	1,2	1,2
		1/20	1,3	1,3	1,3
Correction factor K_{a_p}	for the feed per tooth depending on the cutting depth a_p	1/50			
		$a_p = 6$			
		9			
		12			
$f_z = f_{z0} \cdot K_{a_e} \cdot K_{a_p}$	$0,5 \times D_c$				
	$0,75 \times D_c$				
	$1 \times D_c$				
	$a_{p \max} = L_c$				

¹ and cast steel

² and austenitic / ferritic

 * only possible if $a_p < 0,75 \times D_c$

 ** only with $a_e / D_c < 1/5$

The specified feed rates are average recommended values.
For special applications, adjustment is recommended.

		F 2238		F 2238 CE / CK		F 2338	
		90°		90°		90°	
		F 176		F 178		F 184	
		f _{Z0} [mm]		f _{Z0} [mm]		f _{Z0} [mm]	
	20–32	40–65	80–125	63–80	63–100		
	22–42	50	67–87	56–117	46–100		
	0,10	0,15	0,20	0,20	0,30		
	0,08	0,12	0,15	0,15	0,25		
	0,08	0,12	0,15	0,15	0,20		
	0,06	0,08	0,12	0,10	0,15		
	0,06	0,08	0,10	0,10	0,15		
	0,12	0,20	0,25	0,25	0,40		
	0,10	0,15	0,20	0,20	0,30		
	0,10	0,15	0,20	0,20	0,30		
	0,10	0,15	0,20	0,20	0,30		
	0,10	0,12	0,12	0,12			
	0,08	0,10	0,10	0,10			
	0,10	0,12	0,12	0,12			
	0,08	0,10	0,10	0,10			
	0,06	0,10	0,10	0,10	0,12		
	0,06	0,10	0,10	0,10	0,12		
	0,06	0,10	0,10	0,10	0,12		
	0,06	0,10	0,10	0,10	0,12		
	0,07	0,1	0,15	0,15	0,15		
	0,07	0,1	0,15	0,15	0,15		
	SP...0603... LP...0703...	SP...09T3... LP...15T3...	SP...1204... LP...1504...	SP...1204... LP...1504...	SP...1506... LP...1506...		
	1,0	1,0	-	1,0	1,0		
	1,1	1,1	1,1	1,1	1,1		
	1,2	1,2	1,2	1,2	1,2		
	1,3	1,3	1,3	1,3	1,3		
	1,6	1,6	1,6	1,0	1,0		
	1,0	1,6	1,6	1,0	1,0		
	1,0	1,6	1,6	1,0	1,0		
	1,0	1,0	1,0	1,0	1,0		
	0,8	0,8	0,8	0,8	0,8		
	0,7	0,7	0,7	0,7	0,7		
	0,5**	0,5**	0,5**	0,5**	0,5**		

Feed determination (starting values) Side and face mill

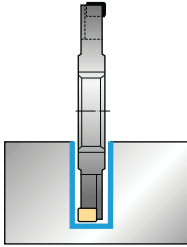
Mill type		F 2252					
Feed per tooth f_{z0} for plunging, central positioning		 <p>full side and face milling</p>					
Approach angle κ		90°					
Page		F 186					
Material group		f_{z0} (mm)					
	Tool \emptyset or \emptyset range (mm)	100–160	125–315	125–250	80–160	100–160	125–315
Maximum cutting width SB (mm)		12–16	16–22	22–25	8–10	10–16	16–23,5
P	Unalloyed steel ¹	0,10	0,14	0,20	0,10	0,10	0,17
	Low-alloyed steel	0,07	0,10	0,14	0,07	0,07	0,13
	High-alloyed steel and tool steel	0,07	0,10	0,14	0,07	0,07	0,13
	Stainless steel	0,05	0,07	0,10	0,05	0,05	0,10
M	Stainless steel ²	0,05	0,07	0,10	0,05	0,05	0,08
K	Malleable cast iron	0,08	0,12	0,18	0,08	0,08	0,17
	Grey cast iron	0,10	0,15	0,23	0,10	0,10	0,20
	Cast iron with spheroidal graphite	0,08	0,12	0,18	0,08	0,08	0,17
	GGV (CGI)	0,07	0,10	0,14	0,07	0,07	0,13
N	Aluminium wrought alloys	0,10	0,12	0,14	0,10	0,10	0,12
	Cast aluminium alloys	0,08	0,10	0,12	0,08	0,08	0,10
	Magnesium alloys	0,08	0,10	0,12	0,08	0,08	0,10
	Copper and copper alloys (bronze / brass)	0,07	0,09	0,11	0,07	0,07	0,10
S	Heat-resistant alloys	0,05	0,07	0,10	0,05	0,05	0,10
	Titanium alloys	0,05	0,07	0,10	0,05	0,05	0,10
	Tungsten alloys	0,05	0,07	0,10	0,05	0,05	0,10
	Molybdenum alloys	0,05	0,07	0,10	0,05	0,05	0,10
H	Hardened steel						
	Hardened cast iron						
O	Thermoplasts	0,07	0,10	0,15	0,07	0,10	0,12
	Plastic, carbon-fibre reinforced Graphite (technical)	0,07	0,10	0,15	0,07	0,10	0,12
Insert types		AD .. 0803 .. R/L	AD .. 1204 .. R/L	AD .. 1606 .. R/L	MP .. 0603 ..	MP .. 0803 ..	MP .. 1204 ..
Correction factor K_{a_e} for feed per tooth depending on the ratio of cutting width a_e to mill diameter D_c		central	1,0	1,0	1,0	1,0	1,0
$f_z = f_{z0} \cdot K_{a_e}$		$a_e / D_c = 1/3$	1,5	1,5	1,5	1,5	1,5
		$1/5$	1,8	1,8	1,8	1,8	1,8
		$1/10$	2,5	2,5	2,5	2,5	2,5
		$1/20$	3,3	3,3	3,3	3,3	3,3
		$1/50$	5,8	5,8	5,8	5,8	5,8

¹ and cast steel

² and austenitic / ferritic

 Please note: The feed per tooth f_z should not exceed 0.6 mm.

Feed determination (starting values) Side and face mill

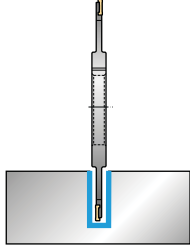
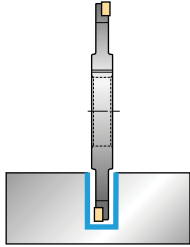
Mill type		F 4053		F 4153	
Feed per tooth f_{z0} for plunging, central positioning		 full side and face milling Xtra-tec®		 full side and face milling Xtra-tec®	
Approach angle κ		90°		90°	
Page		F 200		F 204	
Material group		f_{z0} (mm)		f_{z0} (mm)	
	Tool \varnothing or \varnothing range (mm)	80–160	80–200	80–200	80–200
	Maximum cutting width SB (mm)	4	6	8	10
P	Unalloyed steel ¹	0,11	0,12	0,13	0,14
	Low-alloyed steel	0,09	0,10	0,12	0,12
	High-alloyed steel and tool steel	0,09	0,10	0,12	0,12
	Stainless steel	0,05	0,05	0,07	0,07
M	Stainless steel ²	0,05	0,05	0,07	0,07
K	Malleable cast iron	0,11	0,12	0,13	0,13
	Grey cast iron	0,12	0,13	0,15	0,15
	Cast iron with spheroidal graphite	0,11	0,12	0,13	0,13
	GGV (CGI)	0,09	0,10	0,12	0,12
N	Aluminium wrought alloys				
	Cast aluminium alloys				
	Magnesium alloys				
	Copper and copper alloys (bronze / brass)				
S	Heat-resistant alloys	0,05	0,05	0,07	0,07
	Titanium alloys	0,05	0,05	0,07	0,07
	Tungsten alloys	0,05	0,05	0,07	0,07
	Molybdenum alloys	0,05	0,05	0,07	0,07
H	Hardened steel				
	Hardened cast iron				
O	Thermoplasts	0,10	0,07	0,10	0,12
	Plastic, carbon-fibre reinforced Graphite (technical)	0,10	0,07	0,10	0,12
Insert types		LN . X 0702 . .	LN . U 0803 . .	LN . U 0804 . .	LN . U 1005 . .
Correction factor K_{a_e} for feed per tooth depending on the ratio of cutting width a_e to mill diameter D_c	central	1,0	1,0	1,0	1,0
	$a_e / D_c = 1/3$	1,5	1,5	1,5	1,5
	$1/5$	1,8	1,8	1,8	1,8
	$1/10$	2,5	2,5	2,5	2,5
	$1/20$	3,3	3,3	3,3	3,3
$f_z = f_{z0} \cdot K_{a_e}$	$1/50$	5,8	5,8	5,8	5,8

¹ and cast steel

² and austenitic / ferritic

 Please note: The feed per tooth f_z should not exceed 0.6 mm.

Feed determination (starting values) Copy mill (toric)

Mill type		F 2231					
<p>Feed per tooth f_{z0} for $a_e = D_c$ $a_p = a_{p \max} = L_c$</p>		<p>F 2231</p>					
Approach angle κ		—					
Page		F 216					
Material group		f_{z0} (mm)					
Tool \emptyset or \emptyset range (mm)		10	16	20	24	30/32	40
Maximum cutting data $a_{p \max} = L_c$ (mm)		2,5	4	5	6	7,5/8	10
P	Unalloyed steel ¹	0,06	0,10	0,15	0,20	0,25	0,30
	Low-alloyed steel	0,05	0,08	0,12	0,14	0,20	0,25
	High-alloyed steel and tool steel	0,05	0,08	0,12	0,14	0,20	0,25
	Stainless steel	0,04	0,06	0,08	0,10	0,12	0,15
M	Stainless steel ²	0,04	0,06	0,08	0,10	0,12	0,12
	Malleable cast iron	0,06	0,10	0,15	0,20	0,25	0,30
K	Grey cast iron	0,08	0,12	0,20	0,25	0,30	0,35
	Cast iron with spheroidal graphite	0,06	0,10	0,15	0,20	0,25	0,30
	GGV (CGI)	0,06	0,10	0,15	0,20	0,25	0,30
	Aluminium wrought alloys	0,06	0,10	0,12	0,14	0,16	0,16
N	Cast aluminium alloys	0,06	0,10	0,12	0,14	0,16	0,16
	Magnesium alloys	0,06	0,10	0,12	0,14	0,16	0,16
	Copper and copper alloys (bronze / brass)	0,05	0,08	0,10	0,12	0,14	0,16
	Heat-resistant alloys	0,04	0,06	0,08	0,10	0,10	0,10
S	Titanium alloys	0,06	0,06	0,08	0,10	0,10	0,10
	Tungsten alloys	0,04	0,06	0,08	0,10	0,10	0,10
	Molybdenum alloys	0,06	0,06	0,08	0,10	0,10	0,10
H	Hardened steel	0,03	0,04	0,06	0,06	0,06	0,06
	Hardened cast iron	0,04	0,05	0,07	0,07	0,07	0,07
O	Thermoplasts	0,05	0,07	0,10	0,15	0,20	0,25
	Plastic, carbon-fibre reinforced Graphite (technical)	0,05	0,07	0,10	0,12	0,15	0,20
Insert types		RD .. 0501 ..	RD .. 0803 ..	RD .. 10T3 ..	RD .. 1204 ..	RD .. 1505 .. RD .. 1605 ..	RD .. 2006 ..
Correction factor K_{a_e} for the feed per tooth depending on the ratio of cut width a_e to cutter diameter D_c	$a_e / D_c = 1/1 - 1/2$	1,0	1,0	1,0	1,0	1,0	1,0
	1/5	1,2	1,2	1,2	1,2	1,2	1,2
	1/10	1,5	1,5	1,5	1,5	1,5	1,5
	1/20	1,8	1,8	1,8	1,8	1,8	1,8
	1/50	2,0	2,0	2,0	2,0	2,0	2,0
Correction factor K_{a_p} for the feed per tooth depending on the cutting depth a_p	$a_p = 1$	1,3	1,4	1,5	1,6	1,8	2,0
	2	1,0	1,1	1,2	1,3	1,4	1,5
	3		1,0	1,0	1,1	1,2	1,2
	4			1,0	1,0	1,1	1,1
	6				1,0	1,1	1,1
$f_z = f_{z0} \cdot K_{a_e} \cdot K_{a_p}$	8					1,0	1,1
	10						1,0

¹ and cast steel

² and austenitic / ferritic

The specified feed rates are average recommended values.
For special applications, adjustment is recommended.

F 2234

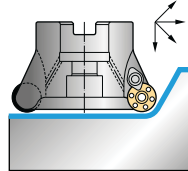

F 218
f_{z0} [mm]

	12-20	15-42	25	25-35	32-52	35-42	40-100	50-125	63-160
	2,5	3,5	4	5	5	6	6	8	10
	0,06	0,06	0,10	0,10	0,15	0,15	0,20	0,25	0,30
	0,05	0,05	0,08	0,08	0,12	0,12	0,14	0,20	0,25
	0,05	0,05	0,08	0,08	0,12	0,12	0,14	0,20	0,25
	0,04	0,04	0,06	0,06	0,08	0,08	0,10	0,12	0,15
	0,04	0,04	0,06	0,06	0,08	0,08	0,10	0,12	0,12
	0,06	0,06	0,10	0,10	0,15	0,15	0,20	0,25	0,30
	0,08	0,08	0,12	0,12	0,20	0,20	0,25	0,30	0,35
	0,06	0,06	0,10	0,10	0,15	0,15	0,20	0,25	0,30
	0,06	0,06	0,10	0,10	0,15	0,15	0,20	0,25	0,30
	0,06	0,06	0,10	0,10	0,12	0,12	0,14	0,16	0,16
	0,06	0,06	0,10	0,10	0,12	0,12	0,14	0,16	0,16
	0,06	0,06	0,10	0,10	0,12	0,12	0,14	0,16	0,16
	0,05	0,05	0,08	0,08	0,10	0,10	0,12	0,14	0,16
	0,04	0,04	0,06	0,06	0,08	0,08	0,10	0,10	0,10
	0,04	0,04	0,06	0,06	0,08	0,08	0,10	0,10	0,10
	0,04	0,04	0,06	0,06	0,08	0,08	0,10	0,10	0,10
	0,04	0,04	0,06	0,06	0,08	0,08	0,10	0,10	0,10
	0,03	0,03	0,06	0,06	0,06	0,06	0,06	0,06	0,06
	0,04	0,04	0,07	0,07	0,07	0,07	0,07	0,07	0,07
	0,05	0,06	0,07	0,09	0,10	0,13	0,15	0,20	0,25
	0,05	0,06	0,07	0,09	0,10	0,12	0,15	0,17	0,20
	RD .. 0501 ..	RD .. 07T1 ..	RD .. 0803 ..	RD .. 1003 ..	RD .. 10T3 ..	RD .. 12T3 ..	RD .. 1204 ..	RD .. 1605 ..	RD .. 2006 ..
	1,0	1,0	1,0	1,0	1,0	1,0	1,0	1,0	1,0
	1,2	1,2	1,2	1,2	1,2	1,2	1,2	1,2	1,2
	1,5	1,5	1,5	1,5	1,5	1,5	1,5	1,5	1,5
	1,8	1,8	1,8	1,8	1,8	1,8	1,8	1,8	1,8
	2,0	2,0	2,0	2,0	2,0	2,0	2,0	2,0	2,0
	1,3	1,3	1,4	1,5	1,5	1,6	1,6	1,8	2,0
	1,0	1,0	1,1	1,2	1,2	1,3	1,3	1,4	1,5
			1,0	1,0	1,0	1,1	1,1	1,2	1,2
				1,0	1,0	1,0	1,0	1,1	1,1
						1,0	1,0	1,1	1,1
								1,0	1,1
									1,0

Feed determination (starting values) Copy mill (toric)

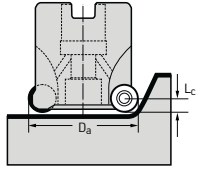
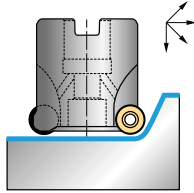
Mill type		F 2010 / F 2334				
Feed per tooth f_{z0} for $a_e = D_c$ $a_p = a_{p \max} = L_c$ 		 <p style="text-align: center;">Xtra-tec®</p>				
Approach angle κ		–				
Page		F 222				
Material group		f_{z0} [mm]				
		F 2334	F 2334	F 2334	F 2010 F 2334	F 2334
Tool \emptyset or \emptyset range [mm]		25–32	32–66	40–80	52–315	63–160
Maximum cutting data $a_{p \max} = L_c$ [mm]		4	5	6	8	10
P	Unalloyed steel ¹	0.11	0.17	0.22	0.28	0.33
	Low-alloyed steel	0.09	0.13	0.15	0.22	0.28
	High-alloyed steel and tool steel	0.09	0.13	0.15	0.22	0.28
	Stainless steel	0.07	0.09	0.11	0.13	0.17
M	Stainless steel ²	0.07	0.09	0.11	0.13	0.13
K	Malleable cast iron	0.11	0.17	0.22	0.28	0.33
	Grey cast iron	0.13	0.22	0.28	0.33	0.39
	Cast iron with spheroidal graphite	0.11	0.17	0.22	0.28	0.33
	GGV (CGI)	0.11	0.17	0.22	0.28	0.33
N	Aluminium wrought alloys					
	Cast aluminium alloys					
	Magnesium alloys					
	Copper and copper alloys (bronze / brass)					
S	Heat-resistant alloys	0.07	0.09	0.11	0.11	0.11
	Titanium alloys	0.07	0.09	0.11	0.11	0.11
	Tungsten alloys	0.07	0.09	0.11	0.11	0.11
	Molybdenum alloys	0.07	0.09	0.11	0.11	0.11
H	Hardened steel					
	Hardened cast iron					
O	Thermoplasts	0.07	0.10	0.15	0.20	0.25
	Plastic, carbon-fibre reinforced					
	Graphite (technical)	0.07	0.10	0.12	0.15	0.20
Insert types		RO . X 0803 ...	RO . X 10T3 ...	RO . X 1204 ...	RO . X 1605 ...	RO . X 2006 ...
Correction factor K_{a_e} for the feed per tooth depending on the ratio of cut width a_e to cutter diameter D_c	$a_e / D_c = 1/1 - 1/2$	1.0	1.0	1.0	1.0	1.0
	1/5	1.2	1.2	1.2	1.2	1.2
	1/10	1.5	1.5	1.5	1.5	1.5
	1/20	1.8	1.8	1.8	1.8	1.8
Correction factor K_{a_p} for the feed per tooth depending on the cutting depth a_p	1/50	2.0	2.0	2.0	2.0	2.0
	$a_p = 1$	1.4	1.5	1.6	1.8	2.0
	2	1.1	1.2	1.3	1.4	1.5
	3	1.0	1.0	1.1	1.2	1.5
$f_z = f_{z0} \cdot K_{a_e} \cdot K_{a_p}$	4		1.0	1.0	1.1	1.2
	6				1.0	1.1
	8					1.1
	10					1.0

¹ and cast steel

² and austenitic / ferritic

The specified feed rates are average recommended values.
For special applications, adjustment is recommended.

F 4031

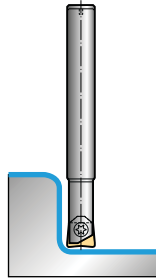

Xtra-tec®

F 232

f_{z0} [mm]

	12	16	20	25	32
	2-2,5	2,5	3,1	3,5	3,5
	0,12	0,14	0,14	0,17	0,17
	0,08	0,10	0,12	0,14	0,14
	0,08	0,10	0,12	0,14	0,14
	0,06	0,08	0,10	0,12	0,12
	0,06	0,08	0,10	0,12	0,12
	0,10	0,12	0,14	0,17	0,17
	0,12	0,15	0,17	0,20	0,20
	0,10	0,12	0,14	0,17	0,17
	0,10	0,12	0,14	0,17	0,17
	0,07	0,09	0,11	0,13	0,13
	0,07	0,09	0,11	0,13	0,13
	0,07	0,09	0,11	0,13	0,13
	0,06	0,08	0,10	0,12	0,12
	0,05	0,06	0,08	0,08	0,08
	0,05	0,06	0,08	0,08	0,08
	0,05	0,06	0,08	0,08	0,08
	0,05	0,06	0,08	0,08	0,08
	0,05	0,06	0,08	0,08	0,08
	0,06	0,07	0,09	0,09	0,09
	0,10	0,15	0,17	0,20	0,25
	0,10	0,12	0,15	0,20	0,20
	P8001-D12 ..	P8001-D16 ..	P8001-D20 ..	P8001-D25 ..	P8001-D32 ..
	1,0	1,0	1,0	1,0	1,0
	1,2	1,2	1,2	1,2	1,2
	1,5	1,5	1,5	1,5	1,5
	1,8	1,8	1,8	1,8	1,8
	2,0	2,0	2,0	2,0	2,0

Feed determination (starting values) Copy mill

Mill type		F 2239					
Approach angle κ		–					
Page		F 226					
Material group		fz0 (mm)					
	Tool \emptyset or \emptyset range (mm)	20	25	30/32	40	50	63
Maximum cutting data $a_{p \max} = L_c$ (mm)		25	28	38	51	77	84
P	Unalloyed steel ¹	0,18	0,24	0,30	0,36	0,36	0,36
	Low-alloyed steel	0,12	0,17	0,24	0,30	0,30	0,30
	High-alloyed steel and tool steel	0,12	0,17	0,24	0,30	0,30	0,30
	Stainless steel	0,08	0,12	0,16	0,20	0,20	0,20
M	Stainless steel ²	0,08	0,12	0,14	0,14	0,14	0,14
K	Malleable cast iron	0,18	0,24	0,30	0,36	0,36	0,36
	Grey cast iron	0,24	0,30	0,36	0,42	0,42	0,42
	Cast iron with spheroidal graphite	0,18	0,24	0,30	0,36	0,36	0,36
	GGV (CGI)	0,18	0,24	0,30	0,36	0,36	0,36
N	Aluminium wrought alloys	0,10	0,14	0,20	0,20	0,20	0,20
	Cast aluminium alloys	0,10	0,14	0,20	0,20	0,20	0,20
	Magnesium alloys	0,10	0,14	0,20	0,20	0,20	0,20
	Copper and copper alloys (bronze / brass)	0,08	0,12	0,17	0,20	0,20	0,20
S	Heat-resistant alloys	0,08	0,12	0,12	0,12	0,12	0,12
	Titanium alloys	0,08	0,12	0,12	0,12	0,12	0,12
	Tungsten alloys	0,08	0,12	0,12	0,12	0,12	0,12
	Molybdenum alloys	0,08	0,12	0,12	0,12	0,12	0,12
H	Hardened steel						
	Hardened cast iron						
O	Thermoplasts	0,10	0,12	0,15	0,20	0,25	0,25
	Plastic, carbon-fibre reinforced Graphite (technical)	0,10	0,12	0,15	0,20	0,20	0,20
Insert types		P26315-R10 SP .. 0603 ..	P26315-R12 SP .. 0603 ..	P26315-R15 P26315-R16 SP .. 09T3 ..	P26315-R20 SP .. 1204 ..	P26315-R25 SP .. 1204 ..	P26315-R32 SP .. 1204 ..
Correction factor K_{a_e}		$a_e / D_c = 1/1 - 1/2$					
		1,0	1,0	1,0	1,0	1,0	1,0
for the feed per tooth depending on the ratio of cut width a_e to cutter diameter D_c		$1/5$					
		1,2	1,2	1,2	1,2	1,2	1,2
		$1/10$					
		1,5	1,5	1,5	1,5	1,5	1,5
		$1/20$					
		1,8	1,8	1,8	1,8	1,8	1,8
		$1/50$					
		2,0	2,0	2,0	2,0	2,0	2,0
Correction factor K_{a_p}		$a_p = 1$					
		1,9	2,1	2,3	2,5	2,8	3,0
		2					
		1,5	1,6	1,8	1,9	2,1	2,3
		4					
		1,2	1,3	1,4	1,5	1,6	1,8
		6					
		1,1	1,2	1,2	1,3	1,4	1,5
for the feed per tooth depending on the cutting depth a_p		8					
		1,1	1,1	1,1	1,2	1,3	1,4
		10					
		1,0	1,1	1,1	1,2	1,2	1,3
		$12,5$					
		0,5	1,0	1,1	1,1	1,1	1,2
		$15/16$					
		0,5	0,5	1,0	1,1	1,1	1,1
		20					
		0,5	0,5	0,5	1,0	1,0	1,0
$f_z = f_{z0} \cdot K_{a_e} \cdot K_{a_p}$		$a_{p \max} = L_c$					
		0,5	0,5	0,5	0,5	0,5	0,5

¹ and cast steel

² and austenitic / ferritic

The specified feed rates are average recommended values.
For special applications, adjustment is recommended.

F 2239B

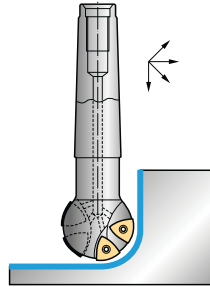

–
F 226
f_{z0} [mm]

	20	25	30/32	40	50
	15	20	26	32	39
	0.18	0.24	0.30	0.36	0.36
	0.12	0.17	0.24	0.30	0.30
	0.12	0.17	0.24	0.30	0.30
	0.08	0.12	0.16	0.20	0.20
	0.08	0.12	0.14	0.14	0.14
	0.18	0.24	0.30	0.36	0.36
	0.24	0.30	0.36	0.42	0.42
	0.18	0.24	0.30	0.36	0.36
	0.18	0.24	0.30	0.36	0.36
	0.10	0.14	0.20	0.20	0.20
	0.10	0.14	0.20	0.20	0.20
	0.10	0.14	0.20	0.20	0.20
	0.08	0.12	0.17	0.20	0.20
	0.08	0.12	0.12	0.12	0.12
	0.08	0.12	0.12	0.12	0.12
	0.08	0.12	0.12	0.12	0.12
	0.08	0.12	0.12	0.12	0.12
	0.10	0.12	0.15	0.20	0.25
	0.10	0.12	0.15	0.20	0.20
	P26315-R10	P26315-R12	R26315-R15 P26315-R16	P26315-R20	P26315-R25
	1.0	1.0	1.0	1.0	1.0
	1.2	1.2	1.2	1.2	1.2
	1.5	1.5	1.5	1.5	1.5
	1.8	1.8	1.8	1.8	1.8
	2.0	2.0	2.0	2.0	2.0
	1.9	2.1	2.3	2.5	2.8
	1.5	1.6	1.8	1.9	2.1
	1.2	1.3	1.4	1.5	1.6
	1.1	1.2	1.2	1.3	1.4
	1.1	1.1	1.1	1.2	1.3
	1.0	1.1	1.1	1.2	1.2
	0.5	1.0	1.1	1.1	1.1
	0.5	0.5	1.0	1.1	1.1
	0.5	0.5	0.5	1.0	1.0
	0.5	0.5	0.5	0.5	0.5

Feed determination (starting values) Copy mill

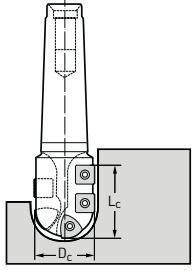
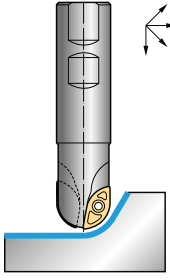
Mill type		F 2339 Form A					
Feed per tooth f_{z0} for $a_e = D_c$ $a_p = a_{p \max} = L_c$ 							
Approach angle κ		–					
Page		F 228					
Material group		f_{z0} [mm]					
	Tool \emptyset or \emptyset range (mm)	16	20	25	30/32	40	50
Maximum cutting data $a_{p \max} = L_c$ (mm)		11	15	20	24/25	31	40
P	Unalloyed steel ¹	0,13	0,15	0,20	0,25	0,30	0,35
	Low-alloyed steel	0,08	0,10	0,14	0,20	0,25	0,30
	High-alloyed steel and tool steel	0,08	0,10	0,14	0,20	0,25	0,30
	Stainless steel	0,06	0,07	0,10	0,12	0,14	0,18
M	Stainless steel ²	0,06	0,07	0,10	0,12	0,12	0,14
K	Malleable cast iron	0,13	0,15	0,20	0,25	0,30	0,35
	Grey cast iron	0,17	0,20	0,25	0,30	0,35	0,40
	Cast iron with spheroidal graphite	0,13	0,15	0,20	0,25	0,30	0,35
	GGV (CGI)	0,13	0,15	0,20	0,25	0,30	0,35
N	Aluminium wrought alloys	0,08	0,09	0,12	0,16	0,16	0,18
	Cast aluminium alloys	0,08	0,09	0,12	0,16	0,16	0,18
	Magnesium alloys	0,08	0,09	0,12	0,16	0,16	0,18
	Copper and copper alloys (bronze / brass)	0,06	0,07	0,10	0,14	0,16	0,18
S	Heat-resistant alloys	0,06	0,07	0,10	0,10	0,10	0,12
	Titanium alloys	0,06	0,07	0,10	0,10	0,10	0,12
	Tungsten alloys	0,06	0,07	0,10	0,10	0,10	0,12
	Molybdenum alloys	0,06	0,07	0,10	0,10	0,10	0,12
H	Hardened steel						
	Hardened cast iron						
O	Thermoplasts	0,10	0,10	0,12	0,15	0,20	0,25
	Plastic, carbon-fibre reinforced Graphite (technical)	0,10	0,10	0,12	0,15	0,20	0,20
Insert types		XD .. 130380R ..	XD .. 16T3100R ..	XD .. 2004125R ..	XD .. 2405150R .. XD .. 2506160R ..	XD .. 3207200R ..	XD .. 4009250R ..
Correction factor K_{a_e} for the feed per tooth depending on the ratio of cut width a_e to cutter diameter D_c	$a_e / D_c = 1/1 - 1/2$	1,0	1,0	1,0	1,0	1,0	1,0
	1/5	1,2	1,2	1,2	1,2	1,2	1,2
	1/10	1,5	1,5	1,5	1,5	1,5	1,5
	1/20	1,8	1,8	1,8	1,8	1,8	1,8
	1/50	2,0	2,0	2,0	2,0	2,0	2,0
Correction factor K_{a_p} for the feed per tooth depending on the cutting depth a_p	$a_p = 1$	1,6	1,9	2,1	2,3	2,5	2,7
	2	1,3	1,5	1,6	1,8	1,9	2
	4	1,1	1,2	1,3	1,4	1,5	1,6
	6	1,0	1,1	1,2	1,2	1,3	1,4
	8	1,0	1,1	1,1	1,1	1,2	1,3
	10	1,0	1,0	1,1	1,1	1,2	1,2
	12,5		1,0	1,0	1,1	1,1	1,2
	15/16		1,0	1,0	1,0	1,1	1,1
	20			1,0	1,0	1,0	1,0
	$a_{p \max} = L_c$				1,0	1,0	1,0
$f_z = f_{z0} \cdot K_{a_e} \cdot K_{a_p}$							

¹ and cast steel

² and austenitic / ferritic

The specified feed rates are average recommended values.
For special applications, adjustment is recommended.

F 2339 Form B

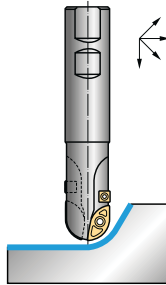

F 230					
f _{z0} [mm]					
16	20	25	30/32	40	
24	28	32	42/43	57	
0.13	0.15	0.20	0.25	0.30	
0.08	0.10	0.14	0.20	0.25	
0.08	0.10	0.14	0.20	0.25	
0.06	0.07	0.10	0.12	0.14	
0.06	0.07	0.10	0.12	0.12	
0.13	0.15	0.20	0.25	0.30	
0.17	0.20	0.25	0.30	0.35	
0.13	0.15	0.20	0.25	0.30	
0.13	0.15	0.20	0.25	0.30	
0.08	0.09	0.12	0.16	0.16	
0.08	0.09	0.12	0.16	0.16	
0.08	0.09	0.12	0.16	0.16	
0.06	0.07	0.10	0.14	0.16	
0.06	0.07	0.10	0.10	0.10	
0.06	0.07	0.10	0.10	0.10	
0.06	0.07	0.10	0.10	0.10	
0.06	0.07	0.10	0.10	0.10	
0.10	0.10	0.12	0.15	0.20	
0.10	0.10	0.12	0.15	0.20	
XD .. 130880R .. SP .. 0603 ..	XD .. 16T3100R .. SP .. 0603 ..	XD .. 2004125R .. SP .. 0603 ..	XD .. 2405150R .. XD .. 2506160R .. SP .. 09T3 ..	XD .. 3207200R .. SP .. 1204 ..	
1.0	1.0	1.0	1.0	1.0	
1.2	1.2	1.2	1.2	1.2	
1.5	1.5	1.5	1.5	1.5	
1.8	1.8	1.8	1.8	1.8	
2.0	2.0	2.0	2.0	2.0	
1.6	1.9	2.1	2.3	2.5	
1.3	1.5	1.6	1.8	1.9	
1.1	1.2	1.3	1.4	1.5	
1.0	1.1	1.2	1.2	1.3	
1.0	1.1	1.1	1.1	1.2	
1.0	1.0	1.1	1.1	1.2	
1.0	1.0	1.0	1.1	1.1	
1.0	1.0	1.0	1.0	1.1	
0.5	0.5	1.0	1.0	1.0	
0.5	0.5	0.5	0.5	0.5	

Feed determination (starting values) Copy mill

Mill type		F 2139			
Approach angle κ		–			
Page		F 214			
Material group		f_{z0} [mm]			
Tool \emptyset or \emptyset range (mm)		8	10	12	16
Maximum cutting data $a_{p \max} = L_c$ (mm)		4	5	6	8
P	Unalloyed steel ¹	0,08	0,10	0,10	0,12
	Low-alloyed steel	0,06	0,08	0,08	0,10
	High-alloyed steel and tool steel	0,06	0,08	0,08	0,10
	Stainless steel	0,05	0,06	0,06	0,08
M	Stainless steel ²	0,05	0,06	0,06	0,08
	Malleable cast iron	0,08	0,10	0,10	0,12
K	Grey cast iron	0,10	0,12	0,12	0,15
	Cast iron with spheroidal graphite	0,08	0,10	0,10	0,12
	GGV (CGI)	0,08	0,10	0,10	0,12
	Aluminium wrought alloys	0,05	0,07	0,07	0,09
N	Cast aluminium alloys	0,05	0,07	0,07	0,09
	Magnesium alloys	0,05	0,07	0,07	0,09
	Copper and copper alloys (bronze / brass)	0,05	0,06	0,06	0,08
	Heat-resistant alloys	0,04	0,05	0,05	0,06
S	Titanium alloys	0,04	0,05	0,05	0,06
	Tungsten alloys	0,04	0,05	0,05	0,06
	Molybdenum alloys	0,04	0,05	0,05	0,06
	Hardened steel	0,04 ³	0,05 ³	0,05 ³	0,06 ³
H	Hardened cast iron	0,05 ³	0,06 ³	0,06 ³	0,07 ³
	Thermoplasts	0,07	0,10	0,12	0,12
O	Plastic, carbon-fibre reinforced				
	Graphite (technical)	0,07	0,10	0,12	0,12
Insert types		P32...-D08	P32...-D10	P32...-D12	P32...-D16
Correction factor K_{a_e}		$a_e / D_c = 1/1 - 1/2$			
		1,0	1,0	1,0	1,0
for the feed per tooth depending on the ratio of cut width a_e to cutter diameter D_c		$1/5$			
		1,2	1,2	1,2	1,2
		$1/10$			
		1,5	1,5	1,5	1,5
		$1/20$			
		1,8	1,8	1,8	1,8
		$1/50$			
		2,0	2,0	2,0	2,0
Correction factor K_{a_p}		$a_p = 0,2$			
		1,8	2,3	2,3	2,5
		$0,4$			
		1,5	2,0	2,0	2,2
		$0,6$			
		1,2	1,7	1,7	1,9
for the feed per tooth depending on the cutting depth a_p		$0,8$			
		1,0	1,3	1,3	1,5
		$1,0$			
		0,8	1,0	1,0	1,2
		$1,5$			
		0,7	0,8	0,8	1,0
		$2,0$			
		0,6	0,7	0,7	0,8
		$3,0$			
		0,5	0,6	0,6	0,7
		$4,0$			
		0,5	0,5	0,5	0,6
$f_z = f_{z0} \cdot K_{a_e} \cdot K_{a_p}$		$a_{p \max} = L_c$			
		0,5	0,5	0,5	0,5

¹ and cast steel

² and austenitic / ferritic

³ Correction factor $K_{a_e} \cdot K_{a_p}$ - do not set to more than 3 when finishing

The specified feed rates are average recommended values.
For special applications, adjustment is recommended.

F 2139

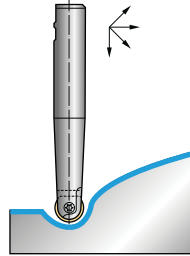

F 214
f_{z0} [mm]

-				
F 214				
f _{z0} [mm]				
20	25	30	32	
10	12	15	16	
0.12	0.15	0.15	0.15	
0.10	0.12	0.12	0.12	
0.10	0.12	0.12	0.12	
0.08	0.10	0.10	0.10	
0.08	0.10	0.10	0.10	
0.12	0.15	0.15	0.15	
0.15	0.18	0.18	0.18	
0.12	0.15	0.15	0.15	
0.12	0.15	0.15	0.15	
0.09	0.11	0.11	0.11	
0.09	0.11	0.11	0.11	
0.09	0.11	0.11	0.11	
0.08	0.10	0.10	0.10	
0.06	0.06	0.06	0.06	
0.06	0.06	0.06	0.06	
0.06	0.06	0.06	0.06	
0.06	0.06	0.06	0.06	
0.06 ³	0.06 ³	0.06 ³	0.06 ³	
0.07 ³	0.07 ³	0.07 ³	0.07 ³	
0.15	0.15	0.20	0.20	
0.15	0.15	0.20	0.20	
P32...-D20	P32...-D25	P32...-D30	P32...-D32	
1.0	1.0	1.0	1.0	
1.2	1.2	1.2	1.2	
1.5	1.5	1.5	1.5	
1.8	1.8	1.8	1.8	
2.0	2.0	2.0	2.0	
2.5	2.7	2.7	2.7	
2.2	2.4	2.4	2.4	
1.9	2.1	2.1	2.1	
1.5	1.7	1.7	1.7	
1.2	1.4	1.4	1.4	
1.0	1.2	1.2	1.2	
0.8	1.0	1.0	1.0	
0.7	0.8	0.8	0.8	
0.6	0.7	0.7	0.7	
0.5	0.5	0.5	0.5	

Feed determination (starting values) Form mill

Mill type		F 2232		
<p>Feed per tooth f_{z0} for $a_e = D_c$ $a_p = a_{p \max} = L_c$</p>				
Approach angle κ		45°		
Page		F 238		
Material group		f_{z0} (mm)		
	Tool \emptyset or \emptyset range (mm)	12–16	20–40	32–40
Maximum cutting data $a_{p \max} = L_c$ (mm)		3	5	7
P	Unalloyed steel ¹	0,15	0,20	0,25
	Low-alloyed steel	0,12	0,15	0,20
	High-alloyed steel and tool steel	0,12	0,15	0,20
	Stainless steel	0,10	0,12	0,15
M	Stainless steel ²	0,08	0,10	0,12
K	Malleable cast iron	0,15	0,20	0,25
	Grey cast iron	0,20	0,25	0,30
	Cast iron with spheroidal graphite	0,15	0,20	0,25
	GGV (CGI)	0,15	0,20	0,25
N	Aluminium wrought alloys	0,10	0,12	0,15
	Cast aluminium alloys	0,08	0,10	0,12
	Magnesium alloys	0,08	0,10	0,12
	Copper and copper alloys (bronze / brass)	0,08	0,10	0,12
S	Heat-resistant alloys	0,08	0,10	0,12
	Titanium alloys	0,08	0,10	0,12
	Tungsten alloys	0,08	0,10	0,12
	Molybdenum alloys	0,08	0,10	0,12
H	Hardened steel			
	Hardened cast iron			
O	Thermoplasts	0,07	0,10	0,15
	Plastic, carbon-fibre reinforced			
	Graphite (technical)	0,07	0,10	0,15
Insert types		SP .. 0603 ..	SP .. 09T3 ..	SP .. 1204 ..
Correction factor K_{a_e}				
$a_e / D_c = 1/1 - 1/2$		1,0	1,0	1,0
1/5		1,1	1,1	1,1
1/10		1,2	1,2	1,2
1/20		1,3	1,3	1,3
1/50		1,5	1,5	1,5
$f_z = f_{z0} \cdot K_{a_e}$				

¹ and cast steel

² and austenitic / ferritic

Feed determination (starting values) Circular interpolation mill

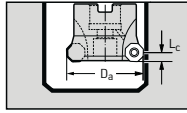
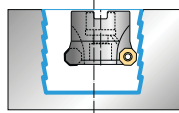
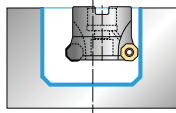
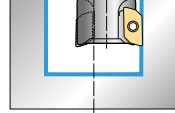
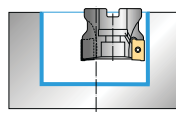
Mill type		F 2010 / F 4080		F 4081		F 3040		F 2010 / F 4042	
Feed per tooth f_{z0} for $a_e = D_c$ $a_p = a_{p \max} = L_c$ 		 Xtra-tec®		 Xtra-tec®				 Xtra-tec®	
Page		F 130		F 244		F 140		F 144	
Material group		f_{z0} [mm]		f_{z0} [mm]		f_{z0} [mm]		f_{z0} [mm]	
		F 4080	F 2010 / F 4080					F 4042	F 4042R
Tool \emptyset or \emptyset range [mm]		32–125	50–315	36–85	52–85	25–63	32–63	10–50	16–50
Maximum cutting data $a_{p \max} = L_c$ [mm]		3/8	4/10	3/8	4/10	15	20	8	10
P	Unalloyed steel ¹	0.40	0.45	0.40	0.45			0.13	0.16
	Low-alloyed steel	0.36	0.40	0.36	0.40			0.09	0.10
	High-alloyed steel and tool steel	0.27	0.32	0.27	0.32			0.09	0.10
	Stainless steel	0.18	0.22	0.18	0.22			0.07	0.09
M	Stainless steel ²	0.13	0.13	0.13	0.13	0.09	0.09	0.07	0.09
K	Malleable cast iron	0.32	0.36	0.32	0.36	0.18	0.18	0.10	0.13
	Grey cast iron	0.40	0.45	0.40	0.45	0.22	0.22	0.13	0.18
	Cast iron with spheroidal graphite	0.32	0.36	0.32	0.36	0.18	0.18	0.10	0.13
	GGV (CGI)	0.32	0.36	0.32	0.36	0.18	0.18	0.10	0.13
N	Aluminium wrought alloys	0.22	0.22	0.22	0.22	0.13	0.18	0.10	
	Cast aluminium alloys	0.22	0.22	0.22	0.22	0.13	0.18	0.10	
	Magnesium alloys	0.13	0.13	0.13	0.13	0.13	0.18	0.09	
	Copper and copper alloys (bronze / brass)	0.13	0.13	0.13	0.13	0.11	0.13	0.09	
S	Heat-resistant alloys	0.13	0.13	0.13	0.13	0.11	0.11	0.07	0.09
	Titanium alloys	0.13	0.13	0.13	0.13	0.11	0.11	0.07	0.09
	Tungsten alloys	0.13	0.13	0.13	0.13	0.11	0.11	0.07	0.09
	Molybdenum alloys	0.13	0.13	0.13	0.13	0.11	0.11	0.07	0.09
H	Hardened steel								
	Hardened cast iron								
O	Thermoplasts	0.20	0.20	0.20	0.20	0.15	0.15	0.12	0.15
	Plastic, carbon-fibre reinforced								
	Graphite (technical)	0.15	0.15	0.15	0.15	0.12	0.12	0.10	0.12
Insert types		OD .. 0504 ..	OD .. 0605 ..	OD .. 0504 ..	OD .. 0605 ..	ZDGT 1504 ..	ZDGT 2005 ..	AD .. T 0803 ..	AD .. T 10T3 ..
Correction factor K_{a_e}		$a_e / D_c = 1/1 - 1/2$		1.0	1.0	1.0	1.0	1.0	1.0
for the feed per tooth depending on the ratio of cut width a_e to cutter diameter D_c		$1/5$		1.1	1.1	1.1	1.1	1.1	1.1
		$1/10$		1.2	1.2	1.2	1.2	1.2	1.2
		$1/20$		1.3	1.3	1.3	1.3	1.3	1.3
		$1/50$							
Correction factor K		$1 < (L : D_c) = \leq 2$							
		$2 < (L : D_c) = \leq 4$							
$f_z = f_{z0} \cdot K_{a_e} \cdot K$		$4 < (L : D_c) = \leq 6$							

¹ and cast steel

² and austenitic / ferritic

The specified feed rates are average recommended values.
For special applications, adjustment is recommended.

F 2010 / F 4042				F 2010 / F 2330			F 4030		F 2234			
Xtra-tec®							Xtra-tec®					
90°				0-15°			0-15°		-			
F 144				F 114			F 116		F 218			
f _{z0} [mm]		f _{z0} [mm]		f _{z0} [mm]		f _{z0} [mm]		f _{z0} [mm]				
F 2010 F 4042	F 2010 F 4042	F 4042	F 2330	F 2330	F 2010 F 2330							
25-80	40-160	50-160	20-25	32-85	52-315	25-63	50-100	12-20	15-42	25	25-35	
11.7	15	16.7	1.0	1.5	2.0	1.0	2.0	2.5	3.5	4	5	
0.18	0.22	0.27	1.00	1.40	1.80	1.40	1.80	0.06	0.06	0.10	0.10	
0.13	0.16	0.20	0.90	1.25	1.60	1.30	1.60	0.05	0.05	0.08	0.08	
0.13	0.16	0.20	0.60	0.90	1.00	1.00	1.10	0.05	0.05	0.08	0.08	
0.10	0.13	0.16	0.45	0.50	0.70	0.50	0.40	0.04	0.04	0.06	0.06	
0.09	0.10	0.12	0.45	0.50	0.70	0.50	0.70	0.04	0.04	0.06	0.06	
0.18	0.22	0.27	1.00	1.40	1.80	1.40	1.60	0.06	0.06	0.10	0.10	
0.22	0.27	0.36	0.90	1.25	1.60	1.30	1.80	0.08	0.08	0.12	0.12	
0.18	0.22	0.27	0.90	1.25	1.60	1.30	1.60	0.06	0.06	0.10	0.10	
0.18	0.22	0.27	1.00	1.40	1.80	1.40	1.60	0.06	0.06	0.10	0.10	
0.13	0.13							0.06	0.06	0.10	0.10	
0.13	0.13							0.06	0.06	0.10	0.10	
0.10	0.13							0.06	0.06	0.10	0.10	
0.10	0.13							0.05	0.05	0.08	0.08	
0.10	0.13	0.16	0.45	0.50	0.70	0.50	0.70	0.04	0.04	0.06	0.06	
0.10	0.13	0.16	0.45	0.50	0.70	0.50	0.70	0.04	0.04	0.06	0.06	
0.10	0.13	0.16	0.45	0.50	0.70	0.50	0.70	0.04	0.04	0.06	0.06	
0.10	0.13	0.16	0.45	0.50	0.70	0.50	0.70	0.04	0.04	0.06	0.06	
								0.03	0.03	0.06	0.06	
								0.03	0.03	0.06	0.06	
0.17	0.20	0.20	0.30	0.40	0.50	0.40	0.50	0.05	0.06	0.07	0.09	
0.15	0.15	0.15	0.20	0.25	0.30	0.25	0.30	0.05	0.06	0.07	0.09	
AD...1204...	AD.T 1606...	AD.T 1807...	P2633.-R10 P26379-R10	P2633.-R14 P26379-R14	P2633.-R25 P26379-R25	P23696-1.0	P23696-2.0	RD...0501...	RD...07T1...	RD...0803...	RD...1003...	
1.0	1.0	1.0	1.0	1.0	1.0	1.0	1.0	1.0	1.0	1.0	1.0	
1.1	1.1	1.1	1.0	1.0	1.0	1.4	1.4	1.2	1.2	1.2	1.2	
1.2	1.2	1.2	1.8	1.8	1.8	1.8	1.8	1.5	1.5	1.5	1.5	
1.3	1.3	1.3						1.8	1.8	1.8	1.8	
								2.0	2.0	2.0	2.0	
			1.4	1.4	1.4	1.4	1.4					
			1.0	1.0	1.0	1.0	1.0					
			0.7	0.7	0.7	0.7	0.7					

Feed determination (starting values) Circular interpolation mill

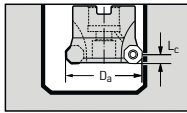
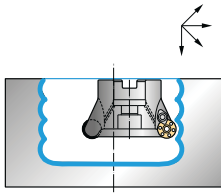
Mill type		F 2234				
Feed per tooth f_{z0} for $a_e = D_c$ $a_p = a_{p \max} = L_c$ 						
Approach angle κ		-				
Page		F 218				
Material group		f_{z0} [mm]				
	Tool \emptyset or \emptyset range (mm)	32–52	35–42	40–100	50–125	63–160
Maximum cutting data $a_{p \max} = L_c$ (mm)		5	6	6	8	10
P	Unalloyed steel ¹	0.15	0.15	0.20	0.25	0.30
	Low-alloyed steel	0.12	0.12	0.14	0.20	0.25
	High-alloyed steel and tool steel	0.12	0.12	0.14	0.20	0.25
	Stainless steel	0.08	0.08	0.10	0.12	0.15
M	Stainless steel ²	0.08	0.08	0.10	0.12	0.12
K	Malleable cast iron	0.15	0.15	0.20	0.25	0.30
	Grey cast iron	0.20	0.20	0.25	0.30	0.35
	Cast iron with spheroidal graphite	0.15	0.15	0.20	0.25	0.30
	GGV (CGI)	0.15	0.15	0.20	0.25	0.30
N	Aluminium wrought alloys	0.12	0.12	0.14	0.16	0.16
	Cast aluminium alloys	0.12	0.12	0.14	0.16	0.16
	Magnesium alloys	0.12	0.12	0.14	0.16	0.16
	Copper and copper alloys (bronze / brass)	0.10	0.10	0.12	0.14	0.16
S	Heat-resistant alloys	0.08	0.08	0.10	0.10	0.10
	Titanium alloys	0.08	0.08	0.10	0.10	0.10
	Tungsten alloys	0.08	0.08	0.10	0.10	0.10
H	Molybdenum alloys	0.08	0.08	0.10	0.10	0.10
	Hardened steel	0.06	0.06	0.06	0.06	0.06
O	Hardened cast iron	0.06	0.06	0.06	0.06	0.06
	Thermoplasts	0.10	0.13	0.15	0.20	0.25
	Plastic, carbon-fibre reinforced					
Graphite (technical)		0.10	0.12	0.15	0.17	0.20
Insert types		RD .. 10T3 ..	RD .. 12T3 ..	RD .. 1204 ..	RD .. 1605 ..	RD .. 2006 ..
Correction factor K_{a_e}						
for the feed per tooth depending on the ratio of cut width a_e to cutter diameter D_c		$a_e / D_c = 1/1 - 1/2$	1.0	1.0	1.0	1.0
		1/5	1.2	1.2	1.2	1.2
		1/10	1.5	1.5	1.5	1.5
		1/20	1.8	1.8	1.8	1.8
$f_z = f_{z0} \cdot K_{a_e}$		1/50	2.0	2.0	2.0	2.0

¹ and cast steel

² and austenitic / ferritic

The specified feed rates are average recommended values.
For special applications, adjustment is recommended.

F 2010 / F 2334

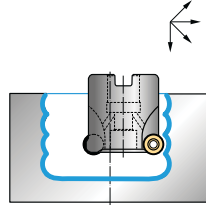

F 222					
f _{z0} [mm]					
F 2334	F 2334	F 2334	F 2010 F 2334	F 2334	
25–32	32–66	40–80	52–315	63–160	
4	5	6	8	10	
0.11	0.17	0.22	0.28	0.33	
0.09	0.13	0.15	0.22	0.28	
0.09	0.13	0.15	0.22	0.28	
0.07	0.09	0.11	0.13	0.17	
0.07	0.09	0.11	0.13	0.13	
0.11	0.17	0.22	0.28	0.33	
0.13	0.22	0.28	0.33	0.39	
0.11	0.17	0.22	0.28	0.33	
0.11	0.17	0.22	0.28	0.33	
0.07	0.09	0.11	0.11	0.11	
0.07	0.09	0.11	0.11	0.11	
0.07	0.09	0.11	0.11	0.11	
0.07	0.09	0.11	0.11	0.11	
0.07	0.10	0.15	0.20	0.25	
0.07	0.10	0.12	0.15	0.20	
RO . X 0803 . .	RO . X 10T3 . .	RO . X 1204 . .	RO . X 1605 . .	RO . X 2006 . .	
1.0	1.0	1.0	1.0	1.0	
1.2	1.2	1.2	1.2	1.2	
1.5	1.5	1.5	1.5	1.5	
1.8	1.8	1.8	1.8	1.8	
2.0	2.0	2.0	2.0	2.0	

Cutting material application tables – milling

Coated carbide																			
Walter grade designation	Standard designation	Workpiece material group							Application range							Coating procedure	Coating composition	Indexable insert example	
		P	M	K	N	S	H	O	01	05	10	15	20	25	30				35
		Steel	Stainless steel	Cast iron	NF metals	Difficult-to-machine materials	Hard materials	Other											
WKP 35 S	HC – P 35	●●																	
	HC – K 35			●●															
WKP 35	HC – P 35	●●																	
	HC – K 35			●●															
WKP 25	HC – P 25	●●																	
	HC – K 25			●●															
WAK 15	HC – K 15			●●															
WSP 45	HC – S 45					●●													
	HC – P 45	●●																	
	HC – M 45		●●																
WSM 35	HC – S 35					●●													
	HC – M 35		●●																
WKK 25	HC – K 25			●●															
WSP 46	HC – S 45					●●													
	HC – P 45	●●																	
	HC – M 45		●●																
WSM 36	HC – S 35					●●													
	HC – M 35		●●																
WHH 15	HC – H 15						●●												
	HC – P 15	●																	
	HC – K 15			●															
WXN 15	HC – N 15				●●														
WXM 15	HC – P 15	●●																	
	HC – M 15		●																
	HC – K 15			●															

BH = CBN with high CBN content
 CN = Silicon nitride Si₃N₄
 DP = Polycrystalline diamond
 HC = Coated carbide
 HF = Uncoated fine-grained carbide
 HW = Uncoated carbide

●● Primary application
 ● Other application

Cutting material application tables – milling



Uncoated carbide grades, cutting ceramics, CBN and PCD																									
Walter grade designation	Standard designation	Workpiece material group						Application range							Coating procedure	Coating composition	Indexable insert example								
		P	M	K	N	S	H	O	01	05	10	15	20	25				30	35	40	45				
		Steel	Stainless steel	Cast iron	NF metals	Difficult-to-machine materials	Hard materials	Other																	
WK 10	HW – N 10				●●																				
WMG 40	HF – N 35				●●																				
WCB 80	BH – K 05			●●																					
	BH – H 15						●																		
WCB 50	BH – H 10						●●																		
	BH – K 10			●																					
WSN 10	CN – K 20			●●																					
WCD 10	DP – N 10				●●																				

BH = CBN with high CBN content
 CN = Silicon nitride Si₃N₄
 DP = polycrystalline diamond
 HC = Coated carbide
 HF = Uncoated fine-grained carbide
 HW = Uncoated carbide

●● Primary application
 ● Other application

Geometry overview of milling indexable inserts

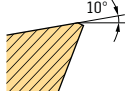
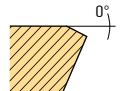
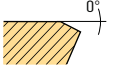
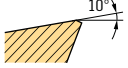
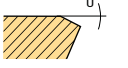
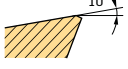
Tool families / insert geometry

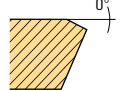
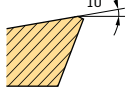
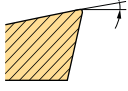
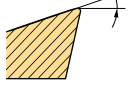
Geometry example	Remarks / field of applications	Cut Main cutting edge	Workpiece material group							Suitable tool families
			P Steel	M Stainless steel	K Cast iron	N NF metals	S Difficult-to-machine materials	H Hard materials	O Other	
	P 26335 – The easy-cutting one → for good machining conditions → low cutting forces → medium feed rates		●●	●●	●●		●●			F 2010 F 2330
	P 26337 – The stable one → for unfavourable machining conditions → maximum cutting edge stability → high feed rates		●●	●	●●		●			
	P 26339 – The universal one → for medium machining conditions → universal application for most materials	Insert corner  Main cutting edge 	●●	●●	●●		●●			
	P 26379 – The special one → for circular interpolation milling → universal application for most materials → trailing edge version	Insert corner  Main cutting edge 	●●	●●	●●		●●			
 RO . X . .	A27 – The stable one → for unfavourable machining conditions → maximum cutting edge stability → high feed rates		●●		●●				F 2010 F 2334	
	D57 – The universal one → for medium machining conditions → universal application for most materials		●●	●●	●●		●●			
	D67 – The powerful one → high cutting edge stability → for machining high-alloy and high-tensile steels and Ni-based alloys, e.g. Inconel → high level of accuracy		●●	●●	●		●●			
	G77 – The special one → for machining titanium materials → low cutting forces → high level of accuracy		●	●●			●●			

●● Primary application
 ● Other application



Tool families / insert geometry

Geometry example	Remarks / field of applications	Cut Main cutting edge	Workpiece material group							Suitable tool families
			P	M	K	N	S	H	O	
	P 23696 – The universal one → for medium to unfavourable machining conditions → universal application for most materials		••	••	••		••			F 4030
	A57 – The universal one → for medium machining conditions → universal application for most materials		••	•	••		•	••		F 4031
P 8001 . . 	D27 – The special one → for machining cast iron materials → for sand inclusions or casting skin → maximum process reliability		•		••					F 2010 F 4033 F 4047 F 4048
SN . X . .	F27 – The stable one → for unfavourable machining conditions → maximum cutting edge stability → high feed rates		••	•	••		•			
	F57 – The universal one → for medium machining conditions → universal application for most materials		••	••	••		••			
	F67 – The easy-cutting one → for good machining conditions → low cutting forces → medium feed rates		••	••	••		••			
	K88 – The sharp one → for aluminium machining → low cutting forces → sharp cutting edges						••		•	
	L55 – The universal one → for medium machining conditions → universal application for most materials		••	••	••		••			F 2010 F 4041
LNGX . .	L88 – The sharp one → for aluminium machining → low cutting forces → sharp cutting edges						••		•	

•• Primary application
• Other application



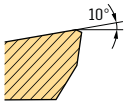
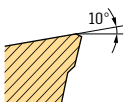
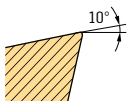
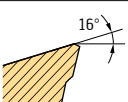
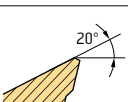
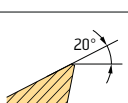
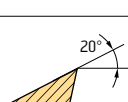

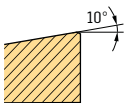
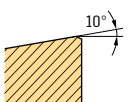
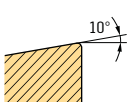
Geometry overview of milling indexable inserts

Tool families / insert geometry

Geometry example	Remarks / field of applications	Cut Main cutting edge	Workpiece material group							Suitable tool families
			P Steel	M Stainless steel	K Cast iron	N NF metals	S Difficult-to-machine materials	H Hard materials	O Other	
 AD . T . .	D51 – The quiet one → antivibration geometry → for tools with extended tool projection		••	•	••		•			F 2010 F 4042 F 4042R F 4038 F 4138 F 4238 F 4338
	D56 – The stable one → for unfavourable machining conditions → maximum cutting edge stability → high feed rates		••	•	••		•			
	D67 – The powerful one → high cutting edge stability → for machining high-alloy and high-tensile steels and Ni-based alloys → high level of accuracy		••	••	•		••			
	F56 – The universal one → for medium machining conditions → universal application for most materials		••	••	••		••			
	G56 – The easy-cutting one → for good machining conditions → low cutting forces → medium feed rates		••	••	••		••			
	G77 – The special one → for machining titanium materials → low cutting forces → high level of accuracy		•	••			••			
	G88 – The sharp one → for aluminium machining → low cutting forces → sharp cutting edges						••		•	
 XNHF . . .	D27 – The stable one → for unfavourable machining conditions → maximum cutting edge stability → high feed rates		•		••					F 4045
	D57 – the universal one → for medium machining conditions → universal application		•		••					
	D67 – The easy-cutting one → for good machining conditions → low cutting forces → medium feed rates		•		••					

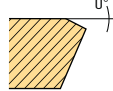
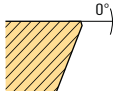
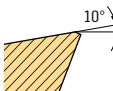
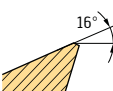
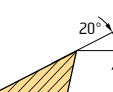
•• Primary application
 • Other application

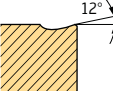
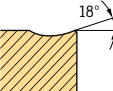
Tool families / insert geometry

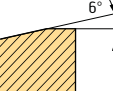
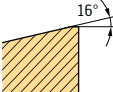
Geometry example	Remarks / field of applications	Cut Main cutting edge	Workpiece material group							Suitable tool families
			P Steel	M Stainless steel	K Cast iron	N NF metals	S Difficult-to-machine materials	H Hard materials	O Other	
 OD . .	A27 – The stable one → for unfavourable machining conditions → maximum cutting edge stability → high feed rates		••		••					F 2010 F 4080 F 4081
	A57 – The special one → for medium machining conditions → predominantly for cast iron machining		•		••					
	D57 – the universal one → for medium machining conditions → universal application for most materials		••	••	••		••			
	F57 – The easy-cutting one → for good machining conditions → low cutting forces → medium feed rates		••	••	••		••			
	G88 – The sharp one → for aluminium machining → low cutting forces → sharp cutting edges						••		•	
 LN . X . .	D57T – The stable one → for unfavourable machining conditions → maximum cutting edge stability → high feed rates		••		••					F 4053
	F57T – The universal one → for medium machining conditions → universal application for most materials		••	••	••		••			
 LN . U . .	B57T – The stable one → for unfavourable machining conditions → maximum cutting edge stability → high feed rates		••		••					F 4153 F 4253
	F57T – The universal one → for medium machining conditions → universal application for most materials		••	••	••		••			

•• Primary application
 • Other application

Setting instructions for the runout of Walter close pitch cutter F 2146

- ① Finishing cartridge
- ② Clamping wedge
- ③ Compound screw
- ④ Cap screw
- ⑤ Spring washer
- ⑥ Eccentric bolt

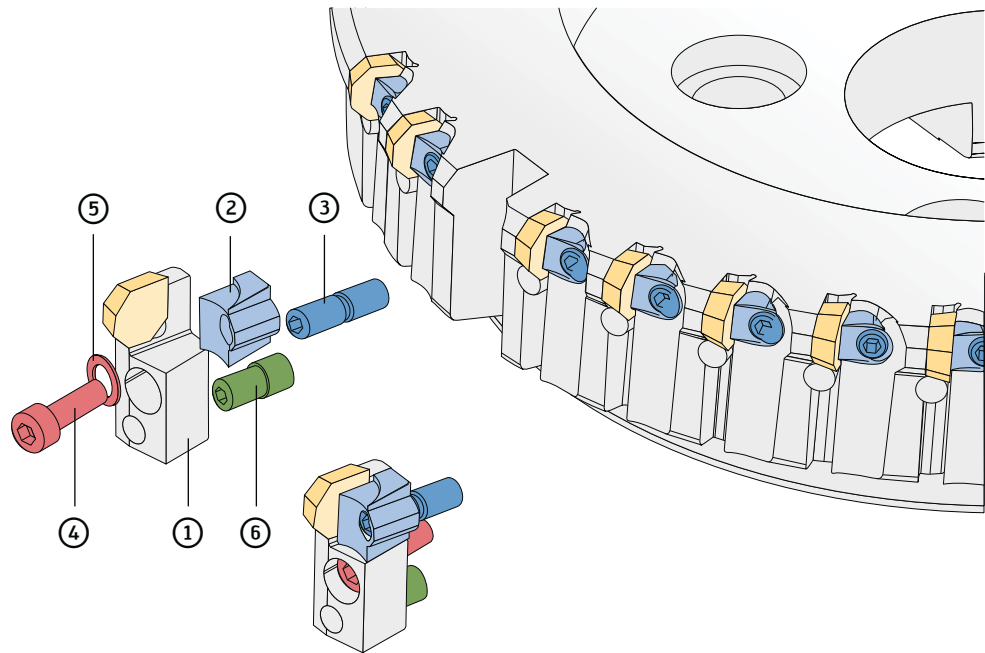

Runout amount

1. Loosen the clamping wedge ② using the compound screw ③ and press the insert corner onto the finishing cartridge ①.
2. Apply light pressure to the clamping wedge ②.
3. Pretension the cap screws ④ until the spring washers ⑤ beneath them are flattened.
4. Set cutting edges to installation height using the eccentric bolt ⑥ (remain approx. 5 µm below size).
5. Firmly tighten clamping wedge ② with compound screw ③.
6. Tighten cap screw ④ with 8 Nm of torque wrench.
7. Check the runout again.

Please note:

When using the roughing / wiper cutting edge combination, the wiper cutting edge must protrude by 0.03 – 0.04 mm. To reset the finishing cartridge, the insert must be manually pushed down.

Note:

Insert the spring washers ⑤ with the camber pointing towards the screw head.
Coat eccentric bolt ⑥ with Copper special grease (FS 663).

Setting instructions for the cutting width of Walter Side and face mill F 2252, axially adjustable

- ① Cartridge
- ② Clamping wedge
- ③ Compound screw
- ④ Eccentric bolt
- ⑤ Spring washer

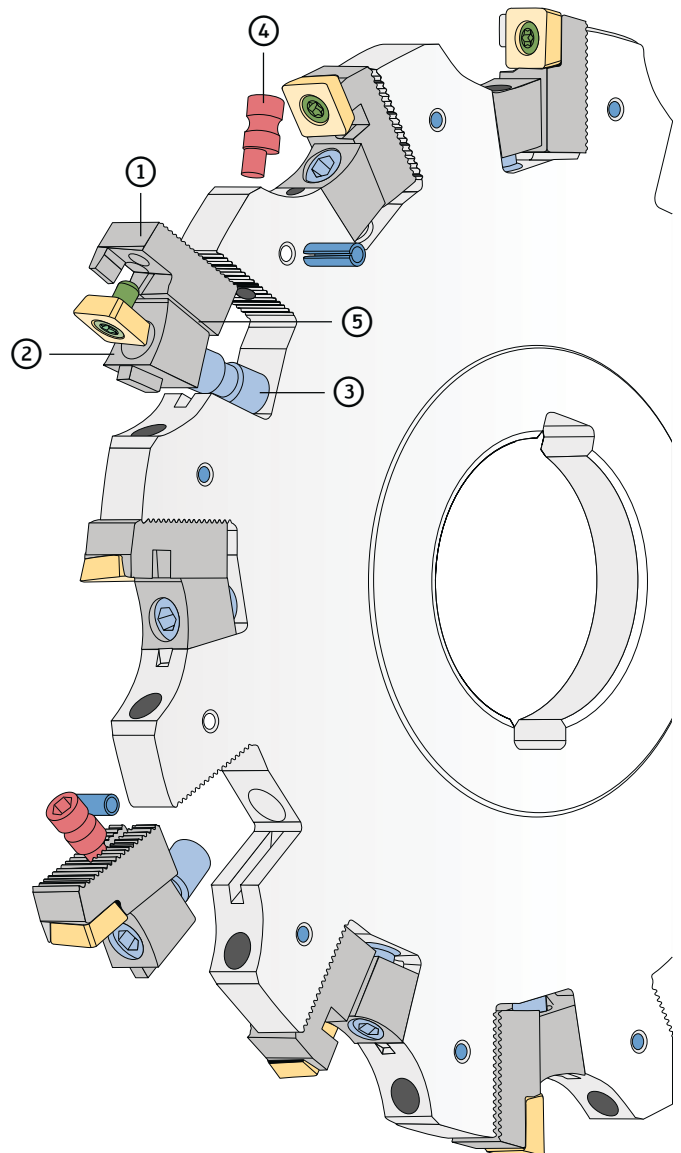

Cutting width adjustment

1. Slacken compound screw ③ of clamping wedge ② and then screw it in again until the spring washer ⑤, which is inserted between the clamping wedge and the front contact surface of the cartridge, has built up pre-tension between the clamping wedge and the cartridge.
2. Set the right-hand cartridge ① with the cutting edge of the insert to half the cutting width (symmetrical to the cutter body for a full side and face milling cutter) by turning the eccentric ④ bolt.
3. Then set the left-hand cartridge ① in the same way described in 2. (half the cutting width for full side and face milling cutters).
4. Ensure that there is sufficient tension against the eccentric bolt ④ - tighten compound screw ③ if necessary, i.e. increase the spring washer ⑤ pretension.
5. Tighten compound screw ③ with prescribed torque.
6. Check cutting width and runout again.

Note:

Coat eccentric bolt ④ and spring washer ⑤ with Copper special grease (FS 663).

Setting instructions for Walter milling cutter F 2010, Microplan

Design principle:

With this tool, the slots of the cutter have a conically countersunk threaded hole in which an adjustment screw is inserted.

This screw in turn engages in a corresponding hole of the cartridge. The cartridge can be adjusted with micro precision by screwing in the adjusting screw (see picture).



Axial fine adjustment of the Microplan milling cutter

1. Before the cartridge is installed ①, the adjusting screw ② is screwed in so that the taper is approx. 0.3–0.5 mm above the bottom of the groove.
2. Now the cartridge is installed and the clamping screw ③ is tightened. It must be ensured that the cartridge is in contact with the fixed stop (rear ring groove ④) and that the adjusting screw is not under load.

3. By tightening the adjusting ② screw clockwise, the cartridge ① can be adjusted to the required plane position.

When doing this it must be ensured that μm -precise adjustment of the adjusting screw pretension is carried out. This is achieved by turning the adjusting screw anticlockwise and reattaching it free of pretension.

There is approx. 0.2 mm of adjustment.

4. When it is put back, the adjusting screw ② must be moved back to its starting position. The cartridge ① is moved back to the axial starting position after slackening the clamping screw ③.

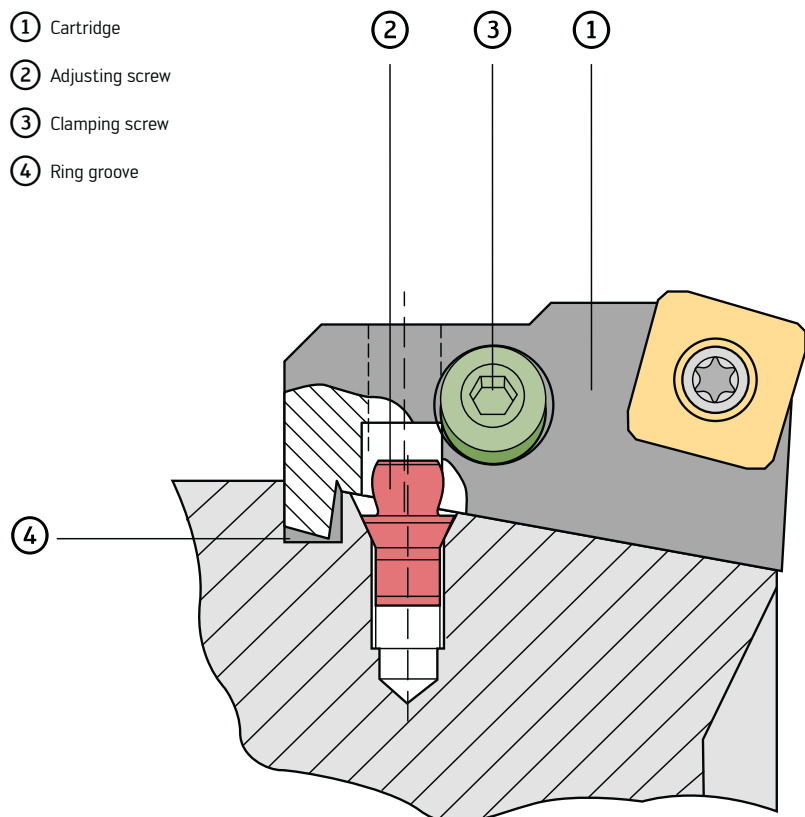

Setting instructions for the runout (and secondary cutting edge angle) of Walter Light alloy milling cutter F 2250

F 2250 with fixed insert seat

- ① Clamping screw for indexable insert
- ② PCD insert
- ③ Countersunk screw
- ④ Fine balancing screw

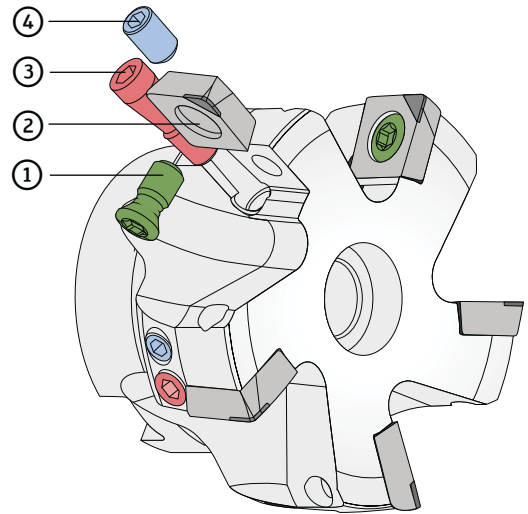

Runout amount

1. Tighten indexable inserts ② with torque of 5 Nm. Insert must not yet lie on countersunk screw ③.
2. Then fit countersunk screw ③ and pretension indexable insert with the highest installation height at approx. 0.05–0.08 mm.
3. Set all indexable inserts to the same height. Re-check the runout.

Note:

Do not re-tighten the indexable insert clamping screw ①. Coat countersunk screw with Copper special grease (FS 663).

F 2250 – Cartridge design

- ① Cap screws
- ② Eccentric bolt
- ③ Spring washer
- ④ Adjusting screw

Runout amount for 1D cartridge

1. Slacken cap screws ①.
2. Turn eccentric bolt ② until the cartridges are right at the back.
3. Pretension the cap screws ① until the spring washers ③ beneath them are flattened.
4. Set cutting edges to installation height using the eccentric bolt ② (remain approx. 4 µm below size). The cartridges can be adjusted 0.2 mm back and 0.8 mm forward in relation to the nominal installation height.
5. Tighten cap screws ① with torque of 14 Nm using a torque wrench.
6. Check the runout again.

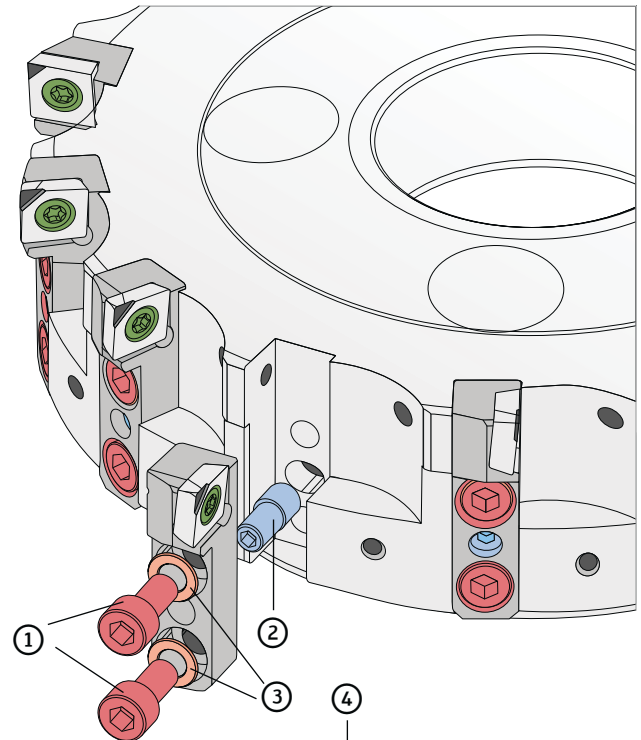

Runout and secondary cutting edge settings for 2D cartridge

1. The adjusting screw ④ must not protrude from the back of the cartridges.
2. Cartridge assembly is the same as for 1D cartridge.
3. Fasten indexable insert with a torque of 5 Nm in the insert seat. Make sure that the indexable insert rises from the outside to the inside at the front in the body.
4. Position adjusting screw ④ at indexable insert and move to required position in small steps, taking several measurements. The wrench is applied from behind the cartridge through the cutter body.
5. Set the runout in accordance with the 1D cartridge. Ensure that the wiper cutting edge SPHX 1204 PDR-A 88 is sitting 0.04 mm above the roughing insert SPHW 1204 PDR-A 88.

2D cartridge FR 595

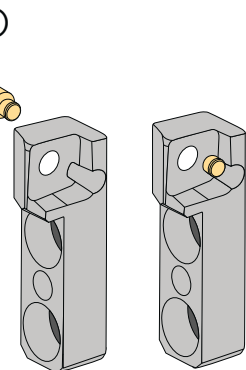

Note:

Fit spring washers ③ with camber pointing towards the screw head. Coat eccentric bolt ② and adjusting screw ④ with Copper special grease (FS 663).

Adjusting instructions for Walter side and face mill F 4253

- ① Indexable insert
- ② Clamping screw for indexable insert
- ③ Adjusting screw

Instructions for runout setting F 4253

If the tool is going to be used with a runout setting, the adjusting screws ③ must be fitted.

1. Install indexable inserts ①, tighten clamping screws ② with torque.
2. Check runout.
3. Move the highest indexable insert forward by about 0.05 mm using the adjusting screw ③.
4. Bring all other indexable inserts to the same height.
5. Re-check the runout.



Assembly instructions for Walter side and face mill F 4153 and F 4253

Assembly instructions F 4153

Please note:

Insert sizes LNHU 0803 . . and LNHU 0804 . . can be installed incorrectly.

The indexable insert is fitted correctly when the insert seat is closed on all sides and the cutting edge tapers towards the centre of the milling cutter.

correct

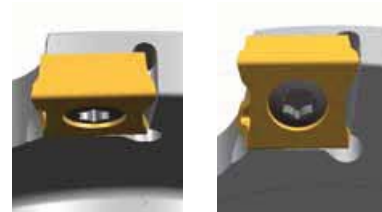

incorrect



Assembly instructions F 4253

Please note:

Insert sizes LNHU 0803 . . and LNHU 0804 . . can be installed incorrectly.

The indexable insert is fitted correctly when the insert seat is closed on all sides and the cutting edge tapers towards the centre of the milling cutter.

correct



incorrect

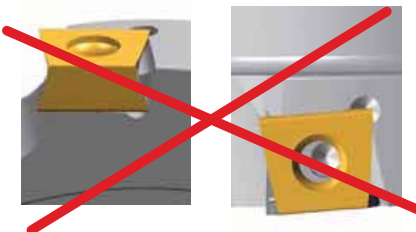

Installation instructions for Walter face / shoulder milling cutter F 2254

- ① Indexable insert SNHQ 1205 ZZN
- ② Clamping screw for indexable insert
- ③ Installation key
- ④ Compound screw

Setting instructions

1. Insert indexable insert ① into cleaned insert seat and tighten with clamping screw ② $M = 3 \text{ Nm}$. The installation key ③ must be loose during this procedure.
If necessary, release the installation key using the compound screw ④ and reinsert and tighten the indexable insert.
2. Check runout and adjust indexable insert with biggest installation height using installation key ③ approx. 0.05 mm , then set all other indexable inserts to same height. Re-check the runout.
3. Do not tighten indexable insert clamping screw ②!

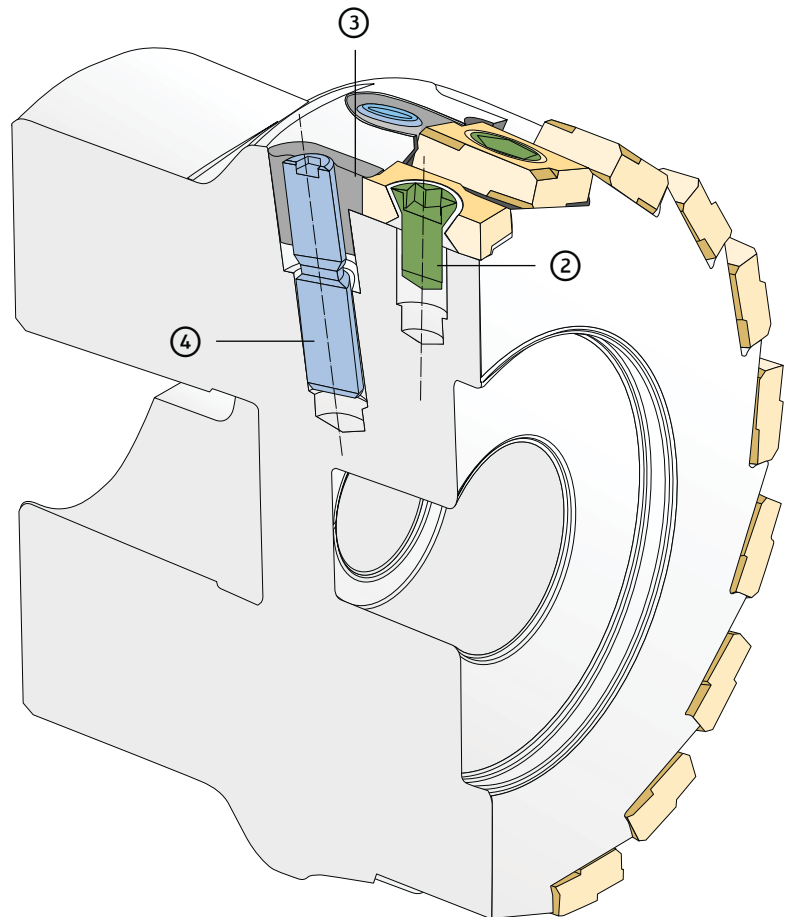
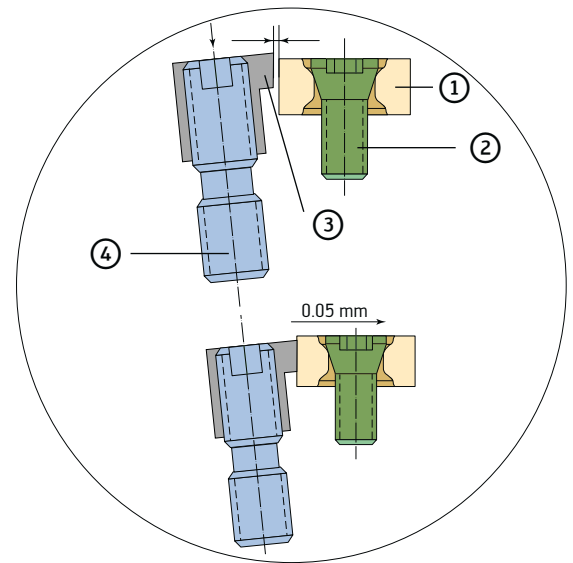

Assembly instructions for Walter slitting cutter F 2255

Slitting cutters F 2255 must always be used with two drive collars or retaining washers (order separately):

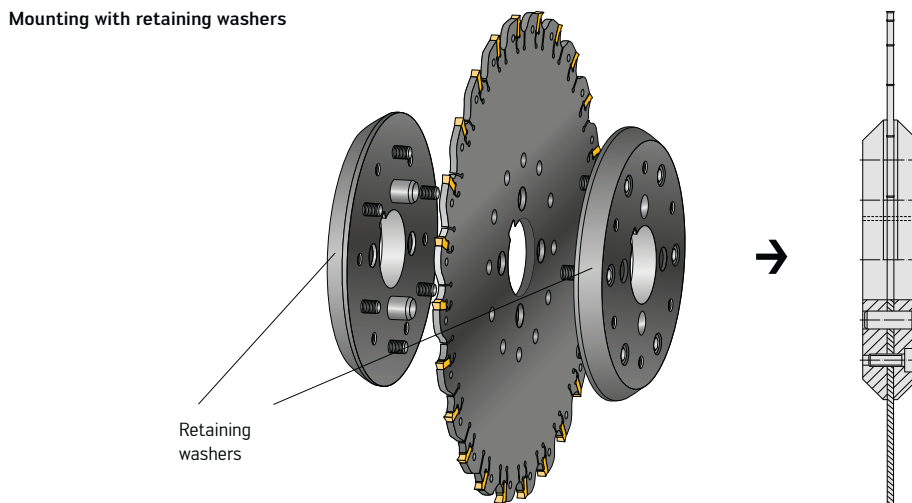
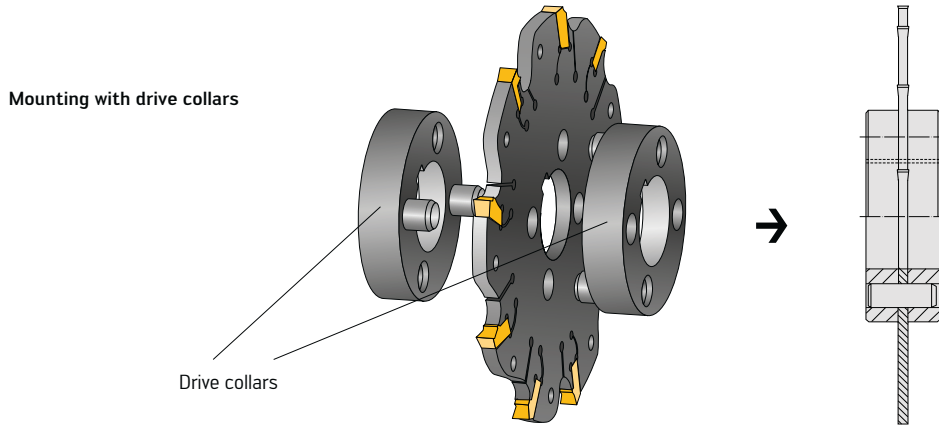

Please note:
When using retaining washers, check the measurement a_e (see page F 198).

Use of the mounting wrench:

Installing the insert

Removing the insert

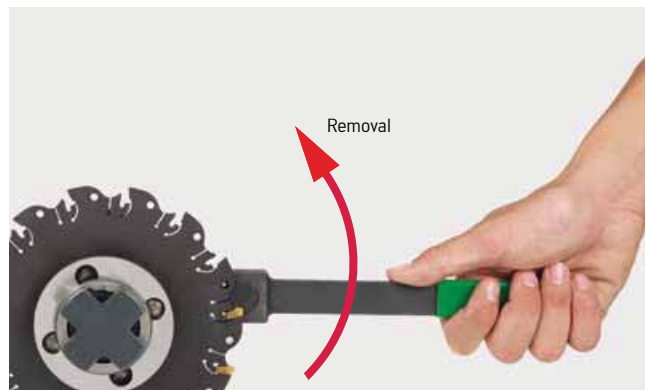
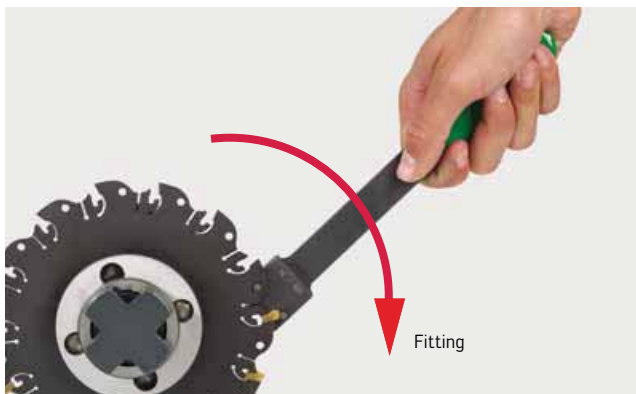

Note:

Only use mounting wrench FS 1353. When fitting the indexable insert, always position the wrench in the bore hole above the insert. N.B.: When fitting and removing, pay attention to which side of the wrench is used (different pin sizes).

Assembly instructions for Walter porcupine cutter F 2238 with front piece

- Mount the steep taper shank-type tool onto the assembly block
- Mount the tool with NCT interface and insert the collar onto the assembly block

- 1** Place clamping screw in the basic body (with hexagon socket in direction of basic body).

Then fit front piece and align drive in the front piece with drive slot in the basic body. Hold the front piece in position.

- 2** Using the socket wrench, tighten the clamping screw by **turning anticlockwise** until the front piece lies against the basic body.

- 3** Tighten the clamping screw to the left according to the specified torque.

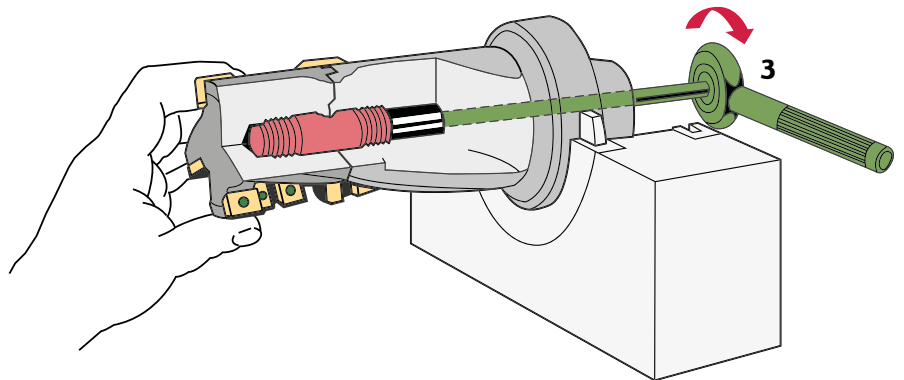
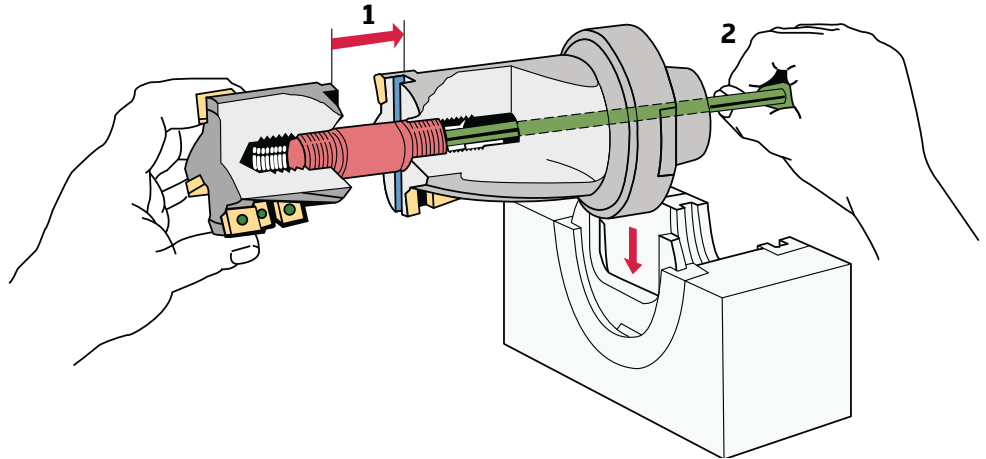

Safety instructions for the Walter ramping mill F 3040

When inserting the F 3040, observe the following:

Always tighten the indexable insert screws using a torque wrench!
For tightening torque, see table on page H 31.
N.B.: Do not grease indexable insert screws.
After 5 indexable insert replacements, replace the indexable insert screws.
Insert must be well seated in the insert seat – see illustration.
Check the balance status and concentricity of the adaptor.

Press on the indexable insert during tightening



Check with 0.01 mm spacer



N.B.: The spacer must **not** be able to fit between the indexable insert and the insert seat.

Tightening torques

Tightening torques for modular front pieces

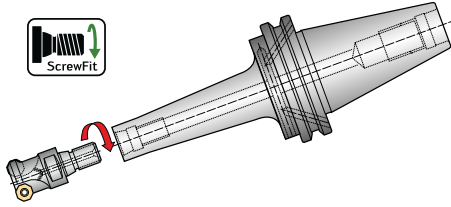

Interface	Thread	Tightening torque	Wrench size [mm]	Diameter of corresponding NCT taper
T 9	M 5	6 Nm	SW 8	–
T 14	M 8	25 Nm	SW 12	–
T 18	M 10	50 Nm	SW 14	–
T 22	M 12	80 Nm	SW 17	NCT 25/32
T 28	M 16	150 Nm	SW 21	–
T 36	M 20	200 Nm	SW 30	NCT 40/50
T 45	M 20	200 Nm	SW 36	NCT 40/50

Axial clamping system for NCT

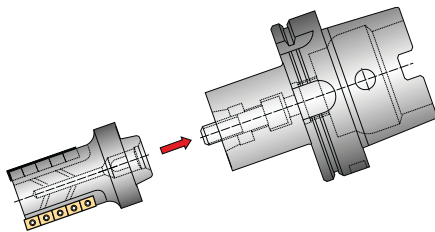

D ₂ mm	Thread	Wrench sizes	Torque wrench	Socket wrench	Tightening torque	Limit speed
25	M 8	5	FS 1385	FS 402	18 Nm	20,000 rpm
32	M 8	5	FS 1385	FS 402	18 Nm	30,000 rpm
40	M 12	8	FS 1386	FS 403	80 Nm	30,000 rpm
50	M 12	8	FS 1386	FS 403	80 Nm	30,000 rpm
63	M 16	12	FS 1386	FS 404	150 Nm	30,000 rpm
80	M 20	14	FS 1386	FS 405	200 Nm	30,000 rpm

Notes on high-speed cutting

1. Maximum permissible speeds:
The limiting values shown in the tables should not be exceeded. Otherwise functionality and / or reliability are not guaranteed.
2. Only use original Walter indexable inserts and assembly parts (screws etc.).
Recommendation: After having changed the indexable inserts at least five times, new screws should be fitted.
3. The torques specified in the catalogue must be observed.
4. Balancing
Balancing in two steps is required when milling at fast speeds (> 6,000 rpm) or at circumferential speeds of > 1,000 m/min.:
 - a. Basic balancing of the tool body including indexable inserts (can be carried out by Walter if required). In this case tool adapters that have been balanced separately beforehand must be used.
 - b. Fine balancing of the cutter when fully mounted on the adaptor. The fine balancing operation is strongly recommended as even small concentricity errors can seriously affect the balance status.
5. Short projection lengths reduce concentricity errors or an imbalance as well as increase spindle life. The specified speeds only apply to the use of tools without additional extensions.
6. Safety guards
Appropriate safety guards or machine encapsulations must be used to securely collect particles which spin off such as chips or cutting edges that are broken as a result of collisions.
7. Damaged tools:
The operating speed must be specified when arranging the repair of the HSC tool.
Only Walter may carry out repairs on Walter tools for HSC machining operations.
8. Use of standards:
Walter recommends the use of balancing standard DIN 69888, in which the balancing of tools and the chip removal area requirements are described.
DIN 69888 is tailored to the cutting area requirements, and describes the tool balancing requirements in a practical way. DIN ISO 1940, which was previously often used, describes balancing for all areas of mechanical engineering. The requirements when working at circumferential speeds of >1,000 m/min are described in DIN ISO 15641.

Walter milling cutters

Tool	Safety-related parts	related to	n_{max} [1/min] with D															
			Ø 10	Ø 16	Ø 20	Ø 25	Ø 32	Ø 40	Ø 50	Ø 63	Ø 80	Ø 100	Ø 125	Ø 160	Ø 200	Ø 250	Ø 315	
F 2010	all cartridges											6.700	6.000	5.400	4.700	4.200	3.800	3.350
F 2139¹	P 32 ..	D _c		40.000*	40.000*	40.000*	40.000*											
F 2231 Form A	RD .. 0501M0	D _a	40.000*															
	RD .. 0803M0	D _a		40.000*														
	RD .. 10T3M0	D _a			40.000*													
	RD .. 1204M0	D _a				33.300												
	RD .. 1605M0	D _a					27.200											
	RD .. 2006M0	D _a						24.300										
F 2233	SD .. 09T3 ..	D _c			40.000*	39.600	35.000	31.300	28.000	25.000	22.100	19.800						
	SP .. 1204 ..	D _c				40.000	40.000	37.600	33.600	30.000	26.600	23.800	21.200	17.000				
F 2234	RD .. 0501M0	D _a		40.000*	40.000*	40.000*												
	RD .. 07T1M0	D _a		40.000*	40.000*	40.000*	35.000	31.300										
	RD .. 0803M0	D _a		40.000*	40.000*	40.000*												
	RD .. 10T3M0	D _a			40.000*	40.000*	37.100											
	RD .. 1204M0	D _a				33.300	29.400	26.300	23.500	21.000	18.600	16.600						
	RD .. 1605M0	D _a							21.700	19.400	17.200	15.300	13.700					
F 2238	LP .. 0703 ..	D _c			40.000*	40.000*	39.900	35.700	31.900									
	LP .. 15T3 ..	D _c						21.900	19.600									
	LP .. 1504 ..	D _c							18.500	16.500	14.600	13.000	11.700					
	AP .. 2004 ..	D _c							17.300	15.500	13.700							
F 2241	SP .. 0603 ..	D _c		40.000*	40.000*	40.000*	38.500	37.600	33.600									
	SP .. 09T3 ..	D _c				40.000*	39.900	35.700	31.900	28.500	25.200	22.600	20.200	17.000				
	SP .. 1204 ..	D _c					30.800	27.600	24.600	22.000	19.500	17.400	15.600	13.800				

¹ The specified speed of 40,000 rpm refers to the entire diameters range of 8–32 mm.

* Higher speeds than 40,000 rpm are possible under favourable conditions and short projection lengths upon consultation with Walter.

Notes on high-speed cutting (continued)

Walter milling cutters

Tool	Safety-related parts	related to	n _{max} [1/min] with D															
			Ø 10	Ø 16	Ø 20	Ø 25	Ø 32	Ø 40	Ø 50	Ø 63	Ø 80	Ø 100	Ø 125	Ø 160	Ø 200	Ø 250	Ø 315	
F 2250	all cartridges	D _c								22.800	20.400	18.100	16.100	14.400	12.800	11.400	10.200	
	without cartridges SP... 1204...	D _c									22.000	19.500	17.400					
F 2255	NSM 3.900...	D _c									5.100	4.000	3.200	2.600	2.000	1.600	1.300	
F 2330	P 2633...	D _c			35.400	31.700	28.000	25.000	22.400	20.000	17.700							
F 2334	RO... 0803M0	D _a				40.000*	37.100											
	RO... 10T3M0	D _a					37.100	33.200	29.700	26.500	23.500							
	RO... 1204M0	D _a						28.200	25.200	22.500	19.900							
	RO... 1605M0	D _a							23.000	20.500	18.100	16.200	14.500					
	RO... 2006M0	D _a								19.400	17.200	15.300	13.700	12.100				
F 3040	ZD... 1504...	D _c				36.500	32.200	28.800	25.800	23.000								
	ZD... 2005...	D _c					32.200	28.800	25.800	23.000								
F 4030	P 23696-1.0	D _a				34.900	30.800	27.600	24.600	22.000								
	P 23696-1.0	D _a							20.200	18.000	15.900	14.200						
F 4031	P 8001	D _c		40.000*	40.000*	40.000*	40.000*											
F 4033	SN... X 1205...	D _c						20.000	17.900	16.000	14.200	12.700	11.300	10.000				
	SN... X 1606...	D _c						21.000	18.800	16.800	15.000	13.300	11.900	10.600	9.400	8.400	7.500	
F 4038	AD... 0803...	D _c			40.000*	38.000	33.600											
F 4138	AD... 1204...	D _c					25.100	22.400	20.000	17.900	15.800							
F 4238	AD... 1606...	D _c						15.800	14.100	12.600	11.100							
F 4338	AD... 1807...	D _c								12.600	11.100	10.000	8.900					
F 4041	LNGX 1307...	D _c					14.000	12.500	11.200	10.000	8.800	7.900	7.000	6.200	5.600	5.000		
F 4042 F 4042R	AD... 0803...	D _c		40.000*	40.000*	38.000	33.600	30.100	26.900									
	AD... 10T3...	D _c		39.600	35.400	31.700	28.000	25.000	22.400	20.000								
	AD... 1204...	D _c				28.400	25.100	22.400	20.000	17.900	15.800							
	AD... 1606...	D _c						15.800	14.100	12.600	11.100	10.000	8.900	7.900				
	AD... 1807...	D _c					17.600	15.800	14.100	12.600	11.100	10.000	8.900	7.900				
F 4045	XN... F 0705...	D _c								10.000	8.800	7.900	7.000	6.200	5.600			
	XN... F 0906...	D _c									5.700	5.100	4.600	4.000	3.600			
F 4047	SN... X 1205...	D _c						18.800	16.800	14.000	13.300	11.900	10.600	9.400	8.400			
F 4048	SN... X 1205...	D _c						18.800	16.800	14.000	13.300	11.900	10.600	9.400	8.400			
F 4080	OD... 0504...	D _a					29.400	26.300	23.500	21.000	18.600	16.600	14.900	13.100				
	OD... 0605...	D _a							19.600	17.500	15.500	13.800	12.400	10.900	9.800			
F 4081	OD... 0504...	D _a					29.400	26.300	23.500	21.000	18.600	16.600						
	OD... 0605...	D _a							19.600	17.500	15.500	13.800						
F 4053	LN... X 0702...	D _c									21.200	19.000	17.000	15.000				
F 4153	LN... U 0803...	D _c										11.000	9.900	8.800	7.800			
	LN... U 0804...	D _c										9.300	8.300	7.400	6.500			
	LN... U 1005...	D _c										13.700	12.300	11.000	9.700			
F 4253	LN... U 0804...	D _c											17.000	15.000				
	LN... U 1005...	D _c											16.100	14.200				
	LN... U 1206...	D _c											12.400	10.900	9.800	8.700		
	LN... U 1605...	D _c												7.800	7.000	6.200	5.500	

* Speeds faster than 40,000 rpm are possible under favourable conditions and with short projection lengths upon consultation with Walter.

Roughing / finishing combinations in Walter milling cutters

$\kappa = 43^\circ$	Roughing	Finishing
F 2010 	Indexable insert OD . 0605 . . Cartridge FR 592 M	Indexable insert ODHX 0605 ZZN Cartridge FR 681 M
F 4080 	Indexable insert ODH . 0504 ZZN	Indexable insert ODHX 0504 ZZR
F 4080 	Indexable insert ODH . 0605 ZZN	Indexable insert ODHX 0605 ZZR
F 2010 	Indexable insert ODH . 0605 . . Cartridge FR 592 M	Indexable insert ODHX 0605 ZZR Cartridge FR 592 M
F 2146 	Indexable insert OP . . 0504 . .	Indexable insert OPHX 0504 ZZN Cartridge FR 683
F 2146 	Indexable insert OP . . 0504 . .	Indexable insert OPHX 0504 ZZR Cartridge FR 599

$\kappa = 45^\circ$	Roughing	Finishing
F 2010 	Indexable insert SP . . 1204 A . . Cartridge FR 495 M	Indexable insert P 2905 – Gr. 1 Cartridge FR 448 M
F 2010 	Indexable insert SN . . 1205 ANN Cartridge FR 720 M	Indexable insert P 2905 – 1 Cartridge FR 448 M
F 2010 	Indexable insert SN . . 1205 ANN Cartridge FR 720 M	Indexable insert ODHX 0605 ZZN Cartridge FR 681 M
F 2010 	Indexable insert SNGX 1205 ANN – F 57 / F 67 Cartridge F 720	Indexable insert XNGX 1205 ANN – F 67 Cartridge F 730
F 4033 	Indexable insert SNGX 1205 ANN – F 57 / F 67	Indexable insert XNGX 1205 ANN – F 67

**Roughing / finishing combinations
in Walter milling cutters (continued)**

$\kappa = 75^\circ$	Roughing	Finishing
F 2010 	Indexable insert SP .. 120408 Cartridge FR 441 M	Indexable insert P 2905 – Gr. 1 Cartridge FR 448 M
F 2010 	Indexable insert SP .. 1204 EDR Cartridge FR 441 M	Indexable insert P 2901 – Gr. 1 Cartridge FR 441 M
F 2010 	Indexable insert SNGX 1205 ENN – F 57 / F 67 Cartridge FR 727	Indexable insert XNGX 1205 ENN – F 67 Cartridge FR 727
F 4047 	Indexable insert SNGX 1205 ENN – F 57 / F 67	Indexable insert XNGX 1205 ENN – F 67

$\kappa = 89^\circ 45'$	Roughing	Finishing
F 2010 	Indexable insert SP .. 120408 Cartridge FR 445 M	Indexable insert P 2905 – Gr. 1 Cartridge FR 448 M

$\kappa = 90^\circ$	Roughing	Finishing
F 2250 PKD 	Indexable insert SPHW 1204 PDR Cartridge FR 594	Indexable insert SPHX 1204 PDR Cartridge FR 595

$\kappa = 88^\circ$	Roughing	Finishing
F 2010 	Indexable insert SNGX 1205 ENN – F 57 / F 67 Cartridge FR 728	Indexable insert XNGX 1205 ENN – F 67 Cartridge FR 728
F 4048 	Indexable insert SNGX 1205 ENN – F 57 / F 67	Indexable insert XNGX 1205 ENN – F 67

Application information for octagon cutters F 4080 / F 4081

Face milling (F 4080 only)

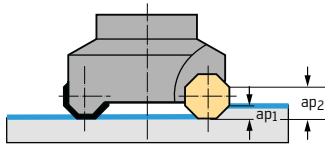

 Max. cut depth a_p [mm]

	OD .. 0504 ..	OD .. 0605 ..
a_{p1}	3	4
a_{p2}	8	10

Circular interpolation milling of a hole into solid material

Range of diameters for milling a hole in one pass [mm]

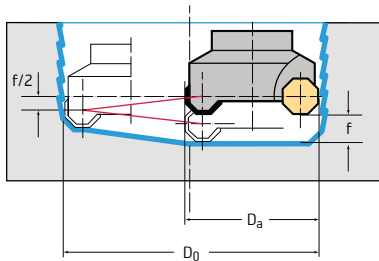
F 4080



F 4081*

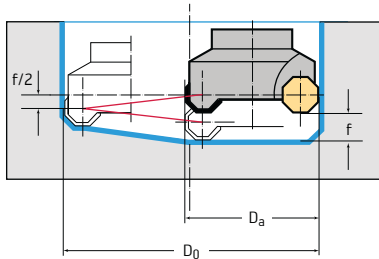

D_a [mm]	Indexable insert					
	OD .. 050408			OD .. 060508		
	$D_{0 \min}$ [mm]	$D_{0 \max}$ [mm]	f_{\max} [mm]	$D_{0 \min}$ [mm]	$D_{0 \max}$ [mm]	f_{\max} [mm]
32	40,4	64	4,5			
36	48,4	72	4,5			
40	56,4	80	4,5			
44	64,4	88	4,5			
50	76,4	100	4,5	69,5	100	5,8
52	80,4	104	4,5	73,5	104	5,8
58	92,4	116	4,5			
60				89,5	120	5,8
63	102,4	126	4,5	95,5	126	5,8
66	108,4	132	4,5	101,5	132	5,8
71	118,4	142	4,5			
73				115,5	146	5,8
80	136,4	160	4,5	129,5	160	5,8
85	146,4	170	4,5	139,5	170	5,8
88	152,4	176	4,5			
90				149,5	180	5,8
100	176,4	200	4,5	169,5	200	5,8
108	192,4	216	4,5			
110				189,5	220	5,8
125	226,4	250	4,5	219,5	250	5,8
133	242,4	266	4,5			
135				239,5	270	5,8
160				289,5	320	5,8
170				309,5	340	5,8

* With F 4081 only use indexable inserts with corner radius, e.g. ODMT 060512–D57.

Angular plunging

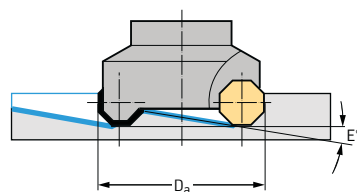
 Maximum feed angle E [°]

D_a [mm]	OD .. 0504 ..	OD .. 0605 ..	D_a [mm]	OD .. 0504 ..	OD .. 0605 ..
32	14,0		85	2,5	3,8
36	10,6		88	2,4	
40	8,3		90		4,0
44	6,9		100	2,0	3,1
50	5,5	9,6	108	2,0	
52	5,1	8,9	110		3,1
58	4,6		125	1,5	2,3
60		7,7	133	1,5	
63	3,8	6,2	135		2,3
66	3,5	5,8	160		1,7
71	3,2		170		1,7
73		5,4			
80	2,7	4,3			

Application information for octagon cutter F 4080 / F 4081 (continued)

Vertical plunging

Max. plunging depth T_{max} [mm]

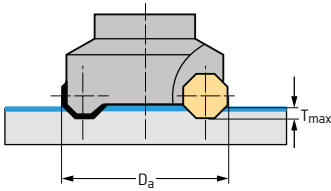

	OD .. 0504 ..	OD .. 0605 ..
T_{max}	2,8	4,0

Application information for face mill F 2233

Face milling

Max. cut depth a_p [mm]

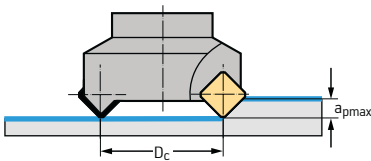

	SD .. 09T3 ..	SP .. 1204 ..
a_p	5,0	7,0

Angular plunging

Maximum feed angle E [°]

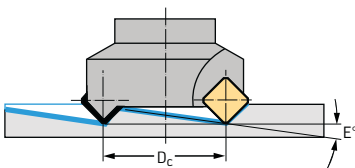

D_c [mm]	SD .. 09T3 ..	D_c [mm]	SD .. 09T3 ..	SP .. 1204 ..
20	23,4	63	5,2	N.B.: not suitable for plunging.
25	16,8	80	4,0	
32	12,0	100	3,1	
40	9,0	125	2,4	
50	6,8	160	1,9	

Vertical plunging

Max. plunging depth T_{max} [mm]

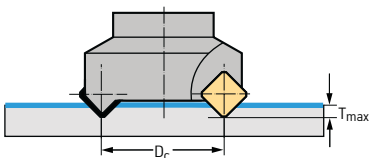

	SD .. 09T3 ..	SP .. 1204 ..
T_{max}	5,0	N.B.: not suitable for plunging.

Application information for high-performance mill F 2330

Face milling

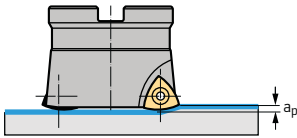
 Max. cut depth a_p [mm]

	P 2633 . – R10 P 26379 – R10	P 2633 . – R14 P 26379 – R14	P 2633 . – R25 P 26379 – R25
a_p max	1	1,5	2

Angular plunging

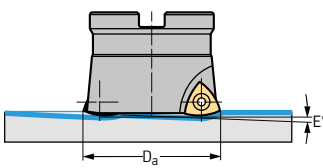
 Maximum feed angle E [°]

D_a [mm]	P 2633 . – R10 P 26379 – R10	P 2633 . – R14 P 26379 – R14	P 2633 . – R25 P 26379 – R25
20	4,0		
25	2,3		
32		2,5	
35		2,0	
40		1,5	
42		1,4	
52		1,2	2,3
66		0,9	1,4
85		0,6	1,0

Plunging

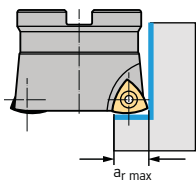
 Maximum plunging depth a_r [mm]

	P 2633 . – R10 P 26379 – R10	P 2633 . – R14 P 26379 – R14	P 2633 . – R25 P 26379 – R25
a_r max	7	10,3	15

Circular interpolation milling of a hole into solid material

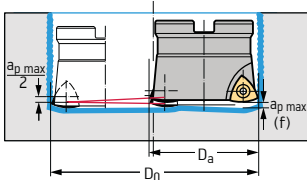

Range of diameters for milling a hole in one pass [mm]

D_a [mm]	Indexable insert					
	P 2633 . – R10 P 26379 – R10*		P 2633 . – R14 P 26379 – R14*		P 2633 . – R25 P 26379 – R25*	
	D_0 min [mm]	D_0 max [mm]	D_0 min [mm]	D_0 max [mm]	D_0 min [mm]	D_0 max [mm]
20	24,2	40				
25	34,2	50				
32			41,8	64		
35			47,8	70		
40			57,8	80		
42			61,8	84		
52			81,8	104	70,4	102,6
66			109,8	132	98,4	130,6
85			147,8	170	136,4	168,6

* Special geometry for circular interpolation milling (see geometry description on page F 296).

Application information for high-performance mill F 2330 (continued)

Programming information

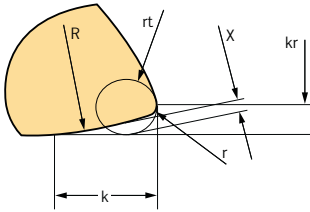

Indexable insert	R	r	rt	k	kr	X
P 2633 . – R10	10,0	0,8	2,0	4,0	1,8	0,5
P 2633 . – R14	14,0	1,2	2,5	5,5	2,6	0,8
P 2633 . – R25	25,0	2,0	3,0	8,0	3,4	0,9
P 26379 – R10	10,0	0,4	1,5	4,8	1,5	0,63
P 26379 – R14	14,0	0,4	2,2	7,2	2,2	0,91
P 26379 – R25	25,0	0,4	2,8	9,6	2,8	1,05

Programming the theoretical tool radius “rt” results in a maximum deviation from the final contour as shown. The minimal difference (only in the corners) is corrected by the subsequent tools during the remaining machining operations.

Application information for high-performance mill F 4030

Face milling

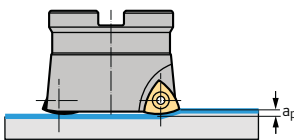

Max. cutting depth a_p [mm]

	P 23696-1.0	P 23696-2.0
$a_{p \max}$	1,0	2,0

Angular plunging

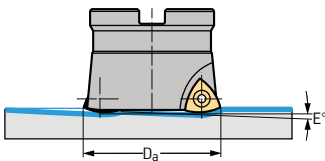

Maximum feed angle E [°]

D_a [mm]	P 23696-1.0	P 23696-2.0
25	10,5	
32	8,0	
35	7,0	
40	5,5	
42	5,0	8,5
50	3,8	7,0
52	3,5	6,5
63	2,5	4,5
66		4,0
80		3,0
85		2,5
100		2,0

Plunging

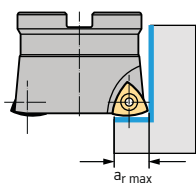

Maximum plunging depth a_r [mm]

D_a [mm]	P 23696-1.0	P 23696-2.0
25	6	
32	7	
35	7	
40	7	
42	7	9,5
50	7	10
52	7	10
63	7	10
66		10
80		10
85		10
100		10

Application information for high-performance mill F 4030 (continued)

**Circular interpolation milling
of hole into solid material**

Range of diameters for milling a hole in one pass [mm]

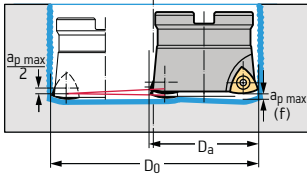

D_a [mm]	P 23696-1		P 23696-2	
	D_0 min [mm]	D_0 max [mm]	D_0 min [mm]	D_0 max [mm]
25	33	50		
32	44	64		
35	50	70		
40	59	80		
42	63	84	56	84
50	78	100	70	100
52	82	104	74	104
63	104	126	96	126
66			102	132
80			130	160
85			140	170
100			170	200

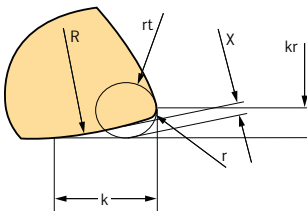
**Information about
programming**

Indexable insert	R	r	rt	k	kr	X
P 23696 – R 1.0	14	1,2	2,0	5,8	2,1	0,6
P 23696 – R 2.0	18	1,6	3,5	9,2	3,5	1,1

Programming the theoretical tool radius "rt" results in a maximum deviation from the final contour as shown. The minimal difference (only in the corners) is corrected by the subsequent tools during the remaining machining operations.

Application information for ramping mill F 3040

Shoulder milling

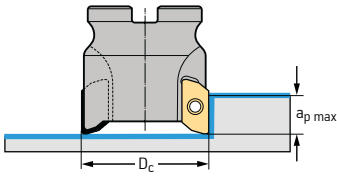

Max. cutting depth a_p [mm]

Corner radius [mm]	ZD .. 1504 ..	ZD .. 2005 ..
0,4	16,0	21,3
0,8	16,0	21,3
1,2	15,9	21,2
1,6	15,8	21,0
2,0	15,7	20,9
2,5	15,5	20,8
3,0	15,4	20,6
4,0	15,1	20,3
5,0		20,0
6,0		19,8
6,4		19,7

Angular plunging

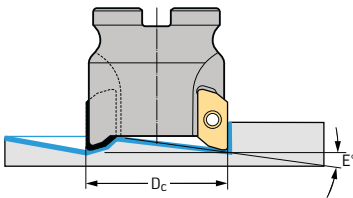

Maximum feed angle E [°]

D_c [mm]	ZD .. 1504 ..	ZD .. 2005 ..
25	16	
32	11	16
40	7	12
50	5	8
63	4	6

Vertical plunging

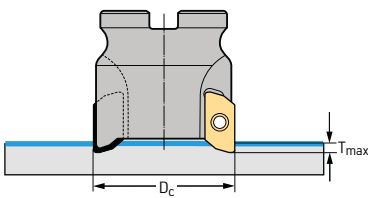

Max. plunging depth T_{max} [mm]

Corner radius [mm]	ZD .. 1504 ..	ZD .. 2005 ..
0,4	4,5	6,0
0,8	4,5	6,0
1,2	4,4	5,9
1,6	4,2	5,7
2,0	4,1	5,6
2,5	4,0	5,5
3,0	3,8	5,3
4,0	3,5	5,0
5,0		4,7
6,0		4,5
6,4		4,4

Circular interpolation milling of a hole into solid material

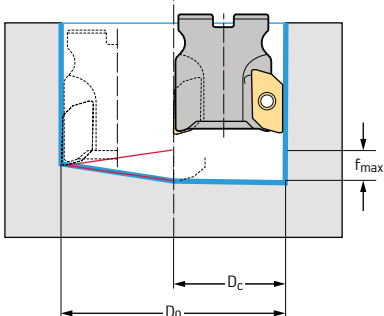

Possible bore diameters and axial feeds

Mill Ø D_c [mm]	ZDGT 1504			ZDGT 2005		
	D_0 min [mm]	D_0 max [mm]	f_{max} [mm]	D_0 min [mm]	D_0 max [mm]	f_{max} [mm]
25	31	50	5,4			
32	45	64	7,9	38	64	5,4
40	61	80	8,1	54	80	9,3
50	81	100	8,5	74	100	10,6
63	107	126	9,7	100	126	12,2

Application information for shoulder mill F 4042 / F 4042R

Angular plunging and circular interpolating into solid material

Plunging with shoulder mill F 4042 / F 4042R

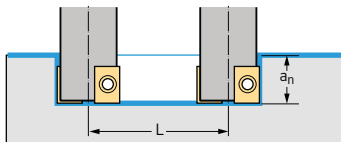
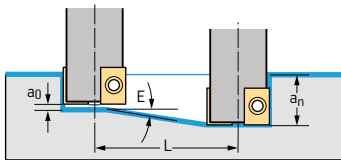
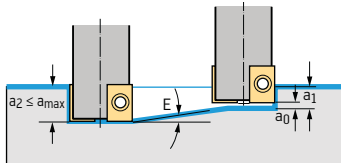
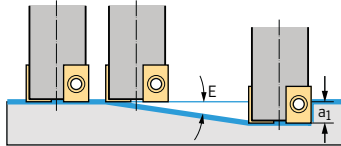

Mill Ø D _c [mm]	Plunging angle E _{max} [°]	AD .. 080304 a _{p max} = 8 mm			AD .. 10T3 .. a _{p max} = 10 mm		
		D _{0 min} [mm]	D _{0 max} [mm]	a ₀ [mm]	D _{0 min} [mm]	D _{0 max} [mm]	a ₀ [mm]
10	12,1	15	20	0,75			
12	9,9	17	24	0,8			
16	13,7	21	32	2,0	6,6	20	32
20	8,9	29	40	1,9	2,9	28	40
25	5,6	39	50	1,7	2	38	50
32	3,8	53	64	1,6	1,4	52	64
40	2,8	69	80	1,6	1,1	68	80
50	2,2	89	100	1,6	0,8	88	100
63					0,6	114	126

Plunging with shoulder mill F 4042

Mill Ø D _c [mm]	Plunging angle E _{max} [°]	AD .. 120408 a _{p max} = 11 mm			AD .. 160608 a _{p max} = 15 mm		
		D _{0 min} [mm]	D _{0 max} [mm]	a ₀ [mm]	D _{0 min} [mm]	D _{0 max} [mm]	a ₀ [mm]
25	8,5	36	50	2,3			
32	5,6	50	64	2,2			
40	3,9	66	80	2,1	5,9	62	80
50	2,7	86	100	1,9	3,9	82	100
63	2,0	112	126	1,9	2,6	108	126
80	1,5	146	160	1,9	1,9	142	160
100					1,5	182	200
120					1,2	232	250
160					0,9	302	320

Plunging with shoulder mill F 4042

Mill Ø D _c [mm]	Plunging angle E _{max} [°]	AD .. 180712 a _{p max} = 16 mm		
		D _{0 min} [mm]	D _{0 max} [mm]	a ₀ [mm]
50	2,9	74	100	1,7
63	2,1	100	126	1,7
80	1,5	134	160	1,7
100	1,2	174	200	1,7
120	0,9	224	250	1,7
160	0,7	294	320	1,7

Groove depth after 2 plunging operations:

$$a_2 = 2 \cdot L \cdot \tan E - a_0$$

Number of inclined plunging operations:

$$n = \frac{(a_n - a_0)}{(L \cdot \tan E_{\max} - a_0)}$$

Groove depth after angular plunging:

$$a_n = n \cdot L \cdot \tan E - (n-1) \cdot a_0$$

Feed angle:

$$\tan E = \frac{[a_n + (n-1) \cdot a_0]}{(n \cdot L)}$$

Explanation of letter symbols

a ₀	[mm]	amount by which the tool is to be lifted off at the end of plunging before starting the next plunging operation
a _n	[mm]	groove depth
a _{max}	[mm]	max. tool cutting depth
E	[°]	feed angle
L	[mm]	groove length without radius
n		number of plunging operations into inclined surface

Application information for shoulder mill F 4042 / F 4042R (continued)

Circular interpolation milling

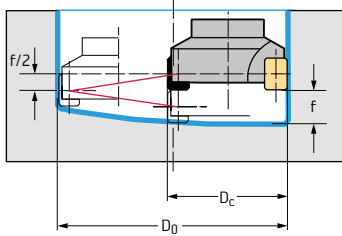

Max. axial feed per tool revolution ("thread pitch") f [mm]

Machined hole Ø D ₀ [mm]	AD . . 080304 D _c [mm]								AD . . 10T3 . . D _c [mm]							
	10	12	16	20	25	32	40	50	16	20	25	32	40	50	63	
15	3,4															
20	6,7	4,4								1,5						
30	8,0	8,0	8,0	4,9						5,1	1,6					
40	8,0	8,0	8,0	8,0	4,7					8,7	3,2	1,6				
50	8,0	8,0	8,0	8,0	7,8					10,0	4,8	2,7				
60	8,0	8,0	8,0	8,0	8,0	5,8				10,0	6,4	3,8	2,1			
80	8,0	8,0	8,0	8,0	8,0	8,0	6,2			10,0	9,5	6,0	3,7	2,4		
100	8,0	8,0	8,0	8,0	8,0	8,0	8,0	6,0		10,0	10,0	8,2	5,2	3,6	2,2	
120	8,0	8,0	8,0	8,0	8,0	8,0	8,0	8,0		10,0	10,0	10,0	6,8	4,8	3,1	
150	8,0	8,0	8,0	8,0	8,0	8,0	8,0	8,0		10,0	10,0	10,0	9,1	6,6	4,4	
180	8,0	8,0	8,0	8,0	8,0	8,0	8,0	8,0		10,0	10,0	10,0	10,0	8,4	5,7	
200	8,0	8,0	8,0	8,0	8,0	8,0	8,0	8,0		10,0	10,0	10,0	10,0	9,7	6,6	
250	8,0	8,0	8,0	8,0	8,0	8,0	8,0	8,0		10,0	10,0	10,0	10,0	10,0	8,8	

Max. axial feed per tool revolution ("thread pitch") f [mm]

Machined hole Ø D ₀ [mm]	AD . . 120408 D _c [mm]						AD . . 160608 D _c [mm]						
	25	32	40	50	63	80	40	50	63	80	100	125	160
40	7,0												
50	11,0	5,5											
60	11,0	8,6											
80	11,0	11,0	8,7				13,1						
100	11,0	11,0	11,0	7,4			15,0	10,8					
120	11,0	11,0	11,0	10,3	6,4		15,0	15,0	8,1				
150	11,0	11,0	11,0	11,0	9,7	3,4	15,0	15,0	12,4	7,5			
180	11,0	11,0	11,0	11,0	11,0	5,9	15,0	15,0	15,0	10,7			
200	11,0	11,0	11,0	11,0	11,0	8,5	15,0	15,0	15,0	12,8	8,2		
250	11,0	11,0	11,0	11,0	11,0	10,2	15,0	15,0	15,0	15,0	12,3	8,0	
300	11,0	11,0	11,0	11,0	11,0	11,0	15,0	15,0	15,0	15,0	15,0	11,2	
350	11,0	11,0	11,0	11,0	11,0	11,0	15,0	15,0	15,0	15,0	15,0	14,4	9,3
400							15,0	15,0	15,0	15,0	15,0	15,0	11,7
450							15,0	15,0	15,0	15,0	15,0	15,0	14,2
500							15,0	15,0	15,0	15,0	15,0	15,0	15,0

Max. axial feed per tool revolution ("thread pitch") f [mm]

Machined hole Ø D ₀ [mm]	AD . . 180712 D _c [mm]					
	50	63	80	100	125	160
80	4,8					
100	7,9	4,2				
120	11,1	6,5				
150	15,9	10,0	5,9			
180	16,0	13,4	8,4	5,1		
200	16,0	15,7	10,1	6,4		
250	16,0	16,0	14,3	9,6	6,1	
300	16,0	16,0	16,0	12,8	8,6	5,2
350	16,0	16,0	16,0	16,0	11,1	7,1
400	16,0	16,0	16,0	16,0	13,5	8,9
450	16,0	16,0	16,0	16,0	16,0	10,8
500	16,0	16,0	16,0	16,0	16,0	12,6

Application information for ball nose cutters F 2139 / F 2239 / F 2339

Line-by-line milling

Groove depth:

$$t_R = 0.5 \cdot (D_c - \sqrt{D_c^2 - b_R^2})$$

0.3 to 0.5 mm material removal when finishing depending on tool diameter

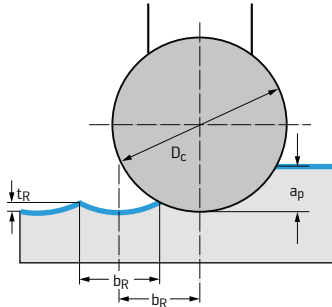

Recommendations when copy finishing F 2139

Tool Ø D_c [mm]	Row width b_R [mm]	Groove depth t_R [mm]
8	0,5	0,008
10	0,6	0,009
12	0,7	0,010
16	0,8	0,010
20	1,0	0,012
25	1,2	0,014
30	1,3	0,014
32	1,4	0,015

Semi-finishing – roughing

Example:

$D_c = 32 \text{ mm}$
 $b_R = 4 \text{ mm}$
 $\rightarrow t_R = 0.125 \text{ mm}$

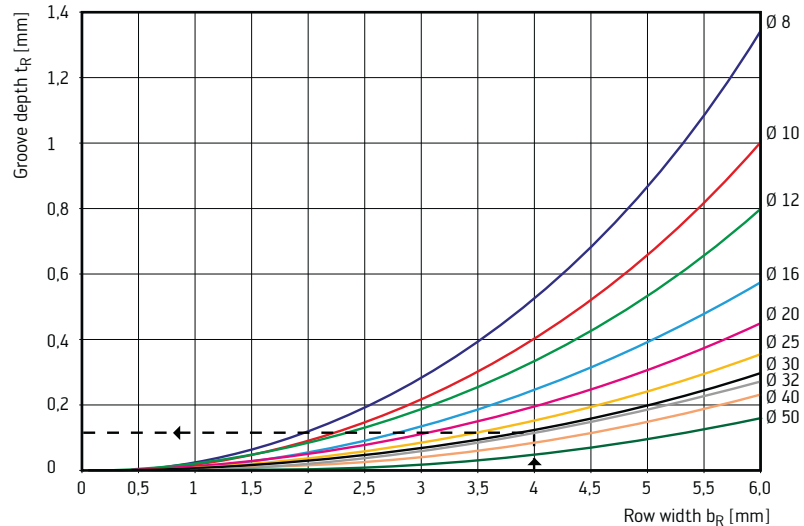

Finishing

Example:

$D_c = 20 \text{ mm}$
 $b_R = 1.0 \text{ mm}$
 $\rightarrow t_R = 0.0125 \text{ mm}$

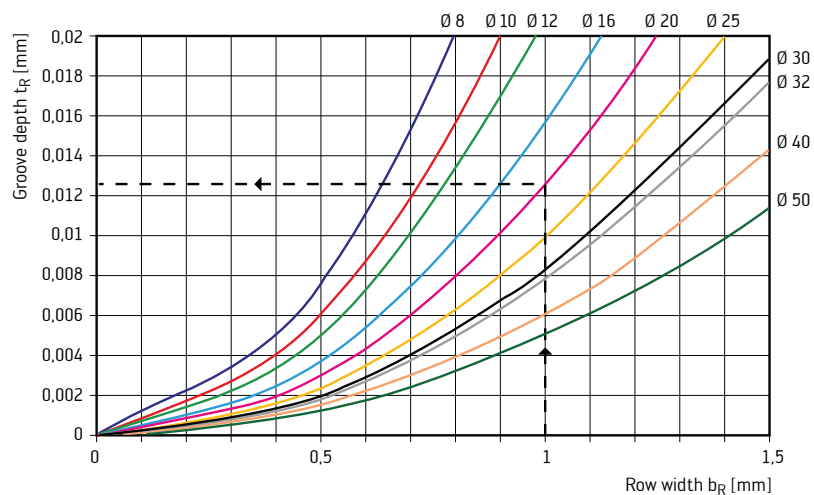

Application information for ball nose cutters F 2139 / F 2239 / F 2339 (continued)

Determining the effective cutting diameter

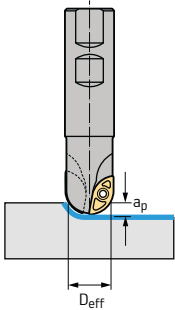

Example:

$D_c = 12 \text{ mm}$
 $a_p = 1.5 \text{ mm}$
 $\rightarrow D_{\text{eff}} = 8 \text{ mm}$

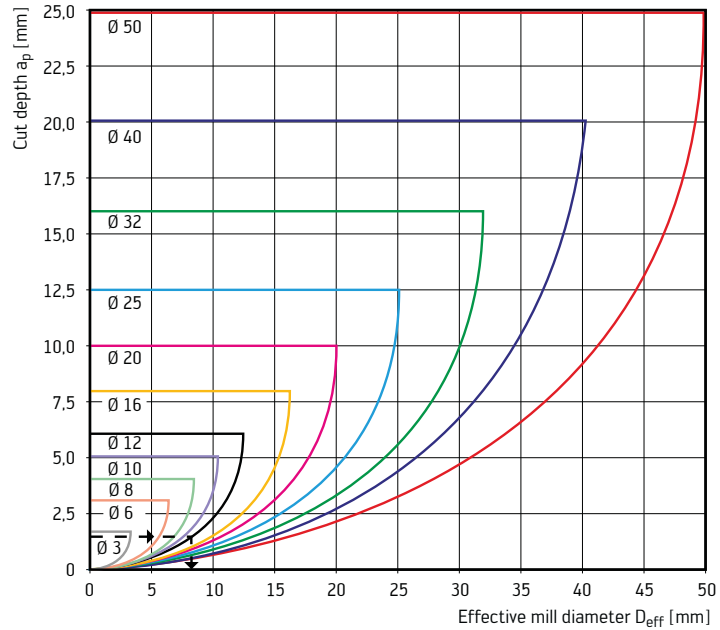

Determining the required number of revolutions

Example:

$D_{\text{eff}} = 8 \text{ mm}$
 $v_c = 300 \text{ m/min}$
 $\rightarrow n = 12,000 \text{ rpm}$

$$n = \frac{v_c \cdot 1000}{\frac{1}{4} \cdot D_{\text{eff}}} \text{ [rpm]}$$

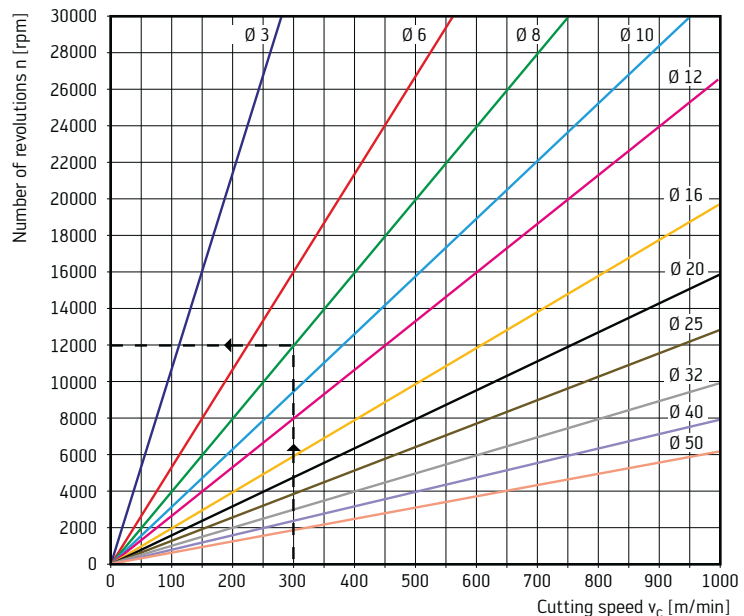

Radial plunging with F 2239 B

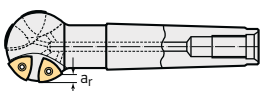

Radial plunging

Tool Ø D _c [mm]	a _r [mm]	Tool Ø D _c [mm]	a _r [mm]
20	2,0	32	4,4
25	2,8	40	4,6
30	3,5	50	5,0

Application information for round insert cutters F 2231 / F 2234 / F 2334

Face milling

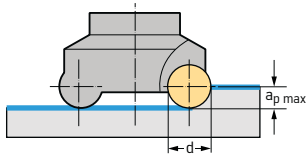
 Max. milling depth $a_{p \max}$ [mm]

$a_{p \max}$ [mm]	Indexable insert diameter d [mm]							
	$d = 5$	$d = 7$	$d = 8$	$d = 10$	$d = 12$	$d = 15$	$d = 16$	$d = 20$
	2,5	3,5	4,0	5,0	6,0	7,5	8,0	10,0

Circular interpolation milling of a hole into solid material

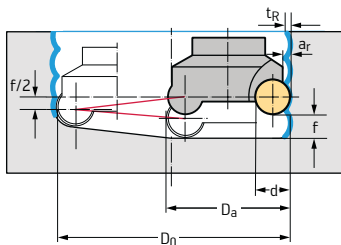
 F 2334:
Range of diameters for milling a hole in one pass [mm]

D_a [mm]	Indexable insert diameter d [mm]									
	$d = 8$		$d = 10$		$d = 12$		$d = 16$		$d = 20$	
	$D_0 \min$ [mm]	$D_0 \max$ [mm]	$D_0 \min$ [mm]	$D_0 \max$ [mm]	$D_0 \min$ [mm]	$D_0 \max$ [mm]	$D_0 \min$ [mm]	$D_0 \max$ [mm]	$D_0 \min$ [mm]	$D_0 \max$ [mm]
25	34,6	50								
32	48,4	64	45	64						
40			61	80	57,4	80				
50			81,4	100	77,2	100				
52			85	104	81,2	104	75,4	104		
63			102,4	126	103,2	126	97,6	126		
66			113	132	109,4	132	103,4	132	97	132
80					137,8	160	131,4	160	124,8	160
96							163,4	192		
100							171,4	200	164,8	200
116							203,4	232		
125							221,4	250	214,8	250
141							253,4	282		
160									284,8	320

Application information for round insert cutters F 2231 / F 2234 / F 2334 (continued)

F 2231 / F 2234: Range of diameters for milling of a bore in one pass [mm]																
D _a [mm]	Indexable insert diameter d [mm]															
	d = 5		d = 7		d = 8		d = 10		d = 12		d = 15		d = 16		d = 20	
	D _{0 min} [mm]	D _{0 max} [mm]	D _{0 min} [mm]	D _{0 max} [mm]	D _{0 min} [mm]	D _{0 max} [mm]	D _{0 min} [mm]	D _{0 max} [mm]	D _{0 min} [mm]	D _{0 max} [mm]	D _{0 min} [mm]	D _{0 max} [mm]	D _{0 min} [mm]	D _{0 max} [mm]	D _{0 min} [mm]	D _{0 max} [mm]
10	10	20														
12	14,7	24														
15	20,7	30	16	30												
16					16	32										
20	30,6	40	27,2	40			20	40								
24									24	48						
25			37	50	35,2	50	31,6	50								
30			47,1	60			41,3	60			30	60				
32							45,3	64					32	64		
35			57,2	70			51,3	70	47,8	70						
40									57,6	80					40	80
42			71,3	84					61,3	84						
50									77,6	100			69,2	100		
52							84,7	104	80,3	104			72,7	104		
63									103,6	126			95,2	126	88,7	126
66													100,1	132		
80									137,6	160			129,2	160	122,7	160
100									177,6	200			169,2	200	162,7	200
125													219,2	250	212,7	250
160															282,7	320

Groove depth on the hole wall t _R [mm]									
axial feed rate per revolution f [mm]	Indexable insert diameter d [mm]								
	d = 5	d = 7	d = 8	d = 10	d = 12	d = 15	d = 16	d = 20	
1	0,051	0,036	0,031	0,025	0,02	0,017	0,015	0,01	
2	0,209	0,146	0,127	0,101	0,08	0,067	0,06	0,05	
3	0,500	0,338	0,292	0,230	0,19	0,15	0,14	0,11	
4			0,536	0,417	0,34	0,27	0,25	0,20	
5			0,878	0,670	0,54	0,43	0,40	0,32	
6				(1,000)	0,80	0,63	0,58	0,46	
7				(1,429)	(1,12)	0,87	0,81	0,63	
8					(1,53)	(1,16)	(1,07)	0,84	
a _{r max}	0,5	0,5	1,25	1,5	2,0	2,3	3,0	4,5	

The values in brackets only apply to short bores.

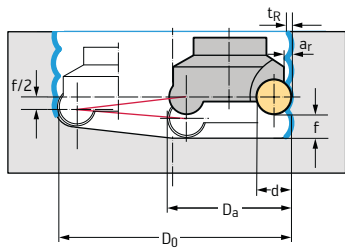

Application information for round insert cutters F 2231 / F 2234 / F 2334 (continued)

Angular plunging

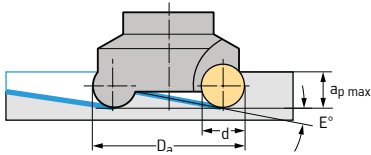

F 2334: Max. feed angle E [°]

D _a [mm]	Indexable insert diameter d [mm]				
	d = 8	d = 10	d = 12	d = 16	d = 20
25	10,5				
32	6,8	8,6			
40		5,8	7,9		
50		4,0	5,4		
52		3,9	5,3	6,1	
63		3,0	3,4	4,4	
66		2,8	3,4	4,1	5,3
80			2,6	3,1	3,9
96				2,4	
100				2,3	2,8
116				1,9	
125				1,7	2,1
141				1,5	
160					1,5
a _{p max} [mm]	6,9	8,8	10,5		1,9

F 2234: Max. feed angle E [°]

D _a [mm]	Indexable insert diameter d [mm]						
	d = 5	d = 7	d = 8	d = 10	d = 12	d = 16	d = 20
12	14,4						
15	8,8	43,7					
20	5,7	9,2					
25	7,9	6,2	7,9	14,6			
30		4,5		9,6			
32				8,0			
35		3,4		6,9	8,5		
40					11,4		
42		2,5			7,0		
50					7,9	15	
52				8,8	7,4	18,5	
63					5,6	10,1	10,9
66						9,4	
80					4,1	7,1	7,3
100					3,1	5,2	5,2
125						3,9	3,8
160							2,8
a _{p max} [mm]	4,1	5,4	5,9	7,9	10,4	12,6	16,6

Application information for round insert cutters F 2231 / F 2234 / F 2334 (continued)

Vertical plunging

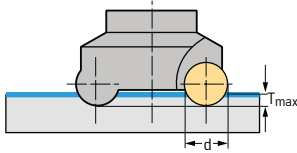

F 2334: Max. plunging depth T_{max} [mm]

T_{max} [mm]	Indexable insert diameter d [mm]				
	d = 8	d = 10	d = 12	d = 16	d = 20
	2,4	2,6	3,1	1,2	1,6

F 2231 / F 2234: Max. plunging depth T_{max} [mm]

T_{max} [mm]	Indexable insert diameter d [mm]							
	d = 5	d = 7	d = 8	d = 10	d = 12	d = 15	d = 16	d = 20
	1,1	1,5	1,9	2,5	4,5	6,0	7,0	6,5

Up milling of steep surfaces

F 2231 / F 2234: Max. plunging depth T_{max} [mm]

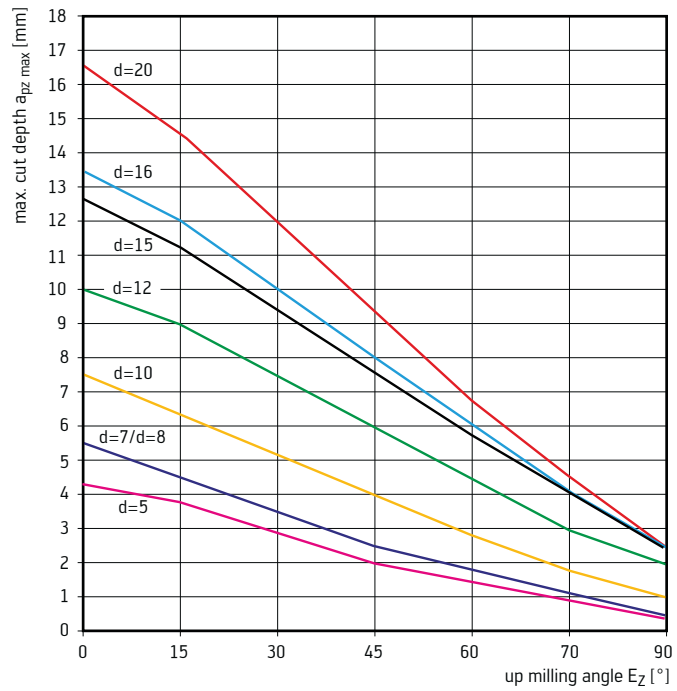
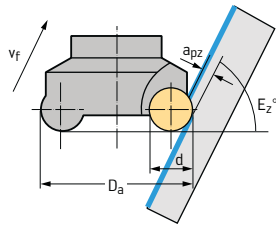

Application information for torus cutter F 4031

Angular plunging

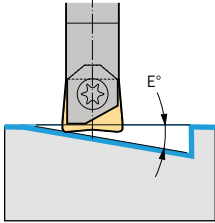

D_c [mm]	Max. feed angle E [°]	
Ø 12	8	
Ø 16	8	
Ø 20	8	
Ø 25	8	
Ø 32	8	





CONTENTS

Adaptors and Clamping Units

	Product range overviews	G 2
	Designation key	G 9
Walter Capto™ clamping units and adaptors	Walter Capto™ clamping units	G 10
	Walter Capto™ adaptors	G 14
	Assembly parts and accessories for Walter Capto™	G 28
	Technical information for Walter Capto™	G 110
Boring bar adaptors	Cylindrical boring bar adaptors with self-centring	G 27
Walter NC Tools Masters, intermediate elements and adaptors	Master NCT	G 42
	NCT intermediate elements	G 48
	NCT adaptors	G 51
	Adaptors for ScrewFit front pieces	G 67
Adaptors for ConeFit™ milling heads		G 81
HSK adaptors	Master NCT	G 87
	HSK adaptors	G 88
Assembly parts and accessories for rotary adaptors	Quick change inserts	G 98
	Collets	G 99
	Sealing discs	G 102
	Assembly parts and accessories	G 104
Technical Information	Walter Capto™ clamping units and adaptors	G 110
	Rotary adaptors	G 114

Product range overview of Walter Capto™ clamping units and adaptors

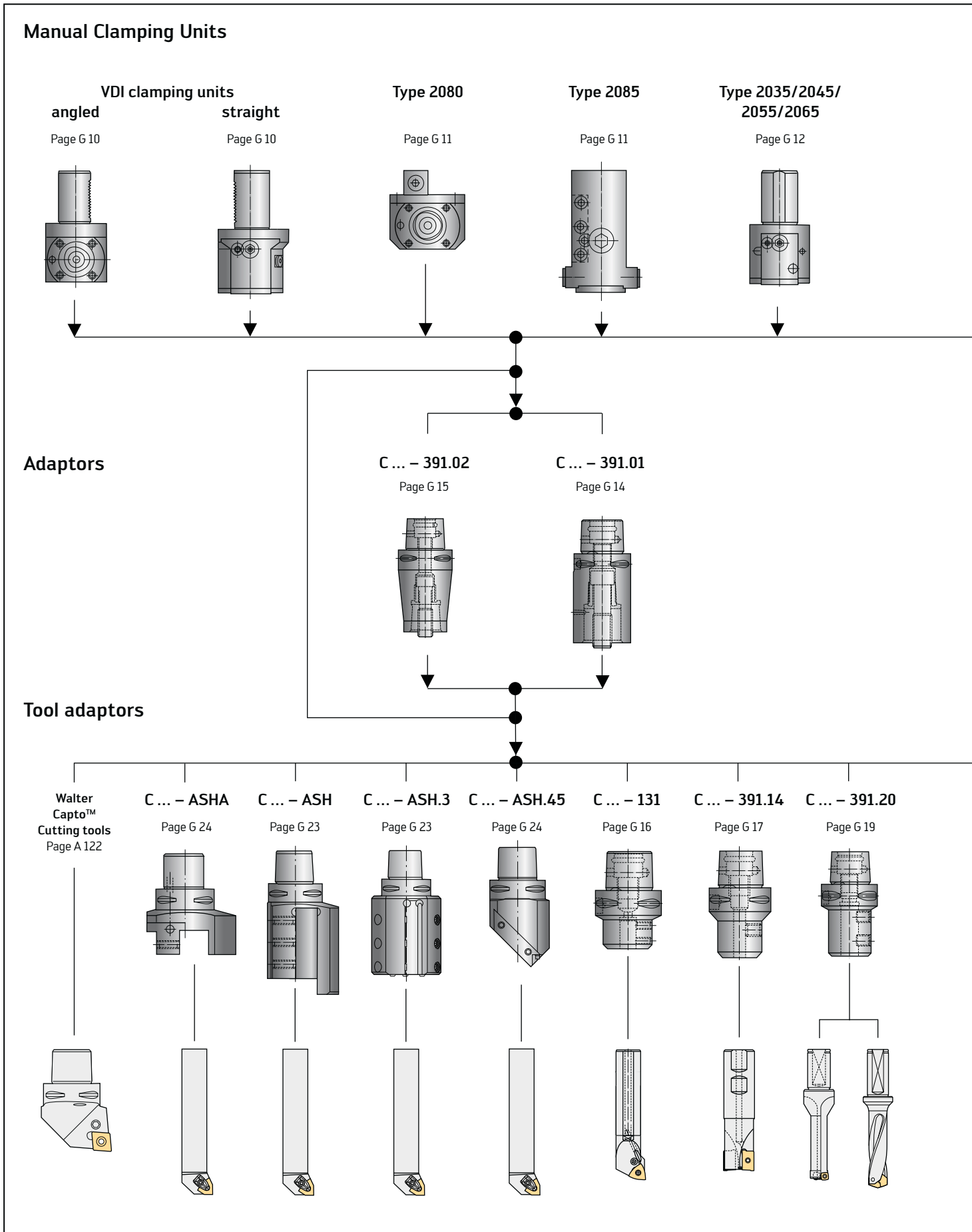

**Type 2000/
3000**

Page G 12

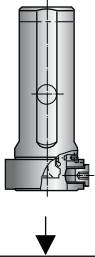

Type 2090

Page G 13

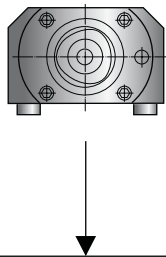

**HSK Capto
type C ... – 390.410**

Page G 26

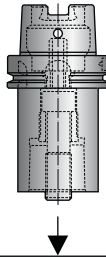

**Driven
Walter Capto™
Toolholder
on request**



**Walter Capto™
Special clamping
units
on request**



C ... – 391.27

Page G 21

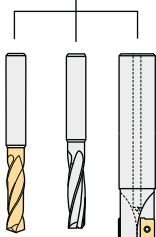
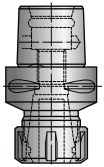

C ... – 391.60

Page G 22

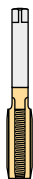
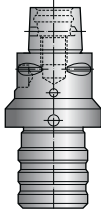

AK 155.8.C

Page G 25

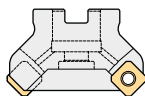
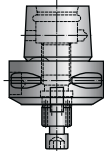

AK 580.C

Page G 80

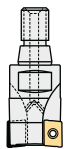
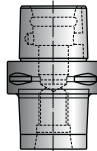

AK 681

Page G 86

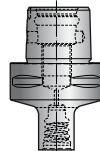

A 100 M.8

Page G 47

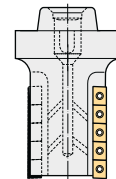
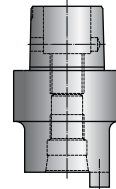

**Walter Capto™
Hydro-expansion
chuck
on request**

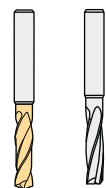

Product range overview of Walter NC Tools

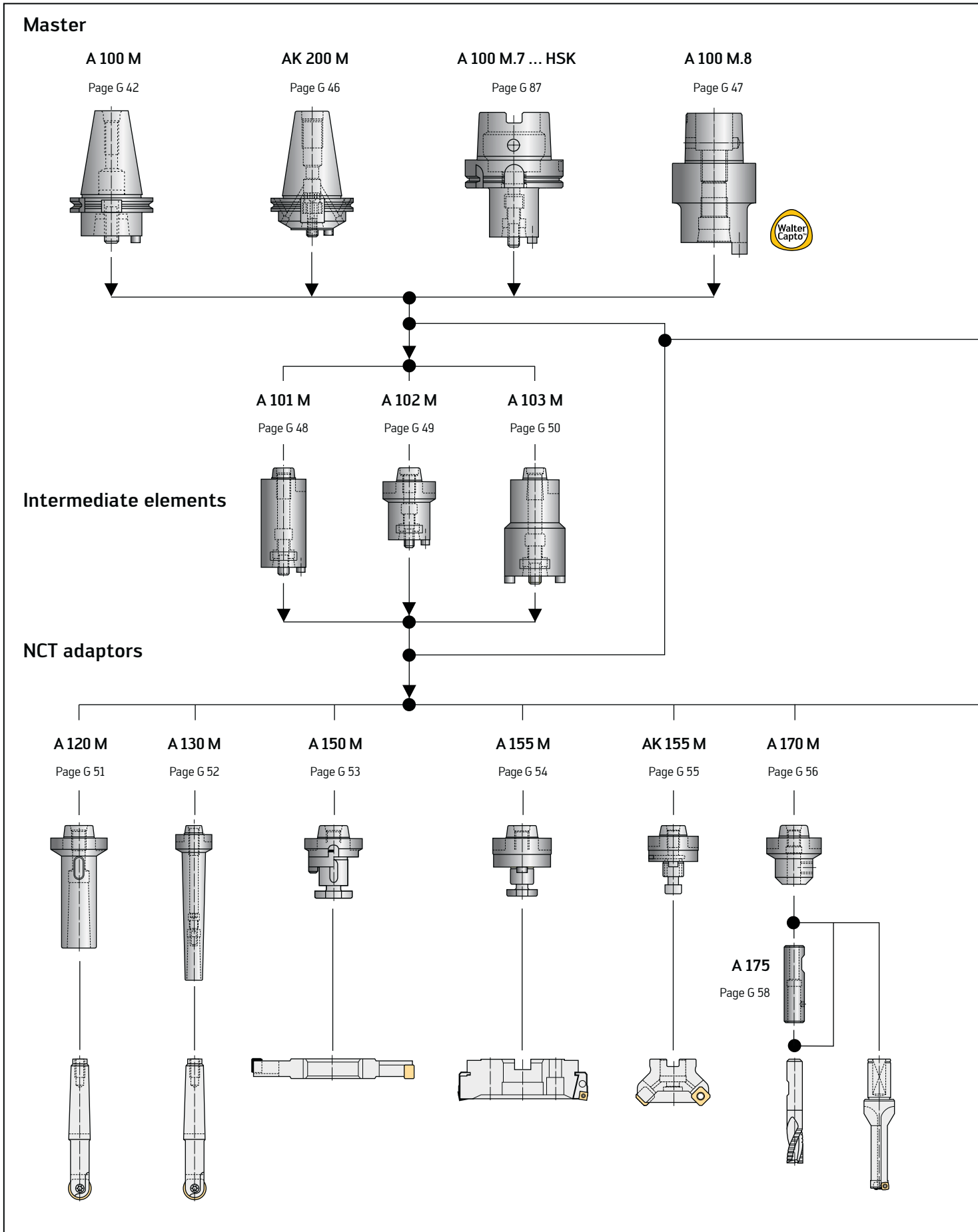

AK 520

Page G 69

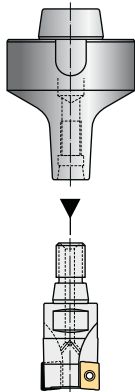

For ScrewFit system,
see page C 42 or F 52

A 201 M

Page G 59



AK 300 M

Page G 61

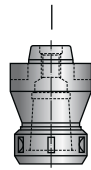

A 305
Page G 63

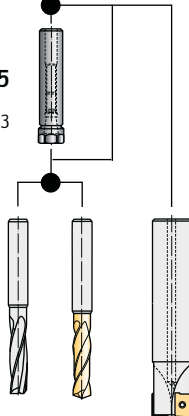

A 320 M

Page G 64



**A 330/
A 331**
Page G 98

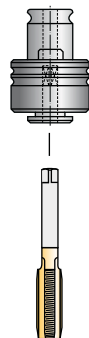

A 340 M

Page G 65

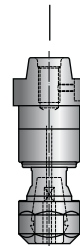

**Tools
with NCT
interface**

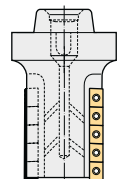

Product range overview of adaptors for ConeFit™

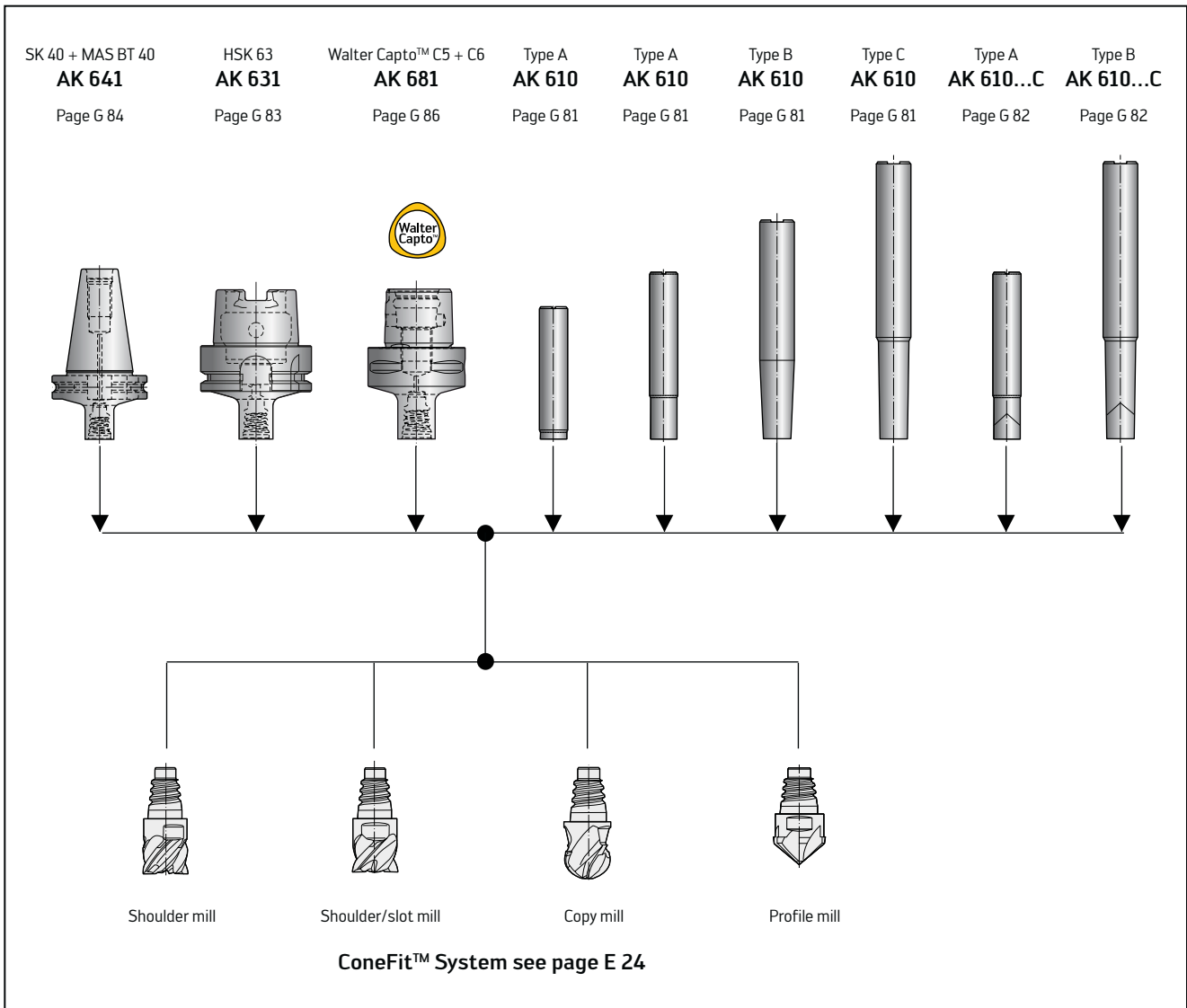

Product range overview of adaptors for ScrewFit

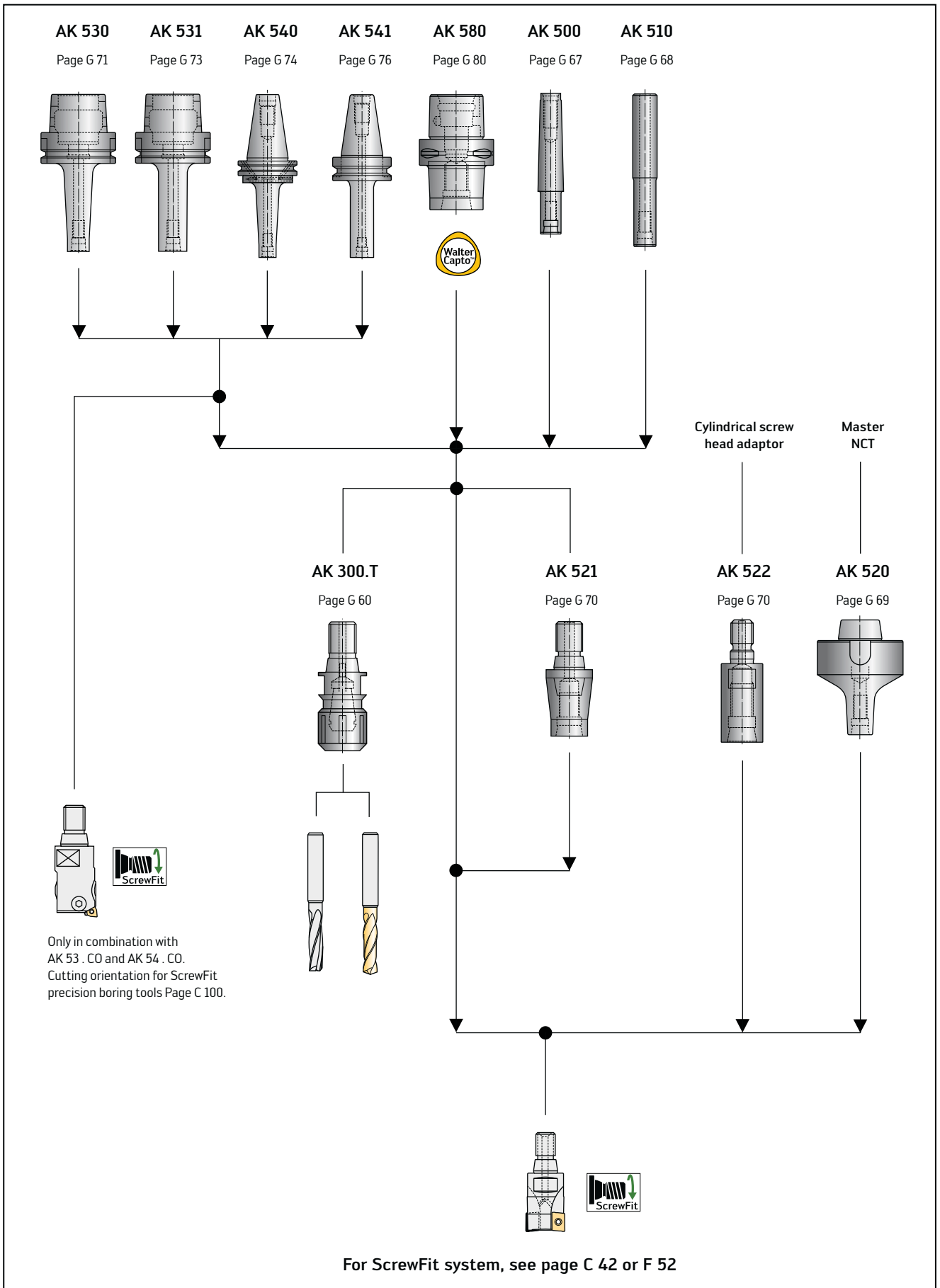

Product range overview of HSK adaptors

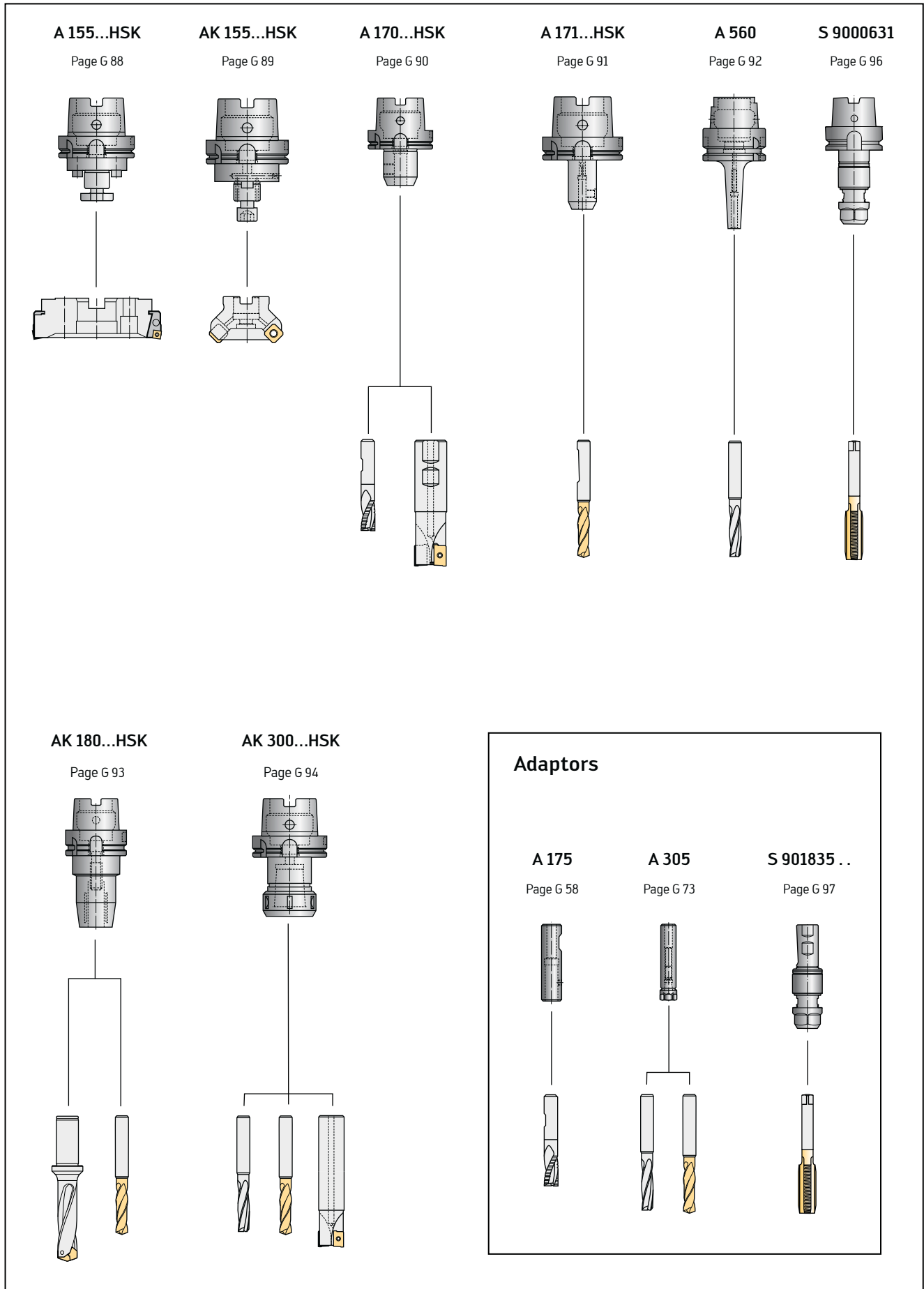

Designation key for modular systems and HSK adaptors

A	K	200	M	.	2	.	50	.	030	.	63
1	2	3	4		5		6		7		8

1	2	3	4
Tool range	Coolant supply	Family	Modular system
A Adaptors	K With internal coolant supply		

5	6	7	8
Interface type shank end	Interface size shank end	Projection length	Interface size tool end
0 NCT 1 Steep taper DIN 2080 2 Steep taper DIN 69871/1 AD 3 Steep taper ANSI/ASME B 5.50 – 1985 4 Steep taper MAS BT 5 Steep taper DIN 69871/1 AD + B 7 HSK-A DIN 69893/1 8 Capto			

Designation key for ScrewFit adaptors and collet chucks

A	K	540	.	S	50	.	T	22	.	050	.	CO
1	2	3		4	5		6	7		8		9

1	2	3	4
Tool range	Coolant supply	Family	Interface spindle end
A Adaptors	K With internal coolant supply		H HSK T ScrewFit M Morse taper BT Steep taper MAS BT N NCT C Capto S Steep taper Z Cylindrical shank

5	6	7	8	9
Interface size shank end	Interface cutter end	Interface size tool end	Projection length	Cutting edge orientation (optional)
	T ScrewFit TC Cylindrical screw head			

VDI clamping units

Type 2030/2040/2050/2060

VDI 30 - VDI 60

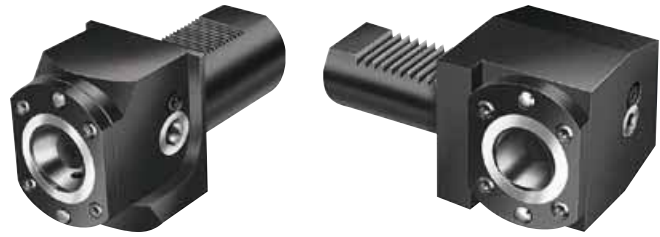

- Manually actuated
- Walter Capto™ in acc. with ISO 26623

Tool	Designation	Size	d ₁ mm	l ₄ mm	l ₂ mm	l ₃ mm	l ₅ mm	b ₁ mm	b ₂ mm	h mm	h ₂ mm	h ₃ mm
VDI DIN 69880 Bushing clamp angled 	C3-R/LC2030-41020M	C3	30	60	20	41		74		57	38	30
	C3-R/LC2030-41030M	C3	30	60	30	41		73		57	41	30
	C4-R/LC2040-51030M	C4	40	75	30	51		86		75	54	38
	C4-R/LC2040-51040M	C4	40	75	40	51		86		75	60	38
	C4-R/LC2050-41030M	C4	50	65	30	41		86		86	66	41
	C5-R/LC2040-53030M	C5	40	85	30	53		99		82	47	41
	C5-R/LC2040-53040M	C5	40	85	40	53		99		82	53	41
	C5-R/LC2050-53030M	C5	50	85	30	53		99		86	53	43
	C5-R/LC2050-53040M	C5	50	85	40	53		99		86	65	43
	C5-R/LC2060-43040M	C5	60	75	40	43		99		94	76	53
	C6-R/LC2060-53040	C6	60	95	40	53		122		105	70	53
VDI DIN 69880 Bushing clamp straight 	C3-R/LC2030-00060M	C3	30	60			44	50	38	61		34
	C4-R/LC2040-00075M	C4	40	75			53	75	48	75		38
	C4-R/LC2050-00065M	C4	50	65			39	70	48	83		42
	C5-R/LC2040-00085M	C5	40	85			72	75	64	82		41
	C5-R/LC2050-00085M	C5	50	85			61	83	64	90		45
	C5-R/LC2060-00075M	C5	60	75			16	80	64	82		58
	C6-R/LC2060-00095	C6	60	95			50	84	84	105		58

Drawing shows clockwise version.

For a selection of clamping units, see page G 111.

Note: To protect the polygon adapter, the clamping units should be fitted with a protective cover, provided that no tool is clamped and the clamping units are stored in the tool room (see page G 29).

Bodies and assembly parts are included in the scope of delivery.

N.B.: Maximum cooling lubricant pressure is 80 bar.

For Walter Capto™ tightening torques, see page G 28.

Clamping units Type 2080/2085



- With square shank for external machining
- Manually actuated
- Walter Capto™ in acc. with ISO 26623

Tool	Designation	Size	l ₁ ^{***} mm	l ₂ mm	l ₃ mm	l ₅ mm	b ₁ [*] mm	b ₂ ^{***} mm	h mm	h ₂ mm	h ₃ mm	h ₄ mm	T _h mm
Bushing clamp 	C3-R/LC2080-48090M	C3	90	45,5	48		21,5	38	20	20	54	73	
	C4-R/LC2080-59110A	C4	110	57	59		26	48	25	25	77	86	
	C5-R/LC2080-77110A	C5	110	75,5	77		33,5	64	32	32	92	100	
	C6-R/LC2080-93140**	C6	140	95	93		40	-	40	40	105	122	
Bushing clamp 	C3-R/LC2085-4038M	C3	95	78,5	25	19	38	20	40	20	62		G1/8
	C4-R/LC2085-5048	C4	125	101	30,5	24	48	25	50	25	54		G1/8
	C5-R/LC2085-6464	C5	145	118	36	32	64	32	64	32	68		G1/8

Drawing shows clockwise version.

For selection of clamping unit, see page G 112.

Bodies and assembly parts are included in the scope of delivery.

* Groove depth in the turret with type 2080.

** One-piece version.

***Length and depth of the groove in the turret with type 2085.

N.B.: Maximum cooling lubricant pressure is 80 bar.

For Walter Capto™ tightening torques, see page G 28.



Clamping units

Type 3000/2000/20.5



- With round shank for internal machining
- Manually actuated
- Walter Capto™ in acc. with ISO 26623

Tool	Designation	Size	d ₁ mm	d ₁₄ mm	l ₄ mm	l ₃ * mm	l ₅ mm	b ₂ mm	h mm	h ₄ mm	T _h mm
Type 3000 Clamping via centre screw 	C3-NC3000-08018-32	C3	32	45,5	18		18		30	26	G 1/8
	C3-NC3000-10018-40	C3	40	45,5	18	20	18		37	26	G 1/8
	C4-NC3000-10020-40	C4	40	51,5	20	10	20		37	28	G 1/8
	C5-NC3000-12024-50	C5	50	61,5	24		24		47	33	G 1/8
Type 2000 Bushing clamp 	C3-NC2000-08018-32	C3	32	45,5	18		18		30	26	G 1/8
	C4-NC2000-10020-40	C4	40	51,5	20	8	20		37	28	G 1/8
	C4-NC2000-12020-50	C4	40	51,5	20	28	20		47	28	G 1/8
	C5-NC2000-12024-50	C5	50	61,5	24		24		47	33	G 1/8
	C5-NC2000-14024-60	C5	50	61,5	25	20	24		57	33	G 1/8
Type 20.5 Bushing clamp 	C3-R/LC2035-00060M	C3	32	54	60		80	38	29		
	C4-R/LC2045-00075M	C4	40	67	75		81	48	37		
	C5-R/LC2055-00085M	C5	50	82	85		100	64	47		
	C6-R/LC2065-00095	C6	60	105	95		120	84	57		

Drawing shows clockwise version.

* Max. reduction of the clamping unit length.

For selection of clamping unit, see page G 112.

Bodies and assembly parts are included in the scope of delivery.

N.B.: Maximum cooling lubricant pressure is 80 bar.

For Walter Capto™ tightening torques, see page G 28.

Clamping units Type 2090



- For special applications
- Manually actuated
- Walter Capto™ in acc. with ISO 26623

Tool	Designation	Size	l ₁ mm	l ₂ mm	l ₃ mm	b ₁ mm	h mm	h ₂ mm	
	Bushing clamp	C3-R/LC2090-19039M	C3	38	19	39	73	54	30
		C4-R/LC2090-24043A	C4	48	24	43	86	77	38
		C5-R/LC2090-32048A	C5	64	32	48	100	92	44
		C6-R/LC2090-42060	C6	84	42	60	122	105	37
		C8-LC2090-50088	C8	100	50	88	146	133	133
		C8-RC2090-50088	C8	100	50	88	146	133	133

Drawing shows clockwise version.

For application example, see page G 113.

Note: To protect the polygon adapter, the clamping units should be fitted with a protective cover, provided that no tool is clamped and the clamping units are stored in the tool room (see page G 29).

Bodies and assembly parts are included in the scope of delivery.

N.B.: Maximum cooling lubricant pressure is 80 bar.

For Walter Capto™ tightening torques, see page G 28.



Extension

C ... – 391.01

Walter Capto™ C3 - C8

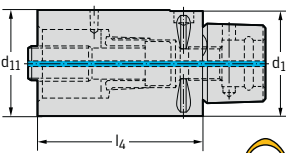
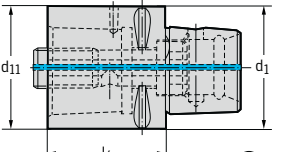

Tool	Designation	d ₁ mm	d ₁₁ mm	l ₄ mm	kg
Walter Capto™ in acc. with ISO 26623 long version 	C3-391.01-32 060A	C3	C3	60	0,4
	C3-391.01-32 080A	C3	C3	80	0,5
	C4-391.01-40 060A	C4	C4	60	0,6
	C4-391.01-40 080A	C4	C4	80	0,7
	C5-391.01-50 080A	C5	C5	80	1,2
	C5-391.01-50 100A	C5	C5	100	1,4
	C6-391.01-63 100A	C6	C6	100	2,3
	C6-391.01-63 140A	C6	C6	140	3,2
	C8-391.01-80 100A	C8	C8	100	3,7
	C8-391.01-80 125A	C8	C8	125	4,6
Walter Capto™ in acc. with ISO 26623 short version 	C3-391.01-32 035*	C3	C3	35	0,2
	C4-391.01-40 040*	C4	C4	40	0,4
	C5-391.01-50 050*	C5	C5	50	0,8
	C6-391.01-63 060*	C6	C6	60	1,4
	C8-391.01-80 065	C8	C8	65	2,4

Bodies and assembly parts are included in the scope of delivery.

* Short version only for bushing clamp.

For Walter Capto™ tightening torques, see page G 28.

Reduction C ... – 391.02

Walter Capto™ C4 - C8



Tool	Designation	d ₁ mm	d ₁₁ mm	l ₄ mm	l ₁₆ mm	kg
Walter Capto™ in acc. with ISO 26623 	C4-391.02-32 055A	C4	C3	55	31	0,5
	C5-391.02-32 060A	C5	C3	60	35	0,7
	C5-391.02-40 065A	C5	C4	65	40	0,8
	C6-391.02-32 070A	C6	C4	70	39	1,1
	C6-391.02-40 080A	C6	C4	80	51,3	1,3
	C6-391.02-50 080A	C6	C5	80	51,5	1,5
	C8-391.02-50 080A	C8	C5	80	49,3	2,3
	C8-391.02-63 080A	C8	C6	80	53,1	2,5
	Walter Capto™ in acc. with ISO 26623 	C4-391.02-32 070A	C4	C3	70	12
C5-391.02-40 085A		C5	C4	85	12	1,1
C6-391.02-50 110A		C6	C5	110	12	2,2
C8-391.02-63 120A		C8	C6	120	12	2,1
Walter Capto™ in acc. with ISO 26623 short version 	C5-391.02-32 033*	C5	C3	33	10	0,5
	C5-391.02-40 040*	C5	C4	40	18	0,6
	C6-391.02-32 032*	C6	C3	32	6	0,9
	C6-391.02-40 040*	C6	C4	40	11,3	1,0
	C6-391.02-50 050*	C6	C5	50	24,5	1,1
	C8-391.02-50 045*	C8	C5	45	10	1,9
	C8-391.02-63 055*	C8	C6	55	20	2,1

Bodies and assembly parts are included in the scope of delivery.

* Short version only for bushing clamp.

For Walter Capto™ tightening torques, see page G 28.

ER collet chuck C ... – 391.14

Walter Capto™ C3 - C6



- For ER collets in acc. with DIN 6499

Tool	Designation	d ₁ mm	d ₁₁ mm	d ₁₂ mm	l ₄ mm	Collets	kg
Walter Capto™ in acc. with ISO 26623 	C3-391.14-20 045	C3	1-13	35	45	ER 20	0,2
	C4-391.14-20 052	C4	1-13	35	52	ER 20	0,4
	C4-391.14-25 052	C4	1-16	42	52	ER 25	0,7
	C4-391.14-32 054	C4	1-20	50	54	ER 32	0,5
	C5-391.14-20 055	C5	1-13	35	55	ER 20	0,8
	C5-391.14-25 055	C5	1-16	42	55	ER 25	0,6
	C5-391.14-32 057	C5	1-20	50	57	ER 32	0,7
	C6-391.14-20 060	C6	1-13	35	60	ER 20	0,9
	C6-391.14-25 060	C6	1-16	42	60	ER 25	1,0
	C6-391.14-25 100	C6	1-16	42	100	ER 25	1,4
	C6-391.14-32 060	C6	2-20	50	60	ER 32	1,1
	C6-391.14-32 100	C6	2-20	50	100	ER 32	1,6
	C6-391.14-40 065	C6	3-26	63	65	ER 40	1,2

For collets, see page G 99.

Bodies and assembly parts are included in the scope of delivery.

Assembly parts	Collets	ER 20	ER 25	ER 32	ER 40
	Clamping nut	FS1451	FS1540	FS1541	FS1542

Accessories	Collets	ER 20	ER 25	ER 32	ER 40
	Tensioning key	FS1452	FS1544	FS1545	FS1546

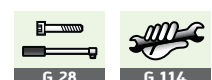

ER collet chuck with internal coolant C ... – 391.14

Walter Capto™ C3 - C6



- For use with sealing disc
- For ER collets in acc. with DIN 6499

Tool	Designation	d ₁ mm	d ₁₁ mm	d ₁₂ mm	l ₄ mm	Collets	kg
	Walter Capto™ in acc. with ISO 26623						
	C3-391.14-20 050	C3	1-13	35	50	ER 20	0,3
	C4-391.14-20 057	C4	1-13	35	57	ER 20	0,5
	C4-391.14-25 057	C4	1-16	42	57	ER 25	0,8
	C4-391.14-32 059	C4	1-20	50	59	ER 32	0,6
	C5-391.14-20 060	C5	1-13	35	60	ER 20	0,9
	C5-391.14-25 060	C5	1-16	42	60	ER 25	0,8
	C5-391.14-32 062	C5	1-20	50	62	ER 32	0,9
	C6-391.14-20 065	C6	1-13	35	65	ER 20	1,1
	C6-391.14-25 065	C6	1-16	42	65	ER 25	1,2
	C6-391.14-25 105	C6	1-16	42	105	ER 25	1,5
	C6-391.14-32 065	C6	2-20	50	65	ER 32	1,2
	C6-391.14-32 105	C6	2-20	50	105	ER 32	1,8
	C6-391.14-40 070	C6	3-26	63	70	ER 40	1,5

If the collet chuck is used with internal coolant supply, the sealing discs on page G 102 must be used.

N.B.: The clamping nut can be damaged if the chuck is used without a sealing disc.

For collets, see page G 99.

Bodies and assembly parts are included in the scope of delivery.

Assembly parts	Collets	ER 20	ER 25	ER 32	ER 40
	Clamping nut for internal coolant supply	FS1359	FS1449	FS1360	FS1450

Accessories	Collets	ER 20	ER 25	ER 32	ER 40
	Tensioning key	FS1452	FS1544	FS1545	FS1546

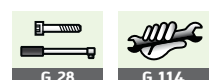

Weldon shank adaptor C ... – 391.20

Walter Capto™ C3 - C5



- For shanks in acc. with DIN 6535 HB

Tool	Designation	d ₁ mm	d ₁₁ mm	d ₁₂ mm	l ₄ mm	l ₁₆ mm	kg	
Walter Capto™ in acc. with ISO 26623 d ₁₁ ≤ 20 mm	C3-391.20-06 045A	C3	6	25	45	26,5	0,3	
	C3-391.20-08 045A	C3	8	28	45	28	0,3	
	C3-391.20-10 050	C3	10	35	50	35	0,4	
	C3-391.20-12 055	C3	12	42	55	40	0,5	
	C4-391.20-06 050	C4	6	25	50	26,5	0,4	
	C4-391.20-08 050	C4	8	28	50	26,5	0,4	
	C4-391.20-10 050A	C4	10	35	51	29,6	0,5	
	C4-391.20-12 055A	C4	12	42	56	36	0,5	
	C4-391.20-14 055	C4	14	44	55	35	0,6	
	C4-391.20-16 055	C4	16	48	55	35	0,7	
	Walter Capto™ in acc. with ISO 26623 d ₁₁ > 20 mm	C5-391.20-06 050	C5	6	25	50	25,5	0,6
		C5-391.20-08 050	C5	8	28	50	26	0,6
C5-391.20-10 055		C5	10	35	55	27,5	0,7	
C5-391.20-12 060		C5	12	42	60	36	0,8	
C5-391.20-14 060		C5	14	44	60	37	0,9	
C5-391.20-16 060		C5	16	48	60	39	0,9	
C5-391.20-18 060		C5	18	50	60	–	1,0	
C5-391.20-20 060		C5	20	52	60	40	1,0	
C5-391.20-25 080		C5	25	65	80	60	1,7	

Bodies and assembly parts are included in the scope of delivery.

Assembly parts	d ₁₁ mm	6	8	10	12-14	16-18	20	25	32	40
Screw		3214 050-357	3214 050-407	3214 050-458	3214 050-509	3214 050-539	3214 050-559	3214 050-590	3214 050-610	3214 050-611

Accessories	d ₁₁ mm	6	8	10	12-18	20	25-40
Key ISO 2936		ISO2936-3 (SW 3)	ISO2936-4 (SW 4)	ISO2936-5 (SW 5)	ISO2936-6 (SW 6)	ISO2936-8 (SW 8)	ISO2936-10 (SW 10)



Weldon shank adaptor C ... – 391.20

Walter Capto™ C6 - C8



- For shanks in acc. with DIN 6535 HB

Tool	Designation	d ₁ mm	d ₁₁ mm	d ₁₂ mm	l ₄ mm	l ₁₆ mm	kg	
Walter Capto™ in acc. with ISO 26623 d ₁₁ ≤ 20 mm	C6-391.20-06 055	C6	6	25	55	25	1,0	
	C6-391.20-08 055	C6	8	28	55	26	1,0	
	C6-391.20-10 060	C6	10	35	60	30	1,1	
	C6-391.20-12 060	C6	12	42	60	33	1,2	
	C6-391.20-14 060	C6	14	44	60	33,5	1,2	
	C6-391.20-16 065	C6	16	48	65	35,5	1,4	
	C6-391.20-18 065	C6	18	50	65	39	1,4	
	C6-A391.20-19 065A	C6	19	45	66	38,7	1,4	
	C6-391.20-20 065	C6	20	52	65	37,5	1,4	
	Walter Capto™ in acc. with ISO 26623 d ₁₁ > 20 mm	C6-391.20-25 080	C6	25	65	80	58	2,0
C6-391.20-32 090		C6	32	72	90	68	2,5	
C6-391.20-40 100		C6	40	90	100	77	3,7	
C8-391.20-16 070		C8	16	48	70	32,5	2,4	
C8-391.20-20 070		C8	20	52	70	35	2,4	
C8-391.20-25 080		C8	25	65	80	53,7	2,7	
C8-391.20-32 080		C8	32	72	80	53,7	2,9	
C8-391.20-40 110		C8	40	90	110	79	5,1	

Bodies and assembly parts are included in the scope of delivery.

Assembly parts	d ₁₁ mm	6	8	10	12-14	16-18	20	25	32	40
Screw		3214 050-357	3214 050-407	3214 050-458	3214 050-509	3214 050-539	3214 050-559	3214 050-590	3214 050-610	3214 050-611

Accessories	d ₁₁ mm	6	8	10	12-18	20	25-40
Key ISO 2936		ISO2936-3 (SW 3)	ISO2936-4 (SW 4)	ISO2936-5 (SW 5)	ISO2936-6 (SW 6)	ISO2936-8 (SW 8)	ISO2936-10 (SW 10)



Toolholder for ISO boring bars C ... – 131

Walter Capto™ C3 - C5



- For boring bars with clamping surface

Tool	Designation	d ₁ mm	d ₁₁ mm	d ₁₂ mm	l ₄ mm	l ₁₆ mm	l ₁₇ mm	kg
	Walter Capto™ in acc. with ISO 26623	C3	10	36	35	20	20	0,3
	C3-131-00035-10	C3	12	36	40	24	24	0,3
	C3-131-00040-12	C4	10	36	40	19	20	0,4
	C4-131-00040-10	C4	12	36	45	24	24	0,5
	C4-131-00045-12	C4	16	36	50	29	32	0,5
	C4-131-00050-16	C5	10	36	45	21	20	0,6
	C5-131-00045-10	C5	12	36	45	22,5	24	0,6
	C5-131-00045-12	C5	16	36	55	31	32	0,7
	C5-131-00055-16							

Bodies and assembly parts are included in the scope of delivery.

Assembly parts	d ₁₁ mm	10-12	16
	Screw	5514 020-04	5514 020-02

Accessories	d ₁₁ mm	10-12	16
	Key ISO 2936	ISO 2936-3 (SW 3)	ISO 2936-4 (SW 4)

Adaptor for drilling and boring tools C ... – 391.27

Walter Capto™ C3 - C6



- For drilling and boring tools with shank design

Tool	Designation	d ₁ mm	d ₁₁ mm	d ₁₂ mm	l ₄ mm	l ₁₆ mm	l ₁₇ mm	kg
Walter Capto™ in acc. with ISO 26623 	C3-391.27-16 056	C3	16	36	56	41	49,5	0,4
	C3-391.27-20 060	C3	20	40	60	45	51,5	0,5
	C4-391.27-16 056	C4	16	36	56	32,5	49,5	0,5
	C4-391.27-20 060	C4	20	40	60	60	51,5	0,6
	C4-391.27-25 077	C4	25	45	77	57	57,5	0,8
	C5-391.27-16 065	C5	16	36	65	41,7	49,5	0,8
	C5-391.27-20 060	C5	20	40	60	37,7	51,5	0,7
	C5-391.27-25 071	C5	25	45	71	46,7	57,5	0,9
	C5-391.27-32 075	C5	32	52	75	55	61,5	1,0
	C6-391.27-16 070	C6	16	36	70	43	49,5	1,1
	C6-391.27-20 070	C6	20	40	70	43,8	51,5	1,2
	C6-391.27-25 070A	C6	25	45	70	43,8	57,5	1,2
	C6-391.27-32 075	C6	32	52	75	49,8	61,5	1,3
	C6-391.27-40 085	C6	40	65	85	63	71,5	1,7

Bodies and assembly parts are included in the scope of delivery.

Assembly parts	d ₁₁ mm	16-20	25-32	40
	Screw	5514 042-04	416.1-838	5514 042-06

Accessories	d ₁₁ mm	16-20	25-32	40
	Key ISO 2936	ISO 2936-4 (SW 4)	ISO2936-6 (SW 6)	ISO2936-8 (SW 8)



Quick change tap chuck C ... – 391.60

Walter Capto™ C3 - C6



- With elastic length compensation for compression and extension

Tool	Designation	d ₁ mm	d ₁₁ mm	d ₁₂ mm	d ₁₃ mm	l ₄ mm	Length compensation		Collet size	For taps	kg
							C mm	T			
Walter Capto™ in acc. with ISO 26623	C3-391.60-01 080A	C3	19	36	50	80	7,5	7,5	1	M4-M12	0,6
	C4-391.60-01 080A	C4	19	36	50	80	7,5	7,5	1	M4-M12	0,7
	C4-391.60-02 110A	C4	31	53	-	110	12,5	12,5	3	M8-M20	1,4
	C5-391.60-01 080A	C5	19	36	50	80	7,5	7,5	1	M4-M12	0,9
	C5-391.60-02 115A	C5	31	53	63	115	12,5	12,5	3	M8-M20	1,7
	C6-391.60-01 090A	C6	19	36	63	90	7,5	7,5	1	M4-M12	1,4
	C6-391.60-02 120A	C6	31	53	63	120	12,5	12,5	3	M8-M20	2,2
	C6-391.60-03 170A	C6	48	78	-	170	20	20	4	M14-M33	4,2

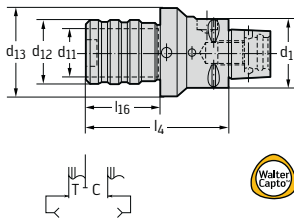

A quick change collet A 330/A 331 is required for every adaptor, see page G 98.

Axial adaptor C ... – ASH

Walter Capto™ C5 – C8



- For shank tools

Tool	Designation	Size	h mm	b ₁ mm	b ₂ mm	d ₁₄ mm	f mm	h ₂ mm	h ₃ mm	l ₂ mm	l ₃ mm	l ₄ mm	l ₅ mm	
	Walter Capto™ in acc. with ISO 26623	C5-ASHR/L-30098-20	C5	41	29	30	90	10	33	41	88	20	98	23
		C6-ASHR/L-30100-20	C6	41	29	30	90	10	33	41	90	22	100	25
		C6-ASHR/L-38130-25	C6	50	32	38	110	13	33	50	112	22	130	28
		C8-ASHR/L-40140-32	C8	55	40	40	110	8	30	55	130	30	140	35
	Walter Capto™ in acc. with ISO 26623	C6-ASHS-58115-32	C6	32	58	58	140	33					115	
	Walter Capto™ in acc. with ISO 26623	C5-ASHR/L3-36123-20	C5	20			90	16				20	123	26
		C6-ASHR/L3-36125-20	C6	20			90	16				22	125	28
		C8-ASHR/L3-45150-32	C8	32			120	20				30	150	36

Bodies and assembly parts are included in the scope of delivery.
 N.B.: Adaptors are provided for machines with automatic tool replacement.
 Please ensure that no malfunctions develop between the magazine and tool replacement cycle.

Assembly parts		for C5- ASHR/L-30...	for C6- ASHR/L-30...	for C6- ASHR/L-38...	for C6- ASHS-...	for C5-/C8- ASHR/L-3...
	Screw	3214 020-461	3214 020-411	3214 020-512	3214 040-462	3214 020-512
	Coolant nozzle	FS1479	FS1479	FS1480	FS1478	FS1479

Radial adaptor C ... – ASHA

Walter Capto™ C5 - C8



- For shank tools

Tool		Designation	Size	h mm	b ₁ mm	b ₂ mm	d ₁₄ mm	f mm	h ₁ mm	h ₂ mm	l ₄ mm	l ₅ mm
	Walter Capto™ in acc. with ISO 26623	C5-ASHA-38058-20M	C5	20		23	90			38	58	38
		C6-ASHA-38060-20M	C6	20		23	90			38	60	40
		C6-ASHA-45071-25M	C6	25		30	110			45	71	45
		C6-ASHA-50071-32M	C6	32		–	130			50	71	45
		C8-ASHA-55085-32M	C8	32		40	142			55	85	53
	Walter Capto™ in acc. with ISO 26623	C8-ASH R/L 45-50135-32	C8	32	45		140	17	32	40	135	

Bodies and assembly parts are included in the scope of delivery.

N.B.: Adaptors are provided for machines with automatic tool replacement.

Please ensure that no malfunctions develop between the magazine and tool replacement cycle.

Assembly parts		l ₅ mm	40	45	53
	Screw		3214 020-411	3214 040-462	3214 020-512
	Coolant nozzle		FS1476	FS1478	FS1476

Face mill adaptor
C ... – AK 155.8.C

Walter Capto™ C4 - C6



Tool	Designation	d ₁ mm	d ₁₁ mm	d ₁₂ mm	l ₄ mm	l ₁₉ mm	kg
	Walter Capto™ in acc. with ISO 26623						
	AK155.8.C4.020.16	C4	16	38	20	17	0,3
	AK155.8.C5.025.16	C5	16	38	25	17	0,5
	AK155.8.C5.025.22	C5	22	48	25	19	0,6
	AK155.8.C5.030.27	C5	27	60	30	21	0,8
	AK155.8.C6.025.22	C6	22	48	25	19	0,9
	AK155.8.C6.025.27	C6	27	60	25	21	1,0
	AK155.8.C6.030.16	C6	16	38	30	17	1,0
	AK155.8.C6.035.32	C6	32	78	35	24	1,5

Bodies and assembly parts are included in the scope of delivery.

Assembly parts	d ₁₁ mm	16	22	27	32
	Locking bolt ISO 4762	FS938 (SW 6)	FS939 (SW 8)	FS940 (SW 10)	FS941 (SW 14)

Accessories	d ₁₁ mm	16	22	27	32
	Allen key ISO 2936	ISO 2936-6 (SW 6)	ISO 2936-8 (SW 8)	ISO 2936-10 (SW 10)	ISO 2936-14 (SW 14)

Adaptor HSK to Capto

C ... – 391.410

HSK63 + HSK100



Tool	Designation	d ₁₁ mm	d ₁	l ₄ mm	l ₁₆ mm	kg
Walter Capto™ in acc. with ISO 26623 HSK DIN 69893/1 A 	C3-390.410-63 075C	C3	HSK-A63	75	49	0,9
	C4-390.410-100 090A	C4	HSK-A100	90	61	2,7
	C4-390.410-63 080C	C4	HSK-A63	80	54	1,1
	C5-390.410-100 100A	C5	HSK-A100	100	71	3,0
	C5-390.410-63 090C	C5	HSK-A63	90	64	1,5
	C6-390.410-100 110A	C6	HSK-A100	110	81	3,7
	C8-390.410-100 120A	C8	HSK-A100	120	91	4,9

Bodies and assembly parts are included in the scope of delivery.
 For Walter Capto™ tightening torques, see page G 28.

Boring bar holder AK 600

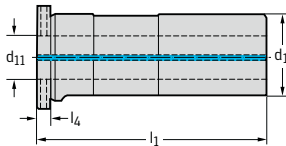

- With Weldon shank in acc. with DIN 9766
- Self centring for cylindrical round shank

Tool	Designation	d ₁ mm	d ₁₁ mm	l ₁ mm	l ₄ mm	
	AK600.25.061.06	25	6	61	5	0,2
	AK600.25.061.08	25	8	61	5	0,2
	AK600.25.061.10	25	10	61	5	0,2
	AK600.25.061.12	25	12	61	5	0,1
	AK600.25.061.16	25	16	61	5	0,2
	AK600.32.085.06	32	6	85	5	0,6
	AK600.32.085.08	32	8	85	5	0,5
	AK600.32.085.10	32	10	85	5	0,5
	AK600.32.085.12	32	12	85	5	0,5
	AK600.32.085.16	32	16	85	5	0,4
	AK600.32.085.20	32	20	81	5	0,3
	AK600.40.105.06	40	6	105	5	0,8
	AK600.40.105.08	40	8	105	5	1,0
	AK600.40.105.10	40	10	105	5	0,9
	AK600.40.105.12	40	12	105	5	0,9
	AK600.40.105.16	40	16	105	5	0,9
	AK600.40.105.20	40	20	105	5	0,8

Comment:

The groove for the self centring of the boring bar is present on all Walter Turn boring bars with cylindrical shank Ø 6–25 mm.
For product range overview, see page A 161.

Accessories for Walter Capto™

Assembly device

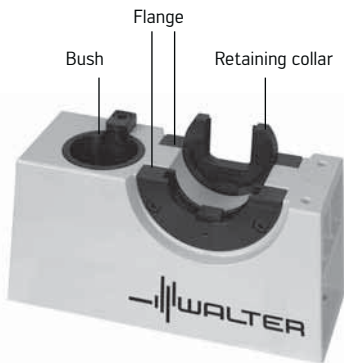

Size	Basic body with integrated bush Ordering code	Flange Ordering code	Retaining collar Ordering code	Bush Ordering code
C3	V 500.00.C3	V 510.23.050	V 530.C3	V 540.C3
C4	V 500.00.C4	V 510.23.050	V 530.C4	V 540.C4
C5	V 500.00.C5	V 510.23.050	V 530.C5	V 540.C5
C6	V 500.00.C6	V 510.23.050	V 530.C6	V 540.C6
C8	V 500.00.C8	V 510.23.050	V 530.C8	V 540.C8

The assembly device is already equipped with the suitable bush.
The flange and retaining collar must be ordered separately. The assembly device enables two flanges (e.g. for equipping two different CAPTO sizes) to be mounted opposite each other on the basic body.

Torque wrench for bushing/cam clamping

Torque wrench Ordering code	Size	Tightening torque Nm	Spare parts	
			Wrench adaptor	SW mm
BT-TK-02	C3	35	5680 035-05	8
C-TK-01	C4	50	5680 035-06	10
C-TK-01	C5	70	5680 035-07	12
C-TK-01	C6	90	5680 035-07	12
C-TK-02	C8	130	5680 035-07	12

Torque wrench for central screw clamping

Torque wrench Ordering code	Size	Tightening torque Nm	Spare parts	
			Wrench adaptor	SW mm
C-TK-01	C3	45	5680 015-05	8
C-TK-01	C4	55	5680 015-05	8
C-TK-01	C5	95	5680 015-01	14
C-TK-02	C6	170	5680 015-02	14
C-TK-02	C8	170	5680 015-02	14

Accessories for Walter Capto™

Lubrication

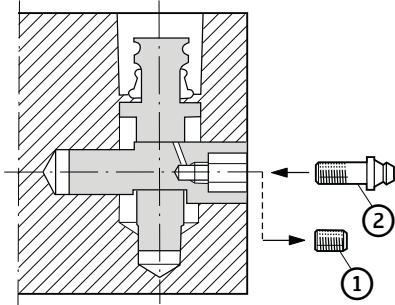

All manually actuated clamping units are lubricated prior to delivery with BP Energ grease ACS-2¹. The lubrication should be checked and replaced after around six months. New grease can be fed through the eccentric bolt.

1. Unscrew screw ①.
2. Insert lubricating nipple ② 5692 012-01 (for ordering information see below).
3. Please ensure that the clamping mechanism is in the clamped setting.
4. Using a grease gun, dispense grease until it begins to emerge on the outside.
5. Remove lubricating nipple.
6. Screw the screw ① back into the eccentric bolt.

NOTE:

The clamping unit must be tensioned during the lubrication process.

¹ Alternatives:

STATOIL Beacon 325, MOBIL Temp SHC 32, MOBIL Grease, MOBIL Special Grease or any equivalent commercially available grease.

Lubricating nipple for Walter Capto™ clamping units

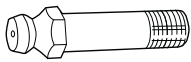

Ordering code	Size
5692 012-01	C3—C8

Cover plug for the CAPTO taper in clamping units

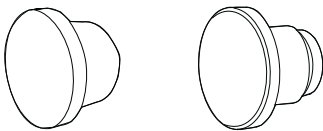

Ordering code	Size
C3-CP-01	C3
C4-CP-01	C4
C5-CP-01	C5
C6-CP-01	C6
C8-CP-01	C8

Operating instructions – Rotating cutting head orientation by 180°

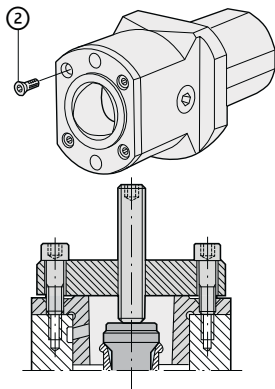

In the case of an overhead machining operation, proceed as described in the following steps:

Turn the polygon socket by 180°.

1. Undo four screws ②.
Recommended keys by separate ordering:
C3: (T15) FS 1047
C4: (T20) FS 1048
C5: (T25) FS 1049
C6: Hexagon (5 mm) ISO 2936-5
C8: Hexagon (6 mm) ISO 2936-6
2. Remove the polygon socket. Please use removal fixture (for ordering information see below).
– Using the 4 screws secure the removal device to the polygon socket.
– Tighten the central screw of the device until the polygon socket is released.
3. Rotate the polygon socket by 180° and reinstall, with the aid of a plastic or copper hammer if necessary.

Removal fixture for removing the polygon socket from manual clamping units

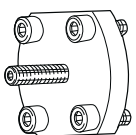

Ordering code	Size
C3-WDT-01M	C3
C4-WDT-01M	C4
C5-WDT-01M	C5
C6-WDT-01M	C6
C8-WDT-01M	C8

Walter Capto™ fixture

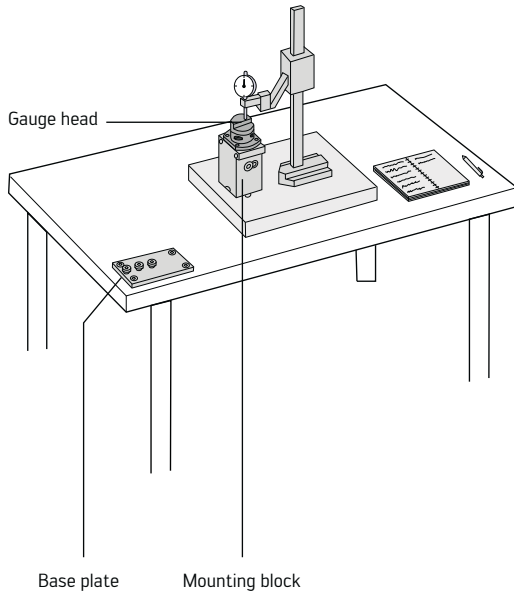

The accuracy of the Walter Capto™ coupling system provides outstanding repeat accuracy during cutting head replacements. This degree of precision has consistently proven to be highly beneficial, for example during manual changeover operations where inserts are changed outside the machine. With the aid of the new, easy-to-operate Walter Capto™ fixture, the position of the cutting edge can be measured in two co-ordinates.

Once the measured cutting head has been mounted in the toolholder, any cutting edge deviation can be compensated for by the machine's control system.

The fixture can be used in combination with any normal gauge and test plate, Walter recommends, however, using an indicator with zero setting and a flat tracing probe.

Basic equipment

If you already have a measuring plate with measuring device, all you require is the following additional equipment:

- Fixture for tool gauging
- Base plate
- Gauge head (see MAS gauges, page G 31)

Mounting block for tool gauging

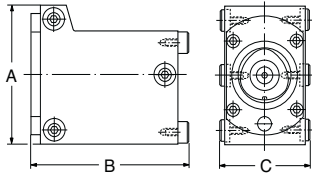

Ordering code	Size	Dimensions [mm]		
		A	B	C
C3-PMU-01M	C3	65	85	44
C4-PMU-01M	C4	77	94	54
C5-PMU-01M	C5	94	130	70
C6-PMU-01	C6	114	135	90
C8-PMU-01	C8	133	150	106

Base plate

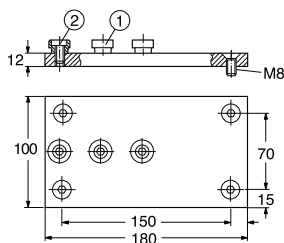

Ordering code	Size	Spare parts	
		① Pin	② Screw
C-HP-01	C3-C8	5638 060-01	3212 020-409

Measuring fixtures and gauges for Walter Capto™

The Walter Capto™ modular system provides outstanding repeat accuracy. However, this is only helpful if the many other components, that are important during the entire machining process, are also accurate and correctly adjusted. Walter therefore offers a wide range of measurement aids for axial and centre measurement for all coupling sizes, the use of which is also highly recommended for setting the most important parameters such as

- Centre line
- Spindle alignment
- Tool position for the gripper
- Centre height of the tool and the cutting edge position (f_1 and l_1)

The gauges can be used for premeasuring

- Indexing device

Axial gauge/master setting gauges MAS-11

Ordering code	Size	Dimensions [mm]		
		D_g	l_g	
C3-MAS-11	C3	25	160	
C4-MAS-11	C4	25	160	
C5-MAS-11	C5	32	215	
C6-MAS-11	C6	40	320	
C8-MAS-11	C8	40	320	

Centre height gauge/master setting gauges MAS-01

Ordering code	Size	Dimensions [mm]		
		f_g	D_g	l_g
C3-MAS-01	C3	22	34	40
C4-MAS-01	C4	27	42	50
C5-MAS-01	C5	35	52	60
C6-MAS-01	C6	45	65	65
C8-MAS-01	C8	55	80	82

Assembly parts and accessories for clamping units VDI angled version DIN 69880 Type 2030/2040/2050/2060

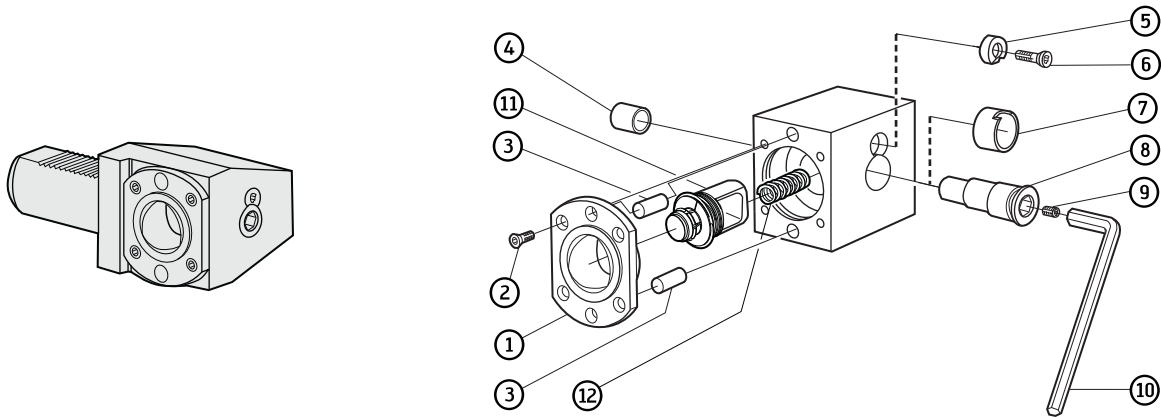

Assembly parts	Coupling size			
	C3	C4	C5	C6
① Adaptor sleeve	5252 010-01	5252 010-02	5252 010-03	5252 010-04
② Screw (4 x)	416.1-834	5513 020-26	5513 020-14	3213 010-410
③ Pin	3111 050-558	3111 050-610	3111 050-661	3111 050-715
④ Slide bearing	3823 010-101	3823 010-122	3823 010-162	3823 010-183
⑤ Washer disc	5541 030-01	5541 030-02	5541 030-03	5541 030-04
⑥ Screw	416.1-834	416.1-834	5513 020-14	5513 020-14
⑦ Slide bearing	5638 022-01	5638 022-02	5638 022-03	5638 022-04
⑧ Eccentric bolt	5333 025-01	5333 025-02	5333 025-03	5333 025-04
⑨ Screw	3214 010-355	3214 010-355	3214 010-355	3214 010-355
⑪ Drawbar (set)	5461 100-101	5461 100-111	5461 100-121	5461 100-131
⑫ Spring	5561 001-71	5561 001-41	5561 001-41	5561 001-41

Accessories	Coupling size			
	C3	C4	C5	C6
⑩ Key	SW 8 (DIN 911)	SW 10 (DIN 911)	SW 12 (DIN 911)	SW 12 (DIN 911)

Assembly parts and accessories for clamping units VDI straight version DIN 69880 Type 2030/2040/2050/2060

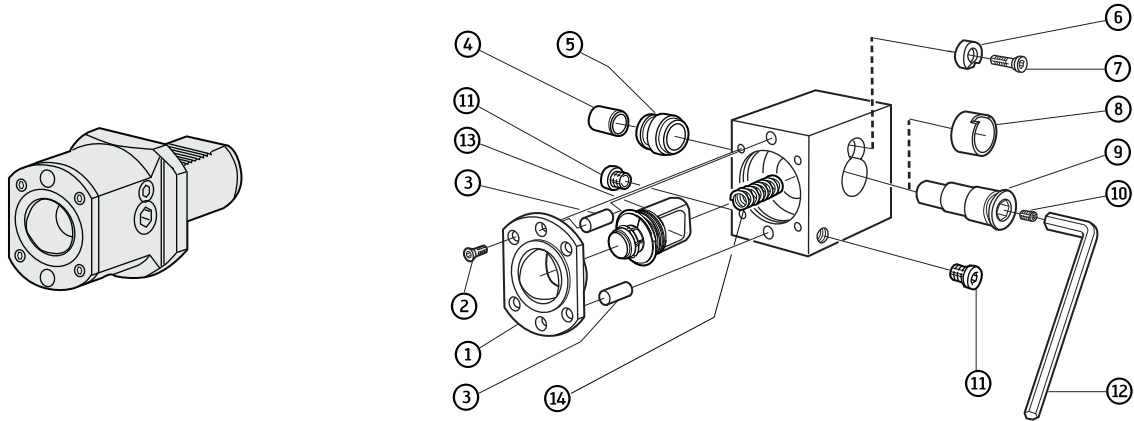

Assembly parts	Coupling size			
	C3	C4	C5	C6
① Adaptor sleeve	5252 010-01	5252 010-02	5252 010-03	5252 010-04
② Screw (4 x)	416.1-834	5513 020-26	5513 020-14	3213 010-410
③ Pin	3111 050-558	3111 050-610	3111 050-661	3111 050-715
④ Slide bearing	3823 010-101	3823 010-122	3823 010-162	3823 010-183
⑤ Bush	5638 024-01	5638 024-02	5638 024-03	5638 024-04
⑥ Retaining washer	5541 030-01	5541 030-02	5541 030-03	5541 030-04
⑦ Screw	416.1-834	416.1-834	5513 020-14	5513 020-14
⑧ Slide bearing	5638 022-01	5638 022-02	5638 022-03	5638 022-04
⑨ Eccentric bolt	5333 025-01	5333 025-02	5333 025-03	5333 025-04
⑩ Screw	3214 010-355	3214 010-355	3214 010-355	3214 010-355
⑪ Seal	3611 005-180	3611 005-180	3611 005-180	3611 005-140
⑬ Drawbar (set)	5461 100-101	5461 100-111	5461 100-121	5461 100-131
⑭ Spring	5561 001-71	5561 001-41	5561 001-41	5561 001-41

Accessories	Coupling size			
	C3	C4	C5	C6
⑫ Key	SW 8 (DIN 911)	SW 10 (DIN 911)	SW 12 (DIN 911)	SW 12 (DIN 911)

Assembly parts and accessories for clamping units Type 2080

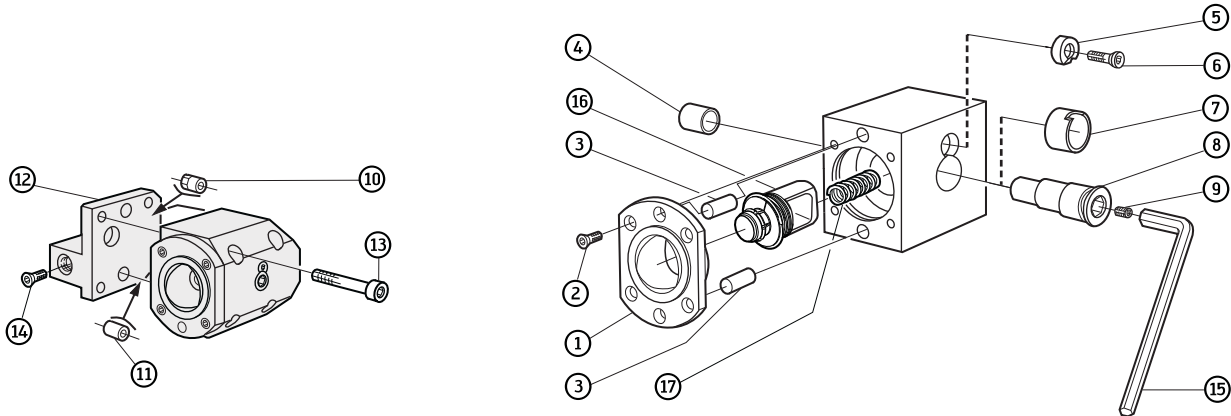

Assembly parts	Coupling size			
	C3	C4	C5	C6
① Adaptor sleeve	5252 010-01	5252 010-02	5252 010-03	5252 010-04
② Screw (4 x)	416.1-834	5513 020-26	5513 020-14	3213 010-410
③ Pin	3111 020-558	3111 020-610	3111 020-661	3111 020-715
④ Slide bearing	3823 010-101	3823 010-122	3823 010-162	3823 010-183
⑤ Retaining washer	5541 030-01	5541 030-02	5541 030-03	5541 030-04
⑥ Screw	416.1-834	416.1-834	5513 020-14	5513 020-14
⑦ Slide bearing	5638 022-01	5638 022-02	5638 022-03	5638 022-04
⑧ Eccentric bolt	5333 025-01	5333 025-02	5333 025-03	5333 025-04
⑨ Screw	3214 010-355	3214 010-355	3214 010-355	3214 010-355
⑩ Pipe pin	5552 063-05	5552 063-07	5552 063-06	—
⑪ Pin	5552 061-07	5552 061-09	5552 061-08	—
⑫ Adaptor right	5253 005-01	5253 005-15	5253 005-11	—
⑫ Adaptor left	5253 005-02	5253 005-16	5253 005-12	—
⑬ Screw	3212 010-363	3212 010-364	3212 010-416	—
⑭ Seal	3611 005-180	3611 005-140	—	—
⑯ Drawbar (set)	5461 100-101	5461 100-111	5461 100-121	5461 100-131
⑰ Spring	5561 001-71	5561 001-41	5561 001-41	5561 001-41

Accessories	Coupling size			
	C3	C4	C5	C6
⑮ Key	SW 8 (DIN 911)	SW 10 (DIN 911)	SW 12 (DIN 911)	SW 12 (DIN 911)

Assembly parts and accessories for clamping units Type 2090

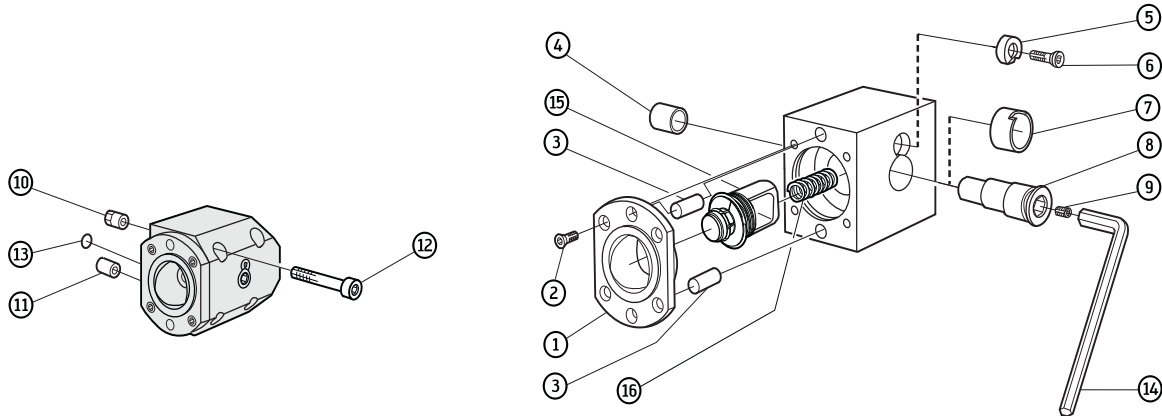

Assembly parts	Coupling size				
	C3	C4	C5	C6	C8
① Adaptor sleeve	5252 010-01	5252 010-02	5252 010-03	5252 010-04	5252 010-05
② Screw (4 x)	416.1-834	5513 020-26	5513 020-14	3213 010-410	3213 010-462
③ Pin	3111 050-558	3111 050-610	3111 050-661	3111 050-715	3111 050-769
④ Slide bearing	3823 010-101	3823 010-122	3823 010-162	3823 010-183	3823 010-225
⑤ Retaining washer	5541 030-01	5541 030-02	5541 030-03	5541 030-04	5541 030-05
⑥ Screw	416.1-834	416.1-834	5513 020-14	5513 020-14	5513 020-14
⑦ Slide bearing	5638 022-01	5638 022-02	5638 022-03	5638 022-04	5638 022-05
⑧ Eccentric bolt	5333 025-01	5333 025-02	5333 025-03	5333 025-04	5333 025-05
⑨ Screw	3214 010-355	3214 010-355	3214 010-355	3214 010-355	3214 010-355
⑩ Pipe pin	5552 063-05	5552 063-07	5552 063-06	5552 063-03	5552 063-04
⑪ Pin	5552 061-07	5552 061-09	5552 061-08	5552 061-05	5552 061-06
⑫ Screw	3212 010-363	3212 010-414	3212 010-466	3212 010-469	3212 010-521
⑬ O-ring	5641 001-22	3671 010-114	3671 010-114	3671 010-119	3671 010-119
⑮ Drawbar (set)	5461 100-101	5461 100-111	5461 100-121	5461 100-131	5461 100-141
⑯ Spring	5561 001-71	5561 001-41	5561 001-41	5561 001-41	5561 001-41

Accessories	Coupling size				
	C3	C4	C5	C6	C8
⑭ Key	SW 8 (DIN 911)	SW 10 (DIN 911)	SW 12 (DIN 911)	SW 12 (DIN 911)	SW 12 (DIN 911)

Assembly parts and accessories for clamping units Type 2085

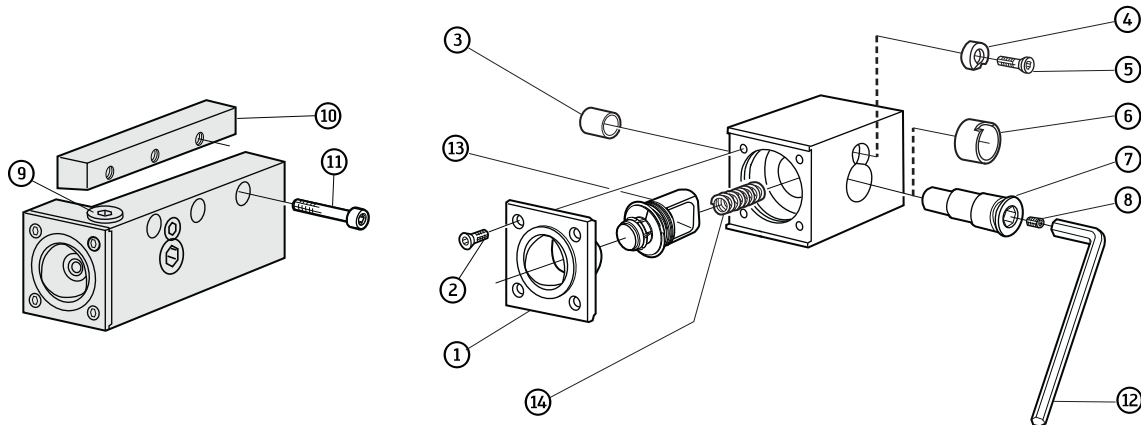

Assembly parts	Coupling size		
	C3	C4	C5
① Adaptor sleeve	5252 010-01	5252 010-02	5252 010-03
② Screw (4 x)	416.1-834	5513 020-26	5513 020-14
③ Slide bearing	3823 010-101	3823 010-122	3823 010-162
④ Retaining bearing	5541 030-01	5541 030-02	5541 030-03
⑤ Screw	416.1-834	416.1-834	5513 020-14
⑥ Slide bearing	5638 022-01	5638 022-02	5638 022-03
⑦ Eccentric bolt	5333 025-01	5333 025-02	5333 025-03
⑧ Screw	3214 010-355	3214 010-355	3214 010-355
⑨ Seal	3611 005-180	3611 005-180	3611 005-180
⑩ Clamping wedge system	5421 115-01	5421 115-02	5421 115-03
⑪ Screw	3212 101-362	3212 101-364	3212 101-416
⑬ Drawbar (set)	5461 100-101	5461 100-111	5461 100-121
⑭ Spring	5561 001-71	5561 001-41	5561 001-41

Accessories	Coupling size		
	C3	C4	C5
⑫ Key	SW 8 (DIN 911)	SW 10 (DIN 911)	SW 12 (DIN 911)

Assembly parts and accessories for clamping units Round shank with clamping surface Type 2035/2045/2055/2065

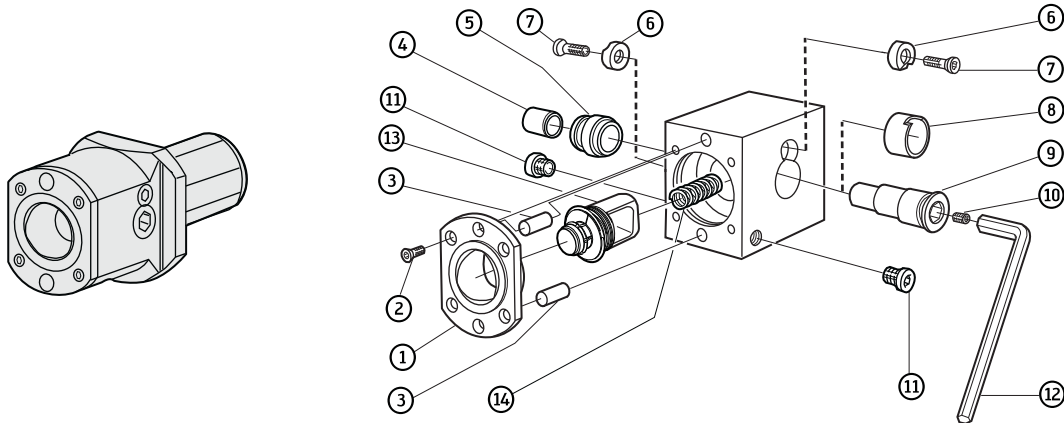

Assembly parts	Coupling size			
	C3	C4	C5	C6
① Adaptor sleeve	5252 010-01	5252 010-02	5252 010-03	5252 010-04
② Screw (4 x)	416.1-834	5513 020-26	5513 020-14	3213 010-410
③ Pin	3111 020-558	3111 020-610	3111 020-661	3111 020-715
④ Slide bearing	3823 010-101	3823 010-122	3823 010-162	3823 010-183
⑤ Bush	5638 024-01	5638 024-02	5638 024-03	5638 024-04
⑥ Retaining washer	5541 030-01	5541 030-02	5541 030-03	5541 030-04
⑦ Screw	416.1-834	416.1-834	5513 020-14	5513 020-14
⑧ Slide bearing	5638 022-01	5638 022-02	5638 022-03	5638 022-04
⑨ Eccentric bolt	5333 025-01	5333 025-02	5333 025-03	5333 025-04
⑩ Screw	3214 010-355	3214 010-355	3214 010-355	3214 010-355
⑪ Seal	3611 005-180	3611 005-180	3611 005-180	3611 005-140
⑬ Drawbar (set)	5461 100-101	5461 100-111	5461 100-121	5461 100-131
⑭ Spring	5561 001-71	5561 001-41	5561 001-41	5561 001-41

Accessories	Coupling size			
	C3	C4	C5	C6
⑫ Key	SW 8 (DIN 911)	SW 10 (DIN 911)	SW 12 (DIN 911)	SW 12 (DIN 911)

Assembly parts and accessories for clamping units Type 2000/Type 3000

Type 2000 – Bushing clamp

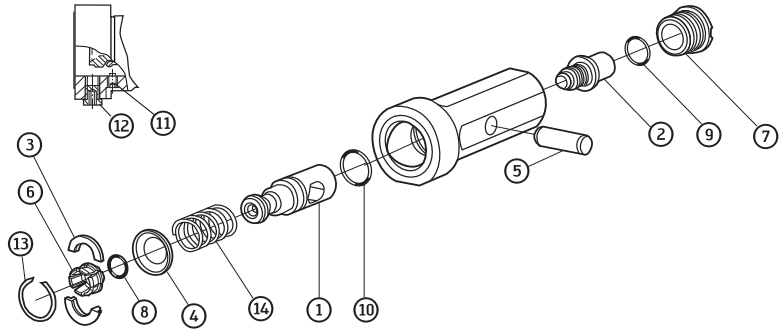

Assembly parts	Coupling size		
	C3	C4	C5
① Drawbar	5461 105-01	5461 105-02	5461 105-03
② Clamping screw	5519 105-01	5519 105-02	5519 105-03
③ Spaced guide ring	5546 002-01	5546 002-02	5546 002-03
④ Ring	5541 028-01	5541 028-02	5541 028-03
⑤ Locking pin	5552 032-01	5552 032-02	5552 032-03
⑥ Segment (1 set = 6 pieces)	5549 120-08	5549 120-06	5549 120-07
⑦ Threaded bush	5512 091-03	5512 091-01	5512 091-02
⑧ O-ring	5641 005-01	5641 005-05	5641 005-06
⑨ O-ring	3671 010-118	3671 010-120	3671 010-124
⑩ O-ring	3671 010-124	3671 010-126	3671 010-128
⑪ Screw	3214 020-204	3214 020-255	3214 020-255
⑫ Seal	3611 005-180	3611 005-180	3611 005-180
⑬ Spring ring	5545 042-01	3421 105-026	3421 105-032
⑭ Spring	5561 001-52	5561 001-53	5561 001-54

Type 3000 – clamping via centre screw

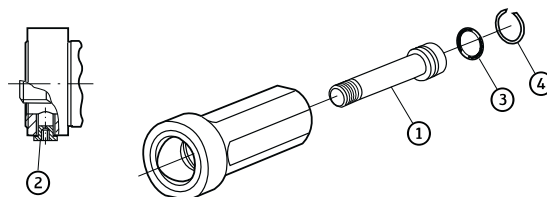

Assembly parts	Coupling size		
	C3	C4	C5
① Clamping screw	5512 096-01	5512 096-02	5512 096-03
② Seal	3611 005-180	3611 005-180	3611 005-180
③ O-ring	3671 010-020	3671 010-022	3671 010-024
④ Spring ring	5545 040-03	5545 040-05	5545 040-06

Accessories	Coupling size		
	C3	C4	C5
Key	SW 8 (DIN 911)	SW 10 (DIN 911)	SW 12 (DIN 911)

Assembly parts and accessories for basic holder C ... – 390.410

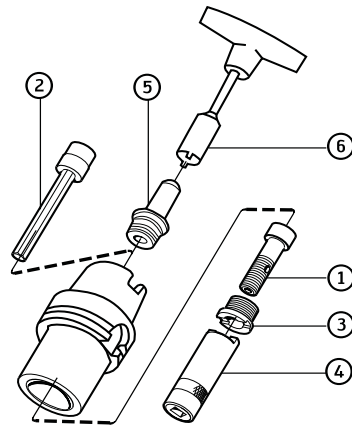

Assembly parts	Coupling size				
	C3	C4	C5	C6	C8
① Centre screw	5512 067-01	5512 067-02	5512 067-03	5512 067-04	5512 067-04
③ Threaded ring	5512 091-04	5512 091-03	5512 091-01	5512 091-02	5512 091-02
⑤ Transfer unit for					
HSK 50	5692 020-03	5692 020-03			
HSK 63	5692 020-04	5692 020-04	5692 020-04		
HSK 80	5692 020-05	5692 020-05	5692 020-05	5692 020-05	
HSK 100		5692 020-06	5692 020-06	5692 020-06	5692 020-06

Accessories	Coupling size				
	C3	C4	C5	C6	C8
② Extension key (mm)	5680 015-05 (SW 8,0)	5680 015-05 (SW 8,0)	5680 015-01 (SW 10,0)	5680 015-02 (SW 14,0)	5680 015-02 (SW 14,0)
④ Socket wrench for threaded ring	5680 065-13	5680 065-10	5680 065-11	5680 065-12	5680 065-12
⑥ Socket wrench for transfer unit					
HSK 50	FS 1212	FS 1212			
HSK 63	FS 952	FS 952	FS 952		
HSK 80	FS 1213	FS 1213	FS 1213	FS 1213	
HSK 100		FS 953	FS 953	FS 953	FS 953

N.B.:

The transfer unit and the threaded ring for machines with automatic tool changing must be mounted in the basic holder.
The clamping system release mechanism can be damaged if the transfer unit/threaded ring is not installed.

Assembly parts and accessories for extensions C ... – 391.01

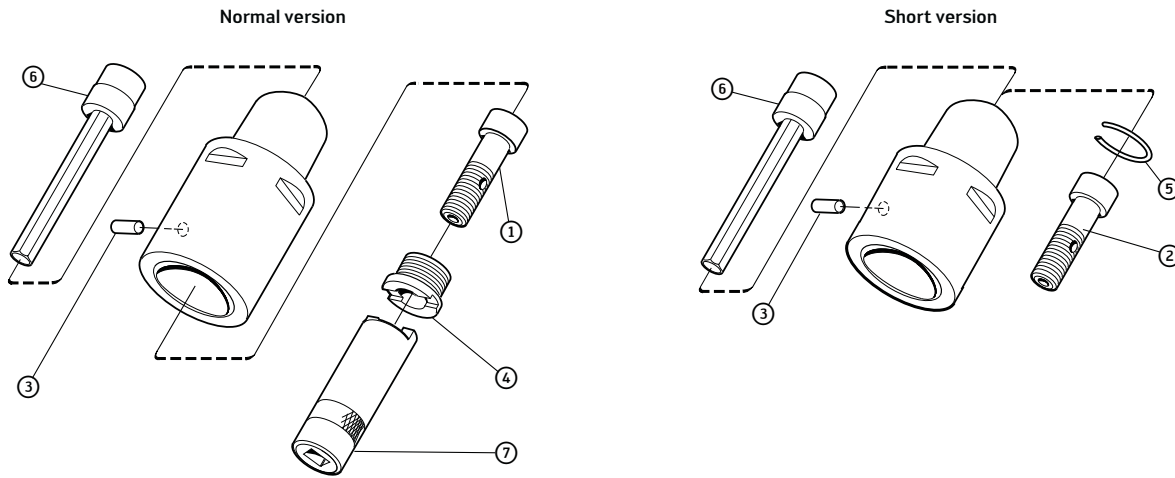

Assembly parts	Coupling size				
	C3	C4	C5	C6	C8
① Centre screw Normal version	5512 067-01	5512 067-02	5512 067-03	5512 067-04	5512 067-04
② Centre screw Short version	5512 068-01	5512 068-02	5512 068-03	5512 068-04	5512 068-05
③ Pin	3113 020-304	3113 020-355	3113 020-406	3113 020-457	3113 020-509
④ Retaining nut	5512 091-04	5512 091-03	5512 091-01	5512 091-02	5512 091-02
⑤ Retaining ring	5545 040-02	5545 040-03	5545 040-07	5545 040-08	5545 040-08

Remark:

Centre screw ① and ② can be used to extend Walter Capto™ cutting heads with internal coolant supplies.

Accessories	Coupling size				
	C3	C4	C5	C6	C8
⑥ Extension key (mm)	5680 015-05 (SW 8,0)	5680 015-05 (SW 8,0)	5680 015-01 (SW 10,0)	5680 015-02 (SW 14,0)	5680 015-02 (SW 14,0)
⑦ Socket wrench for retaining nut	5680 065-13	5680 065-10	5680 065-11	5680 065-12	5680 065-12

Assembly parts and accessories for reductions C ... – 391.02

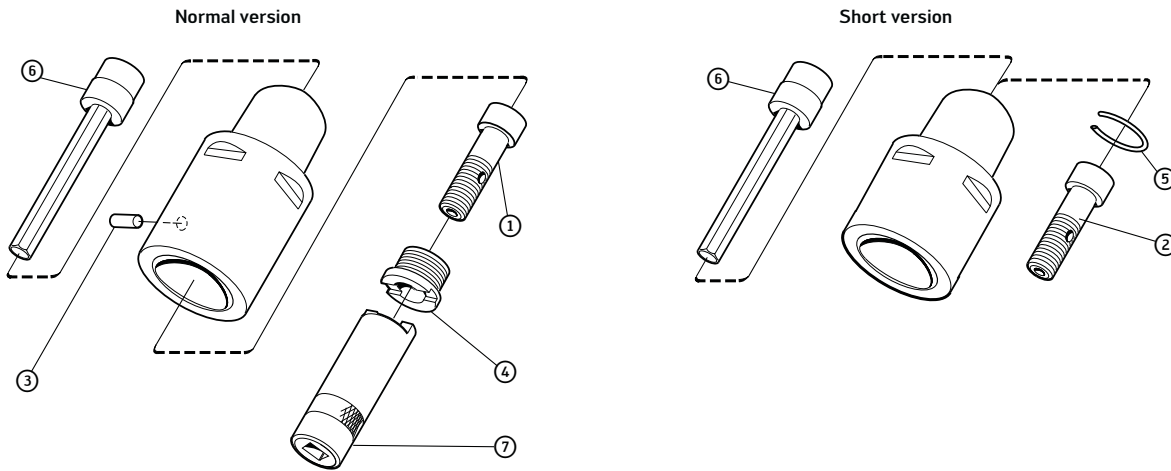

Assembly parts

Coupling size – Machine end	C4/C5/C6/C8	C5	C6/C8	C6	C8	C8
Coupling size – Tool end	C3	C4	C4	C5	C5	C6
① Centre screw Normal version	5512 067-01	5512 067-02	5512 067-02	5512 067-03	5512 067-03	5512 067-04
② Centre screw Short version	5512 068-01	5512 068-06	5512 068-02	5512 068-07	5512 068-08	5512 068-05
③ Pin	3113 020-304	3113 020-355	3113 020-355	3113 020-406	3113 020-406	3113 020-457
④ Retaining nut	5512 091-04	5512 091-03	5512 091-03	5512 091-01	5512 091-01	5512 091-02
⑤ Retaining ring	5545 040-02	5545 040-07	5545 040-03	5545 040-08	5545 040-08	5545 040-08

Remark:

Centre screw ① and ② can be used to extend Walter Capto™ cutting heads with internal coolant supplies.

Accessories

Coupling size – Machine end	C4/C5/C6/C8	C5	C6/C8	C6	C8	C8
Coupling size – Tool end	C3	C4	C4	C5	C5	C6
⑥ Extension key	5680 015-05 (SW 8,0)	5680 015-05 (SW 8,0)	5680 015-05 (SW 8,0)	5680 015-01 (SW 8,0)	5680 015-01 (SW 8,0)	5680 015-02 (SW 12,0)
⑦ Socket wrench for retaining nut	5680 065-13	5680 065-10	5680 065-10	5680 065-11	5680 065-11	5680 065-12

Master DIN 2080/ISO 2583
A 100 M.1
SK40 + SK50



- Modular NCT adaptor

Tool	Designation	d ₁ mm	d ₁₁ mm	l ₄ mm	d ₁₃ mm	Version	kg
SK DIN 2080/ISO 2583 	A100M.1.40.030.63*	SK40	NCT63	30	M16	B	1,1
	A100M.1.50.020.25	SK50	NCT25	20	M24	C	2,8
	A100M.1.50.020.32	SK50	NCT32	20	M24	C	2,8
	A100M.1.50.020.40	SK50	NCT40	20	M24	C	2,6
	A100M.1.50.020.50	SK50	NCT50	20	M24	A	2,8
	A100M.1.50.020.63	SK50	NCT63	20	M24	B	2,6
	A100M.1.50.025.80	SK50	NCT80	25	M24	B	2,8

Bodies and assembly parts are included in the scope of delivery.

* SK 40 with ring groove designed for OTT spindle clamp.



G 108



G 116



H 34

Master DIN 69871/1 AD/ISO 7388/1

A 100 M.2

SK40 + SK50

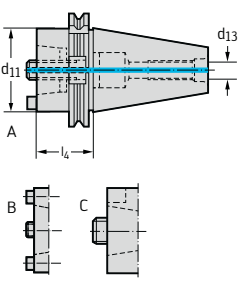

- Modular NCT adaptor

Tool	Designation	d ₁ mm	d ₁₁ mm	l ₄ mm	d ₁₃ mm	Version	
DIN 69871/1/ISO 7388/1 	A100M.2.40.020.25	SK40	NCT25	20	M16	C	0,8
	A100M.2.40.020.32	SK40	NCT32	20	M16	C	0,8
	A100M.2.40.030.40	SK40	NCT40	30	M16	C	0,9
	A100M.2.40.030.50	SK40	NCT50	30	M16	A	1,0
	A100M.2.40.050.63	SK40	NCT63	50	M16	B	1,3
	A100M.2.40.090.80	SK40	NCT80	90	M16	B	2,4
	A100M.2.50.020.25	SK50	NCT25	20	M24	C	2,6
	A100M.2.50.020.32	SK50	NCT32	20	M24	C	2,8
	A100M.2.50.020.40	SK50	NCT40	20	M24	C	2,6
	A100M.2.50.020.50	SK50	NCT50	20	M24	A	2,6
	A100M.2.50.020.63	SK50	NCT63	20	M24	B	2,6
	A100M.2.50.025.80	SK50	NCT80	25	M24	B	2,6

Bodies and assembly parts are included in the scope of delivery.

For pull studs for steep tapers, see page H 42.



Master ANSI and CAT A 100 M.3 SK40 + SK50



- Modular NCT adaptor

Tool	Designation	d ₁ mm	d ₁₁ mm	l ₄ mm	d ₁₃ mm	Version	kg
ANSI/ASME B 5.50-1985 	A100M.3.40.035.25	SK40	NCT25	35	M16	C	1,0
	A100M.3.40.035.32	SK40	NCT32	35	M16	C	1,0
	A100M.3.40.040.40	SK40	NCT40	40	M16	C	1,0
	A100M.3.40.050.50	SK40	NCT50	50	M16	A	1,2
	A100M.3.40.050.63	SK40	NCT63	50	M16	B	1,2
	A100M.3.50.035.25	SK50	NCT25	35	M24	C	3,0
	A100M.3.50.035.32	SK50	NCT32	35	M24	C	3,0
	A100M.3.50.035.40	SK50	NCT40	35	M24	C	3,0
	A100M.3.50.035.50	SK50	NCT50	35	M24	A	3,0
	A100M.3.50.035.63	SK50	NCT63	35	M24	B	3,0
	A100M.3.50.050.80	SK50	NCT80	50	M24	B	3,3

Bodies and assembly parts are included in the scope of delivery.

For pull studs for steep tapers, see page H 42.



G 108



G 116



H 34

Master MAS BT JIS B 6339
A 100 M.4
SK40 + SK50

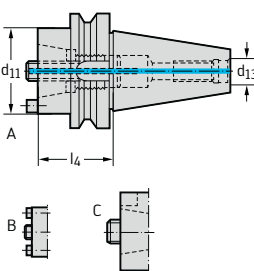

- Modular NCT adaptor

Tool	Designation	d ₁ mm	d ₁₁ mm	l ₄ mm	d ₁₃ mm	Version	
JIS B 6339 	A100M.4.40.030.25	SK40	NCT25	30	M16	C	1,1
	A100M.4.40.030.32	SK40	NCT32	30	M16	C	1,1
	A100M.4.40.030.40	SK40	NCT40	30	M16	C	0,9
	A100M.4.40.030.50	SK40	NCT50	30	M16	A	1,0
	A100M.4.40.040.63	SK40	NCT63	40	M16	B	1,2
	A100M.4.40.090.80	SK40	NCT80	90	M16	B	2,7
	A100M.4.50.040.25	SK50	NCT25	40	M24	C	3,7
	A100M.4.50.040.32	SK50	NCT32	40	M24	C	3,6
	A100M.4.50.040.40	SK50	NCT40	40	M24	C	3,8
	A100M.4.50.040.50	SK50	NCT50	40	M24	A	3,6
	A100M.4.50.040.63	SK50	NCT63	40	M24	B	3,7
	A100M.4.50.040.80	SK50	NCT80	40	M24	B	3,5

Bodies and assembly parts are included in the scope of delivery.

For pull studs for steep tapers, see page H 42.



Master DIN 69871/1 Form AD+B

AK 200 M.2

SK40 + SK50



- Modular NCT adaptor

Tool	Designation	d ₁ mm	d ₁₁ mm	l ₄ mm	d ₁₃ mm	Version	kg	
	DIN 69871/1 AD+B	AK200M.2.40.030.25	SK40	NCT25	30	M16	C	1,0
	AK200M.2.40.030.32	SK40	NCT32	30	M16	C	1,0	
	AK200M.2.40.030.40	SK40	NCT40	30	M16	C	0,9	
	AK200M.2.40.030.50	SK40	NCT50	30	M16	A	0,9	
	AK200M.2.40.060.63	SK40	NCT63	60	M16	B	1,5	
	AK200M.2.50.030.25	SK50	NCT25	30	M24	C	3,0	
	AK200M.2.50.030.32	SK50	NCT32	30	M24	C	3,0	
	AK200M.2.50.030.40	SK50	NCT40	30	M24	C	3,0	
	AK200M.2.50.030.50	SK50	NCT50	30	M24	A	3,0	
	AK200M.2.50.030.63	SK50	NCT63	30	M24	B	3,0	
	AK200M.2.50.030.80	SK50	NCT80	30	M24	B	2,8	

Bodies and assembly parts are included in the scope of delivery.

The masters are supplied in acc. with version AD.

To convert to form B, the two threaded plugs screwed in at the side must be removed.

For pull studs for steep tapers, see page H 42.

Assembly parts	d ₁ mm	SK40	SK50
	Threaded plug ISO 4026	M04X004 ISO 4026	
	Threaded plug ISO 4026		FS974



Master Walter Capto™ ISO 26623
A 100 M.8
C6 - C8



- Modular NCT adaptor

Tool	Designation	d ₁ mm	d ₁₁ mm	l ₄ mm	l ₁₆ mm	kg
Walter Capto ISO 26623	A100M.8.63.070.63.C6	C6	NCT63	70	40	1,9
	A100M.8.63.070.80.C6	C6	NCT80	70	30,5	2,2
	A100M.8.80.065.63.C8	C8	NCT63	65	35	2,5
	A100M.8.80.070.80.C8	C8	NCT80	70	40	3,1

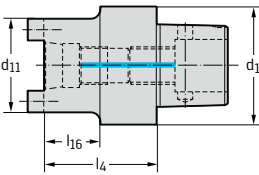

Extension A 101 M



- Modular NCT adaptor

Tool	Designation	d ₁ mm	d ₁₁ mm	l ₄ mm	Version	kg
Modular NCT adaptor 	A101M.0.25.050.25	NCT25	NCT25	50	C	0,2
	A101M.0.25.060.25	NCT25	NCT25	60	C	1,1
	A101M.0.32.050.32	NCT32	NCT32	50	C	0,3
	A101M.0.32.060.32	NCT32	NCT32	60	C	0,5
	A101M.0.32.075.32	NCT32	NCT32	75	C	0,5
	A101M.0.40.070.40	NCT40	NCT40	70	C	0,6
	A101M.0.40.080.40	NCT40	NCT40	80	C	0,7
	A101M.0.50.070.50	NCT50	NCT50	70	A	1,0
	A101M.0.50.080.50	NCT50	NCT50	80	A	1,1
	A101M.0.50.100.50	NCT50	NCT50	100	A	1,4
	A101M.0.63.080.63	NCT63	NCT63	80	B	1,8
	A101M.0.63.100.63	NCT63	NCT63	100	B	2,3
	A101M.0.63.120.63	NCT63	NCT63	120	B	2,7
	A101M.0.63.140.63	NCT63	NCT63	140	B	3,2
	A101M.0.63.160.63	NCT63	NCT63	160	B	3,6
	A101M.0.80.100.80	NCT80	NCT80	100	B	3,6
	A101M.0.80.120.80	NCT80	NCT80	120	B	4,4
	A101M.0.80.140.80	NCT80	NCT80	140	B	5,1
	A101M.0.80.160.80	NCT80	NCT80	160	B	5,9

Bodies and assembly parts are included in the scope of delivery.

Reduction A 102 M



- Modular NCT adaptor

Tool	Designation	d ₁ mm	d ₁₁ mm	d ₁₄ mm	l ₄ mm	l ₁₆ mm	Version	kg
Modular NCT adaptor 	A102M.0.32.050.25	NCT32	NCT25	25	50	32	C	0,2
	A102M.0.40.050.25	NCT40	NCT25	25	50	30	C	0,3
	A102M.0.40.050.32	NCT40	NCT32	32	50	28	C	0,4
	A102M.0.50.050.25	NCT50	NCT25	25	50	25	C	0,4
	A102M.0.50.050.32	NCT50	NCT32	32	50	25	C	0,5
	A102M.0.50.070.40	NCT50	NCT40	40	70	50	C	0,7
	A102M.0.63.050.25	NCT63	NCT25	25	50	20	C	0,7
	A102M.0.63.050.32	NCT63	NCT32	32	50	20	C	0,7
	A102M.0.63.060.25	NCT63	NCT25	25	60	30	C	0,6
	A102M.0.63.060.32	NCT63	NCT32	32	60	30	C	0,6
	A102M.0.63.070.40	NCT63	NCT40	40	70	45	C	0,9
	A102M.0.63.070.50	NCT63	NCT50	50	70	45	A	1,2
	A102M.0.63.080.25	NCT63	NCT25	25	80	50	C	0,8
	A102M.0.63.080.32	NCT63	NCT32	32	80	50	C	0,9
	A102M.0.63.080.40	NCT63	NCT40	40	80	55	C	1,0
	A102M.0.63.080.50	NCT63	NCT50	50	80	55	A	1,3
	A102M.0.63.100.40	NCT63	NCT40	40	100	75	C	1,0
	A102M.0.63.100.50	NCT63	NCT50	50	100	75	A	1,6
	A102M.0.63.120.40	NCT63	NCT40	40	120	95	C	1,3
	A102M.0.63.120.50	NCT63	NCT50	50	120	95	A	1,9
	A102M.0.63.140.40	NCT63	NCT40	40	140	115	C	1,6
	A102M.0.63.140.50	NCT63	NCT50	50	140	115	A	2,2
	A102M.0.80.080.40	NCT80	NCT40	40	80	45	C	1,6
	A102M.0.80.080.50	NCT80	NCT50	50	80	48	A	1,9
	A102M.0.80.080.63	NCT80	NCT63	63	80	50	B	2,2

Bodies and assembly parts are included in the scope of delivery.

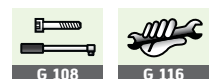

Expansion A 103 M



- Modular NCT adaptor

Tool	Designation	d ₁ mm	d ₁₁ mm	d ₁₄ mm	l ₄ mm	l ₁₆ mm	
Modular NCT adaptor	A103M.0.63.090.80	NCT63	NCT80	80	90	55	2,5

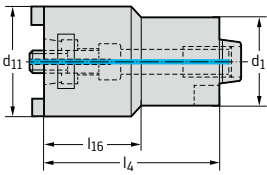

Bodies and assembly parts are included in the scope of delivery.



Morse taper intermediate sleeve A 120 M



- For tools in acc. with DIN 228 version B
- Without draw bolt thread

Tool	Designation	d ₁ mm	d ₁₁ mm	d ₁₂ mm	d ₁₄ mm	l ₄ mm	l ₁₆ mm	kg
Modular NCT adaptor 	A120M.0.32.100.02	NCT32	MK2	32	32	100	100	0,5
	A120M.0.40.105.02	NCT40	MK2	32	32	105	86	0,6
	A120M.0.40.120.03	NCT40	MK3	40	40	120	120	0,9
	A120M.0.50.105.02	NCT50	MK2	32	32	105	85	0,7
	A120M.0.50.120.03	NCT50	MK3	40	40	120	100	1,0
	A120M.0.63.130.03	NCT63	MK3	40	40	130	107	1,3
	A120M.0.63.155.04	NCT63	MK4	48	48	155	132	1,8
	A120M.0.80.125.03	NCT80	MK3	40	40	125	103	1,5
	A120M.0.80.150.04	NCT80	MK4	48	48	150	125	2,0
	A120M.0.80.180.05	NCT80	MK5	63	63	180	153	3,1

Bodies and assembly parts are included in the scope of delivery.



Morse taper intermediate sleeve A 130 M



- For tools in acc. with DIN 228 version A
- With draw bolt thread

Tool	Designation	d ₁ mm	d ₁₁ mm	d ₁₂ mm	d ₁₄ mm	l ₄ mm	l ₁₆ mm	kg
Modular NCT adaptor	A130M.0.63.115.02	NCT63	MK2	24	32	115	75	1,2
	A130M.0.63.125.03	NCT63	MK3	32	40	125	93	1,1
	A130M.0.63.155.04	NCT63	MK4	40	48	155	125	1,7
	A130M.0.63.220.02	NCT63	MK2	24	34	220	190	1,4
	A130M.0.63.250.03	NCT63	MK3	32	44	250	220	2,4
	A130M.0.63.250.04	NCT63	MK4	40	52	250	220	3,0
	A130M.0.80.135.03	NCT80	MK3	32	40	135	95	2,1
	A130M.0.80.155.04	NCT80	MK4	40	48	155	121	2,3
	A130M.0.80.180.05	NCT80	MK5	52	63	180	150	3,0

Bodies and assembly parts are included in the scope of delivery.

Assembly parts		d ₁ mm	MK 2	MK 3	MK 4	MK 5
	Screw	63	FS 652 for l ₄ = 115 mm FS 796 for l ₄ = 220 mm	FS831	FS832	
		80		FS831	FS833	FS834
	Threaded ring	63	FS 1076 for X ₁ = 115 mm FS 1231 for X ₁ = 220 mm	FS1077	FS655	FS413
		80		FS1078	FS655	
	Threaded plug ISO 4027	63	M 5 x 12	M 5 x 8	M 6 x 10	
		80		M 6 x 16	M 6 x 10	M 6 x 12

Accessories		d ₁ mm	MK 2	MK 3	MK 4	MK 5
	Pipe wrench	63+80	FS 1460 for i ₄ = 115 mm FS 1206 for i ₄ = 220 mm	FS739	FS740	FS741
		63	SW 2,5	SW 2,5	SW 2,5	
	Hexagon key DIN 911 for threaded plug	80		SW 3	SW 3	SW 3
		63	SW 7	SW 10	SW 12	
	Hexagon key DIN 911 for screw	80		SW 10	SW 14	SW 14



Combination adaptor A 150 M



- For tools in acc. with DIN 841 and DIN 1880
- For tools in acc. with DIN 842
- For tools in acc. with DIN 1830

Tool	Designation	d ₁ mm	d ₁₁ mm	d ₁₂ mm	l ₄ mm	l _{4max} mm	l ₁₉ mm	kg
Modular NCT adaptor 	A150M.0.32.030.16	NCT32	16	32	20	30	27	0,3
	A150M.0.40.030.16	NCT40	16	32	20	30	27	0,3
	A150M.0.40.030.22	NCT40	22	40	18	30	31	0,4
	A150M.0.50.035.16	NCT50	16	32	25	35	27	0,4
	A150M.0.50.035.22	NCT50	22	40	23	35	31	0,5
	A150M.0.50.035.27	NCT50	27	48	23	35	33	0,6
	A150M.0.50.040.32	NCT50	32	58	26	40	38	1,0
	A150M.0.63.035.16	NCT63	16	32	25	35	27	0,6
	A150M.0.63.035.22	NCT63	22	40	23	35	31	0,7
	A150M.0.63.035.27	NCT63	27	48	23	35	33	0,8
	A150M.0.63.040.32	NCT63	32	58	26	40	38	1,1
	A150M.0.63.040.40	NCT63	40	70	26	40	41	1,5
	A150M.0.80.040.22	NCT80	22	40	28	40	31	1,0
	A150M.0.80.040.27	NCT80	27	48	28	40	33	1,8
	A150M.0.80.040.32	NCT80	32	58	26	40	38	1,4
	A150M.0.80.040.40	NCT80	40	70	26	40	41	1,8
	A150M.0.80.045.50	NCT80	50	90	29	45	46	2,8
	A150M.0.80.055.60	NCT80	60	110	39	55	66	5,0

Bodies and assembly parts are included in the scope of delivery.

Assembly parts	d ₁₁ mm	16	22	27	32	40	50	60
Drive collar DIN 6366		FS424	FS425	FS426	FS427	FS428	FS429	FS911
Cutter locking bolt DIN 6367		FS430	FS431	FS432	FS433	FS434	FS435	FS912

Accessories	d ₁₁ mm	16	22	27	32	40	50	60
Wrench for milling cutter locking bolt		FS436	FS437	FS438	FS439	FS440	FS441	FS913
Spacer ring set b ₁		FS418 = 2, 5, 10 mm	FS419 = 2, 5, 10 mm	FS420 = 2, 5, 10 mm	FS421 = 3, 5, 10 mm	FS422 = 2, 10, 20 mm	FS423 = 2, 10, 20 mm	FS914 = 2, 10, 20 mm
Spacer rings b ₁		FS461 = 2 mm	FS465 = 2 mm	FS469 = 2 mm	FS473 = 2 mm	FS477 = 2 mm	FS481 = 2 mm	FS915 = 2 mm
		FS462 = 3 mm	FS466 = 3 mm	FS470 = 3 mm	FS474 = 3 mm	FS478 = 3 mm	FS482 = 3 mm	FS916 = 3 mm
		FS463 = 5 mm	FS467 = 5 mm	FS471 = 5 mm	FS475 = 5 mm	FS479 = 5 mm	FS483 = 5 mm	FS917 = 5 mm
		FS464 = 10 mm	FS468 = 10 mm	FS472 = 10 mm	FS476 = 10 mm	FS480 = 10 mm	FS484 = 10 mm	FS918 = 10 mm



Face mill adaptor A 155 M



- With enlarged location face and fixed drive dogs
- For tools in acc. with DIN 1880

Tool	Designation	d ₁ mm	d ₁₁ mm	d ₁₂ mm	l ₄ mm	l ₁₉ mm	kg
Modular NCT adaptor 	A155M.0.63.030.22	NCT63	22	50	30	19	0,7
	A155M.0.63.030.27	NCT63	27	60	30	21	0,8
	A155M.0.63.030.32	NCT63	32	78	30	24	1,2
	A155M.0.63.045.40*	NCT63	40	89	45	27	2,1
	A155M.0.80.030.22	NCT80	22	50	30	19	1,0
	A155M.0.80.030.27	NCT80	27	60	30	21	1,2
	A155M.0.80.030.32	NCT80	32	78	30	24	1,4
	A155M.0.80.040.40*	NCT80	40	89	40	27	2,1
	A155M.0.80.065.60*	NCT80	60	128	65	50	5,2

Bodies and assembly parts are included in the scope of delivery.

* With 4 additional threaded holes for tools with ISO 40 or ISO 50 adaption in acc. with DIN 2079.

Assembly parts	d ₁₁ mm	22	27	32	40	60
Cutter locking bolt DIN 6367		FS431	FS432	FS433	FS434	FS912

Accessories	d ₁₁ mm	22	27	32	40	60
Wrench for milling cutter locking bolt		FS437	FS438	FS439	FS440	FS913



Face mill adaptor AK 155 M



- With enlarged collar and fixed drive dogs
- For tools with crosswise slot in acc. with DIN 1880

Tool	Designation	d ₁ mm	d ₁₁ mm	d ₁₂ mm	l ₄ mm	l ₁₉ mm	kg	
	Modular NCT adaptor	AK155M.0.50.025.16	NCT50	16	38	25	17	0,4
		AK155M.0.50.025.22	NCT50	22	48	25	19	0,5
		AK155M.0.63.030.16	NCT63	16	68	30	17	0,6
		AK155M.0.63.030.22	NCT63	22	48	30	19	0,7
		AK155M.0.63.030.27	NCT63	27	60	30	21	0,8
		AK155M.0.63.030.32	NCT63	32	78	30	24	1,2
		AK155M.0.80.030.27	NCT80	27	60	30	21	1,2
		AK155M.0.80.030.32	NCT80	32	78	30	24	1,5
		AK155M.0.80.040.40*	NCT80	40	89	40	27	2,1

Bodies and assembly parts are included in the scope of delivery.

* With 4 additional threaded holes for tools with ISO 40 adaption in acc. with DIN 2079.

Assembly parts	d ₁₁ mm	16	22	27	32	40
	Locking bolt ISO 4762	FS938 (SW 6) M8 x 25	FS939 (SW 8) M10 x 25	FS940 (SW 10) M12 x 35	FS941 (SW 14) M16 x 35	FS942 (SW 17) M20 x 40

Accessories	d ₁₁ mm	16	22	27	32	40
	Allen key ISO 2936	ISO 2936-6 (SW 6)	ISO 2936-8 (SW 8)	ISO 2936-10 (SW 10)	ISO 2936-14 (SW 14)	ISO 2936-17 (SW 17)



Weldon shank adaptor A 170 M



- For tools with shank in acc. with DIN 1835 Form B/DIN 6535-HB

Tool	Designation	d ₁ mm	d ₁₁ mm	d ₁₂ mm	l ₄ mm	l ₁₆ mm	kg
Modular NCT adaptor 	A170M.0.25.050.06	NCT25	6	25	50		0,2
	A170M.0.32.050.08	NCT32	8	28	50	32	0,2
	A170M.0.32.060.10	NCT32	10	36	60	38	0,4
	A170M.0.32.065.12	NCT32	12	42	65	45	0,6
	A170M.0.40.050.08	NCT40	8	28	50	30	0,4
	A170M.0.40.060.10	NCT40	10	36	60	35	0,5
	A170M.0.40.065.12	NCT40	12	42	65	43	0,6
	A170M.0.40.065.14	NCT40	14	44	65	43	0,7
	A170M.0.40.070.16	NCT40	16	48	70	48	0,8
	A170M.0.40.070.18	NCT40	18	50	70	48	0,8
	A170M.0.50.050.06	NCT50	6	25	50	27	0,4
	A170M.0.50.050.08	NCT50	8	28	50	27	0,4
	A170M.0.50.060.10	NCT50	10	35	60	35	0,6
	A170M.0.50.065.12	NCT50	12	42	65	42	0,7
	A170M.0.50.065.14	NCT50	14	44	65	42	0,8
	A170M.0.50.070.16	NCT50	16	48	70	48	1,0
	A170M.0.50.070.18	NCT50	18	50	70	48	0,9
	A170M.0.63.070.16	NCT63	16	48	70	42	1,2
	A170M.0.63.070.18	NCT63	18	50	70	42	1,2
	A170M.0.63.070.20	NCT63	20	52	70	45	1,0
	A170M.0.63.080.25	NCT63	25	63	80		1,7
	A170M.0.63.085.32	NCT63	32	72	85	68	2,1
	A170M.0.80.070.20	NCT80	20	52	70	38	1,7
	A170M.0.80.085.25	NCT80	25	63	85	62	2,2
	A170M.0.80.085.32	NCT80	32	72	85	65	2,2
	A170M.0.80.095.40	NCT80	40	78	95	75	2,7

Bodies and assembly parts are included in the scope of delivery.

Assembly parts	d ₁₁ mm	6	8	10	12-14	16-18	20	25	32-40
Clamping screw DIN 1835-B		M06X010	M08X010	M10X012	M12X016	M14X016	M16X016	18X2X020	20X2X020



Adaptor for eccentric sleeve A 170 M ... Ex



- For diameter adjustment of indexable insert drills with cylindrical shank

Tool	Designation	d ₁ mm	d ₁₁ mm	d ₁₂ mm	l ₄ mm	kg
Modular NCT adaptor	A170M.0.63.079.32.EX	NCT63	32	72	79	2,0
	A170M.0.80.079.32.EX	NCT80	32	72	79	2,3
	A170M.0.80.087.40.EX	NCT80	40	78	87	2,6
	A170M.0.80.096.50.EX	NCT80	50	85	96	3,2

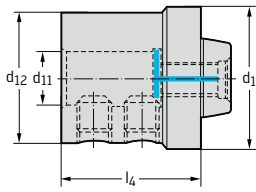

Bodies and assembly parts are included in the scope of delivery.

Assembly parts	d ₁₁ mm	32-40	50
	Screw DIN 1835-B	M20X2X020	M24X2X025

Accessories	d ₁₁ mm	Designation	D _c insert drill mm	D ₂ mm	D ₃ mm	X ₁ mm
 Eccentric sleeve adjustment range: -0.1 to +0.3 mm in comparison to nominal diameter		FS2165	13,5-16,49	20	32	4
		FS2131	16,5-25,49	25	32	4
		FS3132	15,5-35,99	32	40	4
		FS2133	36-59	40	50	4
	Allen key ISO 2936	for D ₃ = 32-40 mm = SW10		for D ₃ = 50 mm = SW12		

Mill extension DIN 1835 B A 175



- For tools with cylindrical shank

Tool	Designation	d ₁ mm	d ₁₁ mm	l ₁ mm	kg
	DIN 1835 B				
	A175.0.20.090.04	20	4	90	0,2
	A175.0.20.090.05	20	5	90	0,2
	A175.0.20.090.06	20	6	90	0,2
	A175.0.20.090.08	20	8	90	0,2
	A175.0.20.090.10	20	10	90	0,2
	A175.0.20.090.12	20	12	90	0,2
	A175.0.20.130.04	20	4	130	0,2
	A175.0.20.130.05	20	5	130	0,3
	A175.0.20.130.06	20	6	130	0,3
	A175.0.20.130.08	20	8	130	0,3
	A175.0.20.130.10	20	10	130	0,3
	A175.0.20.130.12	20	12	130	0,3
	A175.0.25.100.14	25	14	100	0,3
	A175.0.25.100.16	25	16	100	0,3
	A175.0.25.150.14	25	14	150	0,5
	A175.0.25.150.16	25	16	150	0,4

Bodies and assembly parts are included in the scope of delivery.

Assembly parts	d ₁₁ mm	4	5	6-10	12	14-16
	Threaded plug	M04X008 DIN 913	M05X008 DIN 913	M06X006 DIN 913	M06X005 DIN 913	M06X006 DIN 913

Small drill chuck A 201 M



- With clamping mechanism backup

Tool	Designation	d ₁ mm	d ₁₁ mm	d ₁₂ mm	l ₄ mm	kg	
Modular NCT adaptor	A201M.0.50.092.13	NCT50	1 - 13	50	50	92	1,3

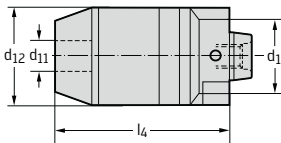

The clamping mechanism backup prevents loosening when the spindle stops quickly.



Collet chuck AK 300 T



- For ER collets in acc. with DIN 6499

Tool	Designation	d ₁ mm	d ₁₁ mm	d ₁₂ mm	l ₄ mm	Collets	kg
NCT ScrewFit 	AK300.T18.030.06	T18	1 - 6	19	30	ER 11	0,1
	AK300.T22.030.06	T22	1 - 6	19	30	ER 11	0,1
	AK300.T22.040.10	T22	1 - 10	28	40	ER 16	0,9
	AK300.T22.045.10	T22	1 - 10	28	45	ER 16	0,9
	AK300.T28.040.10	T28	1 - 10	28	40	ER 16	0,9
	AK300.T28.045.10	T28	1 - 10	28	45	ER 16	0,9
	AK300.T36.050.16	T36	1 - 16	42	50	ER 25	0,9
	AK300.T36.055.16	T36	1 - 16	42	55	ER 25	0,9

Bodies and assembly parts are included in the scope of delivery.

If the collet chuck is used with internal coolant supply, the sealing discs on page G 102 must be used.

N.B.: The clamping nut can be damaged if the chuck is used without a sealing disc.

For collets, see page G 99.

Assembly parts	Collets	ER 11	ER 16	ER 25
	Clamping nut	FS653	FS1537	FS1540
	Clamping nut for internal coolant supply		FS1448	FS1449

Accessories	Collets	ER 16	ER 25
	Tensioning key	FS1539	FS1544



ER collet chuck with internal cooling AK 300 M

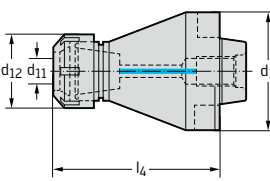

- For ER collets in acc. with DIN 6499

Tool	Designation	d ₁ mm	d ₁₁ mm	d ₁₂ mm	l ₄ mm	Collets		
	Modular NCT adaptor	AK300M.0.25.055.10	NCT25	1 - 10	28	55	ER 16	0,2
		AK300M.0.32.055.10	NCT32	1 - 10	28	55	ER 16	0,2
		AK300M.0.40.085.16	NCT40	1 - 16	42	85	ER 25	0,6
		AK300M.0.50.085.16	NCT50	1 - 16	42	85	ER 25	0,8
		AK300M.0.50.085.20	NCT50	1 - 20	50	85	ER 32	0,9
		AK300M.0.50.085.26	NCT50	2 - 26	63	85	ER 40	1,0
		AK300M.0.63.085.26	NCT63	2 - 26	63	85	ER 40	1,4

Bodies and assembly parts are included in the scope of delivery.

If the collet chuck is used with internal coolant supply, the sealing discs on page G 102 must be used.

N.B.: The clamping nut can be damaged if the chuck is used without a sealing disc.

For collets, see page G 99.

Assembly parts	Collets	ER 16	ER 25	ER 32	ER 40
	Clamping nut for internal coolant supply	FS1448	FS1449	FS1360	FS1450

Accessories	Collets	ER 16	ER 25	ER 32	ER 40
	Tensioning key	FS1539	FS1544	FS1545	FS1546



Collet chuck AK 300 M



- For ER collets in acc. with DIN 6499

Tool	Designation	d ₁ mm	d ₁₁ mm	d ₁₂ mm	l ₄ mm	Collets	kg
Modular NCT adaptor 	AK300M.0.25.050.10	NCT25	1 - 10	28	50	ER 16	0,2
	AK300M.0.32.050.10	NCT32	1 - 10	28	50	ER 16	0,2
	AK300M.0.40.080.16	NCT40	1 - 16	42	80	ER 25	0,6
	AK300M.0.50.080.16	NCT50	1 - 16	42	80	ER 25	0,8
	AK300M.0.50.080.20	NCT50	1 - 20	50	80	ER 32	0,9
	AK300M.0.50.080.26	NCT50	2 - 26	63	80	ER 40	1,0
	AK300M.0.63.080.26	NCT63	2 - 26	63	80	ER 40	1,3

Bodies and assembly parts are included in the scope of delivery.

For collets, see page G 99.

Assembly parts	Collets	ER 16	ER 25	ER 32	ER 40
	Clamping nut	FS1537	FS1540	FS1541	FS1542

Accessories	Collets	ER 16	ER 25	ER 32	ER 40
	Tensioning key	FS1539	FS1544	FS1545	FS1546



Collet chuck DIN 1835 B A 305



- For ER collets in acc. with DIN 6499

Tool	Designation	d ₁ mm	d ₁₁ mm	d ₁₂ mm	l ₁ mm	d ₁₅ mm	Collets	kg
	DIN 1835 B							
	A305.0.16.120.06	16	1 - 6	19	120	M8	ER 11	0,2
	A305.0.16.180.06	16	1 - 6	19	180	M8	ER 11	0,2
	A305.0.25.140.10	25	1 - 10	28	140	M12	ER 16	0,4
	A305.0.25.180.10	25	1 - 10	28	180	M12	ER 16	0,5

Bodies and assembly parts are included in the scope of delivery.
For collets, see page G 99.

Assembly parts	Collets	ER 11	ER 16
	Clamping nut Tightening torque	FS653 30,0 Nm	FS1537 40,0 Nm

Quick change tap chuck A 320 M



- With elastic length compensation for compression and extension

Tool	Designation	d ₁ mm	d ₁₁ mm	d ₁₂ mm	l ₄ mm	Length adjustment C	Length adjust- ment T	Collet size	For taps	kg
Modular NCT adaptor 	A320M.0.40.110.19	NCT40	19	36	110	7,5	7,5	1	M 4-M 12	0,9
	A320M.0.50.136.31	NCT50	31	53	136	12,5	12,5	3	M 8-M 20	1,8
	A320M.0.63.180.48	NCT63	48	78	180	20	20	4	M 14-M 33	4,1
	A320M.0.63.196.60	NCT63	60	96	196	22,5	22,5	5	M 22-M 48	5,8

Bodies and assembly parts are included in the scope of delivery.

A quick change collet A 330/A 331 is required for every tap shank size, see page G 98.



G 98



G 116



G 104

Soft synchro chuck A 340 M



- For ER collet in acc. with DIN 6499
- For thread cutting on synchronous spindles

Tool	Designation	d ₁ mm	d ₁₁ mm	d ₁₂ mm	l ₄ mm	Collets	kg
Modular NCT adaptor	A340M.0.40.092.10	NCT40	4,5 - 10	34	92	ER 20	0,5
	A340M.0.50.105.16	NCT50	4,5 - 16	50	105	ER 32	1,0

Bodies and assembly parts are included in the scope of delivery.
 If the soft synchro chuck is used with internal coolant supply, the sealing discs on page G 102 must be used.
 N.B.: The clamping nut can be damaged if the chuck is used without a sealing disc.
 For tap collets, see page G 101.

Assembly parts	Collets	ER 20	ER 32
	Clamping nut for internal coolant supply	FS1359	FS1360
	Tensioning key	FS1452	FS1545

Shell Reamer holder with morse taper Z2311

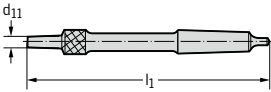

- For shell reamers F7133

DIN 217			l_1 mm	
Morse taper 	Designation			
	Z2311-13	13	250	0,6
	Z2311-16	16	261	0,7
	Z2311-19	19	298	1,3
	Z2311-22	22	312	1,6
	Z2311-27	27	359	2,2
	Z2311-32	32	376	4,2
	Z2311-40	40	396	5,5
	Z2311-50	50	416	7,9

Morse taper adaptor AK 500



- For NCT ScrewFit front pieces

Tool	Designation	d ₁ mm	d ₁₁ mm	l ₄ mm	d ₁₃ mm	Version	kg	
Shank DIN 228 A 	AK500.M2.T18.015	MK2	T18	15	M10	B	0,3	
	AK500.M2.T18.065	MK2	T18	65	M10	B	0,2	
	AK500.M3.T22.035	MK3	T22	35	M12	A	0,3	
	AK500.M3.T22.065	MK3	T22	65	M12	A	0,4	
	AK500.M3.T28.035	MK3	T28	35	M12	B	0,3	
	AK500.M3.T28.065	MK3	T28	65	M12	B	0,4	
	AK500.M4.T22.100	MK4	T22	100	M16	A	0,7	
	AK500.M4.T28.045	MK4	T28	45	M16	A	0,6	
	AK500.M4.T28.075	MK4	T28	75	M16	A	0,7	

Adaptor DIN 1835 A

AK 510/A 510



- For NCT ScrewFit front pieces

Tool	Designation	d ₁ mm	d ₁₁ mm	l ₁₆ mm	l ₄ mm	l ₁ mm	Version	kg	
Shank DIN 1835 A 	AK510.Z10.T09.030	10	T09	10	30	70	A	0,1	
	AK510.Z10.T09.060	10	T09	20	60	100	A	0,1	
	AK510.Z12.T09.060	12	T09	20	60	105	A	0,1	
	AK510.Z16.T09.090	16	T09	20	90	140	A	0,2	
	AK510.Z16.T14.050	16	T14	45	50	100	A	0,1	
	AK510.Z16.T14.110	16	T14	45	110	160	A	0,2	
	AK510.Z20.T14.108	20	T14	52	108	160	B	0,3	
	AK510.Z20.T18.068	20	T18	50	68	120	A	0,2	
	AK510.Z20.T18.128	20	T18	50	128	180	A	0,3	
	AK510.Z25.T14.152	25	T14	100	152	210	B	0,6	
	AK510.Z25.T18.122	25	T18	62	122	180	B	0,6	
	AK510.Z25.T22.072	25	T22	55	72	130	A	0,4	
	AK510.Z25.T22.142	25	T22	55	142	200	A	0,6	
	AK510.Z25.T28.072	25	T28	55	72	130	C	0,5	
	AK510.Z25.T28.142	25	T28	55	142	200	C	0,7	
	AK510.Z32.T18.178	32	T18	128	178	240	B	1,1	
	AK510.Z32.T22.138	32	T22	95	138	200	B	1,0	
	AK510.Z32.T28.138	32	T28	40	138	200	B	1,1	
	AK510.Z32.T36.090	32	T36	60	90	150	C	0,9	
	AK510.Z32.T36.140	32	T36	60	140	200	C	1,2	
	AK510.Z40.T22.228	40	T22	172	228	300	B	2,1	
	AK510.Z40.T28.228	40	T28	115	228	300	B	2,6	
	AK510.Z40.T36.130	40	T36	60	130	200	A	1,4	
	AK510.Z40.T36.230	40	T36	100	230	300	A	2,6	
	AK510.Z40.T45.080	40	T45	60	80	150	C	1,5	
	AK510.Z40.T45.230	40	T45	100	230	300	C	2,8	
	Shank DIN 1835 A Without coolant supply Solid carbide shank 	A510.Z10.T09.070-CS	10	T09	29	70	120	D	0,1
		A510.Z12.T09.120-CS	12	T09	32	120	170	E	0,3
A510.Z16.T14.070-CS		16	T14	38	70	120	E	0,3	
A510.Z16.T14.120-CS		16	T14	37	120	170	E	0,4	
A510.Z20.T14.278-CS		20	T14	37	278	330	E	1,4	
A510.Z20.T18.070-CS		20	T18	45	70	120	D	0,4	
A510.Z20.T18.123-CS		20	T18	45	123	175	D	0,7	
A510.Z25.T18.277-CS		25	T18	45	277	335	D	2,2	
A510.Z25.T22.070-CS		25	T22	55	70	130	D	0,7	
A510.Z25.T22.122-CS		25	T22	55	122	180	D	1,1	
A510.Z25.T22.282-CS		25	T22	55	282	340	D	2,2	
A510.Z25.T28.070-CS		25	T28	55	70	130	F	0,8	
A510.Z25.T28.127-CS		25	T28	60	127	185	F	1,2	
A510.Z32.T28.283-CS		32	T28	60	283	345	D	3,7	

NCT adaptor

AK 520

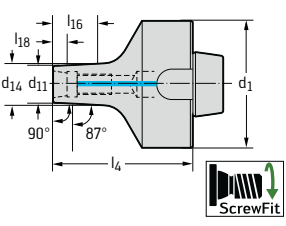

- For NCT ScrewFit front pieces

Tool	Designation	d ₁ mm	d ₁₁ mm	d ₁₄ mm	l ₄ mm	l ₁₆ mm	l ₁₈ mm	kg
Modular NCT adaptor 	AK520.N50.T09.050	NCT50	T09	12	50	14	10	0,4
	AK520.N50.T09.075	NCT50	T09	12	75	31	10	0,4
	AK520.N50.T09.100	NCT50	T09	12	100	31	10	0,5
	AK520.N50.T14.055	NCT50	T14	16	55	20	10	0,4
	AK520.N50.T14.085	NCT50	T14	16	85	24	10	0,5
	AK520.N50.T14.120	NCT50	T14	16	120	24	10	0,6
	AK520.N50.T18.060CO*	NCT50	T18	20	60	24	10	0,5
	AK520.N50.T18.095	NCT50	T18	20	95	24	10	0,6
	AK520.N50.T22.065CO*	NCT50	T22	25	65	33	10	0,5
	AK520.N50.T22.115	NCT50	T22	25	115	38	10	0,3
	AK520.N63.T18.060CO*	NCT63	T18	20	60	22	10	0,7
	AK520.N63.T18.095	NCT63	T18	20	95	24	10	0,8
	AK520.N63.T18.145	NCT63	T18	20	145	24	10	1,0
	AK520.N63.T22.065CO*	NCT63	T22	25	65	30	10	0,7
	AK520.N63.T22.115	NCT63	T22	25	115	38	10	1,0
	AK520.N63.T22.165	NCT63	T22	25	165	38	10	1,3
	AK520.N63.T22.215	NCT63	T22	25	215	38	10	1,8
	AK520.N63.T22.265	NCT63	T22	25	265	38	10	2,3
	AK520.N63.T28.085CO*	NCT63	T28	32	85	48	10	0,9
	AK520.N63.T28.150	NCT63	T28	32	150	48	10	1,5
	AK520.N63.T36.070CO	NCT63	T36	40	70	48	10	0,8
	AK520.N63.T36.095	NCT63	T36	40	95	48	10	0,9
	AK520.N63.T36.120	NCT63	T36	40	120	48	10	1,1
	AK520.N63.T45.080CO	NCT63	T45	50	80	57	10	0,9
	AK520.N63.T45.130	NCT63	T45	50	130	57	10	1,1
	AK520.N63.T45.180	NCT80	T45	50	180	57	10	1,6
	AK520.N80.T28.220	NCT63	T28	32	220	47	10	2,8
	AK520.N80.T36.070CO	NCT80	T36	40	70	48	10	1,0
	AK520.N80.T36.095	NCT80	T36	40	95	48	10	1,1
	AK520.N80.T36.120	NCT80	T36	40	120	48	10	1,3
	AK520.N80.T45.080CO	NCT80	T45	50	80	57	10	1,1
	AK520.N80.T45.130	NCT80	T45	50	130	57	10	1,3
	AK520.N80.T45.180	NCT80	T45	50	180	57	10	1,7

* ... CO = interface provides cutting edge orientation. For using B 4030.T and B 3230.T.

Reduction adaptor AK 521/AK 522



- For NCT ScrewFit front pieces

Tool	Designation	d ₁ mm	d ₁₁ mm	d ₁₂ mm	l ₄ mm	kg
NCT ScrewFit 	AK521.T14.25.T09	T14	T9		25	0,1
	AK521.T18.30.T14	T18	T14		30	0,1
	AK521.T22.35.T18	T22	T18		35	0,1
	AK521.T28.40.T22	T28	T22		40	0,2
	AK521.T36.45.T28	T36	T28		45	0,3
	AK521.T45.50.T36	T45	T36		50	0,5
Conversion kit* 	AK522.TC06.25.T09	M6	T9	9,7	25	0,1
	AK522.TC08.30.T14	M8	T14	14,5	30	0,1
	AK522.TC10.35.T18	M10	T18	18,5	35	0,1
	AK522.TC12.40.T22	M12	T22	22	40	0,1
	AK522.TC16.40.T28	M16	T28	28	40	0,2

* For converting cylindrical interface to Walter interface.

Adaptor DIN 69893/1 A

AK 530

HSK63

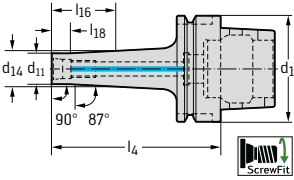

- For NCT ScrewFit front pieces

Tool	Designation	d ₁ mm	d ₁₁ mm	d ₁₄ mm	l ₄ mm	l ₁₆ mm	l ₁₈ mm	kg
	AK530.H63A.T09.045	HSK-A63	T09	12	45	14	10	0,7
	AK530.H63A.T09.070	HSK-A63	T09	12	70	31	10	0,7
	AK530.H63A.T09.095	HSK-A63	T09	12	95	31	10	0,8
	AK530.H63A.T14.045	HSK-A63	T14	16	45	11	10	0,7
	AK530.H63A.T14.070	HSK-A63	T14	16	70	24	10	0,8
	AK530.H63A.T14.095	HSK-A63	T14	16	95	24	10	0,8
	AK530.H63A.T14.120	HSK-A63	T14	16	120	24	10	0,9
	AK530.H63A.T18.050CO*	HSK-A63	T18	20	50	16	10	0,7
	AK530.H63A.T18.075	HSK-A63	T18	20	75	24	10	0,8
	AK530.H63A.T18.100	HSK-A63	T18	20	100	24	10	0,9
	AK530.H63A.T18.125	HSK-A63	T18	20	125	24	10	0,5
	AK530.H63A.T18.150	HSK-A63	T18	20	150	24	10	1,1
	AK530.H63A.T22.060CO*	HSK-A63	T22	25	60	26	10	0,8
	AK530.H63A.T22.085	HSK-A63	T22	25	85	38	10	0,9
	AK530.H63A.T22.110	HSK-A63	T22	25	110	38	10	1,0
	AK530.H63A.T22.135	HSK-A63	T22	25	135	38	10	1,1
	AK530.H63A.T22.160	HSK-A63	T22	25	160	38	10	1,3
	AK530.H63A.T28.065CO*	HSK-A63	T28	32	65	31	10	0,8
	AK530.H63A.T28.090	HSK-A63	T28	32	90	48	10	1,0
	AK530.H63A.T28.115	HSK-A63	T28	32	115	48	10	1,2
	AK530.H63A.T28.140	HSK-A63	T28	32	140	48	10	1,4
	AK530.H63A.T28.165	HSK-A63	T28	32	165	48	10	1,7
	AK530.H63A.T36.065CO*	HSK-A63	T36	40	65	34	10	0,9
	AK530.H63A.T36.090	HSK-A63	T36	40	90	48	10	1,2
	AK530.H63A.T36.115	HSK-A63	T36	40	115	48	10	1,4
	AK530.H63A.T45.065CO*	HSK-A63	T45	50	65	36	10	1,1
	AK530.H63A.T45.090	HSK-A63	T45	50	90	57	10	1,4

Balance class G 6.3 where n = 25,000 rpm

For HSK accessories, see page H 42.

* ... CO = interface is cutting edge oriented. For using B 4030.T and B 3230.T.

Adaptor DIN 69893/1 A

AK 530

HSK100



- For NCT ScrewFit front pieces

Tool	Designation	d ₁ mm	d ₁₁ mm	d ₁₄ mm	l ₄ mm	l ₁₆ mm	l ₁₈ mm	kg
	AK530.H100A.T22.055CO*	HSK-A100	T22	25	55	21	10	2,1
	AK530.H100A.T22.100	HSK-A100	T22	25	100	38	10	2,3
	AK530.H100A.T22.150	HSK-A100	T22	25	150	38	10	2,6
	AK530.H100A.T22.200	HSK-A100	T22	25	200	38	10	3,0
	AK530.H100A.T28.060CO*	HSK-A100	T28	32	60	26	10	2,2
	AK530.H100A.T28.110	HSK-A100	T28	32	110	48	10	2,5
	AK530.H100A.T28.160	HSK-A100	T28	32	160	48	10	3,0
	AK530.H100A.T28.210	HSK-A100	T28	32	210	48	10	3,5
	AK530.H100A.T28.260	HSK-A100	T28	32	260	48	10	4,2
	AK530.H100A.T36.070CO*	HSK-A100	T36	40	70	36	10	2,3
	AK530.H100A.T36.120	HSK-A100	T36	40	120	48	10	2,8
	AK530.H100A.T36.170	HSK-A100	T36	40	170	48	10	3,5
	AK530.H100A.T36.220	HSK-A100	T36	40	220	48	10	4,3
	AK530.H100A.T36.270	HSK-A100	T36	40	270	48	10	5,3
	AK530.H100A.T45.070CO*	HSK-A100	T45	50	70	36	10	2,5
	AK530.H100A.T45.120	HSK-A100	T45	50	120	57	10	3,3
	AK530.H100A.T45.170	HSK-A100	T45	50	170	57	10	4,3
	AK530.H100A.T45.220	HSK-A100	T45	50	220	57	10	5,4
	AK530.H100A.T45.270	HSK-A100	T45	50	270	57	10	6,7

Balance class G 6.3 where n = 16,000 rpm

For HSK accessories, see page H 42.

* ... CO = interface is cutting edge oriented. For using B 4030.T and B 3230.T.

Adaptor DIN 69893/1 A

AK 531

HSK63 + HSK100

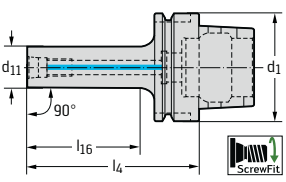

- For NCT ScrewFit front pieces
- Cutting edge oriented (CO)

Tool	Designation	d ₁ mm	d ₁₁ mm	l ₄ mm	l ₁₆ mm	kg
	AK531.H63A.T18.075CO*	HSK-A63	T18	75	41	0,8
	AK531.H63A.T22.110CO*	HSK-A63	T22	110	76	0,9
	AK531.H63A.T28.115CO*	HSK-A63	T28	115	81	1,1
	AK531.H63A.T36.115CO*	HSK-A63	T36	115	84	1,3
	AK531.H63A.T45.090CO*	HSK-A63	T45	90	62	1,3
	AK531.H100A.T22.100CO*	HSK-A100	T22	100	66	2,5
	AK531.H100A.T28.110CO*	HSK-A100	T28	110	76	2,7
	AK531.H100A.T36.120CO*	HSK-A100	T36	120	86	2,9
	AK531.H100A.T45.170CO*	HSK-A100	T45	170	136	3,2

D1 = 63 mm: Balance class G 6.3 at n = 25,000 rpm, D1 = 100 mm: Balance class G 6.3 at n = 16,000 rpm

For HSK accessories, see page H 42.

* ... CO = interface is cutting edge oriented. For using B 4030.T and B 3230.T.

Adaptor DIN 69871 AD+B

AK 540

SK40



- For NCT ScrewFit front pieces

Tool	Designation	d ₁ mm	d ₁₁ mm	d ₁₄ mm	l ₄ mm	l ₁₆ mm	l ₁₈ mm	kg
SK DIN 69871 AD+B 	AK540.S40.T09.040	SK40	T09	12	40	17	10	0,9
	AK540.S40.T09.065	SK40	T09	12	65	31	10	0,9
	AK540.S40.T09.090	SK40	T09	12	90	31	10	0,9
	AK540.S40.T14.045	SK40	T14	16	45	17	10	0,9
	AK540.S40.T14.070	SK40	T14	16	70	24	10	0,9
	AK540.S40.T14.095	SK40	T14	16	95	24	10	1,0
	AK540.S40.T14.120	SK40	T14	16	120	24	10	1,0
	AK540.S40.T18.050CO*	SK40	T18	20	50	22	10	0,9
	AK540.S40.T18.075	SK40	T18	20	75	24	10	1,0
	AK540.S40.T18.100	SK40	T18	20	100	24	10	1,0
	AK540.S40.T18.125	SK40	T18	20	125	24	10	1,2
	AK540.S40.T18.150	SK40	T18	20	150	24	10	1,3
	AK540.S40.T22.060CO*	SK40	T22	25	60	32	10	0,9
	AK540.S40.T22.085	SK40	T22	25	85	38	10	1,0
	AK540.S40.T22.110	SK40	T22	25	110	38	10	1,1
	AK540.S40.T22.135	SK40	T22	25	135	38	10	1,4
	AK540.S40.T22.160	SK40	T22	25	160	38	10	1,5
	AK540.S40.T28.040CO*	SK40	T28	32	40	17	10	0,9
	AK540.S40.T28.065	SK40	T28	32	65	37	10	1,0
	AK540.S40.T28.090	SK40	T28	32	90	48	10	1,2
	AK540.S40.T28.115	SK40	T28	32	115	48	10	1,3
	AK540.S40.T28.140	SK40	T28	32	140	48	10	1,6
	AK540.S40.T28.165	SK40	T28	32	165	48	10	1,9
	AK540.S40.T36.040CO*	SK40	T36	40	40	17	10	0,9
	AK540.S40.T36.065	SK40	T36	40	65	40	10	1,1
	AK540.S40.T36.090	SK40	T36	40	90	48	10	1,4
	AK540.S40.T36.115	SK40	T36	40	115	48	10	1,7
	AK540.S40.T45.040CO*	SK40	T45	50	40	17	10	1,0
	AK540.S40.T45.065	SK40	T45	50	65	42	10	1,3
	AK540.S40.T45.090	SK40	T45	50	90	67	10	2,0

When delivered, the form is AD. To convert to form B, remove the two threaded plugs.

Bodies and assembly parts are included in the scope of delivery.

For pull studs for steep tapers, see page H 42.

* ... CO = interface is cutting edge oriented. For using B 4030.T and B 3230.T.

Assembly parts

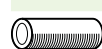
 d₁ mm

Threaded plug DIN 913

SK40

M04X005 DIN 913



G 105



H 34

Adaptor DIN 69871 AD+B

AK 540

SK50

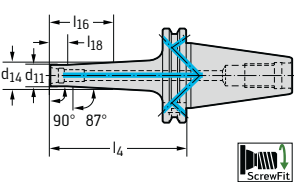

- For NCT ScrewFit front pieces

Tool	Designation	d ₁ mm	d ₁₁ mm	d ₁₄ mm	l ₄ mm	l ₁₆ mm	l ₁₈ mm	kg
SK DIN 69871 AD+B 	AK540.S50.T22.050CO*	SK50	T22	25	50	25	10	2,8
	AK540.S50.T22.100	SK50	T22	25	100	38	10	3,0
	AK540.S50.T22.150	SK50	T22	25	150	38	10	3,4
	AK540.S50.T22.200	SK50	T22	25	200	38	10	3,8
	AK540.S50.T28.050CO*	SK50	T28	32	50	25	10	2,9
	AK540.S50.T28.100	SK50	T28	32	100	48	10	3,2
	AK540.S50.T28.150	SK50	T28	32	150	48	10	3,6
	AK540.S50.T28.200	SK50	T28	32	200	48	10	4,8
	AK540.S50.T28.250	SK50	T28	32	250	48	10	4,7
	AK540.S50.T36.050CO*	SK50	T36	40	50	25	10	2,9
	AK540.S50.T36.100	SK50	T36	40	100	48	10	3,4
	AK540.S50.T36.150	SK50	T36	40	150	48	10	4,1
	AK540.S50.T36.200	SK50	T36	40	200	48	10	4,9
	AK540.S50.T36.250	SK50	T36	40	250	48	10	5,7
	AK540.S50.T45.050CO*	SK50	T45	50	50	25	10	3,0
	AK540.S50.T45.100	SK50	T45	50	100	57	10	3,8
	AK540.S50.T45.150	SK50	T45	50	150	57	10	4,7
	AK540.S50.T45.200	SK50	T45	50	200	57	10	5,8
	AK540.S50.T45.250	SK50	T45	50	250	57	10	7,0

When delivered, the form is AD. To convert to form B, remove the two threaded plugs.

Bodies and assembly parts are included in the scope of delivery.

For pull studs for steep tapers, see page H 42.

* ... CO = interface is cutting edge oriented. For using B 4030.T and B 3230.T.

Assembly parts

	d ₁ mm	SK50
	Threaded plug DIN 913	M06X006 DIN 913

Adaptor DIN 69871 AD+B

AK 541

SK40 + SK50



- For NCT ScrewFit front pieces
- Cutting edge oriented (CO)

Tool	Designation	d ₁ mm	d ₁₁ mm	l ₄ mm	l ₁₆ mm	kg
	SK DIN 69871 AD+B					
	AK541.S40.T18.075CO*	SK40	T18	75	50	1,0
	AK541.S40.T22.110CO*	SK40	T22	110	85	1,0
	AK541.S40.T28.115CO*	SK40	T28	115	90	1,3
	AK541.S40.T36.115CO*	SK40	T36	115	92	1,4
	AK541.S40.T45.090CO*	SK40	T45	90	67	1,6
	AK541.S50.T22.100CO*	SK50	T22	100	75	2,7
	AK541.S50.T28.100CO*	SK50	T28	100	75	2,9
	AK541.S50.T36.150CO*	SK50	T36	150	125	3,4
	AK541.S50.T45.200CO*	SK50	T45	200	175	4,6

When delivered, the form is AD. To convert to form B, remove the two threaded plugs.

Bodies and assembly parts are included in the scope of delivery.

For pull studs for steep tapers, see page H 42.

Balance class G 6.3 where n = 25,000 rpm

* ... CO = interface is cutting edge oriented. For using B 4030.T and B 3230.T.

Assembly parts	d ₁ mm	SK40	SK50
	DIN 913 threaded plug	M04X005 DIN 913	M06X006 DIN 913 6 X 6

Adaptor MAS-BT JIS B 6339

AK 540

SK40

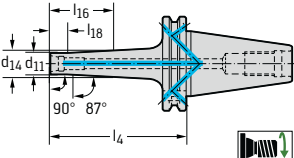

- For NCT ScrewFit front pieces

Tool	Designation	d ₁ mm	d ₁₁ mm	d ₁₄ mm	l ₄ mm	l ₁₆ mm	l ₁₈ mm	kg
	JIS B 6339							
	AK540.BT40.T09.050	SK40	T09	12	50	17	10	1,1
	AK540.BT40.T09.075	SK40	T09	12	75	31	10	1,1
	AK540.BT40.T09.100	SK40	T09	12	100	31	10	1,1
	AK540.BT40.T14.055	SK40	T14	16	55	22	10	1,1
	AK540.BT40.T14.080	SK40	T14	16	80	24	10	1,1
	AK540.BT40.T14.105	SK40	T14	16	105	24	10	1,2
	AK540.BT40.T14.130	SK40	T14	16	130	24	10	1,3
	AK540.BT40.T18.060CO*	SK40	T18	20	60	24	10	1,1
	AK540.BT40.T18.085	SK40	T18	20	85	24	10	1,1
	AK540.BT40.T18.110	SK40	T18	20	110	24	10	1,3
	AK540.BT40.T18.135	SK40	T18	20	135	24	10	1,4
	AK540.BT40.T18.160	SK40	T18	20	160	24	10	1,6
	AK540.BT40.T22.070CO*	SK40	T22	25	70	37	10	1,0
	AK540.BT40.T22.095	SK40	T22	25	95	38	10	1,3
	AK540.BT40.T22.120	SK40	T22	25	120	38	10	1,6
	AK540.BT40.T22.145	SK40	T22	25	145	38	10	1,6
	AK540.BT40.T22.170	SK40	T22	25	170	38	10	1,8
	AK540.BT40.T28.050CO*	SK40	T28	32	50	17	10	1,1
	AK540.BT40.T28.075	SK40	T28	32	75	42	10	1,2
	AK540.BT40.T28.100	SK40	T28	32	100	48	10	1,4
	AK540.BT40.T28.125	SK40	T28	32	125	48	10	1,6
	AK540.BT40.T28.150	SK40	T28	32	150	48	10	1,9
	AK540.BT40.T28.175	SK40	T28	32	175	48	10	2,1
	AK540.BT40.T36.075CO*	SK40	T36	40	75	42	10	1,3
	AK540.BT40.T36.100	SK40	T36	40	100	48	10	1,6
	AK540.BT40.T36.125	SK40	T36	40	125	48	10	1,9
	AK540.BT40.T45.075CO*	SK40	T45	50	75	42	10	1,6
	AK540.BT40.T45.100	SK40	T45	50	100	57	10	1,9

For pull studs for steep tapers, see page H 42.

* ... CO = interface is cutting edge oriented. For using B 4030.T and B 3230.T.

Adaptor MAS-BT JIS B 6339

AK 540

SK50



- For NCT ScrewFit front pieces

Tool	Designation	d ₁ mm	d ₁₁ mm	d ₁₄ mm	l ₄ mm	l ₁₆ mm	l ₁₈ mm	kg
JIS B 6339 	AK540.BT50.T22.070CO*	SK50	T22	25	70	26	10	3,9
	AK540.BT50.T22.120	SK50	T22	25	120	38	10	4,0
	AK540.BT50.T22.170	SK50	T22	25	170	38	10	4,4
	AK540.BT50.T22.220	SK50	T22	25	220	38	10	4,9
	AK540.BT50.T28.070CO*	SK50	T28	32	70	26	10	3,9
	AK540.BT50.T28.120	SK50	T28	32	120	48	10	4,2
	AK540.BT50.T28.170	SK50	T28	32	170	48	10	4,7
	AK540.BT50.T28.220	SK50	T28	32	220	48	10	5,2
	AK540.BT50.T28.270	SK50	T28	32	270	48	10	5,7
	AK540.BT50.T36.070CO*	SK50	T36	40	70	26	10	3,9
	AK540.BT50.T36.120	SK50	T36	40	120	48	10	4,4
	AK540.BT50.T36.170	SK50	T36	40	170	48	10	5,1
	AK540.BT50.T36.220	SK50	T36	40	220	48	10	5,9
	AK540.BT50.T36.270	SK50	T36	40	270	48	10	6,9
	AK540.BT50.T45.070CO*	SK50	T45	50	70	26	10	4,1
	AK540.BT50.T45.120	SK50	T45	50	120	57	10	4,8
	AK540.BT50.T45.170	SK50	T45	50	170	57	10	5,7
	AK540.BT50.T45.220	SK50	T45	50	220	57	10	6,6
	AK540.BT50.T45.270	SK50	T45	50	270	57	10	8,0

For pull studs for steep tapers, see page H 42.

* ... CO = interface is cutting edge oriented. For using B 4030.T and B 3230.T.

Adaptor MAS-BT JIS B 6339

AK 541

SK40 + SK50

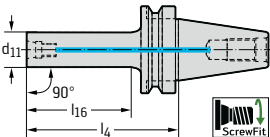

- For NCT ScrewFit front pieces
- Cutting edge oriented (CO)

Tool	Designation	d ₁ mm	d ₁₁ mm	l ₄ mm	l ₁₆ mm	kg
JIS B 6339 	AK541.BT40.T18.085CO*	SK40	T18	85	53	1.1
	AK541.BT40.T22.120CO*	SK40	T22	120	88	1.2
	AK541.BT40.T28.125CO*	SK40	T28	125	93	1.4
	AK541.BT40.T36.125CO*	SK40	T36	125	93	1.6
	AK541.BT40.T45.100CO*	SK40	T45	100	68	1.8
	AK541.BT50.T22.120CO*	SK50	T22	120	77	3.9
	AK541.BT50.T28.120CO*	SK50	T28	120	77	4.0
	AK541.BT50.T36.170CO*	SK50	T36	170	127	4.5
	AK541.BT50.T45.220CO*	SK50	T45	220	177	5.7

Balance class G 6.3 where n = 25,000 rpm

For pull studs for steep tapers, see page H 42.

* ... CO = interface is cutting edge oriented. For using B 4030.T and B 3230.T.

Walter Capto adaptor ISO 26623

AK 580.C

C3 - C6

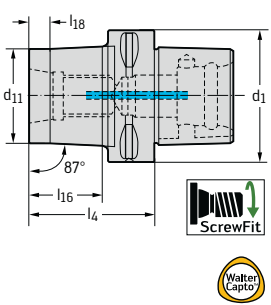

- For NCT ScrewFit front pieces

Tool	Designation	d ₁ mm	d ₁₁ mm	l ₄ mm	l ₁₆ mm	l ₁₈ mm	kg
Walter Capto ISO 26623 	AK580.C3.T09.30	C3	T9	30	12,2	10	0,1
	AK580.C3.T14.45	C3	T14	45	27,2	10	0,2
	AK580.C3.T18.45	C3	T18	45	27,2	10	0,2
	AK580.C3.T22.45	C3	T22	45	27,2	10	0,2
	AK580.C3.T28.55	C3	T28	55	40	10	0,3
	AK580.C4.T09.30	C4	T9	30	-	7	0,3
	AK580.C4.T14.45	C4	T14	45	22,2	10	0,3
	AK580.C4.T18.45	C4	T18	45	22,2	10	0,3
	AK580.C4.T22.45	C4	T22	45	22,2	10	0,3
	AK580.C4.T28.55	C4	T28	55	32,2	10	0,4
	AK580.C4.T36.55	C4	T36	55	35	10	0,5
	AK580.C4.T45.55	C4	T45	55	35	10	0,6
	AK580.C5.T09.35	C5	T9	35	12,2	10	0,5
	AK580.C5.T14.45	C5	T14	45	22,2	10	0,3
	AK580.C5.T18.45	C5	T18	45	22,2	10	0,5
	AK580.C5.T22.45	C5	T22	45	22,2	10	0,5
	AK580.C5.T28.55	C5	T28	55	32,2	10	0,6
	AK580.C5.T36.55	C5	T36	55	32,2	10	0,7
	AK580.C5.T45.55	C5	T45	55	35	10	0,8
	AK580.C6.T14.50	C6	T14	50	25,2	10	0,8
	AK580.C6.T18.50	C6	T18	50	25,2	10	0,9
	AK580.C6.T22.50	C6	T22	50	25,2	10	0,9
	AK580.C6.T28.60	C6	T28	60	35,2	10	1,0
	AK580.C6.T36.60	C6	T36	60	35,2	10	1,0
	AK580.C6.T45.60	C6	T45	60	35,2	10	1,2

For tightening torques for screw fit front pieces, see page F 309.

Adaptor DIN 6335 HA AK610

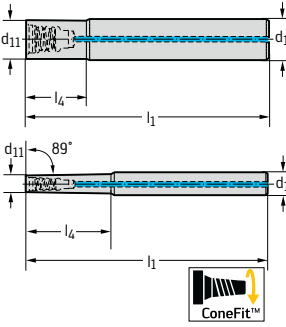

- For ConeFit™ mill heads

	Designation	d ₁ mm	d ₁₁ mm	l ₄ mm	l ₁ mm	
Shank DIN 6335 HA With coolant supply	AK610.Z10.E10.020	10	E10	20	75	0,1
	AK610.Z12.E12.022	12	E12	22	100	0,1
	AK610.Z16.E10.005	16	E10	5	65	0,1
	AK610.Z16.E10.036	16	E10	36	140	0,2
	AK610.Z16.E10.050	16	E10	50	160	0,2
	AK610.Z16.E12.005	16	E12	5	65	0,1
	AK610.Z16.E12.025	16	E12	25	140	0,2
	AK610.Z16.E12.060	16	E12	60	170	0,2
	AK610.Z20.E16.005	20	E16	5	70	0,2
	AK610.Z20.E16.025	20	E16	25	110	0,2
	AK610.Z20.E16.075	20	E16	75	190	0,4
	AK610.Z20.E20.030	20	E20	30	120	0,3
	AK610.Z25.E16.054	25	E16	54	170	0,6
	AK610.Z25.E20.005	25	E20	5	80	0,3
	AK610.Z25.E25.040	25	E25	40	140	0,5
	AK610.Z32.E20.073	32	E20	73	180	1,0
	AK610.Z32.E25.005	32	E25	5	80	0,5
	AK610.Z32.E25.045	32	E25	45	200	1,2

Adaptors DIN 6335 HA AK610

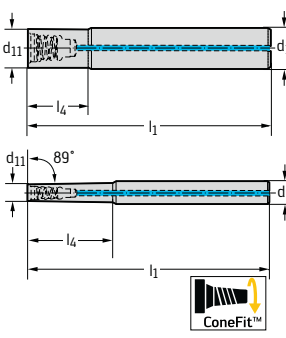

- For ConeFit™ mill heads
- With solid carbide shank

	Designation	d ₁ mm	d ₁₁ mm	l ₄ mm	l ₁ mm	 kg
Shank DIN 6335 HA With coolant supply	AK610.Z10.E10.050C	10	E10	50	100	0,1
	AK610.Z12.E12.048C	12	E12	48	100	0,1
	AK610.Z16.E10.100C	16	E10	100	155	0,3
	AK610.Z16.E12.090C	16	E12	90	150	0,3
	AK610.Z16.E16.080C	16	E16	80	135	0,3
	AK610.Z20.E16.118C	20	E16	118	175	0,6
	AK610.Z20.E20.038C	20	E20	38	95	0,3
	AK610.Z25.E25.120C	25	E25	120	200	1,2

Adaptor DIN 69893/1 A
AK631
HSK63



- For ConeFit™ mill heads

	Designation	d ₁ mm	d ₁₁ mm	l ₄ mm	l ₁₆ mm	kg
HSK DIN 69893/1 A With coolant supply 	AK631.H63A.E10.049	HSK-A63	E10	49	13,5	0,7
	AK631.H63A.E12.051	HSK-A63	E12	51	15,8	0,7
	AK631.H63A.E16.056	HSK-A63	E16	56	21,3	0,8
	AK631.H63A.E20.053	HSK-A63	E20	53	18,8	0,8
	AK631.H63A.E25.059	HSK-A63	E25	59	25,5	0,8

For HSK accessories, see page H 42.

Adaptor DIN 69871
AK641
SK40



- For ConeFit™ mill heads

	Designation	d ₁ mm	d ₁₁ mm	l ₁₆ mm	l ₄ mm	kg
SK DIN 69871 With coolant supply 	AK641.S40.E10.041	SK40	E10	12,7	41	0,9
	AK641.S40.E12.044	SK40	E12	16	44	0,9
	AK641.S40.E16.049	SK40	E16	21,5	49	0,9
	AK641.S40.E20.046	SK40	E20	19	46	0,9
	AK641.S40.E25.051	SK40	E25	24,6	51	1,0

For pull studs for steep tapers, see page H 42.

**Adaptor MAS-BT JIS B 6339
AK641
SK40**



- For ConeFit™ mill heads

	Designation	d ₁ mm	d ₁₁ mm	l ₁₆ mm	l ₄ mm	kg
JIS B 6339 	AK641.BT40.E10.051	SK40	E10	13	51	1,1
	AK641.BT40.E12.054	SK40	E12	16,3	54	1,1
	AK641.BT40.E16.060	SK40	E16	22,8	60	1,1
	AK641.BT40.E20.056	SK40	E20	19,3	56	1,1
	AK641.BT40.E25.062	SK40	E25	26	62	1,3

For pull studs for steep tapers, see page H 42.

Walter Capto adaptors ISO 26623

AK681

C5 + C6



- For ConeFit™ mill heads

	Designation	d ₁ mm	d ₁₁ mm	l ₄ mm	l ₁₆ mm	kg
Walter Capto ISO 23623 	AK681.C5.E10.042	C5	E10	42	12,8	0,5
	AK681.C5.E12.045	C5	E12	45	16	0,5
	AK681.C5.E16.050	C5	E16	50	21,5	0,5
	AK681.C5.E20.047	C5	E20	47	19	0,5
	AK681.C5.E25.052	C5	E25	52	24,7	0,6
	AK681.C6.E12.049	C6	E12	49	16,3	0,9
	AK681.C6.E16.054	C6	E16	54	21,8	0,9
	AK681.C6.E20.051	C6	E20	51	19,3	0,9
	AK681.C6.E25.056	C6	E25	56	25	0,9

Master DIN 69893/1 Form A

A 100 M ... HSK

HSK63 + HSK100



- Modular NCT adaptor

Tool	Designation	d ₁ mm	d ₁₁ mm	d ₁₄ mm	l ₄ mm	l ₁₆ mm	Version	kg
DIN 69893/1 A 	A100M.7.063.055.25.HSK	HSK-A63	NCT25	25	55	29	C	0,7
	A100M.7.063.055.32.HSK	HSK-A63	NCT32	32	55	29	C	0,8
	A100M.7.063.065.40.HSK	HSK-A63	NCT40	40	65	39	C	1,0
	A100M.7.063.065.50.HSK	HSK-A63	NCT50	50	65	39	A	1,2
	A100M.7.063.075.63.HSK	HSK-A63	NCT63	63	75	49	B	1,7
	A100M.7.063.080.25.HSK	HSK-A63	NCT25	25	80	54	C	0,9
	A100M.7.063.080.32.HSK	HSK-A63	NCT32	32	80	54	C	1,0
	A100M.7.063.080.40.HSK	HSK-A63	NCT40	40	80	54	C	1,1
	A100M.7.063.080.50.HSK	HSK-A63	NCT50	50	80	54	A	1,5
	A100M.7.063.080.80.HSK	HSK-A63	NCT80	80	80	54	B	2,2
	A100M.7.063.100.63.HSK	HSK-A63	NCT63	63	100	74	B	2,2
	A100M.7.100.060.25.HSK	HSK-A100	NCT25	25	60	31	C	2,2
	A100M.7.100.060.32.HSK	HSK-A100	NCT32	32	60	31	C	2,3
	A100M.7.100.080.25.HSK	HSK-A100	NCT25	25	80	51	C	2,3
	A100M.7.100.080.32.HSK	HSK-A100	NCT32	32	80	51	C	2,4
	A100M.7.100.080.40.HSK	HSK-A100	NCT40	40	80	51	C	2,6
	A100M.7.100.080.50.HSK	HSK-A100	NCT50	50	80	51	A	2,8
	A100M.7.100.080.63.HSK	HSK-A100	NCT63	63	80	51	B	3,2
	A100M.7.100.100.63.HSK	HSK-A100	NCT63	63	100	71	B	3,7
	A100M.7.100.100.80.HSK	HSK-A100	NCT80	80	100	71	B	4,5

Bodies and assembly parts are included in the scope of delivery.

For HSK accessories, see page H 42.

Only use the transfer units FS1064 (HSK 63) and FS1065 (HSK 100).

Assembly parts	d ₁₁ mm	NCT25	NCT32	NCT40-NCT50	NCT63	NCT80
Drive dog				FS554	FS555	FS558
Cap screw		FS414	FS414	FS415	FS416	FS417
Threaded ring		FS410	FS410	FS411	FS412	FS413
Threaded plug ISO 4027		M04X006	M04X008	M05X010	M06X012	M06X016

Accessories	d ₁₁ mm	NCT25-NCT32	NCT40-NCT50	NCT63	NCT80
Pipe wrench for threaded ring		FS738	FS739	FS740	FS741



Face mill adaptor DIN 69893/1 A

A 155 ... HSK

HSK63 + HSK100



- For tools in acc. with DIN 1880

Tool	Designation	d ₁ mm	d ₁₁ mm	d ₁₂ mm	l ₄ mm	l ₁₉ mm	kg	
	DIN 69893/1 A	A155.7.063.050.22.HSK	HSK-A63	22	48	50	19	1,1
	A155.7.063.100.22.HSK	HSK-A63	22	48	100	19	0,2	
	A155.7.063.060.27.HSK	HSK-A63	27	60	60	21	1,5	
	A155.7.063.100.27.HSK	HSK-A63	27	60	100	21	2,4	
	A155.7.063.100.32.HSK	HSK-A63	32	78	100	24	3,3	
	A155.7.063.060.32.HSK	HSK-A63	32	78	60	24	1,8	
	A155.7.063.060.40.HSK*	HSK-A63	40	89	60	27	2,2	
	A155.7.100.100.22.HSK	HSK-A100	22	100	100	19	3,2	
	A155.7.100.050.22.HSK	HSK-A100	22	48	50	19	2,5	
	A155.7.100.050.27.HSK	HSK-A100	27	60	50	21	2,7	
	A155.7.100.100.27.HSK	HSK-A100	27	60	100	21	3,8	
	A155.7.100.050.32.HSK	HSK-A100	32	78	50	24	3,1	
	A155.7.100.100.32.HSK	HSK-A100	32	78	100	24	5,0	
	A155.7.100.060.40.HSK*	HSK-A100	40	89	60	27	3,8	
	A155.7.100.100.40.HSK*	HSK-A100	40	89	100	27	5,7	
	A155.7.100.075.60.HSK*	HSK-A100	60	128	75	40	6,8	
	A155.7.100.160.60.HSK*	HSK-A100	60	128	160	40	15,3	

Bodies and assembly parts are included in the scope of delivery.

For HSK accessories, see page H 42.

* With 4 additional threaded holes for tools with DIN 2079 adaption

Assembly parts		d ₁₁ mm	22	27	32	40	60
	Cutter locking bolt DIN 6367		FS431	FS432	FS433	FS434	FS912

Accessories		d ₁₁ mm	22	27	32	40	60
	Wrench for milling cutter locking bolt		FS437	FS438	FS439	FS440	FS913

Face mill adaptor DIN 69893/1 A

AK 155 ... HSK

HSK63 + HSK100



- For tools in acc. with DIN 1880

Tool	Designation	d ₁ mm	d ₁₁ mm	d ₁₂ mm	l ₄ mm	l ₁₉ mm	kg
	AK155.7.063.050.16.HSK	HSK-A63	16	38	50	17	0,9
	AK155.7.063.050.22.HSK	HSK-A63	22	48	50	19	1,1
	AK155.7.063.060.27.HSK	HSK-A63	27	60	60	21	1,5
	AK155.7.063.060.32.HSK	HSK-A63	32	78	60	24	1,8
	AK155.7.063.060.40.HSK*	HSK-A63	40	89	60	27	2,1
	AK155.7.100.050.22.HSK	HSK-A100	22	48	50	19	2,5
	AK155.7.100.050.27.HSK	HSK-A100	27	60	50	21	3,5
	AK155.7.100.050.32.HSK	HSK-A100	32	78	50	24	3,5
	AK155.7.100.060.40.HSK*	HSK-A100	40	89	60	27	3,7

Bodies and assembly parts are included in the scope of delivery.

For HSK accessories, see page H 42.

* With 4 additional threaded holes for tools with DIN 2079 adaption

Assembly parts	d ₁₁ mm	16	22	27	32	40
	Locking bolt ISO 4762	FS938 (SW 6)	FS939 (SW 8)	FS940 (SW 10)	FS941 (SW 14)	FS942 (SW 17)

Accessories	d ₁₁ mm	16	22	27	32	40
	Allen key ISO 2936	ISO 2936-6 (SW 6)	ISO 2936-8 (SW 8)	ISO 2936-10 (SW 10)	ISO 2936-14 (SW 14)	ISO 2936-17 (SW 17)

Weldon adaptor DIN 69893/1 A

A 170 ... HSK

HSK63 + HSK100



- For tools with shank in acc. with DIN 1835 Form B

Tool	Designation	d ₁ mm	d ₁₁ mm	d ₁₂ mm	l ₄ mm	l ₁₆ mm	kg
HSK DIN 69893/1 A 	A170.7.063.065.06.HSK	HSK-A63	6	25	65	39	0,8
	A170.7.063.065.08.HSK	HSK-A63	8	28	65	39	0,8
	A170.7.063.065.10.HSK	HSK-A63	10	35	65	39	0,9
	A170.7.063.080.12.HSK	HSK-A63	12	42	80	54	1,2
	A170.7.063.080.14.HSK	HSK-A63	14	44	80	54	1,2
	A170.7.063.080.16.HSK	HSK-A63	16	48	80	54	1,3
	A170.7.063.080.18.HSK	HSK-A63	18	50	80	54	1,6
	A170.7.063.080.20.HSK	HSK-A63	20	52	80	54	1,4
	A170.7.063.110.25.HSK	HSK-A63	25	65	110	84	2,4
	A170.7.063.110.32.HSK	HSK-A63	32	72	110	84	2,6
	A170.7.100.080.06.HSK	HSK-A100	6	25	80	51	2,3
	A170.7.100.080.08.HSK	HSK-A100	8	28	80	51	2,3
	A170.7.100.080.10.HSK	HSK-A100	10	35	80	51	2,5
	A170.7.100.080.12.HSK	HSK-A100	12	42	80	51	2,6
	A170.7.100.080.14.HSK	HSK-A100	14	44	80	51	2,6
	A170.7.100.100.16.HSK	HSK-A100	16	48	100	71	3,0
	A170.7.100.100.18.HSK	HSK-A100	18	50	100	71	3,0
	A170.7.100.100.20.HSK	HSK-A100	20	52	100	71	3,1
	A170.7.100.100.25.HSK	HSK-A100	25	65	100	71	3,6
	A170.7.100.100.32.HSK	HSK-A100	32	72	100	71	3,8
	A170.7.100.105.40.HSK	HSK-A100	40	80	105	76	4,2

Bodies and assembly parts are included in the scope of delivery.
For HSK accessories, see page H 42.

Assembly parts	d ₁₁ mm	6	8	10	12-14	16-18	20	25	32-40
Clamping screw DIN 1835-B		M06X010	M08X010	M10X012	M12X016	M14X016	M16X016	M18X2X020	M20X2X020

Whistle-notch adaptor A 171 ... HSK HSK63 + HSK100



- For tools with shank in acc. with DIN 1835 Form E

Tool	Designation	d ₁ mm	d ₁₁ mm	d ₁₂ mm	l ₄ mm	l ₁₆ mm	kg	
	HSK DIN 69893/1 A	A171.7.063.080.06.HSK	HSK-A63	6	25	80	54	0,9
	A171.7.063.080.08.HSK	HSK-A63	8	28	80	54	0,9	
	A171.7.063.080.10.HSK	HSK-A63	10	35	80	54	1,0	
	A171.7.063.090.12.HSK	HSK-A63	12	42	90	64	1,3	
	A171.7.063.090.14.HSK	HSK-A63	14	44	90	64	1,3	
	A171.7.063.100.16.HSK	HSK-A63	16	48	100	74	1,6	
	A171.7.063.100.18.HSK	HSK-A63	18	50	100	74	1,7	
	A171.7.063.100.20.HSK	HSK-A63	20	52	100	74	1,7	
	A171.7.063.110.25.HSK	HSK-A63	25	65	110	84	2,4	
	A171.7.063.110.32.HSK	HSK-A63	32	72	110	84	2,6	
	A171.7.100.090.06.HSK	HSK-A100	6	25	90	61	2,4	
	A171.7.100.090.08.HSK	HSK-A100	8	28	90	61	2,5	
	A171.7.100.090.10.HSK	HSK-A100	10	35	90	61	2,5	
	A171.7.100.100.12.HSK	HSK-A100	12	42	100	71	2,8	
	A171.7.100.100.14.HSK	HSK-A100	14	44	100	71	2,9	
	A171.7.100.100.16.HSK	HSK-A100	16	48	100	71	3,0	
	A171.7.100.100.18.HSK	HSK-A100	18	50	100	71	3,0	
	A171.7.100.110.20.HSK	HSK-A100	20	52	110	81	3,3	
	A171.7.100.120.25.HSK	HSK-A100	25	65	120	91	4,1	
	A171.7.100.120.32.HSK	HSK-A100	32	72	120	91	4,6	

Bodies and assembly parts are included in the scope of delivery.
For HSK accessories, see page H 42.

Assembly parts		d ₁₁ mm	6	8	10	12-14	16-18	20	25	32
	Backstop screw D ₁ = 63 mm D ₁ = 100 mm		FS1066	FS1067	FS1068 FS1069	FS1070	FS1071	FS1072 FS1073	FS1074	FS1074
	Clamping screw DIN 1835-B		M06X010	M08X010	M10X012	M12X016	M14X016	M16X016	M18X2X020	M20X2X020

Shrink-fit adaptor DIN 69893/1 A

A 560

HSK63



For tools with cylindrical shank in acc. with DIN 1835

Tool	Designation	d ₁ mm	d ₁₁ mm	d ₁₂ mm	l ₄ mm	l ₁₆ mm	l ₁₇ mm	kg	
	HSK DIN 69893-1 A	A560.H63A.05.080	HSK-A63	5	10	80	45	29	0,7
	A560.H63A.06.080	HSK-A63	6	12	80	45	37	0,8	
	A560.H63A.08.080	HSK-A63	8	16	80	45	37	0,8	
	A560.H63A.10.085	HSK-A63	10	20	85	50	41	0,9	
	A560.H63A.12.090	HSK-A63	12	24	90	55	46	1,0	
	A560.H63A.16.095	HSK-A63	16	28	95	60	49	1,0	
	A560.H63A.20.100	HSK-A63	20	34	100	68	51	1,2	
	A560.H63A.25.115	HSK-A63	25	39	115	85	57	1,5	

Bodies and assembly parts are included in the scope of delivery.

Balance class G 6.3 where n = 25,000 rpm

For HSK accessories, see page H 42.

Assembly parts	d ₁₁ mm	5	6	8	10	12	16-25
	Threaded plug	FS1137	FS1138	FS1139	FS1140	FS1141	FS1142

Accessories	d ₁₁ mm	5	6	8	10	12	16-25
	Allen key ISO 2936	ISO 2936-2 (SW 2)	ISO 2936-2,5 (SW 2,5)	ISO 2936-3 (SW 3)	ISO 2936-4 (SW 4)	ISO 2936-5 (SW 5)	ISO 2936-6 (SW 6)

Hydraulic expansion chuck AK 180 ... HSK

HSK63 + HSK100



- For tools with shank in acc. with DIN 1835 Form A

Tool	Designation	d ₁ mm	d ₁₁ mm	d ₁₂ mm	l ₄ mm	d ₁₄ mm	l ₁₆ mm	l ₁₇ mm	l _{17max} mm	kg
	HSK DIN 69893/1 A									
	AK180.7.063.090.12.HSK	HSK-A63	12	50	90	32	44	37	47	1,2
	AK180.7.063.100.20.HSK	HSK-A63	20	50	100	42	58	42	52	1,4
	AK180.7.100.105.20.HSK	HSK-A100	20	63	105	42	54	42	52	3,0

Bodies and assembly parts are included in the scope of delivery.
For divergent dimensions, please contact our sales staff.
For HSK accessories, see page H 42.

Accessories	d ₄ mm	6	8	10	12	14	16
	Intermediate bushings D2 = 12 mm	FS1405	FS1406				
	Intermediate bushings D2 = 20 mm	FS1120	FS1121	FS1122	FS1123	FS1124	FS1125



ER collet chuck with internal cooling

AK 300...HSK

HSK63 + HSK100



- For ER collets in acc. with DIN 6499

Tool	Designation	d ₁ mm	d ₁₁ mm	d ₁₂ mm	l ₄ mm	Collets	kg
	AK300.7.063.105.10.HSK	HSK-A63	1-10	28	105	ER 16	1,0
	AK300.7.063.105.16.HSK	HSK-A63	1-16	42	105	ER 25	1,1
	AK300.7.063.105.20.HSK	HSK-A63	1-20	50	105	ER 32	1,2
	AK300.7.063.125.26.HSK	HSK-A63	2-36	63	125	ER 40	1,8
	AK300.7.100.105.20.HSK	HSK-A100	1-20	50	105	ER 32	2,6
	AK300.7.100.125.26.HSK	HSK-A100	2-26	63	125	ER 40	3,2

Bodies and assembly parts are included in the scope of delivery.

If the collet chuck is used with internal coolant supply, the sealing discs on page G 102 must be used.

N.B.: The clamping nut can be damaged if the chuck is used without a sealing disc.

For collets, see page G 99.

For HSK accessories, see page H 42.

Assembly parts	Collets	ER 16	ER 25	ER 32	ER 40
	Clamping nut for internal coolant supply	FS1448	FS1449	FS1360	FS1450

Accessories	Collets	ER 16	ER 25	ER 32	ER 40
	Tensioning key	FS1539	FS1544	FS1545	FS1546

Collet chuck DIN 69893/1 A
AK 300...HSK
HSK63 + HSK100



- For ER collets in acc. with DIN 6499

Tool	Designation	d ₁ mm	d ₁₁ mm	d ₁₂ mm	l ₄ mm	Collets	kg
	AK300.7.063.100.10.HSK	HSK-A63	1-10	28	100	ER 16	1,0
	AK300.7.063.100.16.HSK	HSK-A63	1-16	42	100	ER 25	1,1
	AK300.7.063.100.20.HSK	HSK-A63	1-20	50	100	ER 32	1,3
	AK300.7.063.120.26.HSK	HSK-A63	2-26	63	120	ER 40	1,8
	AK300.7.100.100.20.HSK	HSK-A100	1-20	50	100	ER 32	2,6
	AK300.7.100.120.26.HSK	HSK-A100	2-26	63	120	ER 40	3,1

Bodies and assembly parts are included in the scope of delivery.
 For collets, see page G 99.
 For HSK accessories, see page H 42.

Assembly parts	Collets	ER 16	ER 25	ER 32	ER 40
	Clamping nut	FS1537	FS1540	FS1541	FS1542

Accessories	Collets	ER 16	ER 25	ER 32	ER 40
	Tensioning key	FS1539	FS1544	FS1545	FS1546

Synchronised tapping chuck Protoflex C



- For ER collets in acc. with DIN 6499

Tool	Designation	d ₁ mm	d ₁₁ mm	d ₁₂ mm	l ₄ mm	Collets	
	HSK DIN 69893/1 A						
	S9000631-20	63	M4-M12 (#8-1/2")	34	102	ER 20	1,4
	S9000631-25	63	M8-M20 (5/16-3/4")	40	122	ER 25	2,0
	S9000631-40	63	M16-M30 (7/16-1 1/8")	63	156	ER 40	3,8

Bodies and assembly parts are included in the scope of delivery.

If the collet chuck is used with internal coolant supply, the sealing discs on page G 102 must be utilised.

N.B.: The clamping nut can be damaged if the chuck is used without a sealing disc.

For collets, see page G 101.

Assembly parts	Collets	ER 20			ER 25			ER 40		
	Clamping nut for internal coolant supply		S9300ERC-20		S9300ERC-25				FS1450	
	Tensioning key				FS1544				FS1546	

Synchronised tapping chuck Protoflex C



- For ER collets in acc. with DIN 6499

Tool	Designation	d ₁ mm	d ₁₁ mm	d ₁₂ mm	l ₄ mm	Collets	kg
	DIN 1835 B/E						
	S9018350-11	25	M2-M5 (#2-#10)	19	51	ER 11	0,5
	S9018350-20	25	M4-M12 (#8-1/2")	34	63	ER 20	0,8
	S9018350-25	25	M8-M20 (5/16"-3/4")	40	83	ER 25	1,4
	DIN 1835 B/E						
	S9018351-20	25	M4-M12 (#8-1/2")	34	63	ER 20	0,8
	S9018351-25	25	M8-M20 (5/16"-3/4")	40	83	ER 25	1,4

Bodies and assembly parts are included in the scope of delivery.
 If the collet chuck is used with internal coolant supply, the sealing discs on page G 102 must be utilised.
 N.B.: The clamping nut can be damaged if the chuck is used without a sealing disc.
 For collets, see page G 101.

Assembly parts	Collets	ER 11	ER 20	ER 25
	Clamping nut	S93000ER-11	S93000ER-20	S93000ER-25
	Clamping nut for internal coolant supply		S9300ERC-20	S9300ERC-25
	Tensioning key			FS1544

Quick change collet A 331



- With overload clutch

Tool	Designation	d ₁ mm	d ₁₁ mm	d ₁₂ mm	l ₄ mm	l ₁₇ mm	SW	Collet size	kg
	A331.0.19.025.03	19	3,5	32	25	21	2,7	1	0,2
	A331.0.19.025.04	19	4,5	32	25	23	3,4	1	0,2
	A331.0.19.025.05	19	5,5	32	25	24	4,3	1	0,2
	A331.0.19.025.06	19	6	32	25	25	4,9	1	0,2
	A331.0.19.025.07	19	7	32	25	25	5,5	1	0,2
	A331.0.19.025.08	19	8	32	25	26	6,2	1	0,2
	A331.0.19.025.09	19	9	32	25	27	7	1	0,2
	A331.0.19.025.10	19	10	32	25	28	8	1	0,2
	A331.0.31.034.06	31	6	50	34	38	4,9	3	0,5
	A331.0.31.034.07	31	7	50	34	38	5,5	3	0,6
	A331.0.31.034.08	31	8	50	34	39	6,2	3	0,6
	A331.0.31.034.09	31	9	50	34	40	7	3	0,6
	A331.0.31.034.10	31	10	50	34	41	8	3	0,5
	A331.0.31.034.11	31	11	50	34	42	9	3	0,5
	A331.0.31.034.12	31	12	50	34	42	9	3	0,5
	A331.0.31.034.14	31	14	50	34	44	11	3	0,5
	A331.0.31.034.16	31	16	50	34	45	12	3	0,5
	A331.0.48.045.11	48	11	72	45	56	9	4	1,6
	A331.0.48.045.12	48	12	72	45	56	9	4	1,6
	A331.0.48.045.14	48	14	72	45	58	11	4	1,6
	A331.0.48.045.16	48	16	72	45	59	12	4	1,6
	A331.0.48.045.18	48	18	72	45	61	14,5	4	1,6
	A331.0.48.045.20	48	20	72	45	63	16	4	1,6
	A331.0.48.045.22	48	22	72	45	65	18	4	1,5
	A331.0.48.045.25	48	25	72	45	67	20	4	1,5
	A331.0.60.068.18	60	18	95	68	88	14,5	5	4,0
	A331.0.60.068.20	60	20	95	68	90	16	5	4,0
	A331.0.60.068.22	60	22	95	68	92	18	5	3,9
	A331.0.60.068.25	60	25	95	68	94	20	5	3,9
	A331.0.60.068.28	60	28	95	68	96	22	5	3,9
	A331.0.60.068.32	60	32	95	68	98	24	5	3,7
	A331.0.60.068.36	60	36	95	68	103	29	5	4,0

A collet is required for each tap shank diameter (order in acc. with D2).

For tightening torques for setting the correct torque of the overload clutch, see page G 117.

Delivery status: Torque is set according to the metric thread chart on page G 117.

ER collets C 330



- In acc. with DIN 6499

Tool	Designation	Collets	d ₁₁ mm	l ₁ mm	kg
DIN 6499 	C330.06.010	ER 11	1,0-0,5	18	0,02
	C330.06.020	ER 11	2,0-1,5	18	0,01
	C330.06.030	ER 11	3,0-2,5	18	0,02
	C330.06.040	ER 11	4,0-3,5	18	0,01
	C330.06.050	ER 11	5,0-4,5	18	0,01
	C330.06.060	ER 11	5,5-6,0	18	0,01
	C330.10.010	ER 16	1,0-0,5	27,5	0,02
	C330.10.020	ER 16	2,0-1,0	27,5	0,01
	C330.10.030	ER 16	3,0-2,0	27,5	0,01
	C330.10.040	ER 16	4,0-3,0	27,5	0,02
	C330.10.050	ER 16	5,0-4,0	27,5	0,02
	C330.10.060	ER 16	6,0-5,0	27,5	0,02
	C330.10.070	ER 16	7,0-6,0	27,5	0,02
	C330.10.080	ER 16	8,0-7,0	27,5	0,02
	C330.10.090	ER 16	9,0-8,0	27,5	0,01
	C330.10.100	ER 16	10,0-9,0	27,5	0,01
	C330.13.010	ER 20	1,0-0,5	31,5	0,05
	C330.13.020	ER 20	2,0-1,0	31,5	0,05
	C330.13.030	ER 20	3,0-2,0	31,5	0,05
	C330.13.040	ER 20	4,0-3,0	31,5	0,05
	C330.13.050	ER 20	5,0-4,0	31,5	0,05
	C330.13.060	ER 20	6,0-5,0	31,5	0,05
	C330.13.070	ER 20	7,0-6,0	31,5	0,05
	C330.13.080	ER 20	8,0-7,0	31,5	0,04
	C330.13.090	ER 20	9,0-8,0	31,5	0,04
	C330.13.100	ER 20	10,0-9,0	31,5	0,04
	C330.13.110	ER 20	11,0-10,0	31,5	0,03
	C330.13.120	ER 20	12,0-11,0	31,5	0,03
	C330.13.130	ER 20	13,0-12,0	31,5	0,03
	C330.16.020	ER 25	2,0-1,0	34	0,08
	C330.16.030	ER 25	3,0-2,0	34	0,08
	C330.16.040	ER 25	4,0-3,0	34	0,08
	C330.16.050	ER 25	5,0-4,0	34	0,08
	C330.16.060	ER 25	6,0-5,0	34	0,08
C330.16.070	ER 25	7,0-6,0	34	0,08	
C330.16.080	ER 25	8,0-7,0	34	0,08	
C330.16.090	ER 25	9,0-8,0	34	0,07	
C330.16.100	ER 25	10,0-9,0	34	0,07	
C330.16.110	ER 25	11,0-10,0	34	0,07	
C330.16.120	ER 25	12,0-11,0	34	0,06	
C330.16.130	ER 25	13,0-12,0	34	0,06	
C330.16.140	ER 25	14,0-13,0	34	0,06	
C330.16.150	ER 25	15,0-14,0	34	0,05	
C330.16.160	ER 25	16,0-15,0	34	0,05	

Continued



ER collets C 330



Continued

- In acc. with DIN 6499

Tool	Designation	Collets	d ₁₁ mm	l ₁ mm	kg
DIN 6499 	C330.20.020	ER 32	2,0-1,0	40	0,14
	C330.20.030	ER 32	3,0-2,0	40	0,15
	C330.20.040	ER 32	4,0-3,0	40	0,16
	C330.20.050	ER 32	5,0-4,0	40	0,16
	C330.20.060	ER 32	6,0-5,0	40	0,16
	C330.20.070	ER 32	7,0-6,0	40	0,16
	C330.20.080	ER 32	8,0-7,0	40	0,16
	C330.20.090	ER 32	9,0-8,0	40	0,15
	C330.20.100	ER 32	10,0-9,0	40	0,15
	C330.20.110	ER 32	11,0-10,0	40	0,14
	C330.20.120	ER 32	12,0-11,0	40	0,14
	C330.20.130	ER 32	13,0-12,0	40	0,12
	C330.20.140	ER 32	14,0-13,0	40	0,13
	C330.20.150	ER 32	15,0-14,0	40	0,13
	C330.20.160	ER 32	16,0-15,0	40	0,12
	C330.20.170	ER 32	17,0-16,0	40	0,12
	C330.20.180	ER 32	18,0-17,0	40	0,11
	C330.20.190	ER 32	19,0-18,0	40	0,10
	C330.20.200	ER 32	20,0-19,0	40	0,10
	C330.26.030	ER 40	3,0-2,0	46	0,27
	C330.26.040	ER 40	4,0-3,0	46	0,30
	C330.26.050	ER 40	5,0-4,0	46	0,29
	C330.26.060	ER 40	6,0-5,0	46	0,29
	C330.26.070	ER 40	7,0-6,0	46	0,27
	C330.26.080	ER 40	8,0-7,0	46	0,29
	C330.26.090	ER 40	9,0-8,0	46	0,29
	C330.26.100	ER 40	10,0-9,0	46	0,29
	C330.26.110	ER 40	11,0-10,0	46	0,28
	C330.26.120	ER 40	12,0-11,0	46	0,28
	C330.26.130	ER 40	13,0-12,0	46	0,28
	C330.26.140	ER 40	14,0-13,0	46	0,27
	C330.26.150	ER 40	15,0-14,0	46	0,26
	C330.26.160	ER 40	16,0-15,0	46	0,26
	C330.26.170	ER 40	17,0-16,0	46	0,26
C330.26.180	ER 40	18,0-17,0	46	0,24	
C330.26.190	ER 40	19,0-18,0	46	0,24	
C330.26.200	ER 40	20,0-19,0	46	0,24	
C330.26.210	ER 40	21,0-20,0	46	0,22	
C330.26.220	ER 40	22,0-21,0	46	0,21	
C330.26.230	ER 40	23,0-22,0	46	0,20	
C330.26.240	ER 40	24,0-23,0	46	0,19	
C330.26.250	ER 40	25,0-24,0	46	0,18	
C330.26.260	ER 40	26,0-25,0	46	0,17	

ER tap collets

C 340/ S9200011



- ER - GB in acc. with DIN 6499

Tool	Designation	Collets	d ₁₁ mm	l ₁ mm	SW	kg
DIN 6499 	S9200011-28	ER 11	2,8	18	2,1	0,01
	S9200011-35	ER 11	3,5	18	2,7	0,01
	S9200011-45	ER 11	4,5	18	3,4	0,01
	S9200011-60	ER 11	6,0	18	4,9	0,01
	C340.20.045	ER 20	4,5	31,5	3,4	0,05
	C340.20.060	ER 20	6	31,5	4,9	0,05
	C340.20.070	ER 20	7	31,5	5,5	0,05
	C340.20.080	ER 20	8	31,5	6,3	0,05
	C340.20.090	ER 20	9	31,5	7,1	0,04
	C340.20.100	ER 20	10	31,5	8	0,04
	C340.32.045	ER 32	4,5	40	3,4	0,17
	C340.32.060	ER 32	6	40	4,9	0,16
	C340.32.070	ER 32	7	40	5,5	0,17
	C340.32.080	ER 32	8	40	6,3	0,17
	C340.32.090	ER 32	9	40	7,1	0,16
	C340.32.100	ER 32	10	40	8	0,16
	C340.32.110	ER 32	11	40	9	0,16
	C340.32.120	ER 32	12	40	9	0,16
	C340.32.140	ER 32	14	40	11,2	0,15
	C340.32.160	ER 32	16	40	12	0,13
	C340.40.120	ER 40	12	46	9	0,17
	C340.40.140	ER 40	14	46	11,2	0,16
	C340.40.160	ER 40	16	46	12	0,14
	C340.40.180	ER 40	18	46	14,5	0,15
	C340.40.200	ER 40	20	46	16	0,17
	C340.40.220	ER 40	22	46	18	0,19

Sealing discs for ER collets in acc. with DIN 6499 with internal coolant supply

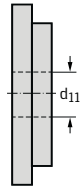

Designation	ER Size	d ₁₁ mm
FS 1238	16	3,0–2,5
FS 1239	16	3,5–3,0
FS 1240	16	4,0–3,5
FS 1241	16	4,5–4,0
FS 1242	16	5,0–4,5
FS 1243	16	5,5–5,0
FS 1244	16	6,0–5,5
FS 1245	16	6,5–6,0
FS 1246	16	7,0–6,5
FS 1247	16	7,5–7,0
FS 1248	16	8,0–7,5
FS 1249	16	8,5–8,0
FS 1250	16	9,0–8,5
FS 1251	16	9,5–9,0
FS 1252	16	10,0–9,5
FS 1408	20	3,0–2,5
FS 1409	20	3,5–3,0
FS 1410	20	4,0–3,5
FS 1411	20	4,5–4,0
FS 1412	20	5,0–4,5
FS 1413	20	5,5–5,0
FS 1361	20	6,0–5,5
FS 1414	20	6,5–6,0
FS 1362	20	7,0–6,5
FS 1415	20	7,5–7,0
FS 1363	20	8,0–7,5
FS 1416	20	8,5–8,0
FS 1364	20	9,0–8,5
FS 1417	20	9,5–9,0
FS 1365	20	10,0–9,5
FS 1418	20	10,5–10,0
FS 1419	20	11,0–10,5
FS 1420	20	11,5–11,0
FS 1421	20	12,0–11,5
FS 1422	20	12,5–12,0
FS 1423	20	13,0–12,5
FS 1253	25	3,0–2,5
FS 1254	25	3,5–3,0
FS 1255	25	4,0–3,5

Designation	ER Size	d ₁₁ mm
FS 1256	25	4,5–4,0
FS 1257	25	5,0–4,5
FS 1258	25	5,5–5,0
FS 1259	25	6,0–5,5
FS 1260	25	6,5–6,0
FS 1261	25	7,0–6,5
FS 1262	25	7,5–7,0
FS 1263	25	8,0–7,5
FS 1264	25	8,5–8,0
FS 1265	25	9,0–8,5
FS 1266	25	9,5–9,0
FS 1267	25	10,0–9,5
FS 1268	25	10,5–10,0
FS 1269	25	11,0–10,5
FS 1270	25	11,5–11,0
FS 1271	25	12,0–11,5
FS 1272	25	12,5–12,0
FS 1273	25	13,0–12,5
FS 1274	25	13,5–13,0
FS 1275	25	14,0–13,5
FS 1276	25	14,5–14,0
FS 1277	25	15,0–14,5
FS 1278	25	15,5–15,0
FS 1279	25	16,0–15,5
FS 1424	32	3,0–2,5
FS 1425	32	3,5–3,0
FS 1426	32	4,0–3,5
FS 1427	32	4,5–4,0
FS 1428	32	5,0–4,5
FS 1429	32	5,5–5,0
FS 1366	32	6,0–5,5
FS 1430	32	6,5–6,0
FS 1367	32	7,0–6,5
FS 1431	32	7,5–7,0
FS 1368	32	8,0–7,5
FS 1432	32	8,5–8,0
FS 1369	32	9,0–8,5
FS 1433	32	9,5–9,0
FS 1370	32	10,0–9,5

Sealing discs for ER collets in acc. with DIN 6499 with internal coolant supply

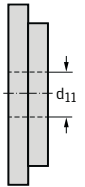





Designation	ER Size	d ₁₁ mm
FS 1434	32	10,5–10,0
FS 1371	32	11,0–10,5
FS 1435	32	11,5–11,0
FS 1372	32	12,0–11,5
FS 1436	32	12,5–12,0
FS 1373	32	13,0–12,5
FS 1437	32	13,5–13,0
FS 1374	32	14,0–13,5
FS 1438	32	14,5–14,0
FS 1375	32	15,0–14,5
FS 1439	32	15,5–15,0
FS 1376	32	16,0–15,5
FS 1440	32	16,5–16,0
FS 1441	32	17,0–16,5
FS 1442	32	17,5–17,0
FS 1443	32	18,0–17,5
FS 1444	32	18,5–18,0
FS 1445	32	19,0–18,5
FS 1446	32	19,5–19,0
FS 1447	32	20,0–19,5
FS 1280	40	3,0–2,5
FS 1281	40	3,5–3,0
FS 1282	40	4,0–3,5
FS 1283	40	4,5–4,0
FS 1284	40	5,0–4,5
FS 1285	40	5,5–5,0
FS 1286	40	6,0–5,5
FS 1287	40	6,5–6,0
FS 1288	40	7,0–6,5
FS 1289	40	7,5–7,0
FS 1290	40	8,0–7,5
FS 1291	40	8,5–8,0
FS 1292	40	9,0–8,5
FS 1293	40	9,5–9,0
FS 1294	40	10,0–9,5
FS 1295	40	10,5–10,0
FS 1296	40	11,0–10,5
FS 1297	40	11,5–11,0
FS 1298	40	12,0–11,5

Designation	ER Size	d ₁₁ mm
FS 1299	40	12,5–12,0
FS 1300	40	13,0–12,5
FS 1301	40	13,5–13,0
FS 1302	40	14,0–13,5
FS 1303	40	14,5–14,0
FS 1304	40	15,0–14,5
FS 1305	40	15,5–15,0
FS 1306	40	16,0–15,5
FS 1307	40	16,5–16,0
FS 1308	40	17,0–16,5
FS 1309	40	17,5–17,0
FS 1310	40	18,0–17,5
FS 1311	40	18,5–18,0
FS 1312	40	19,0–18,5
FS 1313	40	19,5–19,0
FS 1314	40	20,0–19,5
FS 1315	40	20,5–20,0
FS 1316	40	21,0–20,5
FS 1317	40	21,5–21,0
FS 1318	40	22,0–21,5
FS 1319	40	22,5–22,0
FS 1320	40	23,0–22,5
FS 1321	40	23,5–23,0
FS 1322	40	24,0–23,5
FS 1323	40	24,5–24,0
FS 1324	40	25,0–24,5
FS 1325	40	25,5–25,0
FS 1326	40	26,0–25,5

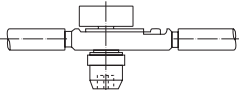
Torque setting tools for quick change collet A 331

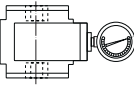

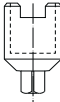
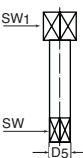
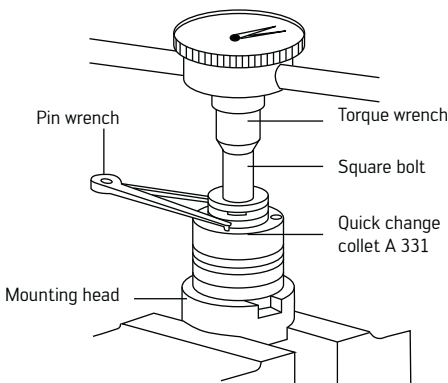
Setting tools

	Setting tool	Designation	for Collet size	Thread	Torque NM			
	Torque wrench	FS 518	1	M 3–M 12	30			
		FS 519	3	M 8–M 20	120			
		FS 791	4	M 14–M 33	300			
	Ratchet	FS 792	5	M 22–M 48				
	Torque setting device	FS 793	5	M 22–M 48	1000			
	Pin wrench	FS 524	1					
		FS 526	3					
		FS 527	4					
		FS 794	5					
	Mounting head	FS 520	1					
		FS 522	3					
		FS 523	4					
		FS 795	5					
	Square bolt	FS 779	D ₅ 3,5	SW ₁ 13	SW 2,7	for Collet size 1, 3, 4		
		FS 536	D ₅ 4,5	SW ₁ 13	SW 3,4	1, 3, 4		
		FS 538	D ₅ 6,0	SW ₁ 13	SW 4,9	1, 3, 4		
		FS 539	D ₅ 7,0	SW ₁ 13	SW 5,5	1, 3, 4		
		FS 540	D ₅ 8,0	SW ₁ 13	SW 6,2	1, 3, 4		
		FS 541	D ₅ 9,0	SW ₁ 13	SW 7,0	1, 3, 4		
		FS 542	D ₅ 10,0	SW ₁ 13	SW 8,0	1, 3, 4		
		FS 543	D ₅ 11,0	SW ₁ 13	SW 9,0	1, 3, 4		
		FS 544	D ₅ 12,0	SW ₁ 13	SW 9,0	1, 3, 4		
		FS 545	D ₅ 14,0	SW ₁ 13	SW 11,0	1, 3, 4		
		FS 546	D ₅ 16,0	SW ₁ 13	SW 12,0	1, 3, 4		
		FS 547	D ₅ 18,0	SW ₁ 13	SW 14,5	1, 3, 4		
		FS 548	D ₅ 20,0	SW ₁ 13	SW 16,0	1, 3, 4		
		FS 549	D ₅ 22,0	SW ₁ 13	SW 18,0	1, 3, 4		
		FS 550	D ₅ 25,0	SW ₁ 13	SW 20,0	1, 3, 4		
				FS 780	D ₅ 18,0	SW ₁ 25	SW 14,5	for Collet size 5
				FS 781	D ₅ 20,0	SW ₁ 25	SW 16,0	5
FS 782	D ₅ 22,0			SW ₁ 25	SW 18,0	5		
FS 783	D ₅ 25,0			SW ₁ 25	SW 20,0	5		
FS 784	D ₅ 28,0			SW ₁ 25	SW 22,0	5		
FS 785	D ₅ 32,0			SW ₁ 25	SW 24,0	5		
FS 786	D ₅ 36,0	SW ₁ 25	SW 29,0	5				

For tightening torques, see page G 117.

Assembly accessories

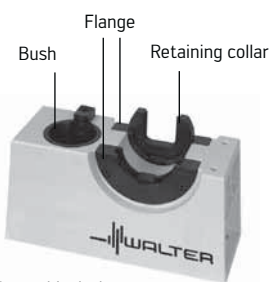
Assembly device, flange, retaining collars

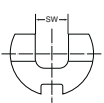
	Assembly device		Bush	Flange		Retaining collars for NCT				
	Designation	Integrated bush for	Designation	Designation	for	Retaining collars Designation	SW mm	D ₁ mm		
 Assembly device	V 500.00.040	SK 40	V540.23.040	V 510.10.040	ISO 40 DIN 2080					
				V 510.23.040	ISO 40 DIN 69871 ANSI B 5.50 und CAT					
				V 510.40.040	ISO 40 MAS BT					
 Flange	V 500.00.050	SK 50	V540.23.050	V 510.10.050	ISO 50 DIN 2080 (adaptor for NCT retaining collars)	V 530.22.025	22	25		
						V 530.27.032	27	32		
						V 530.32.040	32	40		
						V 530.41.050	41	50		
						V 530.55.063	55	63		
 Retaining collar	V 500.00.HSK063	HSK 63	V540.HSK.063AC	V 510.HSK063AC	HSK 63 form A+C					
				V 500.00.HSK100	HSK 100	V540.HSK.100AC	V 510.HSK100AC	HSK 100 form A+C		

The assembly device, flange and retaining collars must be ordered separately. The assembly device is provided with the suitable bush. The device can be fitted with max. two flanges. Note: For other Walter Capto™ mounting options, see page G 28.

Assembly set

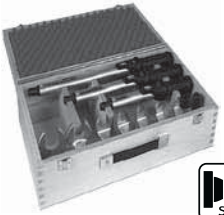
	Designation	consisting of:	
 NCT assembly set	FS 1407	Torque wrench	FS 1385 + 1386
		Socket wrench	FS 402–405
		Taper cleaner	all V 520, version B
		Retaining collars	all V 530
		Torx inserts	FS 806–808
		Wooden box	
 ScrewFit assembly set	FS 1395	Torque wrench	FS 1384 – FS 1386
		Open-ended wrench heads	FS 1387 – FS 1393
		Adaptor	FS 1394
		Wooden box	



Accessories for NCT and ScrewFit

Socket key for NCT tools



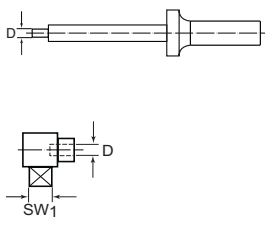

Designation	SW mm	SW ₁ mm	L ₁ mm	for NCT mm	for Walter porcupine cutters D _c mm
FS 402	5	9,52	130	25-32	
FS 403	8	12,7	130	40-50	
FS 404	12	12,7	150	63	
FS 405	14	12,7	150	80	
FS 1043	8	12,7	329		63
FS 1044	10	12,7	329		80

Torque wrench and head pieces

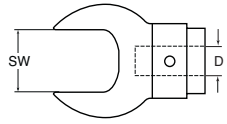

Designation	D mm	Torque range	SW ₁ mm
FS 1384	16	2-25 Nm	
FS 1385	16	10-100 Nm	
FS 1386	16	20-200 Nm	
FS 398	16		9,52
FS 399	16		12,7

Open-ended wrench heads for ScrewFit tools



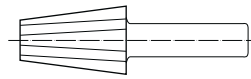

Designation	SW mm	for NCT	D mm	Tightening torque
FS 1387	SW 8	T 9	16	6 Nm
FS 1388	SW 12	T 14	16	25 Nm
FS 1389	SW 14	T 18	16	50 Nm
FS 1390	SW 17	T 22	16	80 Nm
FS 1391	SW 21	T 28	16	150 Nm
FS 1392	SW 30	T 36	16	200 Nm
FS 1393	SW 36	T 45	16	200 Nm
FS 1394	Adaptor for FS 1393 (from D 20 to D 16)		20	200 Nm

Taper bush cleaner

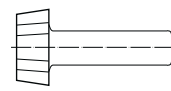

Version A





Version B for NCT

Designation	for Tapered shank	Version
V 520.40.000	ISO 40	A
V 520.45.000	ISO 45	A
V 520.50.000	ISO 50	A
V 520.25.032	D ₂ = 25 + 32	B
V 520.40.050	D ₂ = 40 + 45	B
V 520.63.000	D ₂ = 63	B
V 520.80.000	D ₂ = 80	B

Accessories for ConeFit™

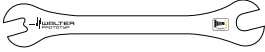
Flat wrench

	Designation	E	SW	Type
	FS2124-E10	10	8 + 6 for Spade type	Twin head
	FS2125-E12	12	10 + 8 for Spade type	Twin head
	FS2126-E16	16	12 + 10 for Spade type	Twin head
	FS2127-E20	20	16	Single head
	FS2128-E25	25	20	Single head

Torque wrench

	Designation	D	Torque range
	FS1384	16	2–25 Nm
	FS1385	16	10–100 Nm

Open-ended wrench heads for torque wrenches

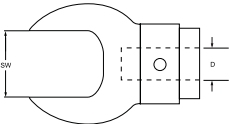
	Designation	E	SW	D	Nm
	FS2135-E10-R	10	8	16	12
	FS2136-E12-R	12	10	16	15
	FS2137-E16-R	16	12	16	30
	FS2138-E20-R	20	16	16	50
	FS2141-E25-R	25	20	16	65

Set

ConeFit™ SET-E12-MULTI – metric

	Designation	E	Contents	Remarks
	CONEFIT-SET-E12-MULTI	12	H3E82378-E12-12	Qmax roughing end mill
			H3E21138-E12-12	N 50 finishing end mill
			H3E21317-E12-12	Tough guys N50
			H3E58318-E12-12	Chamfer mill 90°
			AK610.Z12.E12.022	Holder type A
			AK610.Z16.E12.025	Holder type C
			FS2125-E12	Flat wrench

Assembly parts and accessories for master

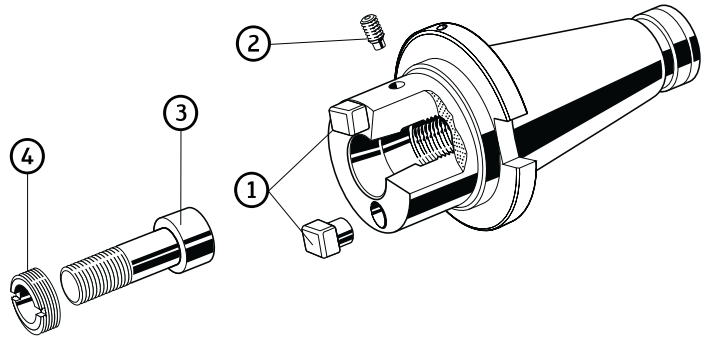

Assembly parts		d ₁₁ = 25 mm	d ₁₁ = 32 mm	d ₁₁ = 40 mm	d ₁₁ = 50 mm	d ₁₁ = 63 mm	d ₁₁ = 80 mm	
①	Drive dog				FS 554	FS 555 (B = 12) FS 557 (B = 14)	FS 556 (B = 14) FS 558 (B = 16)	
②	Threaded plug DIN 914	for SK 40	M 4 x 12	M 4 x 10	M 5 x 10	M 5 x 10	M 6 x 8	
		for SK 50	M 4 x 12	M 4 x 12	M 5 x 12	M 5 x 12	M 6 x 16	M 6 x 16
③	Screw	for SK 40	FS 414	FS 414	FS 415	FS 415	FS 416	FS 850
		for SK 50	FS 414	FS 414	FS 415	FS 415	FS 416	FS 417
④	Threaded ring	FS 410	FS 410	FS 411	FS 411	FS 412	FS 413	

Accessories		d ₁₁ = 25 mm	d ₁₁ = 32 mm	d ₁₁ = 40 mm	d ₁₁ = 50 mm	d ₁₁ = 63 mm	d ₁₁ = 80 mm
Pipe wrench for threaded ring		FS 738	FS 738	FS 739	FS 739	FS 740	FS 741

Axial clamping system

d ₁₁ mm	③ Thread	Wrench size	Torque wrench	Socket wrench	Tightening torque	max. speed
25	M 8	5	FS 1385	FS 402	18 Nm	20,000 rpm
32	M 8	5	FS 1385	FS 402	18 Nm	30,000 rpm
40	M 12	8	FS 1386	FS 403	80 Nm	30,000 rpm
50	M 12	8	FS 1386	FS 403	80 Nm	30,000 rpm
63	M 16	12	FS 1386	FS 404	150 Nm	30,000 rpm
80	M 20	14	FS 1386	FS 405	200 Nm	30,000 rpm

Assembly parts and accessories for intermediate elements

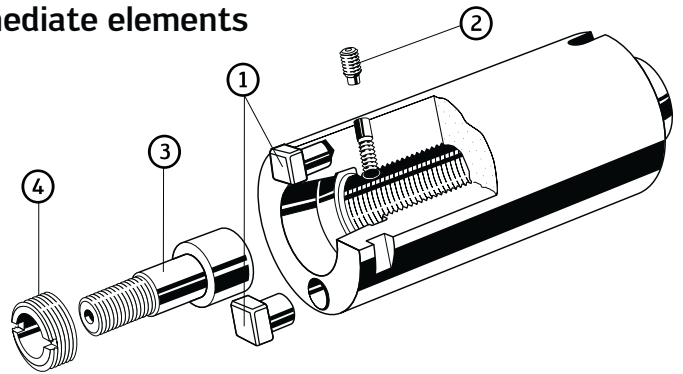

Assembly parts		d ₁₁ = 25 mm	d ₁₁ = 32 mm	d ₁₁ = 40 mm	d ₁₁ = 50 mm	d ₁₁ = 63 mm	d ₁₁ = 80 mm
①	Drive dog	FK 311	FK 312	FK 313	FS 554	FS 555 (B = 12) FS 557 (B = 14)	FS 556 (B = 14) FS 558 (B = 16)
	Screw for drive dog	FS 502	FS 503	FS 504			
②	DIN 914 threaded plug	M 4 x 6	M 4 x 8	M 5 x 10	M 5 x 12	M 6 x 16	M 6 x 16
③	Screw	FS 414	FS 414	FS 415	FS 415	FS 416	FS 417
④	Threaded ring	FS 410	FS 410	FS 411	FS 411	FS 412	FS 413

Accessories		d ₁₁ = 25 mm	d ₁₁ = 32 mm	d ₁₁ = 40 mm	d ₁₁ = 50 mm	d ₁₁ = 63 mm	d ₁₁ = 80 mm
Pipe wrench for threaded ring		FS 738	FS 738	FS 739	FS 739	FS 740	FS 741

Axial clamping system

d ₁₁ mm	③ Thread	Wrench size	Torque wrench	Socket wrench	Tightening torque	max. speed
25	M 8	5	FS 1385	FS 402	18 Nm	20,000 rpm
32	M 8	5	FS 1385	FS 402	18 Nm	30,000 rpm
40	M 12	8	FS 1386	FS 403	80 Nm	30,000 rpm
50	M 12	8	FS 1386	FS 403	80 Nm	30,000 rpm
63	M 16	12	FS 1386	FS 404	150 Nm	30,000 rpm
80	M 20	14	FS 1386	FS 405	200 Nm	30,000 rpm

Operating instructions for Walter Capto™

Clamping principle for types 2035, 2045, 2055, 2065, 2080, 2085 and 2090 and VDI

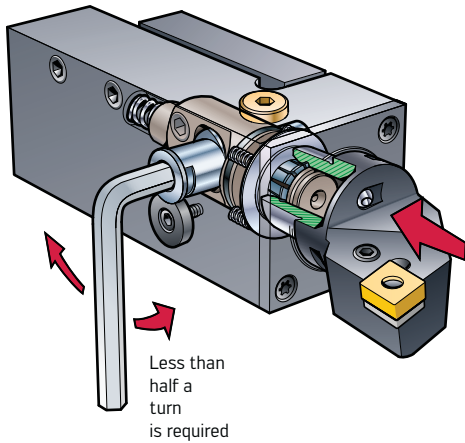

Clamped using a bushing – Drawbar activated by a cam

With the help of a cam the drawbar is moved forwards and backwards. The tool is clamped and released via a cam shaft.

Recommended torque:

- C3: 35 Nm
- C4: 50 Nm
- C5: 70 Nm
- C6: 90 Nm
- C8: 130 Nm

For torque wrenches, see page G 28.

Clamping principle for type 2000

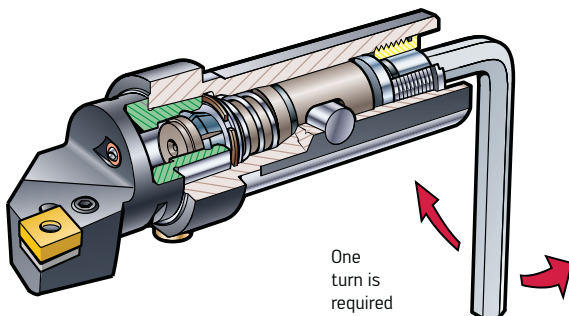

Clamped using a bushing – Drawbar activated by a screw

The movement of the drawbar is controlled by a screw at the end of the clamping unit.

Recommended torque:

- C3: 35 Nm
- C4: 50 Nm
- C5: 70 Nm

For torque wrenches, see page G 28.

Clamping principle for type 3000

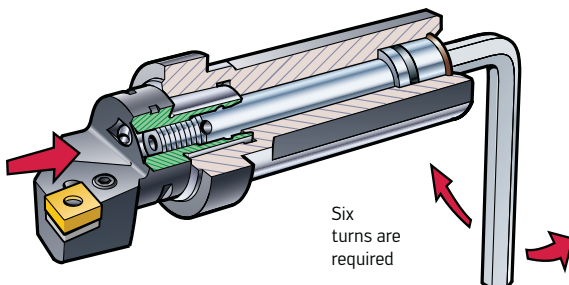

Clamped directly via a central screw

The thread in the coupling system is used to clamp and release the tool with the central screw.

Recommended torque:

- C3: 45 Nm
- C4: 55 Nm
- C5: 95 Nm
- C6: 170 Nm
- C8: 170 Nm

For torque wrenches, see page G 28.

Conversion of VDI turrets to Walter Capto™ – Selection of clamping units

External machining

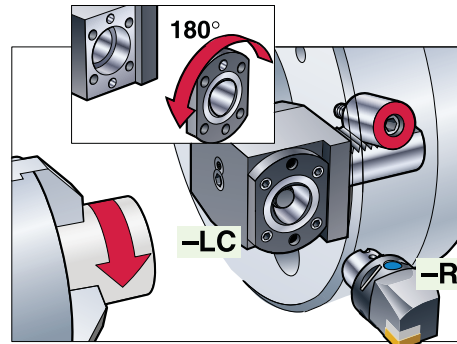
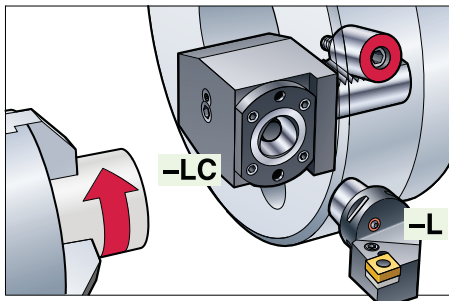

Important:
Turn polygon
socket 180° –
see page G 29.

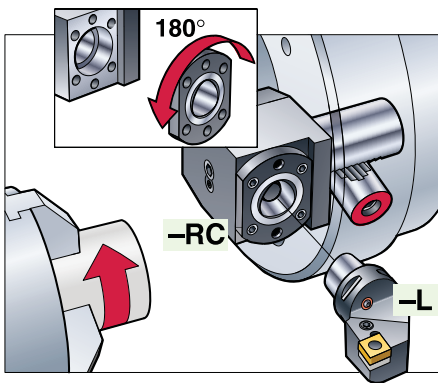

Important:
Turn polygon
socket 180° –
see page G 29.

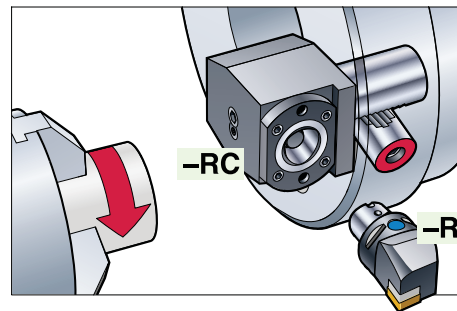

Internal machining

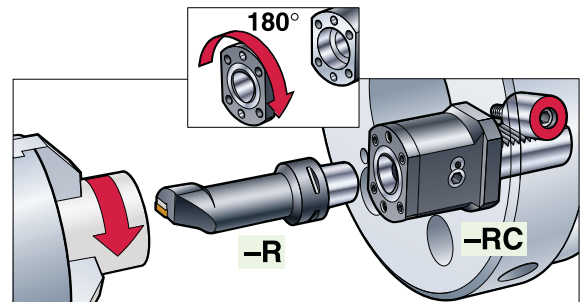
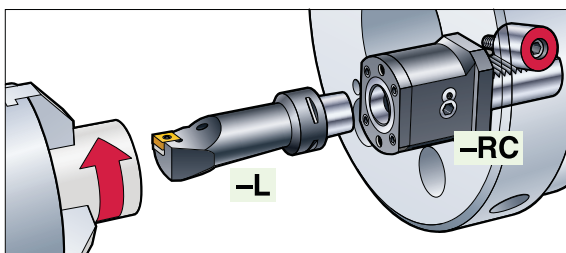

Important:
Turn polygon socket 180° – see page G 29.

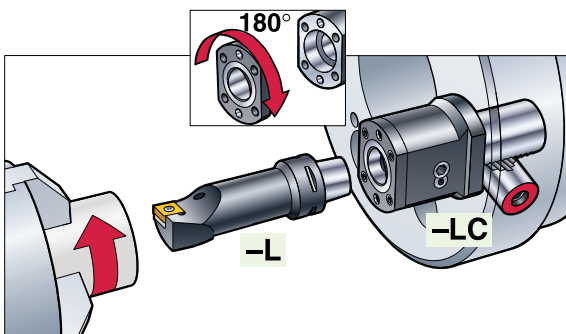

Important:
Turn polygon socket 180° – see page G 29.

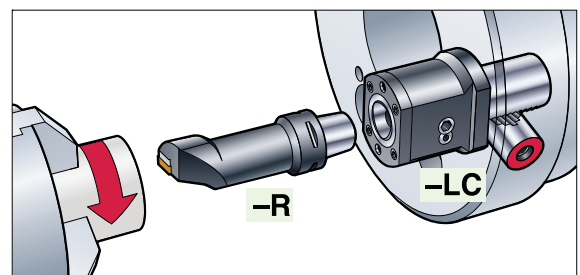

Conversion of turrets with square or round shank adaption to Walter Capto™ – Selection of clamping units, type 2000/3000/2085

External machining with clamping unit RC 2085/LC 2085

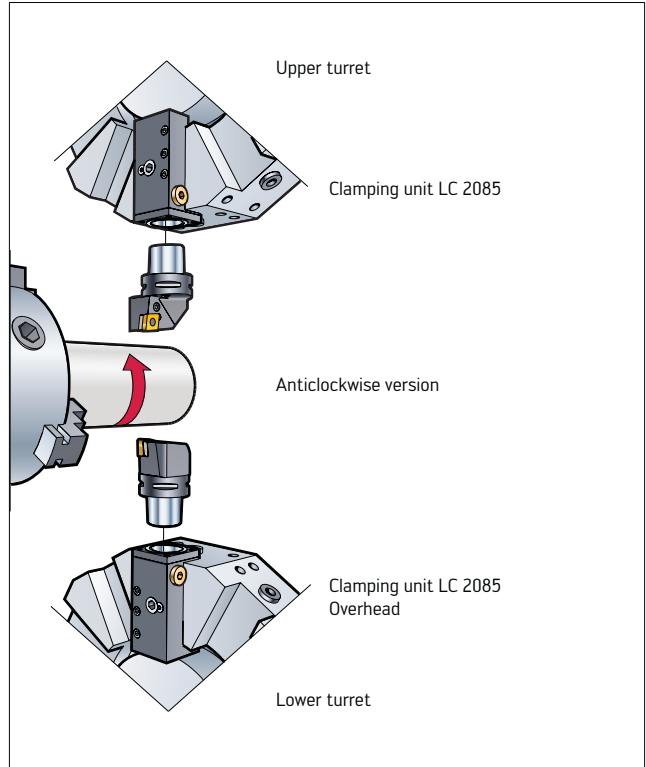
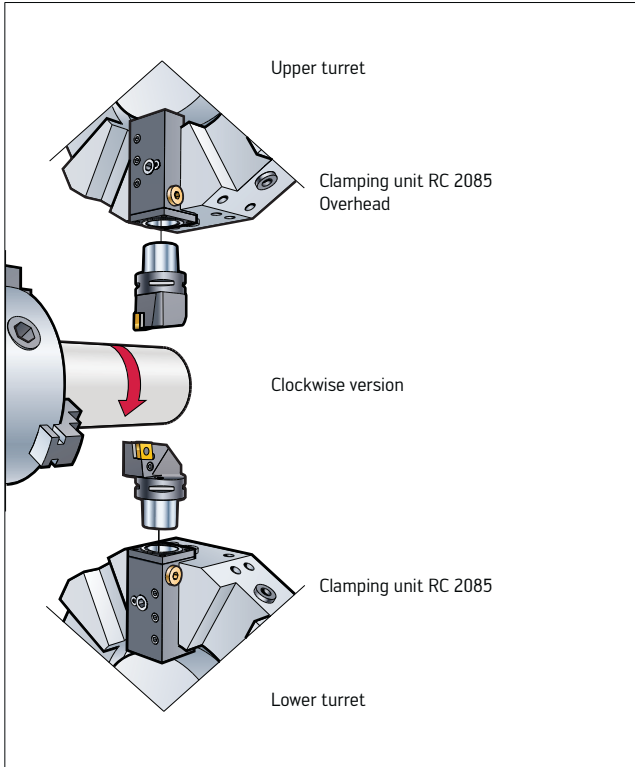

Internal machining with clamping unit NC 2000/3000/2035/2045/2055/2065

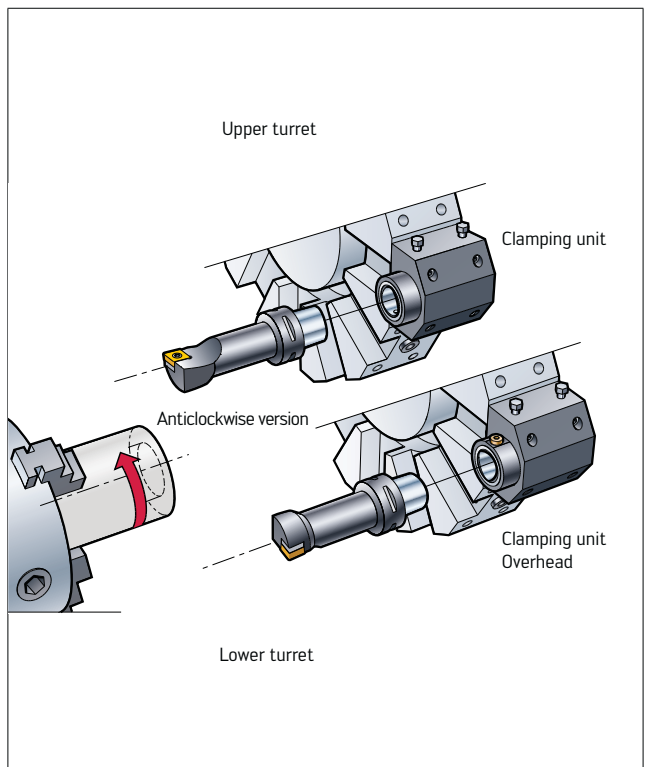
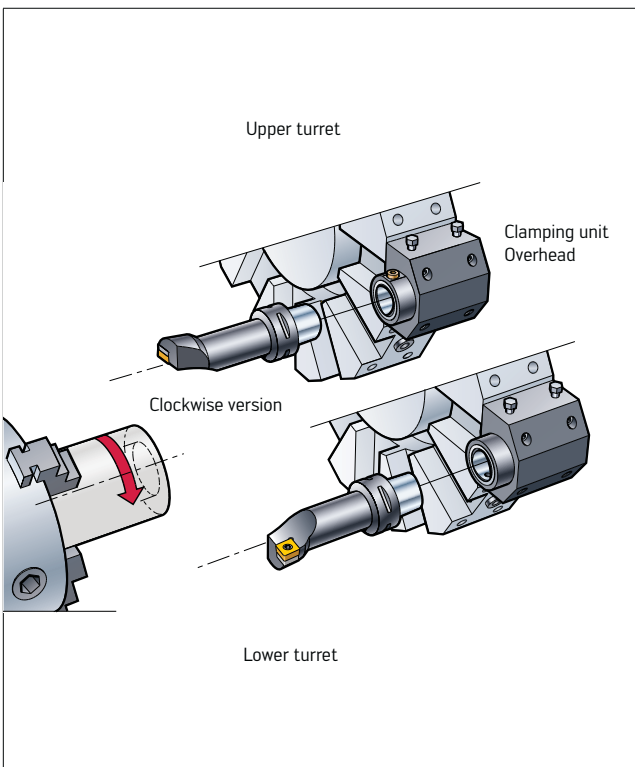

Assembly instructions for the use of clamping unit RC/LC 2090

Application example



The clamping unit type 2090 has been designed for universal usage cases.
For instructions on the design and use of these clamping units, please see below.



Drilling pattern

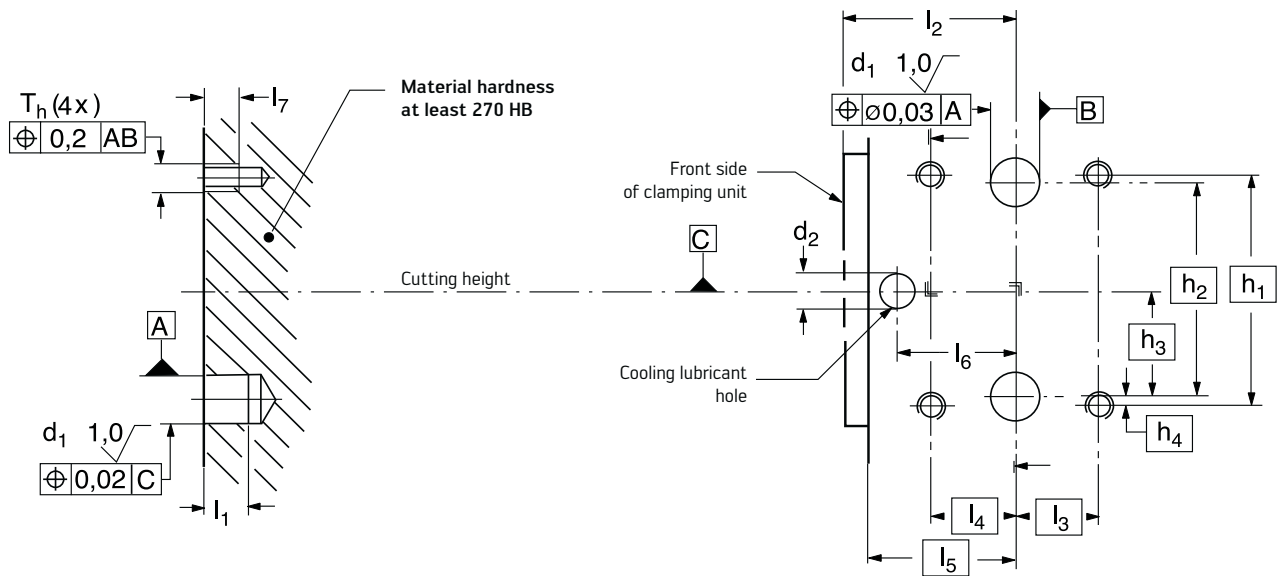

Clamping unit	d ₁ /H7 mm	d ₂ mm	h ₁ mm	h ₂ mm	h ₃ mm	h ₄ mm	l ₁ mm	l ₂ mm	l ₃ mm	l ₄ mm	l ₅ mm	l ₆ mm	l ₇ mm	T _h
C3-R/LC2090-19039M	12	5	42	39	19,5	1,5	8,5	39	19	19	33,5	28	7,5	M6
C4-R/LC2090-24043A	16	7	60	55	27,5	2,5	11	43	19	19	36,5	30	11	M8
C5-R/LC2090-32048A	20	7	70	62	31	4	12	48	21	21	39,5	33	13	M10
C6-R/LC2090-42060	25	10	82	71	35,5	5,5	20	60	24,5	24,5	50,5	41	12	M10
C8-R/LC2090-50088	32	11	110	92	46	9	20	88	43	43	76	63	145	M12

Assembly instructions for collet chuck with ER collets (C 330, C 340) and sealing disc

Mounting the collet chuck

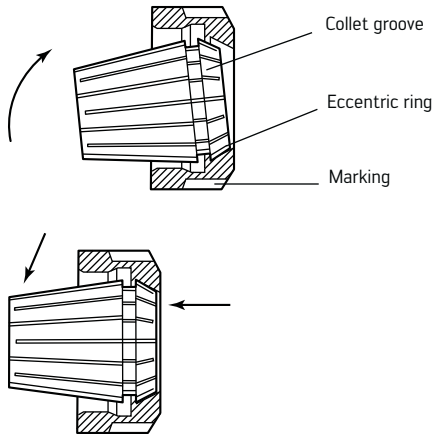

Fitting

1. Fit collet groove into the clamping nut eccentric ring at the position shown.
2. Tilt the collet in the opposite direction until you hear it click into place.
3. Insert the tool.
4. Screw clamping nut to toolholder and tighten.

Removal

After unscrewing from the holder, simultaneously press down on the front and end of the collet.

Fitting the sealing discs

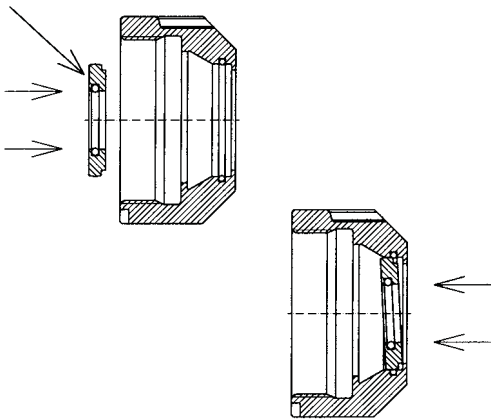

Fitting

1. Insert the sealing disc into the nut so that the inscription is at the rear.
2. Insert the sealing disc and press until you hear an audible click.
3. If correctly mounted, the sealing disc is flush with the front of the clamping nut.

Removal

Press the disc from the outside until it jumps out.

Note

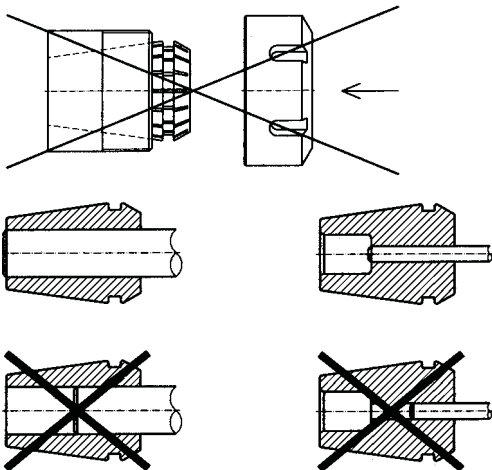

- a. The collet must be engaged into the clamping nut during assembly.
- b. Never apply excessive pressure to shanks.
Use the next collet size up.
E.g. shank $\varnothing = 14.3$ with collet
Collet $\varnothing 15-14$ mm
- c. Where possible, clamp the tool shank along the whole length of the collet (at least $\frac{2}{3}$ of the collet length).

Locking bolts for face mill adaptors

When using face mill adaptors A150, A155 and AK155 in combination with porcupine cutters and ramping cutters with cylindrical bores and DIN 138 longitudinal key way, the locking bolt of the adaptor must be replaced.

Designation	Locking bolt for adaptor*
F4138.B16.040.Z03.33	M8 x 40 (SW6)
F4138.B16.040.Z03.43	M8 x 50 (SW6)
F4138.B22.050.Z04.43	M10 x 45 (SW8)
F4138.B22.050.Z04.54	M10 x 55 (SW8)
F4138.B27.063.Z05.43	M12 x 45 (SW10)
F4138.B27.063.Z05.54	M12 x 55 (SW10)
F4138.B32.080.Z06.54	M16 x 65 (SW14)
F4138.B32.080.Z06.65	M16 x 70 (SW14)
F4238.B22.050.Z03.43	M10 x 45 (SW8)
F4238.B27.063.Z04.43	M12 x 55 (SW10)
F4238.B27.063.Z04.57	M12 x 70 (SW10)
F4238.B27.066.Z04.57	M12 x 70 (SW10)
F4238.B32.080.Z05.57	M16 x 70 (SW14)
F4238.B32.080.Z05.71	M16 x 90 (SW14)
F4238.B32.085.Z05.71	M16 x 90 (SW14)
F4338.B27.063.Z04.31	M12 x 40 (SW10)
F4338.B27.063.Z04.47	M12 x 50 (SW10)
F4338.B27.063.Z04.63	M12 x 65 (SW10)
F4338.B32.080.Z05.31	M16 x 35 (SW14)
F4338.B32.080.Z05.63	M16 x 70 (SW14)
F4338.B32.080.Z05.78	M16 x 90 (SW14)
F4338.B40.100.Z05.78	M20 x 80 (SW17)
F4338.B40.125.Z06.94	M20 x 90 (SW17)
F2238.B.050.Z02.42	M10 x 40 (SW8)
F2238.B.063.Z03.50	M12 x 35 (SW10)
F2238.B.065.Z03.50	M12 x 35 (SW10)
F2238.B.080.Z03.67	M16 x 60 (SW14)
F2238.B.082.Z03.67	M16 x 60 (SW14)
F2238.B.100.Z04.77	M20 x 70 (SW17)
F2238.B.125.Z05.87	M24 x 80 (SW19)
F3040.B.040.Z03.15	M8 x 40 (SW6)
F3040.B.050.Z04.15	M10 x 35 (SW8)
F3040.B.063.Z05.15	M10 x 35 (SW8)
F3040.B.050.Z03.20	M10 x 40 (SW8)
F3040.B.063.Z04.20	M10 x 35 (SW8)

* Cap head bolt ISO 4762 (12.9)

Assembly instructions for Walter NC tools system



1. Assembly device with accessories.



2. Example of tooling combination.



3. Clean the inside taper and the support face.



4. Insert the retaining collar V 530 into the flange V 510.10.050.



5. Insert the extension into the retaining collar.



6. Screw the extension and the cutter adaptor together by hand using the extended socket key.



7. Tighten with a torque wrench.



8. Insert the master into the associated flange.



9. Screw the NC tool elements together using the master.



10. Tighten with a torque wrench.



11. Insert the assembled adaptors into the tapered bush.



12. Install and tighten the cutting tool.

For tightening torque for NCT, see page F 309.

Tightening torques for thread cutting and tap shank dimensions

Recommended values for torque adjustment of tapping chucks

Thread type	Size [mm]	Lead [mm]	Thread cutting torque setting	Tap breaking torque	Thread forming torque setting
M, MF	1	≤ 0,25	0,03*	0,03	0,07*
M, MF	1,2	≤ 0,25	0,07*	0,07	0,12
M, MF	1,4	≤ 0,3	0,1*	0,1	0,16
M, MF	1,6	≤ 0,35	0,15*	0,15	0,25
M, MF	1,8	≤ 0,35	0,24*	0,24	0,3
M, MF	2	≤ 0,4	0,3*	0,3	0,4
M, MF	2,5	≤ 0,45	0,5	0,6	0,6
M, MF	3	≤ 0,5	0,7	1	1
M, MF	3,5	≤ 0,6	1,2	1,6	1,5
M, MF	4	≤ 0,7	1,7	2,3	2,4
M, MF	5	≤ 0,8	3	5	4
M, MF	6	≤ 1,0	5,5	8,1	8
M, MF	8	≤ 1,25	12	20	17
M, MF	10	≤ 1,5	20	41	30
M, MF	12	≤ 1,75	35	70	50
M, MF	14	≤ 2,0	50	130	75
M, MF	16	≤ 2,0	60	160	85
M, MF	18	≤ 2,5	100	260	150
M, MF	20	≤ 2,5	110	390	160
M, MF	22	≤ 2,5	125	450	170
M, MF	24	≤ 3,0	190	550	260
M, MF	27	≤ 3,0	220	850	290
M, MF	30	≤ 3,5	320	1100	430
M, MF	33	≤ 3,5	350	1600	470
M, MF	36	≤ 4,0	460	2300	650
M, MF	39	≤ 4,0	500		
M, MF	42	≤ 4,5	700		
M, MF	45	≤ 4,5	750		
M, MF	48	≤ 5,0	900		
M, MF	52	≤ 5,0	1000		
M, MF	56	≤ 5,5	1300		

When the correction values are being used, the torque setting can exceed the breaking torque of the tap.

Basis: Material 42CrMo4, 1000 N/mm², thread depth 1.5 x D_c.

* Thread depth not reached.

Tap shank dimensions

Shank dim. mm	DIN 371	DIN 374	DIN 376	Square bolt	Size
3,5 x 2,7	M 3	M 5	M 5	FS 779	1, 3, 4
4,5 x 3,4	M 4	M 6	M 6	FS 536	1, 3, 4
6,0 x 4,9	M 5/M 6	M 8	M 8	FS 538	1, 3, 4
7,0 x 5,5		M 10	M 10	FS 539	1, 3, 4
8,0 x 6,2	M 8			FS 540	1, 3, 4
9,0 x 7,0		M 12	M 12	FS 541	1, 3, 4
10,0 x 8,0	M 10			FS 542	1, 3, 4
11,0 x 9,0		M 14	M 14	FS 543	1, 3, 4
12,0 x 9,0		M 16	M 16	FS 544	1, 3, 4
14,0 x 11,0		M 18	M 18	FS 545	1, 3, 4
16,0 x 12,0		M 20	M 20	FS 546	1, 3, 4
18,0 x 14,5		M 22/M 24	M 22/M 24	FS 547	1, 3, 4
20,0 x 16,0		M 27	M 27	FS 548	1, 3, 4
22,0 x 18,0		M 30	M 30	FS 549	1, 3, 4
25,0 x 20,0		M 33	M 33	FS 550	1, 3, 4
18,0 x 14,5		M 22/M 24	M 22/M 24	FS 780	5
20,0 x 16,0		M 27	M 27	FS 781	5
22,0 x 18,0		M 30	M 30	FS 782	5
25,0 x 20,0		M 33	M 33	FS 783	5
28,0 x 22,0		M 36	M 36	FS 784	5
32,0 x 24,0		M 39/M 42	M 39/M 42	FS 785	5
36,0 x 29,0		M 48	M 48	FS 786	5

Conversion for other materials

Material	Factor
Soft steel	0,7
Steel 1200 N/mm ²	1,2
Steel 1600 N/mm ²	1,4
VA	1,3
GG/GGG	0,6
Aluminium/copper	0,4
Ti alloys	1,1
Ni alloys	1,4



CONTENTS

General

General technical information	Calculation formulae for turning	H 2
	Calculation formulae for drilling	H 3
	Calculation formulae for milling	H 4
	Milling engagement conditions	H 5
	Calculation formulae for thread machining	H 6
	Cutting forces of the Walter machining groups	H 7
	Workpiece material comparison table	H 8
	Hardness comparison table	H 30
	Clamping screws for indexable inserts	H 31
	Screwdrivers	H 32
	Clamping systems for tools and tool adaptors	H 34
	ISO tolerances	H 41
	Accessories for tool adaptors	H 42
	Assembly parts and accessories	H 43

Alphanumeric Index	for Walter tools	H 51
	for Walter Titex tools	H 56
	for Walter Prototyp tools	H 58
	for Walter competence brands	H 67

Turning calculation formulae

Speed

$$n = \frac{v_c \times 1000}{D_c \times \pi} \quad [\text{min}^{-1}]$$

Cutting speed

$$v_c = \frac{D_c \times \pi \times n}{1000} \quad [\text{m/min}]$$

Feed rate

$$v_f = n \times f \quad [\text{mm/min}]$$

Metal removal rate

$$Q = v_c \times a_p \times f \quad [\text{cm}^3/\text{min}]$$

Chip cross section

$$A = h \times b = a_p \times f \quad [\text{mm}^2]$$

Chip width, chip thickness

$$b = \frac{a_p}{\sin \kappa} \quad [\text{mm}] \quad h = f \times \sin \kappa \quad [\text{mm}]$$

Main cutting force

$$F_c = A \times k_{c1.1} \times h^{-m_c} \quad [\text{N}]$$

Power requirement

$$P_{\text{mot}} = \frac{F_c \times v_c}{60000 \times \eta} \quad [\text{kW}]$$

Cutting time

$$t_h = \frac{l_m}{f \times n} \quad [\text{min}]$$

Roughness profile depth

$$R_{\text{max}} = \frac{f^2}{8 \times r} \times 1000 \quad [\mu\text{m}]$$

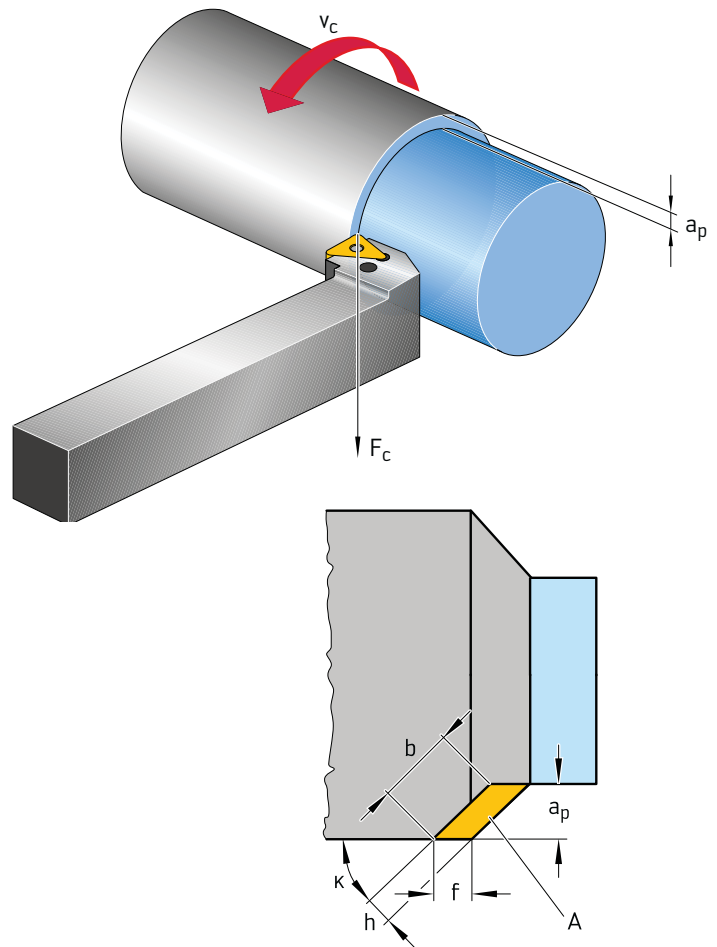

n	Speed	rpm
D _c	Cutter diameter	mm
v _c	Cutting speed	m/min
v _f	Feed rate	mm/min
f	Feed per revolution	mm
Q	Metal removal rate	cm ³ /min
a _p	Depth of cut	mm
A	Chip cross section	mm ²
h	Chip thickness	mm
b	Chip width	mm
κ	Approach angle	°
F _c	Main cutting power	N
k _{c1.1} *	Specific cutting force for 1 mm ² chip cross-section	N/mm ²
m _c *	Increase in the k _c curve	
P _{mot}	Drive power	kW
t _h	Cutting time	min
l _m	Length of cut	mm
R _{max}	Roughness profile depth	μm
r	Corner radius of the insert	mm
η	Efficiency of machine	(0.75 – 0.9)

*m_c and k_{c1.1} see table on page H 7

Drilling calculation formulae

Speed

$$n = \frac{v_c \times 1000}{D_c \times \pi} \quad [\text{min}^{-1}]$$

Cutting speed

$$v_c = \frac{D_c \times \pi \times n}{1000} \quad [\text{m/min}]$$

Feed per revolution

$$f = f_z \times z \quad [\text{mm}]$$

Feed rate

$$v_f = f \times n \quad [\text{mm/min}]$$

Metal removal rate (drilling)

$$Q = \frac{v_f \times \pi \times D_c^2}{4 \times 1000} \quad [\text{cm}^3/\text{min}]$$

Power requirement

$$P_{\text{mot}} = \frac{Q \times k_c}{60000 \times \eta} \quad [\text{kW}]$$

Torque

$$M_c = \frac{D_c^2 \times k_c \times f}{8000} = \frac{P_c \times 9500}{n} \quad [\text{Nm}]$$

Feed force

$$F_f = 0,63 \times \frac{f \times D_c \times k_c}{2} \quad [\text{N}]$$

Specific cutting force

$$k_c = \frac{k_{c1.1}}{h^{m_c}}$$

Chip thickness

$$h = f_z \times \text{sink} \quad [\text{mm}]$$

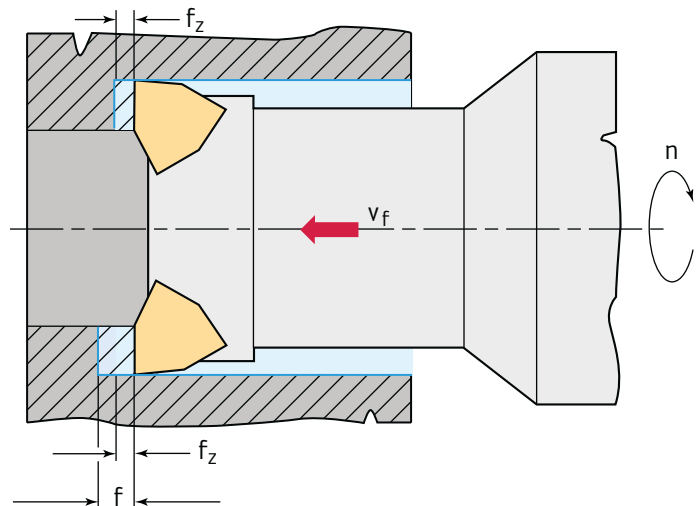
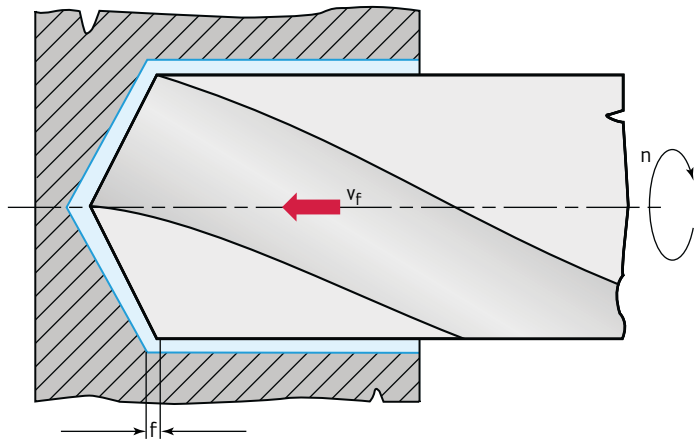

n	Speed	rpm
D _c	Cutter diameter	mm
z	Number of teeth	
v _c	Cutting speed	m/min
v _f	Feed rate	mm/min
f _z	Feed per tooth	mm
f	Feed per revolution	mm
A	Chip cross section	mm ²
Q	Metal removal rate	cm ³ /min
P _{mot}	Drive power	kW
M _c	Torque	Nm
F _f	Axial force	N
h	Chip thickness	mm
k _c	Specific cutting force	N/mm ²
η	Efficiency of machine (0.7–0.95)	
κ	Approach angle	°
k _{c1.1} *	Specific cutting force for 1 mm ² Chip cross section with h = 1 mm	N/mm ²
m _c *	Increase in the k _c curve	

*m_c and k_{c1.1} see table on page H 7

Milling calculation formulae

Speed

$$n = \frac{v_c \times 1000}{D_c \times \pi} \quad [\text{min}^{-1}]$$

Cutting speed

$$v_c = \frac{D_c \times \pi \times n}{1000} \quad [\text{m/min}]$$

Feed rate

$$v_f = f_z \times z \times n \quad [\text{mm/min}]$$

Feed per tooth

$$f_z = \frac{v_f}{z \times n} \quad [\text{mm/z}]$$

Metal removal rate

$$Q = \frac{a_e \times a_p \times v_f}{1000} \quad [\text{cm}^3/\text{min}]$$

Power requirement

$$P_{\text{mot}} = \frac{a_p \times a_e \times v_f \times k_c}{6 \times 10^7 \times \eta} \quad [\text{kW}]$$

Medium chip thickness

$$h_m = \frac{\{114,7 \times f_z \times \sin \kappa \times (a_e / D_c)\}}{\varphi_s} \quad [\text{mm}]$$

$$f_z = \frac{h_m \times \varphi_s}{114,7 \times \sin \kappa \times (a_e / D_c)} \quad [\text{mm}]$$

or

$$h_m \cong f_z \times \sqrt{\frac{a_e}{D_c}} \quad [\text{mm}]$$

$$f_z = \frac{h_m}{\sqrt{\frac{a_e}{D_c}}} \quad [\text{mm}]$$

as approximation formula for $a_e / D_c < 30\%$

Engagement angle

where cutter is positioned centrally

$$\varphi_s = 2 \times \arcsin \left(\frac{a_e}{D_c} \right) \quad [^\circ]$$

where cutter is positioned eccentrically

$$\varphi_s = 90^\circ + \arcsin \frac{a_e - (D_c / 2)}{(D_c / 2)} \quad [^\circ]$$

Specific cutting force

$$k_c = \frac{1 - 0,01 \times \gamma_0}{h_{\text{mc}}} \times k_{c1.1} \quad [\text{N/mm}^2]$$

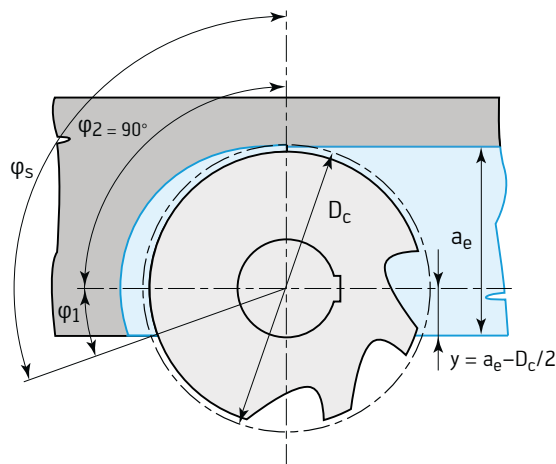
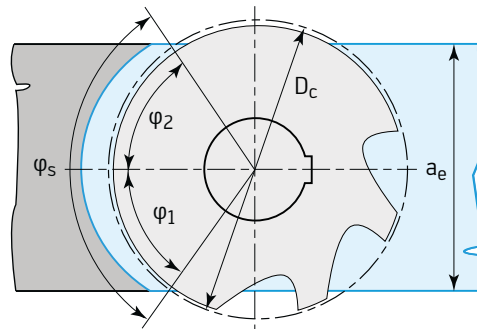
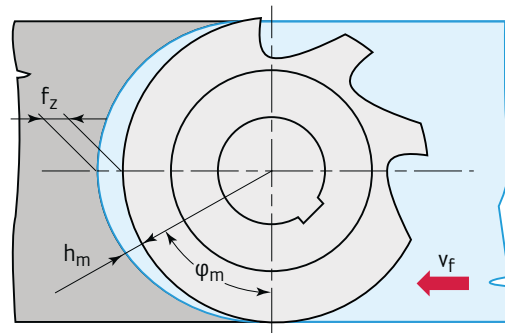

n	Speed	rpm
D_c	Cutter diameter	mm
a_p	Depth of cut	mm
a_e	Width of cut	mm
z	Number of teeth	
v_c	Cutting speed	m/min
v_f	Feed rate	mm/min
f_z	Feed per tooth	mm
Q	Metal removal rate	cm ³ /min
P_{mot}	Drive power	kW
h_m	Medium chip thickness	mm
k_c	Specific cutting force	N/mm ²
η	Efficiency of machine (0.7–0.95)	
κ	Approach angle	°
φ_s	Engagement angle	°
φ_1	Up-cut milling area	°
φ_2	Synchronous milling area	°
k_c	Specific cutting force	N/mm ²
$k_{c1.1}^*$	Specific cutting force for 1 mm ² chip cross section	N/mm ²
m_c^*	Increase in the k_c curve	
y	Reverse engagement	mm

* m_c and $k_{c1.1}$ see table on page H 7

Engagement ratio for external circular interpolation

External profile feed rate

$$v_{fa} = \left(1 + \frac{D_c}{D_w + a_e}\right) \times v_f \quad [\text{mm/min}]$$

Circular interpolation traverse time

$$T_{rev} = \frac{D_m \times \pi}{n \times f_z \times z} \quad [\text{min}]$$

$$T_{rev} = \frac{(D_w + D_a) D_a \times \pi^2 \times 60}{v_c \times f_z \times z \times 1000} \quad [\text{s}]$$

Cutter engagement width for external circular interpolation

$$a_e = \frac{(D_v^2 - D_w^2)}{4(D_w + D_a)} \quad [\text{mm}]$$

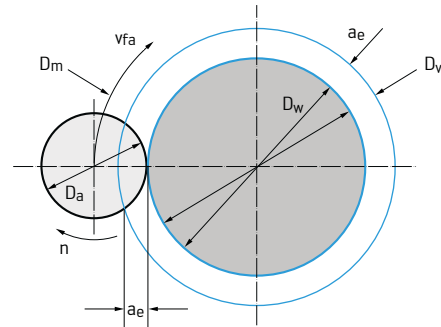

External contour

v_{fa}	Feed rate of tool axis	[mm/min]
D_a	Cutter outer diameter	[mm]
D_m	Mid-point path diameter	[mm]
D_v	Workpiece raw diameter	[mm]
D_w	Workpiece machined diameter	[mm]
a_e	Material removal	[mm]
n	Speed	[rpm]
f_z	Feed per tooth	[mm]
z	Number of teeth	

Engagement ratio for internal circular interpolation

Internal profile feed rate

$$v_{fi} = \left(1 - \frac{D_c}{D_w}\right) \times v_f \quad [\text{mm/min}]$$

Circular interpolation traverse time

$$T_{rev} = \frac{D_m \times \pi}{n \times f_z \times z} \quad [\text{min}]$$

$$T_{rev} = \frac{(D_w - D_a) D_a \times \pi^2 \times 60}{v_c \times f_z \times z \times 1000} \quad [\text{s}]$$

Cutter engagement width for internal circular interpolation

$$a_e = \frac{(D_w^2 - D_v^2)}{4(D_v + D_a)} \quad [\text{mm}]$$

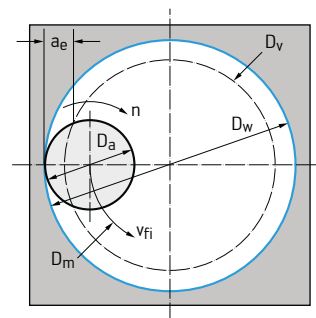

Internal contour

v_{fi}	Feed rate of tool axis	[mm/min]
D_a	Cutter diameter	[mm]
D_v	Workpiece raw diameter	[mm]
D_w	Workpiece machined diameter	[mm]
n	Speed	[rpm]

Thread machining calculation formulae

Speed

$$n = \frac{v_c \times 1000}{D_c \times \pi} \quad [\text{min}^{-1}]$$

Cutting speed

$$v_c = \frac{D_c \times \pi \times n}{1000} \quad [\text{m/min}]$$

Torque

$$M_D = \frac{k_c \times h^2 \times d_1}{8000} \quad [\text{Nm}]$$

Power requirement – tool

$$P = \frac{M_D \times n}{9500} \quad [\text{kW}]$$

Power requirement – motor

$$P_{\text{mot}} = \frac{P}{\eta_M} \quad [\text{kW}]$$

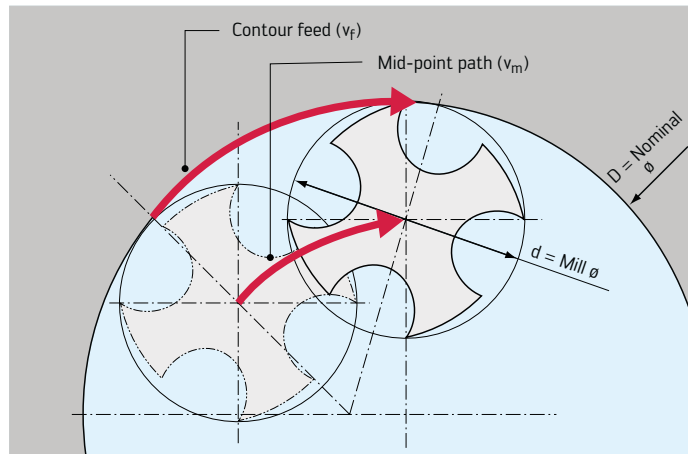

Thread milling calculation formulae

$$v_m = \frac{v_f (D-d)}{D}$$

k_c	Specific cutting force	N/mm^2
n	Speed	rpm
h	Thread pitch	mm
d_1	Nominal thread diameter	mm
P_{mot}	Drive power	kW
η_M	Machine efficiency (<1)	

Cutting forces of Walter machining groups

Description	Tensile strength		Spec. cutting force	Increase value	Walter machining group
	min	max			
	R _m		k _{c1.1}	m _c	
	[N/mm ²]		[N/mm ²]		
Non-alloyed and low-alloyed steels, C > 0.25 %, low and medium strength	350	750	1500	0,21	P1, P6
Unalloyed and low-alloyed steels, C > 0.55 %, not tempered	400	900	1700	0,25	P2, P3, P4, P7, P14
Low and high-alloyed steels, low tempering level	750	1100	2000	0,25	P5, P8, P11, P12
Stainless ferritic / martensitic steels, tempered	800	1400	2200	0,25	P15
Low and high-alloyed steels, medium tempering level	1100	1400	2500	0,25	P9
Low and high-alloyed steels, high tempering level	1200	1600	3000	0,25	P10, P13
Stainless, austenitic steels	400	900	1800	0,21	M1
Stainless, austenitic/ferritic steel + duplex	600	1000	2000	0,21	M3
Stainless, austenitic steels, precipitation hardened (PH steels)	700	1500	2400	0,21	M2
Grey cast iron + CGI + malleable cast iron, low tensile strength	200	400	800	0,28	K1, K3, K7
Ductile cast iron low tensile strength + malleable cast iron with higher tensile strength	400	600	950	0,28	K2, K5
Grey cast iron with higher tensile strength	300	400	1200	0,28	K4,
Ductile cast iron with high tensile strength + ADI high tensile strength, unalloyed + alloyed	600	800	1400	0,28	K6
Aluminium wrought alloy, not hardened			350	0,25	N1
Aluminium wrought alloy, hardened			600	0,25	N2
Cast aluminium alloy < 12 % Si, not hardened			600	0,25	N3
Cast aluminium alloy < 12 % Si, hardened, cast aluminium alloy ≥ 12 %			700	0,25	N4, N5
Pure copper, copper alloy (brass, bronze) with low tensile strength			550	0,25	N7, N8, N9
High tensile strength copper alloy, bronze with high tensile strength			1000	0,25	N10
Heat-resistant alloys, iron-based, annealed			2400	0,25	S1
Heat-resistant alloys, iron-based, hardened			2500	0,25	S2
Pure titanium			1300	0,25	S6
Titanium alloys, alpha, alpha/beta and beta alloys			1500	0,25	S7, S8
Heat-resistant alloys, nickel-cobalt-based, annealed			2800	0,25	S3
Heat-resistant alloys, nickel-cobalt-based, hardened			2900	0,25	S4
Heat-resistant alloys, nickel-cobalt-based, cast			3000	0,25	S5
Hardened steels 46 – 52 HRC			3000	0,25	H1
Hardened steels 52 – 58 HRC			3700	0,25	H2
Hardened steels 58 – 62 HRC			4300	0,25	H3
Hardened cast iron 50 – 60 HRC			3500	0,25	H4
Thermoplasts and duroplasts, without abrasive fillers			150	0,2	O1, O2
Fibre-reinforced plastics			300	0,3	O3, O4, O5
Graphite			400	0,25	O6

Comments:

The information consists of guideline values and relate to neutral cutting edge geometry.

The condition of the workpiece material and the cutting edge geometry have considerable influence on the cutting forces.

Workpiece material comparison table

Material group	Machining group	Germany					Manufacturer designation
		W. no. DIN	W. no. DIN EN	DIN	DIN EN		
		Building and construction steels					
P	P1	1.0401		C 15	C15		
	P1	1.0402		C 22	C22		
	P2	1.0501		C 35	C35		
	P2	1.0503		C 45	C45		
	P4	1.0535		C 55	C55		
	P4 / P5	1.0601		C 60	C60		
	P6	1.0715		9 SMn 28	11SMn30		
	P6	1.0718		9 SMnPb 28	11SMnPb30		
	P6	1.0722		10 SPb 20	10SPb20		
	P6	1.0726		35 S 20	35S20		
	P6	1.0736		9 SMn 36	11SMn37		
	P6	1.0737		9 SMnPb 36	11SMnPb37	Ledloy	
	P7 / P10	1.0904			55Si7		
	P7 / P10	1.0961		60 SiCr 7	S340MGC, 60SiCr7		
	P1	1.1141		Ck 15	C15E		
	P7 / H2	1.1157		40 Mn 4	40Mn4		
	P1 / P3	1.1158		Ck 25	C25E		
	P7	1.1167		36 Mn 5	36Mn5		
	P7	1.1170		28 Mn 6	28Mn6		
	P2	1.1183		Cf 35	C35G		
P2	1.1191		Ck 45	C45E			
P4 / P5	1.1203		Ck 55	C55E			

Great Britain		France	Italy	Sweden	Spain	Japan	USA
B.S.	EN	AFNOR	UNI	SS	UNE	JIS	AISI / SAE
080M15, 144917CS, 040A15, 080A15		C18RR, XC18	C15, C16, 1C15	1350	F.111	S 15 C, JIS S 15C	J 409 Grade 1015
040 A 15, 055 M 15, En 2, 22 CS, 22 HS, C 22, 070 M 20	2D, 2	AF42C20, XC25, 1C22	C20, C21	1450	1C22, F112	S 20 C, S22C, JIS S 20C	
080A32, 080A35, 080M36, 1449.40CS		C35, 1C35, AF55C35	C35, 1C35	1572, 155	F.113	S 35 C	
060A47, 080M46, 1449.50HS, 1449.50CS		1C45, AF 65 C 45	C45, 1C45	1650	F.114	JIS S 45C	
070M55, 5770-50	9	C54, 1C55, AF 70 C 55	C55, 1C55	1655	F.115	S 55 C	
060A62, 5770-60, 1449 60HS.CS		C60, 1C60, AF70C55	C60, 1C60		F.115	S 58 C	
230M07		S250	CF9Mn28	1912	F.2111 - 11SMn28	JIS SUM22	
		S250Pb	CF9SMnPb28	1914	F.2112 - 11SMnPb28	SUM22L, SUM23L, SUM24L	12L13, 12L14, J 403 Grade 12L14, J 1397 Grade 12L14
212M36		35MF6		1957	F.210G		J 403 Grade 1141
240M07	1B	S300	CF9SMn36		F.2113 - 12 SMn 35	SUM 25	J 403 Grade 1213, J 403 Grade 1215, J 1392 Grade 1213
		S300Pb	CF9SMnPb36	1926	F.2114 - 12 SMnPb 35		J 403 Grade 12L14, J 1397 Grade 12L14
250A53	45	55S7		2085	F.1440 - 56 Si 7		
250A61		60SC7			F.1442 - 60 SiCr 8		
040A15, 080M15, S14, CS17	32C			1370	F.1511 - C 16 k, F.1110 - C 15 k	S 15, S 15 CK, JIS S 15 C	
150M36	15	35M5					1035, 1041
070M26		2C25			F.1120 - C 25 k, C25K (F1120)	S 25 C, S 28 C	
150M36	15 B	40M5		2120	F.1203 - 36 Mn5	SMn 438 (H), SCMn 3	
150M28, 150M19, S92	14A, 14B	20M5	C28Mn		28Mn6	SCMn1	1027
060A35, 080A35		XC38H1TS	C36, C38			S 35 C	
080M46, 060A47		C45RR, XC42H1, XC45, 2C45, XC48, XC48H1		1672	F1140-C45k, F1142-C48k	S 45 C, S 48 C	
060A57	9	XC55H1, 2C55, XC54		1655	F.1150 - C 55 k	S 55 C	

Workpiece material comparison table

Material group	Machining group	Germany					Manufacturer designation
		W. no. DIN	W. no. DIN EN	DIN	DIN EN		
P	Building and construction steels (continued)						
	P2 / P3	1.1213		Cf 53	C53G		
	P4 / P5	1.1221		Ck 60	C60E		
	P4 / H1	1.1274		Ck 101	C101E, C100S		
	P11	1.3401		X 120 Mn 12	X120Mn12		
	P7 / H2	1.3505		100 Cr 6	100Cr6		
	P7	1.5415		15 Mo 3	16Mo3		
	P3	1.5423		16 Mo 5	16Mo5		
	P7	1.5622		14 Ni 6	14Ni6		
	P11	1.5662		X 8 Ni 9	X8Ni9		
	P11	1.5680		12 Ni 19	X12Ni5, 12Ni19		
	P9	1.5710		36 NiCr 6	36NiCr6		
	P7	1.5732		14 NiCr 10	14NiCr10		
	P7	1.5752		14 NiCr 14	15NiCr13		
	P7 / P9	1.6511		36 CrNiMo 4	36CrNiMo4		
	P7	1.6523		20NiCrMo2-2	21NiCrMo2		
	P9	1.6546		40 NiCrMo 22	40NiCrMo2-2, 40NiCrMo2KD		
	P7 / P9	1.6582		34 CrNiMo 6	34CrNiMo6		
	P7	1.6587		17 CrNiMo 8, 17 CrNiMo 6, 17 CrNiMo 6 BG	17CrNiMo6, 18CrNiMo7-6		
	P7	1.6657		14 NiCrMo 134	14NiCrMo13-4		
P7	1.7015		15 Cr 3	15Cr2KD			

Great Britain		France	Italy	Sweden	Spain	Japan	USA
B.S.	EN	AFNOR	UNI	SS	UNE	JIS	AISI / SAE
060A52, 070M55		XC48H1TS				S 50 C	1050, 1055
060A62, 070M60, CS60		C60RR, XC60, 2C60		1665, 168	F.511, F.512	S 58 C	
060A96, 5770-95, CS95		C100RR, C100, XC100, E 100		1870		SUP4	
		Z120M12, Z120Mn12		2183	F.82551-AM-X 120 Mn 12	SCMnH1, SCMnH11	
BL3, 534A99, 535A99, 2S135, S135		Y100C6, 100C6, 100Cr6	100Cr6	2258	F.5230 100 Cr6, F.1310-100 Cr 6, F.131	SUJ 2, SUJ 4	L3
1501-240, 1503-243B, 3606-243, 3059-243		15D3, 15Mo3	16Mo3 (KG KW)	2912	F.2601-16 Mo 3		
1503-245-420			16Mo5KG, 16Mo5KW		F.2602-16Mo5	SB 450 M, SB 480 M	
		16N6, 15N6, 15Ni6	14Ni6KG, 14Ni6KT		F.2641-15Ni6		
1501-509;510, 3603-509LT, 1502-502-650, 509-690, 1503-509-690		Z8N9, 9Ni490	X10Ni9, X12Ni09		F.2645-X8 Ni09	SL9N53(60)	
		Z18N5, 5Ni390					2515, 2517
640A35		35NC6				SNC 236	
		14NC11	16NiCr11		F.1540-15NiCr11	SNC 415 (H)	
655M13, 655A12, 655H13	36A, 36B	14NC11, 12NC15, 14NC12, 13NiCr14				SNC 815 (H), SNC22, JIS SNC 815	3310, 3415, 9314
816M40	110	40NCD3, 36CrNiMo4, 35NCD5	38NiCrMo7 (KB)		F.1280-35NiCrMo4		
805H20, 805M20, 806M20	362	20NCD2, 22NCD2	20NiCrMo2	2506	F1552-20NiCrMo2, F1534-20NiCrMo3	SNCM 220 (H)	J 1268 Grade 8620H
311-Type7		40NCD2	40NiCrMo2 (KB)		F1204-40NiCrMo2, F1205-40NiCrMo2DF	SNCM 240	
816M40, 817M40	24	35NCD6, 34CrNiMo6, 34CrNiMo8	35NiCrMo6KB	2541	F1272-40NiCrMo7, 34CrNiMo6	SNCM 447, JIS SNC M447	
820A16		18NCD6	18NiCrMo7		F.1560-14 NiCrMo13, F.156		
832H13, 832M13, S157	36C	16NCD13	15NiCrMo13		F1560-14NiCrMo13, F.1569-14NiCrMo131		
523M15	206	12C3, 15Cr2, 18C3				SCr 415 (H)	

Workpiece material comparison table

Material group	Machining group	Germany					Manufacturer designation
		W. no. DIN	W. no. DIN EN	DIN	DIN EN		
		Building and construction steels (continued)					
P	P7 / P8	1.7033		34 Cr 4	34Cr4		
	P7 / P9	1.7035		41 Cr 4	41Cr4		
	P9	1.7045		42 Cr 4	42Cr4		
	P7	1.7131		16 MnCr 5	16MnCr5		
	P7 / P9	1.7176		55 Cr 3	55Cr3		
	P8	1.7218		25 CrMo 4	25CrMo4		
	P7 / P9	1.7220		34 CrMo 4	34CrMo4		
	P7 / P9	1.7223		41 CrMo 4	41CrMo4		
	P7 / P9	1.7225		42 CrMo 4	42CrMo4		
	P7	1.7262		15 CrMo 5	15CrMo5		
	P7	1.7335		13 CrMo 4 4	13CrMo4-5		
	P7 / P10	1.7361		32 CrMo 12	32CrMo12		
	P7	1.7380		10 CrMo 9 10	10CrMo9-10		
	P7	1.7715		14 MoV 6 3	14MoV6-3		
	P7 / P9	1.8159		50 CrV 4	51CrV4		
	P7	1.8509		41 CrAlMo 7	41CrAlMo7	Nitraloy 135	
P7 / P10	1.8523		39 CrMoV 13 9	40CrMoV13-9			

Great Britain		France	Italy	Sweden	Spain	Japan	USA
B.S.	EN	AFNOR	UNI	SS	UNE	JIS	AISI / SAE
530A32, 530H32, 530M32		32C4, 34Cr4	34Cr4(KB)		F.8221-35 Cr 4, F.224	SCr 435 (H)	
530M40, 530A40, 530H40	18	42C4, 41Cr4	41Cr4, 41Cr4KB		38Cr4, 38Cr41, 42Cr4, F.1202-42Cr4	SCR4, SCr 440 (H)	
530A40	18	42C4, 42C4TS	41Cr4	2245	F1201, F1202, F1206, F.1202-42Cr4	SCR4, SCr 440 (H), SCr 440	5140, 5140H
527M17, 590H17, 590M17		16MC5, 16MC4, 16MnCr5	16MnCr5	2511, 2173	F.1515-16 MnCr5, F.151		J 1268 Grade 4118H
525A58, 525A60, 525H60	48	55Cr3, 55C3	55Cr3	2253	F.1431-55 Cr3, F.143	SUP 9 (A)	
1717CDS110, 708A25		25CD4, 25CrMo4	25CrMo4 (KB)	2225	F8372-AM26CrMo4, F8330-AM25CrMo4, F1256-30CrMo4-1, F.222	SCM420, SCM430, SCCrM1	
708A37	19B	35CD4, 34CrMo4, 35CD4 / 34CrMo5	34CrMo4KB, 35CrMo4, 35CrMo4F	2234	F8331-AM34CrMo4, F8231-34CrMo4, F1250-35CrMo4, F1254-35CrMo4DF, F.125	SCM 432, SCCrM 3, SCM 435 H	4135, 4137, J 1268 Grade 4135H
708M40, 3111-5.1		42CD4TS	41CrMo4		F8332-AM42CrMo4, F8232-42CrMo4, F1252-40CrMo4	SCm 440, JIS SCM 440	
708A42, 708M40, 709M40	19A	42CD4, 42CrMo4	38CrMo4KB, 42CrMo4, G40CrMo4	2244	F8332-AM42CrMo4, F8232-42CrMo4, F1252-40CrMo4	SCM 440 (H), SNB 7, JIS SCM 440	
		12CD4			F.1551-12CrMo4	SCM 415 (H)	
620-440, 1503-620-440, 1502, 620-470, 3606-620, 620-540, 3604-620-440		15CD3.05, 15CD4.05	14CrMo3, 16CrMo3	2216	F.2631-14CrMo45	SFVA F 12	A387 Grade 12Cl2
722M24	40B	30CD12	32CrMo12	2240	F.124.A		
3059-622-490, 3606-622, 1502-622, 3604-622, 622Gr.31, 622Gr.45		12CD9.10, 10CrMo9-10, 10CrMo9-11	12CrMo9 (KW KG), G14CrMo9, 10	2218	TU.H	SFVAF22A, BSCMV4, SCPH32-CF	A387 Grade 22, A387 Grade 22Cl2
1503-660-460, 3604-660					F.2621-13 MoCrV6		
735A50, 735A51, 735H51, 735M50	47	50CV4, 51CrV4, 50CrV4	50CrV4	2230	F.1430-51CrV4	SUP 10	
905M39	41B	40CAD6.12	41CrAlMo7	2940	F.1740-41CrAlMo7	SACM 645, JIS SACM 645	
897M39	40C						

Workpiece material comparison table

Material group	Machining group	Germany					Manufacturer designation
		W. no. DIN	W. no. DIN EN	DIN	DIN EN		
P	Stainless and heat-resistant steels						
	P14 / P15	1.4000		X 7 Cr 13	X6Cr13		
	P14	1.4001		X 7 Cr 14	X7Cr14		
	P14 / P15	1.4006		X 10 Cr 13, X 12 Cr 13	X12Cr13, X10Cr13		
	P14	1.4016		X 6 Cr 17	X6Cr17		
	P15	1.4027		G-X 20 Cr 14	GX20Cr14		
	P15	1.4034		X 46 Cr 13	X46Cr13		
	P15	1.4057		X 20 CrNi 17 2	X19CrNi17-2, X17CrNi16-2		
	P14 / P15	1.4104		X 12 CrMoS 17	X14CrMoS17		
	P14	1.4113		X 6 CrMo 17 1	X6CrMo17-1		
	P15	1.4313		X 4 CrNi 13 4	X3CrNiMo13-4		
	P15	1.4718		X 45 CrSi 9 3	X45CrSi9-3-1		
	P14	1.4724		X 10 CrAl 13, X 10 CrAlSi 13	X10CrAlSi13, X10CrAl13		
	P14	1.4742		X 10 CrAl 18, X 10 CrAlSi 18	X10CrAl18, X10CrAlSi18		
	P15	1.4747		X 80 CrNiSi 20	X80CrNiSi20	Sil XB	
	P14	1.4762		X 10 CrAl 24, X 10 CrAlSi 25	X10CrAl24, X10CrAlSi25		
	Tool steels						
	P4	1.1545		C 105 W 1	C105U		
	P4	1.1663		C 125 W	C125W, C125U		
	P7 / H2	1.2067		100 Cr 6	99Cr6, 102Cr6		
P11 / H3	1.2080		X 210 Cr 12	X210Cr12			
P11 / H1	1.2344		X 40 CrMoV 5 1	X40CrMoV5-1			
P11 / H3	1.2363		X 100 CrMoV 5 1	X100CrMoV5-1			
P7 / H2	1.2419		105 WCr 6	107WCr5, 105WCr6, 100WCr6			

Great Britain		France	Italy	Sweden	Spain	Japan	USA
B.S.	EN	AFNOR	UNI	SS	UNE	JIS	AISI / SAE
403S17		Z6013, Z6Cr13, Z8C12	X6Cr13	2301	F.3110-X6 Cr13	SUS403, SUS410S, SUS429	
403S17		Z3014, Z8C13FF	X6Cr13		F.8401-AM-X12 Cr13	SUS403, SUS410S, SUS429	403, 410S, 429
410S21, 410C21, ANC1A		Z12C13, Z12Cr13, Z10C13	X12Cr13, X10Cr13	2302	F.3401-X12 Cr13	SUS 410, JIS SUS 410	410
430S15, 430S17, 430S18	60	Z8C17, Z6Cr17	X8Cr17	2320	F.3113-X8 Cr17	SUS 430	
ANC1B, ANC1C, 420C24, 420C29		Z20C13M				SCS 2	
420S45		Z40C14, Z40Cr14, Z38C13M, Z44C14	X40Cr14		F.3405-X46 Cr13		
431S29, 6S80, S80	57	Z15CN16.02	X16CrNi16	2321	F.3427-X15 CrNi16, F.313, F3427-X19CrNi172	SUS 431, JIS SUS 431	
		Z10CF17	X10CrS17	2383	F3117-X10CrS17, F3413-X14CrMoS17	SUS 431, SUS430F	430F, J 405 Grade 51435
434S17		Z8CD17.01	X8CrMo17	2325	F3116-X6CrMo171	SUS 434	
425C11, 425C12		Z5CN13.4, Z4CND13.4M, Z6CN13-4, Z8CD17-01	GX6CrNi13 04	2385		SCS 5, SCS 6	CA6
401S45	52	Z45CS9	X45CrSi8		F.3220-X 4 ScrSi 09-03	SUH 1	HNV3
403S17		Z10C13, Z13C13	X10CrAl12		F.13152-X 10 CrAl13		405
430S15	60	Z10CAS18, Z12CAS18	X8Cr17		F.3153-X 10 CrAl 18	SUH 21	430
443S65	59	Z80CSN20.02			F.3222-X 80CrSiNi20-02	SUH 4	HNV6
		Z10CAS24, Z12CAS25	X16Cr26	2322	F.3154-X 10 CrAl24	SUH 446	446
		C105E2U, Y1105	C100KU	1880	F515, F516	SK 3 (TC105)	W110
		Y2120			F.5123 C120		W112
BL3, 534A99		100Cr6RR, 100C6, Y100C6		2258	F.5230 100 Cr6, F.1310 - 100 Cr6, F.131	SUJ 2, SUJ 4	L3, 52100, L1
BD3		X200Cr12, Z200C12	X205Cr12KU		F.5212 X210 Cr12	SKD 1, SKS	D3
BH13		X40CrMoV5, Z40CDV5	X40CrMoV511KU	2242	F.5318 X40 CrMoV5	SKD 61	H13
BA2		X100CrMoV5, Z100CDV5	X100CrMoV51KU	2260	F.5227 X100 CrMoV5	SKD 12, JIS SKD 12	A2
		105WC13	107WCr5KU	2140	F.5233 105 WCr5, F.523	SKS 2, SKS 3, SKS 31	

Workpiece material comparison table

Material group	Machining group	Germany					Manufacturer designation
		W. no. DIN	W. no. DIN EN	DIN	DIN EN		
P	Tool steels (continued)						
	P14 / H3	1.2436		X 210 CrW 12	X210CrW12-1, X210CrW12		
	P7 / H2	1.2542		45 WCrV 7	45WCrV8, 45WCrV7		
	P11 / P13	1.2581		X 30 WCrV 9 3	X30WCrV9-3		
	P14 / H3	1.2601		X 165 CrMoV 12	X165CrMoV12		
	P7 / P10 / H1	1.2713		55 NiCrMoV 6	55NiCrMoV6		
	P7 / H3	1.2833		100 V 1	100V1		
	P11 / H3	1.3243		S 6-5-2-5	HS6-5-2-5		
	P11 / H3	1.3255		S 18-1-2-5	HS18-1-2-5		
	P11 / H3	1.3343		S 6-5-2	HS6-5-2		
	P11 / H3	1.3348		S 2-9-2	HS2-9-2		
P11 / H3	1.3355		S 18-0-1	HS18-0-1			
M	Stainless and heat-resistant steels						
	M1	1.4301		X 5 CrNi 18 10	X5CrNi18-10		
	M1	1.4305		X 10 CrNiS 18 9	X8CrNiS18-9		
	M1	1.4306		X 2 CrNi 19 11	X2CrNi19-11		
	M1	1.4308		G-X 6 CrNi 18 9	GX5CrNi19-10		
	M2	1.4310		X 12 CrNi 17 7	X9CrNi18-8, X10CrNi18-8		
	M1	1.4311		X 2 CrNiN 18 10	X2CrNiN18-10		
	M1	1.4401		X 5 CrNiMo 17 12 2	X5CrNiMo17-12-2, X4CrNiMo17-12-2, X5CrNiMo18-10		

Great Britain		France	Italy	Sweden	Spain	Japan	USA	
B.S.	EN	AFNOR	UNI	SS	UNE	JIS	AISI / SAE	
		X210CrW12-1, Z210CW12-01, Z 210 CW 12	X215CrW121KU	2312	F.5213 X210 CrW12, F.521		D6	
BS1		45WCrV8, 45WCrV20	45WCrV8KU	2710	F.5241 45 WCrSi 8, F.524, F524145WCrSi 8		S1	
BH21		X30WCrV9, Z30WCv9	X30WCrV93KU		F.5323 X30 WCrV9	SKD 5	H21	
			X165CrMoW12KU	2310	F.5211 X160 CrMoV12			
BH224					F.528, F520S		L6	
BW2		C105E2UV1, Y1105V, 100V2	102V2KU			SKS 43	W210	
BM35		Z85WDKCV06- 05-05-04-02, Z90WDKCV06- 05-05-04-02	HS6-5-2-5	2723	F.5613 6-5-2-5	SKH 55	M35	
BT4		Z80WKCV18- 05-04-01	HS18-1-1-5		F.5530 18-1-1-5	SKH 3	T4	
BM2		Z85WDCV06- 05-04-02	HS6-5-2-5	2722	F.5603 6-5-2	SKH 51	M2	
		Z100DCVW09- 04-02-02	HS2-9-2	2782	F.5607 2-9-2		M7	
BT1		Z80WCV18-04-01	HS18-0-1		F.5520 18-0-1	SKH 2	T1	
	304S15, 304S16, 304S31, 304S11, 304S17, LW21, LWCF21	58E	Z4CN19-10FF, Z5CN17-08, Z6CN18-09, Z7CN18-09	X5CrNi18 10	2332, 233	F.3451-X5 CrNi18-10, F.314, F.3504-X6CrNi19 10, F3504-X5CrNi1810	SUS 304	304, 304H
	303S21, 303S22, 303S31	58M	Z10CNF18.09, Z8CNF18-09	X10CrNi18 09	2346	F.3508-X10CrNi18-09	SUS 303, JIS SUS 303	J 405 Grade 30303
	304S11, LW20, LWCF20, S536, T74, 304C12 (LT196), 305S11		Z1CN18-12, Z2CN18-10, Z3CN19.10M, Z3CN18-10, Z3CN19-11, Z3CN19-11FF	X3CrNi18 11, X2CrNi18 11, GX2CrNi19 10	2352	F.3503-X 2CrNi19-10, F3503-X 2CrNi18-10	JIS SCS 19, JIS SUS 304L	
	304C15, 304C15 (LT196)		Z6CN18.10M				SCS 13	
	301S21, 301S22, 302S26		Z12CN17.07, Z12CN18.07, Z11CN17-08, Z11CN18-08, Z12CN18-09	X12CrNi17 07	2331	F.3517-X12CrNi17 07	SUS 301	301
	304S62		Z3CN18-07Az, Z3CN18-10AZ	X2CrNi18 11	2371	F3541-X2CrNi1810	SUS 304 LN	304LN
	316S13, 316S17, 316S19, 316S31, 316S33, 316S16		Z6CND17.11, Z3CD17-11-01, Z6CND17-11, Z6CND17-11-02FF, Z7CND17-11-02, Z7CND17-12-02	X5CrNiMo17 12	2347	F.3543-X5CrNiMo17-12, F.3543-X6 CrNiMo17- 12-03, F3543-X5CrNiMo17-122	SUS 316	316

Workpiece material comparison table

Material group	Machining group	Germany					Manufacturer designation
		W. no. DIN	W. no. DIN EN	DIN	DIN EN		
M	Stainless and heat-resistant steels (continued)						
	M1	1.4408		G-X 6 CrNiMo 18 10	GX5CrNiMo19-11-2		
	M1	1.4429		X 2 CrNiMoN 17 13 3	X2CrNiMoN17-13-3		
	M1	1.4435		X 2 CrNiMo 18 14 3, X 2 CrNiMo 18 12	X2CrNiMo18-14-3		
	M1	1.4438		X 2 CrNiMo 18 16 4	X2CrNiMo18-15-4		
	M1	1.4460		X 4 CrNiMoN 27 5 2	X3CrNiMoN27-5-2		
	M1	1.4541		X 6 CrNiTi 18 10	X6CrNiTi18-10		
	M1	1.4550		X 6 CrNiNb 18 10	X6CrNiNb18-10		
	M1	1.4571		X 6 CrNiMoTi 17 12 2	X6CrNiMoTi17-12-2		
	M1	1.4581		G-X 5 CrNiMiNb 18 10	GX5CrNiMoNb19-11-2		
	M1	1.4583		X 10 CrNiMoNb 18 12	X10CrNiMoNb18-12		
	M1	1.4828		X 15 CrNiSi 20 12	X15CrNiSi20-12		
	M2	1.4871		X 53 CrMnNiN 21 9	X53CrMnNiN21-9		
	M1	1.4878		X 12 CrNiTi 18 9	X12CrNiTi18-9, X10CrNiTi18-10		
	Heat-resistant alloys, Fe basis						
	M1	1.4558		X 2 NiCrAlTi 32 20	X2NiCrAlTi32-20		
	M1	1.4563		X 1 NiCrMoCu 31 27 4	X1NiCrMoCu31-27-4		
	M1	1.4864		X 12 NiCrSi 36 16	X12NiCrSi36-16, X12NiCrSi35-16	Incoloy DS	
	M1	1.4958		X 5 NiCrAlTi31-20	X5NiCrAlTi31-20		
	M1	1.4977			X 40 CoCrNi 20 20		

Great Britain		France	Italy	Sweden	Spain	Japan	USA
B.S.	EN	AFNOR	UNI	SS	UNE	JIS	AISI/ SAE
316C16, 316C16 (LT196), ANC4B					F.8414-AM-X7 CrNiMo20 10	SCS 14	
316S62, 316S63		Z2CND17.13Az	X2CrNiMoN17 13	2375	F3543- X2CrNiMoN17133	SUS 316 LN	316LN
316S11, 316S13, 316S14, 316S31, LW22, LWCF22, 316S12		Z2CND17.13, Z3CND17-12-03, Z3CND18-14-03	X2CrNiMo17 13	2353	F.3533-X2 CrNiMo 17- 12-03, F.3534-X6 CrNiMo 17- 12-03		316L
317S12		Z2CND19.15, Z2CND19-15-04, Z3CND19-15-04	X2CrNiMo18 16	2367	F3539-X2CrNiMo18164	SUS 317 L	317L
		Z3CND25-07Az, Z5CND27-05Az		2324	F3309-X8CrNiMo27-05, F3552-X8CrNiMo266	SUS 329 J1	
321S12, 321S31, 321S51 (1010, 1105) LW24, LWCF24	58B, 58C	Z6CNT18.10	X6CrNiTi18 11	2337	F.3553-X7 CrNiTi 18-11, F.3523-X 6 CrNiTi 18-11, 09 Ch 18N10T, F3523-X6CrNiTi1810	SUS 321, JIS SUS 321	
347S20, 347S31, 347S51, ANC3B	58F, 58G	Z6CNNb18.10	X6CrNiNb18 11, X8CrNiNb18 11	2338	F.3552-X 7 CrNiNb 18-11, F.3524-X 67 CrNiNb 18-11, F3524-X6CrNiNb1810	SUS 347	
320S31, 320S17, 320S18	58J	Z6CNDT17.12	X6CrNiMoTi17 12	2350	F.3552-X 6 CrNiMoTi17-12-03, F3535- X6CrNiMoTi17122	SUS 316 Ti	316Ti, 326Ti
318C17, ANC4C		Z4CNDNb18.12M	GX6crNiMoNb20 11 X6CrNiMoNb17 13			SCS 22	
309S24		Z15CNS20.12, Z17CNS20-12, Z9CN24-13	X16CrNi23 14		F3312-X15CrNiSi20-12	SUH 309	309
349S54		Z52CMN21.09, Z53CMNS21-09Az, Z53CMN21-09Az	X53CrMnNiN21 9		F.3217-X53 CrMnNiN 21-09	SUH 35, SUH 36	EV8
321S20, 321S51	58B, 58C	T6CNT18.12 (B), Z6CNT18-10		2337	F.3523-X 6CrNiTi 18 11	SUS 321	321
NA17		Z12NCS37.18, Z12NCS35.16, Z20NCS33-16			F.3313-X12 CrNi 36-16	SUH 330	
		Z 42 CNKDOWNb					

Workpiece material comparison table

Material group	Machining group	Germany					Manufacturer designation
		W. no. DIN	W. no. DIN EN	DIN	DIN EN		
K	Grey cast iron						
	K3	0.6010	EN-JL1010	GG-10, GG 10	EN-GJL-100		
	K3	0.6015	EN-JL1020	GG-15, GG 15	EN-GJL-150		
	K3	0.6020	EN-JL1030	GG-20, GG 20	EN-GJL-200		
	K3	0.6025	EN-JL1040	GG-25, GG 25	EN-GJL-250		
	K4	0.6030	EN-JL1050	GG-30, GG 30	EN-GJL-300		
	K4	0.6035	EN-JL1060	GG-35, GG 35	EN-GJL-350		
	K4	0.6040		GG-40, GG 40	EN-GJL-400		
	K4	0.6660		GGL-NiCr 20 2			
	K4			GG-26Cr, GG 26Cr	EN-GJL-260 Cr		
	K7			GGV 45	EN-GJV-450		
	Ductile cast iron						
	K5	0.7040	EN-JS1030	GGG-40	EN-GJS-400-15		
	K6	0.7050	EN-JS1050	GGG-50	EN-GJS-500-7		
	K6	0.7060	EN-JS1060, EN-JS 1092	GGG-60	EN-GJS-600-3, EN-GJS-600-3U		
	K6	0.7070	EN-JS1070, EN-JS 1102	GGG-70	EN-GJS-700-2, EN-GJS-700-2U		
	Malleable cast iron						
	K1	0.8035	EN-JM 1010	GTW-35, GTW-35-04	GTW-35-04, EN-GJMW-350-4		
	K1	0.8040	EN-JM 1030	GTW-40-05, GTW-40	EN-GJMW-400-5, GTW-40-05		
	K1	0.8045	EN-JM 1040	GTW-45-07, GTW-45	EN-GJMW-450-7		
	K1	0.8135	EN-JM 1130	GTS-35-10, GTS-35	EN-GJMB 350-10		
	K1	0.8145	EN-JM 1140	GTS-45-06, GTS-45	EN-GJMB 450-6, GTS-45-06		
	K1	0.8155	EN-JM 1160	GTS-55-04, GTS-55	EN-GJMB 550-4, GTS-55-04		
	K2	0.8165	EN-JM 1180	GTS 65-02, GTS-65	EN-GJMB 650-2, GTS-65-02		
	K2	0.8170	EN-JM 1190	GTS 70-02, GTS-70	EN-GJMB 700-2, GTS-70-02		

	Great Britain		France	Italy	Sweden	Spain	Japan	USA
	B.S.	EN	AFNOR	UNI	SS	UNE	JIS	AISI / SAE
			Ft10D, FGL100	G10	0110	FG 10	FC 100, FC10	
	Grade 150		Ft15D, FGL150	G15	0115	FG 15	FC 150	
	Grade 220		Ft20D, FGL200	G20	0120	FG 20	FC 200, FC20	
	Grade 260		Ft25D, FGL250	G25	0125	FG 25	FC25, FC 250	
	Grade 300		Ft30D, FGL300	G30	0130	FG 30	FC 300	
	Grade 350		Ft35D, FGL350	G35	0135	FG 35	FC 350	
	Grade 400		Ft40D, FGL400		0140			
	L-NiCr20 2		L-NC 20 2		0523			
	420 / 12		FGS 400-12	GS400-12	0717		FCD 400, FCD40	
	500 / 7		FGS 500-7	GS500-7	0727		FCD 500, FCD50	
	600 / 3		FGS 600-3	GS600-3	0732		FCD 600, FCD60	
	700 / 2		FGS 700-2	GS700-2	0737		FCD 700, FCD70	
	W 35-04		MB 35-7				FCMW 330	
	W 410 / 4		MB 40-10				FCMW 350	
	45-07		MB 45-7				FCMWP 440	
	B 340 / 12		MN 35-10		0815		FCMB 340	
	P 440 / 7, P 45-06		MP 50-5		0854			
	P 540 / 5, P 55-04		MP 60-3		0856			
	P 65-02				0862			
	P 70-02		MP 70-2		0862			

Workpiece material comparison table

Material group	Machining group	Germany					Manufacturer designation
		W. no. DIN	W. no. DIN EN	DIN	DIN EN		
N	Aluminium alloys						
	N1	3.0255	EN AW-1050A	Al99.5	Al99.5		
	N4	3.1371	EN AC-21000	G-AlCu4TiMg	G-AlCu4TiMg		
	N2	3.1655	EN AW-2011	AlCuBiPb	AlCu6BiPb		
	N2	3.1734		Y-Legierung	AlCu4Mg1.5Ni2, WL 3.1734		
	N4	3.2371	EN AC-42100	G-AlSi7Mg	G-AlSi7Mg, AlSi7Mg		
	N4	3.2373	EN AC-43300	G-AlSi9Mg	G-AlSi9Mg, AlSi9Mg		
	N4	3.2381	EN AC-43000	G-AlSi10Mg	G-AlSi10Mg, AlSi10Mg		
	N4	3.2382	EN AC-43400	GD-AlSi10Mg	AlSi10Mg(Fe)		
	N4	3.2383	EN AC-43200	G-AlSi10MgCu	G-AlSi10MgCu, AlSi10Mg (Cu)		
	N3	3.2581	EN AC-44200	G-AlSi12	G-AlSi12, AlSi12		
	N3	3.2582	EN AC-44300	GD-AlSi12	GD-AlSi12, AlSi12 (Fe)		
	N3	3.2583	EN AC-47000	G-AlSi12 (Cu)	G-AlSi12 (Cu)		
	N2	3.3315	EN AW-5005A	AlMg1	AlMg1C		
	N3	3.3561	EN AC-51300	G-AlMg5	G-AlMg5		
	N2	3.4345	EN AW-7022	AlZnMgCu0.5	AlZnMgCu0.5		
	Copper alloys						
	N7	2.0240	CW502L	CuZn15	CuZn15	Medium red tombac, Gold tombac	
	N7	2.0265	CW505L	CuZn30	CuZn30	Half tombac, Soldered brass, Cartridge brass, Polished copper, Metarsic	
	N7	2.0321	CW508L	CuZn37	CuZn37	Pressed brass, Etching quality, Tuned brass, Soft brass, Stamped brass	
N7	2.0592	CC765S	G-CuZn35Al1, GK-CuZn35Al1, GZ-CuZn35Al1	CuZn35Mn2Al1Fe1-C			
N7	2.0596	CC764S	G-CuZn34Al2, GK-CuZn34Al2, GZ-CuZn34Al2	CuZn34Mn3Al2Fe1-C			
N7	2.0966	CW307G	CuAl10Ni5Fe4	CuAl10Ni5Fe4			
N7	2.0975	CC333G	G-CuAl11Ni, G-CuAl10Ni	G-CuAl11Ni			
N7	2.1050	CC480K	G-CuSn10Zn	CuSn10-C			

	Great Britain		France	Italy	Sweden	Spain	Japan	USA
	B.S.	EN	AFNOR	UNI	SS	UNE	JIS	AISI / SAE
	1B		A5	4507	4007	L-3051	A1x1, A1050	1050A
			A-U5GT			L-2140	AC1B	
	FC1		A-U5PbBi	6362	4355	L-3182	A2011	
	LM14		A-U4NT	3045		L-2150	AC5A	
	2L99, LM25		A-S7G0.3	7257	4244	L-2651	AC4C, JIS AC4 CH (AL 9)	
			A7-S10G	3051	4253		AC4A, JIS AC4 A (AL 4)	
	LM9		A-S10G	3051	4253	L-2560, L-2561	JIS AC4 A (AL 4V)	
	LM9		A-S10G	3051	4253	L-2560, L-2561	AC4A	
			A-S9GU				JIS ADC3 (AL 4)	
	LM6		A-S13	4514	4261	L-2520, L-2521	AC3A	
	LM6, LM20		A-S13, A-S12	4514, G-AISI13	4261	L-2520, 21	AC3A	
	LM20		A-S12U	3048	4260	L-2530	ADC1 (AK 12), AC3A (AL 12)	413.1
	N41		A-G0, 6	5764	4106	L-3350	A2x8, A5005	5005A
	N6, LM5		A-G6	3058	4146	L-3320	JIS AC7A (AL28)	5056A, 514.1
			A-Z5GU0.6					
	CZ 102		CuZn15				C2300	
	CZ 106		CuZn30				C2600	
	CZ 108		CuZn37				C2720	
	HTB 1							
	CA 104		CuAl9Ni5Fe3Mn, U-A10N					
	AB2		CuAl11Ni5Fe	G-CuAl11Fe4Ni4				
	G1, CT1							

Workpiece material comparison table

Material group	Machining group	Germany					Manufacturer designation
		W. no. DIN	W. no. DIN EN	DIN	DIN EN		
N	Copper alloys (continued)						
	N7	2.1052	CC483K	G-CuSn12, GZ-CuSn12, GC-CuSn12	CuSn12-C		
	N9	2.1090	CC493K	G-CuSn7ZnPb, GZ-CuSn7ZnPb, GC-CuSn7ZnPb	CuSn7Zn4Pb7-C	Red brass 7	
	N9	2.1096	CC491K	G-CuSn5ZnPb	CuSn5Zn5Pb5-C	Red brass 5	
	N9	2.1098	CC490K	G-CuSn2ZnPb	CuSn3Zn8Pb5-C	Alloy 5A	
	N9	2.1176	CC495K	G-CuPb10Sn, GZ-CuPb10Sn, GC-CuPb10Sn	CuSn10Pb10-C		
	N9	2.1182	CC496K	G-CuPb15Sn, GZ-CuPb15Sn, GC-CuPb15Sn	CuSn7Pb15-C		
	N9	2.1188	CC497K	G-CuPb20Sn	CuSn5Pb20-C		
	N7	2.1293	CW106C	CuCrZr	CuCr1Zr		
	N7			CuAl6.5Fe2.5Sn0.25		AMPCO 8	
	N7					AMPCO 6	
	N10			CuAl13Fe4.5		AMPCO 21	
	N10					AMPCO 26	
	Magnesium alloys						
	N6	3.5101	EN-MC35110	G-MgZn 4 SE 1 Zr 1	EN-MCMgZn4RE1Zr, G-MgZn4SE1Zr1		
	N6	3.5103	EN-MC65120	G-MgSE 3 Zn 2 Zr 1	EN-MCMgRE3Zn2Zr, G-MgSE3Zn2Zr1		
	N6	3.5106	EN-MC65210	G-MgAg 3 SE 2 Zr 1	EN-MCMgRE2Ag2Zr, G-MgAg3SE2Zr1		
	N6	3.5161		MgZn6Zr, MgZn 6 Zr F 29	MgZn6Zr, MgZn6Zr F29		
	N6	3.5200		MgMn2	MgMn2		
	N6	3.5312		MgAl3Zn	MgAl3Zn		
N6	3.5470	EN-MC21320	MgAl4Si1	EN-MCMgAl4Si			
N6	3.5612		MgAl6Zn	MgAl6Zn			
N6	3.5632	EN-MC21150	G-MgAl 6 Zn 3	G-MgAl6Zn3	AZ63		
N6	3.5662		G-MgAl 6	G-MgAl6			
N6	3.5812	EN-MC21110	G-MgAl 8 Zn 1	G-MgAl8Zn1	AZ81 hp		
N6	3.5912	EN-MC21120	GD-MgAl 9 Zn 1	GD-MgAl9Zn1	AZ91		

		Great Britain		France	Italy	Sweden	Spain	Japan	USA
		B.S.	EN	AFNOR	UNI	SS	UNE	JIS	AISI / SAE
	Pb2			A53-707, CuSn12					
				CuSn7Pb6Zn4					
	LG2			CuPb5Sn5Zn5					
	LG1								
	LB2			CuPb10Sn10					
	LB1								
	LB5			CuPb20Sn5					
	CC 102				CuCrZr				
	RZ5, MAG5, MAG9, TZ6			G-Z4TR, ZH62					
	ZRE1, MAG6			G-TR3Z2					
	MSR, QE22			G-Ag2, 5					
	ZW1, ZW3, ZW6, ZW21, MAG 161, MAG 131, MAG 141, MAG 151								M1
	MAG 101, AM503			G-M2					
	AZ31, MAG 111			G-A3Z1, AZ31					52, 510
				G-A4S1					
	MAG121, AZM			G-A6Z1, AZ61					520, 531
				AZ63					
	MAG1, MAG2, AZ80, AZ81, A8			G-A9, AZ81	AZ81 hp			AZ81 hp	
	AZ91, MAG3, MAG7			G-A9Z1, AZ91	AZ91 hp				HK31

Workpiece material comparison table

Material group	Machining group	Germany					Manufacturer designation
		W. no. DIN	W. no. DIN EN	DIN	DIN EN		
S	Titanium and titanium alloys						
	S6	3.7025		Ti 1	Ti 99.8	TitaniumGrade1	
	S7	3.7115.1		TiAl 5 Sn 2	TiAl5Sn2.5		
	S6	3.7124		TiCu2	TiCu2		
	S7	3.7164, 3.7165		TiAl 6 V 4	TiAl6V4	TitaniumGrade5	
	Heat-resistant alloy Ni/Co-based						
	S3	2.4360		NiCu30Fe	NiCu30	Monel 400	
	S4	2.4375		NiCu30Al	NiCu30Al3Ti	Monel K500	
	S3	2.4630		NiCr20Ti		Nimonic 75	
	S3	2.4642		NiCr30Fe		Inconel 690, Alloy 690	
	S4	2.4668		NiCr19Fe19NbMo, NiCr19Fe19Nb5Mo3, NiCr19NbMo	NiCr19Nb5Mo3	Inconel 718, Udimet 630	
	S4	2.4669		NiCr15Fe7TiAl, Alloy X-750	NiCr15Fe7Ti2Al	Inconel X-750, Alloy X-750	
	S3	2.4856		NiCr22Mo9Nb, Alloy 625	NiCr22Mo9Nb	Inconel 625	
	S3	2.4858		NiCr21Mo, Alloy 825	NiFe30Cr21Mo3	Incoloy 825	
	H	Hardened cast iron					
H4		0.9640		G-X300CrMoNi1521	GX300CrMoNi15-2-1		
H4		0.9645		G-X260CrMoNi2021	GX260CrMoNi20-2-1		
H4		0.9650		G-X260Cr27	GX260Cr27		
H4		0.9655		G-X300CrMo271	GX300CrMo27-1		
Chilled cast iron							
H4		0.9620		G-X260NiCr42	GX260NiCr42	Ni-Hard 2	
H4		0.9625		G-X330NiCr42	GX330NiCr42	Ni-Hard 1	
H4		0.9630		G-X300CrNiSi952	GX300CrNiSi952	Ni-Hard 4	
H4		0.9635		G-X300CrMo153	GX300CrMo15-3		

Great Britain		France	Italy	Sweden	Spain	Japan	USA
B.S.	EN	AFNOR	UNI	SS	UNE	JIS	AISI / SAE
TA.1		T-35				Ti-P01	
TA.21, TA.22, TA.23, TA.24, TA.52, TA.53, TA.54, TA.55, TA.58		T-U2				Ti-P11	
TA.10, TA.11, TA.12, TA.13, TA.28, TA.56		T-A6V				Ti-P63	4911, 4928, 4935, 4954, 4965, 4967
3072-76, NA13		NU30					
3072-76, HC202, 3146, Na18							AMS 4676
HR5, 703 B, 203-4		NC 20 T					
HR 8		NC 19 FeNb					
HR 505		NC 15 FeTNb					5542G
		NC 22 FeDNB					
3072-76		NC 21 FeDU					
Grade3A, Grade3B, BS4844							
Grade3C							
Grade3D				0466			
Grade3E							
Grade2A, BS4844 (1986) 2A				0512			
Grade2B, BS4844 (1986) 2B				0513			
Grade2C, Grade2D, Grade2E, BS4844 (1986) 2E				0457			
Grade3A,B, Grade3B							

Workpiece material comparison table

Material group	Machining group	Germany					Manufacturer designation
		W. no. DIN	W. no. DIN EN	DIN	DIN EN		
0	Duroplastic						
	02					EP, Epoxide, Epoxy	
	02					Bakelite	
	02					Pertinax	
	02					Resitex	
	Thermoplastic						
	01					PMMA, Polymethylmetacrylate, Plexiglass, Acrylic glass	
	01					PC, Polycarbonate, Makrolon	
	01					PA, Polyacrylamide	

	Great Britain		France	Italy	Sweden	Spain	Japan	USA
	B.S.	EN	AFNOR	UNI	SS	UNE	JIS	AISI / SAE
								Phenolic

Hardness comparison table

Tensile strength, Brinell, Vickers and Rockwell hardness (extract from DIN 50150)





Tensile strength Rm N/mm ²	Vickers hardness HV	Brinell hardness HB	Rockwell hardness HRC
255	80	76,0	
270	85	80,7	
285	90	85,5	
305	95	90,2	
320	100	95,0	
335	105	99,8	
350	110	105	
370	115	109	
385	120	114	
400	125	119	
415	130	124	
430	135	128	
450	140	133	
465	145	138	
480	150	143	
495	155	147	
510	160	152	
530	165	156	
545	170	162	
560	175	166	
575	180	171	
595	185	176	
610	190	181	
625	195	185	
640	200	190	
660	205	195	
675	210	199	
690	215	204	
705	220	209	
720	225	214	
740	230	219	
755	235	223	
770	240	228	20,3
785	245	233	21,3
800	250	238	22,2
820	255	242	23,1
835	260	247	24,0
850	265	252	24,8
865	270	257	25,6
880	275	261	26,4
900	280	266	27,1
915	285	271	27,8
930	290	276	28,5
950	295	280	29,2
965	300	285	29,8
995	310	295	31,0
1030	320	304	32,2
1060	330	314	33,3
1095	340	323	34,4
1125	350	333	35,5
1155	360	342	36,6
1190	370	352	37,7
1220	380	361	38,8
1255	390	371	39,8
1290	400	380	40,8
1320	410	390	41,8
1350	420	399	42,7
1385	430	409	43,6

Tensile strength Rm N/mm ²	Vickers hardness HV	Brinell hardness HB	Rockwell hardness HRC
1420	440	418	44,5
1455	450	428	45,3
1485	460	437	46,1
1520	470	447	46,9
1555	480	(456)	47,7
1595	490	(466)	48,4
1630	500	(475)	49,1
1665	510	(485)	49,8
1700	520	(494)	50,5
1740	530	(504)	51,1
1775	540	(513)	51,7
1810	550	(523)	52,3
1845	560	(532)	53,0
1880	570	(542)	53,6
1920	580	(551)	54,1
1955	590	(561)	54,7
1995	600	(570)	55,2
2030	610	(580)	55,7
2070	620	(589)	56,3
2105	630	(599)	56,8
2145	640	(608)	57,3
2180	650	(618)	57,8
	660		58,3
	670		58,8
	680		59,2
	690		59,7
	700		60,1
	720		61,0
	740		61,8
	760		62,5
	780		63,3
	800		64,0
	820		64,7
	840		65,3
	860		65,9
	880		66,4
	900		67,0
	920		67,5
	940		68,0

The hardness values converted in accordance with these tables are approximate only. See DIN 50150.

Material property	Unit / test method	Symbol
Tensile strength	N/mm ²	R _m
Vickers hardness	Diamond pyramid 136° Testing force F ≥ 98 N	HV
Brinell hardness Calculated from: HB = 0.95 x HV	0.102 × F/D ² = 30 N/mm ² F = testing force in N D = sphere diameter in mm	HB
Rockwell hardness C	Diamond cone 120° Overall testing force 1471 ± 9 N	HRC

Clamping screws for indexable inserts

Screw types	Designation	Dimension	Tightening torque	
			Torx	Nm
 Clamping screws with head angle 43° for inserts with countersink	FS 322	M 2,5 x 5,7	7	0,8
	FS 258	M 3 x 5,7	8	1,5
	FS 246	M 3 x 7	8	1,5
	FS 1163	M 3,5 x 10	15	3,0
	FS 320	M 4 x 5	15	3,0
	FS 318	M 4 x 6	15	3,0
	FS 245	M 4 x 6,5	15	3,0
	FS 321	M 4 x 7	15	3,0
	FS 319	M 4 x 8	15	3,0
	FS 244	M 4 x 9	15	3,0
	FS 749	M 4 x 10,5	15	3,0
	FS 326	M 4 x 12	15	3,0
	FS 1458	M 4 x 11,3	15 IP	2,5
	FS 954	M 4,5 x 11	20	4,5
	FS 260	M 5 x 9,5	20	5,0
	FS 243	M 5 x 11	20	5,0
	FS 242	M 5 x 13	20	5,0
	FS 1165	M 5 x 12	20	6,0
	FS 1010	M 6 x 14	20	5,0
	FS 1164	M 6 x 15	25	10,0
 Fitting screws	FS 925	M 2,5 x 6,5	8	0,8
	FS 397	M 3 x 6,9	8	1,0
	FS 2070	M 3 x 6,5	8 IP	2,0
	FS 922	M 3,5 x 9,5	15	2,5
	FS 390	M 4 x 0,5 x 8,4	15	4,0
	FS 2071	M 4 x 8,4	15 IP	4,0
	FS 1028	M 4,5 x 12,8	20	4,0
	FS 1153	M 4,5 x 14	20	4,0
	FS 391	M 5 x 0,5 x 9,1	20	5,0
	FS 392	M 5 x 0,5 x 12,75	20	5,0
	FS 393	M 5 x 0,5 x 15,45	20	5,0
	FS 2072	M 5 x 9,55	20 IP	5,0
	FS 2073	M 5 x 12,75	20 IP	5,0
	FS 2074	M 5 x 15,45	20 IP	5,0
	FS 2075	M 6 x 20,35	20 IP	5,0
	FS 394	M 6 x 0,7 x 20,35	20	5,0
	FS 395	M 8 x 0,75 x 24,7	30	6,0
FS 2107	M 8 x 24,7	30 IP	10,0	
 Clamping screws for exchangeable blades	FS 1396	M 2,5 x 10,9	7 IP	1,2
	FS 1397	M 3 x 12,8	8 IP	2,0
	FS 1398	M 3 x 14,7	8 IP	2,0
	FS 1399	M 4 x 16,7	15 IP	4,0
	FS 1400	M 5 x 18,7	20 IP	5,0
	FS 1401	M 5 x 20,6	20 IP	5,0
	FS 1402	M 5 x 22,6	20 IP	5,0
	FS 1403	M 6 x 24,6	25 IP	5,5
	FS 1404	M 6 x 26,6	25 IP	5,5
	FS 2159	M 6 x 29,6	25 IP	5,5
 Clamping screws for thread milling inserts with head angle 60° and arched countersink in accordance with ISO	T9111010-1XT7	M 2,2 x 5	7	0,4
	T9111020-2XT8	M 2,6 x 6,5	8	1,0
	T9111030-3XT10	UNC 5 x 9,5	10	1,5 / 2,0
	T9111031-3MXT10	UNC 5 x 8	10	1,5 / 2,0
	T9111040-4XT20	UNC 8 x 10,7	20	5,0
	T9111050-5XT25	M 5 x 15	25	6,0

Screw types	Designation	Dimension	Tightening torque	
			Torx	Nm
 Clamping screws with head angle 60° for inserts with arched countersink in acc. with ISO	FS 1358	M 1,8 x 3,5	6	0,4
	FS 1012	M 1,8 x 4,3	6	0,4
	FS 2076	M 2 x 3,2	6 IP	0,6
	FS 1003	M 2 x 3,25	6	0,4
	FS 1151	M 2 x 3,45	6	0,4
	FS 2147	M 2 x 4,25	6 IP	0,6
	FS 2148	M 2 x 4,95	6 IP	0,6
	FS 1004	M 2,2 x 4,6	7	0,6
	FS 2084	M 2,2 x 4,6	7 IP	0,9
	FS 2111	M 2,2 x 4,85	7 IP	0,9
	FS 1020	M 2,2 x 5,5	7	0,6
	FS 2149	M 2,2 x 6,4	7 IP	0,9
	FS 2066	M 2,5 x 5,2	7 IP	0,9
	FS 924	M 2,5 x 4,5	8	0,8
	FS 1455	M 2,5 x 4,5	8 IP	0,8 / 1,2
	FS 1129	M 2,5 x 5,2	8	0,8
	FS 1021	M 2,5 x 5,5	8	0,8
	FS 2067	M 2,5 x 5,7	7 IP	0,9
	FS 375	M 2,5 x 5,8	7	0,8
	FS 923	M 2,5 x 6	8	0,8 / 1,2
	FS 1454	M 2,5 x 6	8 IP	0,8 / 1,2
	FS 2061	M 2,5 x 6,5	7 IP	0,9
	FS 2077	M 3 x 5,3	9 IP	1,5
	FS 1005	M 3 x 6	8	1,0
	FS 1456	M 3 x 6,2	9 IP	1,5 / 2,0
	FS 2078	M 3 x 7,2	9 IP	1,5
	FS 1013	M 3 x 7,5	8	1,0
	FS 1457	M 3 x 7,7	9 IP	1,5
	FS 379	M 3 x 8,5	8	1,0
	FS 2079	M 3 x 8,7	9 IP	2,0
	FS 920	M 3,5 x 7,3	15	2,5
	FS 2062	M 3,5 x 8,1	15 IP	3,0
	FS 359	M 3,5 x 9	15	2,5
	FS 2119	M 3,5 x 9,3	15 IP	3,0
	FS 2063	M 3,5 x 10,1	15 IP	3,0
	FS 1006	M 3,5 x 12	15	2,5
FS 2060	M 3,5 x 12,1	15 IP	3,0	
FS 2064	M 4 x 0,5 x 11	15 IP	3,0	
FS 2065	M 4 x 0,5 x 14	15 IP	3,0	
FS 1011	M 4 x 7,8	15	3,0	
FS 2080	M 4 x 8,5	15 IP	2,5	
FS 2114	M 4 x 9	15 IP	2,5	
FS 378	M 4 x 9,5	15	3,0	
FS 1453	M 4 x 9,7	15 IP	2,5 / 3,5	
FS 1459*	M 4 x 10	15 IP	4,0	
FS 2081	M 4 x 12	15 IP	3,0	
FS 1007	M 4 x 12	15	3,0	
FS 1029	M 5 x 9	20	5,0	
FS 2139	M 5 x 10	20 IP	5,0	
FS 1030	M 5 x 11	20	5,0	
FS 1495	M 5 x 13	20 IP	5,0	
FS 1031	M 5 x 13	20	5,0	
FS 1009	M 5 x 16	20	5,0	
FS 2112	M 5 x 16	20 IP	5,0	
FS 2090	M 5 x 17,25	20 IP	5,0	
FS 1036	M 6 x 14	20	5,0	
FS 2089	M 6 x 18,25	25 IP	5,0	
FS 1008	M 6 x 18	20	5,0	
FS 1152	M 8 x 1 x 18,5	30	10,0	
FS 2150	M 8 x 22	30 IP	10,0	



* Screw head with radius IP = Torx Plus





Torque screwdriver with interchangeable blades



Designation	Size		Scale range
FS 2001	1	4	0,4–1,2 Nm
FS 2003	3	4	1,5–5,0 Nm
FS 2002	1	4	3,5–10,6 in lbs
FS 2004	3	4	13,3–44 in lbs

Designation		Scale range
FS 2041	6	4,5–14 Nm
FS 2042	6	40–123 in lbs

Interchangeable blades	Designation	Torx	
 Torx interchangeable blades Blade length 175 mm	FS 2005	6	4
	FS 2006	7	
	FS 2007	8	
	FS 2008	10	
	FS 2009	15	
	FS 2010	20	
 Torx Plus interchangeable blades Blade length 175 mm	FS 2085	6 IP	4
	FS 2011	7 IP	
	FS 2012	8 IP	
	FS 2013	9 IP	
	FS 2014	15 IP	
	FS 2015	20 IP	
	FS 2016	25 IP	
Complete blade set (FS 2005–FS 2016) Blade length 175 mm	FS 2017		4

Interchangeable blades	Designation	Torx / WAF	
 Torx interchangeable blades Blade length 130 mm	FS 2043	15	6
	FS 2044	20	
	FS 2045	25	
	FS 2046	30	
 Torx Plus interchangeable blades Blade length 130 mm	FS 2047	15 IP	6
	FS 2048	20 IP	
	FS 2049	25 IP	
	FS 2109	30 IP	
 Hexagonal interchangeable blades Blade length 130 mm	FS 2050	SW 3	6
	FS 2051	SW 4	
	FS 2052	SW 5	
Complete blade set (FS 2043–FS 2052) Blade length 130 mm	FS 2053		6

Screwdrivers

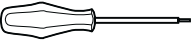
Screwdriver types	Designation	Torx
 Screwdriver	FS 1063	6
	FS 2086	6 IP
	FS 309	7
	FS 2088	7 IP
	FS 230	8
	FS 1483	8 IP
	FS 1128	9
	FS 1484	9 IP
	FS 229	15
	FS 1485	15 IP
	FS 228	20
	FS 1486	20 IP
	FS 2167	25
	FS 1487	25 IP
	FS 396	30
	FS 2108	30 IP

IP = Torx Plus

Screwdriver types	Designation	Torx	WAF	
 Torx key	FS 2146	6 IP	-	
	FS 2087	6 IP	-	
	FS 325	7	-	
	FS 1490	7 IP	-	
	FS 257	8	-	
	FS 1466	9 IP	-	
	FS 1050	10	-	
	FS 255	15	-	
	FS 1465	15 IP	3,5	
	FS 1496	15 IP	4,0	
	FS 256	20	-	
	FS 1154	-	2,0	
	FS 1155	-	2,5	

IP = Torx Plus

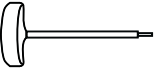
Screwdriver types	Designation	Torx
 Handle key, small	FS 1047	15
	FS 1048	20
	FS 1049	25
 Handle key, large	FS 1172	15
	FS 1173	20
	FS 1174	25
	FS 1175	30

Allen key	Designation	Torx	WAF	
	ISO 2936-1,3	-	1,3	
	ISO 2936-1,5	-	1,5	
	ISO 2936-2	-	2	
	ISO 2936-2,5	-	2,5	
	ISO 2936-3	-	3	
	ISO 2936-4	-	4	
	ISO 2936-5	-	5	
	ISO 2936-6	-	6	
	FS 1464	20 IP	-	
	FS 1592	25 IP	-	

IP = Torx Plus

Clamping systems for tools and tool adaptors

Tool adaptor DIN 69871 part 1 form B

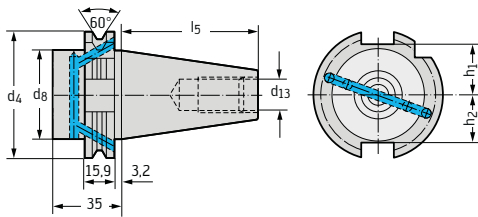

SK no.	l ₅ mm	d ₄ mm	d ₈ max. mm	d ₁₃	h ₂ mm	h ₁ mm
40	68,40	63,55	50	M16	22,8	25,0
50	101,75	97,50	80	M24	35,5	37,7

(with internal coolant supply; dimensions similar to version A)

Tool adaptor ANSI B 5.50

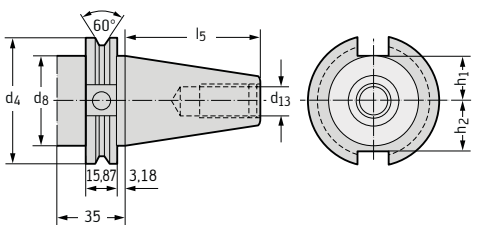

SK no.	l ₅ mm	d ₄ mm	d ₈ mm	d ₁₃	h ₂ mm	h ₁ mm
40	68,25	63,5	44,5	M16	22,6	25,0
50	101,6	98,4	70,0	M24	35,3	37,7

(ANSI/ASME B 5.50 – 1885)

Tool adaptor MAS BT

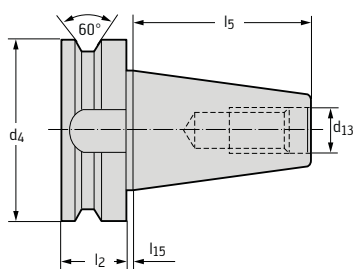

SK no.	l ₅ mm	d ₄ mm	d ₁₃	l ₂ mm	l ₁₅ mm
40	65,4	63	M16	25	2
50	101,8	100	M24	35	3

Tool adaptor HSK DIN 69893, part 1, version A

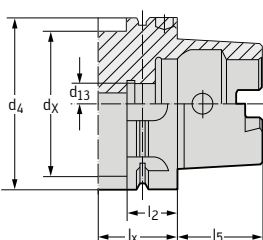

HSK	l ₅ mm	d ₄ mm	d _x max. mm	d ₁₃	l ₂ mm	l _x min. mm
63	32	63	53	M 18 × 1,0	26	42
100	50	100	85	M 24 × 1,5	29	45

Clamping systems for tools and tool adaptors

**Cylindrical shank
DIN 6535 HA / DIN 6535 HB**

d_{11} h6 mm	l_5 +2 mm	b +0,05 mm	e -1 mm	b_2 +1 mm	h h11 mm
6	36	4,2	18	-	5,1
8	36	5,5	18	-	6,9
10	40	7	20	-	8,5
12	45	8	22,5	-	10,4
14	45	8	22,5	-	12,7
16	48	10	24	-	14,2
18	48	10	24	-	16,2
20	50	11	25	-	18,2
25	56	12	32	17	23,0

Form HA
for $d_{11} = 6 - 20$ mm

Form HB
for $d_{11} = 6 - 20$ mm

Form HB
for $d_{11} = 25$ mm

**Cylindrical shank
DIN 6535**

d_{11} h6 mm	l_5 +2 mm	b -1 mm	e mm	h mm
6	36	25	18	5,1
8	36	25	18	6,9
10	40	28	20	8,5
12	45	33	22,5	10,4
14	45	33	22,5	12,7
16	48	36	24	14,2
18	48	36	24	16,2
20	50	38	25	18,2
25	56	44	32	23,0

for $d_{11} = 6-20$ mm

for $d_{11} = 25$ mm

Clamping systems for tools and tool adaptors

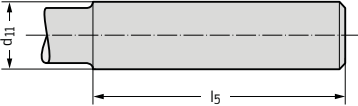
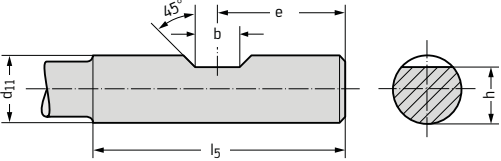
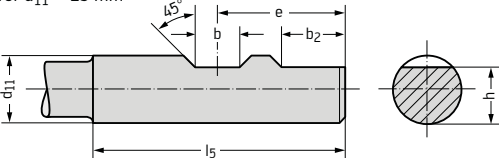
Cylindrical shank DIN 1835 A / DIN 1835 B		d_{11} h6 mm	l_5 +2 mm	b +0,05 mm	e -1 mm	b_2 +1 mm	h h13 mm
Form A for $d_{11} = 3 - 20$ mm		3	28	-	-	-	-
		4	28	-	-	-	-
		5	28	-	-	-	-
		6	36	4,2	18	-	4,8
		8	36	5,5	18	-	6,6
Form B for $d_{11} = 3 - 20$ mm		10	40	7	20	-	8,4
		12	45	8	22,5	-	10,4
		16	48	10	24	-	14,2
		20	50	11	25	-	18,2
		25	56	12	32	17	23,0
		32	60	14	36	19	30,0
Form B for $d_{11} = 25$ mm		40	70	14	40	19	38,0
		50	80	18	45	23	47,8

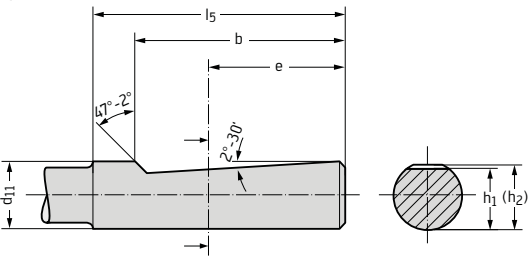
Cylindrical shank DIN 1835 E		d_{11} h6 mm	l_5 +2 mm	b -1 mm	e mm	h_1 mm	(h_2) h13 mm
Form E		6	36	25	18	5,4	4,8
		8	36	25	18	7,2	6,6
		10	40	28	20	9,1	8,4
		12	45	33	22,5	11,2	10,4
		16	48	36	24	15,0	14,2
		20	50	38	25	19,1	18,2
		25	56	44	32	24,1	23,0
		32	60	48	35	31,2	30,0

Clamping systems for tools and tool adaptors

**Tool adaptor
(MK) DIN 228 A**

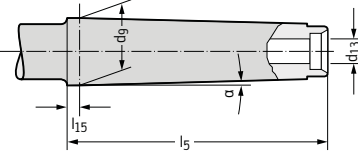

MK	d _g mm	l ₅ mm	l ₁₅ mm	α	d ₁₃
0	9,045	53	3	1°29'27"	–
1	12,065	57	3,5	1°25'43"	M6
2	17,780	69	5	1°25'50"	M10
3	23,825	86	5	1°26'16"	M12
4	31,267	109	6,5	1°29'15"	M16
5	44,399	136	6,5	1°30'26"	M20

**Tool adaptor
(MK) DIN 2207 A**

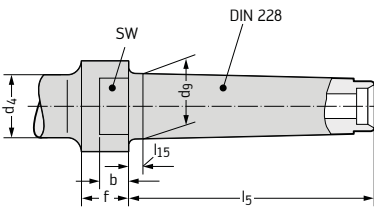

MK	d _g mm	l ₅ mm	l ₁₅ mm	d ₄ mm	f mm	b mm	SW d _g mm
3	23,825	86	5	36	18	12	24
4	31,267	109	6,5	43	23	15	32
5	44,399	136	6,5	60	28	18	45

**Tool adaptor
(SK) DIN 2080**

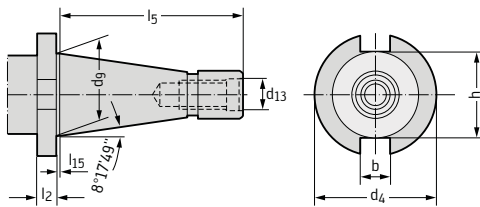

SK no.	d _g mm	l ₅ mm	l ₁₅ ± 0,2 mm	d ₁₃	d ₄ - 0,4 mm	l ₂ ± 0,15 mm	b H12 mm	h max. mm
40	44,45	93,4	1,6	M16	63	10	16,1	45
50	69,85	126,8	3,2	M24	97,5	12	25,7	70,6

**Tool adaptor
(SK) DIN 69 871 part 1, form A**

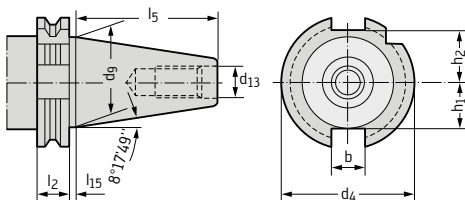

SK no.	l ₅ - 0,3 mm	l ₂ - 0,1 mm	l ₁₅ ± 0,2 mm	d _g mm	d ₁₃	d ₄ - 0,1 mm	b H12 mm	h ₁ - 0,4 mm	h ₂ - 0,4 mm
40	68,4	15,9	3,2	44,45	M16	63,55	16,1	22,8	25,0
50	101,75	15,9	3,2	69,85	M24	97,50	25,7	35,5	37,7

Clamping systems for tools and tool adaptors

Cylindrical shank ISO 9766 (1990)

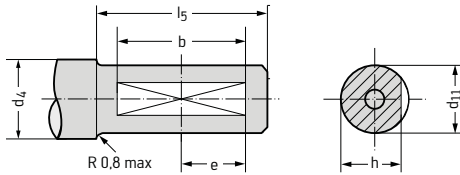

d_{11} h6 mm	d_4 min. mm	h h13 mm	l_5 ± 1 mm	e mm	b mm
20	25	18,2	50	14,5	29
25	31	23	56	17,5	35
32	38	30	60	19,5	39

Bore with radial key way DIN 138 – A 10

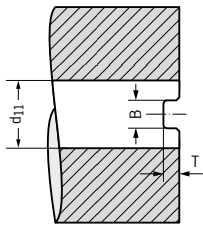

d_{11} mm	B H11 mm	T H12 mm
16	8,4	5,6
22	10,4	6,3
27	12,4	7
32	14,4	8
40	16,4	9

Bore with longitudinal key way DIN 138 – L 10

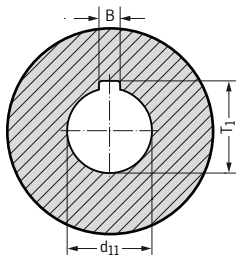

d_{11} H7 mm	B mm	T_1 mm
16	4	17,7
22	6	24,1
27	7	29,8
32	8	34,8
40	10	43,5
50	12	53,6
60	14	64,2

Tool adaptor Capto ISO 26623

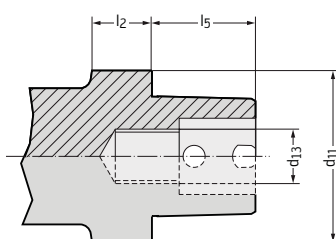

Type	d_{11} mm	l_2 mm	l_5 mm	d_{13}
Capto C3	32	15	19	M 12 × 1,5
Capto C4	40	20	24	M 14 × 1,5
Capto C5	50	20	30	M 16 × 1,5
Capto C6	63	22	38	M 20 × 2
Capto C8	80	30	48	M 20 × 2

Clamping systems for tools and tool adaptors

Tool adaptor ConeFit™

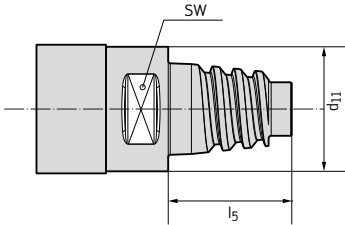

Type	d_{11} mm	l_5 mm	SW mm
E10	9,7	12,4	8
E12	11,7	14,5	10
E16	15,5	18,7	12
E20	19,3	21,3	16
E25	24,2	25,6	20

Tool adaptor ScrewFit

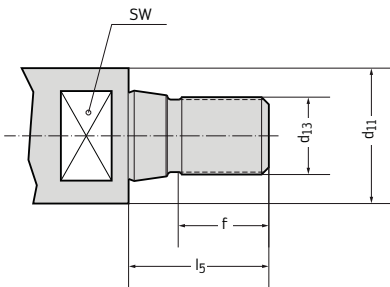

Type	d_{11} mm	d_{13}	l_5 mm	f mm	SW mm
T09	9,7	M5	14	6	8
T14	14,5	M8	18	10	12
T18	18,5	M10	21	12	14
T22	22	M12	23	14	17
T28	28	M16	29	18	21
T36	36	M20	35	20	30
T45	45	M20	35	20	36

Tool adaptor NCT

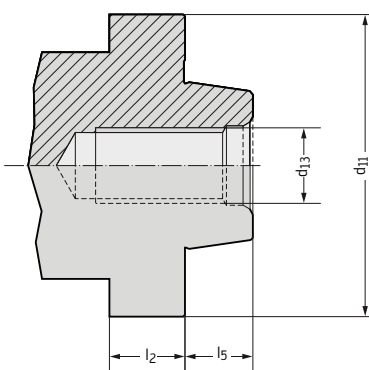

Type	d_{11} mm	d_{13}	l_5 mm	l_2 mm
25	24,85	M8	6,975	14
32	31,85	M8	6,975	14
40	39,85	M12	11,975	16
50	49,85	M12	11,975	16
63	62,85	M16	15,975	16
80	79,85	M20	17,975	18

Clamping systems for tools and tool adaptors

Bores with radial key way for spindle head in acc. with DIN 2079 form B

	d_{11} mm	H_{11} mm	D_i mm	d_{1i} mm	d_{2i} mm	D_e mm	d_{1e} mm	d_{2e} mm	H mm	T mm	K mm	T_i mm	T_e mm
ISO 40/40 B	40	30	66,7	14	–	–	–	–	16,455	9,075	52,5	–	–
ISO 60/50 B	60	35	101,6	18	26	–	–	–	25,64	14,25	77,5	28	–
ISO 60/60-50 BB	60	35	101,6	18	26	177,8	22	33	25,64	14,25	122,5	28	32

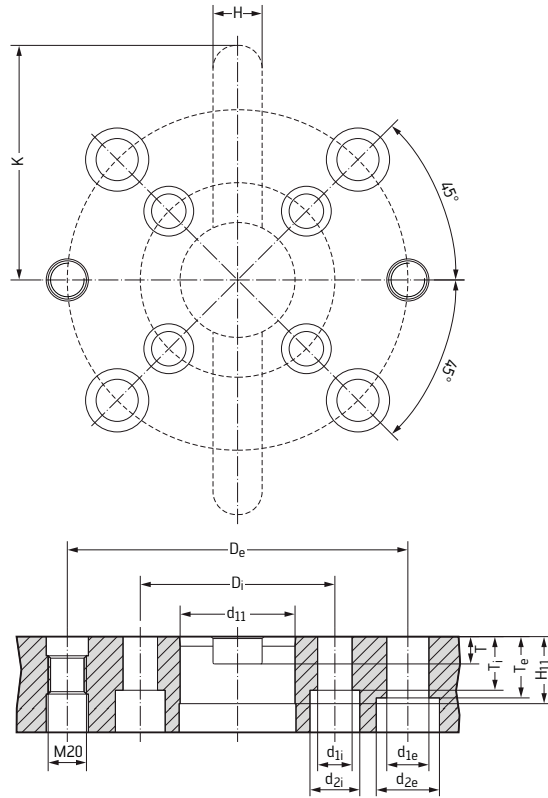
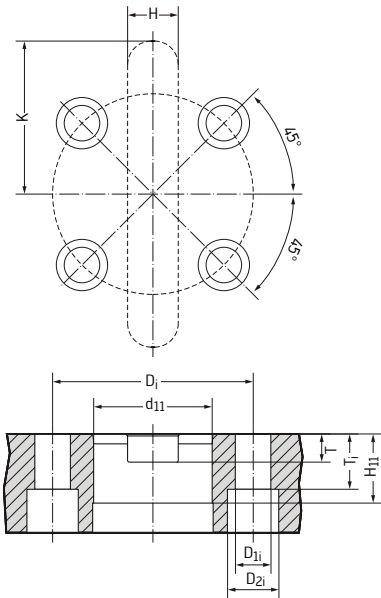

ISO tolerances

Nominal size range in mm	Dimension* for external dimensions																
	d11	e8	h5	h6	h7	h8	h9	h10	h11	h12	js14	js16	k6	k10	k11	k12	m7
> 3	-20 -80	-14 -28	0 -4	0 -6	0 -10	0 -14	0 -25	0 -40	0 -60	0 -100	+125 -125	+300 -300	+6 0	+40 0	+60 0	+100 0	+12 +2
> 3 ≤ 6	-30 -105	-20 -38	0 -5	0 -8	0 -12	0 -18	0 -30	0 -48	0 -75	0 -120	+150 -150	+375 -375	+9 +1	+48 0	+75 0	+120 0	+16 +4
> 6 ≤ 10	-40 -130	-25 -47	0 -6	0 -9	0 -15	0 -22	0 -36	0 -58	0 -90	0 -150	+180 -180	+450 -450	+10 +1	+58 0	+90 0	+150 0	+21 +6
> 10 ≤ 18	-50 -160	-32 -59	0 -8	0 -11	0 -18	0 -27	0 -43	0 -70	0 -110	0 -180	+215 -215	+550 -550	+12 +1	+70 0	+110 0	+180 0	+25 +7
> 18 ≤ 30	-65 -195	-40 -73	0 -9	0 -13	0 -21	0 -33	0 -52	0 -84	0 -130	0 -210	+260 -260	+650 -650	+15 +2	+84 0	+130 0	+210 0	+29 +8
> 30 ≤ 50	-80 -240	-50 -89	0 -11	0 -16	0 -25	0 -39	0 -62	0 -100	0 -160	0 -250	+310 -310	+800 -800	+18 +2	+100 0	+160 0	+250 0	+34 +9
> 50 ≤ 80	-100 -290	-60 -106	0 -13	0 -19	0 -30	0 -46	0 -74	0 -120	0 -190	0 -300	+370 -370	+950 -950	+21 +2	+120 0	+190 0	+300 0	+41 +11
> 80 ≤ 120	-120 -340	-72 -126	0 -15	0 -22	0 -35	0 -54	0 -87	0 -140	0 -220	0 -350	+435 -435	+1100 -1100	+25 +3	+140 0	+220 0	+350 0	+48 +13
> 120 ≤ 180	-145 -395	-85 -148	0 -18	0 -25	0 -40	0 -63	0 -100	0 -160	0 -250	0 -400	+500 -500	+1250 -1250	+28 +3	+160 0	+250 0	+400 0	+55 +15
> 180 ≤ 250	-170 -460	-100 -172	0 -20	0 -29	0 -46	0 -72	0 -115	0 -185	0 -290	0 -460	+575 -575	+1450 -1450	+33 +4	+185 0	+290 0	+460 0	+63 +17

Nominal size range in mm	Tolerances* for external dimensions	
	z9	
> 3	+51 +26	
> 3 ≤ 6	+65 +35	
> 6 ≤ 10	+78 +42	
> 10 ≤ 14	+93 +50	
> 14 ≤ 18	+103 +60	
> 18 ≤ 24	+125 +73	
> 24 ≤ 30	+140 +88	
> 30 ≤ 40	+174 +112	
> 40 ≤ 50	+196 +136	
> 50 ≤ 65	+246 +172	
> 65 ≤ 80	+284 +210	
> 80 ≤ 100	+345 +258	
> 100 ≤ 120	+397 +310	
> 120 ≤ 140	+465 +365	
> 140 ≤ 160	+515 +415	
> 160 ≤ 180	+565 +465	
> 180 ≤ 200	+635 +520	

Nominal size range in mm	Tolerances* for internal dimensions			
	H6	H7	H11	H12
> 3	+6 0	+10 0	+60 0	+0,10 0
> 3 ≤ 6	+8 0	+12 0	+75 0	+0,12 0
> 6 ≤ 10	+9 0	+15 0	+90 0	+0,15 0
> 10 ≤ 18	+11 0	+18 0	+110 0	+0,18 0
> 18 ≤ 30	+13 0	+21 0	+130 0	+0,21 0
> 30 ≤ 50	+16 0	+25 0	+160 0	+0,25 0
> 50 ≤ 80	+19 0	+30 0	+190 0	+0,30 0
> 80 ≤ 120	+22 0	+35 0	+220 0	+0,35 0
> 120 ≤ 180	+25 0	+40 0	+250 0	+0,40 0
> 180 ≤ 250	+29 0	+46 0	+290 0	+0,46 0

* Tolerances in µm in acc. with DIN ISO 286 (previous: DIN 7160 or DIN 7161)

Accessories for tool adaptors

Pull stud for steep taper

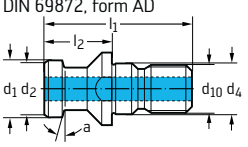
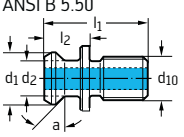
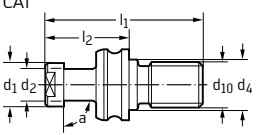
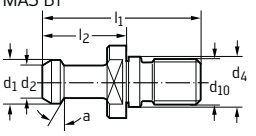
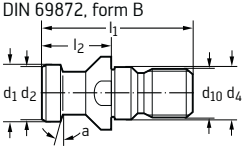
	Designation	for SK	d ₁ mm	d ₂ mm	d ₄ mm	d ₁₀	l ₁ mm	l ₂ mm	a
DIN 69872, form AD 	C 100.40.15	40	19	14	17	M16	54	26	15°
	C 100.50.15	50	28	21	25	M24	74	34	15°
ANSI B 5.50 	C 100.40.345	40	18,8	12,8		M16	38	16,2	45°
	C 100.50.345	50	28,9	19,5		M24	58	25,4	45°
CAT 	C 100.40.390	40	15	10	17	M16	52	26,75	90°
	C 100.50.390	50	23	17	25	M24	85	45,2	90°
MAS BT 	C 100.40.430	40	15	10	17	M16	60	35	30°
	C 100.40.445	40	15	10	17	M16	60	35	45°
	C 100.50.430	50	23	17	25	M24	85	45	30°
	C 100.50.445	50	23	17	25	M24	85	45	45°
DIN 69872, form B 	C 100.40.215	40	19	14	17	M16	54	26	15°
	C 100.50.215	50	28	21	25	M24	74	34	15°

Transfer units for HSK adaptors

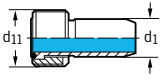

	Designation	d ₁₁	d _{1 f8} mm	for HSK
	FS 1064	M 18 x 1	12	HSK63-A
	FS 1065	M 24 x 1,5	16	HSK100-A

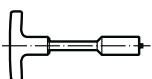
Socket wrench for installing transfer units





	Designation	for HSK
	FS 952	HSK63-A
	FS 953	HSK100-A

Assembly parts and accessories

Finishing cartridges

	Designation	suitable for
	FK 254 FR 277 FR 278	F 244
	FR 327	F 2040

Clamping wedges

















	Designation	suitable for
	FR 260	F 246
	FR 262	F 246
	FR 281 FR 282	F 244
	FR 283	F 244

Shims

	Designation	suitable for
	FR 280	F 244



Assembly parts and accessories

Spare parts for F 2010

	Designation	suitable for	for indexable insert	Clamping screw	Tightening torque
	FR 442 M	Face milling cutter, $\kappa = 75^\circ$	SP .. 1504 ..	FS 243 (Torx 20)	5,0 Nm
	FR 444 M	Shoulder milling cutter, $\kappa = 90^\circ$	TP .. 2204 ..	FS 243 (Torx 20)	5,0 Nm
	FR 447 M	Shoulder milling cutter, $\kappa = 90^\circ$	P 27 .. -4R	FS 243 (Torx 20)	5,0 Nm
	FR 450 M	Round insert cutter	RP .. 1204 ..	FS 244 (Torx 15)	3,0 Nm
	FR 451 M	Face milling cutter, $\kappa = 75^\circ$	SF .. 1203 EFR	FS 260 (Torx 20)	5,0 Nm
	FR 456 M	Face milling cutter, $\kappa = 45^\circ$	SE .. 1504 ..	FS 243 (Torx 20)	5,0 Nm
	FR 495 M	Face milling cutter, $\kappa = 45^\circ$	SP .. 1204 A ..	FS 243 (Torx 20)	5,0 Nm
	FR 496 M	Round insert cutter	RP .. 1605 ..	FS 243 (Torx 20)	5,0 Nm
	FR 497 M	Shoulder milling cutter, $\kappa = 90^\circ$	LP .. 1504 ..	FS 243 (Torx 20)	5,0 Nm
	FR 498 M	Face milling cutter, $\kappa = 45^\circ$	SP .. 1504 A ..	FS 243 (Torx 20)	5,0 Nm
	FR 562 M	Shoulder milling cutter, $\kappa = 90^\circ$	AP .. 15T3 ..	FS 359 (Torx 15)	2,5 Nm
	FR 572 M FR 573 M FR 574 M	Round insert cutter	RD .. 1204 .. RD .. 1605 .. RD .. 2006 ..	FS 359 (Torx 15) FS 1030 (Torx 20) FS 1010 (Torx 20)	3,0 Nm 5,0 Nm 5,0 Nm
	FR 593 M	Octagon milling cutter, $\kappa = 43^\circ$	OD .. 0504 ..	FS 359 (Torx 15)	2,5 Nm
	FR 682 M	Face milling cutter, $\kappa = 45^\circ$	SD .. 0903 ..	FS 359 (Torx 15)	2,5 Nm
	FR 694 M	Shoulder milling cutter, $\kappa = 90^\circ$	AD .. 2006 ..	FS 1030 (Torx 20)	5,0 Nm
	FR 714 M FR 715 M	Shoulder milling cutter, $\kappa = 90^\circ$	AP .. 0903 .. AP .. 15T3 ..	FS 923 (Torx 8) FS 359 (Torx 15)	0,8 Nm 2,5 Nm

Assembly parts and accessories

Spare parts for F 2052 – Cartridges

Designation		for indexable insert	Clamping screw	Tightening torque	
		FR / FL 471	SP .. 09T308	FS 246 (Torx 8)	3,0 Nm



Spare parts for F 2052 – Wedges

Designation		for hub width	Compound screw	Tightening torque
	FK 275 FK 276 FK 277 FK 278 FK 279 FK 280	10 mm 12 mm 14 mm 16 mm 19 mm 22 mm	FS 239 (SW 3)	7,0 Nm

Spare parts for F 2252 – Cartridges

Designation		for indexable insert	Clamping screw	Tightening torque
	FR / FL 687	AP .. 0903 ..	FS 923 (Torx 8)	5,0 Nm
	FR / FL 689	AP .. 15T3 ..	FS 359 (Torx 15)	2,5 Nm
	FR / FL 691	TP .. 1604 ..	FS 244 (Torx 15)	3,0 Nm
	FR / FL 692	SP .. 1204 ..	FS 1029 (Torx 20)	5,0 Nm

Cartridges for milling cutters

Designation		for indexable insert	suitable for
	FR 432	P 23 .. -1	F 2044, face milling cutter
	FR 596	AP .. 15T3 ..	F 2250, face milling cutter
	FR 597	AP .. 0903 ..	
	FR 598	SD .. 0903 ..	

Assembly parts and accessories

Pins

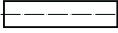
	Designation	Size	suitable for
	FS 955 FS 956 FS 957 FS 958	2,5 x 6 (DIN 6325) 3 x 8 (DIN 6325) 4 x 10 4 x 12 (DIN 6325)	F 2034 split pin
	FS 959	4 x 10 (DIN 1472)	F 2034 close tolerance grooved pin

Cartridges for drilling and boring tools

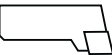
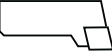





	Designation	Diameter range	suitable for	for indexable insert	Clamping screw	Tightening torque
	EB 237.WC08	150–640 mm	B 3220 Boring tool	WC . . 0804 . .	FS 1030 (Torx 20)	5,0 Nm
	FR 501 FR 502	21–25 mm 24–28 mm	B 2120 Boring tool	CC . . 0602 . .	FS 322 (Torx 7)	1,0 Nm
	FR 510 FR 513 FR 516 FR 519	60–77 mm 75–95 mm 90–115 mm 110–140 mm	B 2120 Boring tool	CC . . 1204 . .	FS 243 (Torx 20)	5,0 Nm
	FR 522 FR 523	135–185 mm 175–500 mm	B 2121 M Boring tool	CC . . 1204 . .	FS 243 (Torx 20)	5,0 Nm
	FR 601 FR 602	28–33 mm 33–41 mm	B 2120 Boring tool	CC . . 0602 . .	FS 322 (Torx 7)	1,0 Nm
	FR 603 FR 604	41–51 mm 51–60 mm	B 2120 Boring tool	CC . . 09T3 . .	FS 244 (Torx 15)	3,0 Nm

Compound screws

	Designation	Size	suitable for
	FS 231	M 8 x 24 (SW 4)	FK 240, FR/FL 281, FR/FL 282, FR/FL 283, F 249
	FS 234 FS 235	M 10 x 40 (SW 5) M 8 x 32 (SW 5)	FR/FL 238, FR/FL 239, FR/FL 243, FR/FL 244, FR/FL 247, FR/FL 248, FR/FL 249, FR/FL 250, FR/FL 259, FR/FL 260, FR/FL 261, FR/FL 262, FR/FL 263, FR/FL 264, FR/FL 265, FR/FL 266, FR/FL 283, FR/FL 285, FR/FL 287
	FS 927 FS 928 FS 929	M 8 x 46 (Torx 25) M 10 x 60 (Torx 40) M 12 x 76 (Torx 45)	Adaptors

Assembly parts and accessories

Spare parts for F 2052 – Cartridges

	Designation	Size	suitable for
	FS 242	M 5 x 13 (Torx 20)	Milling system 2000
	FS 258	M 3 x 5,7 (Torx 8)	Milling system 2000, Stardrill
	FS 318	M 4 x 6 (Torx 15)	Turning toolholder, F 2053, Stardrill
	FS 749	M 4 x 10,5 (Torx 15)	Milling system 2000
	FS 1006 FS 1007 FS 1008 FS 1009	M 3,5 x 12 (Torx 15) M 4 x 12 (Torx 15) M 6 x 18 (Torx 20) M 5 x 16 (Torx 20)	Milling system 2000
	FS 1036	M 6 x 14 (Torx 20)	Milling system 2000, Stardrill
	FS 248 FS 249 FS 250	M 4 x 10,7 (Torx 8) M 5 x 11,3 (Torx 15) M 6 x 11,6 (Torx 20)	Milling system 2000
	FS 293	M 5 x 11 (Torx 15)	Milling system 2000
	FS 305	M 5 x 11,6 (Torx 20)	F 2044
	FS 1015	M 3 x 12 (Torx 20)	F 2253

Threaded plugs

	Designation	Size	suitable for
	FS 962 DIN 915	M 5 x 10	–
	DIN 915	M 4 x 5 M 4 x 6	Adaptors
	DIN 915	M 4 x 10	Walter cutter, F 2140
	DIN 915	M 6 x 10	Adaptors, B 2109
	DIN 915	M 6 x 12 M 6 x 16	Adaptors
	DIN 914	M 6 x 8	Walter Cut

Assembly parts and accessories



Other threaded plugs

	Designation	Size	
	FS 517	M 5 x 13,5 (SW 2,5)	-

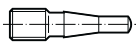
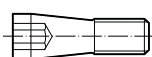
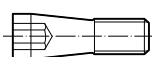
Countersunk screws

	Designation	Size	suitable for
	FS 758 FS 759 FS 760	-	B 2110, precision boring tool
	FS 946 FS 948 FS 950	For Ø 29–38 mm For Ø 50–65 mm For Ø 88–115 mm	B 2110, precision boring tool
	FS 1491 FS 2045 FS 2055 FS 1148 FS 2056 FS 2058	M 3 x 9,8 (SW 2) M 3 x 12 (SW 2) M 4 x 15 (SW 2,5) M 5 x 19 (SW 2,5) M 5 x 23 (SW 3) M 3 x 13,5 (SW 2,5)	Special tools

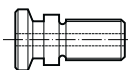
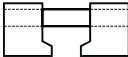
Accessories for adaptors







	Designation	Size	Description	suitable for
	FS 709 FS 710 FS 711 FS 712	M 12 x 18 (SW 16) M 12 x 17 (SW 19) M 16 x 24 (SW 22) M 20 x 30 (SW 30)	Tensioning bolt	Adaptors, NCT radial
	FS 930 FS 931 FS 932 FS 933	M 4 x 10 (Torx 15)	Clamping unit	Adaptors, NCT radial
	FS 1079 FS 1080	for SK 40 for SK 50	Intermediate bushing for pull stud	Tools with steep taper

Assembly parts and accessories

Cap head bolts

	Designation	Size	suitable for
	DIN 912	M 6 x 10	Precision boring tool, B 2109 M
	DIN 7984	M 16 x 40 M 16 x 45	Adaptors
	DIN 7984	M 20 x 60	Eccentric sleeve

Miscellaneous screws

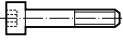
	Designation	Size	suitable for
	FS 314	M 6 x 18,5 (Torx 15)	Collar screw, F 2050
	FS 370	SW 10	Clamping screw for front piece, F 2038
	FS 371 FS 372 FS 373 FS 374	SW 10 SW 10 SW 12 SW 12	Clamping screw for front piece, F 2038
	FS 752 FS 753	-	Adjusting screw B 2120 boring tool
	FS 765 FS 766 FS 767 FS 768 FS 769	-	Fastening screw for tool holder B 2110 precision boring tool
	FS 935	M 2,2 x 6,4 (Torx 7)	Clamping screw
	FS 966 FS 967	M 16 x 16 M 6 x 12	Cap head bolt

Miscellaneous

	Designation	Size	suitable for
	FS 663	100 g	Copaslip

Walter AG

Derendinger Straße 53, 72072 Tübingen
Postfach 2049, 72010 Tübingen
Germany

www.walter-tools.com

www.facebook.com/waltertools

www.youtube.com/waltertools

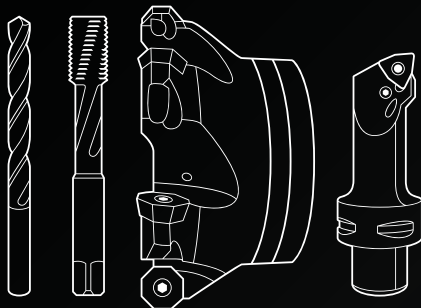

Walter GB LTD.

Bromsgrove, England
+44 (1527) 839 450, service.uk@walter-tools.com

Walter Wuxi Co. Ltd.

Wuxi, Jiangsu, P.R. China
+86 (510) 8241 9399, service.cn@walter-tools.com

Walter AG Singapore Pte. Ltd.

+65 6773 6180, service.sg@walter-tools.com

Walter Korea Ltd.

Ansan, Kyungki-do, Korea
+82 (31) 3646 100, service.kr@walter-tools.com

Walter Tools India Pvt. Ltd.

Pune, India
+91 (20) 3045 7300, service.in@walter-tools.com

Walter (Thailand) Co., Ltd.

Bangkok, 10120, Thailand
+66 2 687 0388, service.th@walter-tools.com

Walter Malaysia Sdn. Bhd.

Selangor D.E., Malaysia
+60 (3) 8023 7748, service.my@walter-tools.com

Walter Australia Pty. Ltd.

Hallam, Victoria 3803, Australia
+61 3 8793 1000, service.au@walter-tools.com

Walter Tooling Japan K.K.

Nagoya, Japan
+81 (52) 723 5800, service.jp@walter-tools.com

Walter USA, LLC

Waukesha WI, USA
+1 800-945-5554, service.us@walter-tools.com

Walter Canada

Mississauga, Canada
service.ca@walter-tools.com